

PROLINK®

www.prolink2u.com

MODEL NO:
PRC3801



Quick Installation Guide

Wireless AC1200 AP/Router/Repeater

Version 1.00

(English / Indonesian)

BEFORE GETTING STARTED

This document is designed to aid you to get started with the device. If you experience problems following these guides or need further information pertaining to the device, please visit our website at www.prolink2u.com. All specifications are subject to the manufacturer's configuration at the time of shipping and may change without prior notice, written or otherwise.

1. Package Contents

1



2

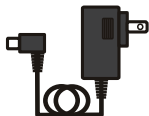

3



4



Items:

- 1 One (1) unit of PRC3801
- 2 One (1) unit of Power Adapter
- 3 One (1) piece of RJ45 Ethernet Cable
- 4 One (1) piece of Quick Installation Guide (QIG)

Note:

1. The illustrations in this document may appear different from your model.
2. If any of above item is not packed in your package when open, please consult your reseller immediately.

2. Overview

Top View (LED Indication)

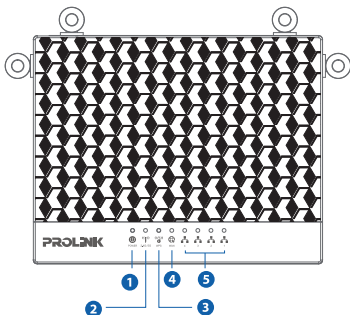

Bottom View

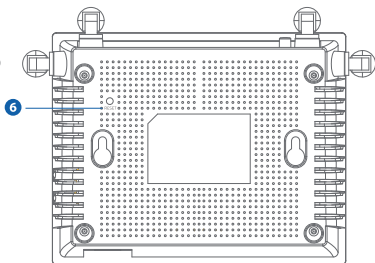

- 1 PWR : ON - Device is powered on
OFF - Device is powered off
- 2 2.4G/5G : ON - Wireless link established and active
OFF - Wireless is turned off
Blink - Wireless packet being transmitted
- 3 WPS : OFF - Idle
Blink - WPS is being triggered
- 4 WAN : ON - WAN link established and active
OFF - No WAN Link
Blink - WAN ethernet packet being transmitted
- 5 LAN 1 - 4 : ON - LAN link established and active
OFF - no LAN Link
Blink - LAN ethernet packet being transmitted
- 6 RESET : Press this button for at least 7 full seconds to RESET device to its default settings

2. Overview

Rear View

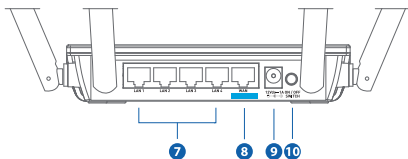

Side View

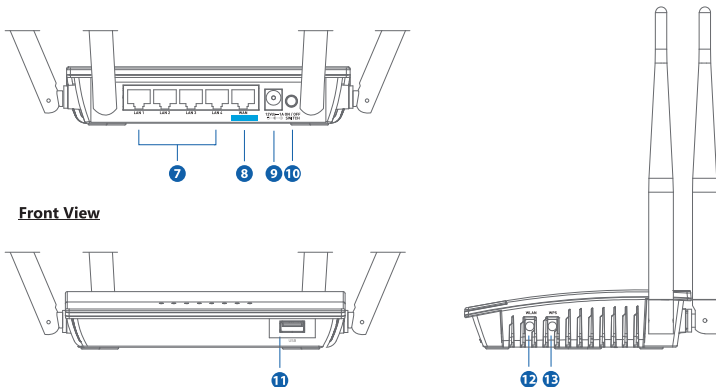

- 7** LAN 1 - 4 : The LAN ports to connect local PC to the router.
- 8** WAN : The WAN port is to connect to the broadband access device. Usually connect to DSL / Cable modem, or to network switch at home/ office.
- 9** POWER : Power socket to connect the power adapter.
- 10** POWER : Power ON / OFF SWITCH
BUTTON
- 11** USB : Connect to USB storage device for file sharing
- 12** WLAN : Press this button for at least 3 full seconds to turn off/on wireless signals
- 13** WPS : Press this button for at least 3 full seconds and the WPS LED will start blinking to start WPS.

Note:

The illustrations in this document may appear different from your model.

3. Application Diagram

3.1 Connection via ADSL Modem / Cable Modem / Fibre Optic ONT

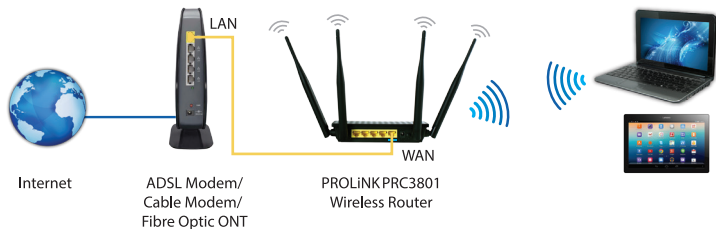

3.2 Connect to Home / Office Network Switch

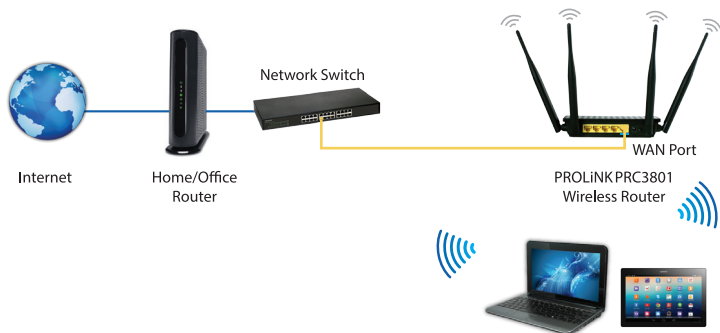

4. Router Configuration

Step1: Hardware connections (Wired or Wireless)

Connect PRC3801 to your computer via Ethernet cable or Wireless connection



Step 2: Software Configurations via Web browser

1. Open your web browser and enter **http://192.168.123.254** or **http://prc3801.prolink** into the address bar.



or



4. Router Configuration

- The default login username is **admin**, password is **password**

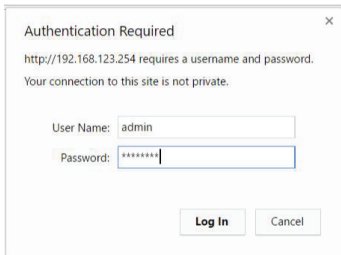

Authentication Required

http://192.168.123.254 requires a username and password.
Your connection to this site is not private.

User Name:

Password:

- Press on **SETUP WIZARD**

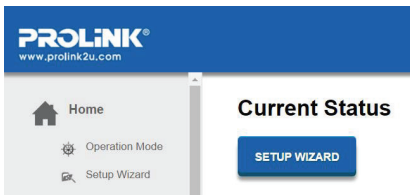

- Select your **WAN ACCESS TYPE*** and press on **NEXT**

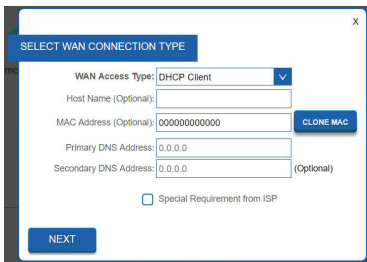

SELECT WAN CONNECTION TYPE

WAN Access Type:

Host Name (Optional):

MAC Address (Optional):

Primary DNS Address:

Secondary DNS Address: (Optional)

Special Requirement from ISP

Notes:

- For PPPoE users, please check the Username, Password or other Special Requirement from ISP and key in the required values.
- For Cable Modem/Fibre Modem users, or connecting to home / office network switch, select DHCP Client mode (Router default setting).

4. Router Configuration

- Set your preferable **Wireless Network Name (SSID)** and **Wireless Security Key**, press **APPLY & REBOOT**.

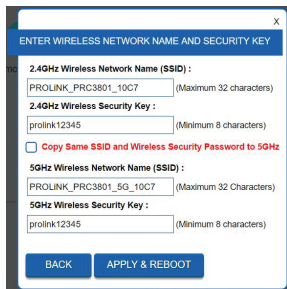

The screenshot shows a web browser window titled "ENTER WIRELESS NETWORK NAME AND SECURITY KEY". The page contains the following fields and options:

- 2.4GHz Wireless Network Name (SSID):** A text input field containing "PROLINK_PRC3801_10C7" with a note "(Maximum 32 characters)".
- 2.4GHz Wireless Security Key:** A text input field containing "prolink12345" with a note "(Minimum 8 characters)".
- Copy Same SSID and Wireless Security Password to 5GHz** (checkbox is unchecked).
- 5GHz Wireless Network Name (SSID):** A text input field containing "PROLINK_PRC3801_5G_10C7" with a note "(Maximum 32 Characters)".
- 5GHz Wireless Security Key:** A text input field containing "prolink12345" with a note "(Minimum 8 characters)".

At the bottom of the form are two buttons: "BACK" and "APPLY & REBOOT".

- PRC3801 will reboot and attempt internet connection.

Rebooting...

Reboot in progress... 17%

1. Isi Kemasan

1



2

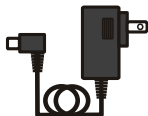

3



4



Item:

- 1 Satu (1) unit PRC3801
- 2 Satu (1) unit Adaptor Daya
- 3 Satu (1) kabel RJ45 Ethernet
- 4 Satu (1) Buku Panduan Instalasi (QIG)

Catatan:

1. Ilustrasi didalam dokumen ini mungkin akan berbeda dari model perangkat yang Anda miliki.
2. Jika terdapat item diatas yang tidak ditemukan pada isi kemasan, silahkan untuk menghubungi dealer Anda secepatnya

2. Penjelasan Perangkat

Tampak Atas (Indikator LED)

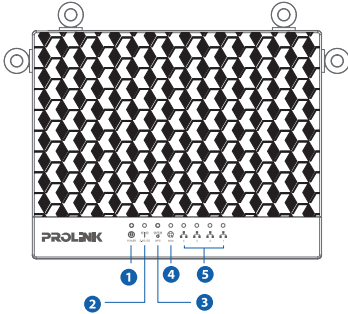

Tampak Bawah

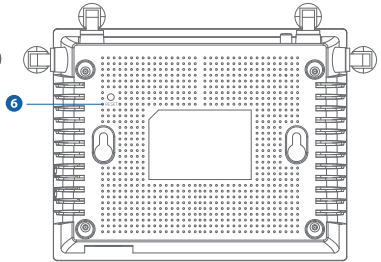

Tombol dan Antarmuka

- 1 PWR : ON - Perangkat dinyalakan
OFF - Perangkat dimatikan
- 2 2.4G/5G : ON - Nirkabel aktif
OFF - Nirkabel dimatikan
Berkedip - Paket nirkabel sedang dikirim
- 3 WPS : OFF - Idle
Berkedip - WPS sedang dipicu
- 4 WAN : ON - WAN aktif
OFF - Tidak ada Tautan WAN
Berkedip - WAN paket ethernet sedang dikirim
- 5 LAN 1 - 4 : ON - LAN aktif
OFF - Tidak ada Tautan LAN
Berkedip - paket ethernet LAN sedang dikirim
- 6 RESET : Tekan tombol ini paling sedikit 7 detik untuk meRESET perangkat ke pengaturan standarnya

2. Penjelasan Perangkat

Tampak Belakang

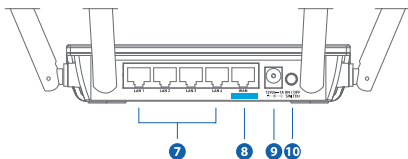

Tampak Samping

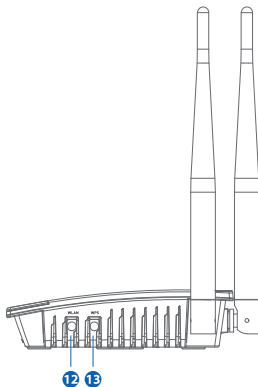

Tampak Depan

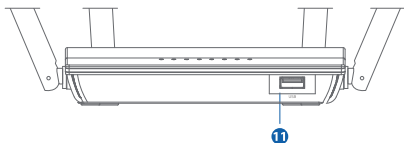

- 7 LAN 1 - 4 : Port LAN Untuk menghubungkan Router ke PC
- 8 WAN : Port WAN terhubung ke perangkat dengan akses internet. Biasanya terhubung ke modem DSL / Cable, atau ke jaringan switch di rumah / kantor.
- 9 POWER : Soket daya untuk menghubungkan adaptor ke Router.
- 10 POWER : Tombol untuk Menyalakan / Mematikan
BUTTON
- 11 USB : Sambungkan ke perangkat storage USB untuk file sharing
- 12 WLAN : Tekan tombol ini sekurangnya 3 detik untuk menyalakan / mematikan signal jaringan nirkabel
- 13 WPS : Tekan tombol ini sekurangnya 3 detik maka LED WPS akan mulai berkedip untuk memulai WPS.

Catatan:

Ilustrasi dalam dokumen ini mungkin tampak berbeda dari model Anda.

3. Diagram Aplikasi

3.1 Koneksi via ADSL Modem / Cable Modem / Fibre Optic ONT



3.2 Koneksi ke jaringan Rumah / Kantor menggunakan Switch Hub

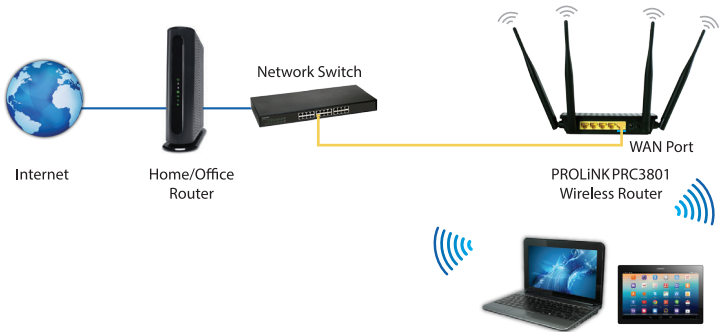

4. Konfigurasi Router

Langkah 1: Koneksi Perangkat keras (Wired or Wireless)

Hubungkan PRC3801 ke komputer Anda via kable Ethernet or koneksi Nirkabel (Wireless)



Catatan:

Nama Wireless dan password dapat di lihat pada label yang berada di bagian belakang dari PRC3801

PROLink PRC3801
Wireless Router

Langkah 2: Konfigurasi Perangkat Lunak via Peramban

1. Buka peramban dan ketikkan **http://192.168.123.254** atau **http://prc3801.prolink** pada address bar.



atau



4. Konfigurasi Router

- Standar login username adalah **admin**, password adalah **password**

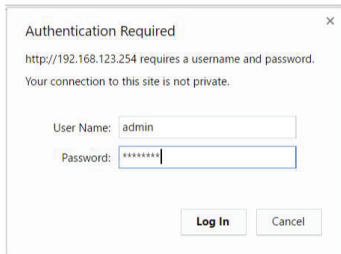

- Pilih pengaturan **SETUP WIZARD**

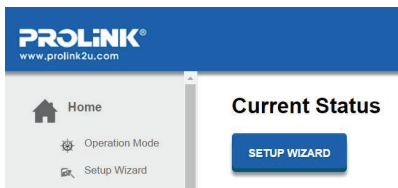

- Pilih **WAN ACCESS TYPE*** Anda dan tekan **NEXT**

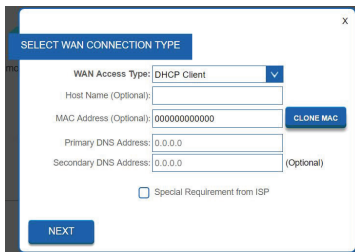

Catatan:

- Untuk pengguna PPPoE, silakan cek Username, Password atau keperluan khusus lainnya dari ISP dan masukkan nilai yang dibutuhkan.
- Untuk modem Cable Modem / Fiber Modem, atau penyambungan ke jaringan Rumah / Kantor, pilih mode DHCP Client (setting standar Router).

4. Konfigurasi Router

- Konfigurasi nama jaringan nirkabel Anda **Wireless Network Name (SSID)** dan **Wireless Security Key**, tekan tombol **APPLY & REBOOT**.

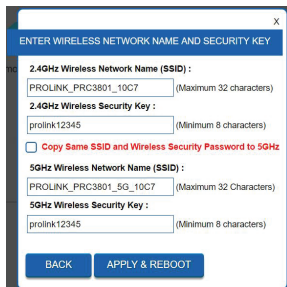

The screenshot shows a web-based configuration window titled "ENTER WIRELESS NETWORK NAME AND SECURITY KEY". It contains the following fields and options:

- 2.4GHz Wireless Network Name (SSID):** A text input field containing "PROLINK_PRC3801_10C7" with a note "(Maximum 32 characters)".
- 2.4GHz Wireless Security Key:** A text input field containing "prolink12345" with a note "(Minimum 8 characters)".
- Copy Same SSID and Wireless Security Password to 5GHz** (checkbox is unchecked).
- 5GHz Wireless Network Name (SSID):** A text input field containing "PROLINK_PRC3801_5G_10C7" with a note "(Maximum 32 Characters)".
- 5GHz Wireless Security Key:** A text input field containing "prolink12345" with a note "(Minimum 8 characters)".

At the bottom, there are two buttons: "BACK" and "APPLY & REBOOT".

- PRC3801 akan reboot dan akan melakukan koneksi ke internet.

Rebooting...

Reboot in progress... 17%

KETENTUAN GARANSI (for Indonesia region only)

PROLINK®
www.prolink2u.com

Kami mengucapkan terima kasih atas kepercayaan Anda memilih produk kami dan selaku distributor di Indonesia, kami memberikan garansi produk selama 1 (satu) tahun.

1. Garansi Hanya Berlaku Jika :

- Diisi dengan jelas, lengkap dan benar.
- Jika telah dikirimkan dan diterima oleh PT. Prolink Intidata Nusantara.
- Memperlihatkan kartu garansi asli dan nota pembelian pada saat klaim service.

2. Garansi Tidak Berlaku Apabila :

- Kerusakan yang disebabkan oleh, kelalaian pemakai, bencana alam, kebakaran, tegangan listrik yang terlalu tinggi / rendah, terkena cairan.
- Kerusakan yang diakibatkan karena transportasi / pengiriman, pemasangan / pengoperasian yang tidak sesuai dengan buku petunjuk, penyambungan dengan alat lain.
- Barang yang diservice tidak sesuai dengan kartu garansi.
- Serial number rusak / robek / tidak ada.

3. Ruang Lingkup Garansi :

- Garansi hanya mencakup bagian-bagian / komponen perangkat keras dari konfigurasi standar yang terdapat pada spesifikasi produk sesuai dengan faktur.
- Khusus netbook garansi baterai hanya berlaku selama 6 bulan sejak tgl. pembelian.

* Biaya pengiriman ditanggung pembeli



PROLINK®
www.prolink2u.com

Tempelkan perangkat
disini.
Hanya untuk pengeposan
di Indonesia

Kepada Yth.
Customer Service
PT. PROLINK INTIDATA NUSANTARA
Jl. Cideng Barat No.79
Jakarta Pusat 10150 - Indonesia



KARTU GARANSI
(for Indonesia region only)

No :**KARTU GARANSI / WARRANTY CARD***(for Indonesia region only)*

Barang : Data Comm Networking Netbook

Produk : UPS Display* Accessories

S/N :

Nama :
Name :

Model :

Alamat :
Address :

Tgl. Pembelian :
Purchase Date :

Dealer :
Toko :

Kota : **Kode Pos** :

Kota :
City :

Tel / Fax :**Email :****Pelanggan****PT. Prolink Intidata Nusantara****Cap Toko**

*Kartu Garansi harus diisi lengkap, kirimkan paling lambat 14 Hari setelah Tgl. Pembelian / Please Fill - in Your Warranty Card Completely and Send max.14 day after Purchase
* Tendaftar No.2134/1.824.124*

Alamat Pengiriman : **PT. PROLINK INTIDATA NUSANTARA**
Address : **Jl. Cideng Barat No.79 Jakarta Pusat 10150 - Indonesia**

Telp. : (62-21) 34831777
Fax : (62-21) 34830788
Email : service@prolink.co.id

No :**KARTU GARANSI / WARRANTY CARD***(for Indonesia region only)*

Barang : Data Comm Networking Netbook

Produk : UPS Display* Accessories

S/N :

Nama :
Name :

Model :

Alamat :
Address :

Tgl. Pembelian :
Purchase Date :

Dealer :
Toko :

Kota : **Kode Pos** :

Kota :
City :

Tel / Fax :**Email :****Pelanggan****PT. Prolink Intidata Nusantara****Cap Toko**

*Kartu Garansi harus diisi lengkap, kirimkan paling lambat 14 Hari setelah Tgl. Pembelian / Please Fill - in Your Warranty Card Completely and Send max.14 day after Purchase
* Tendaftar No.2134/1.824.124*

Alamat Pengiriman : **PT. PROLINK INTIDATA NUSANTARA**
Address : **Jl. Cideng Barat No.79 Jakarta Pusat 10150 - Indonesia**

Telp. : (62-21) 34831777
Fax : (62-21) 34830788
Email : service@prolink.co.id

Worldwide Customer Care Centers

SINGAPORE Office (Head Office)

FIDA INTERNATIONAL (S) PTE LTD

Walk-In : Block 16 Kallang Place #06-02, Kallang Basin Industrial Estate, Singapore 339156.

Email Support : support@prolink2u.com

MALAYSIA Office

FIDA SYSTEMS (M) SDN BHD

Walk-In : 29 Jalan USJ 1/31, 47600 Subang Jaya, Selangor Darul Ehsan, Malaysia.

Email Support : support.my@prolink2u.com

INDONESIA Office

PT PROLiNK INTIDATA NUSANTARA

Walk-In : Jl. Cideng Barat No. 79, Jakarta Pusat 10150, Indonesia.

Email Support : support.id@prolink2u.com

Technical Support Hotline

SINGAPORE : +65 6357 0666

MALAYSIA : +60 3 8023 9151

INDONESIA : +62 21 3483 1717

VIETNAM : +84 942 274 727

Note: Closed on Saturdays, Sundays and local/regional Public Holidays.

Register Online For Your Product Warranty @ www.prolink2u.com/register

PROLiNK® is a trademark of Fida International (S) Pte Ltd and is manufactured under its authority. Microsoft®, Windows®, Windows® 98SE/ME/2000/XP/Vista/7/8/10 are either registered trademarks or trademarks of Microsoft Corporation. Mac and the Mac logo are trademarks of Apple, Inc., registered in the U.S. and other countries. Linux® is a registered trademark of Linus Torvalds and Linux penguin "Tux" created by Larry Ewing and The Gimp. All other brands, products, services, logos and company names mentioned herein are trademarks of their respective owners. All specifications, designs and contents are subjected to changes without prior notice. Images are for demonstration and may vary from actual products. © Copyright 2017. PROLiNK® All rights reserved.