

D-Link®



EXO

AC2600 MU-MIMO Wi-Fi Router
QUICK INSTALL GUIDE

DIR-882

Package Contents



DIR-882 AC2600 High Power Wi-Fi Gigabit Router



Power Adapter



Ethernet Cable



Wi-Fi Configuration Card



Quick Install Guide

If any of the above items are missing, please contact your reseller.

Minimum Requirements

Network Requirements:

- An Ethernet-based broadband modem

Web-based Configuration Requirements

- Computer, smartphone or tablet with a Web browser*

* We recommend using the latest available browser version for the best compatibility and performance.

Hardware Overview

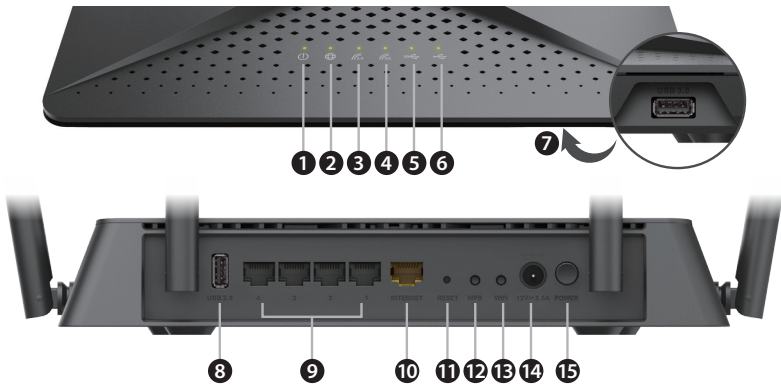

| | | |
|----|--------------------------------|---|
| 1 | Power LED | A solid light indicates a proper connection to the power supply. The light will be a solid orange during boot up. |
| 2 | Internet LED | A solid light indicates connection on the Internet port. If the LED is orange, the router cannot connect to the Internet. |
| 3 | Wireless (2.4 GHz) LED | A solid light indicates that the 2.4 GHz wireless band is enabled. |
| 4 | Wireless (5 GHz) LED | A solid light indicates that the 5 GHz wireless band is enabled. |
| 5 | USB 3.0 LED | A solid white light indicates a USB 3.0 device is connected. |
| 6 | USB LED | A solid white light indicates a USB 2.0 device is connected. |
| 7 | USB 3.0 Port | Connect a USB flash drive to share content throughout your network. Supports USB 3.0 and USB 2.0 devices. |
| 8 | USB 2.0 Port | Connect a USB flash drive to share content throughout your network. Supports USB 2.0 devices. |
| 9 | Gigabit LAN Ports (1-4) | Connect Ethernet devices such as computers, switches, storage (NAS) devices and game consoles. |
| 10 | Gigabit Internet Port | Connect a broadband modem or gateway to this port using an Ethernet cable. |
| 11 | Reset Button | Insert a paperclip in the hole, wait for 10 seconds, and release to reset the router to default settings. |
| 12 | WPS Button | Press to start the WPS process and automatically create a secure connection to a WPS client. |
| 13 | WiFi Button | Press this button to turn on or off the wireless networks. |
| 14 | Power Connector | Connect the supplied power adapter. |
| 15 | Power Button | Press to power the router on or off. |

Before you Start

- **Users with DSL providers** - If you are using a PPPoE connection, you will need your PPPoE user name and password. If you do not have this information, contact your Internet provider. Do not proceed until you have this information.
- **Users with Cable providers** - Make sure you unplug the power to your modem. In some cases, you may need to turn it off for up to 5 minutes.

Connect your Router

- 1 Unplug the power to your DSL or Cable modem.

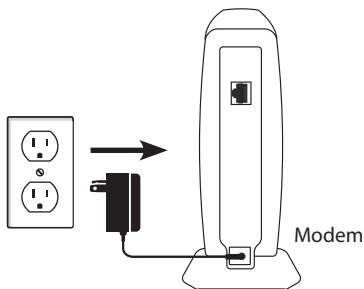

- 2 Connect an Ethernet cable from the Internet port of the router to the Ethernet port on your DSL or Cable modem.

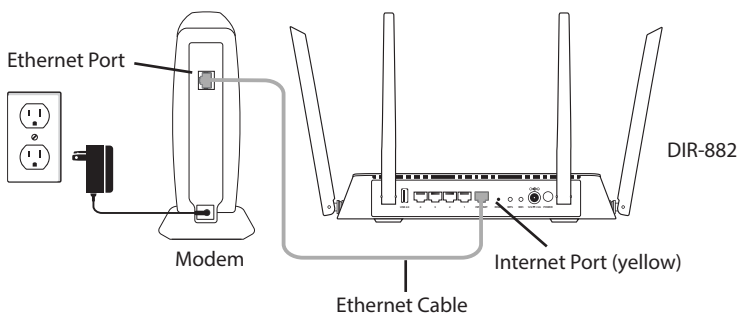

- 3** Connect another Ethernet cable from the Ethernet port on your computer to one of the LAN ports on the router. You can also connect wirelessly to the router with your computer. Use the supplied Wi-Fi Configuration Card for the Wi-Fi network name (SSID) and Wi-Fi password of the router. Complete steps 4 and 5 before attempting to connect.

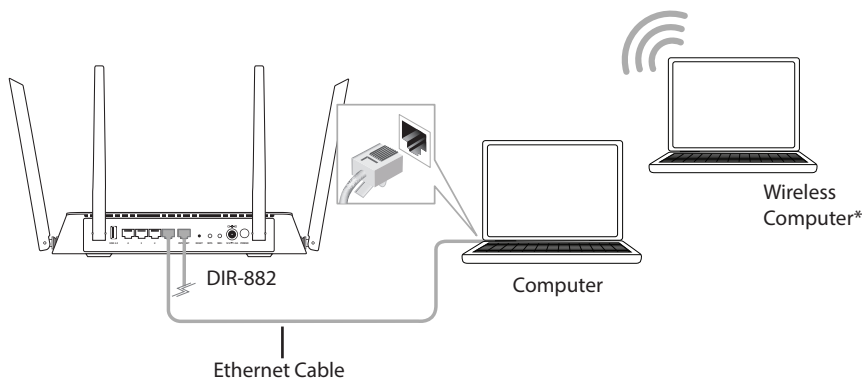

- 4** Plug the power back into your DSL or cable modem. Please wait about one minute before continuing.

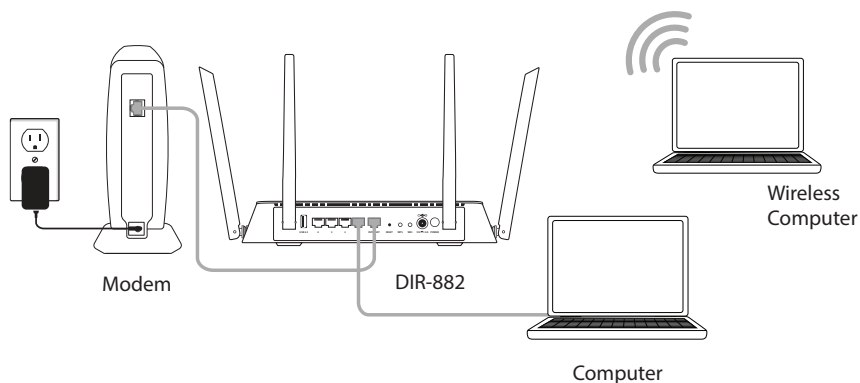

- 5 Plug the power adapter into your router and connect to an available power outlet or surge protector. If the Power LED does not light up, press the Power button on the back of the router.

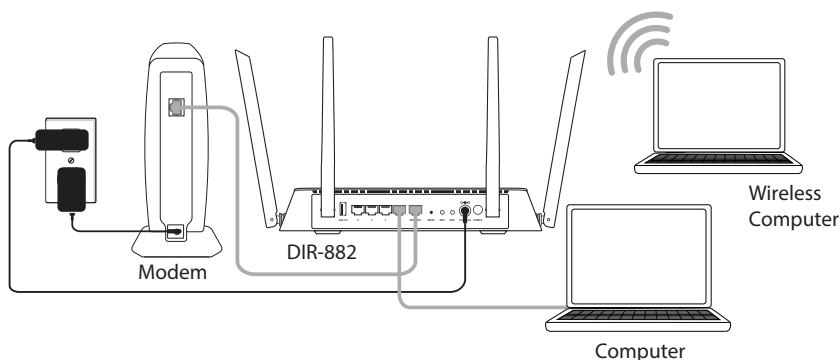

- 6 After the router has powered up, verify that the Power and Internet LEDs are both lit. Proceed with router configuration.

* If you are connecting wirelessly, you may now connect to the router using the supplied Wi-Fi Configuration Card for the Wi-Fi network name (SSID) and Wi-Fi password.

Configuration

There are two ways to configure your router:

- Web Browser** - Use a web browser from your computer.
- QRS Mobile app** - Use a mobile device with the D-Link QRS Mobile app. Refer to the *QRS Mobile Setup* section for more information.

A. Web Browser Configuration

- 1 Open a web browser (e.g. Internet Explorer, Chrome, Firefox, or Safari) and enter **<http://dlinkrouter.local/>** or the IP address of the router (**<http://192.168.0.1>**).

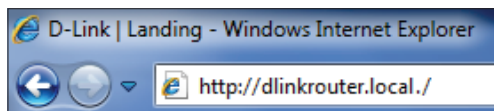

2 When the Welcome screen appears, click **Next** to continue.

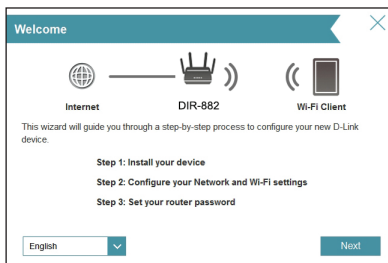

3 The router will automatically detect your Internet connection type. If it cannot, then select your Internet connection and click **Next** to continue.

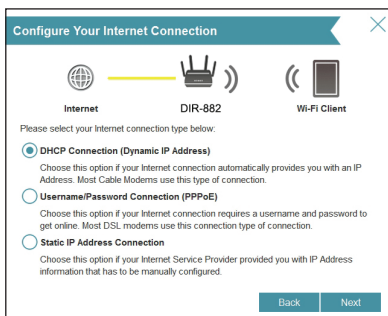

For DSL (PPPoE) users, enter your PPPoE user name and password supplied by your ISP. Click **Next** to continue.

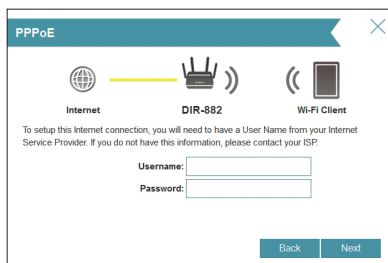

If you have a Static IP connection, enter the IP information and DNS settings supplied by your ISP. Click **Next** to continue.

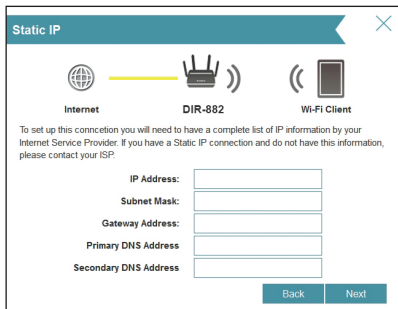

The screenshot shows a window titled "Static IP" with a close button in the top right. At the top, there is a diagram showing "Internet" (globe icon) connected to "DIR-882" (router icon), which is connected to "Wi-Fi Client" (phone icon). Below the diagram, a text block reads: "To set up this connection you will need to have a complete list of IP information by your Internet Service Provider. If you have a Static IP connection and do not have this information, please contact your ISP." Below this are five input fields: "IP Address:", "Subnet Mask:", "Gateway Address:", "Primary DNS Address:", and "Secondary DNS Address:". At the bottom right are "Back" and "Next" buttons.

- 4** Create a name and password for your Wi-Fi Network. Your wireless devices (e.g. tablets, smartphones, and laptops) will need to have this information entered to be able to connect to your wireless network. Click **Next** to continue.

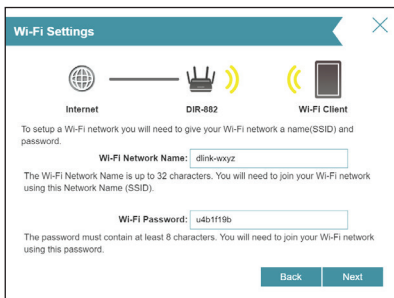

The screenshot shows a window titled "Wi-Fi Settings" with a close button in the top right. At the top, there is a diagram showing "Internet" (globe icon) connected to "DIR-882" (router icon), which is connected to "Wi-Fi Client" (phone icon). Below the diagram, a text block reads: "To setup a Wi-Fi network you will need to give your Wi-Fi network a name(SSID) and password." Below this is a "Wi-Fi Network Name:" field with the value "dlink-xyz" entered. A text block below reads: "The Wi-Fi Network Name is up to 32 characters. You will need to join your Wi-Fi network using this Network Name (SSID)." Below that is a "Wi-Fi Password:" field with the value "u4b1f19b" entered. A text block below reads: "The password must contain at least 8 characters. You will need to join your Wi-Fi network using this password." At the bottom right are "Back" and "Next" buttons.

- 5** Continue with the Setup Wizard to finish configuring your DIR-882 router. Once completed, the Internet LED will turn green indicating that your router is connected to the Internet.

Congratulations! You have completed the router installation.

B. QRS Mobile Setup

- 1 Scan the code below or search "QRS Mobile" (App Store or Google Play) to download the QRS Mobile App to your iPhone, iPad, or Android device.



iOS



Android



QRS Mobile App

- 2 Once your app is installed, you may now configure your router. Connect to the router wirelessly by going to your wireless utility on your device. Scan for the wireless network name as listed on the supplied Wi-Fi Configuration card/sticker. Select the network and then enter the Wi-Fi Password.

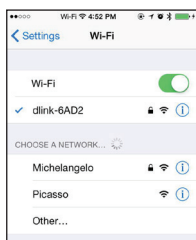

| D-Link Wi-Fi Configuration Card | |
|--|--|
| Default Configuration | Wi-Fi Name(SSID) 2.4GHz: _____ |
| Wi-Fi Name(SSID) 2.4Ghz: dlink-xxxx | Wi-Fi Password: _____ |
| Wi-Fi Name(SSID) 5GHz: dlink-xxxx-5GHz | Wi-Fi Name(SSID) 5GHz *: _____ |
| Password: xxxxxxxx | Wi-Fi Password *: _____ |
| To configure your router, go to: http://dlinkrouter.local Or http://192.168.0.1 Username: "Admin" Password: "" (leave the field blank) | Your configuration Username: "Admin" Password: _____ _____ |
| | *For applicable models |

DCW909WR010

- 3 Once connected, tap on the **QRS Mobile** icon from your mobile device, then tap **Start** to continue. Please follow the on-screen instructions to complete the setup.

- 4 Once the *Setup Complete* screen appears, tap **Save** and write down the new Wi-Fi Network name and password on your companion card for future reference.

Note: To reconnect to your router, launch your wireless utility, select the new Wi-Fi Network you created, and then enter your new Wi-Fi password.

Troubleshooting

How do I connect my wireless devices to the DIR-882 router?

1. Open your wireless network utility that displays available wireless networks.
2. Select the Wi-Fi Network name you assigned in the wizard and connect.

Note: If you did not run the setup wizard or you reset the router to its default settings, refer to the Wi-Fi Configuration Card included for the default Wi-Fi Network Name and Wi-Fi Password.

You can also connect wireless devices to the DIR-882 router using WPS:

1. Press the WPS button on the DIR-882 for three seconds.
2. Within one minute press the WPS button on your wireless device.
3. Allow up to two minutes to connect.

Note: Some devices may require you to log in to a utility to start the WPS process. Refer to the user manual of the device you want to connect to the router if you do not know how to start the WPS process.

How do I change the wireless settings on the DIR-882 router?

1. Open a web browser (e.g., Internet Explorer, Chrome, Firefox, or Safari) and enter **http://dlinkrouter.local/** You can also enter the IP address of the router (**http://192.168.0.1**).
2. At the login screen, enter the router password you created in the wizard.
3. Go to **Settings > Wireless** to create a new Wi-Fi network name (SSID) and Wi-Fi password.

*Documentation available at:

United States: <http://support.dlink.com/DIR-882>

Canada: <http://support.dlink.ca/DIR-882>

GPL Code Statement

This D-Link product includes software code developed by third parties, including software code subject to the GNU General Public License ("GPL") or GNU Lesser General Public License ("LGPL"). As applicable, the terms of the GPL and LGPL, and information on obtaining access to the GPL code and LGPL code used in this product, are available to you at:

<http://tsd.dlink.com.tw/GPL.asp>

The GPL code and LGPL code used in this product is distributed WITHOUT ANY WARRANTY and is subject to the copyrights of one or more authors. For details, see the GPL code and the LGPL code for this product and the terms of the GPL and LGPL.

Written Offer for GPL and LGPL Source Code

Where such specific license terms entitle you to the source code of such software, D-Link will provide upon written request via email and/or traditional paper mail the applicable GPL and LGPL source code files via CD-ROM for a nominal cost to cover shipping and media charges as allowed under the GPL and LGPL.

Please direct all inquiries to:

Email:

GPLCODE@dlink.com

Snail Mail:

Attn: GPLSOURCE REQUEST
D-Link Systems, Inc.
17595 Mt. Herrmann Street
Fountain Valley, CA 92708

GNU GENERAL PUBLIC LICENSE

Version 3, 29 June 2007

Copyright (C) 2007 Free Software Foundation, Inc. <<http://fsf.org/>>

View the full GPL Code Statement at **<http://www.gnu.org/licenses/gpl.html>**

Technical Support

Having trouble installing your new product? D-Link's website contains the latest user documentation and software updates for D-Link products. U.S. and Canadian customers can contact D-Link Technical Support through our website.

United States

Internet: <http://support.dlink.com>

Canada

Internet: <http://support.dlink.ca>

D-Link®

Version 1.00(US)_128x188

May 15, 2017

610000007555

©2017 D-Link Corporation/D-Link Systems, Inc. All rights reserved. D-Link and the D-Link logo are registered trademarks of D-Link Corporation or its subsidiaries in the United States and other countries. iPhone, iPad, and iPod touch are registered trademarks of Apple Inc. Android is a trademark of Google, Inc. Other trademarks are the property of their respective owners. Maximum wireless signal rate derived from IEEE Standard 802.11ac, 802.11g, and 802.11n specifications. Actual data throughput will vary. Network conditions and environmental factors, including volume of network traffic, building materials and construction, and network overhead, lower actual data throughput rate. Environmental factors will adversely affect wireless signal range. Product specifications, size and shape are subject to change without notice, and actual product appearance may differ from that depicted on the packaging. Visit www.dlink.com for more details.