

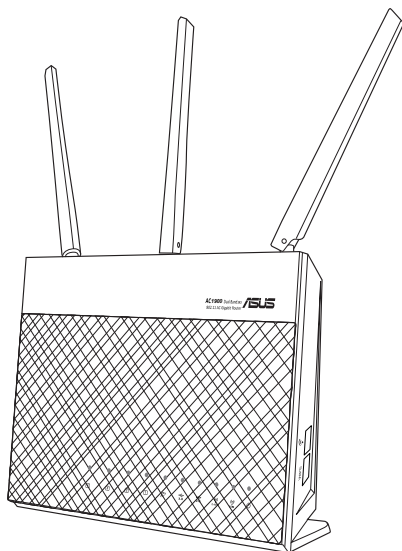

# RT-AC1900P Dual Band 3x3 Wireless-AC 1900 Gigabit Router



## Quick Start Guide

## Table of contents

English.....	3
T-Chinese.....	18
French.....	33
Português.....	48
Spanish.....	63



### **NOTE / <注意> / <REMARQUE> / <NOTA>/<NOTA>**

- For more details, refer to the user manual included in the support CD.
  - 更多資訊，請參考驅動程式與公用程式光碟中的使用手冊。
  - Pour plus de détails, consultez le manuel de l'utilisateur contenu dans le CD de support.
  - Para mais detalhes, consulte o manual do utilizador incluído no CD de suporte.
  - Para obtener más detalles, consulte el manual del usuario incluido en el CD de soporte.
-

## Package contents

- ☑ RT-AC1900P
- ☑ Network cable (RJ-45)
- ☑ Support CD (User Manual)
- ☑ AC adapter
- ☑ Quick Start Guide



**NOTE:** If any of the items is damaged or missing, contact your retailer.

## A quick look at your RT-AC1900P

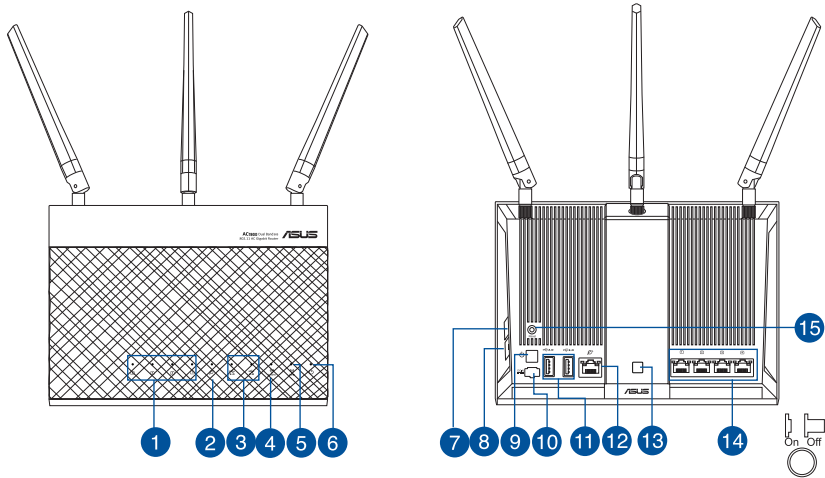

1) LAN 1~4 LED	6) Power LED	11) USB 3.0/2.0 ports
2) WAN (Internet) LED	7) WPS button	12) WAN port
3) USB 3.0/2.0 LED	8) Wi-Fi On/Off button	13) LED On/Off button
4) 2.4GHz LED	9) Power switch	14) LAN ports
5) 5GHz LED	10) Power (DC-IN) port	15) Reset button



---

**NOTES:****• USB External HDD/Flash disk:**

- The wireless router works with most USB HDDs/Flash disks up to 2TB and supports read-write access for FAT16, FAT32, EXT2, EXT3, and NTFS.
  - To safely remove the USB disk, launch the web GUI (<http://192.168.1.1>), then in the **Network Map** page's upper right corner, click the USB icon and click **Eject USB 3.0 / USB 2.0**.
  - Incorrect removal of the USB disk may cause data corruption.
  - For the list of file system and hard disk partitions that the wireless router supports, visit <http://event.asus.com/networks/disksupport>
  - For the list of printers that the wireless router supports, visit <http://event.asus.com/networks/printersupport>
-



## Installing your router



**IMPORTANT:** Before installing the router, ensure that Internet connection is available

### 1. Position your wireless router.

For the optimal wireless transmission between the wireless router and connected wireless devices, ensure that you:

- Place the wireless router in a centralized area for a maximum wireless coverage for the network devices.
- Keep the wireless router away from metal obstructions and away from direct sunlight.
- Keep the wireless router away from 802.11g or 20MHz only Wi-Fi devices, 2.4GHz computer peripherals, Bluetooth devices, cordless phones, transformers, heavy-duty motors, fluorescent lights, microwave ovens, refrigerators, and other industrial equipment to prevent signal interference or loss.
- To ensure the best wireless signal, orient the three detachable antennas as shown in the drawing below.
- Always update to the latest firmware. Visit the ASUS website at <http://www.asus.com> to get the latest firmware updates.

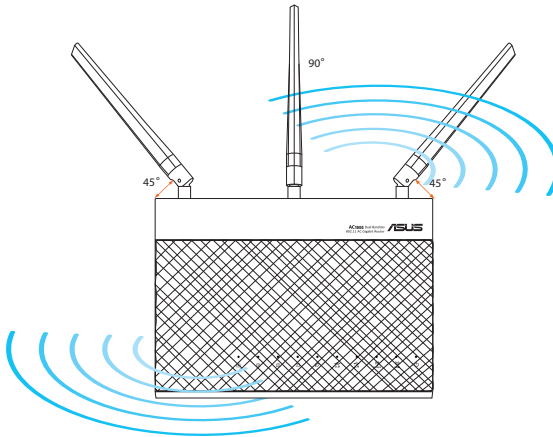

## 2. Prepare your modem.

- Unplug the AC adapter from the power outlet and disconnect it from your cable/ADSL modem.
- Disconnect the network cable from your cable/ADSL modem.
- Reboot your computer (recommended).

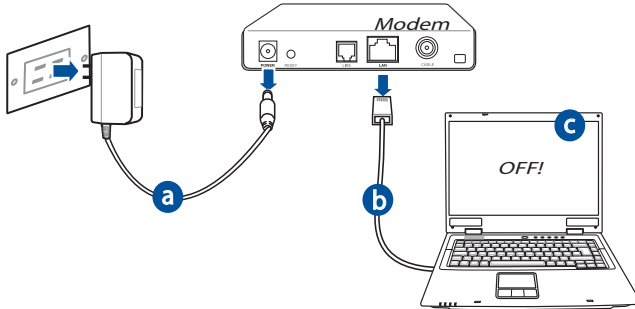

**WARNING!** Before disconnecting the wires/cables, ensure that your cable/ADSL modem has been turned off for at least two minutes. If your modem has a backup battery, remove it as well.

## 3. Set up your wireless environment.

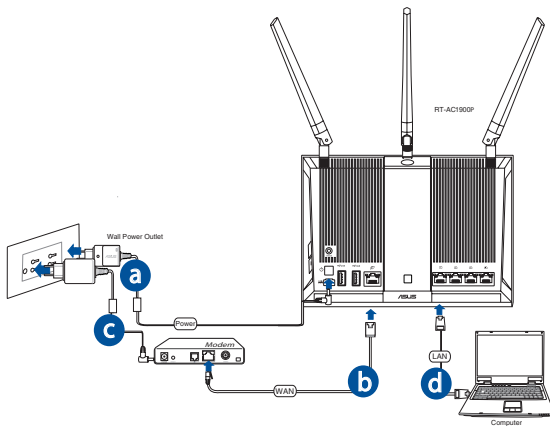

- a. Insert your wireless router's AC adapter to the DC-IN port and plug it to a power outlet.
- b. Using another network cable, connect your modem to your wireless router's WAN port.
- c. Insert your modem's AC adapter to the DC-IN port and plug it to a power outlet.
- d. Using the bundled network cable, connect your computer to your wireless router's LAN port. Ensure that the WAN and LAN LEDs are blinking.



---

**NOTE:** You can also set up RT-AC1900P using a mobile device such as smartphone or tablet PC. To do this, go to **Setup your router using a mobile device** for details.

---

#### 4. Disable some settings on your computer.

- a. Disable the proxy server, if enabled.
- b. Set the TCP/IP settings to automatically obtain an IP address.
- c. Disable the dial-up connection, if enabled.



---

**NOTE:** For more details on disabling your computer settings, refer to **Frequently Asked Questions (FAQs)**.

---

## Setting up your router using the Quick Internet Setup Wizard

To set up your router using QIS ((Quick Internet Setup):

1. Press the power button at the back of your router. Ensure that the Power, LAN and WAN LEDs are on.
2. Launch your web browser such as Internet Explorer, Firefox, Google Chrome, or Safari.

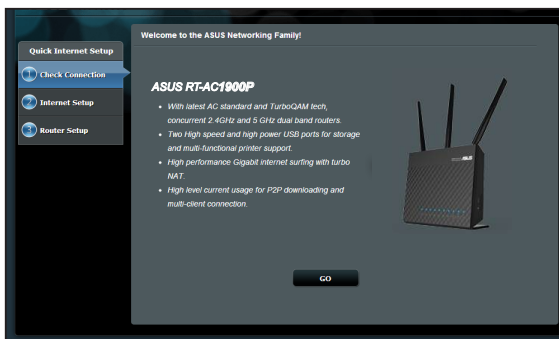

---

**NOTE:** If QIS does not launch automatically, enter <http://192.168.1.1> or <http://router.asus.com> in the address bar and refresh the browser again.

---

3. Assign your router login name and password and click **Next**. You will need this login name and password to log into RT-AC1900P to view or change the router settings. You can take note of your router login name and password for future use.

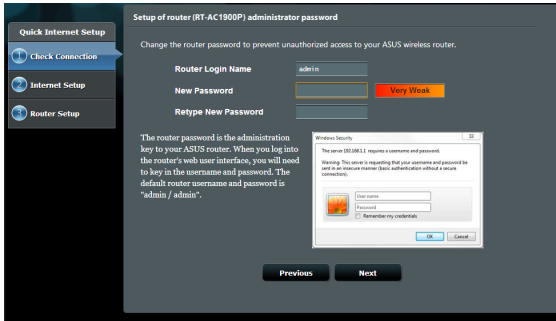

Login name: \_\_\_\_\_

Login password: \_\_\_\_\_

4. The wireless router's Quick Internet Setup (QIS) feature automatically detects if your ISP connection type is **Dynamic IP**, **PPPoE**, **PPTP**, **L2TP**, and **Static IP**. Please obtain the necessary information about your Internet connection type from your Internet Service Provider (ISP). If your connection type is Dynamic IP (DHCP), QIS wizard will automatically direct you to the next step.



**NOTE:** If your connection type is Static IP, choose **Static IP** and click **Next**. Key in IP address, subnet mask, default gateway and DNS server information provided by your ISP. Click **Next** to proceed.

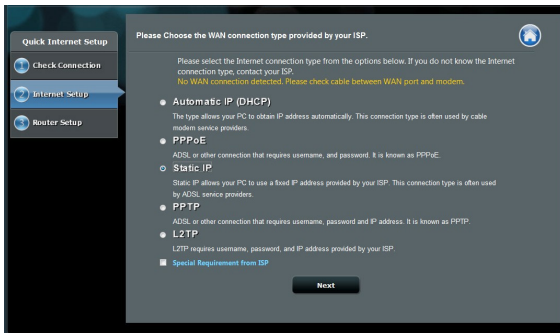

Quick Internet Setup

- 1 Check Connection
- 2 Internet Setup
- 3 Router Setup

Please refer to your ISP setting, and input the related information.

Use the following IP address:

IP Address

Subnet Mask

Default Gateway

DNS Servers

DNS Server1

DNS Server2

MAC Address (optional)

- Assign the network name (SSID) and security key for your 2.4GHz and 5GHz wireless connection. Click **Apply** when done.

Quick Internet Setup

- 1 Check Connection
- 2 Internet Setup
- 3 Router Setup

Wireless Setting

Assign a unique name or SSID (Service Set Identifier) to help identify your wireless network.

2.4GHz - Security

Network Name (SSID)

Security Key

5GHz - Security  Copy 2.4GHz to 5GHz settings.

Network Name (SSID)

Security Key

- Your Internet and wireless settings are displayed. Click **Next** to continue.
- Read the wireless network connection tutorial. When done, click **Finish**.



### NOTES:

- You can assign a network name with up to 32 characters.
- Watch the setup tutorial video if needed.



## Setting up your router using a mobile device (optional)

You can also use your mobile device such as a smartphone or a tablet PC to set up RT-AC1900P through QIS wizard. The QIS wizard will automatically switch to the mobile version if you use a smartphone or a tablet PC to launch it.

To set up your router using a mobile device:

1. Turn on RT-AC1900P.
2. Enable Wi-Fi function of your mobile device.
3. Search for the SSID **ASUS**, which is the default SSID of your RT-AC1900P wireless network. Click this SSID to connect and wait for the status to display Wi-Fi connected.
4. Launch your mobile device web browser.

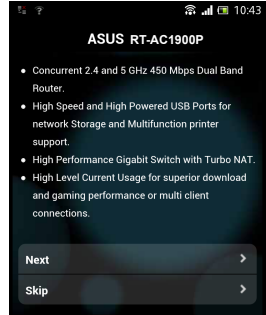

**NOTE:** If QIS does not launch automatically, enter <http://192.168.1.1> or <http://router.asus.com> in the address bar and refresh the browser again. You can also use your mobile device to scan for the QR code here to go to RT-AC1900P's web interface.



5. Assign your router login name and password, and click **Next**. You will need this login name and password to log into RT-AC1900P's web interface to view or change router settings. Ensure that you take note of your router login name and password for future use.

Login name:

\_\_\_\_\_

Login password:

\_\_\_\_\_



6. The QIS feature automatically detects if your ISP connection type is Dynamic IP, PPPoE, PPTP, L2TP, and Static IP. Enter the necessary information that your Internet Service Provider (ISP) has provided. If your connection type is Dynamic IP (DHCP), QIS wizard will automatically direct you to the next step.



**NOTE:** If your connection type is Static IP, choose **Static IP** and click **Next**. Enter the IP address, subnet mask, default gateway and DNS server information provided by your ISP. Click **Next** to proceed.

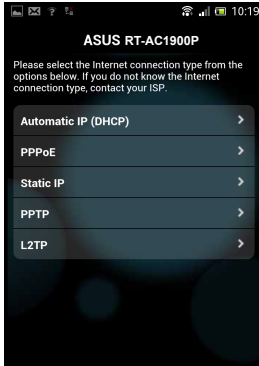

7. Assign the network name (SSID) and security key for your 2.4GHz and 5GHz wireless connection. Click **Apply** when done.





8. Your Internet and wireless settings are displayed. Click **Next** to continue.
9. Read the wireless network connection tutorial. When done, click **Finish**.



---

**NOTES:** You can assign a network name with up to 32 characters.

---

## Connect to the wireless network

There are two ways for your wireless clients (notebook, tablet PC, smartphone and so on) to connect to RT-AC1900P's wireless network.

### Connect to the wireless network manually

To connect to the wireless network manually:

1. Enable the Wi-Fi function on your wireless client to scan for available wireless networks.
2. Select the SSID or network name that you assigned to your RT-AC1900P's network.
3. Enter the password and click **Connect**.

### Connect to the wireless network through WPS

RT-AC1900P has a WPS (Wi-Fi Protected Setup) button for you to connect your wireless client to RT-AC1900P's network without entering password.

To connect to the wireless network through WPS:

1. Press the WPS button at the back of RT-AC1900P. Refer to the section **A quick look at your RT-AC1900P** for the location of the WPS button).
2. Press the WPS button of your wireless client within two minutes or follow the WPS instructions that came with the wireless client. When connecting via WPS, the Power LED on your router blinks fast.
3. Wait until your router's Power LED turns into a solid light indicating a successful connection between your router and your wireless client.

## Managing the router via the ASUSWRT web GUI

Your wireless router comes with the intuitive ASUSWRT web graphical user interface. ASUSWRT allows you to easily configure its various features through a web browser such as Internet Explorer, Firefox, Safari, or Google Chrome.



**NOTE:** Use the search bar on the bottom of the interface to get more information from ASUS technical support site <http://support.asus.com>.



### IMPORTANT:

- For more details on using your router's Web GUI, refer to the user manual.
- Always check and upgrade firmware to the latest version for better experience.
- Visit ASUS Networking video channel for tutorial videos on featured functions.



## AiCloud

ASUS AiCloud app provides you with access to your data wherever and whenever you have an Internet connection. It also allows you to access your ASUS WebStorage account via the AiCloud mobile app on your iOS or Android device, or via a web browser.

To install AiCloud:

1. Ensure that your router's firmware version is the latest one and supports AiCloud.
2. Download AiCloud app from Google Play or App Store.
3. Install your USB storage device to your router. Refer to section **A quick look at your RT-AC1900P** for the location of the USB ports.
4. Connect your iOS or Android devices to the router through Wi-Fi. The AiCloud app will automatically guide you through the setup process.
5. You can now access, stream and share to all files in your USB storage. Search ASUS AiCloud for more information. Watch tutorial videos for step-by-step guide.



Google Play



App Store

## Frequently Asked Questions (FAQs)

### After following the steps, I still cannot access the wireless router's web graphics user interface (web GUI) to configure the wireless router settings.

Ensure that your PC's proxy settings are disabled and your PC'S IP address is obtained from the DHCP server automatically. for details on disabling the proxy settings, visit the ASUS Support site at <http://support.asus.com>. For details on using the DHCP server to obtain IP addresses automatically, refer to your Windows® or Mac operating system's help feature.

### The client cannot establish a wireless connection with the router.

#### Out of Range:

- Put the router closer to the wireless client.
- Try to change the channel settings.

#### Authentication:

- Use wired connection to connect to the router.
- Check the wireless security settings.
- Press the Reset button at the rear panel for more than five seconds.

#### Cannot find the router:

- Press the Reset button at the rear panel for more than five seconds.
- Check the setting in the wireless adapter such as SSID and encryption settings.

### Cannot access the Internet via wireless LAN adapter.

- Move the router closer to the wireless client.
- Check whether the wireless adapter is connected to the correct wireless router.
- Check whether the wireless channel in use conforms to the channels available in your country/area.
- Check the encryption settings.

- Check if the ADSL or Cable connection is correct.
- Retry using another Ethernet cable.

**If the ADSL “LINK” light blinks continuously or stays off, Internet access is not possible - the Router is unable to establish a connection with the ADSL network.**

- Ensure that all your cables are all properly connected .
- Disconnect the power cord from the ADSL or cable modem, wait a few minutes, then reconnect the cord.
- If the ADSL light continues to blink or stays OFF, contact your ADSL service provider.

**Network name or encryption keys are forgotten.**

- Try setting up the wired connection and configuring the wireless encryption again.
- Press the Reset button of the wireless router for more than five seconds.
- Factory default settings:

<b>User name / Password:</b> admin / admin	<b>IP address:</b> 192.168.1.1	<b>SSID:</b> ASUS
---	-----------------------------------	----------------------

**Where can I find more information about the wireless router?**

- User Manual in the support CD
- Online FAQ site: <http://support.asus.com/faq>
- Technical Support site: <http://support.asus.com>
- Customer Hotline: Refer to the Support Hotline in this Quick Start Guide

## 包裝內容物

- ☑ RT-AC1900P 無線路由器
- ☑ 電源變壓器
- ☑ 使用手冊光碟
- ☑ RJ45 網路線
- ☑ 快速使用指南



注意：若以上列出的任何一項配件有毀損或是短缺的情形，請儘速聯絡您的經銷商。

## 認識您的 RT-AC1900P 無線路由器

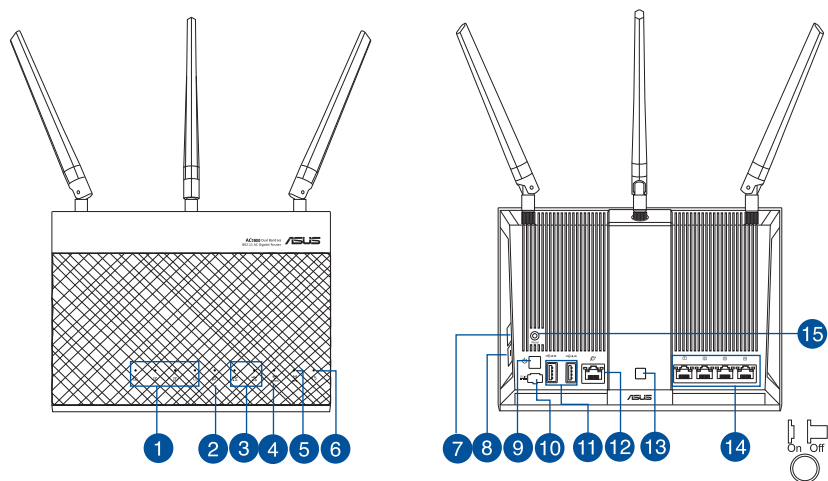

1) LAN 1-4 指示燈	6) 電源指示燈	11) USB 3.0/2.0 連接埠
2) WAN (網際網路) 指示燈	7) WPS 按鈕	12) WAN 連接埠
3) USB 3.0/2.0 指示燈	8) Wi-Fi 開啟 / 關閉按鈕	13) 指示燈開啟 / 關閉按鈕
4) 2.4GHz 指示燈	9) 電源開關	14) LAN 連接埠
5) 5GHz 指示燈	10) 電源輸入埠 (DC-IN)	15) 重置按鈕



---

## 注意：

- USB 外接硬碟 / 隨身碟：
    - 此無線路由器相容大多數容量高達 2TB 的 USB 硬碟 / 隨身碟，並支援 FAT16、FAT32、EXT2、EXT3 與 NTFS 的存取。
    - 欲安全移除 USB 磁碟，請登入網頁圖形使用者介面（<http://192.168.1.1>），接著在「網路地圖」頁面的右上角點選 USB 圖示並選擇 **退出 USB 磁碟**。
    - 錯誤移除 USB 碟將會導致資料遺失。
    - 請造訪 <http://event.asus.com/networks/disksupport> 獲得此無線路由器所支援的檔案系統與硬碟磁區清單。
    - 請造訪 <http://event.asus.com/networks/printersupport> 獲得此無線路由器所支援的印表機清單。
-

## 安裝您的路由器



**重要！** 安裝路由器之前，請確認網際網路連線可用。

### 1. 放置您的路由器

為獲得無線路由器與所連線的網路裝置之間的最佳無線傳送訊號，請確認以下幾點：

- 建議將路由器放置在中心區域，以覆蓋所有無線行動裝置。
- 請勿將裝置放在靠近金屬物品與陽光直射的地方。
- 請遠離其它 802.11g 或 20MHz Wi-Fi 裝置、2.4GHz 電腦周邊裝置、藍芽裝置、無線室內電話、傳送器、重型發動機、日光燈、微波爐、電冰箱與其他工業裝置，以防止訊號干擾或丟失。
- 請按照下圖所示擺放路由器上的三根可拆卸式天線以獲得最佳前後訊號覆蓋。
- 請經常更新至最新版本韌體。您可以登入華碩官網 <http://tw.asus.com> 獲得最新韌體。

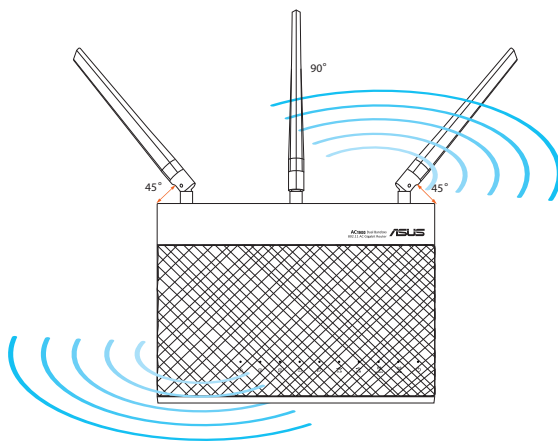



## 2. 準備數據機

- 拔掉 AC 變壓器的電源並斷開與有線 / ADSL 數據機的連接。
- 拔掉您有線 / ADSL 數據機的網路線。
- 重新開啟您的電腦（建議執行）。

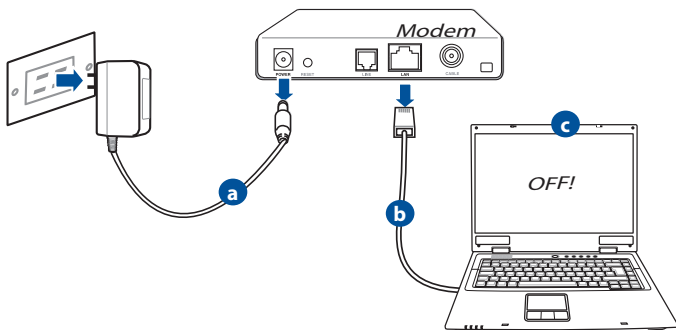

**警告！**請在斷開數據纜線與網路線之前，確認您的有線 / ADSL 已關閉超過二分鐘。若您的數據機有備用電池，請一併移除。

## 3. 設定無線環境

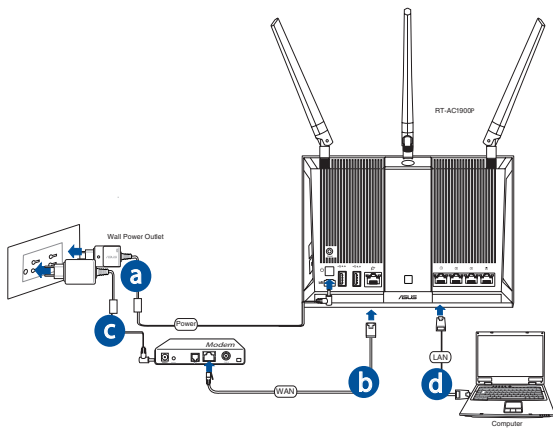

- a: 將無線路由器的 AC 變壓器插入電源輸入埠 (DC-IN) 並插上電源。
- b: 用另一條網路線將您的數據機連接至無線路由器的 WAN 連接埠。
- c: 將數據機的 AC 變壓器插入電源輸入埠 (DC-IN) 並插上電源。
- d: 使用附贈的網路線將您的電腦連接至您的無線路由器的 LAN 連接埠。



---

**注意：**您也可以使用行動裝置來設定 RT-AC1900P，譬如，智慧型手機或平板電腦。要進行此操作，參考「[使用行動裝置設定路由器](#)」部份的說明。

---

#### 4. 關閉電腦中的某些設定

- a. 關閉代理伺服器。
- b. 設定 TCP/IP 自動取得 IP 位址。
- c. 關閉撥號連線。



---

**注意：**更多資訊請參閱「[常見問題解答 \(FAQs\)](#)」。

---

## 使用網路設定精靈 (QIS) 設定路由器

依據以下步驟進行設定：

1. 按下路由器後側的電源按鈕。確定電源指示燈、LAN 指示燈以及 WAN 指示燈亮起。
2. 開啟一個網路瀏覽器，如 Internet Explorer、Firefox、Safari 或 Google Chrome。



**注意：**若網路設定精靈 (QIS) 未能自動開啟，請在您的網路瀏覽器中輸入 <http://192.168.1.1> 或 <http://router.asus.com> 並重新載入頁面。

3. 為路由器設定登入名稱與密碼，接著點選 **Next**。您需要使用此名稱與密碼來登入 RT-AC1900P 檢視並變更路由器設定。記錄下路由器登入名稱與密碼以備日後使用。

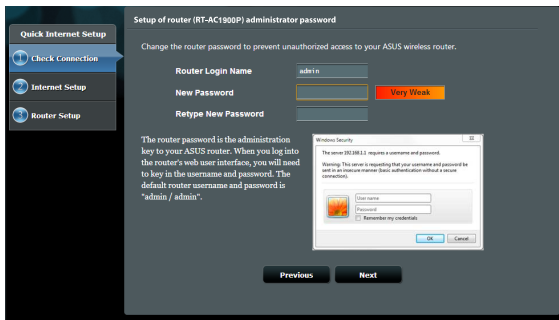

登入名稱：

登入密碼：

3. 此路由器的網路設定精靈 (QIS) 可自動偵測 ISP 連線類型：自動取得 IP、PPPoE、PPTP、L2TP 與固定 IP。請從您的 ISP 獲得網路連接類型的相關資訊。若您的網路連線類型為「自動取得 IP」(DHCP)，網路設定精靈 (QIS) 將自動引導您進入下一步。



**注意：**若您的網路連線類型為固定 IP，選擇「Static IP」並點選 **Next**。輸入 IP 位置、子網路遮罩、預設閘道以及 DNS 伺服器資訊。點選 **Next** 繼續。

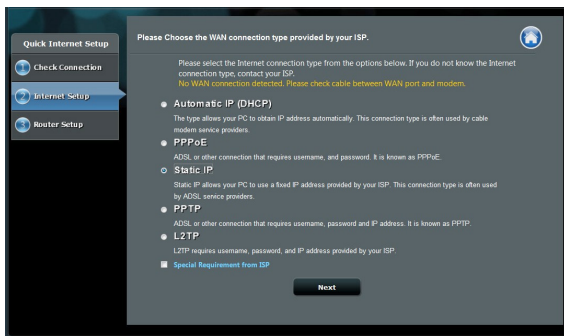

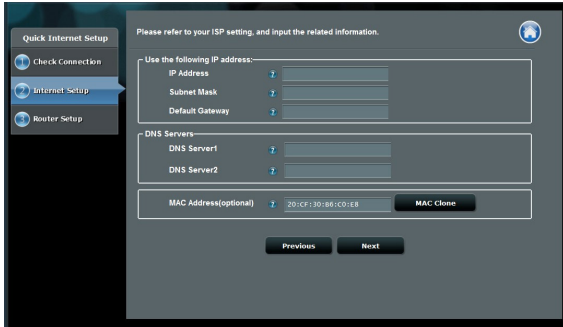

5. 指定網路名稱 (SSID) 與安全密鑰以連接 2.4GHz 與 5GHz 無線網路。完成後點選 **Apply**。

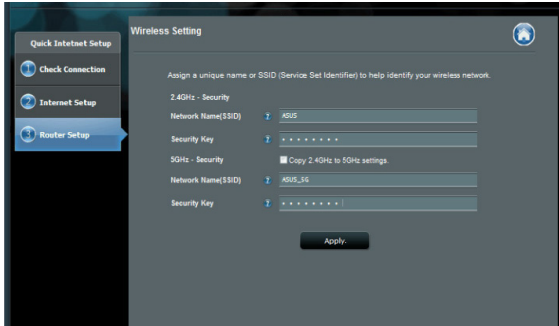

6. 畫面將顯示您的網路與無線設定。點選 **Next** 繼續。
7. 閱讀無線網路連線教程。完成後點選 **Finish**。



#### 注意：

- 您可以指定一個多達 32 字元的網路名稱。
- 若有需要，觀看設定視訊教程。



## 使用行動裝置設定路由器（選用）

您也可以透過網路設定精靈 (QIS) 使用行動裝置來設定 RT-AC1900P，譬如，智慧型手機或平板電腦。若您使用智慧型手機或平板電腦登入，網路設定精靈 (QIS) 會自動切換為行動版本。

1. 開啟 RT-AC1900P。
2. 開啟行動裝置的 Wi-Fi 功能。
3. 搜尋 SSID 為「ASUS」的無線網路，該名稱為 RT-AC68HP 無線網路的預設 SSID。點選此 SSID 進行連線，並等待顯示 Wi-Fi 連線狀態。
4. 開啟行動裝置的網路瀏覽器。

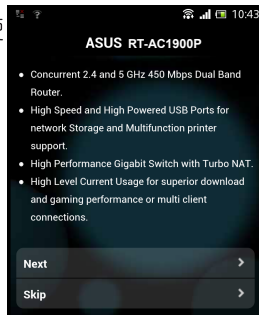

**注意：**若網路設定精靈 (QIS) 未能自動開啟，請在您的網路瀏覽器中輸入 <http://192.168.1.1> 或 <http://router.asus.com> 並重新載入頁面。您也可以使用行動裝置掃描此處的 OR code 進入 RT-AC1900P 的網頁圖形使用者介面。



5. 為路由器設定登入名稱與密碼，接著點選 **Next**。您需要使用此名稱與密碼來登入 RT-AC1900P 檢視並變更路由器設定。記錄下路由器登入名稱與密碼以備日後使用。

登入名稱：

\_\_\_\_\_

登入密碼：

\_\_\_\_\_

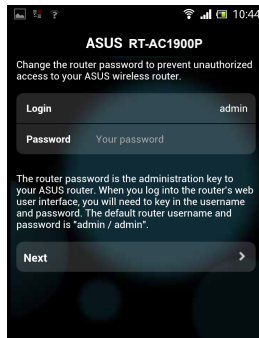

6. 網路設定精靈 (QIS) 可自動偵測 ISP 連線類型：自動取得 IP、PPPoE、PPTP、L2TP 與固定 IP。請從您的 ISP 獲得網路連接類型的相關資訊。若您的網路連線類型為「自動取得 IP」(DHCP)，網路設定精靈 (QIS) 將自動引導您進入下一步。



**注意：**若您的網路連線類型為固定 IP，選擇「Static IP」並點選 **Next**。輸入 IP 位置、子網路遮罩、預設閘道以及 DNS 伺服器資訊。點選 **Next** 繼續。

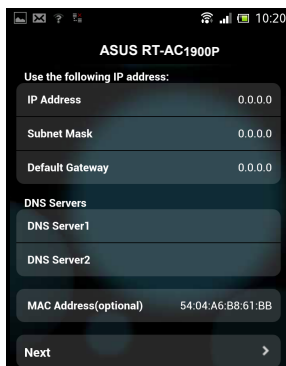

7. 指定網路名稱 (SSID) 與安全金鑰以連接 2.4GHz 與 5GHz 無線網路。完成後點選 **Apply**。

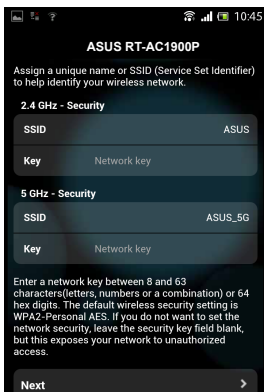

- 畫面將顯示您的網路與無線設定。點選 **Next** 繼續。
- 閱讀無線網路連線教程。完成後點選 **Finish**。



---

**注意：**您可以指定一個多達 32 字元的網路名稱。

---

## 連線到無線網路

無線用戶端（筆電、平板電腦以及智慧型手機等）可以透過兩種方式連線到 RT-AC1900P 的無線網路。

### 手動連線到無線網路

- 開啟行動裝置的 Wi-Fi 功能，並搜尋可用的無線網路。
- 選擇您指定給 RT-AC1900P 網路的 SSID 或網路名稱。
- 輸入密碼，並點選 **Connect**。

### 透過 WPS 連線到無線網路

RT-AC1900P 路由器具備一個 WPS 按鈕，無需輸入密碼您就可以連線無線用戶端至 RT-AC1900P 的網路。

- 按下 RT-AC1900P 後側的 WPS 按鈕。參考「**認識您的 RT-AC1900P 無線路由器**」部份的說明找到 WPS 按鈕的具體位置。
- 在兩秒內按下無線用戶端的 WPS 按鈕，或依據無線用戶端附贈的 WPS 說明操作。透過 WPS 連線時，路由器上的電源指示燈快速閃爍。
- 等待路由器的電源指示燈變為常亮，即表示路由器與無線用戶端成功建立連線。



## 連線到無線網路

您的無線路由器配備一個直覺式 ASUSWRT 網頁圖形使用者介面。ASUSWRT 允許您透過網頁瀏覽器 (如, Internet Explorer、Firefox、Safari 或 Google Chrome) 輕鬆設定各項功能。



注意：點選使用者介面底部的搜尋列可從 ASUS 技術支援網站 <http://support.asus.com> 獲得更多資訊。



注意：

- 關於使用路由器網頁圖形使用者介面的詳細資訊，請參考使用手冊的說明。
- 經常檢查並更新韌體至最新版本以獲得最佳使用體驗。
- 造訪 ASUS Networking 視訊頻道獲得更多教學視訊。



## AiCloud

ASUS AiCloud 應用程式可讓您在有網際網路連線的情況下隨時隨地存取您的資料。您可以透過 iOS 或 Android 裝置上的 AiCloud 行動應用程式存取您的 ASUS WebStorage 帳戶。

依據以下步驟安裝 AiCloud：

1. 確定您的路由器之韌體為最新版本，且支援 AiCloud。
2. 從 Google Play 或 App Store 下載 AiCloud 應用程式。
3. 將 USB 儲存裝置連接到路由器。請參考「認識您的 RT-AC1900P 無線路由器」部份的說明找到 USB 連接埠的具體位置。
4. 將 iOS 或 Android 裝置透過 Wi-Fi 連線到路由器。AiCloud 應用程式將自動引導您進行設定。
5. 現在您就可以存取、串流並分享 USB 儲存裝置中的所有檔案。搜尋 ASUS AiCloud 獲得更多資訊。請觀看教學視訊了解具體設定步驟。



Google Play



App Store

## 常見問題解答 (FAQs)

按照以上步驟執行後，我依然無法獲得無線路由器的網頁圖形使用者介面 (web GUI) 以設定無線路由器。

確定關閉您電腦上的代理設定，並且您的電腦的 IP 位址為自動從 DHCP 伺服器獲得。關於關閉代理設定的詳細資訊，請造訪 ASUS 支援網站 <http://support.asus.com>。關於使用 DHCP 伺服器自動獲得 IP 位址的詳細資訊，請參考您的 Windows® 或 Mac 作業系統說明。

### 無法建立無線網路連線

超出有效範圍：

- 請將路由器放置於較靠近用戶端裝置之處。
- 嘗試進行頻道設定的變更。

認證問題：

- 請使用採用有線連線的電腦來連接路由器。
- 檢查網路安全設定。
- 您可以嘗試按路由器後方的重置 (Reset) 按鈕超過 5 秒鐘後，進行硬體重置的動作。

無法搜尋到路由器：

- 您可以嘗試按路由器後方的重置 (Reset) 按鈕超過 5 秒鐘後，進行硬體重置的動作。
- 檢查無線網路卡上的 SSID 與加密等設定。

無法透過無線網路卡來連線至網際網路。

- 請將路由器更換至用戶端可以連線到的範圍內。
- 檢查您所使用的無線網路卡是否有連線到正確的路由器。
- 檢查所使用的無線網路頻道是符合您的所在地區 / 國家所規範的頻道。

- 檢查加密設定。
- 檢查您所使用的 ADSL 或有線數據機是否有連接至正確的網路埠。
- 重新更換另一條乙太網路線來連接。

當 ADSL 數據機「Link」（連線）的燈號持續閃爍或熄滅，這表示無法存取至網際網路 - 路由器無法與 ADSL 網路建立連線。

- 請確認網路線已有正確連接。
- 請將 ADSL 或有線數據機的電源線拔除，並等待幾分鐘後，再重新接上電源。
- 若 ADSL 數據機燈號持續閃爍或為熄滅（顯示 OFF）的狀態，請與您的網路電信業者聯絡。

忘記網路名稱或金鑰密碼。

- 試著再次透過有線連接來設定無線的加密動作。
- 按下位於路由器後方的重置（Reset）按鈕超過 5 秒鐘後，進行硬體重置的動作。
- 出廠預設值設定：

使用者名稱 / 密碼： admin / admin	IP 位址： 192.168.1.1	SSID： ASUS
------------------------------	-----------------------	---------------

哪裡可以找到更多的無線路由器資訊？

- 驅動程式與公用程式光碟中的使用手冊
- 線上 FAQ 網址：<http://support.asus.com/faq>
- 技術支援網址：<http://support.asus.com>
- 客戶服務熱線：請參閱此快速使用指南的支援熱線

## Contenu de la boîte

- ☑ Routeur sans fil RT-AC1900P
  - ☑ Adaptateur secteur
  - ☑ CD de support (Manuel + utilitaires)
- ☑ Câble réseau
  - ☑ Guide de démarrage rapide



**REMARQUE :** Contactez votre service après-vente ASUS si l'un des éléments est manquant ou endommagé.

## Aperçu rapide de votre RT-AC1900P

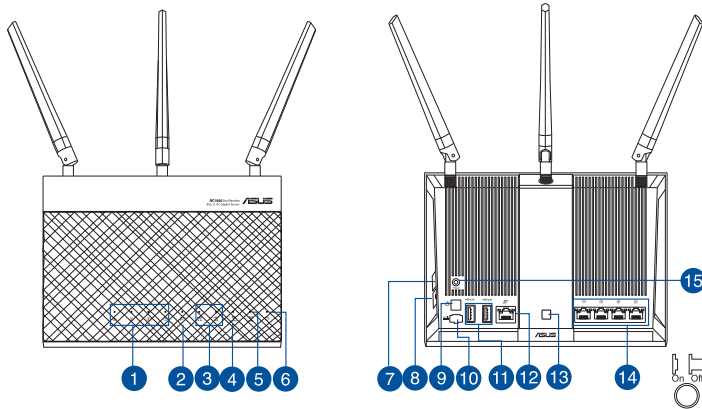

1) réseau local 1~4 LED	6) LED d'alimentation	11) ports USB 3.0/2.0
2) Port réseau étendu (Internet)	7) Bouton WPS	12) Prise réseau étendu
3) LED USB 3.0/2.0	8) Bouton Wi-Fi	13) Bouton d'allumage/d'extinction des voyants lumineux
4) LED 2.4GHz	9) Bouton d'alimentation	14) ports réseau local
5) LED 5GHz	10) Prise d'alimentation (CC)	15) bouton de réinitialisation



---

**REMARQUE:****• Périphérique de stockage USB externe :**

- Le routeur sans fil fonctionne avec la plupart des périphériques de stockage USB d'une taille maximum de 3To et supporte la lecture/écriture pour les formats de fichiers FAT16, FAT32, EXT2, EXT3 et NTFS
  - Pour retirer un lecteur USB en toute sécurité, allez dans l'interface de gestion du routeur (<http://192.168.1.1>), puis cliquez sur l'icône **USB** située sur le coin supérieur droit de l'écran **Network Map** (Carte réseau). Cliquez ensuite sur **Eject USB 3.0 / 2.0** (Éjecter le périphérique USB 3.0 / 2.0).
  - Une mauvaise éjection du périphérique de stockage peut endommager les données contenues sur le disque.
  - Pour consulter la liste des systèmes de fichiers et de partitions de disques supportés par le routeur sans fil, visitez le site **<http://event.asus.com/networks/disksupport>**
  - Pour consulter la liste des imprimantes supportées par le routeur sans fil, visitez le site **<http://event.asus.com/networks/printersupport>**
-

# Installer votre routeur



**IMPORTANT:** avant d'installer votre routeur, assurez-vous que votre connexion Internet est active.

## 1. Positionner le routeur sans fil.

Pour optimiser la transmission du signal sans fil entre votre routeur et les périphériques réseau y étant connecté, veuillez vous assurer des points suivants:

- Placez le routeur sans fil dans un emplacement central pour obtenir une couverture sans fil optimale.
- Maintenez le routeur à distance des obstructions métalliques et des rayons du soleil.
- Maintenez le routeur à distance d'appareils ne fonctionnant qu'avec les standards/fréquences Wi-Fi 802.11g ou 20MHz, les périphériques 2.4GHz et Bluetooth, les téléphones sans fil, les transformateurs électriques, les moteurs à service intense, les lumières fluorescentes, les micro-ondes, les réfrigérateurs et autres équipements industriels pour éviter les interférences ou les pertes de signal sans fil.
- Orientez les trois antennes amovibles comme illustré ci-dessous pour améliorer le qualité de couverture du signal sans fil.
- Mettez toujours le routeur à jour dans la version de firmware la plus récente. Visitez le site Web d'ASUS sur <http://www.asus.com> pour consultez la liste des mises à jour.

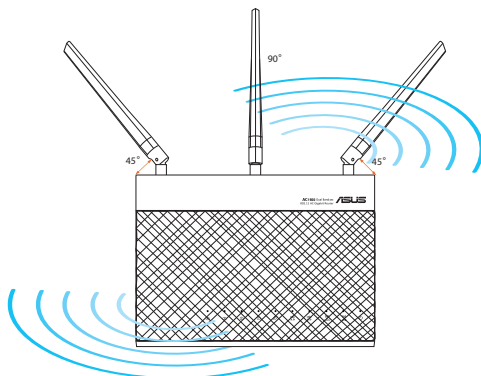

## 2. Préparez votre modem.

- Débranchez l'adaptateur secteur de la prise électrique et du modem câble/ADSL.
- Déconnectez le câble réseau du modem câble/ADSL.
- Redémarrez votre ordinateur (recommandé).

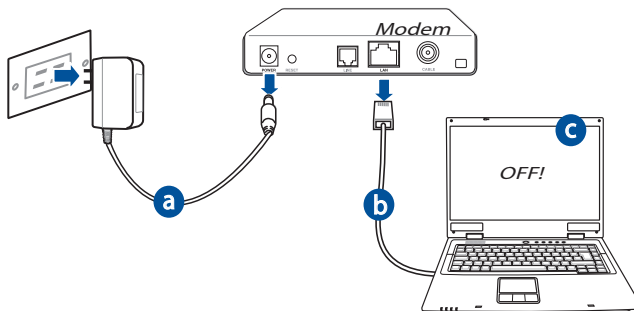

**AVERTISSEMENT !** Avant de débrancher les câbles du modem, assurez-vous que votre modem câble/ADSL est éteint depuis au moins 2 minutes. Si votre modem possède une batterie de secours, retirez-la.

## 3. Set up your wireless environment.

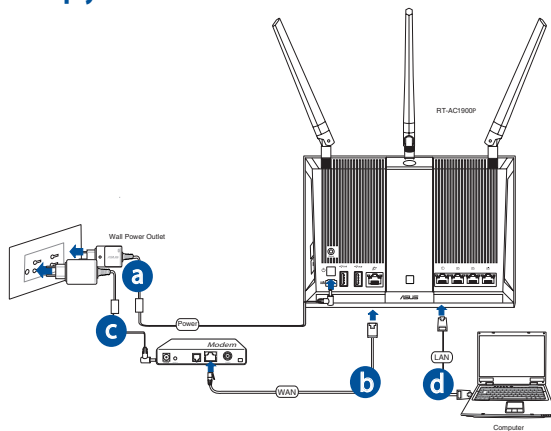



- a. Reliez une extrémité de l'adaptateur secteur au port d'alimentation du routeur et l'autre extrémité à une prise électrique.
- b. À l'aide d'un autre câble réseau, connectez votre modem au port réseau étendu (WAN) du routeur sans fil.
- c. Reliez une extrémité de l'adaptateur secteur au port d'alimentation du modem et l'autre extrémité à une prise électrique.
- d. À l'aide d'un câble réseau, connectez votre ordinateur au port réseau local (LAN) du routeur sans fil.



---

**REMARQUE:** vous pouvez également configurer le RT-AC1900P à partir d'un appareil mobile (smartphone ou tablette). Pour ce faire consultez la section Configurer votre routeur à partir d'un appareil mobile pour plus de détails.

---

#### 4. Désactivez certaines fonctionnalités de votre ordinateur.

- a. Désactivez le serveur proxy si celui-ci est activé.
- b. Configurez les paramètres TCP/IP pour l'obtention automatique d'une adresse IP.
- c. Désactivez la numérotation de votre connexion à distance si celle-ci existe.



---

**REMARQUE :** Pour plus de détails, consultez la section FAQ de ce guide.

---

## Configurer votre routeur à l'aide de l'assistant de configuration Internet

Configurer votre routeur à l'aide de l'assistant de configuration Internet:

1. Appuyez sur le bouton d'alimentation situé à l'arrière du routeur. Vérifiez que les voyants lumineux dédiés à l'alimentation, au réseau local (LAN) et étendu (WAN) sont allumés.
2. Ouvrez votre navigateur Internet (ex : Internet Explorer, Google Chrome, Safari ou Firefox)

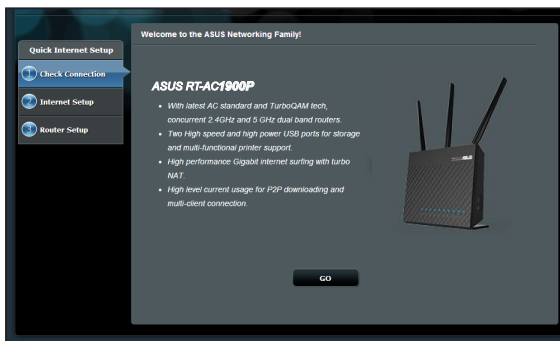

**REMARQUE:** Si l'assistant de configuration Internet ne s'exécute pas automatiquement, entrez <http://192.168.1.1> ou <http://router.asus.com> dans la barre d'adresse de votre navigateur Web, puis actualisez la page.

3. Assignez un nom de connexion et un mot de passe au routeur, puis cliquez sur **Next (Suivant)**. Ces identifiants vous seront demandés à chaque tentative de connexion à l'interface de gestion du routeur.

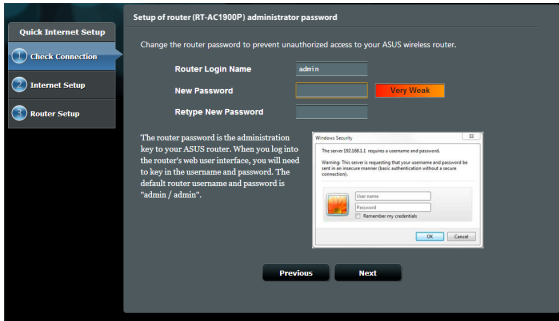

Nom de connexion :

Mot de passe:

4. Le routeur sans fil détecte automatiquement si la connexion Internet fournie par votre FAI utilise une IP dynamique ou statique ou le protocole PPPoE, PPTP ou L2TP. Entrez les informations nécessaires en fonction de votre type de connexion. **REMARQUE** : si vous utilisez une connexion à adresse IP dynamique (DHCP), l'assistant de configuration Internet vous redirigera vers l'étape suivante.



**REMARQUE:** Si vous utilisez une connexion à adresse IP fixe, sélectionnez **Static IP (Adresse IP fixe)**, puis cliquez sur **Next (Suivant)**. Entrez ensuite les adresses IP, de masque sous-réseau, de passerelle et de serveur DNS fournies par votre FAI. Cliquez sur **Next (Suivant)** pour continuer.

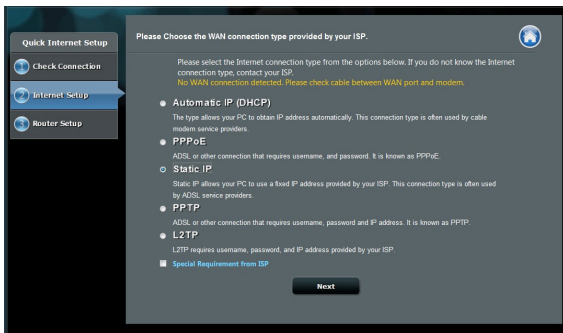

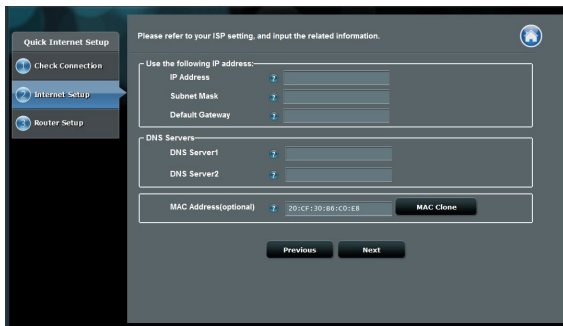

- Assignez un nom (SSID) au réseau sans fil ainsi qu'une clé de sécurité pour votre connexion sans fil 2.4GHz et 5GHz. Cliquez sur **Apply** (Appliquer) une fois terminé.

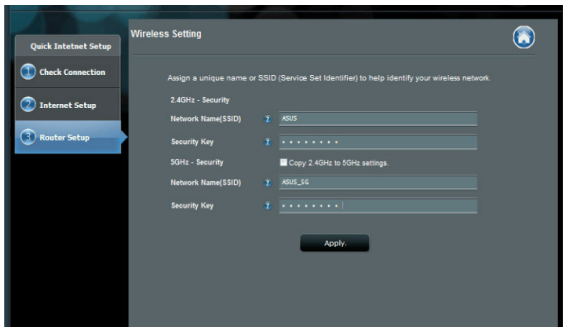

- Les paramètres Internet et de connexion sans fil apparaissent. Cliquez sur **Next** (Suivant) pour continuer.
- Lisez le tutorial de connexion réseau. Une fois terminé, cliquez sur **Finish** (Terminé).



### REMARQUE:

- Vous pouvez assigner un nom réseau composé d'un maximum de 32 caractères.
- Si nécessaire, visionnez la vidéo d'aide.



## Configurer votre routeur à partir d'un appareil mobile (optionnel)

Vous pouvez utiliser un appareil mobile tel qu'un smartphone ou une tablette pour configurer la connexion Internet de votre RT-AC1900P. L'assistant de configuration Internet basculera automatiquement en version mobile si vous utilisez un smartphone ou une tablette pour l'exécuter.

Pour configurer la connexion Internet du routeur par le biais d'un appareil mobile:

1. Allumez votre RT-AC1900P.
2. Activez le Wi-Fi sur votre appareil mobile.
3. Connectez-vous au SSID nommé ASUS, qui est le nom de réseau sans fil par défaut du RT-AC1900P. Patientez le temps que la connexion soit établie.
4. Ouvrez le navigateur Internet de votre appareil mobile.



**REMARQUE:** si l'assistant de configuration Internet ne s'exécute pas automatiquement, entrez <http://192.168.1.1> or <http://router.asus.com> dans la barre d'adresse et actualisez la page. Vous pouvez aussi scanner le code QR ci-contre pour accéder à l'interface de gestion du RT-AC1900P.

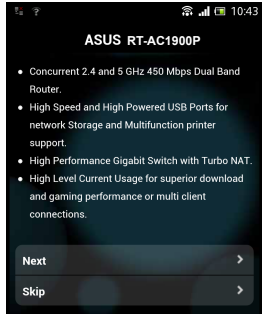

5. Assignez un nom de connexion et un mot de passe au routeur, puis cliquez sur Next (Suivant). Ces identifiants vous seront demandés à chaque tentative de connexion à l'interface de gestion du routeur.

Nom de connexion:

\_\_\_\_\_

Mot de passe:

\_\_\_\_\_



6. Le routeur sans fil détecte automatiquement si la connexion Internet fournie par votre FAI utilise une IP dynamique ou statique ou le protocole PPPoE, PPTP ou L2TP. Entrez les informations nécessaires en fonction de votre type de connexion. Si vous utilisez une connexion à adresse IP dynamique (DHCP), l'assistant de configuration Internet vous redirigera vers l'étape suivante.



**REMARQUE:** si vous utilisez une connexion à adresse IP fixe, sélectionnez **Static IP (Adresse IP fixe)**, puis cliquez sur **Next (Suivant)**. Entrez ensuite les adresses IP, de masque sous-réseau, de passerelle et de serveur DNS fournies par votre FAI. Cliquez sur **Next (Suivant)** pour continuer.

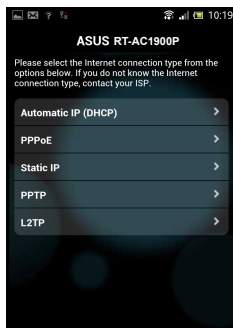

7. Assignez un nom (SSID) au réseau sans fil ainsi qu'une clé de sécurité pour votre connexion sans fil 2.4GHz et 5GHz. Cliquez sur **Apply** (Appliquer) une fois terminé.

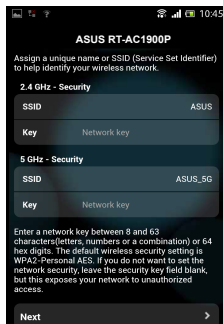

8. Les paramètres Internet et de connexion sans fil apparaissent. Cliquez sur **Next** (Suivant) pour continuer.
9. Lisez le tutoriel de connexion réseau. Une fois terminé, cliquez sur **Finish** (Terminé).



---

**REMARQUE :** Vous pouvez assigner un nom réseau composé d'un maximum de 32 caractères.

---

## Connexion à un réseau sans fil

Il existe deux méthodes de connexion de clients sans fil (ordinateurs portables, tablettes, smartphones, etc.) au réseau sans fil du RT-AC1900P.

### Connexion manuelle à un réseau sans fil

Pour vous connecter manuellement à un réseau sans fil :

1. Activez la fonctionnalité Wi-Fi de votre client sans fil.
2. Sélectionnez le SSID attribué au RT-AC1900P.
3. Entrez le mot de passe et appuyez sur **Connect (Connecter)**.

### Connexion à un réseau sans fil via WPS.

Le RT-AC1900P dispose d'un bouton WPS (Wi-Fi Protected Setup) vous permettant de connecter un client au réseau sans fil géré par le routeur sans avoir à entrer d mot de passe de connexion.

Pour utiliser la fonctionnalité WPS:

1. Appuyez sur le bouton WPS situé à l'arrière du RT-AC1900P. Consultez la section **Aperçu rapide de votre RT-AC1900P** pour localiser l'emplacement de ce bouton.
2. Appuyez sur le bouton WPS du client sans fil dans un délai de 2 minutes ou suivez les instructions fournies avec le client sans fil. Lors d'une tentative de connexion WPS, le voyant d'alimentation du routeur clignote rapidement.
3. Lorsque le voyant d'alimentation s'arrête de clignoter, cela signifie que la connexion a été établie entre le routeur et le client sans fil.

## Gestion du routeur via l'interface ASUSWRT

Votre routeur sans fil dispose de l'interface intuitive ASUSWRT. Cette interface de gestion du routeur vous permet de configurer en toute simplicité les fonctionnalités du routeur par le biais d'un navigateur Internet tel que Internet Explorer, Firefox, Safari ou Google Chrome.



**REMARQUE:** utilisez la barre de recherche localisée en bas de l'écran pour obtenir plus d'informations sur le site d'assistance technique d'ASUS sur <http://support.asus.com>.



### IMPORTANT:

- Pour plus de détails sur l'utilisation de l'interface de gestion du routeur, consultez le manuel de l'utilisateur.
- Vérifiez régulièrement que votre routeur dispose de la dernière version de microprogramme disponible.
- Rendez-vous sur la page vidéo d'ASUS pour visionner de nombreuses vidéos didacticielles.





## AiCloud

ASUS AiCloud est une plate-forme vous permettant d'accéder à vos données à tout moment et où que vous soyez tant qu'une connexion Internet est disponible. Vous pouvez aussi utiliser l'application AiCloud à partir de votre appareil iOS ou Android pour accéder à votre compte ASUSWebstorage.

Pour installer AiCloud :

1. Assurez-vous que votre routeur dispose de la dernière version de microprogramme disponible.
2. Téléchargez l'application AiCloud Google Play ou sur l'App Store.
3. Connectez un périphérique de stockage à votre routeur. Consultez la section **Aperçu rapide de votre RT-AC1900P** pour localiser l'emplacement des ports USB.
4. Connectez votre appareil iOS ou Android au routeur via Wi-Fi. L'application AiCloud vous guidera automatiquement au travers des divers étapes de configuration.
5. Une fois terminé, vous pouvez accéder, diffuser et partager les fichiers contenus sur votre dispositif de stockage USB. Vous pouvez également accéder aux vidéos dédiées à AiCloud à partir des codes QR ci-dessous.



Google Play



App Store

## Foire aux questions (FAQ)

### **Même après avoir suivi les instructions de ce guide, je ne parviens toujours pas à accéder au Gestionnaire de configuration du routeur.**

Assurez-vous que votre proxy est désactivé et que l'adresse IP de votre ordinateur est gérée par le serveur DHCP. Pour plus de détails sur la désactivation d'un proxy, rendez-vous sur le site <http://support.asus.com>. Pour plus d'informations sur l'utilisation du serveur DHCP, consultez l'aide de votre ordinateur Windows® ou MAC.

### **Le client ne peut pas établir de connexion sans fil avec le routeur.**

#### **Hors de portée :**

- Rapprochez le client du routeur.
- Essayez d'autres paramètres de canaux.

#### **Authentification :**

- Utilisez une connexion filaire pour vous connecter au routeur.
- Vérifiez les paramètres de sécurité sans fil.
- Appuyez sur le bouton Reset situé sur l'arrière du routeur pendant plus de 5 secondes

#### **Routeur introuvable :**

- Appuyez sur le bouton de réinitialisation situé sur l'arrière du routeur pendant plus de 5 secondes.
- Vérifiez les paramètres SSID et de chiffrement de l'adaptateur sans fil.

### **Impossible d'accéder à Internet via un adaptateur sans fil local.**

- Rapprochez le client du routeur.
- Vérifiez que l'adaptateur sans fil est connecté au bon routeur sans fil.
- Vérifiez que le canal sans fil que vous utilisez appartient aux canaux disponibles dans votre pays/région.

- Vérifiez les paramètres de chiffrement.
- Vérifiez la connexion ADSL ou au Câble.
- Utilisez un autre câble Ethernet.

**Si la LED "LINK" du modem ADSL clignote ou reste éteinte en permanence, cela signifie alors qu'il n'est pas possible d'accéder à Internet - le routeur n'est pas en mesure d'établir une connexion au réseau ADSL.**

- Vérifiez que les câbles sont correctement connectés.
- Débranchez le câble d'alimentation du modem. Patientez quelques secondes, puis reconnectez le câble.
- Si la LED ADSL clignote ou reste éteinte en permanence, contactez votre fournisseur d'accès ADSL.

### Nom de réseau et/ou clé de cryptage oubliés.

- Essayez de configurer une connexion filaire et configurez à nouveau les paramètres de chiffrement sans fil.
- Appuyez sur le bouton de réinitialisation situé sur l'arrière du routeur pendant plus de 5 secondes.
- Paramètres par défaut :

<b>Nom d'utilisateur / Mot de passe :</b> admin / admin	<b>Adresse IP :</b> 192.168.1.1	<b>SSID :</b> ASUS
--	------------------------------------	--------------------

### Où puis-je obtenir plus d'informations sur le routeur sans fil ?

- Manuel d'utilisation contenu dans le CD de support
- FAQ en ligne : <http://support.asus.com/faq>
- Site de support technique: <http://support.asus.com>
- Hotline : consultez la liste des centres d'appels ASUS en fin de guide.

## Package contents

- RT-AC1900P
- Cabo de rede (RJ-45)
- CD de suporte (contendo o manual)
- Transformador
- Guia de consulta rápida



**NOTA:** Caso algum item esteja danificado ou em falta, contacte o seu revendedor.

## Visão geral do seu RT-AC1900P

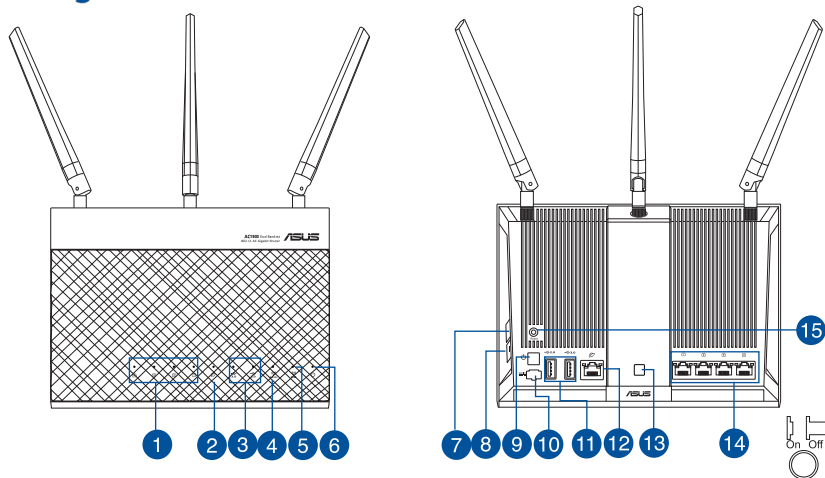

1) LED 1 a 4 da LAN	6) LED de Alimentação	11) Portas USB 3.0/2.0
2) LED WAN (Internet)	7) Botão WPS	12) Portas WAN
3) LED USB 2.0/3.0	8) Botão Ligar/Desligar Wi-Fi	13) Botão Ligar/Desligar LED
4) LED 2.4GHz	9) Vypinaè	14) Portas LAN
5) LED 5GHz	10) Porta de alimentação (Entrada DC)	15) Vypinaè



---

## NOTAS:

- **Disco Rígido USB Externo/Disco Flash:**
    - O router sem fios funciona com a maioria dos Discos Rígidos USB/Discos Flash com até 2TB de capacidade e suporta o acesso de leitura-escrita nos sistemas FAT16, FAT32, EXT2, EXT3 e NTFS.
    - TPara remover em segurança o disco USB, aceda à interface Web (<http://192.168.1.1>) e no canto superior direito da página **Network Map (Mapa de rede)**, Clique no ícone USB e clique em **Eject USB 3.0 / USB 2.0 (Ejectar USB 3.0 / USB 2.0)**.
    - A remoção incorrecta do disco USB poderá danificar os dados.
    - Para consultar a lista de sistemas de ficheiros e de partições de disco rígido que o router sem fios suporta, visite [\*\*http://event.asus.com/networks/disksupport\*\*](http://event.asus.com/networks/disksupport)
  - Para consultar a lista de impressoras que o router suporta, visite [\*\*http://event.asus.com/networks/printersupport\*\*](http://event.asus.com/networks/printersupport)
-

## Instalar o router



**IMPORTANTE:** Antes de instalar o router, certifique-se de que a ligação à Internet está disponível.

### 1. Colocação do router.

Para garantir a melhor qualidade de transmissão entre o router sem fios e os dispositivos de rede a ele ligados:

- Coloque o router sem fios numa área central para obter a maior cobertura possível sem fios para os seus dispositivos de rede.
- Mantenha o dispositivo afastado de obstruções de metal e de luz solar directa.
- Mantenha o dispositivo afastado de dispositivos Wi-Fi que utilizam apenas a norma 802.11g ou 20MHz, periféricos de computador que utilizam a banda 2,4GHz, dispositivos Bluetooth, telefones sem fios, transformadores, motores de alta resistência, lâmpadas fluorescentes, fornos microondas, frigoríficos e outros equipamentos industriais para evitar interferências ou perdas de sinal.
- Para garantir um sinal sem fios ideal, oriente as três antenas amovíveis tal como ilustrado nas imagens abaixo.
- Actualize sempre para o firmware mais recente. Visite o Web site da ASUS em <http://www.asus.com> para obter as actualizações de firmware mais recentes.

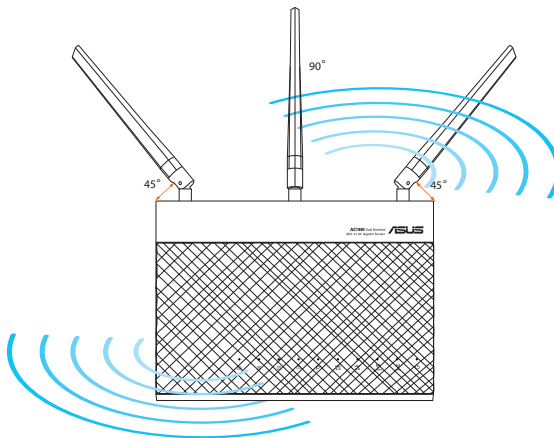

## 2. Preparar o modem.

- a: Desligue o transformador AC da tomada eléctrica e desligue-o do modem por cabo/ADSL.
- b: Desligue o cabo de rede do modem por cabo/ADSL.
- c: Reinicie o computador (recomendado).

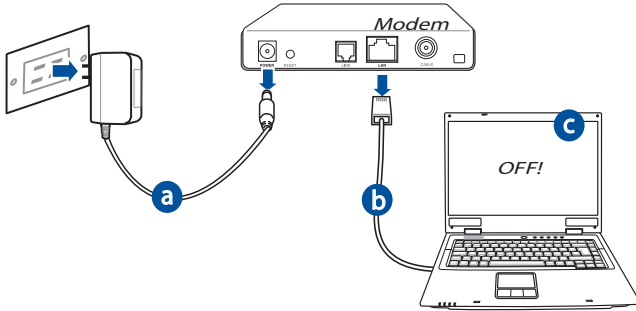

**AVISO!** Antes de desligar os fios/cabos, certifique-se de que o modem por cabo/ADSL se encontra desligado há pelo menos dois minutos. Se o modem possuir uma bateria de reserva, remova-a também.

## 3. Configure o ambiente da sua rede sem fios.

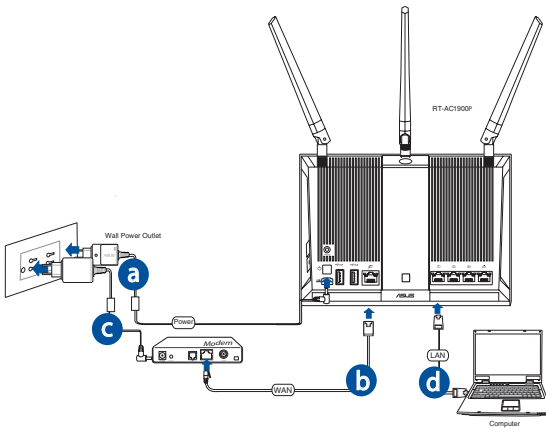

- a: Ligue o transformador AC do router sem fios à porta de entrada DC e a uma tomada eléctrica.
- c: Utilizando outro cabo de rede, ligue o seu modem à porta WAN do router sem fios.
- d: Ligue o transformador AC do modem à porta de entrada DC e a uma tomada eléctrica.
- b: Utilizando o cabo de rede, ligue o seu computador à porta LAN do router sem fios.



---

**NOTA:** Pode também configurar o RT-AC1900P através de um dispositivo móvel, como por exemplo um smartphone ou tablet PC. Para tal, consulte a secção **Configurar o router através de um dispositivo móvel** para obter mais detalhes.

---

#### 4. Desactive algumas configurações no seu computador.

- A. Desactive o servidor proxy, caso esteja activado.
- B. Configurar as definições de TCP/IP para obter automaticamente um endereço IP.
- C. Desactive a ligação de acesso telefónico, caso esteja activada.



---

**NOTA:** Para obter mais detalhes acerca de como desactivar as configurações do seu computador, consulte as **Perguntas Frequentes (FAQ)**.

---



## Configurar o router através do Assistente de Configuração Rápida de Internet

Para configurar o seu router através da função QIS (Configuração Rápida de Internet):

1. Prima o botão de alimentação na traseira do router. Certifique-se de que os LED de Alimentação, LAN e WAN estão acesos
2. Execute o seu navegador Web, como por exemplo o Internet Explorer, o Firefox ,Google Chrome ou o Safari.



---

**NOTA:** Se a função QIS não iniciar automaticamente, introduza <http://192.168.1.1> ou <http://router.asus.com> na barra de endereços e volte a actualizar o browser

---

3. Especifique o seu nome de utilizador e palavra-passe para o router e clique em **Next (Seguinte)**. Irá precisar deste nome de utilizador e palavra-passe para iniciar sessão no RT-AC1900P para visualizar ou alterar as definições do router. Tome nota do seu nome de utilizador e palavra-passe do router para utilização futura.

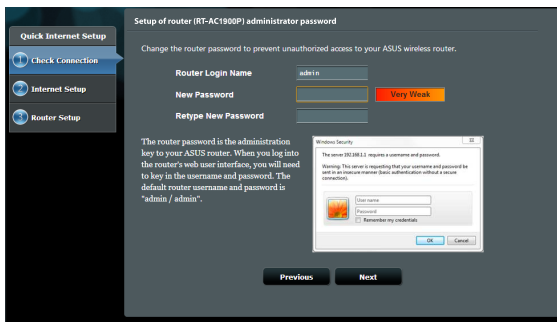

Nome de utilizador:

Palavra-passe:

4. A função de Configuração Rápida de Internet (QIS) do router sem fios detecta automaticamente se o tipo de ligação do seu ISP é de **Dynamic IP (IP Dinâmico), PPPoE, PPTP, L2TP, e Static IP (IP Estático)**. Contacte o seu Fornecedor de Serviços de Internet (ISP), para obter as informações necessárias relativas ao seu tipo de ligação à Internet. Se a sua ligação for do tipo IP Dinâmico (DHCP), o assistente QIS irá direccioná-lo directamente para o passo seguinte



**NOTA:** Se a sua ligação for do tipo IP Estático, escolha **Static IP (IP Estático)** e clique em **Next (Seguinte)**. Introduza o endereço IP, máscara de sub-rede, gateway predefinido e informações do servidor DNS fornecidos pelo seu ISP. Clique em **Next (Seguinte)** para continuar.

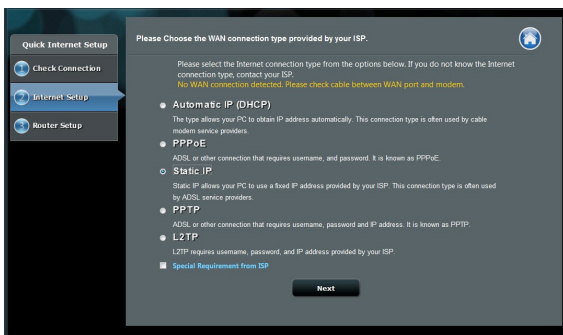

Quick Internet Setup

Check Connection

Internet Setup

Router Setup

Please refer to your ISP setting, and input the related information.

Use the following IP address:

IP Address

Subnet Mask

Default Gateway

DNS Servers

DNS Server1

DNS Server2

MAC Address(optional) 20:CF:30:86:C0:EA

5. Atribua o nome de rede (SSID) e a chave de segurança para a sua ligação sem fio a 2,4GHz e 5GHz. Clique em **Apply (Aplicar)** quando terminar

Quick Internet Setup

Check Connection

Internet Setup

Router Setup

Wireless Setting

Assign a unique name or SSID (Service Set Identifier) to help identify your wireless network.

2.4GHz - Security

Network Name(SSID) 2.4GHz

Security Key 2.4GHz

5GHz - Security  Copy 2.4GHz to 5GHz settings

Network Name(SSID) 5GHz

Security Key 5GHz

6. Serão exibidas as suas definições de Internet e da ligação sem fios. Clique em **Next (Seguinte)** para continuar.
7. Leia o tutorial de ligação da rede sem fios. Clique em **Finish (Concluir)** quando terminar.



## NOTAS:

- Pode atribuir um nome de rede com um máximo de 32 caracteres.
- Assista ao vídeo do tutorial de configuração caso seja necessário.



## Configurar o router através de um dispositivo móvel (opcional)

Pode também utilizar o seu dispositivo móvel, como por exemplo um smartphone ou tablet PC para configurar o RT-AC1900P através do assistente QIS. O assistente QIS irá mudar automaticamente para a versão móvel se utilizar um smartphone ou tablet PC para o executar.

Para configurar o seu router através de um dispositivo móvel:

1. Ligue o RT-AC1900P.
2. Ative a função Wi-Fi do seu dispositivo móvel.
3. Procure o SSID **ASUS**, que é o SSID predefinido da rede sem fios do seu RT-AC1900P. Clique neste SSID para ligar e aguarde que o estado exiba Wi-Fi ligado.
4. Execute o Web browser do seu dispositivo móvel.

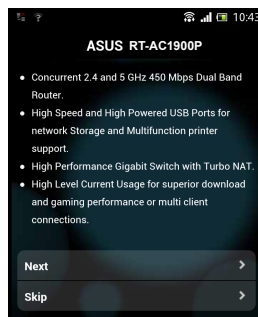

**NOTA:** Se a função QIS não iniciar automaticamente, introduza <http://192.168.1.1> ou <http://router.asus.com> na barra de endereços e volte a actualizar o browser. Pode também utilizar o seu dispositivo móvel para efectuar aqui a leitura do código QR para aceder à interface Web do RT-AC1900P.



5. Especifique o seu nome de utilizador e palavra-passe para o router e clique em Next (Seguinte). Irá precisar deste nome de utilizador e palavra-passe para iniciar sessão na interface Web do RT-AC1900P para visualizar ou alterar as definições do router. Certifique-se de que toma nota do seu nome de utilizador e palavra-passe do router para utilização futura.

Nome de utilizador:

\_\_\_\_\_

Palavra-passe:

\_\_\_\_\_



6. A funcionalidade QIS detecta automaticamente se o tipo de ligação do seu ISP é de **Dynamic IP (IP Dinâmico)**, PPPoE, PPTP, L2TP, e **Static IP (IP Estático)**. Introduza as informações necessárias fornecidas pelo seu Fornecedor de Serviços de **Internet (ISP)**. Se a sua ligação for do tipo **IP Dinâmico (DHCP)**, o assistente QIS irá direccioná-lo directamente para o passo seguinte.



**NOTA:** Se a sua ligação for do tipo IP Estático, escolha Static IP (IP Estático) e clique em Next (Seguinte). Introduza o endereço IP, máscara de sub-rede, gateway predefinido e informações do servidor DNS fornecidos pelo seu ISP. Clique em Next (Seguinte) para continuar.

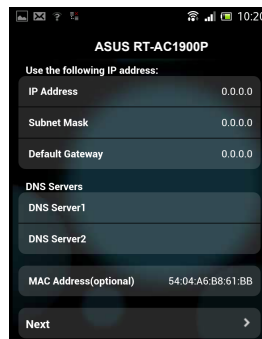

7. Atribua o nome de rede (SSID) e a chave de segurança para a sua ligação sem fio a 2,4GHz e 5GHz. Clique em **Apply (Aplicar)** quando terminar

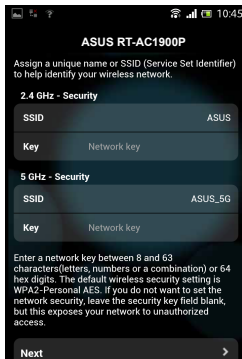

- d: Serão exibidas as suas definições de Internet e da ligação sem fios. Clique em **Next (Seguinte)** para continuar.
- e: Leia o tutorial de ligação da rede sem fios. Clique em **Finish (Concluir)** quando terminar.



---

**NOTA:** Pode atribuir um nome de rede com um máximo de 32 caracteres.

---

## Ligar à rede sem fios

Os seus clientes sem fios (computador portátil, tablet PC, smartphone, etc.) podem ligar-se à rede sem fios do RT-AC1900P de duas formas.

### Ligar à rede sem fios manualmente

Para ligar à rede sem fios manualmente:

1. Ative a função Wi-Fi no seu cliente sem fios para procurar redes sem fios disponíveis.
2. Seleccione o SSID ou nome de rede que atribuiu à rede do seu RT-AC1900P.
3. Introduza a palavra-passe e clique em **Connect (Ligar)**.

### Ligar à rede sem fios através de WPS

ORT-AC1900P possui um botão WPS (Configuração Wi-Fi Protegida) que permite ligar o seu cliente sem fios à rede do RT-AC1900P sem introduzir uma palavra-passe.

Para ligar à rede sem fios através de WPS:

1. Pressione o botão WPS na parte traseira do RT-AC1900P. Consulte a secção **Visão geral do seu RT-AC1900P** para obter a localização do botão WPS..
2. Prima o botão WPS do seu cliente sem fios no espaço de dois minutos ou siga as instruções WPS incluídas no seu cliente sem fios. Ao efectuar a ligação através de WPS, o LED de Alimentação do seu router pisca rapidamente.
3. Aguarde até que o LED de Alimentação do router apresente uma luz fixa, indicando que a ligação entre o router e o cliente sem fios foi estabelecida com êxito.

## Gerir o router através da interface Web ASUSWRT

O seu router sem fios inclui a intuitiva interface gráfica de utilizador na Web ASUSWRT. A interface ASUSWRT permite-lhe configurar facilmente as suas diversas funcionalidades através de um Web browser, tal como o Internet Explorer, Firefox, Safari ou Google Chrome.



**NOTA:** Utilize a barra de pesquisa na parte inferior da interface para obter mais informações acerca do site de apoio técnico da ASUS <http://support.asus.com>



### IMPORTANTE:

- Consulte o manual do utilizador Para obter mais detalhes acerca da interface Web do seu router.
- Verifique e actualize sempre o firmware para a versão mais recente para obter uma melhor experiência.
- Visite o canal de vídeo ASUS Networking para assistir a tutoriais em vídeo sobre as funções principais.



## AiCloud

A aplicação ASUS AiCloud oferece-lhe acesso aos seus dados em qualquer lugar e sempre que possuir uma ligação Internet. Permite-lhe também aceder à sua conta ASUS WebStorage através da aplicação móvel AiCloud no seu dispositivo iOS ou Android, ou através de um Web browser.

Para instalar a aplicação AiCloud:

1. Certifique-se de que a versão de firmware do seu router é a mais recente e que suporta a aplicação AiCloud.
2. Transfira a aplicação AiCloud a partir do Google Play ou da App Store.
3. Ligue o dispositivo de armazenamento USB ao seu router. Consulte a secção **Visão geral do seu RT-AC1900P** para obter a localização das portas USB.
4. Ligue os seus dispositivos iOS ou Android ao router através de Wi-Fi. A aplicação AiCloud irá guiá-lo automaticamente através do processo de configuração.
5. Pode agora aceder, transmitir e partilhar todos os ficheiros na sua unidade de armazenamento USB. Procure por ASUS AiCloud para obter mais informações. Assista aos tutoriais em vídeo para obter instruções passo-a-passo.



Google Play



App Store



## Perguntas Frequentes (FAQ)

### Depois de seguir todos os passos, ainda não consigo aceder à interface gráfica Web do router (GUI Web) para configurar as definições do router sem fios.

Certifique-se de que as definições de proxy do seu PC estão desactivadas e de que o endereço IP do PC é obtido automaticamente através do servidor DHCP. Para mais detalhes sobre a desactivação das definições de proxy, visite o site de Suporte da ASUS em <http://support.asus.com>. Para mais informações sobre a utilização do servidor DHCP para obter automaticamente endereços IP, consulte a função de ajuda do seu sistema operativo Windows® ou Mac.

### O cliente não consegue estabelecer uma ligação sem fios com o router.

#### Fora de alcance:

- Coloque o router mais próximo do cliente sem fios.
- Experimente alterar as definições do canal.

#### Autenticação:

- Utilize uma ligação com fios para ligar ao router.
- Verifique as definições de segurança da ligação sem fios.
- Prima o botão Reset (Repor) no painel traseiro durante mais de cinco segundos

### Não é possível localizar o router:

- Prima o botão Reset (Repor) no painel traseiro durante mais de cinco segundos.
- Verifique as definições na placa sem fios como, por exemplo, as definições SSID e de encriptação.**Cannot find the router:**

### Não é possível aceder à Internet através da LAN sem fios

- Coloque o router mais próximo do cliente sem fios.
- Verifique se a placa sem fios está ligada ao router sem fios correcto.
- Verifique se o canal da função sem fios em utilização está em conformi-

dade com os canais disponíveis no seu país/na sua área.

- Verifique as definições de encriptação.
- Verifique se a ligação por ADSL ou por cabo está correcta.
- Volte a tentar utilizando um outro cabo Ethernet.

**Se o LED "LINK" do modem ADSL estiver intermitente ou desligado, é sinal de que não é possível aceder à Internet – o router não consegue estabelecer ligação através da rede ADSL.**

- Certifique-se de que todos os cabos estão devidamente ligados .
- Desligue o cabo de alimentação do modem ADSL ou do modem por cabo. Aguarde alguns minutos e volte a ligar o cabo.
- Se o LED do modem ADSL continuar a piscar ou permanecer desligado, contacte o seu fornecedor de serviços.

**O nome da rede ou as chaves de segurança foram esquecidas.**

- Tente configurar a ligação com fios e configure novamente as definições de encriptação.
- Pressione o botão Repor durante mais de cinco segundos para repor ou restaurar as predefinições do sistema.
- Predefinições:

<b>Nome de utilizador / Palavra-passe:</b> admin / admin	<b>Endereço IP:</b> 192.168.1.1	<b>SSID:</b> ASUS
---	------------------------------------	-------------------

**Where can I find more information about the wireless router?**

**Onde posso encontrar mais informações acerca do router sem fios?**

- Manual do utilizador incluído no CD de suporte
- Site de Perguntas Frequentes Online: <http://support.asus.com/faq>
- Site de Apoio Técnico: <http://support-org.asus.com/>
- Linha de Apoio ao Cliente: Consulte a Linha de Apoio ao Cliente no Guia suplementar.

## Contenido del paquete

- ☑ RT-AC1900P
- ☑ Cable de red
- ☑ 9CD de soporte (Manual/software de utilidad)
- ☑ AC adapter
- ☑ Guía de inicio rápido



**NOTA:** Si alguno de los artículos falta o se encuentra dañado, póngase en contacto con su distribuidor.

## Un vistazo rápido a su RT-AC1900P

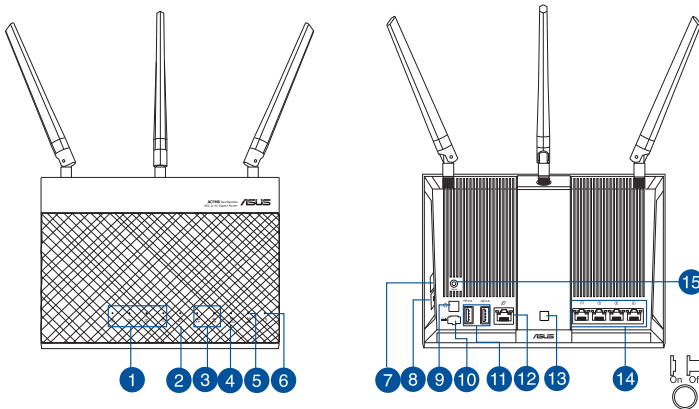

1) LED LAN 1~4	6) LED de alimentación	11) USB 3.0/2.0 Puertos
2) WAN LED (Internet)	7) Botón WPS	12) WAN Puertos
3) USB 3.0/2.0 LED	8) Botón Activar/Desactivar Wi-Fi	13) Botón Activar/Desactivar LED
4) LED de 2.4 GHz	9) Vypínaè	14) LAN Puertos
5) LED de 5GHz	10) Puerto de alimentación (DC-IN)	15) Botón Restablecer



---

**NOTAS:****• Disco flash/Disco duro externo USB:**

- El router inalámbrico funciona con la mayoría de discos flash y discos duros USB de hasta 2 TB y admite acceso de lectura y escritura para los formatos FAT16, FAT32, EXT2, EXT3 y NTFS.
  - Para quitar de forma segura el disco USB, inicie la interfaz gráfica del usuario Web (<http://192.168.1.1>) y, a continuación, en la página **Network Map (Mapa de la red)**, haga clic en el icono USB y, a continuación, en **Eject USB 3.0 / USB 2.0 (Expulsar USB 3.0 / USB 2.0)**.
  - Si quita el disco USB de forma incorrecta, los datos pueden resultar dañados.
  - Para conocer la lista del sistema de archivos y las particiones de disco duro que admite el contador inalámbrico, visite la dirección <http://event.asus.com/networks/disksupport>.
  - Para conocer la lista de impresoras que admite el router inalámbrico, visite la dirección <http://event.asus.com/2009/networks/printersupport>
-

# Instalar el enrutador



**IMPORTANTE:** Antes de instalar el router, asegúrese de que hay disponible una conexión a Internet.

## 1. Ubicar el router inalámbrico

Para conseguir la mejor transmisión de señal inalámbrica entre el router inalámbrico y los dispositivos de red conectados a él, asegúrese de:

- Colocar el router inalámbrico en un área centralizada para conseguir la máxima cobertura inalámbrica para los dispositivos de red.
- Mantenga el dispositivo alejado de obstáculos metálicos y de la luz solar directa.
- Mantenga el producto alejado de dispositivos WiFi de 802.11g o 20 MHz, equipos periféricos de 2,4 GHz, dispositivos Bluetooth, teléfonos inalámbricos, transformadores, motores de alto rendimiento, luces fluorescentes, hornos microondas, frigoríficos y otros equipos industriales para evitar interferencias o pérdidas de señal.
- Oriente las tres antenas desmontables tal y como muestra la siguiente ilustración para maximizar la cobertura de la señal inalámbrica.
- Actualícese siempre a la versión de firmware más reciente. Visite el sitio Web de ASUS en <http://www.asus.com> para obtener las actualizaciones de firmware más recientes.

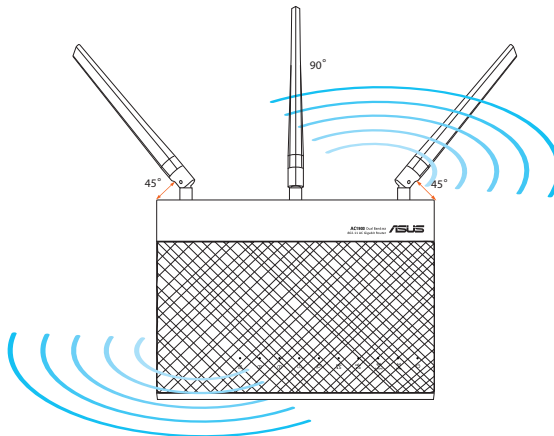

## 2. Prepare el módem.

- Desenchufe el adaptador de CA de la red eléctrica y desconéctelo del módem por cable/ADSL.
- Desconecte el cable de red del módem por cable/ADSL.
- Reinicie su PC (recomendado).

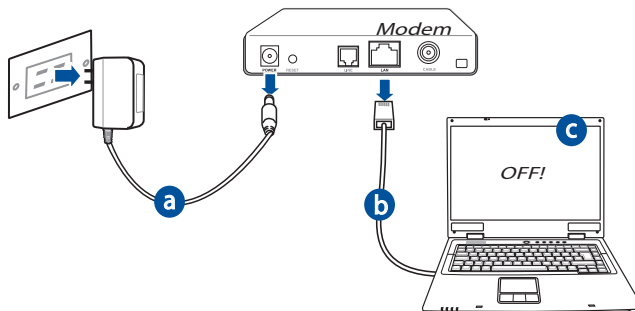

**ADVERTENCIA!** Antes de desconectar todos los cables, asegúrese de que el módem por cable/ADSL haya permanecido apagado durante, al menos, dos minutos. Si el módem tiene una batería de reserva, quítela también.

## 3. Configure la red inalámbrica.

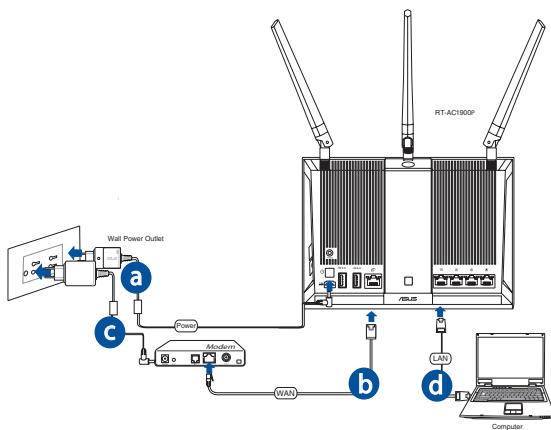

- a. Conecte el adaptador de CA del router inalámbrico al puerto DC-IN y enchúfelo a la red eléctrica.
- b. Use otro cable de red para conectar el módem al puerto WAN del router inalámbrico.
- c. Conecte el adaptador de CA del módem al puerto DC-IN y enchúfelo a la red eléctrica.
- d. Use el cable de red para conectar el equipo a un puerto LAN del router inalámbrico.



---

**NOTA:** También puede configurar su RT-AC1900P utilizando un dispositivo móvil, como por ejemplo un teléfono inteligente o tableta. Para obtener más detalles sobre ello, vaya a la sección **Configurar el enrutador utilizando un dispositivo móvil**.

---

#### 4. Deshabilitar alguna configuración en su PC.

- a. Deshabilite el servidor proxy si se encuentra habilitado.
- b. Establezca la configuración TCP/IP del equipo para que reciba una dirección IP automáticamente.
- c. Deshabilite todas las conexiones de acceso telefónico, si hay alguna habilitada.



---

**NOTA:** Para obtener más detalles sobre cómo deshabilitar la configuración del equipo, consulte la sección de **preguntas más frecuentes (P+F)**.

---

## Configurar el enrutador utilizando el Asistente para configuración rápida para Internet

Para configurar el enrutador utilizando la configuración rápida para Internet (QIS, Quick Internet Setup):

1. Presione el botón de alimentación situado en la parte posterior del enrutador. Asegúrese de que los LED Alimentación, LAN y WAN están encendidos.
2. Inicie un explorador web, como por ejemplo Internet Explorer, Firefox, Google Chrome o Safari.

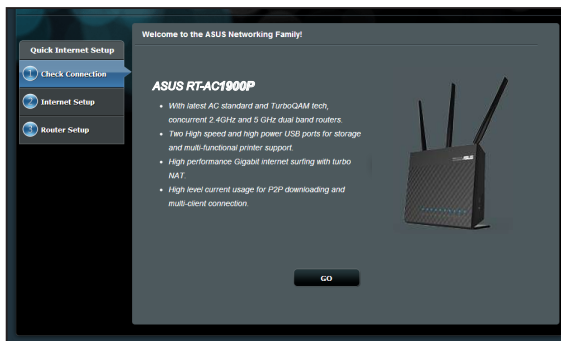

**NOTA:** si QIS no se inicia automáticamente, escriba <http://192.168.1.1> o <http://router.asus.com> en la barra de direcciones y actualice el explorador de nuevo

3. Asigne un nombre de inicio de sesión y una contraseña al enrutador y haga clic en **Next (Siguiente)**. Necesitará este nombre de inicio de sesión y esta contraseña para iniciar sesión en su RT-AC1900P para ver o cambiar la configuración del enrutador. Puede anotar el nombre de inicio de sesión en la contraseña del enrutador para uso futuro.



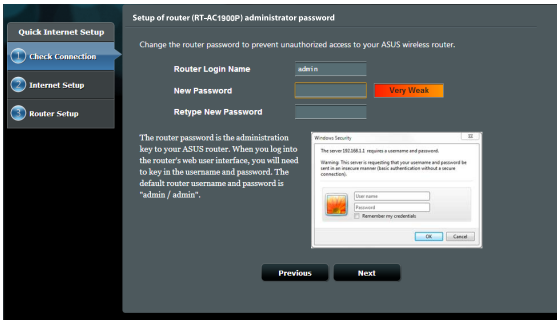

Nombre de inicio de sesión:

\_\_\_\_\_

Contraseña de inicio de sesión:

\_\_\_\_\_

4. La función de configuración rápida de Internet (QIS) del router inalámbrico detecta si el tipo de conexión ISP es **Dynamic IP (Dirección IP dinámica)**, **PPPoE**, **PPTP**, **L2TP** y **Static IP (Dirección IP estática)**. Obtenga la información necesaria sobre el tipo de conexión de Internet de su proveedor de servicios de internet (ISP, Internet Service Provider). Si el tipo de conexión es Dynamic IP (Dirección IP dinámica) (DHCP), el asistente QIS le dirigirá automáticamente al paso siguiente.



**NOTA:** si el tipo de conexión es Static IP (Dirección IP estática), elija **Static IP (Dirección IP estática)** y haga clic en **Next (Siguiente)**. Escriba la dirección IP, la máscara de subred, la puerta de enlace predeterminada y la información del servidor DNS proporcionadas por su ISP. Haga clic en **Next (Siguiente)** para continuar.

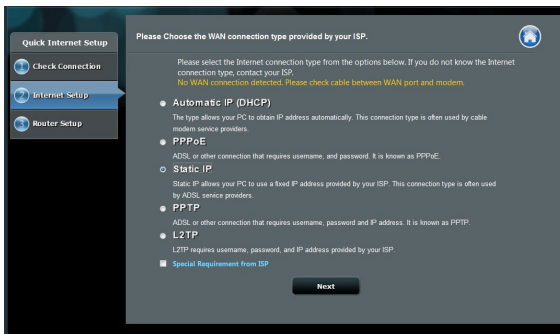

- Asigne el nombre de ver (SSID) y la clave de seguridad para la conexión inalámbrica de 2,4 GHz y 5 GHz. Haga clic en **Apply (Aplicar)** cuando haya terminado.

- Se mostrará la configuración de la conexión a Internet y la red inalámbrica. Haga clic en **Next (Siguiente)** para continuar.
- Lea el tutorial de conexión a una red inalámbrica. Cuando haya terminado, haga clic en **Finish (Finalizar)**.



#### NOTA:

- Puede asignar un nombre a la red compues-to por un máximo de 32 caracteres.
- Si es necesario, vea el vídeo del tutorial de configuración.



## Configurar el enrutador utilizando un dispositivo móvil (opcional)

También puede utilizar un dispositivo móvil, como por ejemplo un teléfono inteligente o una tableta, para configurar su RT-AC1900P a través del asistente QIS. El asistente QIS cambiará automáticamente a la versión móvil si utiliza un teléfono inteligente o una tableta para iniciarlo.

Para configurar el enrutador utilizando un dispositivo móvil:

1. Encienda su RT-AC1900P.
2. Habilite la función Wi-Fi del dispositivo móvil.
3. Busque el SSID **ASUS**, que es el SSID predeterminado de la red inalámbrica de su RT-AC1900P. Haga clic en este SSID para conectarse y espere a que el estado mostrado sea de Wi-Fi conectada.
4. Inicie el explorador Web del dispositivo móvil.



**NOTA:** si QIS no se inicia automáticamente, escriba <http://192.168.1.1> o <http://router.asus.com> en la barra de direcciones y actualice el explorador de nuevo. También puede utilizar el dispositivo móvil para buscar el código QR aquí para ir a la interfaz Web de su RT-AC1900P.

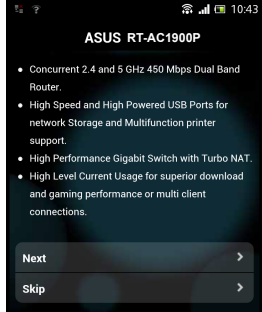

5. Asigne un nombre de inicio de sesión y una contraseña al enrutador y haga clic en **Next (Siguiente)**. Necesitará este nombre de inicio de sesión y esta contraseña para iniciar sesión en la interfaz Web de su RT-AC1900P para ver o cambiar la configuración del enrutador. Asegúrese de anotar el nombre de inicio de sesión en la contraseña del enrutador para uso futuro.

Nombre de inicio de sesión:

\_\_\_\_\_

Contraseña de inicio de sesión:

\_\_\_\_\_



6. La función QIS detecta automáticamente si el tipo de conexión ISP es Dynamic IP (Dirección IP dinámica), PPPoE, PPTP, L2TP o Static IP (Dirección IP estática). Especifique la información necesaria proporcionada por su proveedor de servicio de Internet (ISP, Internet Service Provider). Si el tipo de conexión es Dynamic IP (Dirección IP dinámica) (DHCP), el asistente QIS le dirigirá automáticamente al paso siguiente.



**NOTA:** si el tipo de conexión es Static IP (Dirección IP estática), elija **Static IP (Dirección IP estática)** y haga clic en **Next (Siguiente)**. Escriba la dirección IP, la máscara de subred, la puerta de enlace predeterminada y la información del servidor DNS proporcionadas por su ISP. Haga clic en **Next (Siguiente)** para continuar.



7. Asigne el nombre de ver (SSID) y la clave de seguridad para la conexión inalámbrica de 2,4 GHz y 5 GHz. Haga clic en **Apply (Aplicar)** cuando haya terminado.

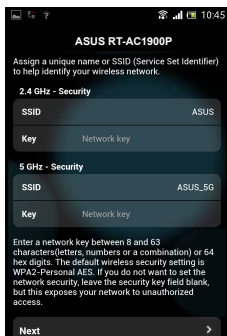

- Se mostrará la configuración de la conexión a Internet y la red inalámbrica. Haga clic en **Next (Siguiente)** para continuar.
- Lea el tutorial de conexión a una red inalámbrica. Cuando haya terminado, haga clic en **Finish (Finalizar)**.



---

**NOTA:** Puede asignar un nombre a la red compuesto por un máximo de 32 caracteres.

---

## Conectarse a la red inalámbrica

Los clientes inalámbricos (equipos portátiles, tabletas, teléfonos inteligentes, etc.) pueden conectarse a la red inalámbrica de su RT-AC1900P de dos formas.

### Conectarse a la red inalámbrica manualmente

Para conectarse a la red inalámbrica manualmente:

- Habilite la función Wi-Fi en el cliente inalámbrico para buscar las redes inalámbricas disponibles.
- Seleccione el SSID o el nombre de red que asignó a la red de su RT-AC1900P.
- Especifique la contraseña y haga clic en **Connect (Conectar)**.

### Conectarse a la red inalámbrica a través de WPS

Su RT-AC1900P tiene un botón WPS (Wi-Fi Protected Setup, es decir, Configuración protegida Wi-Fi) mediante el que puede conectar un cliente inalámbrico a la red de su RT-AC1900P sin necesidad de especificar una contraseña.

Para conectarse a la red inalámbrica a través de WPS:

- Presione el botón WPS situado en la parte posterior de RT-AC1900P. Consulte la sección **Un vistazo rápido a su RT-AC1900P** para conocer la ubicación del botón WPS.
- Presione el botón WPS del cliente inalámbrico antes de que transcurran dos minutos o siga las instrucciones de WPS incluidas con dicho cliente. Cuando realice la conexión a través de WPS, el LED Alimentación del enrutador comenzará a parpadear rápidamente.
- Espere a que el LED Alimentación del enrutador se ilumine permanentemente, lo que indica que la conexión entre dicho enrutador y el cliente inalámbrico se ha realizado correctamente.

## Administrar el enrutador a través de la GUI de ASUSWRT

El enrutador inalámbrico incluye una intuitiva interfaz gráfica del usuario Web ASUSWRT. ASUSWRT permite configurar fácilmente sus distintas funciones a través de un explorador Web, como por ejemplo Internet Explorer, Firefox, Safari o Google Chrome.



**NOTA:** Utilice la barra de búsqueda situada en la parte inferior de la interfaz para obtener más información en el sitio de soporte técnico de ASUS (<http://support.asus.com>).



### IMPORTANTE:

- Para obtener más detalles sobre cómo utilizar la GUI Web, consulte el manual del usuario.
- Para mejorar su experiencia, busque siempre la versión más reciente del firmware y actualícese a ella.
- Visite el canal de vídeo ASUS Networking para obtener vídeos de tutoriales sobre funciones incluidas.



## AiCloud

La aplicación ASUS AiCloud proporciona acceso a los datos en cualquier lugar y momento en el que tenga una conexión a Internet. También permite acceder a su cuenta de ASUS WebStorage a través de la aplicación móvil AiCloud en su dispositivo iOS o Android, o través de un explorador Web.

Para instalar AiCloud:

1. Asegúrese de que la versión de firmware del enrutador es la más reciente y admite AiCloud.
2. Descargue la aplicación AiCloud de Google Play o App Store.
3. Instale el dispositivo de almacenamiento USB en el enrutador. Consulte la sección **Un vistazo rápido a su RT-AC1900P** para conocer la ubicación de los puertos USB.
4. Conecte su iOS o dispositivos Android al enrutador a través de Wi-Fi. La aplicación AiCloud le guiará automáticamente a través del proceso de configuración.
5. Ahora puede acceder a todos los archivos de su almacenamiento USB, transmitirlos por secuencias y compartirlos. Busque ASUS AiCloud para obtener más información. Vea los vídeos de tutoriales para obtener instrucciones paso a paso.



Google Play



App Store

## Preguntas más frecuentes (P+F)

**Después de seguir los pasos indicados, siga sin poder acceder a la interfaz gráfica del usuario (GUI) Web del router inalámbrico para definir la configuración de dicho router.**

Asegúrese de que la configuración proxy de su PC está deshabilitada y que la dirección IP de dicho PC se obtiene del servidor DHCP automáticamente. Para obtener detalles acerca de la configuración proxy, visite el sitio de soporte técnico de ASUS en <http://support.asus.com>. Para obtener detalles acerca del servidor DHCP para obtener direcciones IP automáticamente, consulte la función de ayuda de su sistema operativo Windows® o Mac.

**El cliente no puede establecer una conexión inalámbrica con el router.**

**Se encuentra fuera del alcance de la red:**

- Coloque el router más cerca del cliente inalámbrico.
- Intente cambiar el canal.

**Autenticación:**

- Utilice la conexión por cable para conectarse al router.
- Consulte la configuración de seguridad inalámbrica.
- Presione el botón Restablecer situado en el panel posterior durante más de cinco segundos.

**No se encuentra el router:**

- Mantenga pulsado el botón **Reset (Restablecer)** durante más de cinco segundos.
- Consulte la configuración del adaptador inalámbrico, como el identificador SSID y la configuración de cifrado.

**No se puede acceder a Internet por medio del adaptador de red LAN inalámbrica**

- Coloque el router más cerca del cliente inalámbrico.
- Compruebe si el adaptador inalámbrico está conectado al router inalámbrico correcto.
- Check the encryption settings.



- Compruebe si el canal inalámbrico en uso se puede utilizar en su zona/país.
- Consulte la configuración de cifrado.
- Consulte si la conexión de ADSL o Cable es correcta.
- Vuelva a intentarlo utilizando otro cable Ethernet.

**Si el indicador luminoso “LINK” del Módem ADSL permanece iluminado o apagado, significa que no es posible acceder a Internet; el router no puede establecer una conexión con la red ADSL.**

- Asegúrese de que todos los cables estén conectados correctamente.
- Desconecte el cable de alimentación del módem de ADSL o Cable, espere unos minutos y vuelva a conectarlo.
- Si el indicador ADSL continúa parpadeando o permanece APAGADO, póngase en contacto con su proveedor de servicios de ADSL.

### He olvidado el nombre de la red o las claves de cifrado.

- Intente establecer la conexión por cable y configurar de nuevo el cifrado inalámbrico.
- Presione el botón Reiniciar del router inalámbrico durante más de cinco segundos.
- Valores predeterminados de fábrica:

<b>Nombre de usuario / Contraseña:</b> admin / admin	<b>Dirección IP:</b> 192.168.1.1	<b>SSID:</b> ASUS
--	----------------------------------	-------------------

### ¿De qué otros recursos dispongo para obtener más información acerca del router inalámbrico?

- El manual del usuario que incluye el CD de soporte
- El sitio web de preguntas más frecuentes: <http://support.asus.com/faq>
- El sitio web de soporte técnico: <http://support.asus.com/>
- Línea Directa: Consulte el número de la línea telefónica de soporte técnico en esta Guía de inicio rápido.

## ASUS Recycling/Takeback Services

ASUS recycling and takeback programs come from our commitment to the highest standards for protecting our environment. We believe in providing solutions for you to be able to responsibly recycle our products, batteries, other components, as well as the packaging materials. Please go to <http://csr.asus.com/english/Takeback.htm> for the detailed recycling information in different regions.

## REACH

Complying with the REACH (Registration, Evaluation, Authorisation, and Restriction of Chemicals) regulatory framework, we published the chemical substances in our products at ASUS REACH website at <http://csr.asus.com/english/REACH.htm>

## Federal Communications Commission Statement

This device complies with Part 15 of the FCC Rules. Operation is subject to the following two conditions:

- This device may not cause harmful interference.
- This device must accept any interference received, including interference that may cause undesired operation.

This equipment has been tested and found to comply with the limits for a class B digital device, pursuant to part 15 of the FCC Rules. These limits are designed to provide reasonable protection against harmful interference in a residential installation.

This equipment generates, uses and can radiate radio frequency energy and, if not installed and used in accordance with the instructions, may cause harmful interference to radio communications. However, there is no guarantee that interference will not occur in a particular installation. If this equipment does cause harmful interference to radio or television reception, which can be determined by turning the equipment off and on, the user is encouraged to try to correct the interference by one or more of the following measures:

- Reorient or relocate the receiving antenna.
- Increase the separation between the equipment and receiver.
- Connect the equipment into an outlet on a circuit different from that to which the receiver is connected.
- Consult the dealer or an experienced radio/TV technician for help.



---

**WARNING!** Any changes or modifications not expressly approved by the party responsible for compliance could void the user's authority to operate the equipment.

---

## Prohibition of Co-location

This device and its antenna(s) must not be co-located or operating in conjunction with any other antenna or transmitter except in accordance with FCC multi-transmitter product procedures. For product available in the USA/Canada market, only channel 1~11 can be operated. Selection of other channels is not possible.

### IMPORTANT NOTE:

**Radiation Exposure Statement:** This equipment complies with FCC radiation exposure limits set forth for an uncontrolled environment. End users must follow the specific operating instructions for satisfying RF exposure compliance. To maintain compliance with FCC exposure compliance requirement, please follow operation instruction as documented in this manual.

## Declaration of Conformity for R&TTE directive 1999/5/EC

Essential requirements – Article 3

Protection requirements for health and safety – Article 3.1a

Testing for electric safety according to EN 60950-1 has been conducted. These are considered relevant and sufficient.

Protection requirements for electromagnetic compatibility – Article 3.1b

Testing for electromagnetic compatibility according to EN 301 489-1 and EN 301 489-17 has been conducted. These are considered relevant and sufficient.

Effective use of the radio spectrum – Article 3.2

Testing for radio test suites according to EN 300 328- 2 has been conducted. These are considered relevant and sufficient.

## CE Mark Warning

This is a Class B product, in a domestic environment, this product may cause radio interference, in which case the user may be required to take adequate measures. Operation Channels: CH1~11 for N. America; Ch1~14 for Japan; CH1~13 for Europe (ETSI)

This equipment may be operated in AT, BE, CY, CZ, DK, EE, FI, FR, DE, GR, HU, IE, IT, LU, MT, NL, PL, PT, SK, SL, ES, SE, GB, IS, LI, NO, CH, BG, RO, RT.

## Canada, Industry Canada (IC) Notices

This Class B digital apparatus complies with Canadian ICES-003 and RSS-210.

Operation is subject to the following two conditions: (1) this device may not cause interference, and (2) this device must accept any interference, including interference that may cause undesired operation of the device.

## **Radio Frequency (RF) Exposure Information**

The radiated output power of the ASUS Wireless Device is below the Industry Canada (IC) radio frequency exposure limits. The ASUS Wireless Device should be used in such a manner such that the potential for human contact during normal operation is minimized.

This device has been evaluated for and shown compliant with the IC Specific Absorption Rate (“SAR”) limits when installed in specific host products operated in portable exposure conditions (antennas are less than 20 centimeters of a person’s body).

This device has been certified for use in Canada. Status of the listing in the Industry Canada’s REL (Radio Equipment List) can be found at the following web address: <http://www.ic.gc.ca/app/sitt/reltel/srch/nwRdSrch.do?lang=eng>  
Additional Canadian information on RF exposure also can be found at the following web: <http://www.ic.gc.ca/eic/site/smt-gst.nsf/eng/sf08792.html>

## **Canada, avis d’Industry Canada (IC)**

Cet appareil numérique de classe B est conforme aux normes canadiennes ICES-003 et RSS-210.

Son fonctionnement est soumis aux deux conditions suivantes : (1) cet appareil ne doit pas causer d’interférence et (2) cet appareil doit accepter toute interférence, notamment les interférences qui peuvent affecter son fonctionnement.

## **Informations concernant l’exposition aux fréquences radio (RF)**

La puissance de sortie émise par l’appareil de sans fil ASUS est inférieure à la limite d’exposition aux fréquences radio d’Industry Canada (IC). Utilisez l’appareil de sans fil ASUS de façon à minimiser les contacts humains lors du fonctionnement normal.

Ce périphérique a été évalué et démontré conforme aux limites SAR (Specific Absorption Rate – Taux d’absorption spécifique) d’IC lorsqu’il est installé dans des produits hôtes particuliers qui fonctionnent dans des conditions d’exposition à des appareils portables (les antennes se situent à moins de 20 centimètres du corps d’une personne).

Ce périphérique est homologué pour l’utilisation au Canada. Pour consulter l’entrée correspondant à l’appareil dans la liste d’équipement radio (REL - Radio Equipment List) d’Industry Canada rendez-vous sur:

<http://www.ic.gc.ca/app/sitt/reltel/srch/nwRdSrch.do?lang=eng>

Pour des informations supplémentaires concernant l’exposition aux RF au Canada rendez-vous sur :

<http://www.ic.gc.ca/eic/site/smt-gst.nsf/eng/sf08792.html>

## NCC 警語

經型式認證合格之低功率射頻電機，非經許可，公司、商號或使用者均不得擅自變更頻率、加大功率或變更原設計之特性及功能。低功率射頻電機之使用不得影響飛航安全及干擾合法通信；經發現有干擾現象時，應立即停用，並改善至無干擾時方得繼續使用。前項合法通信，指依電信法規定作業之無線電通信。低功率射頻電機須忍受合法通信或工業、科學及醫療用電波輻射性電機設備之干擾。

電池波曝露量 MPE 標準值  $1\text{mWcm}^2$ ，送測產品實測值為： $0.529\text{mWcm}^2$ 。

## Networks Global Hotline Information

Region	Country	Hotline Number	Service Hours
Europe	Cyprus	800-92491	09:00-13:00 ; 14:00-18:00 Mon-Fri
	France	0033-170949400	09:00-18:00 Mon-Fri
	Germany	0049-1805010920	09:00-18:00 Mon-Fri 10:00-17:00 Mon-Fri
		0049-1805010923 (component support)	
		0049-2102959911 (Fax)	
	Hungary	0036-15054561	09:00-17:30 Mon-Fri
	Italy	199-400089	09:00-13:00 ; 14:00-18:00 Mon-Fri
	Greece	00800-44142044	09:00-13:00 ; 14:00-18:00 Mon-Fri
	Austria	0043-820240513	09:00-18:00 Mon-Fri
	Netherlands/ Luxembourg	0031-591570290	09:00-17:00 Mon-Fri
	Belgium	0032-78150231	09:00-17:00 Mon-Fri
	Norway	0047-2316-2682	09:00-18:00 Mon-Fri
	Sweden	0046-858769407	09:00-18:00 Mon-Fri
	Finland	00358-969379690	10:00-19:00 Mon-Fri
	Denmark	0045-38322943	09:00-18:00 Mon-Fri
	Poland	0048-225718040	08:30-17:30 Mon-Fri
	Spain	0034-902889688	09:00-18:00 Mon-Fri
	Portugal	00351-707500310	09:00-18:00 Mon-Fri
	Slovak Republic	00421-232162621	08:00-17:00 Mon-Fri
	Czech Republic	00420-596766888	08:00-17:00 Mon-Fri
Switzerland-German	0041-848111010	09:00-18:00 Mon-Fri	
Switzerland-French	0041-848111014	09:00-18:00 Mon-Fri	
Switzerland-Italian	0041-848111012	09:00-18:00 Mon-Fri	
United Kingdom	0044-8448008340	09:00-17:00 Mon-Fri	
Ireland	0035-31890719918	09:00-17:00 Mon-Fri	
Russia and CIS	008-800-100-ASUS	09:00-18:00 Mon-Fri	
Ukraine	0038-0445457727	09:00-18:00 Mon-Fri	

Region	Country	Hotline Numbers	Service Hours
<b>Asia-Pacific</b>	Australia	1300-278788	09:00-18:00 Mon-Fri
	New Zealand	0800-278788	09:00-18:00 Mon-Fri
	Japan	0800-1232787	09:00-18:00 Mon-Fri 09:00-17:00 Sat-Sun
		0081-473905630 (Non-Toll Free)	09:00-18:00 Mon-Fri 09:00-17:00 Sat-Sun
		Korea	0082-215666868
	Thailand	0066-24011717 1800-8525201	09:00-18:00 Mon-Fri
	Singapore	0065-64157917	11:00-19:00 Mon-Fri
		0065-67203835 (Repair Status Only)	11:00-19:00 Mon-Fri 11:00-13:00 Sat
		Malaysia	0060-320535077
	Philippine	1800-18550163	09:00-18:00 Mon-Fri
	India	1800-2090365	09:00-18:00 Mon-Sat
	India(WL/NW)		09:00-21:00 Mon-Sun
	Indonesia	0062-2129495000 500128 (Local Only)	09:30-17:00 Mon-Fri 9:30 – 12:00 Sat
	Vietnam	1900-555581	08:00-12:00 13:30-17:30 Mon-Sat
	Hong Kong	00852-35824770	10:00-19:00 Mon-Sat
<b>Americas</b>	USA	1-812-282-2787	8:30-12:00 EST Mon-Fri
	Canada		9:00-18:00 EST Sat-Sun
	Mexico	001-8008367847	08:00-20:00 CST Mon-Fri 08:00-15:00 CST Sat

Region	Country	Hotline Numbers	Service Hours
<b>Middle East + Africa</b>	Egypt	800-2787349	09:00-18:00 Sun-Thu
	Saudi Arabia	800-1212787	09:00-18:00 Sat-Wed
	UAE	00971-42958941	09:00-18:00 Sun-Thu
	Turkey	0090-2165243000	09:00-18:00 Mon-Fri
	South Africa	0861-278772	08:00-17:00 Mon-Fri
	Israel	*6557/00972-39142800	08:00-17:00 Sun-Thu
		*9770/00972-35598555	08:30-17:30 Sun-Thu
<b>Balkan Countries</b>	Romania	0040-213301786	09:00-18:30 Mon-Fri
	Bosnia Herzegovina	00387-33773163	09:00-17:00 Mon-Fri
		00359-70014411	09:30-18:30 Mon-Fri
	Bulgaria	00359-29889170	09:30-18:00 Mon-Fri
		00385-16401111	09:00-17:00 Mon-Fri
	Croatia	00382-20608251	09:00-17:00 Mon-Fri
	Montenegro	00381-112070677	09:00-17:00 Mon-Fri
	Serbia	00368-59045400	08:00-16:00 Mon-Fri
		00368-59045401	
	Estonia	00372-6671796	09:00-18:00 Mon-Fri
	Latvia	00371-67408838	09:00-18:00 Mon-Fri
	Lithuania-Kaunas	00370-37329000	09:00-18:00 Mon-Fri
	Lithuania-Vilnius	00370-522101160	09:00-18:00 Mon-Fri



**NOTE:** For more information, visit the ASUS support site at:  
<http://support.asus.com>







# VIP Member Warranty Notice

## VIP會員保固登錄通知

Global Site: <http://www.asus.com> VIP Registration: <http://vip.asus.com>

Dearest Customer,

Thank you for purchasing an ASUS product!

Register online\* immediately and:

- (1) Enjoy total warranty and protection for your ASUS product
- (2) Receive exclusive VIP Member privileges like:
  - The latest ASUS product news, promotional activities, benefits and discounts exclusive to VIP Members only
  - Software / firmware upgrade reminders

\* For more inquiries and details regarding guarantee and warranty matters, please visit the official website at <http://www.asus.com>.

親愛的客戶您好，感謝您購買華碩產品！

現在就上網登錄立即晉升為華碩VIP會員

- (1) 享有完整保固權益之保障
- (2) 尊爵VIP會員服務：
  - 最新的華碩產品訊息、第一手的促銷優惠、VIP會員獨享的專屬折扣
  - 軟體/韌體更新即時提醒
  - 不同於一般保固均自出場日起為起始日計算，上網註冊成功後，您的保固日期將以「購買當日」為起始日期（請保留蓋有經銷商店章受或單據或發票影本，於機台維修時出示，始享有此獨享服務）

\* 其他相關的保固說明細節，請上華碩官方網站查詢：<http://www.asus.com>。

### For Australian Warranty Statement Only

\* ASUS products come with guarantees that connect be excluded under the Australian Consumer Law. You are entitled to a replacement or refund for a major failure and compensation for any other reasonably foreseeable loss or damage. You are also entitled to have the products repaired or replaced if the goods fail to be of acceptable quality and the failure does not amount to a major failure. You can find more information about the Australian Consumer Law on the ACCC website: [www.accc.gov.au](http://www.accc.gov.au) (see under “For Consumers” tab). ASUSTek Computer Inc. offers the Warranty in conjunction with any guarantees imposed by the Australian Consumer Law.

## VIP Member Copy VIP 會員收執聯

\* To immediately enjoy the VIP Member's enhanced service, we suggest that you register directly via the internet at <http://vip.asus.com>.

\* 為即時享有 VIP 會員級服務，建議您直接上網登錄註冊

### Product Information 產品資料

Product Model 產品型號: \_\_\_\_\_

Product Number (P/N) 產品序號: \_\_\_\_\_

Date of Purchase 購買日期: \_\_\_\_\_ dd \_\_\_\_\_ mm \_\_\_\_\_ yy

Dealer name/shop seal 經銷商名稱/店章 Paste product barcode 黏貼產品條碼處

Retail sales representative name 門市業務姓名: \_\_\_\_\_

\* To ensure the validity of the warranty, please fill in the shop name, name of servicing personnel, date of purchase and other information accurately.

\* 為保障您的權益，請確實填寫店名、承辦業務人員、購買日期等資料。

## Dealer Copy 經銷商收執聯

\* Dealer service partners, fill in the product information as accurately as possible

\* 經銷商業務夥伴，請務必填寫產品資料，並確實保管收執，以維護客戶與保障您的個人權益。

### Product Information 產品資料

Product Model 產品型號: \_\_\_\_\_

Product Number (P/N) 產品序號: \_\_\_\_\_

Date of Purchase 購買日期: \_\_\_\_\_ dd \_\_\_\_\_ mm \_\_\_\_\_ yy

Dealer name/shop seal 經銷商名稱/店章 Paste product barcode 黏貼產品條碼處

Retail sales representative name 門市業務姓名: \_\_\_\_\_

\* To ensure the validity of the warranty, please fill in the shop name, name of servicing personnel, date of purchase and other information accurately.

\* 為保障您的權益，請確實填寫店名、承辦業務人員、購買日期等資料

\* Please mail back this form to your local ASUS sales representative for ASUS Advantage mileage program point accumulation (dependent on local sales policies / web availability).

\* 本收執聯與經銷商活動積點辦法實際執行，由各區華碩人員公告之



150200190500MAS R01