

# DRG700

## Quick Installation Guide



---

GENEXIS

This guide applies to all DRG700 models

---

# CONTENTS

1.	DRG700 overview.....	2
2.	Installation.....	4
3.	Network setup.....	7
4.	Wireless setup.....	8
5.	Configuring your DRG700.....	9
6.	Troubleshooting.....	10

# 1. DRG700 OVERVIEW

## User interfaces

Interface	Description
1	Power port
2	Ethernet LAN ports
3	USB 2.0 port
4	Telephony ports
5	CATV connector
6	Reset button
7	WPS button



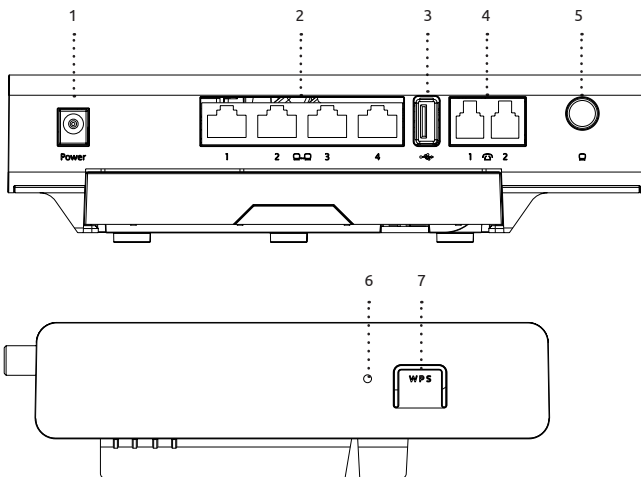



Note: Depending on your specific product type, port configuration may differ.



### Cleaning instructions:

Your DRG700 product may be cleaned using a soft, dry cloth. For areas of persistent dirt, a damp cloth may be used with mild detergent. Product and LED logos may be damaged by using aggressive cleaning products or ethanol-based cleaners - if in doubt do not clean near these logos. Under no circumstances allow water or cleaning fluid to ingress the product, as this may cause permanent damage and prevent correct operation.

## Status feedback LEDs:

LED	Activity	Description
	On (green)	Power on
	On (red)	Error
	Blink (green)	Booting
	Off	Power off
	On	WAN link active
	Off	WAN link inactive
	On (green)	CATV on, signal received
	On (red)	CATV on, no signal received
	Off	CATV disabled
	On	Phone line 1 active
	Off	Phone line 1 inactive
	On	Phone line 2 active
	Off	Phone line 2 inactive
	On	WLAN enabled
	Blink	WPS active
	Off	WLAN disabled
LAN ports	On (green)	Link operating at 1000 Mbps
	On (orange)	Link operating at 100 or 10 Mbps
	Blink	Activity

## Reset button:

Function	Action
Restart	To restart DRG700 without erasing the saved configuration:  <ol style="list-style-type: none"><li>1. Press the button for less than 5 seconds.</li><li>2. Release the button.</li></ol>
Factory reset	To restart DRG700 with all configuration data cleared and factory settings restored:  <ol style="list-style-type: none"><li>1. Press the button for more than 5 seconds.</li><li>2. Release the button.</li></ol>

## WPS button:

This button is used to automatically connect a WPS-enabled wireless client to the DRG700. For details about the connection procedure, see "Wireless Setup" on page 8.

## 2. INSTALLATION

### Step 1: Preparing the DRG FTU

Remove the dust cover from the DRG FTU.

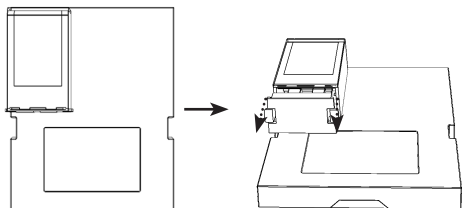

### Step 2: Preparing the DRG700

Remove the dust covers for the fiber connectors on the DRG700.

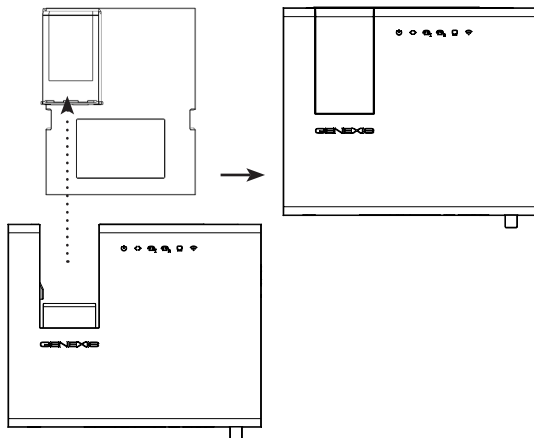

### Step 3: Mounting the DRG700 on the DRG FTU

1. Place the DRG700 on the FTU in such a way that the tabs on side of DRG700 are aligned with the cutouts on the FTU.
2. Gently slide the DRG700 upwards until the fiber connectors connect firmly with the FTU.



#### Step 4: Powering the DRG700

Connect the 12V plug of the supplied adapter to the DRG700 and connect the adapter to a power socket.

Result: The  LED first flashes green. When the booting process is completed, the  LED will be solid green.

Note: The complete start-up sequence may take 2-3 minutes.

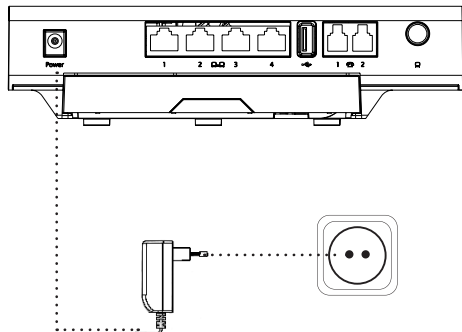

#### Step 5: Connecting your computer

Connect your computer to one of the Ethernet LAN ports on the DRG700 using an Ethernet cable with a RJ-45 connector.

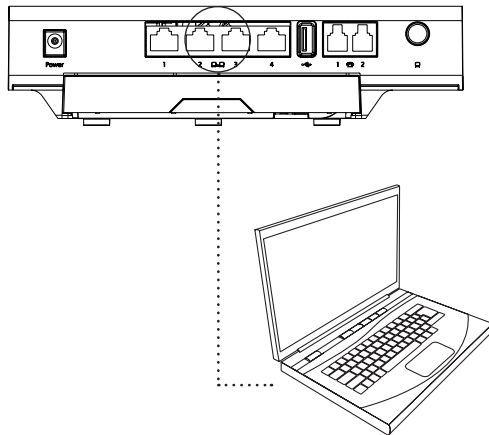

Result: The LAN port LED is on (provided that the computer is on).



### Step 6: Connecting your telephone

This step is only relevant if the DRG700 has telephony ports.

Connect a standard telephone handset to a telephony port using a RJ-11 cable.

Result: The  or  LED is on if voice is enabled and operating correctly. You should hear a dialtone if you pick up the handset.

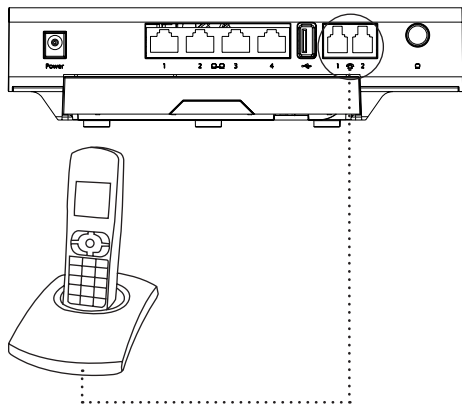

### Step 7: Connecting your analog television

This step is only relevant if the DRG700 has a CATV connector.

Connect your television to the CATV connector using a coaxial cable with a male F-connector.

Result: The  LED is on if CATV is enabled and operating correctly. You may need to retune your television if required for the CATV service.

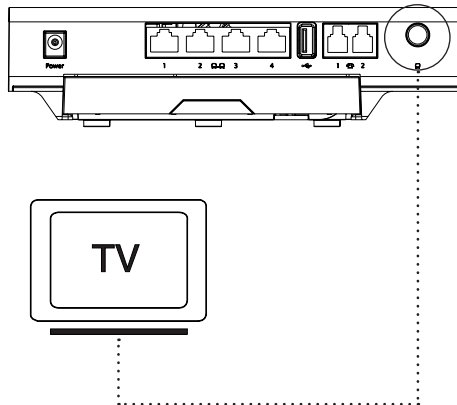

### 3. NETWORK SETUP

#### Step 1:

Open your web browser and check if your Internet connection is working. If your connection is working, you may skip step 2 and 3.

#### Step 2:

(The following instructions are only for Windows Windows 7 / Windows 8. For network setup instructions on other operating systems, please consult the user manual.)

1. Select Start > Control Panel.
2. In the Network and Internet section, click View Network Status and Tasks.
3. Open the panel for network connections:
  - For Windows Vista: Click Manage network connections at the top left hand corner.
  - For Windows 7: Click Change adapter settings at the top left hand corner.
4. Identify the connected network card, right-click the corresponding Local Area Connection, and select Properties in the context menu.
5. Select Internet Protocol Version 4 (TCP/IPv4) from the list and click Properties.
6. Select Obtain an IP address automatically and Obtain DNS server address automatically.
7. Click OK and close the window.

#### Step 3:

Open your web browser and check if the network connection is working. If your connection is not working, refer to the *Troubleshooting* section on page 11.

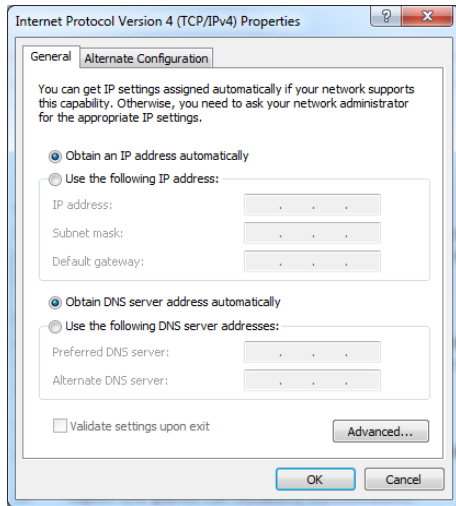



## 4. WIRELESS SETUP

*This section is only relevant if wireless functionality is available on your DRG700.*

*(The following instructions are only for Windows 7 / Windows 8. For wireless setup instructions on other operating systems, please consult the user manual.)*

### Wireless setup using WPA encryption key

#### **Step 1:**

Click the network icon in the notification area of the taskbar. For example:

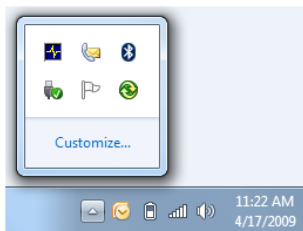

#### **Step 2:**

Select your network SSID and click Connect. The SSID is the name of the wireless network.

#### **Step 3:**

Enter your WPA key and click OK. The WPA key is the password needed for your secured wireless network.

Note: You can find the default SSID and the WPA key on a label shipped with the unit. They are also printed on the label on the back of the DRG700. You can change the SSID and the WPA key when you configure the DRG700.

### Wireless setup using WPS

#### **Step 1:**

Click the network icon in the notification area of the taskbar.

#### **Step 2:**

Select your network SSID and click Connect.

#### **Step 3:**

Press the WPS button on the DRG.

The DRG700 automatically connects to the computer. The connection is established and is displayed as "Connected" in the network list.

### Toggling WLAN status

Press the WPS button for >5 seconds and release it. All user-defined WLAN interfaces are toggled on/off. Status is indicated by WLAN LED.

---

## 5. CONFIGURING YOUR DRG700



*It is only advised for advanced users to change the configuration, as doing this might interrupt your connection. By default the router is configured properly for most home networks.*

*Note: For information about how to reset the router to the factory default settings, see "Reset button" on page 3.*

### Requirements:

The configuration program has been tested on the following browsers:

- Safari version 5 or later
- Firefox version 10 or later
- Internet Explorer version 7.0 or later
- Google Chrome

The browser must support Javascript.

### Step 1:

Launch the web browser on your computer and enter "http://router" in the address bar. The router's default IP address is "192.168.1.254".

### Step 2:

Log in as "admin", using the default password "admin".











It is strongly advised to change the password after you logged in for the first time.

### Step 3:

Configure the router to the desired configuration. Read the help text for additional information about the settings.

## 6. TROUBLESHOOTING

Issue		Action
	LED is off	Make sure you have connected the DRG700 to a working power outlet, using the adapter shipped along with the DRG700. If the LED remains off, please contact your service provider.
	Red LED is on	System error. Disconnect the power from the DRG700 and restart DRG700. If the problem persists, please contact your service provider.
	LED is off	No uplink. Power down the device, wait for 1 minute, then power the device back on. If the problem persists, please contact your service provider.
	LED is off	CATV is disabled. Please contact your service provider if a CATV signal is expected.
	Red LED is on	CATV is enabled but no signal is detected. Please contact your service provider if a CATV signal is expected.
 or 	LED is off	Voice functionality is not enabled. Please contact your service provider if voice functionality is expected.
	LED is off	Please check in the web interface whether wireless functionality is enabled. If the problem persists, please contact your service provider.
Web interface is not reachable		Check if the physical connection between the DRG700 and your computer is correct.

## Europe-EU Declaration of Conformity



Hereby, Genexis BV declares that this product is in compliance with the essential requirements and other relevant provisions of Directive 1999/5/EC.