

# GENEXIS

---



**DRG 700 Series**  
**DRG 7000 Series**  
Quick Installation Guide

# Contents

1.	Supported Models.....	1
2.	What's in the box .....	2
3.	DRG Overview .....	3
4.	Installation .....	4
	Mount on FTU.....	4
	Connect Power .....	5
	Connect Computer .....	5
	Connect Telephone .....	6
	Connect TV .....	6
5.	Advanced Configuration .....	7
6.	Safety & Care.....	7
7.	LAN (network) Setup.....	8
8.	Wireless Setup .....	10
9.	Troubleshooting.....	12
	Status LEDs .....	13

# 1. Supported Models

## DRG 700 series

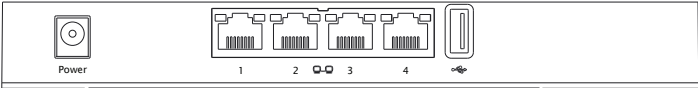
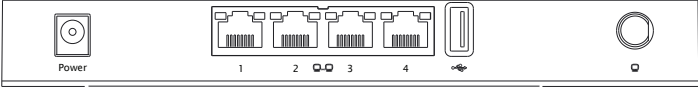
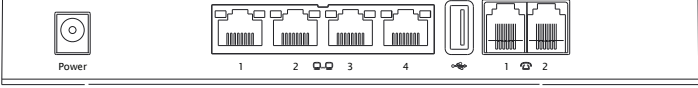
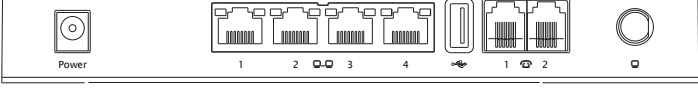
DRG 711v2	
DRG 712v2	
DRG 719v2	
DRG 739v2	
DRG 716v2	
DRG 736v2	
DRG 737v2	

## DRG 7000 series

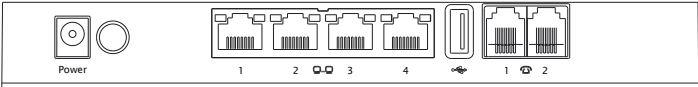
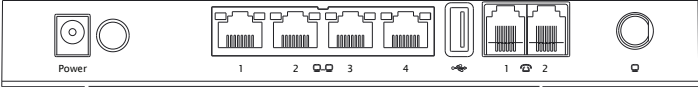
DRG 7820	
DRG 7860	
DRG 7870	
DRG 7880	

## 2. What's in the box

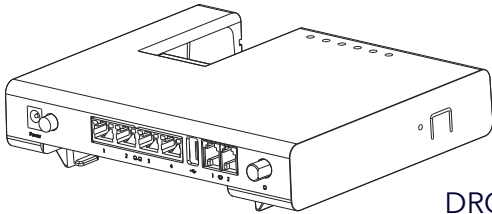

DRG \*

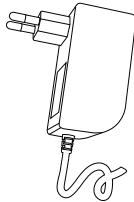

Power adaptor

DRG7xxx		DRG7xxx	
<b>PN:</b> xxxxxxxxxxxx	<b>SSID:</b> GNxxxxxx	<b>MAC:</b> 00:0F:94:XX:XX:XX	
<b>SN:</b> X,xxxxxxxxxx	<b>WPA KEY:</b> xxxxxxxxxxxx	<b>GUI:</b> https://router	
	<b>WPS PIN:</b> xxxxxxxx	<b>Username:</b> admin	
<b>MAC:</b> 00:0F:94:XX:XX:XX		<b>Password:</b> xxxxxxxx	
	<b>CLASS 1 LASER PRODUCT</b>		
<b>GUI:</b> https://router	<b>12V 2A</b>	<b>SSID:</b> GNxxxxxx	
<b>Username:</b> admin		<b>WPA KEY:</b> xxxxxxxxxxxx	
<b>Password:</b> xxxxxxxx		<b>WPS PIN:</b> xxxxxxxx	
Made in China VER: x	GENEXIS	GENEXIS	GENEXIS

1

2

These two labels contain information essential to the configuration and operation of your device.

The first label may be retained by the installer.

Please retain the second label for your reference. To prevent it from getting lost, we recommend it be placed on the front of your DRG.

### 3. DRG Overview

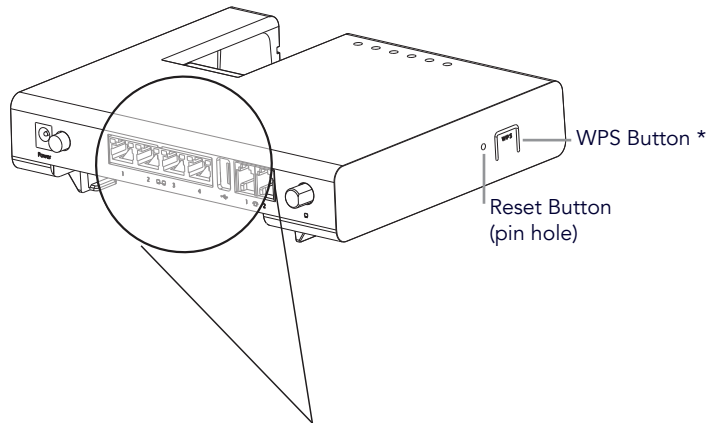

Button	Function	
	Reset	Press and release to reboot.
	Factory Reset (restore factory configuration)	Press and hold for more than 5 seconds. Once the LEDs start flashing, release the button.
WPS *	Press and release to initiate WPS ( Wi-Fi models only )	

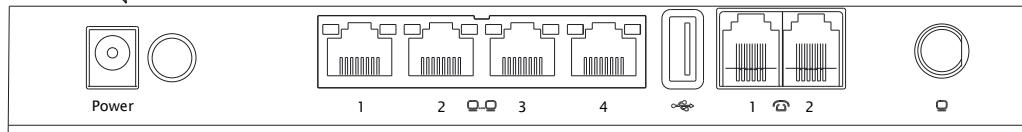

Power connector & Power button \*

LAN ports

USB 2.0 Port

Telephone Jacks \*

CATV \*

\* not present on all models

# 4. Installation

## 1. Mount on FTU

Step 1: If present, remove the dust caps from the fiber connector(s)\* on the DRG.

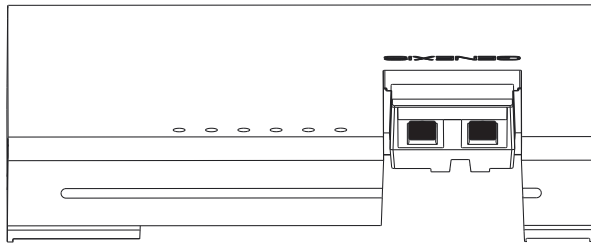

Dust caps present

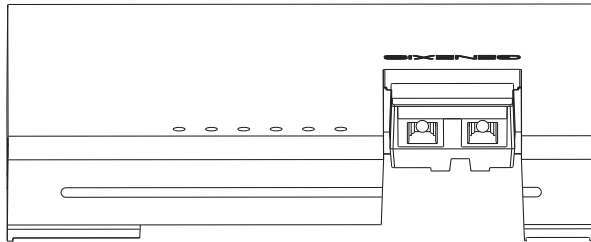

Dust caps removed

\* the number of connectors will vary depending on the exact model

Step 2: If present, remove the dust caps (shown circled) from the connector(s)\* on the FTU (fiber termination unit).

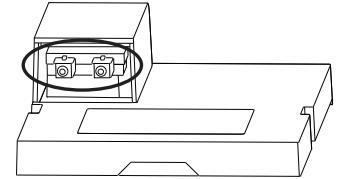

Step 3: Place the DRG on the FTU so that the tabs on the side of the DRG align with the notches on the FTU. Both tabs and notches are shown circled on the right.

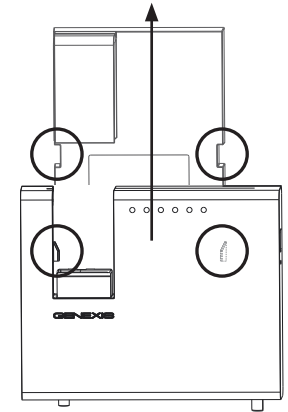

Step 4: Slide the DRG up in the direction of the arrow until the fiber connector(s) click gently into place.

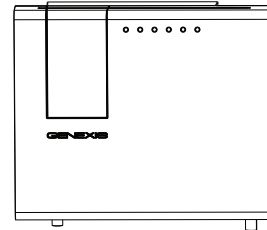

## 2. Connect Power

Connect the supplied power adaptor to the socket on the DRG (as shown on page 3) and then plug the adaptor into an AC socket.

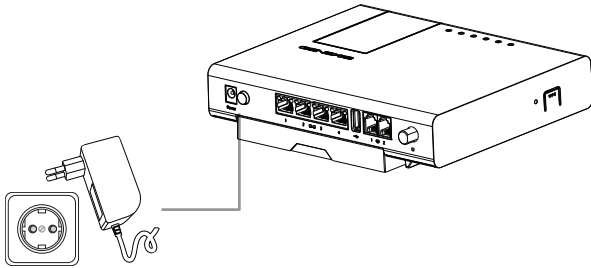

If your unit has a power button, push it in to switch the device on.

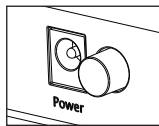

OFF

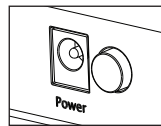

ON

The  LED (as shown on page 13) indicates if the unit has successfully powered on.

## 3. Connect Computer

Connect your computer or laptop to the appropriate LAN port (as shown on page 3) using an Ethernet cable. Your service provider will tell you exactly which port to use.

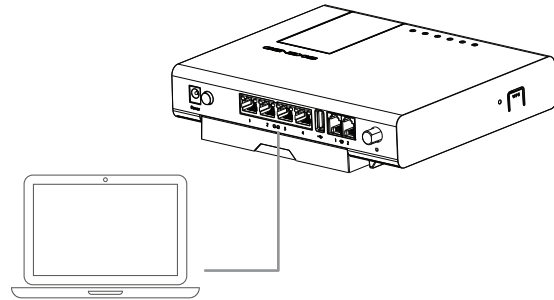

The LAN status lights (described on page 13) provide information about the status of the connection.

#### 4. Connect Telephone \*

A standard analogue telephone handset can be connected to the active voice port(s) using a telephone cable with an RJ-11 connector. Your service provider will tell you which port to use.

The <sub>1</sub> and <sub>2</sub> LEDs (as described on page 13) indicate if the voice service is enabled and receiving a signal.

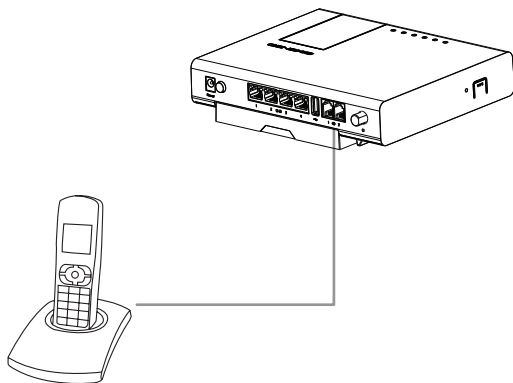

#### 5. Connect TV \*

Connect an analogue television to the CATV connector using a coaxial cable with a male F connector.

The CATV indicator LED  (see page 13) provides feedback on the status of the CATV connection.

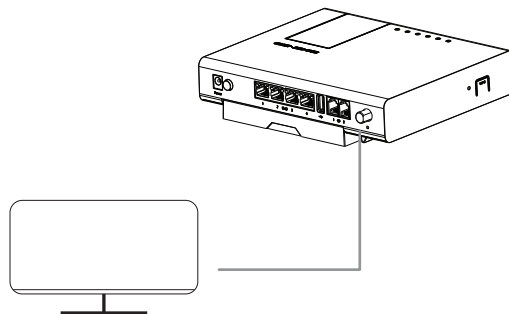



## 5. Advanced Configuration

By default, the router is configured correctly for most home networks.

Changing the configuration is only advised for advanced users as it may interrupt your connection. If you should need to reset the router back to its factory settings, please refer to page 3.

Configuring your DRG is done via your web-browser. The second label (as described on page 2) lists the URL you need to connect to as well as the user name and password required in order to log in.

DRG7xxxx	
MAC:	00:0F:94:XX:XX:XX
GUI:	https://router
Username:	admin
Password:	xxxxxxx
SSID:	GNxxxxxx
WPA KEY:	xxxxxxxxxxxx
WPS PIN:	xxxxxxx

GENEXIS

Pay careful attention to the URL given for the GUI and make sure you enter it exactly as shown on the label.

If your browser gives you an error message about being unable to “verify the identity of the website ‘router’” or that “your connection is not private” or “there’s a problem with the website’s security certificate”, please choose to continue to load the website.

## 6. Safety & Care

### Operating Conditions

- › Do not operate in temperatures below 0° C or above 40° C

### Safe Operation

- › Never look directly into the end of a fibre optic cable.
- › Use only the supplied power adaptor.
- › Indoor use only.
- › Never expose to or immerse in water.
- › Do not block the air vents (the device will overheat).

### Repair and Service

- › Do not open the housing. There are no user serviceable parts inside.
- › Please contact your service provider if problems arise.

### Care

- › Wipe your DRG over with a soft, dry cloth.
- › Persistent dirt can be removed by wiping with a damp cloth.



This product must not be disposed of in your normal household waste.

Please take it to your regular electronic waste collection and recycling location.

# 7. LAN (network) Setup

## 1. Check your connection

Open a web-browser on your computer and try to visit a web page. For example, load your usual home page or favourite search engine.

If the web page loads, your connection is working properly. Skip the rest of this page and continue to the section on page 10.

## 2. Check your network settings

You need to make sure your computer network settings are set to:

1. Use IPv4
2. Obtain an IP address automatically (DHCP)
3. Obtain DNS server(s) automatically

On a Windows 7 computer choose:

Start ->

Control Panel ->

Network and Internet ->

Network and Sharing Center ->

Change Adapter Settings.

Double click on the correct network adaptor and click on Properties. Select the "Internet Protocol Version 4 (TCP/IPv4)" option and choose Properties.

Ensure "Obtain an IP address automatically" is selected.

Ensure "Obtain DNS server address automatically" is selected.

Close all the control panel windows.

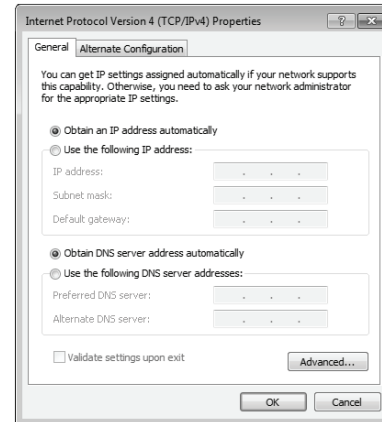

On Mac OS X:

- » Open System Preferences.
- » Click on Network.
- » Click on the Ethernet Adaptor in the left hand panel.
- » Ensure “Configure IPv4” is set to “Using DHCP”.

### 3. Test connection

Try reloading the web page in your browser. If the connection is still not working, please refer to the troubleshooting section.

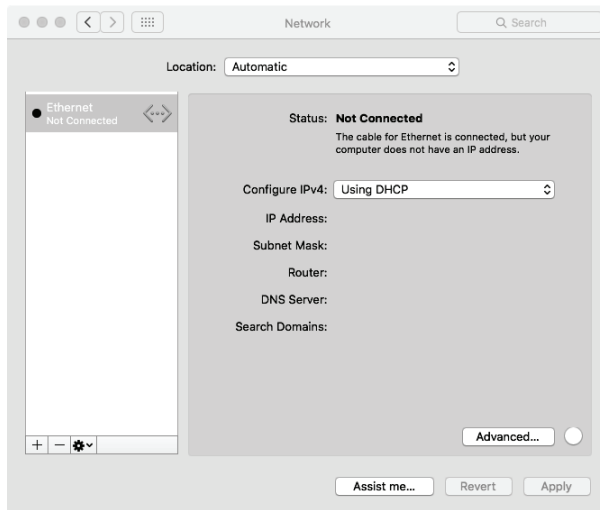

## 8. Wireless Setup \*

In order to set up the wireless connection, you need two pieces of information:

1. The SSID of the DRG.
2. The WPA key for the DRG.

This information can be found on the label included with the DRG (refer to page 2).

DRG7xxxx	
<b>MAC:</b>	00:0F:94:XX:XX:XX
<b>GUI:</b>	https://router
<b>Username:</b>	admin
<b>Password:</b>	xxxxxxxx
<b>SSID:</b>	GNXxxxxxx
<b>WPA KEY:</b>	xxxxxxxxxxxx
<b>WPS PIN:</b>	xxxxxxxx

GENEXIS

On Windows 7:

Start ->

Control Panel ->

Network and Internet ->

Network and Sharing Center

Choose "Setup a new connection or network".

Click on "Connect to the Internet" and click "Next".

Click on "Wireless".

You will then be presented with a list of wireless networks that your computer has detected.

Choose the network whose name matches the SSID on the label included with the DRG (described on page 2).

When prompted for the "network security key", enter the 12 character WPA KEY exactly as printed on the label.



\* not available on all models

Your computer will now connect to the wireless network!

Once successfully connected, the Network and Sharing Center window will change to reflect the new connection status.

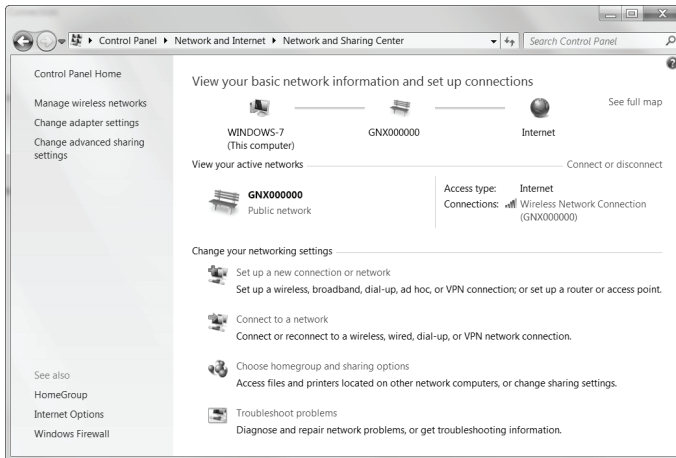



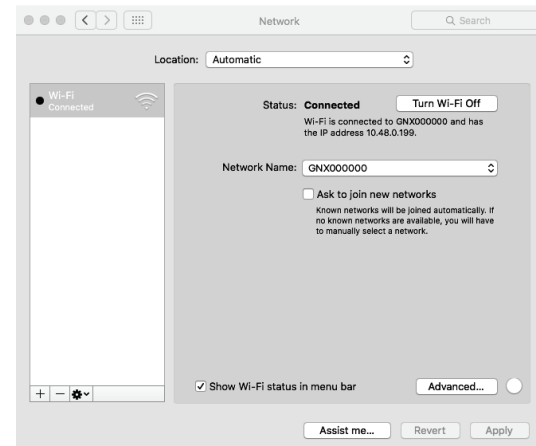

On Mac OS X:

- » Open System Preferences.
- » Click on Network
- » Click on Wi-Fi in the list of interfaces on the left. If necessary, switch Wi-Fi on.
- » In the "Network Name:" drop down box, select the SSID that matches the SSID on the label included with your DRG (see page 2).
- » When prompted for the WPA2 password, enter the WPA key exactly as printed on the label.

You are now connected!



# 9. Troubleshooting







	Issue	Action
	LED is off	Make sure you are using only the power adaptor provided with the DRG, that it is connected to a working power outlet and plugged into the DRG. If applicable, make sure the power button is pushed in.
	LED is red	Turn the device off by removing the power adaptor from the power socket. Wait 1 minute and plug it back in.
	LED is off	There is a problem connecting to your service provider. Turn the DRG off, wait 1 minute and turn it back on again.
	LED is off	CATV is disabled. Please contact your service provider if a television service is part of your subscription.
	LED is red	CATV is enabled but no signal is detected. Please contact your service provider.
	LED is off	The voice service is not enabled. If voice functionality is part of your subscription, contact your service provider.
	LED is off	Use the DRG's web interface to enable WiFi functionality.
Web interface is not reachable:		Make sure the DRG is switched on and the ethernet cable from your computer is plugged into the correct LAN port. Ensure the URL you have entered matches exactly what's shown on the label.
Perform factory reset:		Press and hold the reset button for more than 5 seconds. Once the LEDs start flashing, release the button.

---

If none of these actions resolves your problem, or if the problem persists, please contact your service provider.

---

## Status LEDs

	Activity	Description
	On (green)	Powered up successfully!
	On (red)	System error
	On (flashing green)	System initialising
	Off	No power
	On	Uplink active
	Off	Uplink inactive
	On	Phone line active
	Off	Phone line inactive
	On (green)	CATV enabled, signal received
	On (red)	CATV enabled, no signal received
	Off	CATV disabled
	On	Wi-Fi enabled
	Flashing	WPS active
	Off	Wi-Fi disabled
 (LAN Ports)	Green	1000 Mbps connection
	Yellow	100/10 Mbps connection
	Blinking	Network activity

\* not available on all models

# GENEXIS

©2016 Genexis B.V. Lodewijkstraat 1A, 5652 AC Eindhoven, The Netherlands.

[www.genexis.eu](http://www.genexis.eu)

Rev 1.3