

CONTENTS

Click a title in this table of contents to access the corresponding section

1.	YOUR HERCULES WIRELESS N ACCESS POINT	3
1.1.	Recommendations	3
1.2.	Specifications	3
1.3.	Minimum system requirements	4
1.4.	Box contents.....	4
1.5.	Front face overview	5
1.6.	Connectivity overview	5
2.	INSTALLING YOUR HERCULES WIRELESS N ACCESS POINT	6
2.1.	How to position your Hercules Wireless N Access Point	6
2.2.	Launching the Hercules Wireless N Access Point installation Assistant.....	7
2.3.	Installing Hercules Wireless N Access Point only	8
2.4.	Installing the Hercules pack (Hercules Wireless N Access Point + Wireless N USB Key).....	17
2.5.	Installing the Wireless N USB key only.....	27
2.6.	Exploring the CD-ROM	27
2.7.	Connecting to a network with Wi-Fi Protected Setup™	27
2.7.1.	Connecting to a network in master mode	28
2.7.2.	Connecting to a network in client mode	29
3.	WiFi Manager N, THE VERSATILE UTILITY	30
3.1.	Opening the doors of WiFi Manager N	30
3.2.	Changing the WiFi Manager N password	32
3.3.	Navigating within the WiFi Manager N interface.....	33
3.4.	Resolving any difficulties accessing WiFi Manager N or the Internet	33
3.5.	Mastering your WiFi network at your fingertips	36
3.5.1.	Personalizing your WiFi network	36
3.5.2.	Securing your WiFi network.....	38
3.5.3.	Limiting access to your WiFi network to certain WiFi computers or devices	42
3.6.	A toolbox with multiple facets.....	44
3.6.1.	Restarting your Hercules access point.....	44
3.6.2.	Restoring your original settings	44
3.6.3.	Updating firmware.....	45
4.	WELCOME TO THE WIRELESS ATTITUDE™!	46
4.1.	A few important points to bear in mind before getting started	46
4.2.	Computers running Windows Vista: Sharing folders, a printer or an ADSL connection	46
4.2.1.	Enabling sharing.....	46
4.2.2.	Windows Vista: Sharing public or personal folders	49
4.2.3.	Computers running Windows Vista: Accessing shared folders	51
4.2.4.	Windows Vista: Sharing a printer	51
4.2.5.	Computers running Windows Vista : Accessing the shared printer	54
4.2.6.	Windows Vista: Sharing an ADSL connection in an Infrastructure type network	55
4.3.	Computers running Windows XP: Sharing folders, a printer or an ADSL connection.....	57
4.3.1.	Windows XP: Using the Network Setup Wizard in an Infrastructure network.....	57
4.3.2.	Windows XP: Sharing folders	61
4.3.3.	Windows XP: Accessing shared folders.....	62
4.3.4.	Windows XP: Sharing a printer.....	62
4.3.5.	Windows XP: Modifying a workgroup name.....	64
4.3.6.	Windows XP: Manually enabling or disabling your adapter's WiFi connection (advanced users).....	65

4.4.	Computers running Windows 2000: Sharing folders, a printer or an ADSL connection	65
4.4.1.	<i>Creating a workgroup in Windows 2000</i>	65
4.4.2.	<i>Windows 2000: Sharing folders</i>	66
4.4.3.	<i>Windows 2000: Accessing shared folders</i>	66
4.4.4.	<i>Windows 2000: Sharing a printer</i>	67
4.4.5.	<i>Windows 2000: Modifying a workgroup name</i>	68
4.4.6.	<i>Windows 2000: Sharing an ADSL connection in an Infrastructure network</i>	70
4.4.7.	<i>Windows 2000: Manually enabling or disabling your adapter's WiFi connection (advanced users)</i>	71
4.5.	Computers running Windows Me: Sharing folders, a printer or an ADSL connection	71
4.5.1.	<i>Windows Me: Using the Home Networking Wizard in an Infrastructure network</i>	71
4.5.2.	<i>Windows Me: Sharing folders</i>	73
4.5.3.	<i>Windows Me: Accessing shared folders</i>	74
4.5.4.	<i>Windows Me: Sharing a printer</i>	74
4.5.5.	<i>Windows Me: Modifying a workgroup name</i>	76
4.5.6.	<i>Windows Me: Manually enabling or disabling your adapter's WiFi connection (advanced users)</i>	76
4.6.	Computers running Windows 98 SE: Sharing folders, a printer or an ADSL connection	77
4.6.1.	<i>Windows 98 SE: Creating a workgroup</i>	77
4.6.2.	<i>Windows 98 SE: Sharing folders</i>	77
4.6.3.	<i>Windows 98 SE: Accessing shared folders</i>	78
4.6.4.	<i>Windows 98 SE: Sharing a printer</i>	78
4.6.5.	<i>Windows 98 SE: Sharing an ADSL connection in an Infrastructure network</i>	80
4.6.6.	<i>Windows 98 SE: Manually enabling or disabling your adapter's WiFi connection (advanced users)</i>	81
5.	WIFI MANAGER N FOR ADVANCED USERS	82
5.1.	Configuring your WiFi network's advanced options	82
5.2.	Configuring the DHCP server	83
5.3.	Setting priorities for types of data according to available bandwidth	85
5.4.	Product information	86
6.	GLOSSARY	87
7.	TECHNICAL SUPPORT	91
8.	WARRANTY	91
9.	ENVIRONMENTAL PROTECTION RECOMMENDATION	92

1. YOUR HERCULES WIRELESS N ACCESS POINT

With your Hercules Wireless N Access Point, move up to superior transfer speeds and live a new high-speed wireless communications experience with an extended coverage zone.

Hercules Wireless N Access Point extends the signal from your WiFi equipment or very easily adds the WiFi function to your modem-router. It takes interactivity with users even further by letting you share your Internet access to watch high-definition videos or transfer large files without any hassles. It also allows you to share your devices and data between multiple computers, while at the same time freeing you from the need for kilometers worth of cables.

Great care has been taken in designing your product. Both simple to operate and user-friendly, it is well suited to beginners and advanced users alike.

And now, it's time to learn about your new product and join in the Wireless Attitude™!

1.1. Recommendations

- Never open up your Hercules Wireless N Access Point, as you risk damaging its internal components.
- In order to avoid the risk of fire or electrical discharge, keep your access point away from:
 - rain or humidity, as well as all fluids (water, chemical products and any other liquids),
 - sources of heat such as heaters, stoves and any other heat-producing devices (including amplifiers),
 - direct sunlight.
- Do not cover your access point.
- Unplug the access point's power cable if you do not plan on using it again for an extended period of time. To unplug the power cable, take hold of and pull on the plug. Never pull on the cable itself.
- Disconnect the access point before cleaning. Use a soft cloth for cleaning and avoid using aerosol cleaners.

1.2. Specifications

- Wireless access point compatible with the following WiFi protocols:
 - 802.11b: 1, 2, 5.5 and 11Mbps/s data rates in the 2.4GHz band
 - 802.11g: 6, 9, 12, 18, 24, 36, 48 and 54Mbps/s data rates in the 2.4GHz band
 - 802.11n draft 1.0 and 2.0: data rates in the 2.4GHz band, varying depending on the bandwidth of the channel used (20 or 40MHz). Values are classified from MCS0 to MCS15 and vary from 7.2 to 144.44Mbps/s for 20MHz and from 15 to 300Mbps/s for 40MHz
- **DSSS/CCK** frequency range and **OFDM** modulation from 2.412GHz to 2.484GHz (13 channels)
- Compatible with the following security protocols:
 - **WEP** with 64 and 128-bit key length
 - **WPA-PSK** with TKIP or AES encryption (802.11i security protocol)
 - **WPA2** with TKIP and AES encryption (802.11i security protocol)
- Filtering by **MAC address**
- **WMM** mode support (Wi-Fi MultiMedia™)
- **WPS** (Wi-Fi Protected Setup™)
- LAN mode support
- **802.11n** wireless **access point**
- RF specification: frequency band = 2.4GHz – 2.484GHz

- Maximum transmission power: 100mW
- 2 removable, adjustable 2dBi antennas
- 1 RJ-45 connector for a Fast Ethernet 10/100Mbps connection
- Auto-MDIX support (automatic detection of crossed cabling)
- Conforms to the IEEE 802.3u specification
- IEEE 802.3x flow control support in Full Duplex mode
- External DC power supply. Input: 200~240V, 50/60 Hz; output: 9V DC/1 A



- Blue LEDs on front face
- Software update via Ethernet port

1.3. Minimum system requirements

To access configuration settings:

- Intel Pentium III, AMD Athlon/AMD-K6
- 64MB RAM
- Ethernet 10/100 RJ45 network card
- CD-ROM drive
- Operating system: Microsoft Windows 2000/XP/Vista

To access the Internet:

- Active Internet line
- Internet Explorer 6.0, Netscape Navigator 4.7 or Mozilla Firefox 1.0 or higher
- ADSL Ethernet modem, cable modem, Internet modem-router

1.4. Box contents

Please verify that the following elements are present in your Hercules access point box:

- Hercules Wireless N Access Point
- CD-ROM containing the installation Assistant and User Manual in PDF format
- Quick Start Guide in English
- Ethernet cable
- Power adapter
- Hercules Wireless N USB Key (optional)

1.5. Front face overview



 : Power LED

 : WiFi LED: lit up when the WiFi connection is active. Flashes during data transfer.

LAN : Ethernet LED: the LED is lit up when a device is connected to the corresponding port. The LED flashes during data transfer.

1.6. Connectivity overview

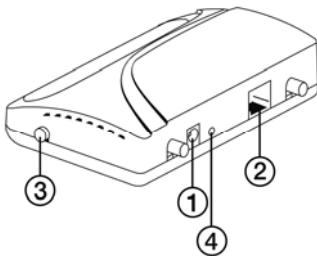

- ① Power plug to connect the power adapter.
- ② One **Ethernet port** allowing your Hercules access point to be connected to a modem-router.
- ③ **WPS** button (Wi-Fi Protected Setup™).
- ④ Return to factory default settings button.

2. INSTALLING YOUR HERCULES WIRELESS N ACCESS POINT

Your Hercules Wireless N Access Point has been designed to be simple to use and install. If you are new to working with wireless products, we invite you to first follow the advice presented in chapters **2.1 to 2.3**. Otherwise, you can proceed directly to chapter **2.4. Launching the Hercules Wireless N Access Point installation Assistant**, which explains how to install your Hercules Wireless N Access Point step by step.

2.1. How to position your Hercules Wireless N Access Point

- Remove the access point and the power adapter from the box.
- Screw the 2 included antennas onto the access point and place them in an upright position.

To help you select the best spot to position your Hercules access point, we are pleased to offer you the following tips, which you may adapt according to your environment (the number of rooms, computers, floors in your home, the presence of any obstacles, the locations of power and telephone plugs...).

- Position the access point near your modem (ADSL, cable or Internet "Box") and a power outlet.
- Try to place your access point in a room centrally located in relation to your other computers and WiFi devices.
- Keep a minimum distance of 2m between the access point and any computers and WiFi devices.
- If you have several computers or WiFi devices on different floors in your home (on the ground floor and the second floor, for example), you should ideally try to place your Hercules access point on the ground floor.



Your access point's WiFi performance may be greatly affected by certain obstacles, such as the presence of paper (a bookcase), metal, water (an aquarium) or a wall made of reinforced concrete between the Hercules access point and any WiFi adapters.

Moreover, do not hesitate to adjust the 2 antennas to different positions in order to achieve optimum reception of the WiFi signal.

2.2. Launching the Hercules Wireless N Access Point installation Assistant

The Assistant, available on the CD-ROM included with the access point, will guide you through the different steps of the installation. To help you with the installation, each of the steps is described below.

- Insert the included CD-ROM into your CD-ROM drive.

The installation Assistant appears automatically.

If the installation menu is not launched automatically:

- Double-click **My Computer** (Windows 2000/XP) or **Computer** (Windows Vista).

- Double-click .

- Double-click **Setup.exe**, if necessary.



The home page prompts you to install the product of your choice.

You can choose to install the **Hercules pack** (composed of the Hercules Wireless N Access Point and the Wireless N USB Key), the **Hercules Wireless N Access Point only** or the **WiFi Station N** software only, which is required for using your Hercules Wireless N Key.

2.3. Installing Hercules Wireless N Access Point only

- Click **Hercules Access point**.



The Assistant will launch the installation procedure for your access point, along with the associated software, Hercules QuickAccess, which will allow you to access the **WiFi Manager N** configuration interface. This interface has been specifically developed by Hercules to set, verify and configure all connection and security settings for Hercules Wireless N series devices.

For more information on **WiFi Manager N**, please refer to section 3. **WiFi Manager N, the versatile utility**.

Step 1: Connecting the power supply

- Connect the Hercules access point's power adapter to the power plug and plug the power adapter into an electrical outlet.



The power LED and the **WiFi LED** light up.

- Click **Next**.

Step 2: Connecting the access point to your computer

- Make sure to disconnect all devices (modem-router, "box") connected to your computer via an Ethernet cable. Connect one end of the included Ethernet cable to the Ethernet port on your Hercules Wireless N Access Point, and the other end of the cable to the Ethernet port on your computer.



The Ethernet LED lights up.

- Click **Next**.

Step 3: Installing QuickAccess

The Assistant prompts you to install **Hercules QuickAccess**, the quick connection utility to **WiFi Manager N**. Click the **Install QuickAccess** button if you wish to install this utility.



You must install QuickAccess in order to be able to configure your access point.

3 Your Access point's cables are now connected and it is ready to be configured.
Hercules QuickAccess is a utility allowing you to easily configure your Access point. To launch installation and configure your Access point, please click the button below.

Install QuickAccess

Connect the Ethernet cable

Step 4: Network name (SSID)

Steps 4 and 5 will allow you to configure your WiFi network.

- Select the name of your WiFi network. Click **Next**.



If you already have a WiFi network, we recommend that you keep the same network name as well as the same security settings. In this way, you will not have to reconfigure all of the computers connected to your old WiFi network.

The screenshot shows a configuration window titled "4 Name of your WiFi network:". The window has a red border and a Hercules logo in the top left corner. The main content area is white with a red border. It contains the following text:

The name of your WiFi network allows you to recognize your network among all those you may be able to receive with your WiFi connection adapter.
The name of this network must not exceed 32 characters.

 If you already have a WiFi network, we recommend that you keep the same network name as well as the same security settings. In this way, you will not have to reconfigure all of the computers connected to your old WiFi network.

Below the text is a text input field labeled "Name of your WiFi network:". At the bottom of the window, there are two red circular buttons: "Install QuickAccess" on the left and "Security type" on the right.

Step 5: Selecting your level of security



Don't forget to protect your network by selecting a level of security combined with a security key. Otherwise, any user, whether malicious or not, will be able to connect to your network.

To find out how to protect your network, please refer to section 3.5.2. **Securing your WiFi network.**

- Select the level of security in the drop-down list.

The screenshot shows a configuration window titled "5 Please select the level of security you wish to put in place." The window has a red border and a Hercules logo in the top left. The main content area is white with a light blue grid background. It contains the following text:

NB: Select the security level according to the level supported by your WiFi adapter. If your computer or WiFi adapter does not support the selected security level, you will not be able to connect to the network.

Security type of your WiFi network

Security level which adapts automatically to the level offered by your adapter:

- WPA (high level)
- WPA2 (very high level).

At the bottom, there are two circular navigation buttons: a left arrow labeled "WiFi settings" and a right arrow labeled "Security key".

Step 6: Choosing the security key

- Choose the security key if you have selected a level of security in the previous step. Click **Next**.



The screenshot shows a configuration window for a Hercules wireless access point. At the top left is the Hercules logo. A grey header bar contains a white circle with the number '6' and the text 'Please select a security key for your WiFi network.' with a close button 'X' on the right. The main content area has a white background with a red border. It contains the following text: 'The security key will then allow you to connect to your WiFi network.' followed by 'We recommend that you make a note of this key, which you will be prompted to enter for any new WiFi computer or device you wish to connect.' Below this is the label 'WiFi security key:' followed by a text input field. Underneath the field is the instruction 'Enter a password composed of 8 to 63 alphanumeric characters.' At the bottom left is a red circular button with a white left-pointing arrow, labeled 'Security type'. At the bottom right is a red circular button with a white right-pointing arrow, labeled 'Router connection'.

Step 7: Connecting the access point to the modem-router

- If necessary, disconnect the access point's power supply (if your modem-router is located in another room, for example, you will have to move your access point close to it to connect it via Ethernet).
- Disconnect the Ethernet cable from the computer.
- If necessary, reconnect the access point's power supply.
- Connect one end of the included Ethernet cable to the Ethernet port on your Hercules Wireless N Access Point, and the other end to the Ethernet port on your modem-router.

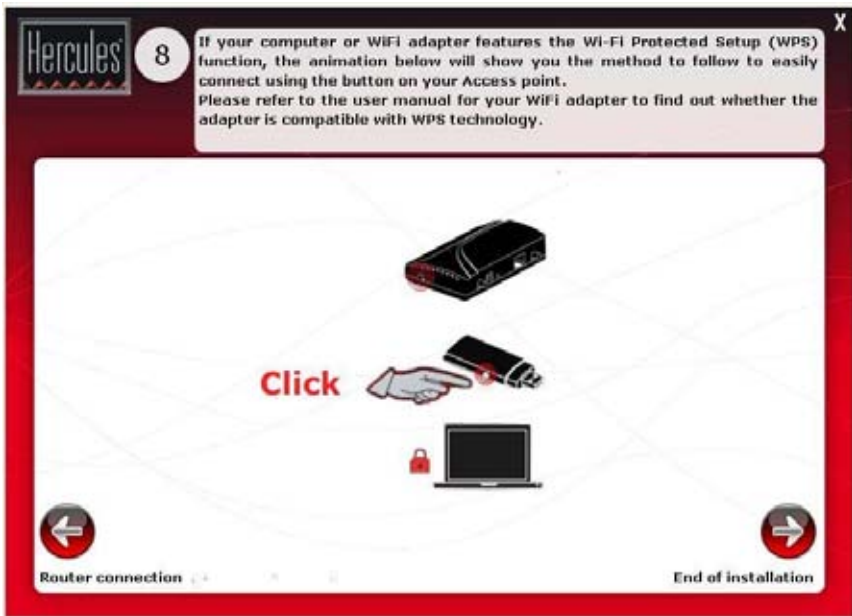

Step 8: WPS connection

Installation of your **Hercules Wireless N Access Point** is almost complete. Before learning about advanced functionalities and moving on to practical applications, the screen shown above demonstrates how you can connect very easily using **WPS**. Click **Next** to complete the installation.

End of installation

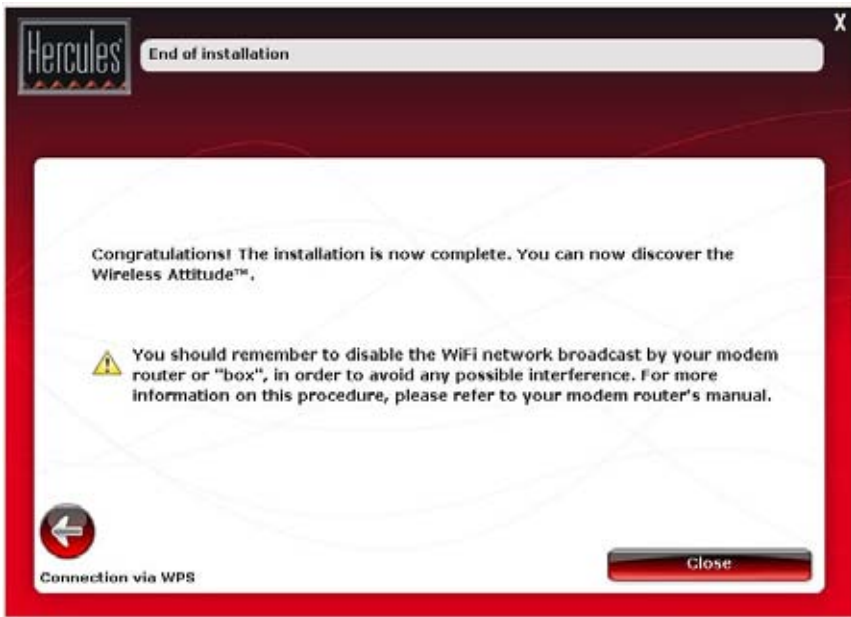

In order to avoid any interference, you should now disable your modem-router's WiFi network, if your access point's WiFi network settings are the same as those of your modem-router's WiFi network. For more information on this procedure, please refer to your modem-router's manual.

For more information on connecting using WPS, please refer to section [2.7. Connecting to a network with Wi-Fi Protected Setup™](#).

To learn about all of your product's advanced functionalities, please refer to section [3. WiFi Manager N, the versatile utility](#).

To learn about practical applications for your WiFi devices, please refer to section [4. Welcome to the Wireless Attitude™](#).

2.4. Installing the Hercules pack (Hercules Wireless N Access Point + Wireless N USB Key)

- Click **Hercules Access point and WiFi USB Key pack**.



The Assistant will successively launch installation of your access point and your Key, as well as of the associated software (**WiFi Manager N** for the Hercules Wireless N Access Point and **WiFi Station N** for the Hercules Wireless N USB Key), specifically developed by Hercules to set, verify and configure all connection and security settings for Hercules Wireless N series devices.

For more information regarding **WiFi Manager N**, please refer to section 3. **WiFi Manager N, the versatile utility**.

For more information regarding **WiFi Station N**, please refer to the PDF manual for your **Hercules Wireless N USB Key**.

Step 1: Connecting the power supply

- Connect the Hercules access point's power adapter to the power plug and plug the power adapter into an electrical outlet.



The power LED and the **WiFi LED** light up.

- Click **Next**.

Step 2: Connecting the access point to your computer

- Make sure to disconnect all devices (modem-router, "box") connected to your computer via an Ethernet cable. Connect one end of the included Ethernet cable to the Ethernet port on your Hercules Wireless N Access Point, and the other end of the cable to the Ethernet port on your computer.



The Ethernet LED lights up.

- Click **Next**.

Step 3: Installing QuickAccess

The Assistant prompts you to install **Hercules QuickAccess**, the quick connection utility to **WiFi Manager N**. Click the **Install QuickAccess** button if you wish to install this utility.



You must install QuickAccess in order to be able to configure your access point.

Hercules 3 Your Access point's cables are now connected and it is ready to be configured. Hercules QuickAccess is a utility allowing you to easily configure your Access point. To launch installation and configure your Access point, please click the button below.

WiFi Manager N

Install QuickAccess

Connect the Ethernet cable

Step 4: Network name (SSID)

Steps 4 and 5 will allow you to configure your WiFi network.

- Select the name of your WiFi network. Click **Next**.



If you already have a WiFi network, we recommend that you keep the same network name as well as the same security settings. In this way, you will not have to reconfigure all of the computers connected to your old WiFi network.

The screenshot shows a configuration window titled "Hercules" with a step indicator "4" and the label "Name of your WiFi network:". The window has a red border and a close button "X" in the top right corner. The main content area contains the following text:

The name of your WiFi network allows you to recognize your network among all those you may be able to receive with your WiFi connection adapter.
The name of this network must not exceed 32 characters.

 If you already have a WiFi network, we recommend that you keep the same network name as well as the same security settings. In this way, you will not have to reconfigure all of the computers connected to your old WiFi network.

Below the text is a text input field labeled "Name of your WiFi network:". At the bottom of the window, there are two navigation buttons: "Install QuickAccess" with a left-pointing arrow and "Security type" with a right-pointing arrow.

Step 5: Selecting your level of security



Don't forget to protect your network by selecting a level of security combined with a security key. Otherwise, any user, whether malicious or not, will be able to connect to your network.

To find out how to protect your network, please refer to section **3.5.2. Securing your WiFi network**.

- Select the level of security in the drop-down list.

The screenshot shows a configuration window for a Hercules wireless network. At the top left is the Hercules logo. A grey header bar contains a circle with the number '5' and the text 'Please select the level of security you wish to put in place.' Below this is a white box with a red border containing the following text: 'NB: Select the security level according to the level supported by your WiFi adapter. If your computer or WiFi adapter does not support the selected security level, you will not be able to connect to the network.' Underneath is a label 'Security type of your Wifi network' followed by a dropdown menu showing 'WPAWPA2'. Below the dropdown is the text 'Security level which adapts automatically to the level offered by your adapter:' followed by a list: '- WPA (high level)' and '- WPA2 (very high level)'. At the bottom left is a red circular button with a white left-pointing arrow labeled 'WiFi settings'. At the bottom right is a red circular button with a white right-pointing arrow labeled 'Security key'.

Step 6: Choosing the security key

- Choose the security key if you have selected a level of security in the previous step. Click **Next**.



The screenshot shows a configuration window for the Hercules Wireless N Access Point. The window has a red border and a dark red background. At the top left is the Hercules logo. To its right is a white circle containing the number '6'. Further right is a grey bar with the text 'Please select a security key for your WiFi network.' and a close button 'X' on the far right. The main content area is white and contains the following text: 'The security key will then allow you to connect to your WiFi network.' followed by 'We recommend that you make a note of this key, which you will be prompted to enter for any new WiFi computer or device you wish to connect.' Below this is the label 'WiFi security key:' followed by a text input field. Underneath the input field is the instruction 'Enter a password composed of 8 to 63 alphanumeric characters.' At the bottom left is a red circular button with a white left-pointing arrow, labeled 'Security type'. At the bottom right is a red circular button with a white right-pointing arrow, labeled 'Router connection'.

Step 7: Installing WiFi Station N

- Click **Install WiFi Station N**.

The *WiFi Station N installation Assistant* then starts up to launch installation of your Hercules Wireless N USB Key. Follow the on-screen instructions.



For more information on installing **WiFi Station N**, please refer to the PDF manual for your **Hercules Wireless N USB Key**.



7

This step will allow you to install the WiFi Key included with your Access point. In order to make your key functional, we recommend that you install the WiFi Station N software, which will allow you to manage all aspects of your connection to various wireless networks. To proceed with this installation, please click the "Install WiFi Station N" button.

X



Security key

Step 8: Connecting the access point to the modem-router

- If necessary, disconnect the access point's power supply (if your modem-router is located in another room, for example, you will have to move your access point close to it to connect it via Ethernet).
- Disconnect the Ethernet cable from the computer.
- If necessary, reconnect the access point's power supply.
- Connect one end of the included Ethernet cable to the Ethernet port on your Hercules Wireless N Access Point, and the other end to the Ethernet port on your modem-router.

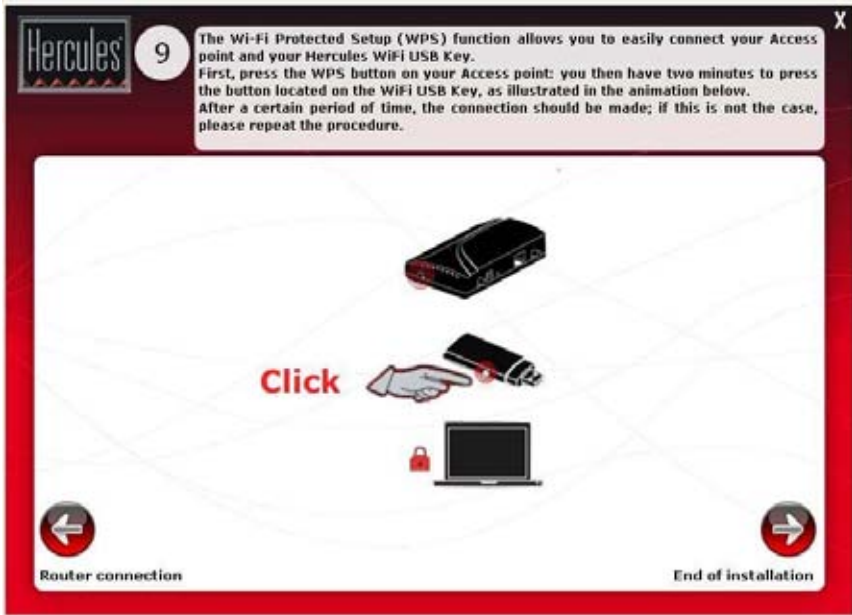

Step 9: WPS connection

Installation of your **Hercules Wireless N Access Point/Hercules Wireless N USB Key** is almost complete. Before learning about advanced functionalities and moving on to practical applications, the screen shown above demonstrates how you can connect very easily using **WPS**. Click **Next** to complete the installation.

End of installation

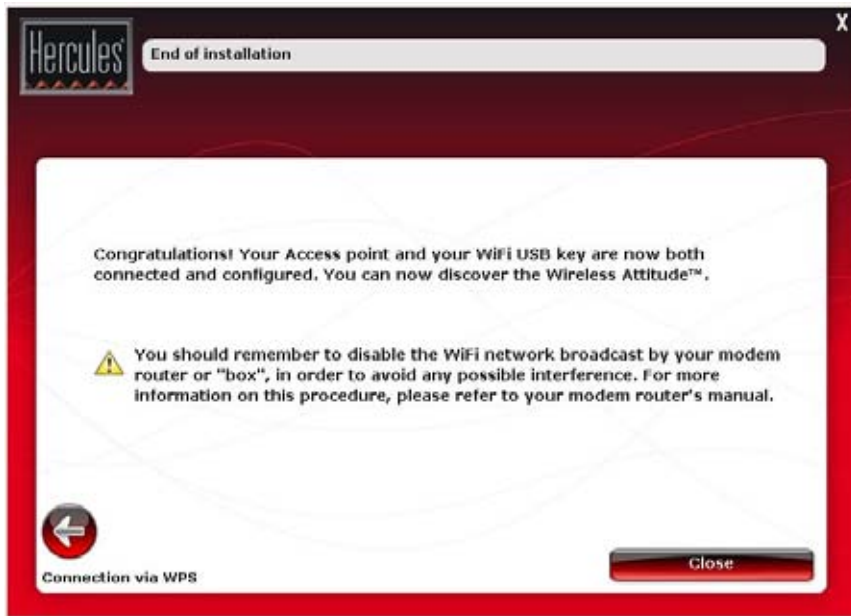

In order to avoid any interference, you should now disable your modem-router's WiFi network, if your access point's WiFi network settings are the same as those of your modem-router's WiFi network. For more information on this procedure, please refer to your modem-router's manual.

For more information on connecting using WPS, please refer to section [2.7. Connecting to a network with Wi-Fi Protected Setup™](#).

To learn about all of your product's advanced functionalities, please refer to section [3. WiFi Manager N, the versatile utility](#) or section [4. The WiFi Station N utility](#) in the PDF manual for your Hercules Wireless N Key.

To learn about practical applications for your WiFi devices, please refer to section [4. Welcome to the Wireless Attitude™](#).

2.5. Installing the Wireless N USB key only

To install the Wireless N USB Key:

- Click **Hercules WiFi N USB Key**.

The *WiFi Station N installation Assistant* is launched. Follow the on-screen instructions



For more information on installing **WiFi Station N**, please refer to the PDF manual for your **Hercules Wireless N USB Key**.

2.6. Exploring the CD-ROM



- Click the button.

The CD-ROM's tree structure is displayed in the new window. You can browse through the contents of the different folders.

2.7. Connecting to a network with Wi-Fi Protected Setup™

If connecting to a WiFi network and configuring it seems like too much trouble to you, you can use the integrated **WPS (Wi-Fi Protected Setup™)** functionality, indicated on the product or packaging by one of the following logos:



What is WPS (Wi-Fi Protected Setup™) ?

WPS is a technology which simplifies the connection procedure to a wireless network between a WPS-compatible device (your **Hercules Wireless N Key**, for example) and your **Hercules Wireless N Access Point**. Different connection methods are available to you: simply click a button located on the access point or in WiFi Manager N, or enter the PIN code of the device to be connected (your **Hercules Wireless N Access Point** or your **Hercules Wireless N Key**, for example) in the WiFi Manager N interface.

About master and client modes

To get a better understanding of the two connection modes via WPS, it is important to grasp the concepts of **master** and **client**. In **master** mode, the WPS device (your **Hercules Wireless N Access Point**, for example) is the access point to which other WPS devices will connect (your **Hercules Wireless N Key** or another WPS device). In **client** mode, it is the WPS device (your **Hercules Wireless N Key** or another WPS device) which connects to the master (your **Hercules Wireless N Access Point**).

Note: The procedure detailed hereafter describes **connecting your Hercules Wireless N Access Point with the Hercules Wireless N USB Key**; however, you can also connect other WPS devices. Should you wish to do so, please refer to your WPS device's user manual.





In order to enjoy using a simplified connection thanks to the **WPS (Wi-Fi Protected Setup™)** functionality, devices which will be connecting to your Access Point must be WPS-compatible and certified.

2.7.1. Connecting to a network in master mode

Note: by default, your **Hercules Wireless N Access Point** is configured to **master mode**, meaning that it will serve as the access point to which other WPS devices will be able to connect.

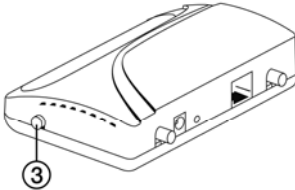
1st option: use the WPS button located on the Access Point



- On your WiFi access point: press the **WPS** button  located on the side of the access point.

You now have two minutes to connect your Hercules Wireless N USB Key to the access point. You will not have to repeat this step the next time you connect.

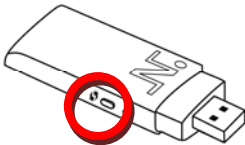

- Press the **WPS** button located on the side of the Hercules Wireless N Key or the **WPS** button on a **WPS-compatible** device.

2nd option: use the WPS button accessible in WiFi Manager N



- On the WiFi Manager N home page, press the **Automatic WiFi client connection (WPS)** button.

Push-Button Configuration method (PBC) is selected by default.

- Click the  connection button.

Alternatively:

- Select **Personal Identification Number method (PIN code)**.

- Enter the **PIN** code of the WPS device you wish to connect.

- Click the  connection button.

*To find out the **PIN** code for your WPS device, please refer to section 4.3.3. **Connecting to a network with a PIN code** in the user manual of your **Hercules Wireless N USB Key**, or refer to the manual supplied by the manufacturer of your WPS device.*

You now have two minutes to connect your Hercules Wireless N USB Key or your device via WPS.

If the connection is not secure, a **WPA** or **WPA2** type security key (depending on the client's capabilities) is generated automatically.

For more information on connecting your device via WPS, please refer to the PDF user manual of your **Hercules Wireless N USB Key** or to the manual supplied by the manufacturer of your WPS device.

2.7.2. Connecting to a network in client mode

Note: by default, your **Hercules Wireless N Access Point** is configured to **master mode**, meaning that it will serve as the access point to which other WPS devices will be able to connect. By switching to **client mode**, your access point will connect to a master WPS device which will become the access point. You should be aware, however, that your **Hercules Wireless N Access Point**, with its access point function, is not meant to connect to other WPS devices.



- On the WiFi Manager N home page, press the **Automatic WiFi client connection (WPS)** button.

- Click the **Advanced settings** button.

Two options are available to you: **Master mode** or **Client mode**.

- Select **Client mode**.

WiFi Manager N displays the PIN code for your Hercules Wireless N Access Point. Make a note of this code, as you will have to enter it in the client's interface in order to connect your Access Point to other devices.

3. WIFI MANAGER N, THE VERSATILE UTILITY

With WiFi Manager N, nothing could be easier than combining your high-speed Internet modem-router with the Hercules access point, thereby sharing your Internet access with all of the computers in your home or small business, or simply creating a wireless network.

WiFi Manager N is the interface which allows you to communicate with your Hercules access point and configure your wireless network or Internet firewall.

3.1. Opening the doors of WiFi Manager N

The Installation Assistant you have launched from the CD-ROM has installed a connection utility on your Desktop, called "**Hercules QuickAccess**". This utility will bring you straight to the door (locked with a key, for the moment) to WiFi Manager N.



- To access the door to enter WiFi Manager N, simply double-click the **Hercules QuickAccess** icon on your Desktop.

The connection window to the access point appears.



Or, if you have chosen not to install the QuickAccess icon:

You must switch to "fixed IP address" mode:

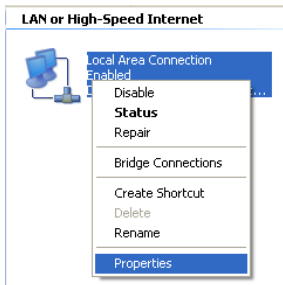

1. Click **Start/Control Panel**. Double-click **Network Connections**.
2. In the **LAN or High-Speed Internet** section, right-click the icon corresponding to your wireless network connection (or to the network Bridge, if you have created one) and select **Properties**.
3. In the **General** tab of the **Wireless Network Connection Properties** window, scroll down the list, and select and highlight the **Internet Protocol (TCP/IP)** entry.



4. Click **Properties**, and select **Use the following IP address**.

*An **IP address** is a unique address assigned by the modem-router to the computer. Each computer has its own identity, via its IP address, allowing it to be identified within the network. The access point's IP address is **192.168.2.254** by default.*

5. Enter an **IP address** in the same subnet range (for example: 192.168.2.10).
6. Enter the subnet mask **255.255.255.0**.
7. Click **OK** to close the windows, then exit the **Control Panel**.

The modem-router will now assign this IP address to your computer.

You are now at the door to enter WiFi Manager N, which you must open using a password.

- To open the door, enter the default password or enter your own password if you have already defined one (for information on how to define your own password, please refer to chapter [3.2. Changing the WiFi Manager N password!](#)).

- Click **Connection**.



The password ensures that you are the only one who can access your WiFi Manager N interface, and therefore your Hercules access point's settings. For this reason, it is important that you change the password when using WiFi Manager N for the first time (see below).

3.2. Changing the WiFi Manager N password

When opening the door to WiFi Manager N for the first time, we strongly recommend that you change the default password, **123456**, during your first use directly via the **Connect to Access point** window.



- Click the **Change password** button.
- Enter the **old** password (**123456**, if you are doing this for the first time), the **new** password, which you will select, and then **confirm** the new password.
- Click **Confirm and Connect** to store your new password and connect.

The door to WiFi Manager N opens to the **Home page** depicted below. You can now explore all of your Hercules access point's functionalities.



3.3. Navigating within the WiFi Manager N interface

The **WiFi Manager N** interface has been designed to simplify navigation through the different menus. Nevertheless, should you ever feel a bit lost, you can always click the **General settings** button at any time to return to the Home page, the starting point for all of your Hercules access point's functionalities.

3.4. Resolving any difficulties accessing WiFi Manager N or the Internet

If you have not managed to connect to the WiFi Manager N interface via QuickAccess:

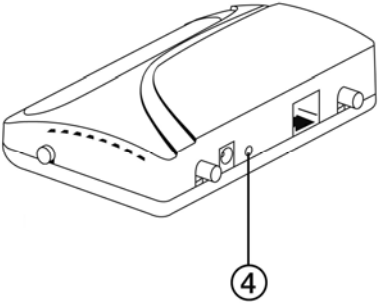
	<ul style="list-style-type: none"> - Press the Reset button ④ for 10 seconds using an object with a pointed tip. - Release the button, then wait. <p><i>Your access point will load its original settings and then restart.</i></p>
---	--

If you have not managed to connect to the Internet, your computer's settings may not be properly configured. The instructions below will help you to resolve this problem.

Note: the access paths mentioned below may vary slightly if you have modified the default display configuration in Windows XP or Vista (meaning the **Start** menu properties and **Control Panel** display).

Windows XP or Vista

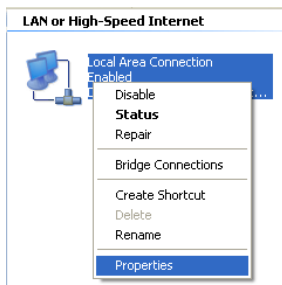

1. Click **Start/Control Panel**. Double-click **Network Connections**.
2. In the **LAN or High-Speed Internet** section, right-click the icon corresponding to your wireless network connection (or to the network Bridge, if you have created one) and select **Properties**.
3. In the **General** tab of the **Wireless Network Connection Properties** window, scroll down the list, and select and highlight the **Internet Protocol (TCP/IP)** entry.



4. Click **Properties**, select **Obtain an IP address automatically** and **Obtain DNS server address automatically**.
5. Click **OK** to close the windows, then exit the **Control Panel**.

The modem-router will now be able to assign an IP address to your computer.

An **IP address** is a unique address assigned by the modem-router to the computer. Each computer has its own identity, via its IP address, allowing it to be identified within the network.

Windows 2000



1. Click **Start/Settings/Control Panel**. Double-click **Network and Dial-Up Connections**.
2. Right-click the appropriate connection and select **Properties**.
3. In the **General** tab, highlight **Internet Protocol (TCP/IP)**.

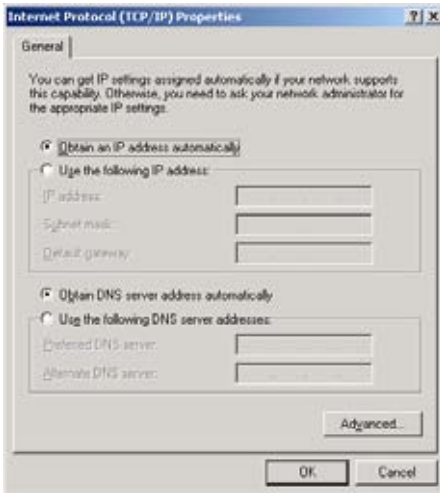

4. Click **Properties** and select **Obtain an IP address automatically** and **Obtain DNS server address automatically**.
5. Click **OK** to close the windows, then exit the **Control Panel**.

The modem-router will now be able to assign an IP address to your computer.

An **IP address** is a unique address assigned by the modem-router to the computer. Each computer has its own identity, via its IP address, allowing it to be identified within the network.

Windows 98 SE/Me



1. Click **Start/Settings/Control Panel**. Double-click **Network**.
2. In the **Configuration** tab of the **Network** window, highlight the name of your network adapter.



3. Click **Properties** and select **Obtain an IP address automatically** in the **IP Address** tab.
4. Click **OK** to close the windows, then exit the **Control Panel**.

The modem-router will now be able to assign an IP address to your computer.

An **IP address** is a unique address assigned by the modem-router to the computer. Each computer has its own identity, via its IP address, allowing it to be identified within the network.

3.5. Mastering your WiFi network at your fingertips

In this chapter, you will learn how to personalize your WiFi network and secure it against unwelcome intrusion attempts.



Configuration of your network is carried out via the Ethernet cable connecting your access point to your computer. Once you have finished, you can disconnect this cable and explore all the subtleties of WiFi, described in chapter 4. **Welcome to the Wireless Attitude™!**

3.5.1. Personalizing your WiFi network

When the wireless access point (your Hercules access point's WiFi function) is enabled, WiFi Manager N displays the name of your network, the Radio Frequency (RF) channel and security type used. These settings may be modified, subject to certain conditions.



Should you decide to modify certain settings, we recommend that you take care to follow the recommendations below.

To personalize your WiFi network:



- On the Home page, select **Your WiFi connection settings**.

Various items of information are displayed, such as the name of your network and the RF channel used.

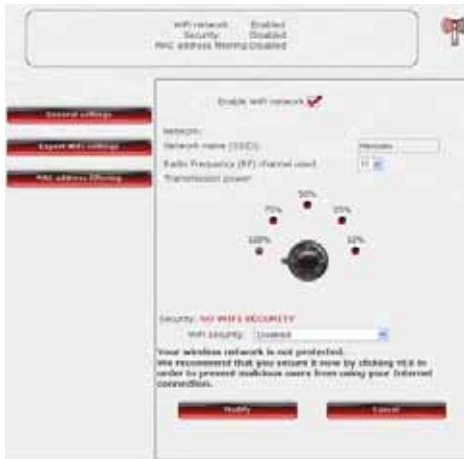

- If you wish, you may personalize the **Network name (SSID)** (Hercules, by default).

*The SSID (Service Set Identifier) is the unique name shared by the WiFi adapters and the access point in a wireless network. **Make sure that you do not lose or forget this name, as you will need it to connect your WiFi devices.***

- Select the transmission power (100 % by default).

- If necessary, change the **Radio Frequency (RF) channel** used by the local area WiFi network to communicate (from 1 to 13).

*Change this setting **only if another transmitter is using the same channel, which may result in a drop in your access point's WiFi performance.***



Don't forget to protect your network by selecting a security key; otherwise, any user, whether with bad intentions or not, will be able to connect to it.

For details on how to protect your network, please refer to section **3.5.2. Securing your WiFi network**.

- Click the **Modify** button to validate your settings.

The access point restarts. All computers or devices connected via WiFi are disconnected. The ADSL connection, however, remains active.



3.5.2. Securing your WiFi network

Creating a WiFi network is very useful if you have several wireless computers or devices, but how can you avoid having someone on the outside connect to your network without permission or intercept your unencrypted data exchanges? Thanks to the WiFi Manager N, you can define your own security choices. To help you select the best level of security for your network, we invite you to consult the table below, which sums up the **5 types of security** supported by WiFi Manager N.

Type	Level of security	Key used	Authentication
WEAK (WEP 64)	The lowest level of security, whereby simple encryption is carried out on exchanged data. Each wireless client in the network must use the same key to decode the transmission.	<p>64-bit key in hexadecimal format (10 characters), or in alphanumeric format with 5 ASCII characters (e.g.: <i>hello</i>).</p> <p>A hexadecimal key is composed of numbers 0 to 9 and letters A to F (example: <i>A123BCD45E</i> for a 64-bit key).</p> <p>An alphanumeric character corresponds either to a number (0-9), or to a letter (a-z or A-Z).</p>	Open (no authentication), Shared (authentication method via shared key) or Auto (authentication when requested by the device).
MEDIUM (WEP 128)	Level of security identical to that of WEP 64. Only the key length is different.	<p>128-bit key in hexadecimal format (26 characters), or in alphanumeric format with 13 ASCII characters.</p> <p>A hexadecimal key is composed of numbers 0 to 9 and letters A to F.</p> <p>An alphanumeric character corresponds either to a number (0-9), or to a letter (a-z or A-Z).</p>	Open (no authentication), Shared (authentication method via shared key) or Auto (authentication when requested by the device).
Type	Level of security	Key used	Authentication
HIGH (WPA-PSK)	Latest-generation heightened level of security, specially designed for environments such as a small office or the home, based on a pre-shared key.	<p>Password with a minimum of 8 alphanumeric characters.</p> <p>An alphanumeric character corresponds either to a number (0-9), or to a letter (a-z or A-Z).</p>	TKIP
VERY HIGH (WPA2)	Latest-generation very heightened level of security, specially designed for environments such as a small office or the home, based on a pre-shared key.	<p>Password with a minimum of 8 alphanumeric characters.</p> <p>An alphanumeric character corresponds either to a number (0-9), or to a letter (a-z or A-Z).</p>	AES

WPA ou WPA2	Level of security selected by the access point depending on the maximum level of security supported by the devices on the network.	Password with a minimum of 8 alphanumeric characters . <i>An alphanumeric character corresponds either to a number (0-9), or to a letter (a-z or A-Z).</i>	TKIP or AES
--------------------	--	---	---------------------------



You must not select a level of security in WiFi Manager N more advanced than that supported by your computers or other WiFi devices. For example, if your computers or other devices only support the **WEAK (WEP 64)** or **MEDIUM (WEP 128)** levels, you should not select the **HIGH (WPA-PSK)** or **VERY HIGH (WPA2)** level.



If you have used the **WPS** function to connect, a **WPA** or **WPA2** type security key has automatically been generated.

To secure your WiFi network:



- Select your level of security: **MEDIUM** (WEP 128), **HIGH** (WPA) or **VERY HIGH** (WPA2).

If you select the "VERY HIGH (WPA2)" security type:

- Select the level of security: **WPA2 (AES)**.
- Enter a **password** (8 alphanumeric characters minimum) or a **key** with 64 hexadecimal characters.

An alphanumeric character corresponds either to a number (0-9), or to a letter (a-z or A-Z).

A hexadecimal key is composed of numbers 0 to 9 and letters A to F (example: A123BCD45E for a 64-bit key).

In the status zone, you can consult the overview of your WiFi settings. Make a note of the network name, security type and key used.

- Click **Modify** to validate the new settings.

If you select the "VERY HIGH (WPA-WPA2)" security type:

- Select the level of security: **WPA-WPA2**.
- Enter a **password** (8 alphanumeric characters minimum) or a **key** with 64 hexadecimal characters.

An alphanumeric character corresponds either to a number (0-9), or to a letter (a-z or A-Z).

A hexadecimal key is composed of numbers 0 to 9 and letters A to F (example: A123BCD45E for a 64-bit key).

In the status zone, you can consult the overview of your WiFi settings. Make a note of the network name, security type and key used.

- Click **Modify** to validate the new settings.

If you select the "HIGH (WPA)" security type:

WPA security: WPA-PSK (TKIP) security

Hexadecimal value

Enter a key composed of 64 hexadecimal characters (numbers from 0-9 and letters from A to F).

WPA-PSK is a high level of security based on a pre-shared key. Random encryption has been improved: one password is all you need; there's no complicated key to remember!

WARNING: if your WiFi equipment installed in your computers does not support the WPA security level, you must select another level of security for your router, otherwise your computers will not be able to connect.

WiFi network:	Enabled
Security:	WPA-PSK (TKIP) security
MAC address filtering:	Disabled

- Enter a **password** with 8 alphanumeric characters minimum, or a **key** with 64 hexadecimal characters of your choice.

An alphanumeric character corresponds either to a number (0-9), or to a letter (a-z or A-Z).

A hexadecimal key is composed of numbers 0 to 9 and letters A to F (example: A123BCD45E for a 64-bit key).

In the status zone, you can consult the overview of your WiFi settings. Make a note of the network name, security type and key used.

- Click **Modify** to validate the new settings.

If you select the "MEDIUM (WEP 64-WEP 128)" security type:

Security level: WEP64

Hexadecimal value

Enter a key composed of 10 hexadecimal characters (numbers from 0-9 and letters from A to F) if you have selected WEP64, or 26 characters if you have selected WEP128.

The WEP 64 level is the first level of security, whereby single encryption is carried out on exchanged data. Each network computer connected via WiFi must use the same key to decode the transmission. The security key is in 64-bit format; it is therefore a hexadecimal key with exactly 10 characters. The WEP 128 level is the second level of security, whereby encryption is carried out on exchanged data. Each network computer connected via WiFi must use the same key to decode the transmission. The security key is in 128-bit format; it is therefore a hexadecimal key with exactly 26 characters. WARNING: if the WiFi equipment installed in your computers only supports WEP 64 security, you must select the same security level for your router, or else your computers will not be able to connect to it.

WiFi network:	Enabled
Security:	WEP security
MAC address filtering:	Disabled

- Enter a **key** with 10 hexadecimal characters or a **password** with 5 alphanumeric characters for **WEP 64** security, or a key with 26 hexadecimal characters or a password with 13 alphanumeric characters for **WEP 128** security.

A hexadecimal key is composed of numbers 0 to 9 and letters A to F (example: A123BCD45E for a 64-bit key).

An alphanumeric character corresponds either to a number (0-9), or to a letter (a-z or A-Z).

In the status zone, you can consult the overview of your WiFi settings. Make a note of the network name, security type and key used.

- Click **Modify** to validate the new settings.

If you select NO (Disabled) security (not recommended):



If you don't apply any security, your network will not be protected. Any user, whether with bad intentions or not, will be able to connect to it.

In the status zone, you can consult the overview of your WiFi settings. Make a note of the network name, security type and key used.

- Click **Modify** to validate the new settings.

3.5.3. Limiting access to your WiFi network to certain WiFi computers or devices

Filtering by **MAC address** is a complement to your security settings, allowing you to select the wireless computers and devices authorized to connect to your local area WiFi network.

A **MAC address** is a unique address created by the builder of the network device (WiFi or Ethernet), serving to identify this element within a network.



Before enabling filtering, we recommend that you connect via WiFi all computers you wish to authorize.

To enable filtering by MAC address:



- Click the **Enable MAC address filtering** button.



- Tick the **Enable MAC address filtering** box.

To add a WiFi computer or device (webcam, game console or other) to the list:

If you are using this function for the first time:

Any new computer or device must be added manually.

- Manually enter its MAC address (in AAAAAAAAAAAA format, without separators).

- Click the **Add** button.

This address has been added to the list of WiFi computers and devices authorized to connect.

- If you wish, add a comment in the corresponding zone.

- Click the **Modify** button to validate your settings, or **Cancel** to cancel the settings you have entered.

Remove	MAC address	comment
	00:0F:2D:44:55:99	Hercules



Once you have enabled the filtering by MAC address function, **only** the computers and devices appearing in this list will be authorized to connect to your Hercules access point.



If your friends visit you with their WiFi computer or device, or if you wish to connect new WiFi devices, don't forget to **add their MAC address** to the filtering list, or else they will never be able to connect.

To remove a WiFi computer or device (webcam, game console or other) from the list:

Remove	MAC address	comment
	00:0F:2D:44:55:99	Hercules

- In the **Remove** column, click next to the computers or devices you wish to remove from the filtering list.

- Confirm the removal in the dialog box which appears.

- Click the **Modify** button to validate your settings, or **Cancel** to cancel the settings you have entered.

3.6. A toolbox with multiple facets

WiFi Manager N functions as a toolbox which can help you to correct any mistakes you might make.

3.6.1. Restarting your Hercules access point

The **Restart the access point** function cuts off the Hercules access point's WiFi function and restarts WiFi Manager N.



Any computer or device connected via WiFi or Ethernet will be disconnected.

To restart the access point:



- On the home page, click the **Toolbox** button.



- Select **Restart the access point**.

An explanatory text explains the function of this button.

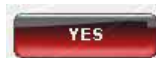

- Click **YES** to confirm the restart.



The access point restarts with the last settings saved. No data is lost.

3.6.2. Restoring your original settings

If you have modified certain settings – whether intentionally or not – and wish to restore the original settings, follow the instructions below.



During the restoration, all settings that you have previously modified (WiFi security key, filtering by MAC address...) will be lost!

To restore the original settings:



- On the home page, click the **Toolbox** button.



- Select **Restore original settings**.



- Click **YES** to confirm restoration of the original settings.

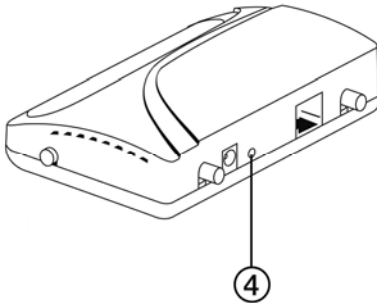

You can also use the Reset button located on the access point:

- Press the **Reset button** ④ for 10 seconds using an object with a pointed tip.
- Release the button, then wait.

Your access point will load its original settings and then restart.

3.6.3. Updating firmware

If you wish to take advantage of new functionalities or improved functionalities for your Hercules access point, we recommend that you regularly visit the www.hercules.com website to check whether any firmware updates are available.



We strongly recommend that you carry out firmware updates while connected by the Ethernet cable (and not via WiFi).



During the update, all settings that you have previously modified (WiFi security key...) will be lost!

If a firmware update is available:

- On the www.hercules.com website, click the **Support/FAQ** link.
- Follow the on-screen instructions provided. Then:



- On the WiFi Manager N homepage, click the **Toolbox** button.
- Select **Update firmware**.
- Click the **Browse** button.
- Select your firmware file, then click **Open**.
- Click **Update** to import the data.

Your Hercules access point will now use this new firmware version.

4. WELCOME TO THE WIRELESS ATTITUDE™!

Now that you have mastered the main functionalities of WiFi Manager N, it is time to move on to a few practical applications. In the following chapters, we will show you how wireless computing is closely linked to user-friendliness and ease of use. Sharing your folders, your printer, or letting friends use your ADSL connection for online gaming are some examples of the things we will help you to do. Enter the world of wireless and join in the **Wireless Attitude™!**

4.1. A few important points to bear in mind before getting started

We advise you to follow the instructions provided hereinafter for each of your computers:

- The procedures described in this chapter differ according to the various operating systems discussed. Please ensure that you refer to the chapters corresponding to your operating system.
- These procedures also apply to the computer or device directly connected to your access point via an Ethernet cable.
- To share an Internet connection, your Hercules access point and your modem (ADSL Ethernet, cable or Internet "Box") must be switched on and your Internet line must be active.

Reminder: the WiFi network you have just finished setting up is an **Infrastructure** type network (as opposed to **Ad hoc** mode), as it is composed of an **access point** and one or more computers.

4.2. Computers running Windows Vista: Sharing folders, a printer or an ADSL connection



To create a network of computers, share data, a printer or an **ADSL** connection between computers running **Windows Vista**, it is not imperative that the computers belong to the same **workgroup**. However, if you wish to share between **Windows Vista** and an earlier operating system, make sure to define the same workgroup on all computers. For information on how to create a workgroup, please refer to the manual of your Hercules product.

Note: The access paths described hereafter may vary slightly if you have modified the default display in Windows Vista (that is to say, the Start menu properties and the Control Panel display).

You have connected your computer to a **private network** (as opposed to a **public network**). Therefore, the **discovery** options (namely, the ability to view outside devices and computers and to be seen by other networks) are enabled, but **sharing** options are not. You must therefore enable them manually before you can share your folders, your Internet connection or your printer.

4.2.1. Enabling sharing

Before setting up sharing for your folders, your printer or your Internet connection, you must enable sharing in the **Network and Sharing Center**.



Note: To open the **Network and Sharing Center**, click the network icon in the **Windows taskbar**, then the **Network and Sharing Center** link.

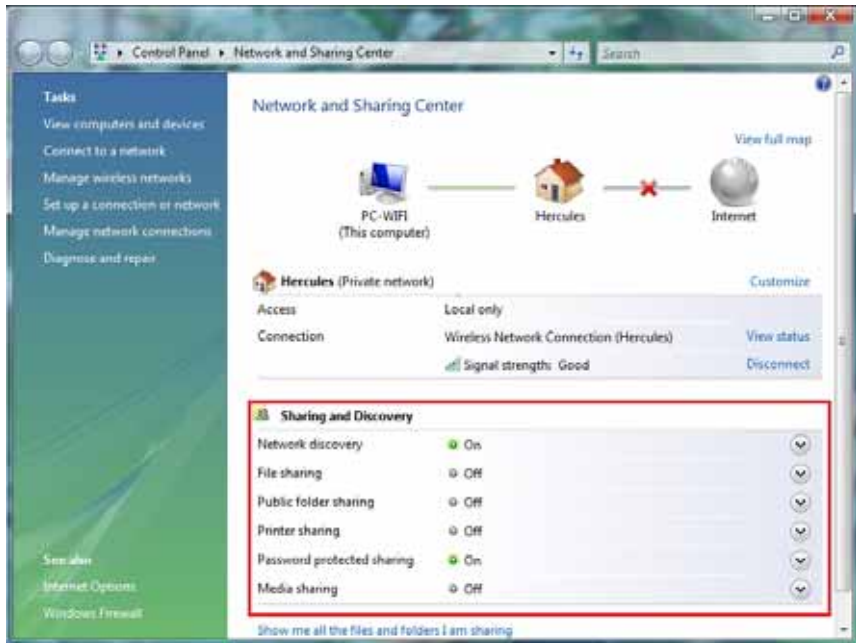

Enabling file sharing

- In the **Sharing and Discovery** zone, click the **Off** link or the  button located opposite **File sharing**.
- Select the **Turn on file sharing** radio button.

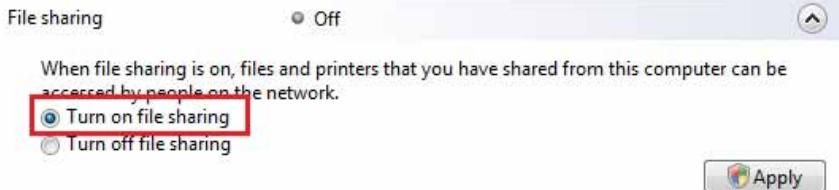

- Click **Apply**. In the Windows Vista confirmation window, click **Continue**.

Enabling public folder sharing

Note: A public folder is a folder which can be shared by other users of the same computer or of the same network.

- In the **Sharing and Discovery** zone, click the **Off** link or the  button located opposite **Public folder sharing**.

- Select the **Turn on sharing so anyone with network access can open files** radio button (they will only be able to consult files) or select **Turn on sharing so anyone with network access can open, change, and create files** (there will be no limitations on the contents of these folders in terms of viewing, making changes and additions or other actions).

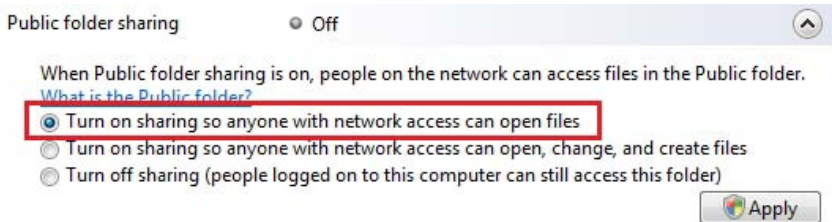

- Click **Apply**. In the Windows Vista confirmation window, click **Continue**.

Enabling printer sharing

Note: To enable printer sharing, you must first have installed a printer.

- In the **Sharing and Discovery** zone, click the **Off** link or the  button located opposite **Printer sharing**.

- Select the **Turn on printer sharing** radio button.

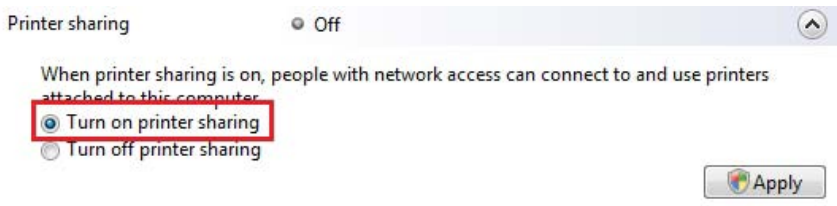

- Click **Apply**. In the Windows Vista confirmation window, click **Continue**.

Enabling media file sharing

Note: This option allows you to enable sharing of your music, videos and images.

- In the **Sharing and Discovery** zone, click the **Off** link or the  button located opposite **Media sharing**.

- Click **Change...**

When media sharing is on, people and devices on the network can access shared music, pictures, and videos on this computer, and this computer can find those types of shared files on the network.

[Change...](#)

- In the **Media Sharing** window that appears, tick the **Share my media** box.

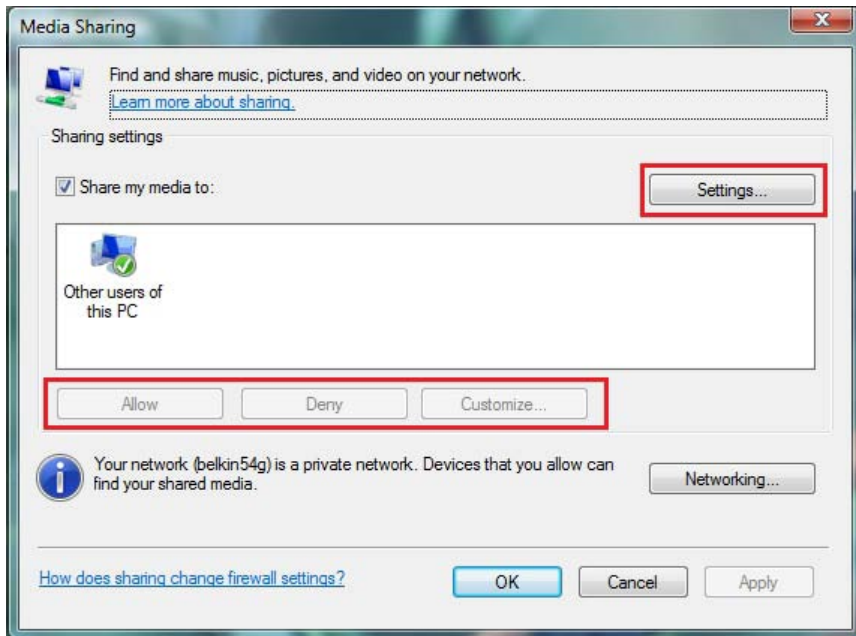

- Click **OK**. In the Windows Vista confirmation window, click **Continue**.

- In the following window, you can define the different **settings**, such as: authorize or refuse groups of users, set parental controls, select media types to be shared, and so on.

- When you're done, click **Apply**, then **OK**.

4.2.2. Windows Vista: Sharing public or personal folders

Reminder: In Windows Vista, there are two types of folders: **personal or local folders** and **public folders**. A **personal folder** is a folder belonging to a specific user created on the computer, whereas a **public folder** is a folder that can be shared by any other user of the same computer or the same network. In essence, a public folder is shared, and therefore available to everyone for viewing (minimum authorization level). For sharing **personal folders** (your folder of your own images, for example), you must select the users who will be able to access their contents and set the authorization level, as indicated in the following procedure.

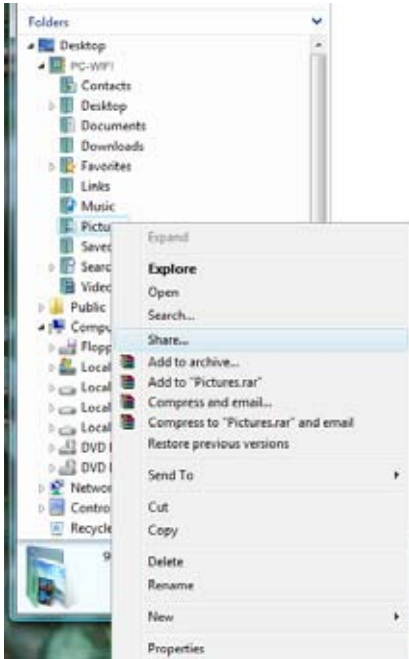

1. Select the folder that you wish to share, without opening it. Here, your **Pictures** folder.
2. Right-click the folder. Select **Share**.

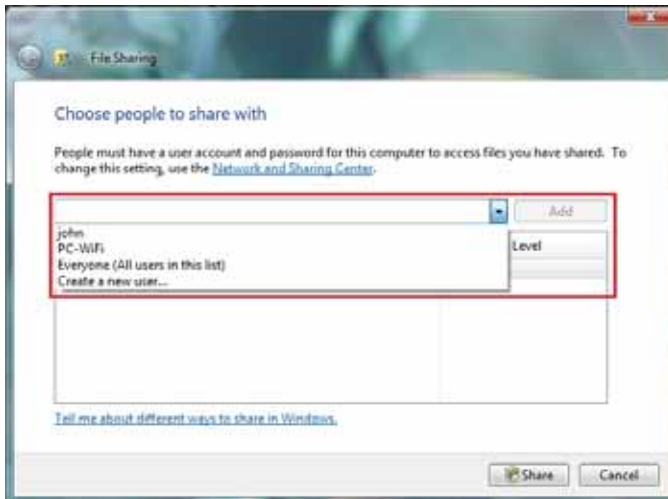

3. In the **File Sharing** window, select the user(s) who will be able to access this folder, then click **Add**.

Note: You can provide access to all users with no restrictions (**Everyone** option) or select specific users previously created on your PC. You can also create new users by clicking **Create a new user...** in the drop-down list.

4. Select the **Permission Level** you wish to assign by clicking on the line for that user: **Reader** (authorization to view only), **Contributor** (authorization to view, add and delete) or **Co-owner** (authorization to view, modify, add and delete).
5. Click **Share**. Be sure to note the path indicated, which will allow for access to the shared folder on the network from another computer. For example: **\\PC-WIFI\Users\My documents\Shared Pictures Folders**.
6. Click **Done**.

*The folder is now shared. You can now display all shared folders and files on the computer or the shared files on the network by clicking the links in the **Network and Sharing Center**.*

4.2.3. Computers running Windows Vista: Accessing shared folders

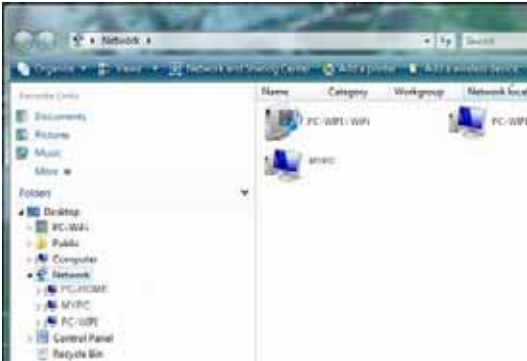

1. In the file explorer, accessible via **Start/Computer**, double-click **Network**.

*You access the list of the computers on the same network. Use the path indicated by Windows when setting up sharing (for example: **\\PC-WIFI\Users\My documents\Shared Pictures Folders**).*

2. Double-click the computer sharing the folders you wish to access.
3. If a password has been defined, enter your **user name** and your **password**.

All shared folders appear. Depending on your authorization level, you can display, modify, add and/or delete shared folders and files.

4.2.4. Windows Vista: Sharing a printer

You can put a printer on the network and thereby share it with all computers in your home equipped with a WiFi adapter.



To access a printer on the network, sharing for the printer must first be set up in the **Network and Sharing Center** (please refer to chapter **4.2.1 Enabling sharing**). The printer must then be set up for sharing on the computer to which is connected and on which it is installed.

On the computer connected to the printer:

1. Click **Start/Control Panel**.
2. Under the **Hardware and Sound** heading, click the **Printer** link.

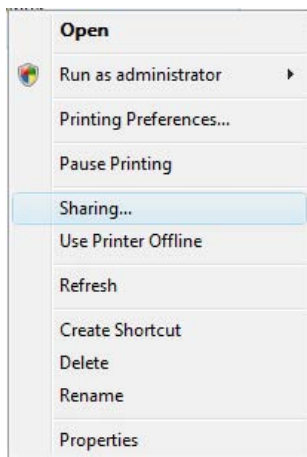
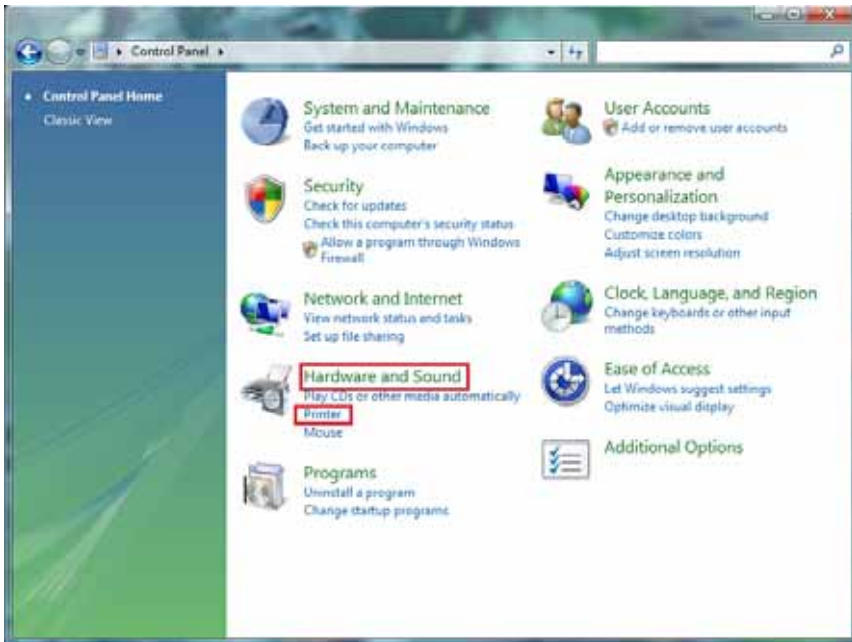

The list of installed printers is displayed.

3. Right-click the printer and select the **Sharing...** option.

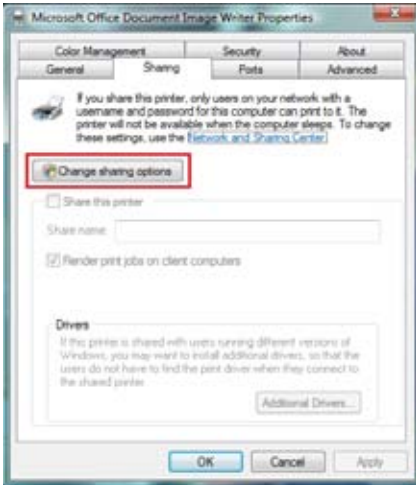

4. In the **Printer Properties** window, click the **Change sharing options** button.
5. In the Windows Vista confirmation window, click **Continue**.



6. Tick the **Share this printer** box.
7. Select the name of the printer which will be displayed on the network under **Share name**.
8. Click **Apply**, then **OK**.

4.2.5. Computers running Windows Vista : Accessing the shared printer

On the computers that will use the shared printer:

1. Click **Start/Control Panel**.
2. Under the **Hardware and Sound** heading, click the **Printer** link.

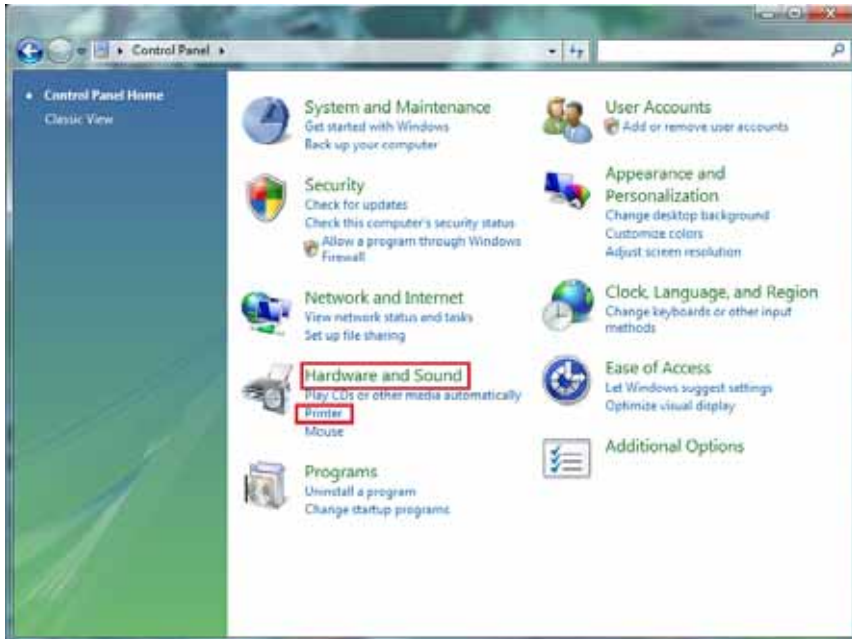

3. Click the **Add a printer** button.
The Add a printer assistant appears.

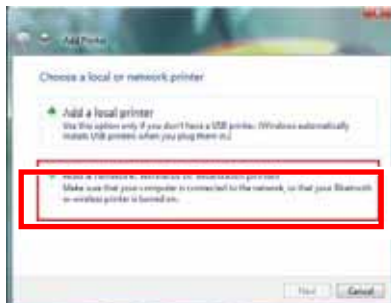

4. Click **Add a network, wireless or Bluetooth printer**.



5. Windows searches for the shared printers on your network. Select the shared printer.
6. Click **Next**.
7. If necessary, accept installation of the printer's drivers when you are being prompted by Windows.
8. Validate the name of your printer, then click **Next**.
9. Click **Finish** to close the assistant.

4.2.6. Windows Vista: Sharing an ADSL connection in an Infrastructure type network

Reminder: If you have a modem-router or a router connected to a modem and one or more computers, your network will be in **Infrastructure mode** by default. In this mode, the WiFi adapters are connected to your **access point**, which might be your Hercules access point, your Hercules Modem Router or your Hercules Router connected to a modem. **Infrastructure mode** is ideal for exchanging data, online gaming, and also for sharing an Internet connection and/or printer among several computers. Follow the instructions below to finally free yourself from the cable that connects you to your modem... without cutting the links to your ADSL connection. Viva the Wireless Attitude!

Proceed as follows for each computer that will use the shared Internet connection:

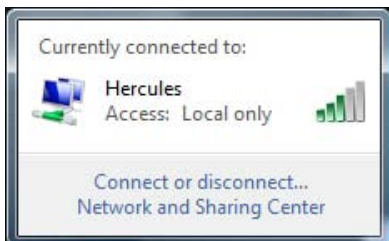

1. Connect to your wireless network (Hercules, for example).
2. Access the **Network and Sharing Center**. To do so, click the network icon on the Windows taskbar, then click the **Network and Sharing Center** link.
3. Click the **View status link**.

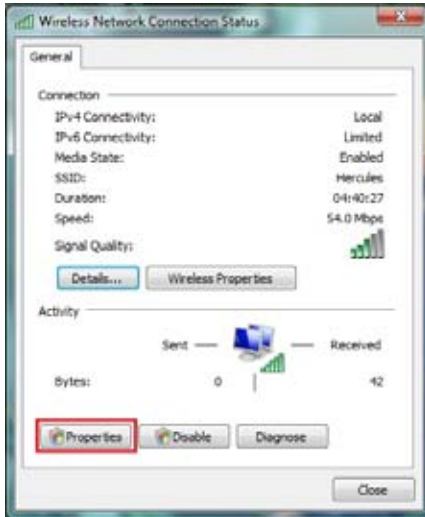

4. In the **Wireless Network Connection Status** window, click **Properties**.
5. In the Windows Vista confirmation window, click **Continue**.

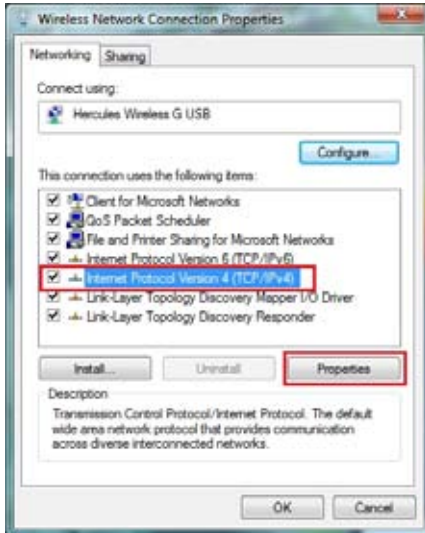

6. In the **Wireless Network Connection Properties** tab, select **Internet Protocol version 4 (TCP/IPv4)**.
7. Click **Properties**.



8. In the **Internet Protocol version 4 (TCP/IPv4)** window, select **Obtain an IP address automatically** and **Obtain DNS server address automatically**.
9. Click **OK** to validate.
10. Do the same for **Internet Protocol version 6 (TCP/IPv6)**.

To access the Internet, simply launch your Internet browser.

4.3. Computers running Windows XP: Sharing folders, a printer or an ADSL connection

A simple solution for sharing folders, a printer or an **ADSL** connection in Windows XP is to use the **Network Setup Wizard**. This Wizard will help you create a real home network.

Note: the access paths mentioned below may vary slightly if you have modified the default display configuration in Windows XP (meaning the Start menu properties and Control Panel display).

4.3.1. *Windows XP: Using the Network Setup Wizard in an Infrastructure network*

Proceed as follows for each computer:



1. Click **Start/All Programs/Accessories/Communications/ Network Setup Wizard**.

The Network Setup Wizard is launched.

2. Click **Next** twice.

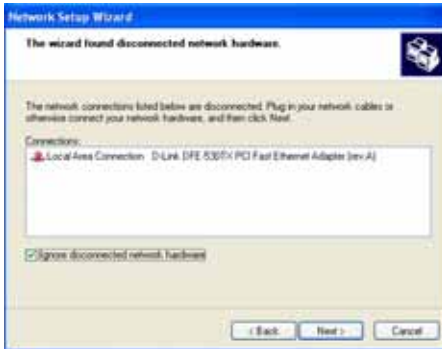

The window opposite may appear if **The Wizard found disconnected network hardware**.

3. If your Hercules Wireless Adapter wireless network connection is not displayed in the list, tick the **Ignore disconnected network hardware** box, then click **Next**. Otherwise, exit the Wizard by clicking **Cancel** and establish the connection from your network device to your access point (if you use a Hercules Wireless G PCI, USB or PCMCIA adapter, please refer to the "The WiFi Station utility" chapter of your User Manual).



The window opposite may appear if **The Wizard found a shared Internet connection on the computer**.

4. Select **No, let me choose another way to connect to the Internet**, then click **Next**.

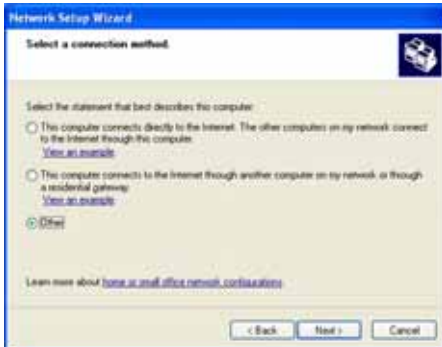

5. In the **Select a connection method** window, select the **Other** option.

6. In the following window, select **This computer connects to the Internet directly or through a network hub**, then click **Next**.

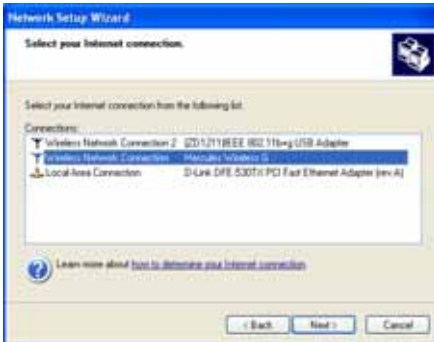

- If the window opposite appears, select the Hercules Wireless network connection, then click **Next**.

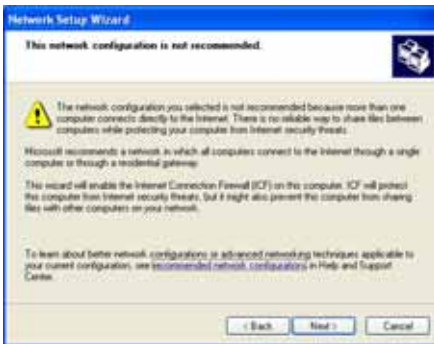

- When this warning screen appears, ignore it by clicking **Next**.

If you are using the Hercules Wireless N Access Point, your computers are already protected by the integrated firewall.



- If your computer has at least three connections (or network devices), the window opposite appears. In this case, let the Wizard determine the appropriate connections.
- Click **Next**.

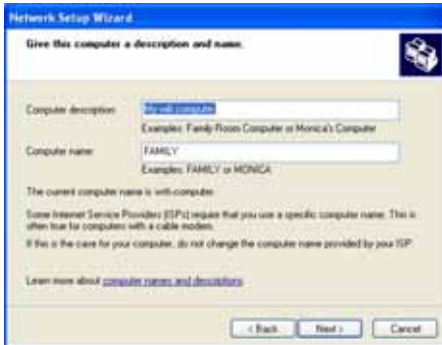

11. Enter the computer name and a description, if required.

Give the computer a name that is unique and sufficiently distinctive, making it easy to recognize on your network (my-computer, wifi-computer or julie, for example).

12. Click **Next**.



13. Enter the **workgroup** name (HOME, OFFICE or HERCULES, for example) and a description, if required.

The workgroup name must be identical (be sure to respect the case of letters) for all computers you wish to link together in a network.

14. Click **Next**.

15. Verify the configuration settings you have entered in the window that appears, then click **Next**.

The Wizard configures the computer for the home network. This may take a few minutes.



16. Before completing the procedure, you may select the **Create a Network Setup Disk** option. This consists of copying this Wizard onto a storage medium (your choice of floppy disk or USB key) so that it can be launched on computers equipped with operating systems other than Windows XP.

This operation is carried out automatically, once you have selected a medium for saving the Wizard.



17. Click **Finish** to exit the Wizard.

Once the procedure is finished, Windows XP may prompt you to restart your computer.



The procedures described in this chapter are specific to Windows XP. For all other questions related to sharing folders, a printer or an Internet connection, or on using Windows, please refer to the Windows online help utility.

4.3.2. Windows XP: Sharing folders

After having configured all of your computers using the Network Setup Wizard, you can now share data located on different disk drives, as long as the user has authorized access.



1. Select the folder you wish to share, without opening it.



2. Right-click the folder. Select **Sharing and Security**.

3. In the **Network sharing and security** section of the **Sharing** tab, tick the **Share this folder on the network** box.

4. On the **Share name** line, enter the folder name as it will be displayed on the network (12 characters maximum to ensure compatibility with other operating systems).

*You can also tick the **Allow network users to change my files** box. In this case, the user will be able to read files and save any changes. If this box is not ticked, the shared files can only be read, and not changed.*



The [Shared folder name] **Properties** window is divided into two sections. **Local sharing and security** only allows for the sharing of files among several users on the same PC. The files are then placed in a **Shared Documents** folder. **Network sharing and security**, however, allows for the sharing of files among more than one computer.



5. Click **Apply** to validate your choices, then click **OK** to close the window.

An icon representing a hand beneath the folder indicates that the folder is now shared.



You can only share the contents of a folder, and not an individual file. We therefore recommend that you create a folder specifically for this purpose where you will put files to be shared.

4.3.3. Windows XP: Accessing shared folders

To easily access folders set up for sharing by several computers, it is preferable that the computers belong to the same workgroup. In Windows XP, the workgroup name has been defined using the Network Setup Wizard.



1. Click **Start/My Computer**.
2. Click **My Network Places**, then click **View workgroup computers**.

You directly access the list of computers in your workgroup.

3. Double-click the computer that is sharing the folders you wish to access.

All shared folders appear.

4.3.4. Windows XP: Sharing a printer

It is possible to put a printer on the network and share it with all computers in the house equipped with a WiFi adapter.



To access a printer on the network, the printer must be set up for sharing on the computer where it is connected and installed.

On the computer connected to the printer:



1. Click **Start/Control Panel/Printers and Other Hardware/Printers and Faxes**.
2. Right-click the printer and select **Sharing**.
3. In the **Sharing** tab, select the **Share this printer** radio button and enter a name for your printer.

Give the printer a name that is unique and sufficiently distinctive, making it easy to recognize (my-printer or home laser printer, for example). If one of your computers is running Windows 98 SE, we recommend that the sharing name not exceed 12 characters (without spaces) in order to ensure its compatibility with this operating system.

4. Click **Apply**, then **OK**.

On the computers that will use the shared printer:

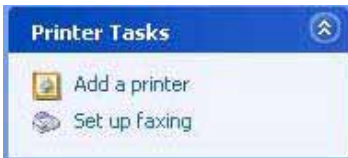

1. Click **Start/Control Panel/Printers and Other Hardware/Printers and Faxes**. In the **Printer Tasks** section, select **Add a printer**.



2. The **Add Printer Wizard** is launched. Click **Next**.
3. Select the **A network printer, or a printer attached to another computer** option, then click **Next**.
4. In the window that appears, click **Next** to launch the search for shared printers.



5. In the list displayed, double-click the computer connected to the printer.
6. Select the shared printer, then click **Next**.
7. If you wish, set the shared printer as the default printer, then click **Next**.



8. Click **Finish** to exit the Wizard.

You can now use the network printer thanks to your WiFi connection. For more information on sharing a printer, please refer to your printer's manual.

4.3.5. Windows XP: Modifying a workgroup name

It may happen that you need to change the name of your workgroup (advanced users only). To do so, proceed as follows:

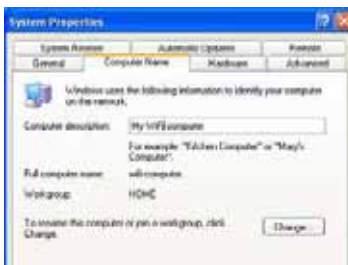

1. Click **Start/Control Panel/Performance and Maintenance/System**.
2. In the **System Properties** window, select the **Computer Name** tab.
3. Click the **Change...** button.



4. In the **Computer Name** zone, enter a name sufficiently distinctive that it can easily be recognized in the list of computers for the **workgroup** (my-computer, wifi-computer or julie, for example).
5. In the **Workgroup** zone, enter a name for the group (HOME, OFFICE or HERCULES, for example).

The workgroup name must be identical (be sure to respect the case of letters) for all computers you wish to link together in a network.

6. A Windows message indicates that the task has been carried out successfully and that you must restart the computer.
7. Repeat this procedure for each computer.

4.3.6. Windows XP: Manually enabling or disabling your adapter's WiFi connection (advanced users)

You can manually enable or disable your adapter's WiFi connection for a variety of reasons: to temporarily avoid connecting to networks, save battery power, etc.



- Click **Start/Connections/Show All Connections**.

Verify that your Hercules Wireless G network connection is listed.

- If its status is **Disabled**, right-click your **Wireless Network Connection** and select **Enable**.

- If its status is **Enabled**, right-click your **Wireless Network Connection** and select **Disable**.

4.4. Computers running Windows 2000: Sharing folders, a printer or an ADSL connection

To create a network of computers, share data, a printer or an **ADSL** connection in Windows 2000, it is preferable that the computers belong to the same **workgroup**.

4.4.1. Creating a workgroup in Windows 2000



1. Click **Start/Settings/Control Panel**. Double-click **System**.
2. In the **System Properties** window, select the **Network Identification** tab.
3. Click the **Properties** button.



4. In the **Computer name** zone, enter a name sufficiently distinctive that it can easily be recognized in the list of computers for the **workgroup** (my-computer, wifi-computer or julie, for example).
5. In the **Workgroup** zone, enter a name for the group (HOME, OFFICE or HERCULES, for example).

The workgroup name must be identical (be sure to respect the case of letters) for all computers you wish to link together in a network.

6. Click **OK**. A Windows message indicates that the task has been carried out successfully and that you must restart the computer.
7. Click **OK** once more.

4.4.2. Windows 2000: Sharing folders



1. Select the folder you wish to share, without opening it.
2. Right-click the folder. Select **Sharing**.
3. In the **Sharing** tab, select **Share this folder**.
4. On the **Share name** line, enter the folder name as it will be displayed on the network (12 characters maximum to ensure compatibility with other operating systems).

*You can also limit access to the folder by selecting a limited number of users and the type of access by clicking the **Permissions** button.*

5. Click **Apply**, then **OK**.

4.4.3. Windows 2000: Accessing shared folders



1. Click **Start/Programs/Accessories/Windows Explorer**.
2. Double-click **My Network Places**, **Entire Network**, then **Microsoft Windows Network**.
3. Double-click your workgroup.

You access the list of the computers in your workgroup.

4. Double-click the computer that is sharing the folders you wish to access.

All shared folders appear.

4.4.4. Windows 2000: Sharing a printer

It is possible to put a printer on the network and share it with all computers in the house equipped with a WiFi adapter.



To access a printer on the network, the printer must be set up for sharing on the computer where it is connected and installed.

On the computer connected to the printer:



1. Click **Start/Settings/Printers**.
2. Right-click the printer and select **Sharing...**
3. In the **Sharing** tab, select the **Shared as:** radio button and enter a name for your printer.

Give the printer a name that is unique and sufficiently distinctive, making it easy to recognize (my-printer or home laser printer, for example). If one of your computers is running Windows 98 SE, we recommend that the sharing name not exceed 12 characters (without spaces) in order to ensure its compatibility with this operating system.

4. Click **Apply**, then **OK**.

On the computers that will use the shared printer:



1. Click **Start/Settings/Printers**. Double-click the **Add Printer** icon.
2. The **Add Printer Wizard** is launched. Click **Next**.
3. Select the **Network printer** option, then click **Next**.
4. Click **Next** to locate the shared printer.



5. In the list displayed, double-click the computer connected to the printer.

6. Select the shared printer, then click **Next**.

7. If you wish, set the shared printer as the default printer, then click **Next**.

8. Click **Finish** to close the Wizard.

You can now use the network printer thanks to your WiFi connection. For more information on sharing a printer, please refer to your printer's manual.

4.4.5. Windows 2000: Modifying a workgroup name

It may happen that you need to change the name of your workgroup (advanced users only). To do so, proceed as follows:



1. Click **Start/Settings/Control Panel**. Double-click **System**.

2. In the **System Properties** window, select the **Network Identification** tab.

3. Click the **Properties** button.



4. In the **Computer name** zone, enter a name sufficiently distinctive that it can easily be recognized in the list of computers for the **workgroup** (my-computer, wifi-computer or julie, for example).
5. In the **Workgroup** zone, enter a name for the group (HOME, OFFICE or HERCULES, for example).

The workgroup name must be identical (be sure to respect the case of letters) for all computers you wish to link together in a network.

6. Click **OK**. A Windows message indicates that the task has been carried out successfully and that you must restart the computer.
7. Repeat this procedure for each computer.

4.4.6. Windows 2000: Sharing an ADSL connection in an Infrastructure network

Proceed as follows for each computer that will use the shared Internet connection:



1. Click **Start/Settings/Network and Dial-up Connections**.
2. Select the connection to the local area network corresponding to your Hercules Wireless G device.
3. Right-click the connection and select **Properties**.



4. In the **Local Area Connection Properties** window, select **Internet Protocol (TCP/IP)**.
5. Click **Properties**.



6. In the **Internet Protocol (TCP/IP) Properties** window, select **Obtain an IP address automatically** and **Obtain DNS server address automatically**.
7. Click **OK** to close the windows.

Windows may prompt you to restart your computer.

To access the Internet, you can now simply launch your Internet browser.

4.4.7. Windows 2000: Manually enabling or disabling your adapter's WiFi connection (advanced users)

You can manually enable or disable your adapter's WiFi connection for a variety of reasons: to temporarily avoid connecting to networks, save battery power, etc.

To manually enable or disable your Hercules Wireless G adapter's WiFi connection in Windows 2000:

- Access the **Device Manager**.
- Select your Hercules Wireless G adapter in the list of network adapters.
- Right-click your adapter and select **Properties**.
- To enable your adapter, select **Enable**. To disable it, select the **Disable** option.

For more information on manually enabling or disabling the adapter in Windows 2000, please refer to the Windows online help utility.

4.5. Computers running Windows Me: Sharing folders, a printer or an ADSL connection

A simple solution for sharing folders, a printer or an **ADSL** connection in Windows Me is to use the **Home Networking Wizard**. This Wizard will help you create a real home network.

4.5.1. Windows Me: Using the Home Networking Wizard in an Infrastructure network



1. Click **Start/Programs/Accessories/Communications/Home Networking Wizard**.

The Wizard is launched.

2. Click **Next**.



If you have already used this Wizard on this computer, the **Setup Options** panel appears. Select **I want to edit my Home Networking settings on this computer**, then click **Next**.

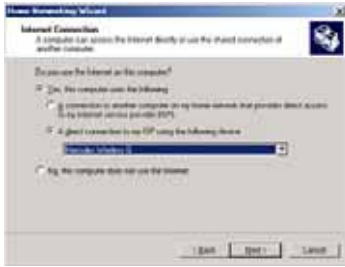

3. In the **Internet Connection** window, select the **A direct connection to my ISP using the following device:** option.
4. Select your Hercules Wireless G adapter in the drop-down list, then click **Next**.



5. If the **Internet Connection Sharing** window appears, select **No, I do not want to share my Internet connection**.
6. Click **Next**.



7. Enter the computer name.

Give the computer a name that is unique and sufficiently distinctive, making it easy to recognize in the list of workgroup computers (my-computer, wifi-computer or julie, for example).

8. Select the **Use this workgroup name** option and enter the **workgroup** name (HOME, OFFICE or HERCULES, for example).

The workgroup name must be identical (be sure to respect the case of letters) for all computers you wish to link together in a network.



9. Click **Next**.
10. If you wish, you can enable sharing for the My Documents folder by ticking the **My Documents folder and folders in it** box. In this case, the Wizard will prompt you to enter a password.
11. If you wish, you can enable sharing of your printer by selecting it in the list.
12. Click **Next**.

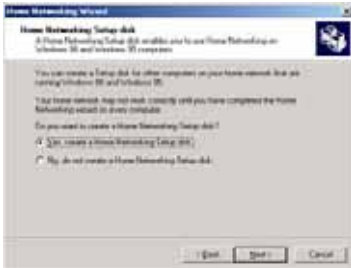

13. Before completing the procedure, you may copy this Wizard onto a setup disk so that it can be launched on computers equipped with operating systems other than Windows Me. In this case, select the **Yes, create a Home Networking Setup disk** option.

This operation is carried out automatically, once you have selected a medium for saving the Wizard.



14. Click **Finish** to exit the Wizard.

Once the procedure is finished, Windows Me prompts you to restart your computer. Once your computer has restarted, a message invites you to configure your other computers.

4.5.2. Windows Me: Sharing folders

After having configured all of your computers using the Home Networking Wizard, you can now share data located on different disk drives, as long as the user has authorized access.



1. Select the folder you wish to share, without opening it.
2. Right-click the folder. Select **Sharing**.
3. In the **Sharing** tab, select **Shared As**.
4. On the **Share Name** line, enter the folder name as it will be displayed on the network (12 characters maximum).

You can also limit access to the folder by selecting the type of access and a password.



If the **Sharing** tab does not appear, you must enable file sharing.



1. Click **Start/Settings/Control Panel**. Double-click **Network**.
2. In the **Network** window, click the **File and Print Sharing...** button.
3. Tick the **I want to be able to give others access to my files** box.

Windows may prompt you to insert the installation CD-ROM.

4.5.3. Windows Me: Accessing shared folders

To easily access folders set up for sharing by several computers, it is preferable that the computers belong to the same workgroup. In Windows Me, the workgroup name has been defined using the Home Networking Wizard.



1. Click **Start/Programs/Windows Explorer**.
2. Double-click **Network Neighborhood** and expand it.

You access the list of the computers in your workgroup.

3. Double-click the computer that is sharing the folders you wish to access.

All shared folders appear.

4.5.4. Windows Me: Sharing a printer

It is possible to put a printer on the network and share it with all computers in the house equipped with a WiFi adapter.



To access a printer on the network, the printer must be set up for sharing on the computer where it is connected and installed.

On the computer connected to the printer:



1. Click **Start/Settings/Printers**.
2. Right-click the printer and select **Sharing**.
3. In the **Sharing** tab, select the **Shared As** radio button and enter a name for your printer.

Give the printer a name that is unique and sufficiently distinctive, making it easy to recognize (printer or wifi printer, for example).

4. Click **Apply**, then **OK**.



If the **Sharing** tab does not appear, you must enable file sharing.



1. Click **Start/Settings/Control Panel**. Double-click **Network**.
2. In the **Network** window, click the **File and Print Sharing...** button.
3. Tick the **I want to be able to allow others to print to my printer(s)** box.

Windows may prompt you to restart your computer.

On the computers that will use the shared printer:



1. Click **Start/Settings/Printers**. Double-click the **Add Printer** icon.
2. The **Add Printer Wizard** is launched. Click **Next**.
3. Select the **Network printer** option, then click **Next**.
4. Click **Browse...** to locate the shared printer.



5. In the list displayed, double-click the computer connected to the printer.
6. Select the shared printer, then click **OK**.
7. Click **Next**.



8. If you wish, set the shared printer as the default printer, then click **Next**.
9. Click **Finish** to close the Wizard.

You can now use the network printer thanks to your WiFi connection. For more information on sharing a printer, please refer to your printer's manual.

4.5.5. Windows Me: Modifying a workgroup name

It may happen that you need to change the name of your workgroup (advanced users only). To do so, proceed as follows:



1. Click **Start/Settings/Control Panel**. Double-click **Network**.
2. Select the **Identification** tab.
3. In the **Computer name** zone, enter a name sufficiently distinctive that it can easily be recognized in the list of computers for the **workgroup** (my-computer, wifi-computer or julie, for example).
4. In the **Workgroup** zone, enter a name for the group (HOME, OFFICE or HERCULES, for example).

The workgroup name must be identical (be sure to respect the case of letters) for all computers you wish to link together in a network.

5. Click **OK**. A Windows message indicates that the task has been carried out successfully and that you must restart the computer.
6. Repeat this procedure for each computer.

4.5.6. Windows Me: Manually enabling or disabling your adapter's WiFi connection (advanced users)

You can manually enable or disable your adapter's WiFi connection for a variety of reasons: to temporarily avoid connecting to networks, save battery power, etc.

To manually enable or disable your adapter's WiFi connection in Windows Me:

- Access the **Device Manager**.
- Select your Hercules Wireless G adapter in the list of network adapters.
- Right-click your adapter and select **Properties**.
- To enable your adapter, select **Enable**. To disable it, select the **Disable** option.

For more information on manually enabling or disabling the adapter in Windows Me, please refer to the Windows online help utility.

4.6. Computers running Windows 98 SE: Sharing folders, a printer or an ADSL connection

To create a network of computers, share data, a printer or an **ADSL** connection in Windows 98 SE, it is preferable that the computers belong to the same **workgroup**.

4.6.1. Windows 98 SE: Creating a workgroup



1. Click **Start/Settings/Control Panel**. Double-click **Network**.
 2. Select the **Identification** tab.
 3. In the **Computer name** zone, enter a name sufficiently distinctive that it can easily be recognized in the list of computers for the **workgroup** (my-computer, wifi-computer or julie, for example).
 4. In the **Workgroup** zone, enter a name for the group (HOME, OFFICE or HERCULES, for example).
- The workgroup name must be identical (be sure to respect the case of letters) for all computers you wish to link together in a network.*
5. Click **OK**. Windows prompts you to restart your computer.
 6. Repeat this procedure for each computer.

Note: to modify the name of a workgroup, follow the same procedure.

4.6.2. Windows 98 SE: Sharing folders



1. Select the folder you wish to share, without opening it.
2. Right-click the folder. Select **Sharing**.
3. In the **Sharing** tab, select **Shared As**.
4. On the **Share Name** line, enter the folder name as it will be displayed on the network (12 characters maximum).

You can also limit access to the folder by selecting the type of access and a password.



If the sharing tab does not appear, you must enable file sharing.



1. Click **Start/Settings/Control Panel**. Double-click **Network**.
2. In the **Network** window, click the **File and Print Sharing...** button.
3. Tick the **I want to be able to give others access to my files** box, then click **OK**.
4. Click **OK** to close the window.

Windows may prompt you to insert the installation CD-ROM and restart the computer.

4.6.3. Windows 98 SE: Accessing shared folders



1. Click **Start/Programs/Windows Explorer**.
2. Double-click **Network Neighborhood** and expand it.

You access the list of the computers in your workgroup.

3. Double-click the computer that is sharing the folders you wish to access.

All shared folders appear.

4.6.4. Windows 98 SE: Sharing a printer

It is possible to put a printer on the network and share it with all computers in the house equipped with a WiFi adapter.



To access a printer on the network, the printer must be set up for sharing on the computer where it is connected and installed.

On the computer connected to the printer:



1. Click **Start/Settings/Printers**.
2. Right-click the printer and select **Sharing**.
3. In the **Sharing** tab, select **Shared As** and enter a name for your printer.

Give the printer a name that is unique and sufficiently distinctive, making it easy to recognize (printer or wifi printer, for example).

4. Click **Apply**, then **OK**.



If the **Sharing** tab does not appear, you must enable file sharing.



1. Click **Start/Settings/Control Panel**. Double-click **Network**.
2. In the **Network** window, click the **File and Print Sharing...** button.
3. Tick the **I want to be able to allow others to print to my printer(s)** box.

Windows prompts you to restart your computer.

On the computers that will use the shared printer:



1. Click **Start/Settings/Printers**. Double-click the **Add Printer** icon.
2. The **Add Printer Wizard** is launched. Click **Next**.
3. Select the **Network printer** option, then click **Next**.
4. Click **Browse...** to locate the shared printer.



5. In the list displayed, double-click the computer connected to the printer.
6. Select the shared printer, then click **OK**.
7. Click **Next**.



8. If you wish, set the shared printer as the default printer, then click **Next**.
9. Click **Finish** to close the Wizard.

You can now use the network printer thanks to your WiFi connection. For more information on sharing a printer, please refer to your printer's manual.

4.6.5. Windows 98 SE: Sharing an ADSL connection in an Infrastructure network

Proceed as follows for each computer that will use the shared Internet connection:

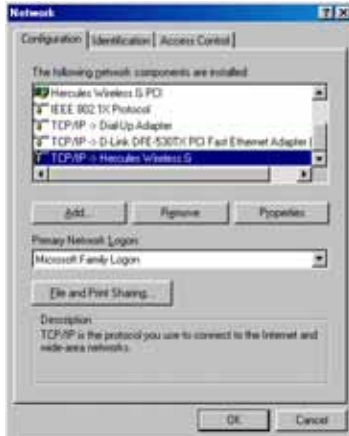

1. Click **Start/Settings/Control Panel**. Double-click **Network**.
2. In the **Configuration** tab of the **Network** window, select the **TCP/IP -> Hercules Wireless G** component.
3. Click **Properties**.



4. In the **IP Address** tab, select **Obtain an IP address automatically**.



5. In the **Gateway** tab, if there are gateways installed, select them and click **Remove**.
6. Click **OK** to close the windows.

Windows may prompt you to restart your computer.

To access the Internet, you can now simply launch your Internet browser.

4.6.6. Windows 98 SE: Manually enabling or disabling your adapter's WiFi connection (advanced users)

You can manually enable or disable your adapter's WiFi connection for a variety of reasons: to temporarily avoid connecting to networks, save battery power, etc.

To manually enable or disable your Hercules Wireless G adapter's WiFi connection in Windows 98 SE:

- Access the **Device Manager**.
- Select your Hercules Wireless G adapter in the list of network adapters.
- Right-click your adapter and select **Properties**.
- To enable your adapter, select **Enable**. To disable it, select the **Disable** option.

For more information on manually enabling or disabling the adapter in Windows 98 SE, please refer to the Windows online help utility.

5. WIFI MANAGER N FOR ADVANCED USERS

WiFi Manager N has been designed to respond to the needs of the widest cross-section of the public. Thus, after having explained the most useful functionalities in the previous chapters, we dedicate this chapter to users who wish to take advantage of the subtleties of WiFi, and explore their access point's more advanced functionalities. **But be careful!** Modifying certain settings may have a negative impact on the proper functioning of your network, and therefore on your access point. You should bear in mind, however, that nothing is irreversible, and that you can always return to the original configuration or reload a personalized configuration.



In certain cases, your settings will only be taken into account after WiFi Manager N has restarted.

5.1. Configuring your WiFi network's advanced options



This window contains settings which affect the functioning of your Hercules access point. If you do not know their functions, we recommend that you keep the default settings.



Your WiFi connection settings

Expert WiFi settings

Fragmentation threshold:

RTS threshold:

Beacon Period:

DTIM:

- In the **General settings** window, click the **Your WiFi connection settings** button.

- In the **Your WiFi connection settings** window, click the **Expert WiFi settings** button.

- The **Fragmentation threshold** consists of defining the size at which data packets are fragmented. If the size is less than the predefined amount, the packet is not fragmented. By contrast, if the size is greater, the packet is fragmented before being transmitted, then reconstituted at the access point.

Fragmentation lets you improve the success of transmissions.

- When an **RTS threshold** is defined, the wireless device asks the **access point** for authorization to transmit data, thereby avoiding data arriving simultaneously (risk of collision).

Modifying the RTS threshold may affect your access point's performance.

- The **Beacon Period** allows you to define the wireless network detection interval.

- The **DTIM** interval corresponds to the interval between two synchronous frames containing information on the transmission messages.

Data rate: ▾

N Data rate: ▾

Channel bandwidth: Auto 20/40MHz 20MHz

Preamble type: Long preamble Short preamble

Broadcast ESSID: Enabled Disabled

CTS protect: Auto Always None

- The **Data Rate** corresponds to the speed at which data packets are transferred, both being sent and received. It is set to **Auto** by default, but can be adjusted from **1Mbps** (min) to **54Mbps** (max).

- The **N Data Rate** is specific to the transfer of data in the 802.11n standard. The values vary from **MCS0** to **MCS15**.

- Select the **channel bandwidth**.

Select bandwidth of **20MHz** (on one channel) to limit interference, or define a higher bandwidth, **40MHz** (two channels), for transmission of your data in total comfort.

- The **Preamble type** defines the size of WiFi packets. A **Short** preamble optimizes transfer rates at the expense of WiFi coverage. A **Long** preamble (selected by default) favors WiFi coverage by way of longer latency times.

- If you do not wish for your network to broadcast its name, select the **Disabled** radio button.

If the SSID is hidden, the name of the network will not be displayed during detection by a WiFi client (the Network name (SSID) is empty in Hercules WiFi Station N, for example).

Be sure to remember this name, as you will need it to connect your WiFi devices.

- **CTS** (Clear-To-Send) protection guarantees the connection of wireless B, G and N devices to the Hercules Wireless N Access Point when using wireless B, G and N devices at the same time on the network.

Enabling this function may reduce the speed of your Hercules Wireless N Access Point.

5.2. Configuring the DHCP server

This chapter will explain how to configure the internal DHCP server in WiFi Manager N which manages the IP addresses of your computers.

By default, your Hercules access point's DHCP function is disabled, since it is your modem-router which is responsible for assigning these addresses (when equipped with this function). However, you can select to assign the IP addresses from your Hercules access point.



If the DHCP function is enabled on both the modem-router and on the access point at same time, requests (data transmissions) may not be successful.

If you choose to use your access point's DHCP function, you must disable this function on the modem-router. Please refer to your modem-router's manual to find out how to disable this function on your modem-router.



IP address:
 Subnet mask:

- In the **General settings** window, click the **Access point's IP configuration** button.

- You can modify the **Access point's IP address** (192.168.2.254, by default) and its **subnet mask** (255.255.255.0, by default).



Be sure to make a note of this IP address. Without it, you will not be able to reconnect to your access point.

Enable DHCP

IP address lease time:
 Start IP address:
 End IP address:

- If you **enable DHCP**, you can modify the **start IP address** (192.168.2.100, by default), the **end IP address** (192.168.2.200, by default) and the **lease time** for these addresses (**Forever** is the default value).

- If you **do not enable DHCP**, you decide to set the IP address for each computer yourself.

Domain name:

- You can assign a **domain name** to this server and a specific **IP address** according to the computer's **MAC address**.

Associate an IP address with a MAC address

IP address:
 MAC address:

Association table of MAC addresses and IP addresses

IP address:	MAC address:	Allows you to remove the rule from the list.

The table displays the list of IP and MAC addresses added.

- Click the **Modify** button to validate your settings.

5.3. Setting priorities for types of data according to available bandwidth

WMM allows you to assign priority with respect to the types of data circulating on the network. If this option is ticked, the priorities are assigned as follows:

Priority	Type
1	Voice over IP (telephone calls via the Internet)
2	Video data
3	Other applications frequently using the network (Web browser...)
4	Background task applications (printing jobs, downloads, email/messaging...)

For example, if bandwidth is insufficient to allow for the simultaneous transit of a phone call via the Internet, watching a video, surfing the Internet and a download, the WMM function will hold off on the download, surfing the Internet, and the video. The objective is to guarantee optimal comfort of use for the main task at hand.

You can freely enable or disable this option. Be aware, however, that if you disable this option, bandwidth will be split up between all current tasks, without order of priority, which can be detrimental to your comfort of use (for example, untimely disruptions in your phone calls via the Internet or your videos, or a slowdown in terms of your downloads).



The WMM function is only compatible with other WMM devices.



Enable the WMM function



- In the **General settings** window, click the **Your WiFi connection settings** button.

- Select **WMM**.

By default, the WMM function is enabled. Un-tick this box to disable the function.

6. GLOSSARY

802.11

Standard established in 1997 by the IEEE (Institute of Electrical and Electronics Engineers, an American organization), defining wireless networks in the 2.4 – 2.48GHz frequency range and offering transfer speeds of between 1 and 2Mbps/s. Revisions have been made to the original standard in order to optimize transfers (this is the case for the 802.11a, 802.11b and 802.11g standards, referred to as physical 802.11 standards) or to ensure better security or improved interoperability of equipment.

802.11b

Standard established by the IEEE (Institute of Electrical and Electronics Engineers, an American organization) in the 802.11 family, allowing for theoretical transfer rates of 11Mbps/s in the 2.4GHz frequency range with a physical range of up to 300m in an environment free from obstructions. The frequency range used is the 2.4GHz band, with 3 radio channels available.

802.11g

Standard established by the IEEE (Institute of Electrical and Electronics Engineers, an American organization) in the 802.11 family, allowing for theoretical transfer rates of 54Mbps/s in the 2.4GHz frequency range with a physical range of up to 300m in an environment free from obstructions. The 802.11g standard offers backwards compatibility with the 802.11b standard, which means that equipment compliant with the 802.11g standard will also work with 802.11b.

802.11i

Standard established by the IEEE (Institute of Electrical and Electronics Engineers, an American organization) in the 802.11 family, whose goal is to improve security by integrating WPA-PSK authentication into AES encryption. This Hercules adapter is compatible with this standard.

802.11n

Standard established by the IEEE (Institute of Electrical and Electronics Engineers, an American organization) in the 802.11 family, allowing for theoretical transfer rates of 300Mbps/s in the 2.4GHz frequency band with a physical range of up to 300m in an environment free from obstructions. The 802.11n standard offers backwards compatibility with the 802.11b and g standards, which means that equipment compliant with the 802.11n standard will also work with 802.11b and/or g.

Access point

The access point is the heart of your local WiFi network. The system access point is a wireless router whose function is to bring several clients together, which is to say link together all computers equipped with WiFi adapters, thanks to its radio antenna.

Ad hoc mode

Mode allowing several computers equipped with WiFi to communicate directly with one another. This mode is also referred to as Peer to Peer.

ADSL (Asymmetric Digital Subscriber Line)

This equipment, connected to a standard telephone line, offers great speed in terms of sending and receiving data.

AES (Advanced Encryption Standard)

A symmetrical block-based encryption standard supporting different key lengths, this is a powerful, quick and efficient encryption method.

ATM (Asynchronous Transfer Mode)

High-speed transfer mode for fixed-size data.

CCK (Complementary Code Keying)

Advanced encoding scheme for radio waves in wireless networks allowing for high transfer speeds.

Client

Computer equipped with a PCI, USB or PCMCIA WiFi adapter.

DHCP (Dynamic Host Configuration Protocol)

Protocol managing the allocation of IP addresses to computers.

DSSS (Direct Sequence Spread Spectrum)

Technique for using radio frequencies in broad-spectrum wireless networks meant to increase the range of transmissions.

ESSID (Service Set Identifier)

8 to 32-character identifier, often abbreviated as SSID, serving as the unique name for a network shared by clients and the access point.

Ethernet port (or RJ-45)

Port allowing for the connection of two devices via a cable, such as a PC and an access point, in order to exchange data packets without collision.

Filter

Device placed between the telephone plug and the modem to improve the quality of telephone communications, which are often degraded by ADSL signals.

Firewall

Combination of software and security devices protecting a network connected to the Internet.

Infrastructure mode

Communication mode consisting of grouping together several computers equipped with WiFi in a network via a wireless access point such as the Hercules ADSL router.

IP address

Unique computer address assigned by the modem-router. Each computer has its own IP address, allowing it to be identified within the network.

LEAP (Lightweight Extensible Authentication Protocol)

Security protocol developed by the company Cisco for the world of Windows. The format used is identifier/password.

MAC address (Message Authentication Code)

Unique address created by the builder of the client adapter or access point, serving to identify this element within a network.

MIMO technology (Multiple In, Multiple Out)

Technology used in the 802.11n standard, allowing for the WiFi signal to be shared over several antennas with a corresponding increase in terms of signal range and transfer speeds. Transmission can take place on one channel in the 20MHz frequency band (for theoretical maximum transfer speeds of 144.44Mbps/s) or two channels simultaneously (for theoretical maximum transfer speeds of 300Mbps/s) with 40MHz bandwidth. In both cases, the WiFi signal's coverage and range are the same. The choice of one mode or the other (20 or 40MHz) depends solely on the transmitter used. The Hercules Wireless N key will automatically adapt to the signal received.

NAT (Network Address Translation)

Technique allowing for the masking of IP addresses of local area network computers with respect to the Internet.

OFDM (Orthogonal Frequency Division Multiplexing)

Radio transmission technique providing very high transfer speeds widespread within DSL technology, in the wireless terrestrial distribution of television signals and adopted for the high-speed 802.11 wireless communication standard.

PPPoA (Point-to-Point Protocol over ATM)

Protocol allowing for connection to the Internet of computers linked over an ATM network, while still identifying the user.

PPPoE (Point-to-Point Protocol over Ethernet)

Protocol allowing for connection to the Internet of computers linked over an Ethernet network via a high-speed modem.

Static IP

Permanent IP address assigned to a computer by the access provider.

Subnet mask

Part of an IP address indicating the class of the network used (class C, type 255.255.255.0 for a local area network).

TKIP (Temporal Key Integrity Protocol)

The WPA standard uses the TKIP protocol, which consists of regenerating new keys for each data packet, whereas WEP uses a system based on a fixed key.

UPnP (Universal Plug n' Play)

Protocol allowing for the connection to one another of many computers and peripherals available on a network.

WEP (Wired Equivalent Privacy)

Security protocol for wireless networks using encryption based on a 64-bit, 128-bit or 256-bit fixed key used only once, at the start of the decryption phase. To decode a transmission, each wireless network client must use the same 64, 128 or 256-bit key. WEP is part of the 802.11 standard with a view to ensuring authentication (access is only authorized for those who know the WEP key) and confidentiality (encryption). An encryption key is composed of numbers 0 to 9 and letters A to F (example: A123BCD45E).

WiFi (Wireless Fidelity)

An abbreviation of Wireless Fidelity, WiFi is the commercial name adopted by the WECA (Wireless Ethernet Compatibility Alliance), an organization responsible for maintaining the interoperability of equipment in a wireless local area network (WLAN) compliant with the IEEE 802.11 standard. Thus, a WiFi network is actually a 802.11 network. In practice, WiFi allows for the connection of laptop computers, desktop computers or Personal Digital Assistants (PDAs) many tens of meters distant from one another via an access point, allowing them to communicate with one another without any cables and exchange data at high speeds.

WiFi Manager N

Utility developed by Hercules to configure and view settings for the Hercules Wireless N Access Point.

WMM (Wi-Fi Multimedia)

Functionality certified by the Wi-Fi Alliance, whose goal is to define levels of priority according to available bandwidth. Thus voice over IP (priority 1) will take precedence over transmission of video data (priority 2), which will itself take precedence over applications making use of the network, such as Internet browsing (priority 3), and then lastly come background applications, such as printing jobs or downloads (priority 4).

WiFi Router

Device installed at the heart of a WiFi network, allowing for the connection of several computers equipped with WiFi adapters for the exchange of data.

WiFi Station N

Utility developed by Hercules to define, verify and configure all connection and security settings regarding your WiFi installation.

WLAN (Wireless Local Area Network)

Wireless local area network, generally employing the 802.11b, g or n standards.

Workgroup

Group of computers with which you wish to communicate or share resources such as folders, a printer or an Internet connection. To be part of a workgroup, computers must have the same group name.

WPA (WiFi Protected Access)

Wireless network security standard put in place by manufacturers, employing a data encryption algorithm relying on dynamic key management, which was lacking in WEP, the difference being that once communication is established, the key changes randomly for enhanced security.

WPA2 (WiFi Protected Access 2)

Security standard for wireless networks based on the WPA standard, which adds support for the TKIP or AES encryption algorithm, for heightened security.

WPA-PSK (WiFi Protected Access-Pre-Shared Key)

Latest-generation heightened security protocol specially designed for use in environments such as a small office or the home, based on a pre-shared key (a single password). This key is also used for TKIP or AES data encryption.

WPS (Wi-Fi Protected Setup™)

Technology standardized by the Wi-Fi Alliance, which aims to simplify the connection and configuration of a wireless network while at the same time maintaining a high level of security. This technology allows the user to enable protection of a WiFi network via a single button located on the WiFi client, or via entry of a PIN code in the software supplied with the access point.

Log on now to our website (www.hercules.com) to download the latest driver and software versions, consult the list of Frequently Asked Questions (FAQs) relating to your product and access User Manual updates. You can also discover the entire Hercules range and get information on upcoming products.

7. TECHNICAL SUPPORT

If you encounter a problem with your product, please go to <http://ts.hercules.com> and select your language. From there you will be able to access various utilities (Frequently Asked Questions (FAQ), the latest versions of drivers and software) that may help to resolve your problem. If the problem persists, you can contact the Hercules products technical support service ("Technical Support"):

By email:

In order to take advantage of technical support by email, you must first register online. The information you provide will help the agents to resolve your problem more quickly.

Click **Registration** on the left-hand side of the Technical Support page and follow the on-screen instructions.

If you have already registered, fill in the **Username** and **Password** fields and then click **Login**.

By telephone:

United Kingdom	08450800942 Charges at local rate	Monday to Friday from Noon to 4pm and 5pm to 10pm Saturday from 9am to Noon and 1pm to 7pm Sunday from 9am to Noon and 1pm to 4pm
United States	1-866-889-5036 Free	Monday to Friday from 7am to 11am and from Noon to 5pm Saturday and Sunday from 7am to Noon (Eastern Standard Time)
Canada	1-866-889-2181 Free	Monday to Friday from 7am to 11am and from Noon to 5pm Saturday and Sunday from 7am to Noon (Eastern Standard Time)
Denmark	80887690 Free	Monday to Friday from 1pm to 5pm and 6pm to 11pm (English) Saturday from 9am to 1pm and 2pm to 8pm Sunday from 10am to 1pm and 2pm to 5pm
Sweden	0200884567 Free	Monday to Friday from 1pm to 5pm and 6pm to 11pm (English) Saturday from 9am to 1pm and 2pm to 8pm Sunday from 10am to 1pm and 2pm to 5pm
Finland	0800 913060 Free	Monday to Friday from 2pm to 6pm and 7pm to Midnight (English) Saturday from 10am to 2pm and 3pm to 9pm Sunday from 11am to 2pm and 3pm to 6pm

8. WARRANTY

Worldwide, Guillemot Corporation S.A. ("Guillemot") warrants to the consumer that this Hercules product will be free from material defects and manufacturing flaws for a period of two (2) years from the original date of purchase. Should the product appear to be defective during the warranty period, immediately contact Technical Support, who will indicate the procedure to follow. If the defect is confirmed, the product must be returned to its place of purchase (or any other location indicated by Technical Support).

Within the context of this warranty, the consumer's defective product will, at Technical Support's option, be either repaired or replaced. Where authorized by applicable law, the full liability of Guillemot and its subsidiaries (including for indirect damages) is limited to the repair or replacement of the Hercules product. The consumer's legal rights with respect to legislation applicable to the sale of consumer goods are not affected by this warranty.

This warranty shall not apply: (1) if the product has been modified, opened, altered, or has suffered damage as a result of inappropriate or abusive use, negligence, an accident, normal wear, or any other cause not related to a material defect or manufacturing flaw; (2) in the event of failure to comply with the instructions provided by Technical Support; (3) to software not published by Guillemot, said software being subject to a specific warranty provided by its publisher.

9. ENVIRONMENTAL PROTECTION RECOMMENDATION

At the end of its working life, this product should not be disposed of with standard household waste, but rather dropped off at a collection point for the disposal of Waste Electrical and Electronic Equipment (WEEE) for recycling.

This is confirmed by the symbol found on the product, user manual or packaging.



Depending on their characteristics, the materials may be recycled. Through recycling and other forms of processing Waste Electrical and Electronic Equipment, you can make a significant contribution towards helping to protect the environment.

Please contact your local authorities for information on the collection point nearest you.

Trademarks

Hercules® is a registered trademark of Guillemot Corporation S.A. Intel® and Pentium® are registered trademarks of Intel Corporation. Wireless Attitude™ is a trademark of Guillemot Corporation S.A. Microsoft® Windows® 2000, XP and Vista are either trademarks or registered trademarks of Microsoft Corporation in the United States and/or other countries. All other trademarks and brand names are hereby acknowledged and are property of their respective owners. Illustrations not binding.

Declaration of conformity with EU directives

This device can be used in: AT, BE, FR, DE, IE, IT, LU, NL, PL, ES, SE, GB, FI, CH.

Hereby, GUILLEMOT CORPORATION, Carentoir France, declares that this **Hercules HWNAP 300** is in compliance with the essential requirements and other relevant provisions of Directive 1999/5/EC. The Declaration of Conformity can be consulted at this website address:

ftp://ftp.hercules.com/wifi/DoC/HWNAP-300/DoC-eng_Hercules_HWNAP-300.pdf

CE 0470

Hercules is a division of Guillemot Corporation.

EUROPEAN USERS:

This equipment has been tested and found to comply with Directive 1999/5/EC of the European Parliament and of the Council on radio equipment and telecommunications terminal equipment and the mutual recognition of their conformity. After assessment, the equipment has been found to comply with the following standards: EN 300.328 (radio), EN 301 489-1, EN 301 489-17 (electromagnetic compatibility) and EN 60950 (safety). This equipment may be used in all European Union countries and in all countries applying Directive 1999/5/EC, without restriction, with the exception of the following countries:

FRANCE:

When this equipment is used outdoors, output power is limited to within the frequency bands listed below. For more information, consult the ART website: www.art-telecom.fr.

Location	Frequency band (MHz)	Power (EIRP)
Indoor (no restrictions)	2400 – 2483.5	100mW (20dBm)
Outdoor	2400 – 2454	100mW (20dBm)
	2454 – 2483.5	10mW (10dBm)

Operation of this equipment in a residential environment may give rise to radio interference; if so, it is incumbent upon the user to rectify the situation.

ITALY:

This device complies with the National Radio Interface and the requirements of the Frequency Allocation Table. Use of this wireless product outside of the boundaries of the owner's property requires a general authorization. For more information, consult the website www.comunicazioni.it.



Federal Communication Commission Interference Statement

This equipment has been tested and found to comply with the limits for a Class B digital device, pursuant to Part 15 of the FCC Rules. These limits are designed to provide reasonable protection against harmful interference in a residential installation. This equipment generates, uses and can radiate radio frequency energy and, if not installed and used in accordance with the instructions, may cause harmful interference to radio communications. However, there is no guarantee that interference will not occur in a particular installation. If this equipment does cause harmful interference to radio or television reception, which can be determined by turning the equipment off and on, the user is encouraged to try to correct the interference by one of the following measures:

- Reorient or relocate the receiving antenna.
- Increase the separation between the equipment and receiver.
- Connect the equipment into an outlet on a circuit different from that to which the receiver is connected.
- Consult the dealer or an experienced radio/TV technician for help.

This device complies with Part 15 of the FCC Rules. Operation is subject to the following two conditions: (1) This device may not cause harmful interference, and (2) this device must accept any interference received, including interference that may cause undesired operation. This device and its antenna(s) must not be co-located or operating in conjunction with any other antenna or transmitter. FCC Caution: Any changes or modifications not expressly approved by the party responsible for compliance could void the user's authority to operate this equipment.

IMPORTANT NOTE:

FCC Radiation Exposure Statement:

This equipment complies with FCC radiation exposure limits set forth for an uncontrolled environment. This equipment should be installed and operated with minimum distance 20cm between the radiator & your body.

Copyright

© Guillemot Corporation S.A. 2008. All rights reserved.

This publication may not be reproduced in whole or in part, summarized, transmitted, transcribed, stored in a retrieval system, or translated into any language or computer language, in any form or by any means, electronic, mechanical, magnetic, photocopying, recording, manual or otherwise, without the prior written permission of Guillemot Corporation S.A.

Disclaimer

Guillemot Corporation S.A. reserves the right to make changes to specifications at any time and without notice. The information provided by this document is believed to be accurate and reliable. However, no responsibility is assumed by Guillemot Corporation S.A. either for its use or for the infringement of patents or other rights of third parties resulting from its use. This product may exist in a light or special version for PC integration or other purposes. Certain functions detailed in this manual may not be available in these versions. Wherever possible, a README.TXT will be included on the installation CD-ROM detailing the differences between the supplied product and the product described in the present documentation.

End-user software license Agreement

IMPORTANT: please read the Agreement carefully prior to opening and installing the Software. By opening the Software package, you agree to be bound by the terms of this Agreement. The Software enclosed in this package is licensed, not sold, and is only available under the terms of the present license Agreement. If you do not agree with the terms hereafter, you must promptly return the Software within 15 days, together with the entire contents of the box, to the place of purchase.

The Guillemot Corporation S.A. Software (hereafter named the "Software") is copyrighted by Guillemot Corporation S.A. All rights are reserved. The term "Software" refers to all documentation and related material, including drivers, executable programs, libraries and data files. The purchaser is granted a license to use the Software only. The licensee also agrees to be bound by the terms and conditions of the present Agreement concerning copyright and all other proprietary rights for any third party Software, documentation and related material included in the Software package.

Guillemot Corporation S.A. reserves the right to terminate this license in the event of failure to comply with any of the terms or conditions laid out in the present Agreement. On termination, all copies of the Software shall immediately be returned to Guillemot Corporation S.A.; the purchaser remaining liable for any and all resulting damages.

License:

1. The license is granted to the original purchaser only. Guillemot Corporation S.A. retains all title to and ownership of the Software and reserves all rights not expressly granted. The licensee is not permitted to sub-license or lease any of the rights that are hereby granted. Transfer of the license is permitted, provided that the transferor does not retain any part or copy of the Software and the transferee accepts to be bound by the terms and conditions of the present Agreement.
2. The licensee may only use the Software on a single computer at any time. The machine-readable portion of the Software may be transferred to another computer provided it is previously erased from the first machine and there is no possibility that the Software can be used on more than one machine at any one time.
3. The licensee acknowledges the copyright protection belonging to Guillemot Corporation S.A. The copyright notice must not be removed from the Software, nor from any copy thereof, nor from any documentation, written or electronic, accompanying the Software.
4. The licensee is granted the right to make one back-up copy of the machine-readable portion of the Software on the condition that all copyright and proprietary notices are also reproduced.
5. Except where the present Agreement expressly permits, the licensee is strictly prohibited from engaging in, nor may he permit third parties to engage in, the following: providing or disclosing the Software to third parties; providing use of the Software in a network, multiple PCs, multi-user or time-sharing arrangement where the users are not individual licensees; making alterations or copies of any kind of the Software; making any attempt to disassemble, de-compile or reverse engineer the Software in any way or form, or engaging in any activity aimed at obtaining underlying information not visible to the user during normal use of the Software; making copies or translations of the User Manual.