



EMG2926-Q10A

Dual-Band Wireless AC/N Gigabit Ethernet Gateway

Version 1.00
Edition 1, 02/2014



User's Guide

Default Login Details

LAN IP Address	http://192.168.0.1 (Router Mode) http://192.168.0.2 (Access Point Mode)
User Name	admin

IMPORTANT!

READ CAREFULLY BEFORE USE.

KEEP THIS GUIDE FOR FUTURE REFERENCE.

Screenshots and graphics in this book may differ slightly from your product due to differences in your product firmware or your computer operating system. Every effort has been made to ensure that the information in this manual is accurate.

Related Documentation

- Quick Start Guide

The Quick Start Guide shows how to connect the EMG2926-Q10A. It contains information on setting up your network and configuring for Internet access.

Contents Overview

User's Guide	11
Introduction	12
Connection Wizard	18
Introducing the Web Configurator	28
EMG2926-Q10A Modes	31
Easy Mode	32
Router Mode	43
Access Point Mode	50
Tutorials	57
Technical Reference	69
Monitor	70
WAN	75
Wireless LAN	86
LAN	109
DHCP Server	113
NAT	118
DDNS	129
Static Route	131
Firewall	134
Content Filtering	139
Parental Control	142
IPv6 Firewall	146
StreamBoost Management	149
Remote Management	154
Universal Plug-and-Play (UPnP)	161
USB Media Sharing	167
Port Configuration	177
Maintenance	179
Troubleshooting	190

Table of Contents

Contents Overview	3
Table of Contents	4
Part I: User's Guide	11
Chapter 1	
Introduction.....	12
1.1 Overview	12
1.1.1 Dual-Band	13
1.2 Applications	13
1.3 Ways to Manage the EMG2926-Q10A	13
1.4 Good Habits for Managing the EMG2926-Q10A	14
1.5 Resetting the EMG2926-Q10A	14
1.5.1 How to Use the RESET Button	14
1.6 The WPS Button	14
1.7 LEDs	15
1.8 Wall Mounting	17
Chapter 2	
Connection Wizard	18
2.1 Overview	18
2.2 Accessing the Wizard	18
2.3 Connect to Internet	19
2.3.1 Connection Type: IPoE	20
2.3.2 Connection Type: PPPoE	22
2.4 Router Password	23
2.5 Wireless Security	24
2.5.1 Wireless Security: No Security	24
2.5.2 Wireless Security: WPA2-PSK	25
Chapter 3	
Introducing the Web Configurator	28
3.1 Overview	28
3.2 Accessing the Web Configurator	28
3.2.1 Login Screen	28
3.2.2 Password Screen	29

Chapter 4	
EMG2926-Q10A Modes	31
4.1 Overview	31
4.1.1 Web Configurator Modes	31
4.1.2 Device Modes	31
Chapter 5	
Easy Mode	32
5.1 Overview	32
5.2 What You Can Do	33
5.3 What You Need to Know	33
5.4 Navigation Panel	34
5.5 Network Map	34
5.6 Control Panel	35
5.6.1 Power Saving	35
5.6.2 Parental Control	36
5.6.3 Firewall	37
5.6.4 Internet Setting	38
5.6.5 Wireless Security	40
5.6.6 WPS	41
5.7 Status Screen in Easy Mode	41
Chapter 6	
Router Mode	43
6.1 Overview	43
6.2 Router Mode Status Screen	43
6.2.1 Navigation Panel	46
Chapter 7	
Access Point Mode	50
7.1 Overview	50
7.2 What You Can Do	50
7.3 What You Need to Know	50
7.3.1 Setting your EMG2926-Q10A to AP Mode	51
7.3.2 Accessing the Web Configurator in Access Point Mode	51
7.3.3 Configuring your WLAN and Maintenance Settings	52
7.4 AP Mode Status Screen	52
7.4.1 Navigation Panel	54
7.5 LAN Screen	54
Chapter 8	
Tutorials	57
8.1 Overview	57

8.2 Set Up a Wireless Network with WPS	57
8.2.1 Push Button Configuration (PBC)	57
8.2.2 PIN Configuration	58
8.3 Configure Wireless Security without WPS	59
8.3.1 Configure Your Notebook	61
8.4 Using Multiple SSIDs on the EMG2926-Q10A	63
8.4.1 Configuring Security Settings of Multiple SSIDs	64

Part II: Technical Reference..... 69

Chapter 9 Monitor..... 70

9.1 Overview	70
9.2 What You Can Do	70
9.3 The Log Screen	70
9.3.1 View Log	70
9.3.2 Log Setting	71
9.4 DHCP Table	71
9.5 Packet Statistics	72
9.6 WLAN Station Status	73

Chapter 10 WAN..... 75

10.1 Overview	75
10.2 What You Can Do	75
10.3 What You Need To Know	75
10.3.1 Configuring Your Internet Connection	76
10.4 Internet Connection	78
10.4.1 IPoE Encapsulation	78
10.4.2 PPPoE Encapsulation	81
10.5 Advanced WAN Screen	84

Chapter 11 Wireless LAN..... 86

11.1 Overview	86
11.1.1 What You Can Do	87
11.1.2 What You Should Know	87
11.2 General Wireless LAN Screen	91
11.3 Wireless Security	93
11.3.1 No Security	93
11.3.2 WEP Encryption	94

11.3.3 WPA-PSK/WPA2-PSK	96
11.3.4 WPA/WPA2	97
11.4 More AP Screen	99
11.4.1 More AP Edit	100
11.5 MAC Filter Screen	102
11.6 Wireless LAN Advanced Screen	104
11.7 Quality of Service (QoS) Screen	105
11.8 WPS Screen	105
11.9 WPS Station Screen	107
11.10 Scheduling Screen	107
Chapter 12	
LAN	109
12.1 Overview	109
12.2 What You Can Do	109
12.3 What You Need To Know	109
12.3.1 IP Alias	110
12.4 LAN IP Screen	110
12.5 IP Alias Screen	111
12.6 IPv6 LAN Screen	112
Chapter 13	
DHCP Server	113
13.1 Overview	113
13.1.1 What You Can Do	113
13.1.2 What You Need To Know	113
13.2 DHCP Server General Screen	114
13.3 DHCP Server Advanced Screen	114
13.4 DHCP Client List Screen	116
Chapter 14	
NAT.....	118
14.1 Overview	118
14.1.1 What You Can Do	118
14.1.2 What You Need To Know	119
14.2 NAT General Screen	120
14.3 Port Forwarding Screen	121
14.3.1 Port Forwarding Edit Screen	123
14.4 Port Trigger Screen	125
14.5 Technical Reference	126
14.5.1 NATPort Forwarding: Services and Port Numbers	126
14.5.2 NAT Port Forwarding Example	126
14.5.3 Trigger Port Forwarding	127

14.5.4 Trigger Port Forwarding Example	127
14.5.5 Two Points To Remember About Trigger Ports	128
Chapter 15	
DDNS.....	129
15.1 Overview	129
15.1.1 What You Need To Know	129
15.2 General	129
Chapter 16	
Static Route.....	131
16.1 Overview	131
16.2 IP Static Route Screen	131
16.2.1 Add/Edit Static Route	132
Chapter 17	
Firewall.....	134
17.1 Overview	134
17.1.1 What You Can Do	134
17.1.2 What You Need To Know	134
17.2 General Screen	136
17.3 Services Screen	136
Chapter 18	
Content Filtering.....	139
18.1 Overview	139
18.1.1 What You Need To Know	139
18.2 Content Filter	139
18.3 Technical Reference	141
18.3.1 Customizing Keyword Blocking URL Checking	141
Chapter 19	
Parental Control.....	142
19.1 Overview	142
19.2 The Parental Control Screen	142
19.2.1 Add/Edit a Parental Control Rule	143
Chapter 20	
IPv6 Firewall.....	146
20.1 Overview	146
20.2 The IPv6 Firewall Screen	146
Chapter 21	
StreamBoost Management.....	149

21.1 Overview	149
21.2 What You Can Do	150
21.3 Network Screen	150
21.4 Bandwidth Screen	150
21.5 Priorities Screen	152
21.6 Up Time Screen	152
21.7 Downloads Screen	152
21.8 All Events Screen	153
Chapter 22	
Remote Management.....	154
22.1 Overview	154
22.2 What You Can Do in this Chapter	154
22.3 What You Need to Know	154
22.3.1 Remote Management and NAT	155
22.3.2 System Timeout	155
22.4 WWW Screen	155
22.5 Telnet Screen	156
22.6 SNMP	156
22.7 Wake On LAN Screen	159
Chapter 23	
Universal Plug-and-Play (UPnP).....	161
23.1 Overview	161
23.2 What You Need to Know	161
23.2.1 NAT Traversal	161
23.2.2 Cautions with UPnP	161
23.3 UPnP Screen	162
23.4 Technical Reference	162
23.4.1 Using UPnP in Windows XP Example	162
23.4.2 Web Configurator Easy Access	164
Chapter 24	
USB Media Sharing.....	167
24.1 Overview	167
24.2 What You Can Do	168
24.3 What You Need To Know	168
24.4 Before You Begin	169
24.5 DLNA Screen	170
24.6 SAMBA Screen	171
24.7 FTP Screen	172
24.8 Example of Accessing Your Shared Files From a Computer	173
24.8.1 Use Windows Explorer to Share Files	173

24.8.2 Use FTP to Share Files	175
Chapter 25	
Port Configuration	177
25.1 Overview	177
25.2 Port Configuration Screen	177
Chapter 26	
Maintenance	179
26.1 Overview	179
26.2 What You Can Do	179
26.3 General Screen	179
26.4 Account Screen	180
26.4.1 Edit a Users Account	180
26.5 Time Setting Screen	181
26.6 Firmware Upgrade Screen	183
26.7 Configuration Backup/Restore Screen	185
26.8 Restart Screen	186
26.9 Language Screen	186
26.10 System Operation Mode Overview	187
26.11 Sys OP Mode Screen	188
Chapter 27	
Troubleshooting.....	190
27.1 Overview	190
27.2 Power, Hardware Connections, and LEDs	190
27.3 EMG2926-Q10A Access and Login	191
27.4 Internet Access	192
27.5 Resetting the EMG2926-Q10A to Its Factory Defaults	194
27.6 Wireless Connections	194
27.7 USB Device Problems	196
27.8 ZyXEL Share Center Utility Problems	196
Appendix A Legal Information.....	198
Index	203

PART I

User's Guide

Introduction

1.1 Overview

This chapter introduces the main features and applications of the EMG2926-Q10A.

The EMG2926-Q10A extends the range of your existing wired network without additional wiring, providing easy network access to mobile users. You can set up a wireless network with other IEEE 802.11a/ac/b/g/n compatible devices.

A range of services such as a firewall and content filtering are also available for secure Internet computing. The EMG2926-Q10A also supports the new StreamBoost technology, which is smart Quality of Service (QoS), to redistribute traffic over the EMG2926-Q10A for the best possible performance in a home network.

There are two USB 2.0 ports on the side panel of your EMG2926-Q10A. You can connect USB (version 2.0 or lower) memory sticks, USB hard drives, or USB devices for file sharing. The EMG2926-Q10A automatically detects the USB devices.

Two USB eject buttons are located above the USB ports. Push the eject button of the corresponding USB port for 2 seconds. Make sure the USB LED is off before removing your USB device. This will remove your USB device safely, preventing file or data loss if it is being transmitted through the USB device.

Figure 1 USB Ports and Eject Buttons

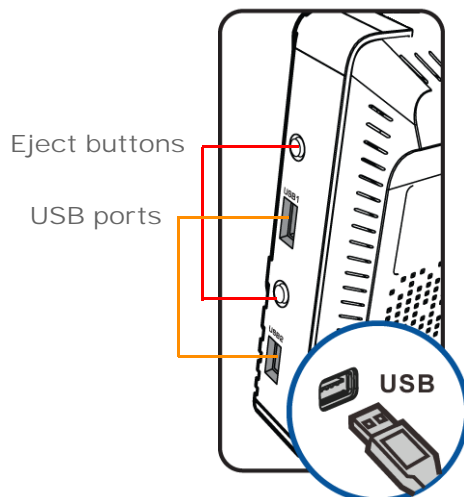

Note: For the USB function, it is strongly recommended to use version 2.0 or lower USB storage devices (such as memory sticks, USB hard drives) and/or USB devices (such as USB printers). Other USB products are not guaranteed to function properly with the EMG2926-Q10A.

1.1.1 Dual-Band

The EMG2926-Q10A is a dual-band AP and able to function both 2.4G and 5G networks at the same time. You could use the 2.4 GHz band for regular Internet surfing and downloading while using the 5 GHz band for time sensitive traffic like high-definition video, music, and gaming.

Figure 2 Dual-Band Application

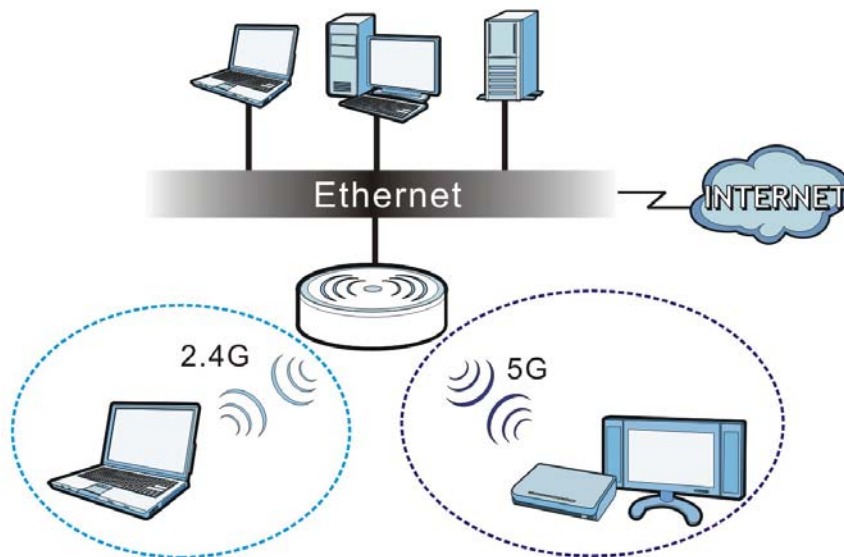

1.2 Applications

You can have the following networks using the EMG2926-Q10A:

- **Wired.** You can connect network devices via the Ethernet ports of the EMG2926-Q10A so that they can communicate with each other and access the Internet.
- **Wireless.** Wireless clients can connect to the EMG2926-Q10A to access network resources. You can use WPS (Wi-Fi Protected Setup) to create an instant network connection with another WPS-compatible device.
- **WAN.** Connect to a broadband modem/router for Internet access.

1.3 Ways to Manage the EMG2926-Q10A

Use any of the following methods to manage the EMG2926-Q10A.

- **WPS (Wi-Fi Protected Setup).** You can use the WPS button or the WPS section of the Web Configurator to set up a wireless network with your ZyXEL Device.
- **Web Configurator.** This is recommended for everyday management of the EMG2926-Q10A using a (supported) web browser.

1.4 Good Habits for Managing the EMG2926-Q10A

Do the following things regularly to make the EMG2926-Q10A more secure and to manage the EMG2926-Q10A more effectively.

- Change the password. Use a password that's not easy to guess and that consists of different types of characters, such as numbers and letters.
- Write down the password and put it in a safe place.
- Back up the configuration (and make sure you know how to restore it). Restoring an earlier working configuration may be useful if the device becomes unstable or even crashes. If you forget your password, you will have to reset the EMG2926-Q10A to its factory default settings. If you backed up an earlier configuration file, you would not have to totally re-configure the EMG2926-Q10A. You could simply restore your last configuration.

1.5 Resetting the EMG2926-Q10A

If you forget your password or IP address, or you cannot access the Web Configurator, you will need to use the **RESET** button at the back of the EMG2926-Q10A to reload the factory-default configuration file. This means that you will lose all configurations that you had previously saved, **the user name will be reset to "admin" and the IP address will be reset to "192.168.0.1"**.

1.5.1 How to Use the RESET Button

- 1 Make sure the power LED is on.
- 2 Press the **RESET** button for one to four seconds to restart/reboot the EMG2926-Q10A.
- 3 Press the **RESET** button for longer than five seconds to set the EMG2926-Q10A back to its factory-default configurations.

1.6 The WPS Button

Your EMG2926-Q10A supports Wi-Fi Protected Setup (WPS), which is an easy way to set up a secure wireless network. WPS is an industry standard specification, defined by the Wi-Fi Alliance.

WPS allows you to quickly set up a wireless network with strong security, without having to configure security settings manually. Each WPS connection works between two devices. Both devices must support WPS (check each device's documentation to make sure).

Depending on the devices you have, you can either press a button (on the device itself, or in its configuration utility) or enter a PIN (a unique Personal Identification Number that allows one device to authenticate the other) in each of the two devices. When WPS is activated on a device, it has two minutes to find another device that also has WPS activated. Then, the two devices connect and set up a secure network by themselves.

You can use the WPS button () on the front panel of the EMG2926-Q10A to activate WPS in order to quickly set up a wireless network with strong security.

- 1 Make sure the power LED is on (not blinking).
- 2 Press the WPS button for more than three seconds and release it. Press the WPS button on another WPS-enabled device within range of the EMG2926-Q10A.

Note: You must activate WPS in the EMG2926-Q10A and in another wireless device within two minutes of each other.

For more information on using WPS, see [Section 8.2 on page 57](#).

1.7 LEDs

Look at the LED lights on the front panel to determine the status of the EMG2926-Q10A. Use the **LED** button at the side panel of the device to turn the LED lights on or off. If you have already pushed the **LED** button to the **ON** position but none of the LEDs are on, make sure the EMG2926-Q10A is receiving power and the power is turned on.

Note: The **Power** LED will be on even if you push the **LED** button to the **OFF** position. This is for you to determine whether the EMG2926-Q10A is powered on.

Figure 3 LED Button

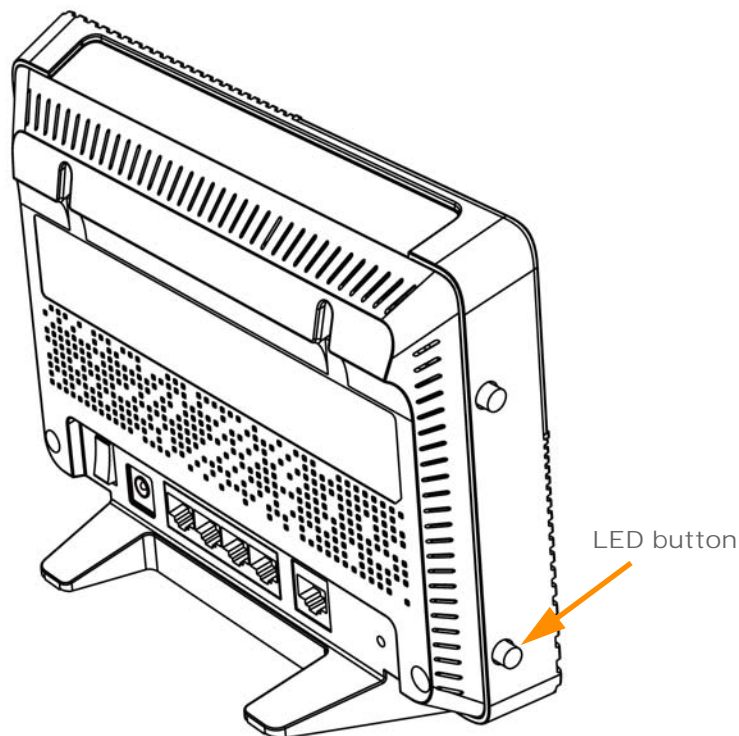
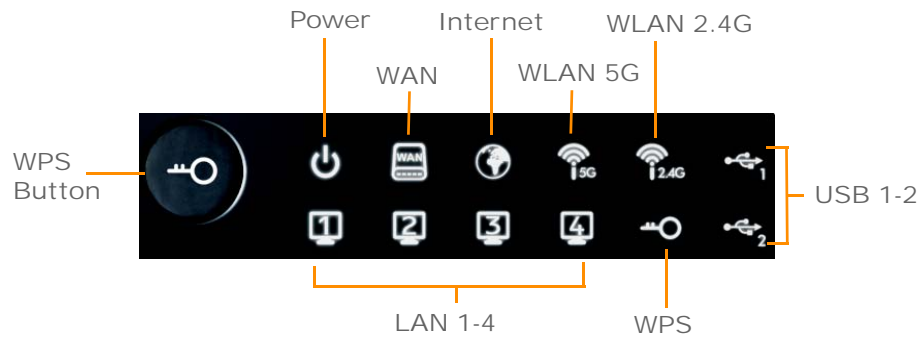

Figure 4 Front Panel

The following table describes the LEDs and the WPS button.

Table 1 Front panel LEDs and WPS button

LED	STATUS	DESCRIPTION
WPS Button		Press this button for 1 second to set up a wireless connection via WiFi Protected Setup with another WPS-enabled client. You must press the WPS button on the client side within 120 seconds for a successful connection. See Section 1.6 on page 14 and Chapter 9 on page 57 for more information on WPS.
Power	On	The EMG2926-Q10A is receiving power and functioning properly.
	Off	The EMG2926-Q10A is not receiving power.
WAN	On	The EMG2926-Q10A's WAN connection is ready.
	Blinking	The EMG2926-Q10A is sending/receiving data through the WAN with a 1000Mbps transmission rate.
	Off	The WAN connection is not ready, or has failed.
Internet	On	The EMG2926-Q10A has an IP connection but no traffic. Your device has a WAN IP address (either static or assigned by a DHCP server), PPP negotiation was successfully completed (if used) and the connection is up.
	Blinking	The EMG2926-Q10A is sending or receiving IP traffic.
	Off	The EMG2926-Q10A does not have an IP connection.
WLAN 2.4/5G	On	The EMG2926-Q10A is ready, but is not sending/receiving data through the 5G wireless LAN.
	Blinking	The EMG2926-Q10A is sending/receiving data through the 5G wireless LAN. The EMG2926-Q10A is negotiating a WPS connection with a wireless client.
	Off	The wireless LAN is not ready or has failed.
LAN 1-4	On	The EMG2926-Q10A's LAN connection is ready.
	Blinking	The EMG2926-Q10A is sending/receiving data through the LAN with a 1000Mbps transmission rate.
	Off	The LAN connection is not ready, or has failed.
USB 1-2	On	The EMG2926-Q10A has a USB device installed.
	Blinking	The EMG2926-Q10A is transmitting and/or receiving data from routers through an installed USB device.
	Off	There is no USB device connected to the EMG2926-Q10A.

1.8 Wall Mounting

You may need screw anchors if mounting on a concrete or brick wall.

Table 2 Wall Mounting Information

Distance between holes	12.7 cm
M4 Screws	Two
Screw anchors (optional)	Two

- 1 Select a position free of obstructions on a wall strong enough to hold the weight of the device.
- 2 Mark two holes on the wall at the appropriate distance apart for the screws.

Be careful to avoid damaging pipes or cables located inside the wall when drilling holes for the screws.

- 3 If using screw anchors, drill two holes for the screw anchors into the wall. Push the anchors into the full depth of the holes, then insert the screws into the anchors. Do not insert the screws all the way in - leave a small gap of about 0.5 cm.

If not using screw anchors, use a screwdriver to insert the screws into the wall. Do not insert the screws all the way in - leave a gap of about 0.5 cm.

- 4 Make sure the screws are fastened well enough to hold the weight of the EMG2926-Q10A with the connection cables.
- 5 Align the holes on the back of the EMG2926-Q10A with the screws on the wall. Hang the EMG2926-Q10A on the screws.

Figure 5 Wall Mounting Example

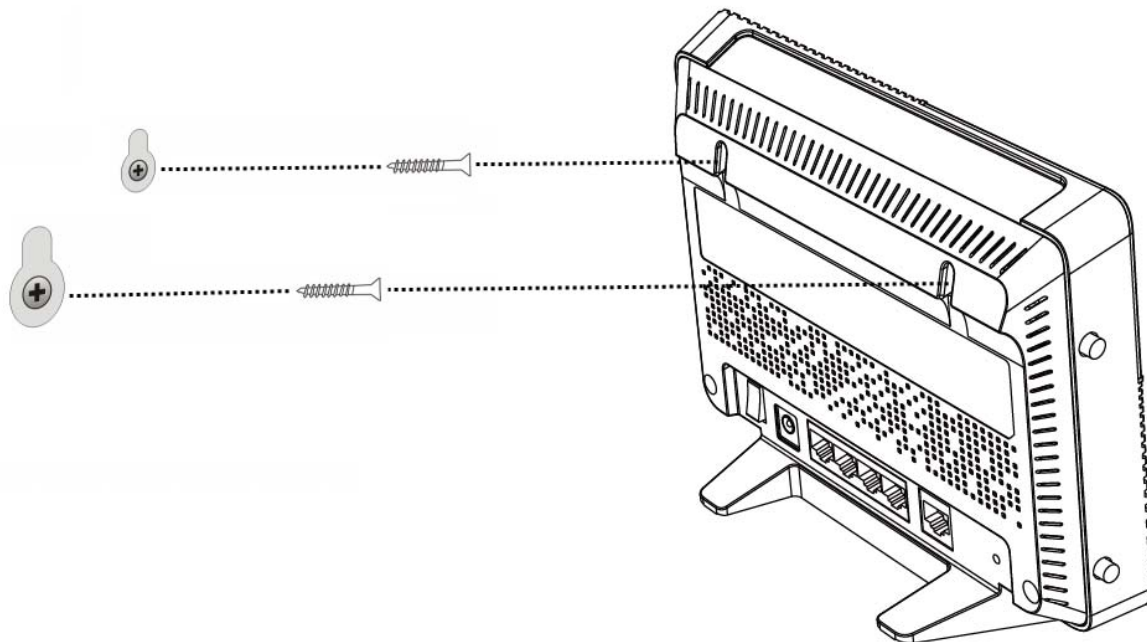

Connection Wizard

2.1 Overview

This chapter provides information on the wizard setup screens in the Web Configurator.

The Web Configurator's wizard setup helps you configure your device to access the Internet. Refer to your ISP for your Internet account information. Leave a field blank if you don't have that information.

2.2 Accessing the Wizard

Launch your web browser and type "http://192.168.0.1" as the website address. Type "admin" (default) as the user name and leave the password field blank. Click **Login**.

Note: The Wizard appears when the EMG2926-Q10A is accessed for the first time or when you reset the EMG2926-Q10A to its default factory settings.

If you have already configured the wizard screens and want to open it again, click the **eaZy123** icon on the network map screen in **Easy Mode**.

The Web Configurator is set to **Easy Mode** by default after login. If you are in **Expert Mode**, you can click the **Easy Mode** icon on the upper right corner of any Web Configurator screen to go to **Easy Mode**.

The Wizard screen opens. Choose your **Language** and click **Connect to Internet**.

Figure 6 Welcome

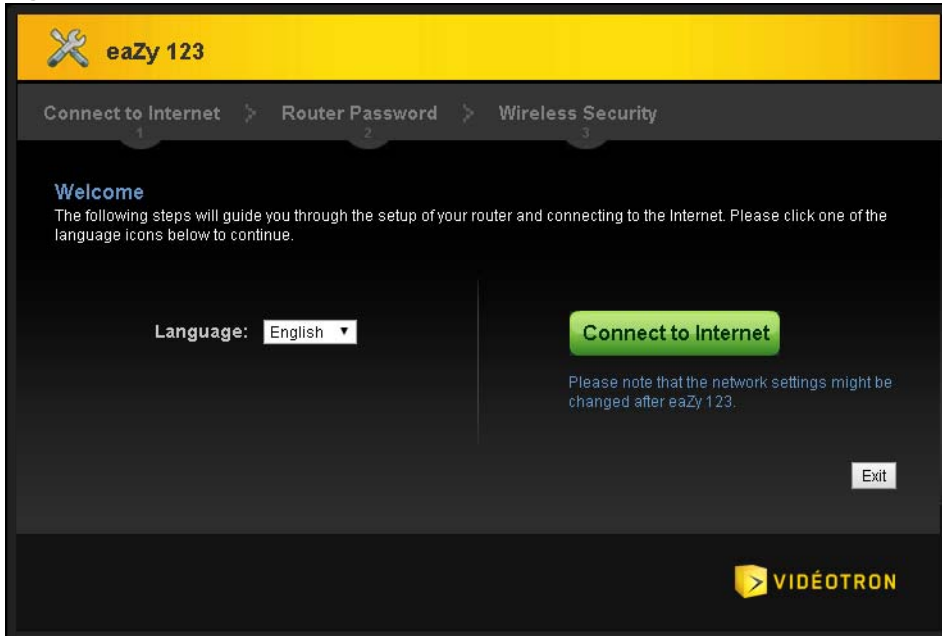

2.3 Connect to Internet

The EMG2926-Q10A offers two Internet connection types. They are **IPoE** or **PPPoE**. The wizard attempts to detect which WAN connection type you are using.

Figure 7 Detecting your Internet Connection Type

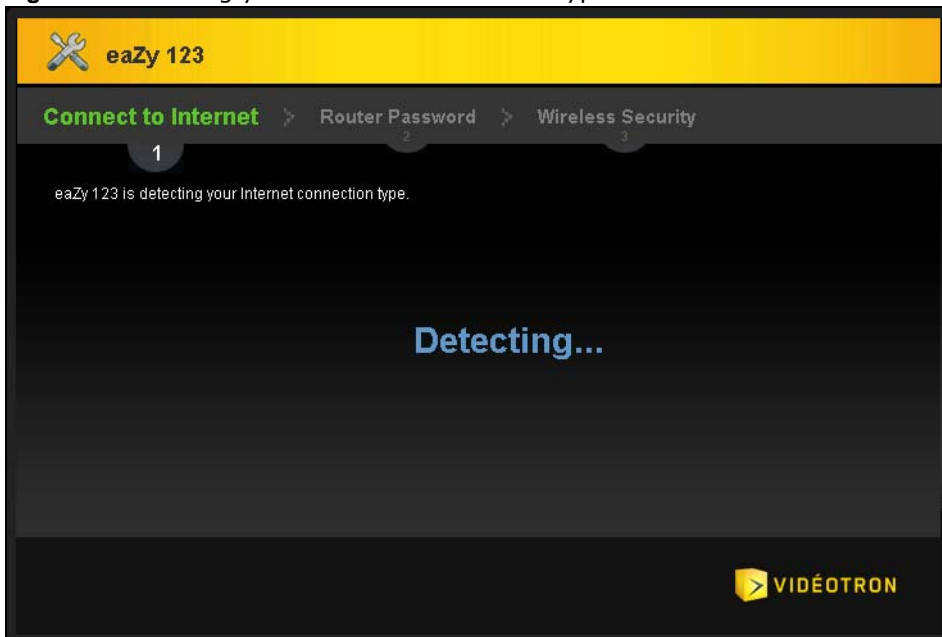

If the wizard does not detect a connection type, you must select one from the drop-down list box. Check with your ISP to make sure you use the correct type.

Note: If you get an error message, check your hardware connections. Make sure your Internet connection is up and running.

The following screen depends on your Internet connection type. Enter the details provided by your Internet Service Provider (ISP) in the fields (if any).

Figure 8 Internet Connection Type

The screenshot shows the 'Connect to Internet' configuration screen in the eaZy 123 router's web interface. The breadcrumb trail indicates the current step is '1 Connect to Internet', with 'Router Password' (step 2) and 'Wireless Security' (step 3) as subsequent steps. The 'Internet Connection Type' is set to 'IPoE'. Below this, there are radio buttons for 'Obtain an IP Address Automatically' (selected) and 'Static IP Address'. Fields for IP Address, Subnet Mask, and Gateway IP address are present but empty. DNS server information is populated: 'First DNS Server' is 'Obtained From ISP' with the value '172.13.7.2', and 'Second DNS Server' is 'Obtained From ISP' with the value '172.13.7.1'. 'Exit', 'Back', and 'Next' buttons are at the bottom right. The VIDÉOTRON logo is in the bottom right corner.

Your EMG2926-Q10A detects the following Internet Connection type.

Table 3 Internet Connection Type

CONNECTION TYPE	DESCRIPTION
IPoE	Select the IPoE (IP over Ethernet) option when the WAN port is used as a regular Ethernet.
PPPoE	Select the PPPoE (Point-to-Point Protocol over Ethernet) option for a dial-up connection.

2.3.1 Connection Type: IPoE

Choose **IPoE** as the **Internet Connection Type** when the WAN port is used as a regular Ethernet. Click **Next**.

Figure 9 Internet Connection Type: IPoE

The following table describes the labels in this screen.

Table 4 Internet Connection Type: IPoE

LABEL	DESCRIPTION
Internet Connection Type	Select the IPoE option.
Obtain an IP Address Automatically	Select this radio button if your ISP did not assign you a fixed IP address.
Static IP Address	Select this radio button if your ISP assigned an IP address for your Internet connection.
IP Address	Enter the IP address provided by your ISP.
Subnet Mask	Enter the IP subnet mask in this field.
Gateway IP Address	Enter the gateway IP address in this field.
First DNS Server Second DNS Server	Select Obtained From ISP if your ISP dynamically assigns DNS server information (and the EMG2926-Q10A's WAN IP address). The field to the right displays the (read-only) DNS server IP address that the ISP assigns. Select User-Defined if you have the IP address of a DNS server. Enter the DNS server's IP address in the field to the right. Select None if you do not want to configure DNS servers. If you do not configure a DNS server, you must know the IP address of a computer in order to access it.
Exit	Click this to close the wizard screen without saving.
Back	Click this to return to the previous screen.
Next	Click this to continue.

Note: If you get an error screen after clicking **Next**, you might have selected the wrong Internet Connection type. Click **Back**, make sure your Internet connection is working and select the right Connection Type. Contact your ISP if you are not sure of your Internet Connection type.

2.3.2 Connection Type: PPPoE

Point-to-Point Protocol over Ethernet (PPPoE) functions as a dial-up connection. PPPoE is an IETF (Internet Engineering Task Force) standard specifying how a host personal computer interacts with a broadband modem (for example DSL, cable, wireless, etc.) to achieve access to high-speed data networks.

For the service provider, PPPoE offers an access and authentication method that works with existing access control systems (for instance, RADIUS).

One of the benefits of PPPoE is the ability to let end users access one of multiple network services, a function known as dynamic service selection. This enables the service provider to easily create and offer new IP services for specific users.

Operationally, PPPoE saves significant effort for both the subscriber and the ISP/carrier, as it requires no specific configuration of the broadband modem at the subscriber's site.

By implementing PPPoE directly on the EMG2926-Q10A (rather than individual computers), the computers on the LAN do not need PPPoE software installed, since the EMG2926-Q10A does that part of the task. Furthermore, with NAT, all of the LAN's computers will have Internet access.

Figure 10 Internet Connection Type: PPPoE

The following table describes the labels in this screen.

Table 5 Internet Connection Type: PPPoE

LABEL	DESCRIPTION
Internet Connection Type	Select the PPPoE option for a dial-up connection.
Get automatically from ISP	Select this radio button if your ISP did not assign you a fixed IP address.
Use Fixed IP Address	Select this radio button, provided by your ISP to give the EMG2926-Q10A a fixed, unique IP address.

Table 5 Internet Connection Type: PPPoE (continued)

LABEL	DESCRIPTION
PPP Username	Type the user name given to you by your ISP.
PPP Password	Type the password associated with the user name above.
My WAN IP Address	Type the name of your service provider.
Exit	Click this to close the wizard screen without saving.
Back	Click this to return to the previous screen.
Next	Click this to continue.

The EMG2926-Q10A connects to the Internet.

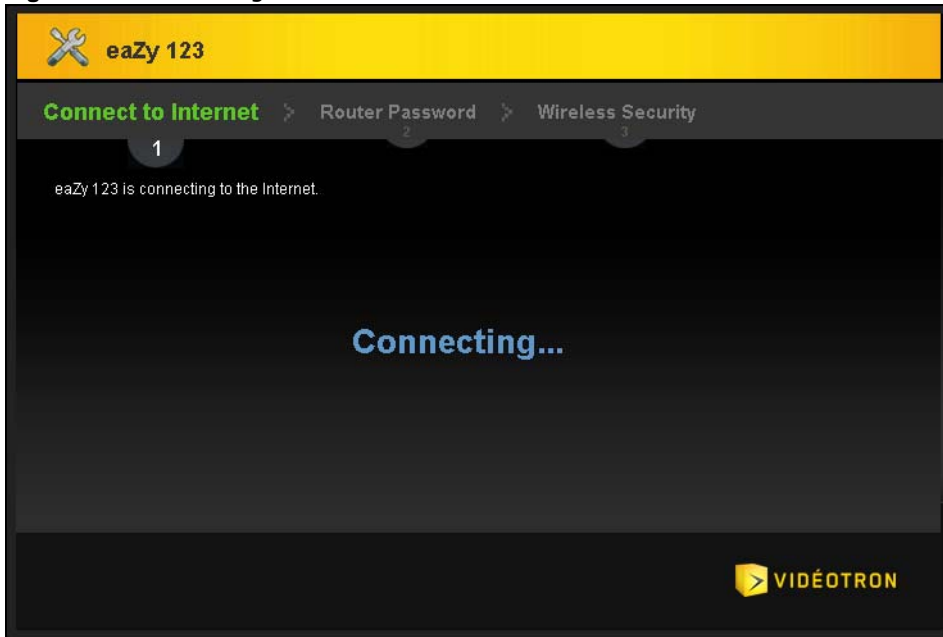
Figure 11 Connecting to the Internet

Note: If the Wizard successfully connects to the Internet, it proceeds to the next step. If you get an error message, go back to the previous screen and make sure you have entered the correct information provided by your ISP.

2.4 Router Password

Change the login password in the following screen. Enter the new password and retype it to confirm. Click **Next** to proceed with the **Wireless Security** screen.

Figure 12 Router Password

The screenshot shows the 'Router Password' configuration screen in the 'eaZy 123' interface. The top navigation bar includes 'Connect to Internet', 'Router Password', and 'Wireless Security'. The 'Router Password' step is highlighted with a green checkmark and the number '2'. The main content area is titled 'Change router password' and includes a note: 'It is highly recommended to have a new administrator password instead of the factory default one (blank)'. Below this, there are two input fields: 'New Password :' and 'Retype to Confirm :'. At the bottom right, there are three buttons: 'Exit', 'Back', and 'Next'. The 'VIDÉOTRON' logo is visible in the bottom right corner.

2.5 Wireless Security

Configure Wireless Settings. Configure the wireless network settings on your EMG2926-Q10A in the following screen. The fields that show up depend on the kind of security you select.

2.5.1 Wireless Security: No Security

Choose **No Security** in the Wireless Security screen to let wireless devices within range access your wireless network.

Figure 13 Wireless Security: No Security

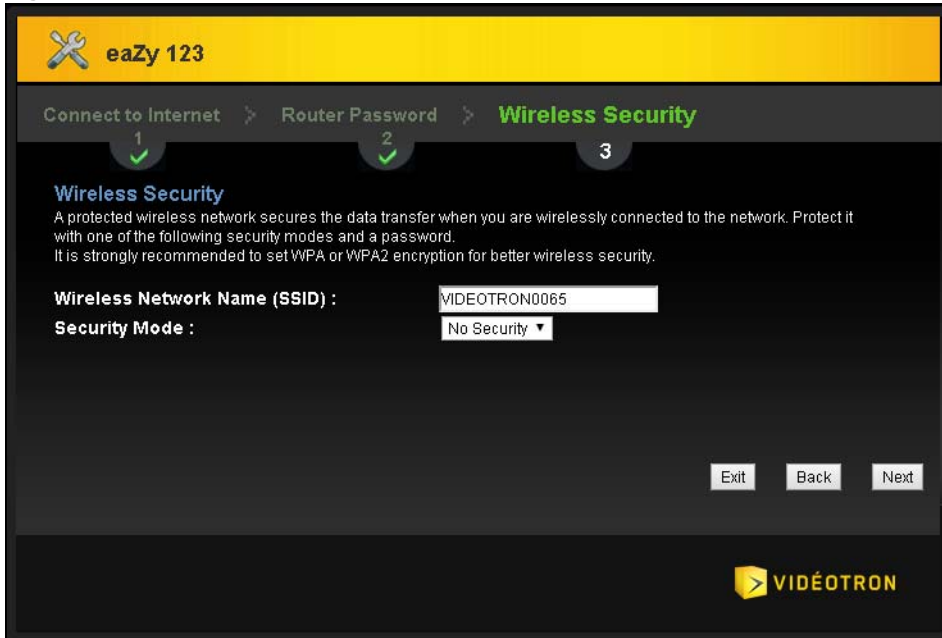

The following table describes the labels in this screen.

Table 6 Wireless Security: No Security

LABEL	DESCRIPTION
Wireless Radio	Choose whether you want to apply the wireless security to 2.4G Hz or 5G Hz wireless radio.
Wireless Network Name (SSID)	Enter a descriptive name (up to 32 printable 7-bit ASCII characters) for the wireless LAN. If you change this field on the EMG2926-Q10A, make sure all wireless stations use the same SSID in order to access the network.
Security Mode	Select a security level from the drop-down list box. Choose No Security to have no wireless LAN security configured. If you do not enable any wireless security on your EMG2926-Q10A, your network is accessible to any wireless networking device that is within range.
Exit	Click this to close the wizard screen without saving.
Back	Click this to return to the previous screen.
Next	Click this to continue.

2.5.2 Wireless Security: WPA2-PSK

Choose **WPA2-PSK** security in the Wireless Security screen to set up a password for your wireless network.

Figure 14 Wireless Security: WPA2-PSK

The following table describes the labels in this screen.

Table 7 Wireless Security: WPA2-PSK

LABEL	DESCRIPTION
Wireless Radio	Choose whether you want to apply the wireless security to 2.4G Hz or 5G Hz wireless radio.
Wireless Network Name (SSID)	Enter a descriptive name (up to 32 printable 7-bit ASCII characters) for the wireless LAN. If you change this field on the EMG2926-Q10A, make sure all wireless stations use the same SSID in order to access the network.
Security Mode	Select a security level from the drop-down list box. Choose WPA2-PSK security to configure a Pre-Shared Key. Choose this option only if your wireless clients support WPA2-PSK.
Wireless password	Type from 8 to 63 case-sensitive ASCII characters. You can set up the most secure wireless connection by configuring WPA in the wireless LAN screens.
Verify Password	Retype the password to confirm.
Exit	Click this to close the wizard screen without saving.
Back	Click this to return to the previous screen.
Next	Click this to continue.

Congratulations! Open a web browser, such as Internet Explorer, to visit your favorite website.

Note: If you cannot access the Internet when your computer is connected to one of the EMG2926-Q10A's LAN ports, check your connections. Then turn the EMG2926-Q10A off, wait for a few seconds then turn it back on. If that does not work, log in to the web configurator again and check you have typed all information correctly. See the User's Guide for more suggestions.

Figure 15 Congratulations



You can also click **GO** to open the **Easy Mode** Web Configurator of your EMG2926-Q10A.

You have successfully set up your EMG2926-Q10A to operate on your network and access the Internet. You are now ready to connect wirelessly to your EMG2926-Q10A and access the Internet.

Introducing the Web Configurator

3.1 Overview

This chapter describes how to access the EMG2926-Q10A Web Configurator and provides an overview of its screens.

The Web Configurator is an HTML-based management interface that allows easy setup and management of the EMG2926-Q10A via Internet browser. Use Internet Explorer 9.0 and later versions, Mozilla Firefox 21 and later versions, Safari 6.0 and later versions or Google Chrome 26.0 and later versions. The recommended screen resolution is 1024 by 768 pixels.

In order to use the Web Configurator you need to allow:

- Web browser pop-up windows from your device. Web pop-up blocking is enabled by default in Windows XP SP (Service Pack) 2.
- JavaScript (enabled by default).
- Java permissions (enabled by default).

Refer to the Troubleshooting chapter ([Chapter 27 on page 190](#)) to see how to make sure these functions are allowed in Internet Explorer.

3.2 Accessing the Web Configurator

- 1 Make sure your EMG2926-Q10A hardware is properly connected and prepare your computer or computer network to connect to the EMG2926-Q10A (refer to the Quick Start Guide).
- 2 Launch your web browser.
- 3 The EMG2926-Q10A is in router mode by default. Type "<http://192.168.0.1>" as the website address.

If the EMG2926-Q10A is in access point, the IP address is [192.168.0.2](#). See [Chapter 4 on page 31](#) for more information about the modes of the EMG2926-Q10A.

Your computer must be in the same subnet in order to access this website address.

3.2.1 Login Screen

Note: If this is the first time you are accessing the Web Configurator, you may be redirected to the Wizard. Refer to [Chapter 2 on page 18](#) for the Connection Wizard screens.

The Web Configurator initially displays the following login screen.

Figure 16 Login screen

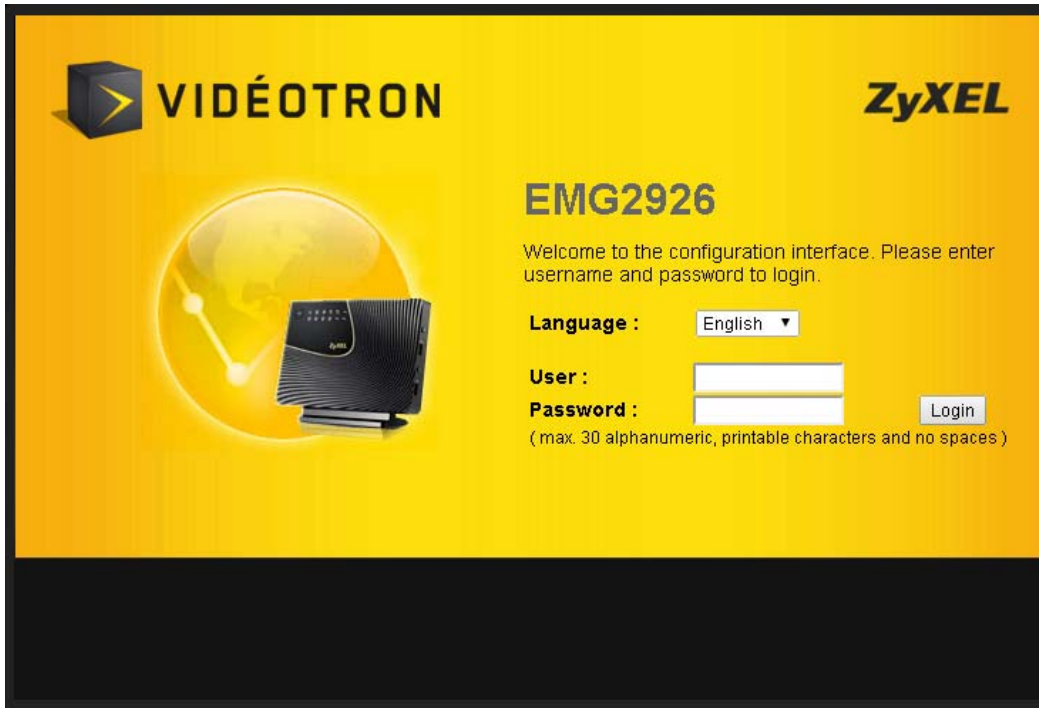

The following table describes the labels in this screen.

Table 8 Login screen

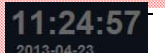
LABEL	DESCRIPTION
Language	Select the language you want to use to configure the Web Configurator.
User	Type "admin" (default) as the user name. Click Login .
Password	Type "1234" (default) as the password. Click Login . Leave this field blank.
	This shows the current weather, either in celsius or fahrenheit, of the city you specify in Section 3.2.2.1 on page 30 .
	This shows the time (hh:mm:ss) and date (yyyy:mm:dd) of the timezone you select in Section 26.5 on page 181 . The time is in 24-hour format, for example 15:00 is 3:00 PM.

3.2.2 Password Screen

You should see a screen asking you to change your password (highly recommended) as shown next.

Figure 17 Change Password Screen

The following table describes the labels in this screen.

Table 9 Change Password Screen

LABEL	DESCRIPTION
New Password	Type a new password.
Retype to Confirm	Retype the password for confirmation.
Apply	Click Apply to save your changes back to the EMG2926-Q10A.
Ignore	Click Ignore if you do not want to change the password this time.

Note: The management session automatically times out when the time period set in the **Administrator Inactivity Timer** field expires (default five minutes; go to [Chapter 26 on page 179](#) to change this). Simply log back into the EMG2926-Q10A if this happens.

3.2.2.1 ~~Weather-Edit~~

~~You can change the temperature unit and select the location for which you want to know the weather.~~

~~Click the  icon to change the Weather display.~~

Figure 18 ~~Change Weather~~

~~The following table describes the labels in this screen:~~

Table 10 ~~Change Weather~~

LABEL	DESCRIPTION
Change Unit	Choose which temperature unit you want the EMG2926-Q10A to display.
Change Location	Select the location for which you want to know the weather. If the city you want is not listed, choose one that is closest to it.
Finish	Click this to apply the settings and refresh the date and time display.

EMG2926-Q10A Modes

4.1 Overview

This chapter introduces the different modes available on your EMG2926-Q10A. First, the term “mode” refers to two things in this User’s Guide.

- **Web Configurator mode.** This refers to the Web Configurator interface you want to use for editing EMG2926-Q10A features.
- **Device mode.** This is the operating mode of your EMG2926-Q10A, or simply how the EMG2926-Q10A is being used in the network.

4.1.1 Web Configurator Modes

This refers to the configuration interface of the Web Configurator, which has two modes:

- **Easy Mode:** The Web Configurator shows this mode by default. Refer to [Chapter 5 on page 32](#) for more information on the screens in this mode. This interface may be sufficient for users who just want to use the device.
- **Expert Mode:** Advanced users can change to this mode to customize all the functions of the EMG2926-Q10A. Click **Expert Mode** after logging into the Web Configurator. The User’s Guide [Chapter 3 on page 28](#) through [Chapter 26 on page 188](#) discusses the screens in this mode.

4.1.2 Device Modes

This refers to the operating mode of the EMG2926-Q10A, which can act as a:

- **Router:** This is the default device mode of the EMG2926-Q10A. Use this mode to connect the local network to another network, like the Internet. Go to [Section 6.2 on page 43](#) to view the **Status** screen in this mode.
- **Access Point:** Use this mode if you want to extend your network by allowing network devices to connect to the EMG2926-Q10A wirelessly. Go to [Section 7.4 on page 52](#) to view the **Status** screen in this mode.

For more information on these modes and to change the mode of your EMG2926-Q10A, refer to [Chapter 26 on page 188](#).

The menu for changing device modes is available in **Expert Mode** only.

Note: Choose your device mode carefully to avoid having to change it later.

When changing to another mode, the IP address of the EMG2926-Q10A changes. The running applications and services of the network devices connected to the EMG2926-Q10A can be interrupted.

Easy Mode

5.1 Overview

The Web Configurator is set to **Easy Mode** by default. You can configure several key features of the EMG2926-Q10A in this mode. This mode is useful to users who are not fully familiar with some features that are usually intended for network administrators.

When you log in to the Web Configurator, the following screen opens.

Figure 19 Easy Mode: Network Map

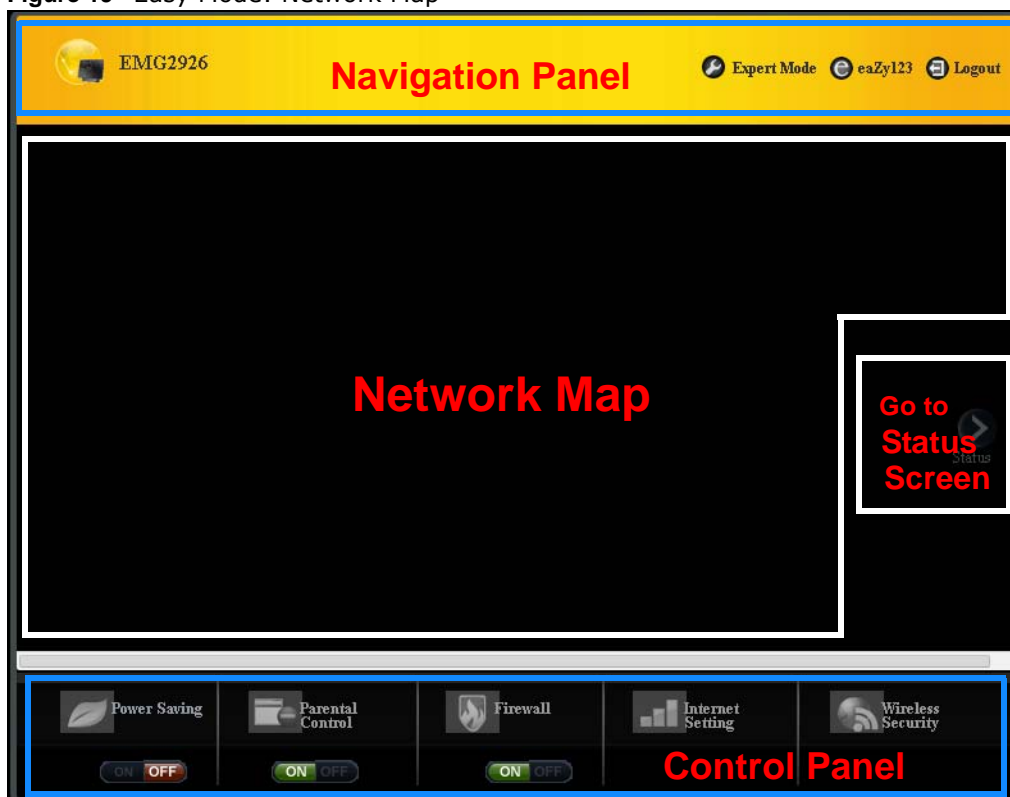

Click **Status** to open the following screen.

Figure 20 Easy Mode: Status Screen

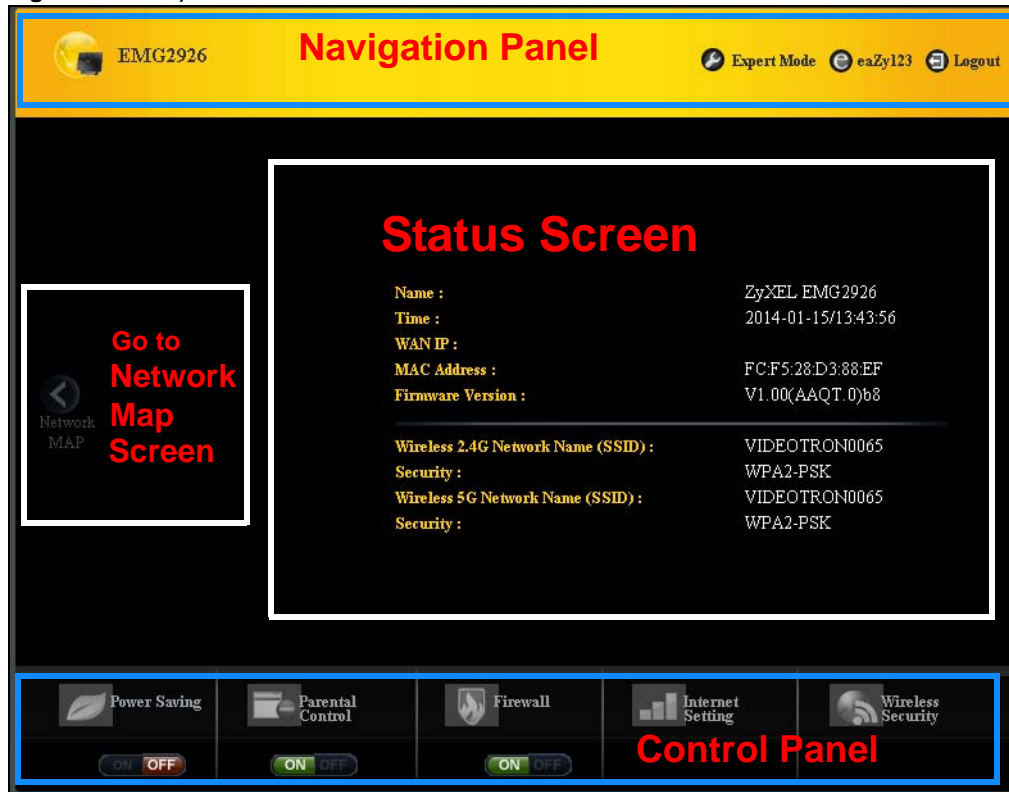

5.2 What You Can Do

You can do the following in this mode:

- Use the **Navigation Panel** to opt out of the **Easy Mode** ([Section 5.4 on page 34](#)).
- Use the **Network Map** screen to check whether your EMG2926-Q10A is connected to the Internet or any networking devices and view the transmission speed between them **when StreamBoost is enabled. At the time of writing, the StreamBoost feature is turned off on the EMG2926-Q10A.**
- Use the **Control Panel** to configure and enable EMG2926-Q10A features, including wireless scheduling, wireless security, **parental control**, firewall and so on ([Section 5.6 on page 35](#)).
- Use the **Status Screen** to view read-only information about the EMG2926-Q10A, including the WAN IP, MAC address of the EMG2926-Q10A, the firmware version and wireless settings ([Section 5.7 on page 41](#)).

5.3 What You Need to Know

Between the different device modes, the **Control Panel** ([Section 5.6 on page 35](#)) changes depending on which features are applicable to the mode:

- **Router Mode:** All **Control Panel** features are available.

- **Access Point Mode:** Only **Power Saving** and **Wireless Security** are available.

5.4 Navigation Panel

Use this navigation panel to opt out of the **Easy Mode**.

Figure 21 Control Panel



The following table describes the labels in this screen.

Table 11 Control Panel

ITEM	DESCRIPTION
Expert Mode	Click this to change to Expert Mode and customize features of the EMG2926-Q10A.
eaZy123	Click this icon to open the setup wizard.
Logout	Click this to end the Web Configurator session and go to the Login page.

5.5 ~~Network Map~~

~~When you log into the Web Configurator, the Network Map is shown as follows.~~

Figure 22 ~~Network Map~~

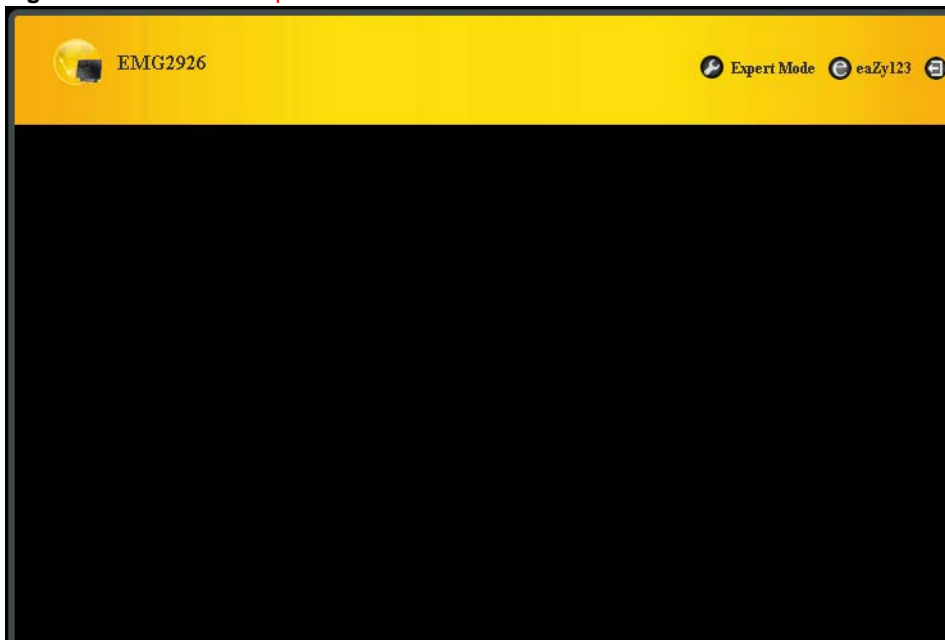

You can view the upstream and downstream transmission speed between the EMG2926-Q10A and the Internet and/or between the EMG2926-Q10A and the connected device(s) (represented by icons indicating the kind of network device), including those connecting wirelessly.

5.6 Control Panel

The features configurable in **Easy Mode** are shown in the **Control Panel**.

Figure 23 Control Panel

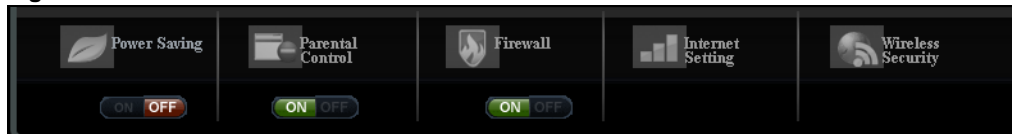

Switch **ON** to enable the feature. Otherwise, switch **OFF**. If the feature is turned on, the green light flashes. If it is turned off, the red light flashes.

Additionally, click the feature to open a screen where you can edit its settings.

The following table describes the labels in this screen.

Table 12 Control Panel

ITEM	DESCRIPTION
Power Saving	Click this to schedule the wireless feature of the EMG2926-Q10A. Disabling the wireless function helps lower the energy consumption of the EMG2926-Q10A. Switch ON to apply wireless scheduling. Otherwise, switch OFF . Refer to Section 5.6.1 on page 35 to see this screen.
Parental Control	Click this to restrict access to certain websites, based on keywords contained in URLs, to which you do not want users in your network to open. Switch ON to apply website filtering. Otherwise, switch OFF . Refer to Section 5.6.2 on page 36 to see this screen.
Firewall	Switch ON to ensure that your network is protected from Denial of Service (DoS) attacks. Otherwise, switch OFF . Refer to Section 5.6.3 on page 37 to see this screen.
Internet Setting	Click this to configure the Internet connection settings. Refer to Section 5.6.4 on page 38 to see this screen.
Wireless Security	Click this to configure the wireless security, such as SSID, security mode and WPS key on your EMG2926-Q10A. Refer to Section 5.6.5 on page 40 to see this screen.

5.6.1 Power Saving

Use this screen to set the day of the week and time of the day when your wireless LAN is turned on and off. Wireless LAN scheduling is disabled by default.

Disabling the wireless capability lowers the energy consumption of the of the EMG2926-Q10A.

Figure 24 Power Saving

Power Saving

Please schedule the wireless service with the table below.

Wireless Radio : 2.4G Hz ▼

WLAN status	Day	For the following times (24-Hour Format)			
<input type="radio"/> On <input checked="" type="radio"/> Off	<input type="checkbox"/> Everyday	00 ▼ (hour)	00 ▼ (min)	~	00 ▼ (hour) 00 ▼ (min)
<input type="radio"/> On <input checked="" type="radio"/> Off	<input type="checkbox"/> Mon	00 ▼ (hour)	00 ▼ (min)	~	00 ▼ (hour) 00 ▼ (min)
<input type="radio"/> On <input checked="" type="radio"/> Off	<input type="checkbox"/> Tue	00 ▼ (hour)	00 ▼ (min)	~	00 ▼ (hour) 00 ▼ (min)
<input type="radio"/> On <input checked="" type="radio"/> Off	<input type="checkbox"/> Wed	00 ▼ (hour)	00 ▼ (min)	~	00 ▼ (hour) 00 ▼ (min)
<input type="radio"/> On <input checked="" type="radio"/> Off	<input type="checkbox"/> Thu	00 ▼ (hour)	00 ▼ (min)	~	00 ▼ (hour) 00 ▼ (min)
<input type="radio"/> On <input checked="" type="radio"/> Off	<input type="checkbox"/> Fri	00 ▼ (hour)	00 ▼ (min)	~	00 ▼ (hour) 00 ▼ (min)
<input type="radio"/> On <input checked="" type="radio"/> Off	<input type="checkbox"/> Sat	00 ▼ (hour)	00 ▼ (min)	~	00 ▼ (hour) 00 ▼ (min)
<input type="radio"/> On <input checked="" type="radio"/> Off	<input type="checkbox"/> Sun	00 ▼ (hour)	00 ▼ (min)	~	00 ▼ (hour) 00 ▼ (min)

Apply Cancel

The following table describes the labels in this screen.

Table 13 Power Saving

LABEL	DESCRIPTION
Wireless Radio	Choose whether you want to apply the power saving schedule to 2.4G Hz or 5G Hz wireless radio.
WLAN Status	Select On or Off to specify whether the Wireless LAN is turned on or off (depending on what you selected in the WLAN Status field). This field works in conjunction with the Day and For the following times fields.
Day	Select Everyday or the specific days to turn the Wireless LAN on or off. If you select Everyday you can not select any specific days. This field works in conjunction with the For the following times field.
For the following times (24-Hour Format)	Select a begin time using the first set of hour and minute (min) drop down boxes and select an end time using the second set of hour and minute (min) drop down boxes. If you have chosen On earlier for the WLAN Status the Wireless LAN will turn on between the two times you enter in these fields. If you have chosen Off earlier for the WLAN Status the Wireless LAN will turn off between the two times you enter in these fields. In this time format, midnight is 00:00 and progresses up to 24:00. For example, 6:00 PM is 18:00.
Apply	Click Apply to save your changes back to the EMG2926-Q10A.
Cancel	Click Cancel to close this screen without saving any changes.

5.6.2 Parental Control

Use this screen to view the parental control rules configured on the EMG2926-Q10A.

Figure 25 Parental Control

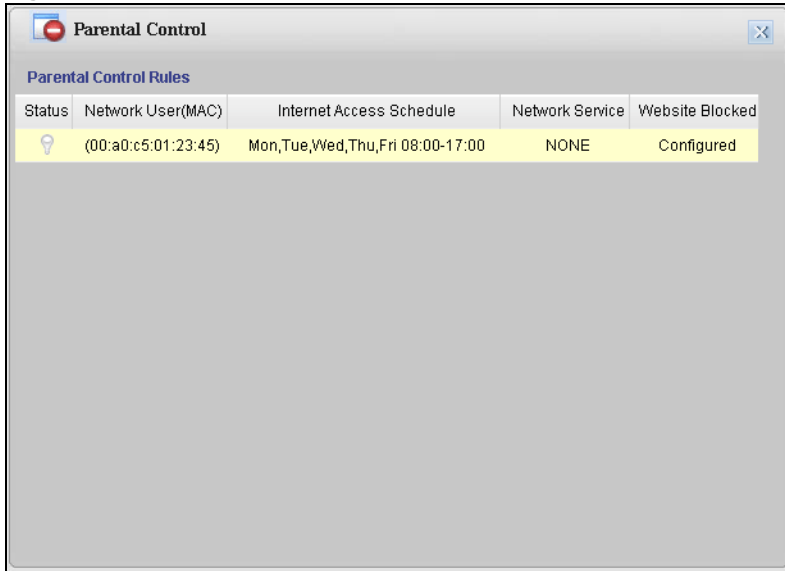

The following table describes the labels in this screen.

Table 14 Parental Control

LABEL	DESCRIPTION
Status	This indicates whether the rule is active or not. A yellow bulb signifies that this rule is active. A gray bulb signifies that this rule is not active.
Network User (MAC)	This shows the MAC address of the LAN user's computer to which this rule applies.
Internet Access Schedule	This shows the day(s) and time on which parental control is enabled.
Network Service	This shows whether the network service is configured. If not, NONE will be shown.
Website Blocked	This shows whether the website block is configured. If not, NONE will be shown.

5.6.3 Firewall

Enable this feature to protect the network from Denial of Service (DoS) attacks. The EMG2926-Q10A blocks repetitive pings from the WAN that can otherwise cause systems to slow down or hang.

Figure 26 Firewall

Click **OK** to close this screen.

5.6.4 Internet Setting

Use this screen to configure your EMG2926-Q10A for Internet access. You should already have Internet account information from your ISP. The screen varies depending on the Internet connection type you selected.

Figure 27 Internet Setting (IPoE)

Figure 28 Internet Setting (PPPoE)

The following table describes the labels in this screen.

Table 15 Internet Setting

LABEL	DESCRIPTION
Internet Connection Type	Select the IPoE (IP over Ethernet) option when the WAN port is used as a regular Ethernet. Select the PPPoE (Point-to-Point Protocol over Ethernet) option for a dial-up connection.
The following fields are available if you select IPoE .	
Obtain an IP Address Automatically	Select this radio button if your ISP did not assign you a fixed IP address.
Static IP Address	Select this radio button if your ISP assigned an IP address for your Internet connection.
IP Address	Enter the IP address provided by your ISP.
Subnet Mask	Enter the IP subnet mask in this field.
Gateway IP Address	Enter the gateway IP address in this field.
The following fields are available if you select PPPoE .	
Get automatically from ISP	Select this radio button if your ISP did not assign you a fixed IP address.
Use Fixed IP Address	Select this radio button, provided by your ISP to give the EMG2926-Q10A a fixed, unique IP address.
PPP Username	Type the user name given to you by your ISP.
PPP Password	Type the password associated with the user name above.
My WAN IP Address	Type the name of your service provider.
Cancel	Click Cancel to close this screen.
Apply	Click Apply to save your changes back to the EMG2926-Q10A.

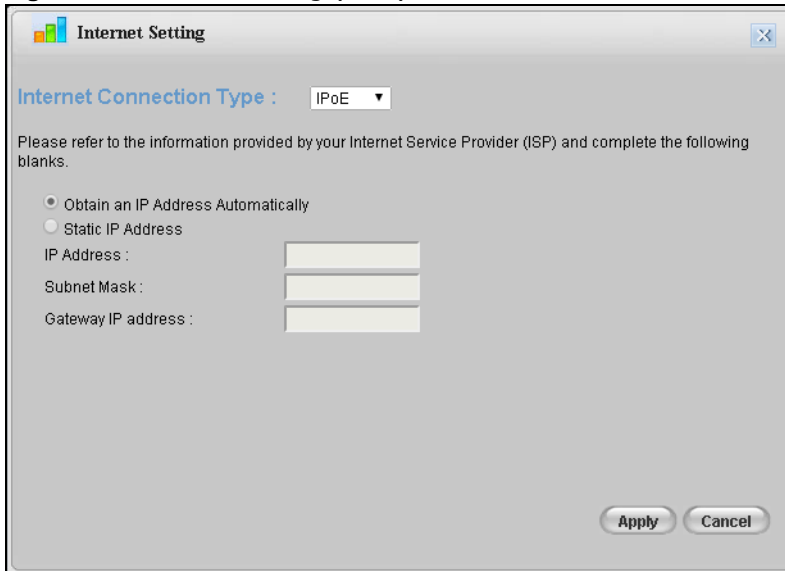
5.6.5 Wireless Security

Use this screen to configure security for your the wireless LAN. You can enter the SSID and select the wireless security mode in the following screen.

Note: You can enable the wireless function of your EMG2926-Q10A by first turning on the switch in the side panel.

Figure 29 Wireless Security

The following table describes the general wireless LAN labels in this screen.

Table 16 Wireless Security

LABEL	DESCRIPTION
Wireless Radio	Choose whether you want to apply the wireless security to 2.4G Hz or 5G Hz wireless radio.
Wireless Network Name (SSID)	(Service Set IDentity) The SSID identifies the Service Set with which a wireless station is associated. Wireless stations associating to the access point (AP) must have the same SSID. Enter a descriptive name (up to 32 keyboard characters) for the wireless LAN.
Security mode	Select WPA2-PSK to add security on this wireless network. The wireless clients which want to associate to this network must have same wireless security settings as this device. After you select to use a security, additional options appears in this screen. Select No Security to allow any client to connect to this network without authentication.
Wireless password	This field appears when you choose wither WPA2-PSK as the security mode. Type a pre-shared key from 8 to 63 case-sensitive keyboard characters.
Verify password	Type the password again to confirm.
Apply	Click Apply to save your changes back to the EMG2926-Q10A.
Cancel	Click Cancel to close this screen.
WPS	Click this to configure the WPS screen. You can transfer the wireless settings configured here (Wireless Security screen) to another wireless device that supports WPS.

5.6.6 WPS

Use this screen to add a wireless station to the network using WPS. Click **WPS** in the **Wireless Security** to open the following screen.

Figure 30 Wireless Security: WPS

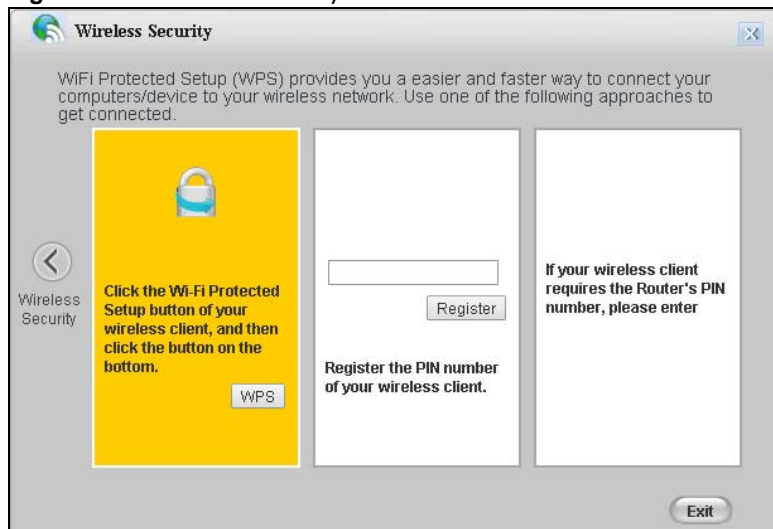

The following table describes the labels in this screen.

Table 17 Wireless Security: WPS

LABEL	DESCRIPTION
Wireless Security	Click this to go back to the Wireless Security screen.
WPS	<p>Create a secure wireless network simply by pressing a button.</p> <p>The EMG2926-Q10A scans for a WPS-enabled device within the range and performs wireless security information synchronization.</p> <p>Note: After you click the WPS button on this screen, you have to press a similar button in the wireless station utility within 2 minutes. To add the second wireless station, you have to press these buttons on both device and the wireless station again after the first 2 minutes.</p>
Register	<p>Create a secure wireless network simply by entering a wireless client's PIN (Personal Identification Number) in the EMG2926-Q10A's interface and pushing this button.</p> <p>Type the same PIN number generated in the wireless station's utility. Then click Register to associate to each other and perform the wireless security information synchronization.</p>
Exit	Click Exit to close this screen.

5.7 Status Screen in Easy Mode

In the Network Map screen, click **Status** to view read-only information about the EMG2926-Q10A.

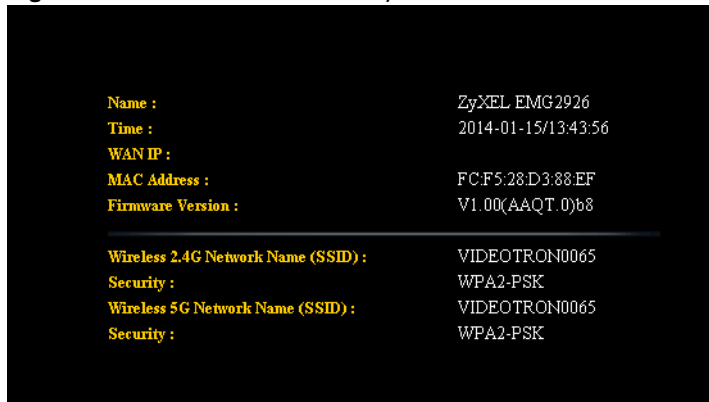
Figure 31 Status Screen in Easy Mode

The following table describes the labels in this screen.

Table 18 Status Screen in Easy Mode

ITEM	DESCRIPTION
Name	This is the name of the EMG2926-Q10A in the network. You can change this in the Maintenance -> General screen in Section 26.3 on page 179.
Time	This is the current system date and time. The date is in YYYY:MM:DD (Year-Month-Day) format. The time is in HH:MM:SS (Hour:Minutes:Seconds) format.
WAN IP	This is the IP address of the WAN port.
MAC Address	This is the MAC address of the EMG2926-Q10A.
Firmware Version	This shows the firmware version of the EMG2926-Q10A. The firmware version format shows the trunk version, model code and release number.
Wireless 2.4G Network Name (SSID)	This shows the SSID of the wireless network. You can configure this in the Wireless Security screen (Section 5.6.5 on page 40 ; Section 11.2 on page 91).
Wireless 5G Network Name (SSID)	
Security	This shows the wireless security used by the EMG2926-Q10A.

Router Mode

6.1 Overview

The EMG2926-Q10A is set to router mode by default. Routers are used to connect the local network to another network (for example, the Internet). In the figure below, the EMG2926-Q10A connects the local network (**LAN1 ~ LAN4**) to the Internet.

Figure 32 EMG2926-Q10A Network

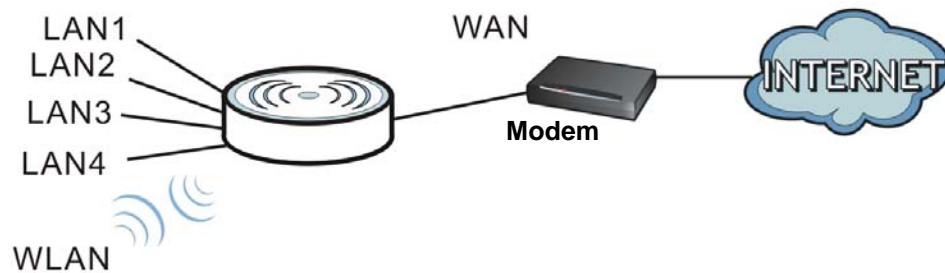

Note: The **Status** screen is shown after changing to the **Expert Mode** of the Web Configurator. It varies depending on the device mode of your EMG2926-Q10A.

6.2 Router Mode Status Screen

Click  to open the status screen.

Figure 33 Status Screen: Router Mode

The screenshot shows the status screen for a ZyXEL VIDÉOTRON EMG2926 router in Router Mode. The interface includes a top navigation bar with 'Welcome: Admin', 'Logout', 'About', and 'Easy Mode' buttons. The main content area is divided into several sections:

- Device Information:** A table listing host name (EMG2926), model number (EMG2926), firmware version (V1.00(AAQT.0)b8), and system operation mode (ROUTER Mode).
- WAN Information:** Details for the WAN interface, including MAC address (FC:F5:28:D3:88:EF), IP address, subnet mask, and default gateway.
- LAN Information:** Details for the LAN interface, including MAC address (FC:F5:28:D3:88:EE), IP address (192.168.0.1), subnet mask (255.255.255.0), and DHCP server status.
- WLAN 2.4G Information:** Details for the 2.4GHz WLAN interface, including mode (Access Point Mode), MAC address (FC:F5:28:D3:88:EC), SSID (VIDÉOTRON0065), channel (6), and security (WPA2-PSK).
- WLAN 5G Information:** Details for the 5GHz WLAN interface, including MAC address (FC:F5:28:D3:88:ED), SSID (VIDÉOTRON0065), channel (161), and security (WPA2-PSK).
- System Status:** Shows system up time (0day 5hr25min 54sec), current date/time (2014-01-15/15:37:42), and resource usage (CPU: 4%, Memory: 24%).
- Interface Status:** A table showing the status and rate of various interfaces: WAN (Down), LAN1-4 (Down), WLAN 2.4G (UP, 450M), and WLAN 5G (UP, 1.3G).
- Summary:** Links to packet statistics and station status for both WLAN 2.4G and 5G.

The following table describes the icons shown in the **Status** screen.

Table 19 Status Screen Icon Key









ICON	DESCRIPTION
 Logout	Click this at any time to exit the Web Configurator.
 About	Click this icon to view copyright and a link for related product information.
 Easy Mode	Click this icon to go to Easy Mode. See Chapter 5 on page 32 .

Table 19 Status Screen Icon Key (continued)

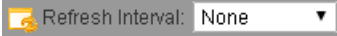
ICON	DESCRIPTION
	Select a number of seconds or None from the drop-down list box to refresh all screen statistics automatically at the end of every time interval or to not refresh the screen statistics.
	Click this button to refresh the status screen statistics.
	Click this icon to see the Status page. The information in this screen depends on the device mode you select.
	Click this icon to see the Monitor navigation menu.
	Click this icon to see the Configuration navigation menu.
	Click this icon to see the Maintenance navigation menu.

The following table describes the labels shown in the **Status** screen.

Table 20 Status Screen: Router Mode

LABEL	DESCRIPTION
Device Information	
Host Name	This is the System Name you enter in the Maintenance > General screen. It is for identification purposes.
Model Number	This is the model name of your device.
Firmware Version	This is the firmware version and the date created.
Sys OP Mode	This is the device mode (Section 4.1.2 on page 31) to which the EMG2926-Q10A is set - Router Mode .
WAN Information	
MAC Address	This shows the WAN Ethernet adapter MAC Address of your device.
IP Address	This shows the WAN port's IP address.
IP Subnet Mask	This shows the WAN port's subnet mask.
Default Gateway	This shows the WAN port's gateway IP address.
IPv6 Address	This shows the IPv6 address of the EMG2926-Q10A on the WAN.
LAN Information	
MAC Address	This shows the LAN Ethernet adapter MAC Address of your device.
IP Address	This shows the LAN port's IP address.
IP Subnet Mask	This shows the LAN port's subnet mask.
DHCP	This shows the LAN port's DHCP role - Server or Disable .
IPv6 Address	This shows the IPv6 address of the EMG2926-Q10A on the LAN.
WLAN 2.4G Information	
WLAN OP Mode	This is the device mode (Section 4.1.2 on page 31) to which the EMG2926-Q10A's wireless LAN is set - Access Point Mode .
MAC Address	This shows the 2.4GHz wireless adapter MAC Address of your device.
SSID	This shows a descriptive name used to identify the EMG2926-Q10A in the 2.4GHz wireless LAN.
Channel	This shows the channel number which you select manually.
Security	This shows the level of wireless security the EMG2926-Q10A is using.

Table 20 Status Screen: Router Mode (continued)

LABEL	DESCRIPTION
WLAN 5G Information	
MAC Address	This shows the 5GHz wireless adapter MAC Address of your device.
SSID	This shows a descriptive name used to identify the EMG2926-Q10A in the 5GHz wireless LAN.
Channel	This shows the channel number which you select manually.
Security	This shows the level of wireless security the EMG2926-Q10A is using.
Firewall	This shows whether the firewall is enabled or not.
Summary	
Packet Statistics	Click Details... to go to the Monitor > Packet Statistics screen (Section 9.5 on page 72). Use this screen to view port status and packet specific statistics.
WLAN 2.4G Station Status	Click Details... to go to the Monitor > WLAN 2.4G Station Status screen (Section 9.6 on page 73). Use this screen to view the wireless stations that are currently associated to the EMG2926-Q10A's 2.4GHz wireless LAN.
WLAN 5G Station Status	Click Details... to go to the Monitor > WLAN 5G Station Status screen (Section 9.6 on page 73). Use this screen to view the wireless stations that are currently associated to the EMG2926-Q10A's 5GHz wireless LAN.
System Status	
Item	This column shows the type of data the EMG2926-Q10A is recording.
Data	This column shows the actual data recorded by the EMG2926-Q10A.
System Up Time	This is the total time the EMG2926-Q10A has been on.
Current Date/Time	This field displays your EMG2926-Q10A's present date and time.
System Resource	
- CPU Usage	This displays what percentage of the EMG2926-Q10A's processing ability is currently used. When this percentage is close to 100%, the EMG2926-Q10A is running at full load, and the throughput is not going to improve anymore. If you want some applications to have more throughput, you should turn off other applications (for example, using bandwidth management.)
- Memory Usage	This shows what percentage of the heap memory the EMG2926-Q10A is using.
Interface Status	
Interface	This displays the EMG2926-Q10A port types. The port types are: WAN , LAN and WLAN .
Status	For the LAN and WAN ports, this field displays Down (line is down) or Up (line is up or connected). For the 2.4GHz/5GHz WLAN, it displays Up when the 2.4GHz/5GHz WLAN is enabled or Down when the 2.4G/5G WLAN is disabled.
Rate	For the LAN ports, this displays the port speed and duplex setting or N/A when the line is disconnected. For the WAN port, it displays the port speed and duplex setting if you're using Ethernet encapsulation. This field displays N/A when the line is disconnected. For the 2.4GHz/5GHz WLAN, it displays the maximum transmission rate when the 2.4GHz/5GHz WLAN is enabled and N/A when the WLAN is disabled.

6.2.1 Navigation Panel

Use the sub-menus on the navigation panel to configure EMG2926-Q10A features.

Figure 34 Navigation Panel: Router Mode

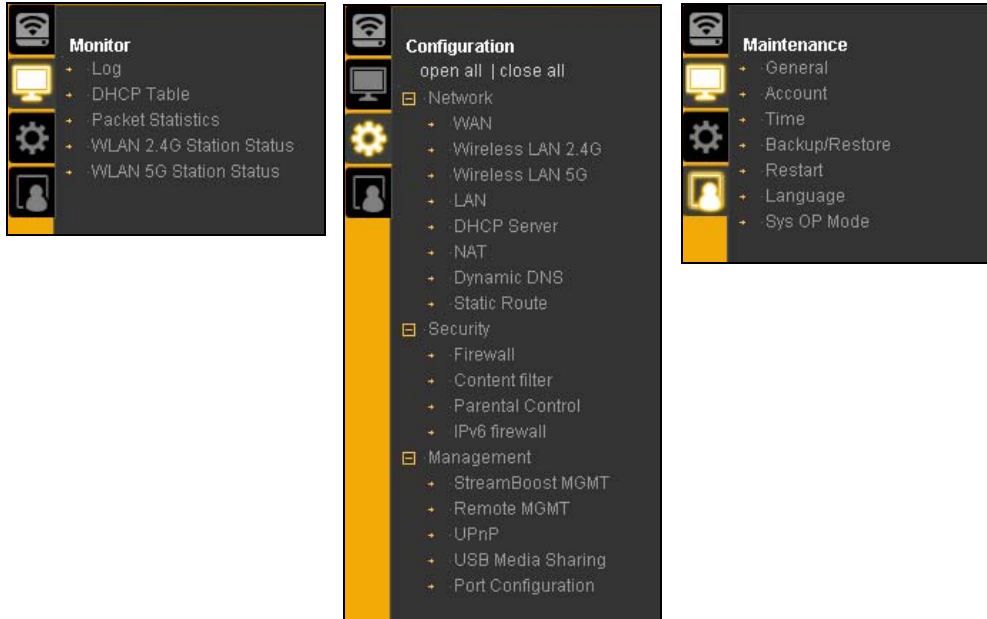

The following table describes the sub-menus.

Table 21 Navigation Panel: Router Mode

LINK	TAB	FUNCTION
Status		This screen shows the EMG2926-Q10A's general device, system and interface status information. Use this screen to access summary statistics tables.
MONITOR		
Log	View Log	Use this screen to view the list of activities recorded by your EMG2926-Q10A.
	Log Setting	Use this screen to select the logs you wish to display.
DHCP Table		Use this screen to view current DHCP client information.
Packet Statistics		Use this screen to view port status and packet specific statistics.
WLAN 2.4G Station Status	Association List	Use this screen to view the wireless stations that are currently associated to the EMG2926-Q10A's 2.4GHz wireless LAN.
WLAN 5G Station Status	Association List	Use this screen to view the wireless stations that are currently associated to the EMG2926-Q10A's 5GHz wireless LAN.
CONFIGURATION		
Network		
WAN	Internet Connection	This screen allows you to configure ISP parameters, WAN IP address assignment, DNS servers and the WAN MAC address.
	Advanced	Use this screen to configure other advanced properties.

Table 21 Navigation Panel: Router Mode (continued)

LINK	TAB	FUNCTION
Wireless LAN 2.4G/5G	General	Use this screen to enable the wireless LAN and configure wireless LAN and wireless security settings.
	More AP	Use this screen to configure multiple BSSs on the EMG2926-Q10A.
	MAC Filter	Use the MAC filter screen to configure the EMG2926-Q10A to block access to devices or block the devices from accessing the EMG2926-Q10A.
	Advanced	This screen allows you to configure advanced wireless settings.
	QoS	Use this screen to configure Wi-Fi Multimedia Quality of Service (WMM QoS). WMM QoS allows you to prioritize wireless traffic according to the delivery requirements of individual services.
	WPS	Use this screen to configure WPS.
	WPS Station	Use this screen to add a wireless station using WPS.
	Scheduling	Use this screen to schedule the times the Wireless LAN is enabled.
LAN	IP	Use this screen to configure LAN IP address and subnet mask.
	IP Alias	Use this screen to have the EMG2926-Q10A apply IP alias to create LAN subnets.
	IPv6 LAN	Use this screen to configure the IPv6 address for the EMG2926-Q10A on the LAN.
DHCP Server	General	Use this screen to enable the EMG2926-Q10A's DHCP server.
	Advanced	Use this screen to assign IP addresses to specific individual computers based on their MAC addresses and to have DNS servers assigned by the DHCP server.
	Client List	Use this screen to view information related to your DHCP status.
NAT	General	Use this screen to enable NAT.
	Port Forwarding	Use this screen to configure servers behind the EMG2926-Q10A and forward incoming service requests to the server(s) on your local network.
	Port Trigger	Use this screen to change your EMG2926-Q10A's port triggering settings.
Dynamic DNS	Dynamic DNS	Use this screen to set up dynamic DNS.
Static Route	Static Route	Use this screen to configure IP static routes.
Security		
Firewall	General	Use this screen to activate/deactivate the firewall.
	Services	This screen shows a summary of the IPv4 firewall rules, and allows you to edit/add an IPv4 firewall rule.
Content Filter	Content Filter	Use this screen to restrict web features and designate a trusted computer.
Parental Control		Use this screen to block certain web features and sites containing certain keywords in the URL.
IPv6 firewall	Services	Use this screen to configure IPv6 firewall rules.
Management		

Table 21 Navigation Panel: Router Mode (continued)

LINK	TAB	FUNCTION
Streamboost Management	Network	Use this screen to view transmission data rates between the EMG2926-Q10A and the Internet or connected devices.
	Bandwidth	Use this screen to configure the maximum allowable bandwidth and enable automatic update.
	Priorities	Use this screen to change the priority of the connected devices.
	Up Time	Use this screen to view the top five traffic flows transmitting from/to the selected LAN device(s).
	Downloads	Use this screen to view the type and percentage of most download traffic.
	All Events	Use this screen to view the time at which a traffic flow is given bandwidth for optimal, good or best-effort performance.
Remote Management	WWW	Use this screen to configure through which interface(s) and from which IP address(es) users can use HTTP to manage the EMG2926-Q10A.
	Telnet	Use this screen to configure through which interface(s) and from which IP address(es) users can use Telnet to manage the EMG2926-Q10A.
	SNMP	Use this screen to change your EMG2926-Q10A's SNMP settings.
	Wake On LAN	Use this screen to enable Wake on LAN to remotely turn on a device on the local network.
UPnP	General	Use this screen to enable UPnP on the EMG2926-Q10A.
USB Media Sharing	DLNA	Use this screen to have the EMG2926-Q10A function as a DLNA-compliant media server, that lets DLNA-compliant media clients play video, audio, and photo content files stored on the connected USB storage device.
	SAMBA	Use this screen to enable file sharing through the EMG2926-Q10A.
	FTP	Use this screen to have the EMG2926-Q10A act as a FTP server.
Port Configuration		Use this screen to change the Ethernet port speed and duplex settings.
MAINTENANCE		
General	General	Use this screen to view and change administrative settings such as system and domain names.
Account	Account Setup	Use this screen to change the password of your EMG2926-Q10A.
Time	Time Setting	Use this screen to change your EMG2926-Q10A's time and date.
Firmware Upgrade	Firmware Upgrade	Use this screen to upload firmware to your EMG2926-Q10A.
Backup/Restore	Backup/Restore	Use this screen to backup and restore the configuration or reset the factory defaults to your EMG2926-Q10A.
Restart	System Restart	This screen allows you to reboot the EMG2926-Q10A without turning the power off.
Language	Language	This screen allows you to select the language you prefer.
Sys OP Mode	Sys OP Mode	This screen allows you to select whether your device acts as a router, or an access point.

Access Point Mode

7.1 Overview

Use your EMG2926-Q10A as an access point (AP) if you already have a router or gateway on your network. In this mode your EMG2926-Q10A bridges a wired network (LAN) and wireless LAN (WLAN) in the same subnet. See the figure below for an example.

Figure 35 Wireless Internet Access in Access Point Mode

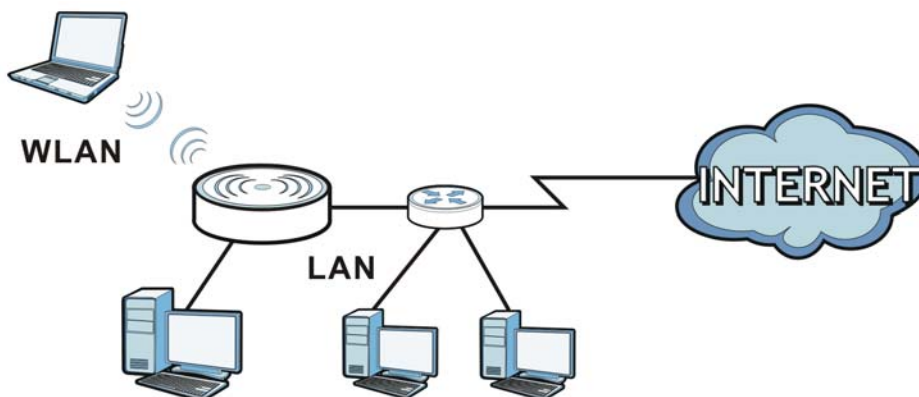

Many screens that are available in **Router Mode** are not available in **Access Point Mode**, such as NAT and firewall.

Note: See [Chapter 8 on page 57](#) for an example of setting up a wireless network in Access Point mode.

7.2 What You Can Do

- Use the **Status** screen to view read-only information about your EMG2926-Q10A ([Section 7.4 on page 52](#)).
- Use the **LAN** screen to set the IP address for your EMG2926-Q10A acting as an access point ([Section 7.5 on page 54](#)).

7.3 What You Need to Know

See [Chapter 8 on page 57](#) for a tutorial on setting up a network with the EMG2926-Q10A as an access point.

7.3.1 Setting your EMG2926-Q10A to AP Mode

- 1 Log into the Web Configurator if you haven't already. See the Quick start Guide for instructions on how to do this.
- 2 To use your EMG2926-Q10A as an access point, go to **Maintenance > Sys OP Mode** and select **Access Point Mode**.

Figure 36 Changing to Access Point mode

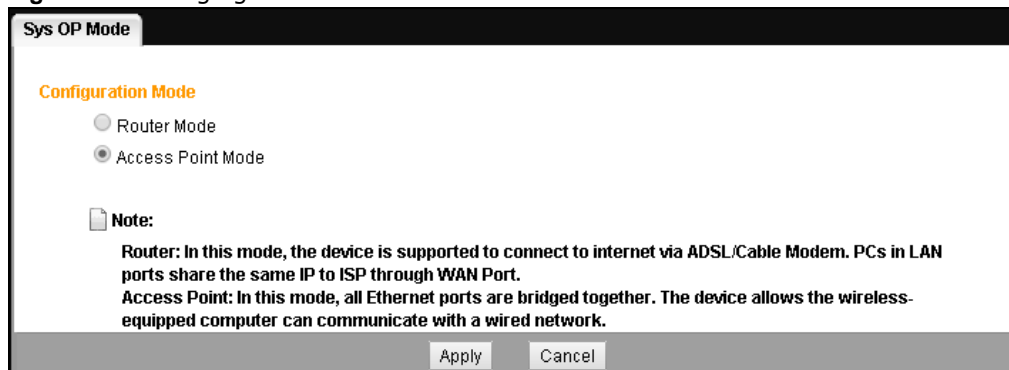

Note: You have to log in to the Web Configurator again when you change modes. As soon as you do, your EMG2926-Q10A is already in Access Point mode.

- 3 When you select **Access Point Mode**, the following pop-up message window appears.

Figure 37 Pop up for Access Point mode

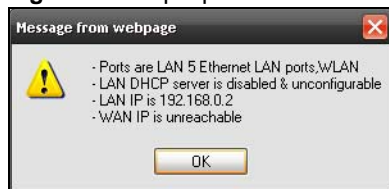

Click **OK**. Then click **Apply**. The Web Configurator refreshes once the change to Access Point mode is successful.

7.3.2 Accessing the Web Configurator in Access Point Mode

Log in to the Web Configurator in Access Point mode, do the following:

- 1 Connect your computer to the LAN port of the EMG2926-Q10A.
- 2 The default IP address of the EMG2926-Q10A is "192.168.0.2". In this case, your computer must have an IP address in the range between "192.168.0.3" and "192.168.0.254".
- 3 Click **Start > Run** on your computer in Windows. Type "cmd" in the dialog box. Enter "ipconfig" to show your computer's IP address. If your computer's IP address is not in the correct range then see [Appendix B on page 193](#) for information on changing your computer's IP address.
- 4 After you've set your computer's IP address, open a web browser such as Internet Explorer and type "192.168.0.2" as the web address in your web browser.

Note: After clicking **Login**, the **Easy Mode** appears. Refer to [Section on page 32](#) for the **Easy Mode** screens. Change to **Expert Mode** to see the screens described in the sections following this.

7.3.3 Configuring your WLAN and Maintenance Settings

The configuration of wireless and maintenance settings in **Access Point Mode** is the same as for **Router Mode**.

- See [Chapter 11 on page 86](#) for information on the configuring your wireless network.
- See [Chapter 26 on page 179](#) for information on configuring your Maintenance settings.

7.4 AP Mode Status Screen

Click  to open the **Status** screen.

Figure 38 Status Screen: Access Point Mode



The screenshot shows the ZyXEL EMG2926 Status Screen in Access Point Mode. The interface includes a navigation sidebar, a top header with user information, and several data panels.

Device Information

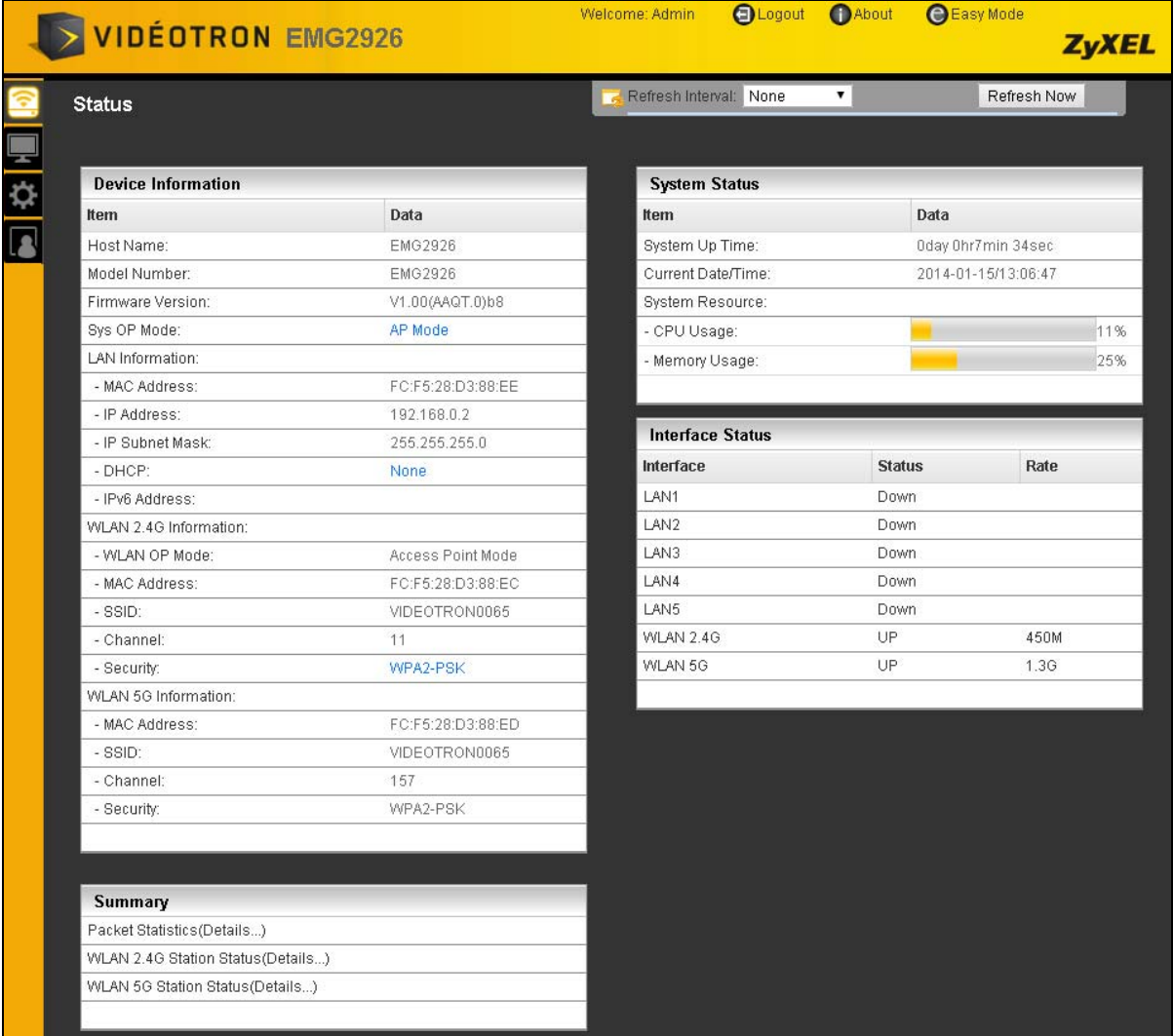
Item	Data
Host Name:	EMG2926
Model Number:	EMG2926
Firmware Version:	V1.00(AAGT.0)b8
Sys OP Mode:	AP Mode
LAN Information:	
- MAC Address:	FC:F5:28:D3:88:EE
- IP Address:	192.168.0.2
- IP Subnet Mask:	255.255.255.0
- DHCP:	None
- IPv6 Address:	
WLAN 2.4G Information:	
- WLAN OP Mode:	Access Point Mode
- MAC Address:	FC:F5:28:D3:88:EC
- SSID:	VIDEOTRON0065
- Channel:	11
- Security:	WPA2-PSK
WLAN 5G Information:	
- MAC Address:	FC:F5:28:D3:88:ED
- SSID:	VIDEOTRON0065
- Channel:	157
- Security:	WPA2-PSK

System Status

Item	Data
System Up Time:	0day 0hr7min 34sec
Current Date/Time:	2014-01-15/13:06:47
System Resource:	
- CPU Usage:	11%
- Memory Usage:	25%

Interface Status

Interface	Status	Rate
LAN1	Down	
LAN2	Down	
LAN3	Down	
LAN4	Down	
LAN5	Down	
WLAN 2.4G	UP	450M
WLAN 5G	UP	1.3G

Summary

- Packet Statistics(Details...)
- WLAN 2.4G Station Status(Details...)
- WLAN 5G Station Status(Details...)

The following table describes the labels shown in the **Status** screen.

Table 22 Status Screen: Access Point Mode

LABEL	DESCRIPTION
Device Information	
Host Name	This is the System Name you enter in the Maintenance > General screen. It is for identification purposes.
Model Number	This is the model name of your device.
Firmware Version	This is the firmware version and the date created.
Sys OP Mode	This is the device mode (Section 4.1.2 on page 31) to which the EMG2926-Q10A is set - AP Mode .
LAN Information	
MAC Address	This shows the LAN Ethernet adapter MAC Address of your device.
IP Address	This shows the LAN port's IP address.
IP Subnet Mask	This shows the LAN port's subnet mask.
DHCP	This shows the LAN port's DHCP role - Client or None .
IPv6 Address	This shows the IPv6 address of the EMG2926-Q10A on the LAN.
WLAN 2.4G Information	
WLAN OP Mode	This is the device mode (Section 4.1.2 on page 31) to which the EMG2926-Q10A's wireless LAN is set - Access Point Mode .
MAC Address	This shows the 2.4GHz wireless adapter MAC Address of your device.
SSID	This shows a descriptive name used to identify the EMG2926-Q10A in the 2.4GHz wireless LAN.
Channel	This shows the channel number which you select manually.
Security	This shows the level of wireless security the EMG2926-Q10A is using.
WLAN 5G Information	
MAC Address	This shows the 5GHz wireless adapter MAC Address of your device.
SSID	This shows a descriptive name used to identify the EMG2926-Q10A in the 5GHz wireless LAN.
Channel	This shows the channel number which you select manually.
Security	This shows the level of wireless security the EMG2926-Q10A is using.
Summary	
Packet Statistics	Click Details... to go to the Monitor > Packet Statistics screen (Section 9.5 on page 72). Use this screen to view port status and packet specific statistics.
WLAN 2.4G Station Status	Click Details... to go to the Monitor > WLAN 2.4G Station Status screen (Section 9.6 on page 73). Use this screen to view the wireless stations that are currently associated to the EMG2926-Q10A's 2.4GHz wireless LAN.
WLAN 5G Station Status	Click Details... to go to the Monitor > WLAN 5G Station Status screen (Section 9.6 on page 73). Use this screen to view the wireless stations that are currently associated to the EMG2926-Q10A's 5GHz wireless LAN.
System Status	
Item	This column shows the type of data the EMG2926-Q10A is recording.
Data	This column shows the actual data recorded by the EMG2926-Q10A.
System Up Time	This is the total time the EMG2926-Q10A has been on.
Current Date/Time	This field displays your EMG2926-Q10A's present date and time.
System Resource	

Table 22 Status Screen: Access Point Mode (continued)

LABEL	DESCRIPTION
- CPU Usage	This displays what percentage of the EMG2926-Q10A's processing ability is currently used. When this percentage is close to 100%, the EMG2926-Q10A is running at full load, and the throughput is not going to improve anymore. If you want some applications to have more throughput, you should turn off other applications (for example, using bandwidth management.)
- Memory Usage	This shows what percentage of the heap memory the EMG2926-Q10A is using.
Interface Status	
Interface	This displays the EMG2926-Q10A port types. The port types are: LAN and WLAN .
Status	For the LAN ports, this field displays Down (line is down) or Up (line is up or connected). For the 2.4GHz/5GHz WLAN, it displays Up when the 2.4GHz/5GHz WLAN is enabled or Down when the 2.4G/5G WLAN is disabled.
Rate	For the LAN ports, this displays the port speed and duplex setting or N/A when the line is disconnected. For the 2.4GHz/5GHz WLAN, it displays the maximum transmission rate when the 2.4GHz/5GHz WLAN is enabled and N/A when the WLAN is disabled.

7.4.1 Navigation Panel

Use the menu in the navigation panel to configure EMG2926-Q10A features in **Access Point Mode**.

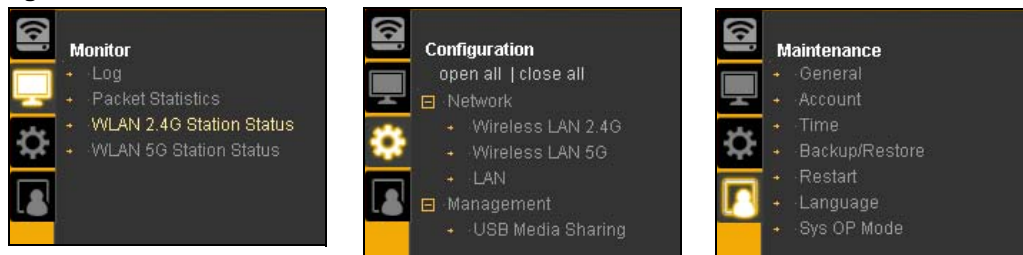
Figure 39 Menu: Access Point Mode

Refer to [Table 21 on page 47](#) for descriptions of the labels shown in the navigation panel.

7.5 LAN Screen

Use this section to configure your LAN settings while in **Access Point Mode**.

Click **Network > LAN** to see the screen below.

Note: If you change the IP address of the EMG2926-Q10A in the screen below, you will need to log into the EMG2926-Q10A again using the new IP address.

Figure 40 Network > LAN > IP

The table below describes the labels in the screen.

Table 23 Network > LAN > IP

LABEL	DESCRIPTION
Obtain an IP Address Automatically	When you enable this, the EMG2926-Q10A gets its IP address from the network's DHCP server (for example, your ISP). Users connected to the EMG2926-Q10A can now access the network (i.e., the Internet if the IP address is given by the ISP). The Web Configurator may no longer be accessible unless you know the IP address assigned by the DHCP server to the EMG2926-Q10A. You need to reset the EMG2926-Q10A to be able to access the Web Configurator again (see Section 26.7 on page 185 for details on how to reset the EMG2926-Q10A). Also when you select this, you cannot enter an IP address for your EMG2926-Q10A in the field below.
Static IP Address	Click this if you want to specify the IP address of your EMG2926-Q10A. Or if your ISP or network administrator gave you a static IP address to access the network or the Internet.
IP Address	Type the IP address in dotted decimal notation. The default setting is 192.168.0.2. If you change the IP address you will have to log in again with the new IP address.
Subnet Mask	The subnet mask specifies the network number portion of an IP address. Your EMG2926-Q10A will automatically calculate the subnet mask based on the IP address that you assign. Unless you are implementing subnetting, use the subnet mask computed by the EMG2926-Q10A.
Gateway IP Address	Enter a Gateway IP Address (if your ISP or network administrator gave you one) in this field.
DNS Server	

Table 23 Network > LAN > IP (continued)

LABEL	DESCRIPTION
First DNS Server	Select Obtained From ISP if your ISP dynamically assigns DNS server information (and the EMG2926-Q10A's WAN IP address). The field to the right displays the (read-only) DNS server IP address that the ISP assigns.
Second DNS Server	
Third DNS Server	
Apply	Select User-Defined if you have the IP address of a DNS server. Enter the DNS server's IP address in the field to the right. If you chose User-Defined , but leave the IP address set to 0.0.0.0, User-Defined changes to None after you click Apply . If you set a second choice to User-Defined , and enter the same IP address, the second User-Defined changes to None after you click Apply . Select None if you do not want to configure DNS servers. If you do not configure a DNS server, you must know the IP address of a computer in order to access it.
Cancel	Click Apply to save your changes to the EMG2926-Q10A.
	Click Cancel to reload the previous configuration for this screen.

8.1 Overview

This chapter provides tutorials for setting up your EMG2926-Q10A.

- [Set Up a Wireless Network with WPS](#)
- [Configure Wireless Security without WPS](#)
- [Using Multiple SSIDs on the EMG2926-Q10A](#)

8.2 Set Up a Wireless Network with WPS

This section gives you an example of how to set up wireless network using WPS. This example uses the EMG2926-Q10A as the AP and NWD210N as the wireless client which connects to a notebook.

Note: The wireless client must be a WPS-aware device (for example, a WPS USB adapter or PCI card).

There are two WPS methods for creating a secure connection. This tutorial shows you how to do both.

- **Push Button Configuration (PBC)** - create a secure wireless network simply by pressing a button. See [Section 8.2.1 on page 57](#). This is the easier method.
- **PIN Configuration** - create a secure wireless network simply by entering a wireless client's PIN (Personal Identification Number) in the EMG2926-Q10A's interface. See [Section 8.2.2 on page 58](#). This is the more secure method, since one device can authenticate the other.

8.2.1 Push Button Configuration (PBC)

- 1 Make sure that your EMG2926-Q10A is turned on. Make sure the **WIFI** button (at the side panel of the EMG2926-Q10A) is pushed in, and that the device is placed within range of your notebook.
- 2 Make sure that you have installed the wireless client (this example uses the NWD210N) driver and utility in your notebook.
- 3 In the wireless client utility, find the WPS settings. Enable WPS and press the WPS button (**Start** or **WPS** button)
- 4 Log into EMG2926-Q10A's Web Configurator and press the **Push Button** in the **Configuration > Network > Wireless LAN 2.4G > WPS Station** screen.

Note: Your EMG2926-Q10A has a WPS button located on its panel, as well as a WPS button in its configuration utility. Both buttons have exactly the same function; you can use one or the other.

Note: It doesn't matter which button is pressed first. You must press the second button within two minutes of pressing the first one.

The EMG2926-Q10A sends the proper configuration settings to the wireless client. This may take up to two minutes. Then the wireless client is able to communicate with the EMG2926-Q10A securely.

The following figure shows you an example to set up wireless network and security by pressing a button on both EMG2926-Q10A and wireless client (the NWD210N in this example).

Figure 41 Example WPS Process: PBC Method

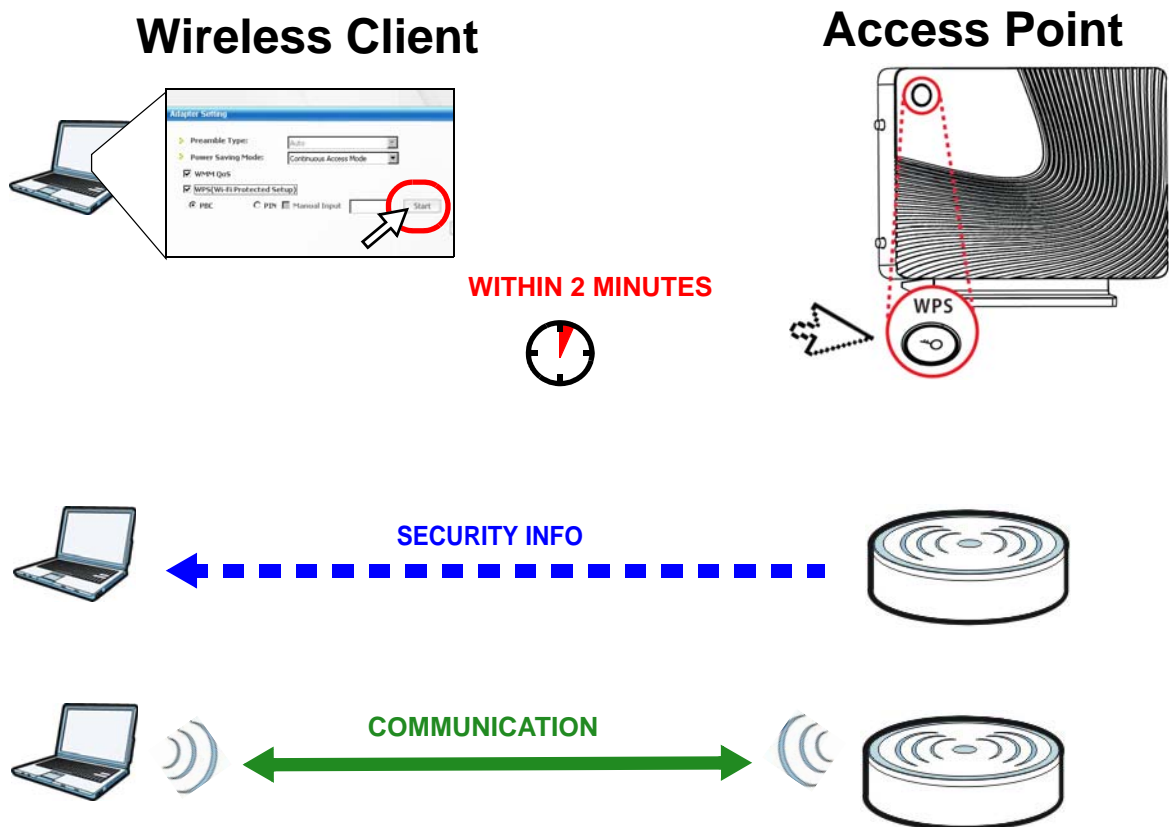

8.2.2 PIN Configuration

When you use the PIN configuration method, you need to use both EMG2926-Q10A's configuration interface and the client's utilities.

- 1 Launch your wireless client's configuration utility. Go to the WPS settings and select the PIN method to get a PIN number.
- 2 Enter the PIN number to the **PIN** field in the **Configuration > Network > Wireless LAN 2.4G > WPS Station** screen on the EMG2926-Q10A.

- Click **Start** buttons (or button next to the PIN field) on both the wireless client utility screen and the EMG2926-Q10A's **WPS Station** screen within two minutes.

The EMG2926-Q10A authenticates the wireless client and sends the proper configuration settings to the wireless client. This may take up to two minutes. Then the wireless client is able to communicate with the EMG2926-Q10A securely.

The following figure shows you the example to set up wireless network and security on EMG2926-Q10A and wireless client (ex. NWD210N in this example) by using PIN method.

Figure 42 Example WPS Process: PIN Method

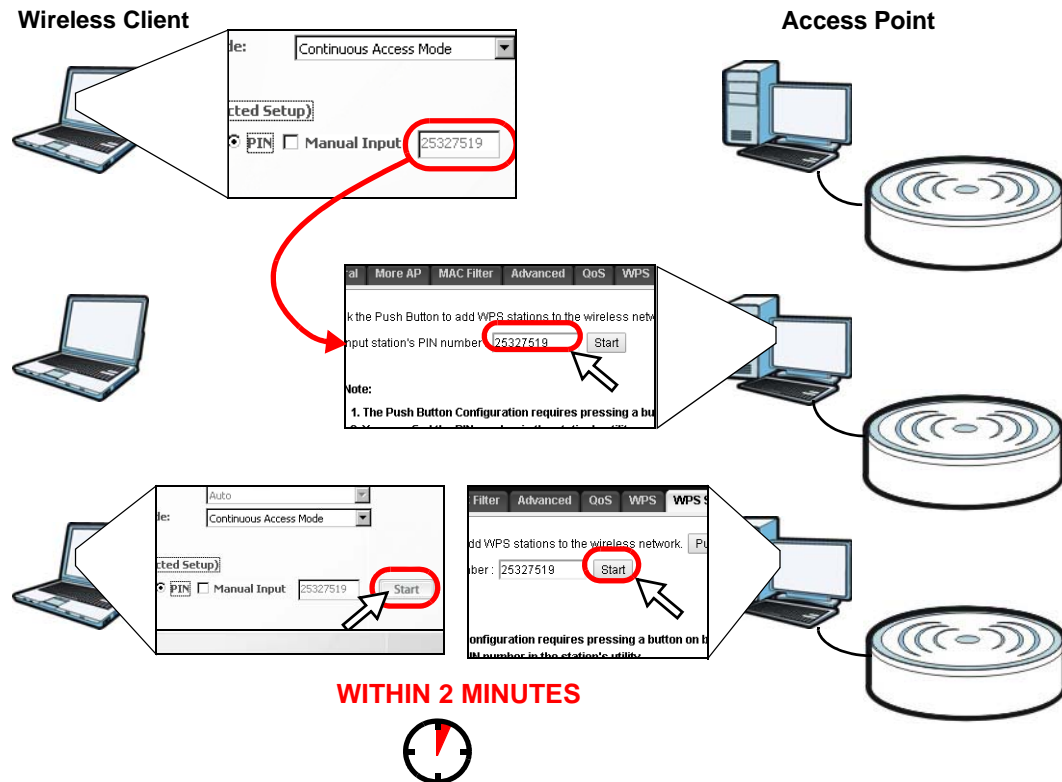

8.3 Configure Wireless Security without WPS

This example shows you how to configure wireless security settings with the following parameters on your EMG2926-Q10A.

SSID	SSID_Example3
Channel	6
Security	WPA2-PSK (Pre-Shared Key: ThisismyWPA-PSKpre-sharedkey)

Follow the steps below to configure the wireless settings on your EMG2926-Q10A.

The instructions require that your hardware is connected (see the Quick Start Guide) and you are logged into the Web Configurator through your LAN connection (see [Section 3.2 on page 28](#)).

- 1 Make sure the **WIFI** switch (at the side panel of the EMG2926-Q10A) is set to **ON**.
- 2 Open the **Configuration > Network > Wireless LAN 2.4G > General** screen in the AP's Web Configurator.
- 3 Confirm that the wireless LAN is enabled on the EMG2926-Q10A.
- 4 Enter **SSID_Example3** as the SSID and select **Channel-06** as the channel. Set security mode to **WPA2-PSK** and enter **ThisismyWPA-PSKpre-shared!** in the **Pre-Shared Key** field. Click **Apply**.

The screenshot displays the configuration interface for the EMG2926-Q10A. The 'More AP' tab is selected, and the 'Wireless Setup' section is active. The 'Wireless LAN' option is set to 'Enable'. The 'Name (SSID)' field contains 'SSID_Example3'. The 'Channel Selection' is set to 'Channel-6 2437MHz', and 'Auto Channel Selection' is disabled. The 'Operating Channel' is 'Channel-6', 'Channel Width' is 'Auto 20/40 MHz', and '802.11 Mode' is '802.11bgn'. In the 'Security' section, 'Security Mode' is 'WPA2-PSK', 'WPA-PSK Compatible' is disabled, 'Pre-Shared Key' is 'ThisismyWPA-PSKpre-shared!', and 'Group Key Update Timer' is '3600 seconds'. A note at the bottom states: 'Note: No Security and WPA2-PSK can be configured when WPS enabled.' The 'Apply' and 'Cancel' buttons are visible at the bottom of the form.

- 5 Open the **Status** screen. Verify your wireless and wireless security settings under **Device Information** and check if the WLAN connection is up under **Interface Status**.

The screenshot displays the Status screen with the following sections:

- WAN Information:**
 - MAC Address: FC:F5:28:D3:88:EF
 - IP Address:
 - IP Subnet Mask:
 - Default Gateway:
 - IPv6 Address:
- LAN Information:**
 - MAC Address: FC:F5:28:D3:88:EE
 - IP Address: 192.168.0.1
 - IP Subnet Mask: 255.255.255.0
 - DHCP: [Server](#)
 - IPv6 Address:
- WLAN 2.4G Information:** (highlighted with a red circle)
 - WLAN OP Mode: Access Point Mode
 - MAC Address: FC:F5:28:D3:88:EC
 - SSID: SSID_Example3
 - Channel: 6
 - Security: [WPA2-PSK](#)
- WLAN 5G Information:**
 - MAC Address: FC:F5:28:D3:88:ED
 - SSID: VIDEOTRON0065
 - Channel: 161
 - Security: WPA2-PSK
- Firewall:** Enable
- Summary:**
 - Packet Statistics(Details...)
 - WLAN 2.4G Station Status(Details...)
 - WLAN 5G Station Status(Details...)

On the right side, the **Interface Status** table is shown:

Interface	Status	Rate
WAN	Down	
LAN1	Down	
LAN2	Down	
LAN3	Down	
LAN4	Down	
WLAN 2.4G	UP	450M
WLAN 5G	UP	1.3G

8.3.1 Configure Your Notebook

Note: We use the ZyXEL NWD2205 wireless adapter utility screens as an example for the wireless client. The screens may vary for different models.

- 1 The EMG2926-Q10A supports IEEE 802.11a, IEEE 802.11b, IEEE 802.11g and IEEE 802.11n wireless clients. Make sure that your notebook or computer's wireless adapter supports one of these standards.
- 2 Wireless adapters come with software sometimes called a "utility" that you install on your computer. See your wireless adapter's User's Guide for information on how to do that.
- 3 After you've installed the utility, open it. If you cannot see your utility's icon on your screen, go to **Start > Programs** and click on your utility in the list of programs that appears. The utility displays a list of APs within range, as shown in the example screen below.

- 4 Select SSID_Example3 and click **Connect**.

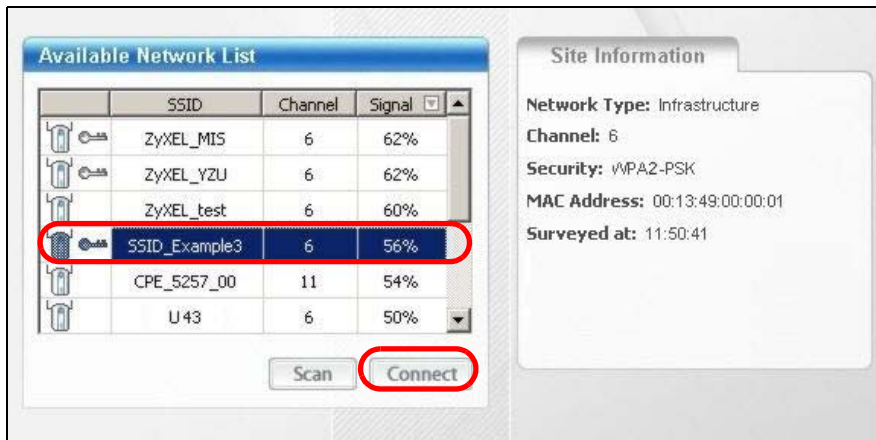

- 5 Select **AES** and type the security key in the following screen. Click **Next**.

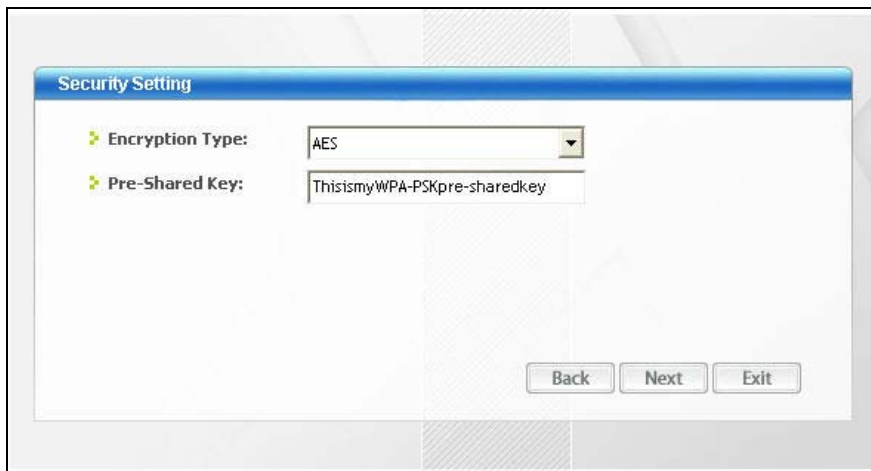

- 6 The **Confirm Save** window appears. Check your settings and click **Save** to continue.

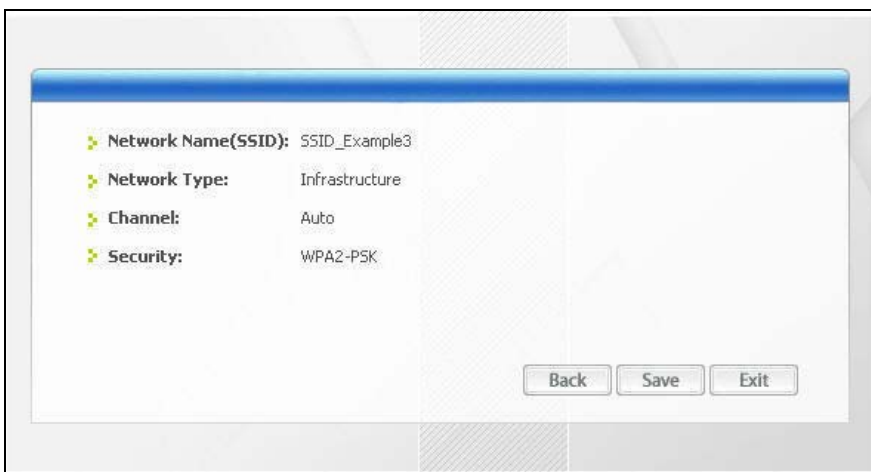

- 7 Check the status of your wireless connection in the screen below. If your wireless connection is weak or you have no connection, see the Troubleshooting section of this User's Guide.



If your connection is successful, open your Internet browser and enter <http://www.zyxel.com> or the URL of any other web site in the address bar. If you are able to access the web site, your wireless connection is successfully configured.

8.4 Using Multiple SSIDs on the EMG2926-Q10A

You can configure more than one SSID on a EMG2926-Q10A. See [Section 11.4 on page 99](#).

This allows you to configure multiple independent wireless networks on the EMG2926-Q10A as if there were multiple APs (virtual APs). Each virtual AP has its own SSID, wireless security type and MAC filtering settings. That is, each SSID on the EMG2926-Q10A represents a different access point/wireless network to wireless clients in the network.

Clients can associate only with the SSIDs for which they have the correct security settings. Clients using different SSIDs can access the Internet and the wired network behind the EMG2926-Q10A (such as a printer).

For example, you may set up three wireless networks (A, B and C) in your office. A is for workers, B is for guests and C is specific to a VoIP device in the meeting room.

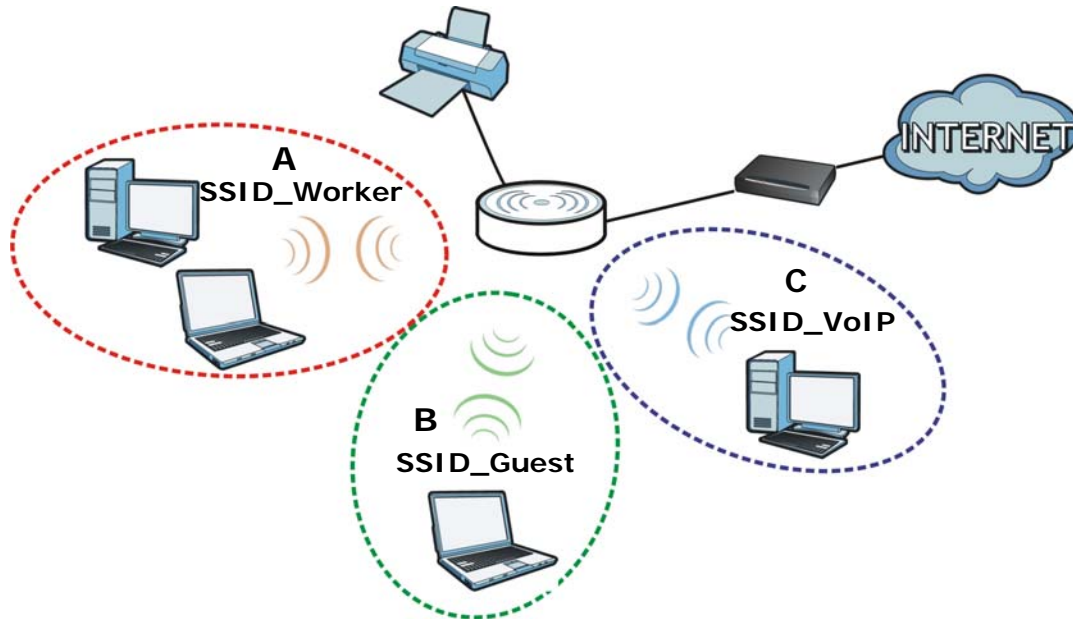

8.4.1 Configuring Security Settings of Multiple SSIDs

The EMG2926-Q10A is in router mode by default.

This example shows you how to configure the SSIDs with the following parameters on your EMG2926-Q10A (in router mode).

SSID	SECURITY TYPE	KEY	MAC FILTERING
SSID_Worker	WPA2-PSK WPA Compatible	DoNotStealMyWirelessNetwork	Disable
SSID_VoIP	WPA-PSK	VoIPOnly12345678	Allow 00:A0:C5:01:23:45
SSID_Guest	WPA-PSK	keyexample123	Disable

- 1 Connect your computer to the LAN port of the EMG2926-Q10A using an Ethernet cable.
- 2 The default IP address of the EMG2926-Q10A in router mode is "192.168.0.1". In this case, your computer must have an IP address in the range between "192.168.0.2" and "192.168.0.254".
- 3 Click **Start > Run** on your computer in Windows. Type "cmd" in the dialog box. Enter "ipconfig" to show your computer's IP address. If your computer's IP address is not in the correct range then see [Appendix B on page 193](#) for information on changing your computer's IP address.
- 4 After you've set your computer's IP address, open a web browser such as Internet Explorer and type "http://192.168.0.1" as the web address in your web browser.
- 5 Enter "admin" (default) as the user name and click **Login**.

- 6 Type a new password and retype it to confirm, then click **Apply**. Otherwise, click **Ignore**.
- 7 The **Easy Mode** appears. Click **Expert Mode** in the navigation panel.
- 8 Go to **Configuration > Network > Wireless LAN 2.4G > More AP**. Click the **Edit** icon of the first entry to configure wireless and security settings for **SSID_Worker**.

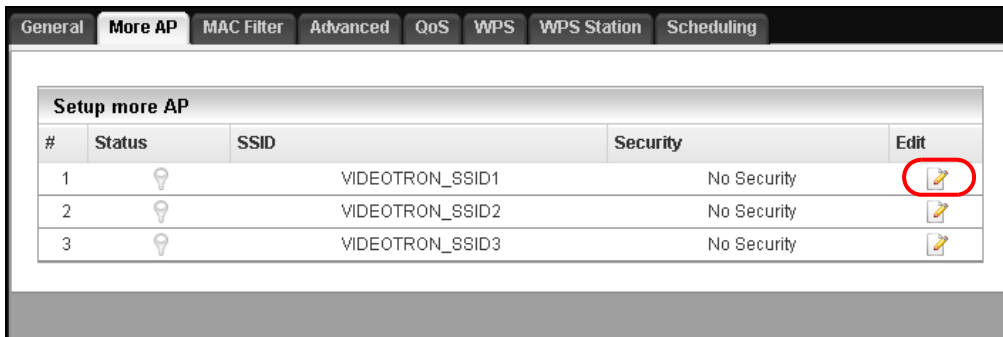

- 9 Configure the screen as follows. In this example, you enable **Intra-BSS Traffic** for **SSID_Worker** to allow wireless clients in the same wireless network to communicate with each other. Click **Apply**.

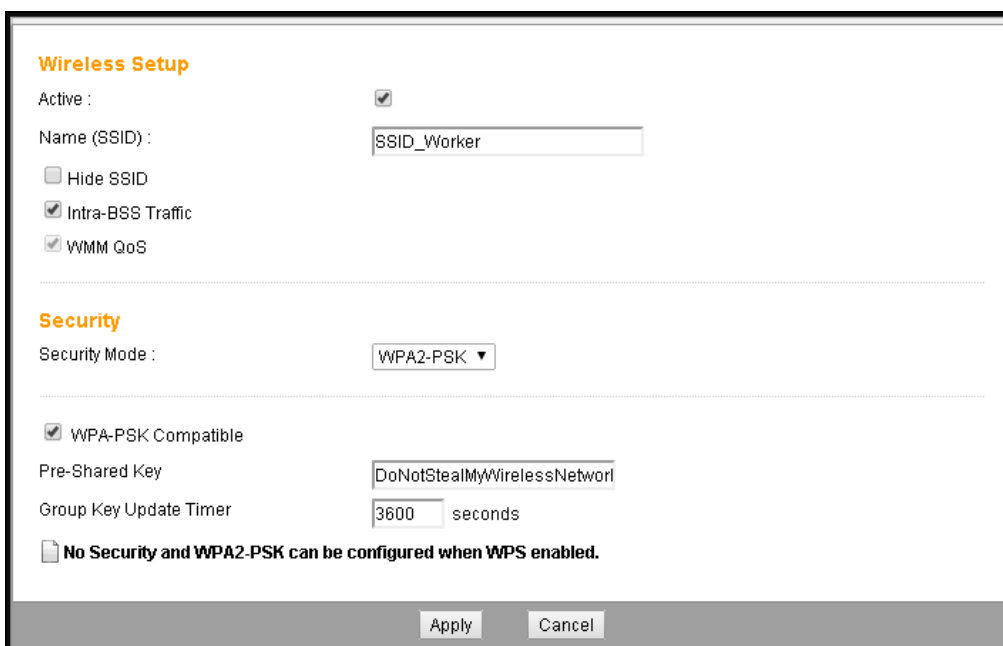

- 10 Click the **Edit** icon of the second entry to configure wireless and security settings for **SSID_VoIP**.

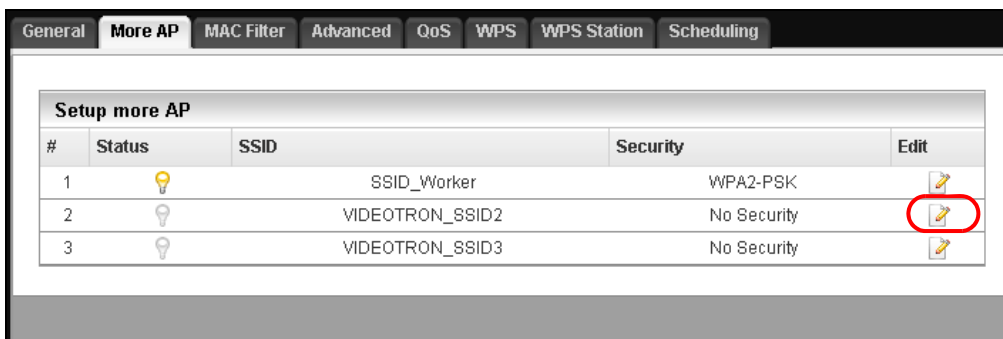

- 11 Configure the screen as follows. You do not enable **Intra-BSS Traffic** for **SSID_VoIP**. Click **Apply**.

The screenshot shows the configuration page for a wireless network. Under the **Wireless Setup** section, the **Active** checkbox is checked. The **Name (SSID)** is set to `SSID_VoIP`. The **Hide SSID** checkbox is unchecked, while **Intra-BSS Traffic** and **WMM QoS** are checked. Under the **Security** section, the **Security Mode** is set to **WPA-PSK**. The **Pre-Shared Key** is `VoIPOnly12345678` and the **Group Key Update Timer** is set to `3600` seconds. A message at the bottom states: **No Security and WPA2-PSK can be configured when WPS enabled.** At the bottom of the page are **Apply** and **Cancel** buttons.

- 12 Click the **Edit** icon of the third entry to configure wireless and security settings for **SSID_Guest**.

The screenshot shows the **Setup more AP** table with the following data:

#	Status	SSID	Security	Edit
1		SSID_Worker	WPA2-PSK	
2		SSID_VoIP	WPA-PSK	
3		VIDEOTRON_SSID3	No Security	

The **Edit** icon for the third entry (VIDEOTRON_SSID3) is circled in red.

- 13 Configure the screen as follows. In this example, you enable **Intra-BSS Traffic** for **SSID_Guest** to allow wireless clients in the same wireless network to communicate with each other. Select **Enable Guest WLAN** to allow clients to access the Internet only. Click **Apply**.

Wireless Setup

Active :

Name (SSID) :

Hide SSID

Intra-BSS Traffic

WMM QoS

Enable Guest WLAN

IP Address :

IP Subnet Mask :

Enable Bandwidth Management for Guest WLAN

Maximum Bandwidth (kbps)

Security

Security Mode :

Pre-Shared Key

Group Key Update Timer seconds

No Security and WPA2-PSK can be configured when WPS enabled.

- 14 Click the **MAC Filter** tab to configure MAC filtering for the **SSID_VoIP** wireless network. Select **SSID_VoIP** from the **SSID Select** drop-down list, enable MAC address filtering and set the **Filter Action** to **Allow**. Enter the VoIP device's MAC address in the **Mac Address** field and click **Apply** to allow only the VoIP device to associate with the EMG2926-Q10A using this SSID.

General More AP **MAC Filter** Advanced QoS WPS WPS Station Scheduling

SSID Select:
MAC Address Filter: Enable Disable
Filter Action: Allow Deny

MAC Filter Summary

Set	MAC Address	Set	MAC Address
1	00:A0:C5:01:23:45	17	00:00:00:00:00:00
2	00:00:00:00:00:00	18	00:00:00:00:00:00
3	00:00:00:00:00:00	19	00:00:00:00:00:00
4	00:00:00:00:00:00	20	00:00:00:00:00:00
5	00:00:00:00:00:00	21	00:00:00:00:00:00
6	00:00:00:00:00:00	22	00:00:00:00:00:00
7	00:00:00:00:00:00	23	00:00:00:00:00:00
8	00:00:00:00:00:00	24	00:00:00:00:00:00
9	00:00:00:00:00:00	25	00:00:00:00:00:00
10	00:00:00:00:00:00	26	00:00:00:00:00:00
11	00:00:00:00:00:00	27	00:00:00:00:00:00
12	00:00:00:00:00:00	28	00:00:00:00:00:00
13	00:00:00:00:00:00	29	00:00:00:00:00:00
14	00:00:00:00:00:00	30	00:00:00:00:00:00
15	00:00:00:00:00:00	31	00:00:00:00:00:00
16	00:00:00:00:00:00	32	00:00:00:00:00:00

PART II

Technical Reference

Monitor

9.1 Overview

This chapter discusses read-only information related to the device state of the EMG2926-Q10A.

To access the Monitor screens, go to **Expert Mode** after login, then click .



You can also click the links in the **Summary** table of the **Status** screen to view the packets sent/received as well as the status of clients connected to the EMG2926-Q10A.

9.2 What You Can Do

- Use the **Log** screens to see the logs for the activity on the EMG2926-Q10A and select the logs you wish to display ([Section 9.3 on page 70](#)).
- Use the **DHCP Table** screen to view information related to your DHCP status ([Section 9.4 on page 71](#)).
- use the **Packet Statistics** screen to view port status, packet specific statistics, the "system up time" and so on ([Section 9.5 on page 72](#)).
- Use the **WLAN 2.4G/5G Station Status** screen to view the wireless stations that are currently associated to the EMG2926-Q10A ([Section 9.6 on page 73](#)).

9.3 The Log Screen

The Web Configurator allows you to look at all of the EMG2926-Q10A's logs in one location and select the logs you wish to display.

9.3.1 View Log

Use the **View Log** screen to see the logged messages for the EMG2926-Q10A. The log wraps around and deletes the old entries after it fills. Select what logs you want to see from the **Display**

drop list. The log choices depend on your settings in the **Log Setting** screen. Click **Refresh** to renew the log screen. Click **Clear Log** to delete all the logs.

Figure 43 View Log

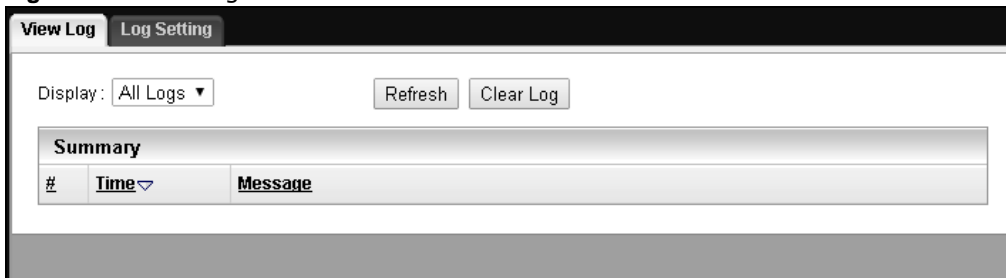

9.3.2 Log Setting

You can configure which logs to display in the **View Log** screen. Go to the **Log Setting** screen and select the logs you wish to display. Click **Apply** to save your settings. Click **Cancel** to start the screen afresh.

Figure 44 Log Settings

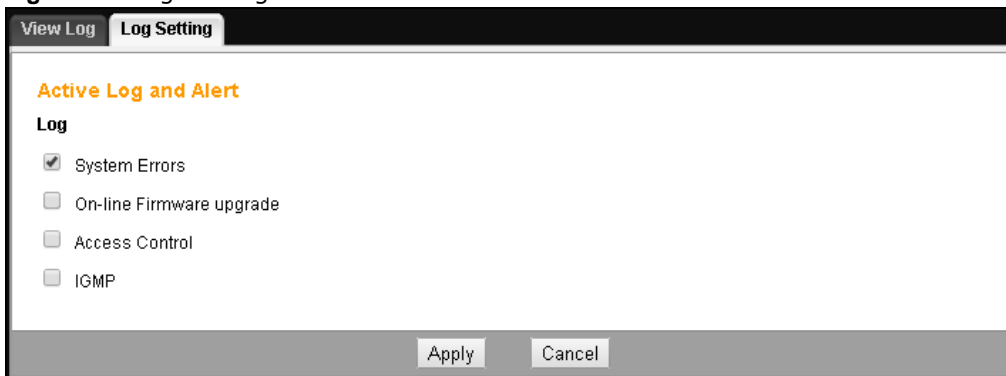

9.4 DHCP Table

DHCP (Dynamic Host Configuration Protocol, RFC 2131 and RFC 2132) allows individual clients to obtain TCP/IP configuration at start-up from a server. You can configure the EMG2926-Q10A's LAN as a DHCP server or disable it. When configured as a server, the EMG2926-Q10A provides the TCP/IP configuration for the clients. If DHCP service is disabled, you must have another DHCP server on that network, or else the computer must be manually configured.

Click **Monitor > DHCP Table** or **Configuration > Network > DHCP Server > Client List**. Read-only information here relates to your DHCP status. The DHCP table shows current DHCP client information (including **MAC Address**, and **IP Address**) of all network clients using the EMG2926-Q10A's DHCP server.

Figure 45 Monitor > DHCP Table

#	Status	Host Name	IP Address	MAC Address	Interface	Reserve
1	⬆	*	192.168.0.44	00:21:85:0c:44:4b	Port2	<input type="checkbox"/>
2	⬇	twpcMT	192.168.0.45	00:19:cb:32:be:ac	Wi-Fi	<input type="checkbox"/>

The following table describes the labels in this screen.

Table 24 Monitor > DHCP Table

LABEL	DESCRIPTION
#	This is the index number of the host computer.
Status	This field displays whether the connection to the host computer is up (a yellow bulb) or down (a gray bulb).
Host Name	This field displays the computer host name.
IP Address	This field displays the IP address relative to the # field listed above.
MAC Address	This field shows the MAC address of the computer with the name in the Host Name field. Every Ethernet device has a unique MAC (Media Access Control) address which uniquely identifies a device. The MAC address is assigned at the factory and consists of six pairs of hexadecimal characters, for example, 00:A0:C5:00:00:02.
Interface	This field shows the interface to which the host computer is connected.
Reserve	Select this if you want to reserve the IP address for this specific MAC address.
Apply	Click Apply to save your changes back to the EMG2926-Q10A.
Cancel	Click Cancel to reload the previous configuration for this screen.

9.5 Packet Statistics

Click **Monitor > Packet Statistics** or the **Packet Statistics (Details...)** hyperlink in the **Status** screen. Read-only information here includes port status, packet specific statistics and the "system up time". The **Poll Interval(s)** field is configurable and is used for refreshing the screen.

Figure 46 Monitor > Packet Statistics

Packet Statistics								
Port	Status	TxPkts	RxPkts	Collisions	Errors	Tx B/s	Rx B/s	Up Time
WAN	Down	3159	0	0	0	140	0	2: 24: 53
LAN	Down	4924	0	0	0	35	0	2: 24: 53
WLAN 2.4G	450M	194116	2133618	0	0	0	0	2: 24: 53
WLAN 5G	1.3G	10390	0	0	0	2	0	2: 24: 53

System Up Time : 2: 24: 53

Poll Interval(s):

The following table describes the labels in this screen.

Table 25 Monitor > Packet Statistics

LABEL	DESCRIPTION
Port	This is the EMG2926-Q10A's interface type.
Status	For the LAN ports, this displays the port speed and duplex setting or Down when the line is disconnected. For the WAN port, it displays the port speed and duplex setting if you're using Ethernet encapsulation and Idle (line (ppp) idle), Dial (starting to trigger a call) and Drop (dropping a call) if you're using PPPoE encapsulation. This field displays Down when the line is disconnected. For the 2.4GHz or 5GHz WLAN, it displays the maximum transmission rate when the WLAN is enabled and Down when the WLAN is disabled.
TxPkts	This is the number of transmitted packets on this port.
RxPkts	This is the number of received packets on this port.
Collisions	This is the number of collisions on this port.
Errors	This is the number of received errors on this port.
Tx B/s	This displays the transmission speed in bytes per second on this port.
Rx B/s	This displays the reception speed in bytes per second on this port.
Up Time	This is the total time the EMG2926-Q10A has been for each session.
System Up Time	This is the total time the EMG2926-Q10A has been on.
Poll Interval(s)	Enter the time interval in seconds for refreshing statistics in this field.
Set Interval	Click this button to apply the new poll interval you entered in the Poll Interval(s) field.
Stop	Click Stop to stop refreshing statistics.

9.6 WLAN Station Status

Click **Monitor > WLAN 2.4G/5G Station Status** or the **WLAN 2.4G/5G Station Status (Details...)** hyperlink in the **Status** screen. View the wireless stations that are currently associated to the EMG2926-Q10A's 2.4GHz or 5GHz wireless network in the **Association List**. Association means that a wireless client (for example, your network or computer with a wireless network card)

has connected successfully to the AP (or wireless router) using the same SSID, channel and security settings.

Figure 47 Monitor > WLAN Station Status



The screenshot shows a web interface titled 'Association List'. It contains a table with the following data:

#	MAC Address	Association Time
1	00:19:cb:32:be:ac	19:54:33 2014/01/15

The following table describes the labels in this screen.

Table 26 Monitor > WLAN Station Status

LABEL	DESCRIPTION
#	This is the index number of an associated wireless station.
MAC Address	This field displays the MAC address of an associated wireless station.
Association Time	This field displays the time a wireless station first associated with the EMG2926-Q10A's WLAN.

10.1 Overview

This chapter discusses the EMG2926-Q10A's **WAN** screens. Use these screens to configure your EMG2926-Q10A for Internet access.

A WAN (Wide Area Network) connection is an outside connection to another network or the Internet. It connects your private networks such as a LAN (Local Area Network) and other networks, so that a computer in one location can communicate with computers in other locations.

Figure 48 LAN and WAN

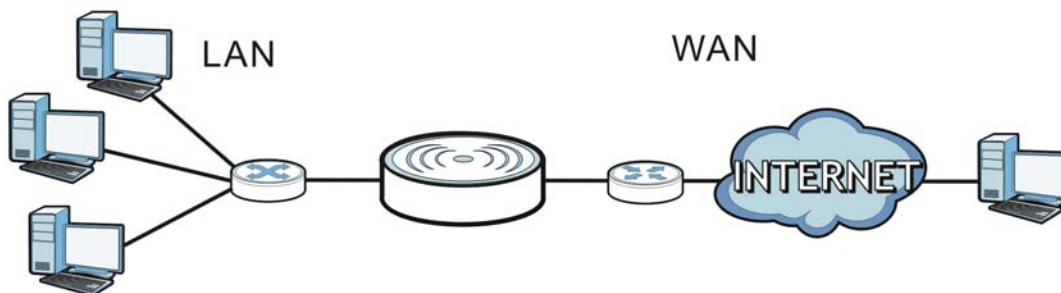

10.2 What You Can Do

- Use the **Internet Connection** screen to enter your ISP information and set how the computer acquires its IP, DNS and WAN MAC addresses ([Section 10.4 on page 78](#)).
- Use the **Advanced** screen to enable multicasting, configure Windows networking and bridge ([Section 10.5 on page 84](#)).

10.3 What You Need To Know

The information in this section can help you configure the screens for your WAN connection, as well as enable/disable some advanced features of your EMG2926-Q10A.

10.3.1 Configuring Your Internet Connection

Encapsulation Method

Encapsulation is used to include data from an upper layer protocol into a lower layer protocol. To set up a WAN connection to the Internet, you need to use the same encapsulation method used by your ISP (Internet Service Provider). If your ISP offers a dial-up Internet connection using PPPoE (PPP over Ethernet) or PPTP (Point-to-Point Tunneling Protocol), they should also provide a username and password (and service name) for user authentication.

WAN IP Address

The WAN IP address is an IP address for the EMG2926-Q10A, which makes it accessible from an outside network. It is used by the EMG2926-Q10A to communicate with other devices in other networks. It can be static (fixed) or dynamically assigned by the ISP each time the EMG2926-Q10A tries to access the Internet.

If your ISP assigns you a static WAN IP address, they should also assign you the subnet mask and DNS server IP address(es) (and a gateway IP address if you use the Ethernet or ENET ENCAP encapsulation method).

DNS Server Address Assignment

Use Domain Name System (DNS) to map a domain name to its corresponding IP address and vice versa, for instance, the IP address of `www.zyxel.com` is `204.217.0.2`. The DNS server is extremely important because without it, you must know the IP address of a computer before you can access it.

The EMG2926-Q10A can get the DNS server addresses in the following ways.

- 1 The ISP tells you the DNS server addresses, usually in the form of an information sheet, when you sign up. If your ISP gives you DNS server addresses, manually enter them in the DNS server fields.
- 2 If your ISP dynamically assigns the DNS server IP addresses (along with the EMG2926-Q10A's WAN IP address), set the DNS server fields to get the DNS server address from the ISP.

IPv6 Rapid Deployment

Use IPv6 Rapid Deployment (6rd) when the local network uses IPv6 and the ISP has an IPv4 network. When the EMG2926-Q10A has an IPv4 WAN address and you set **IPv6/IPv4** mode to **IPv4 Only**, you can enable 6rd to encapsulate IPv6 packets in IPv4 packets to cross the ISP's IPv4 network.

The EMG2926-Q10A generates a global IPv6 prefix from its IPv4 WAN address and tunnels IPv6 traffic to the ISP's Border Relay router (**BR** in the figure) to connect to the native IPv6 Internet. The local network can also use IPv4 services. The EMG2926-Q10A uses its configured IPv4 WAN IP to route IPv4 traffic to the IPv4 Internet.

Figure 49 IPv6 Rapid Deployment

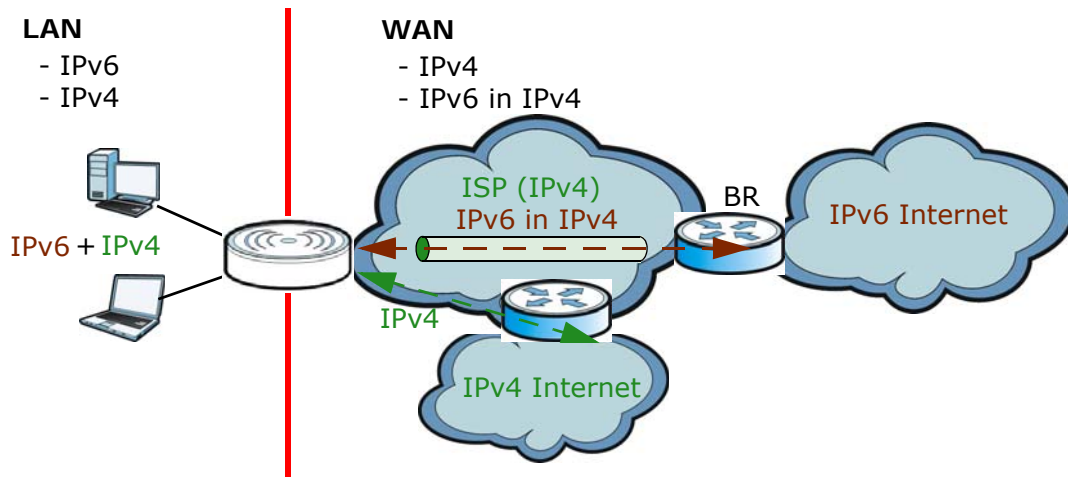

WAN MAC Address

The MAC address screen allows users to configure the WAN port's MAC address by either using the factory default or cloning the MAC address from a computer on your LAN. Choose **Factory Default** to select the factory assigned default MAC Address.

Otherwise, click **Clone the computer's MAC address - IP Address** and enter the IP address of the computer on the LAN whose MAC you are cloning. Once it is successfully configured, the address will be copied to configuration file. It is recommended that you clone the MAC address prior to hooking up the WAN Port.

Multicast

Traditionally, IP packets are transmitted in one of either two ways - Unicast (1 sender - 1 recipient) or Broadcast (1 sender - everybody on the network). Multicast delivers IP packets to a group of hosts on the network - not everybody and not just 1.

Figure 50 Multicast Example

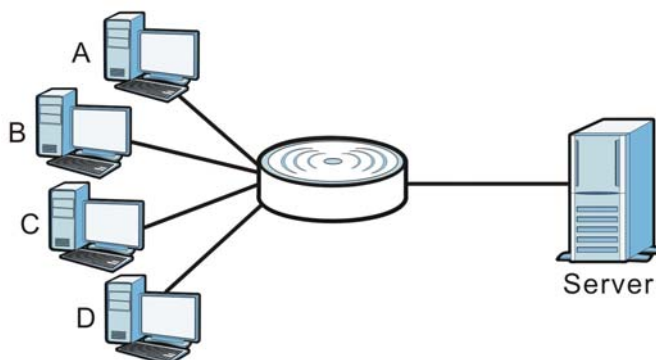

In the multicast example above, systems A and D comprise one multicast group. In multicasting, the server only needs to send one data stream and this is delivered to systems A and D.

IGMP (Internet Group Multicast Protocol) is a network-layer protocol used to establish membership in a multicast group - it is not used to carry user data. The EMG2926-Q10A supports both IGMP version 1 (**IGMP-v1**) and IGMP version 2 (**IGMP-v2**).

At start up, the EMG2926-Q10A queries all directly connected networks to gather group membership. After that, the EMG2926-Q10A periodically updates this information. IP multicasting can be enabled/disabled on the EMG2926-Q10A WAN interface in the Web Configurator (**WAN**). Select **None** to disable IP multicasting on these interfaces.

10.4 Internet Connection

Use this screen to change your EMG2926-Q10A's Internet access settings. Click **Network > WAN** from the **Configuration** menu. The screen differs according to the encapsulation and IPv4/IPv6 mode you choose.

10.4.1 IPoE Encapsulation

This screen displays when you select **IPoE** encapsulation.

Figure 51 Network > WAN > Internet Connection: IPoE Encapsulation (IPv4 Only)

The following table describes the labels in this screen.

Table 27 Network > WAN > Internet Connection: IPoE Encapsulation

LABEL	DESCRIPTION
ISP Parameters for Internet Access	
Encapsulation	You must choose the IPoE option when the WAN port is used as a regular Ethernet.
IPv4 / IPv6	Select IPv4 Only if you want the EMG2926-Q10A to run IPv4 only. Select Dual Stack to allow the EMG2926-Q10A to run IPv4 and IPv6 at the same time. Select IPv6 Only if you want the EMG2926-Q10A to run IPv6 only.

Table 27 Network > WAN > Internet Connection: IPoE Encapsulation (continued)

LABEL	DESCRIPTION
IP Address	
Obtain an IP Address Automatically	Select this option If your ISP did not assign you a fixed IP address. This is the default selection.
Static IP Address	Select this option If the ISP assigned a fixed IP address.
IP Address	Enter your WAN IP address in this field if you selected Static IP Address .
Subnet Mask	Enter the Subnet Mask in this field.
Gateway IP Address	Enter a Gateway IP Address (if your ISP gave you one) in this field.
MTU Size	Enter the MTU (Maximum Transmission Unit) size for each packet. If a larger packet arrives, the EMG2926-Q10A divides it into smaller fragments.
DHCP Option	
Enable DHCP Option 121	Select this to enable the classless route option 121.
Enable DHCP Option 125	Select this to add vendor specific information to DHCP requests that the EMG2926-Q10A sends to a DHCP server when getting a WAN IP address.
Enable DHCP Option 60	Select this to identify the vendor and functionality of the EMG2926-Q10A in DHCP requests that the EMG2926-Q10A sends to a DHCP server when getting a WAN IP address.
Vendor ID	Enter the Vendor Class Identifier (Option 60), such as the type of the hardware or firmware.
6RD	
This is available only when you select IPv4 Only in the IPv6/IPv4 field.	
Enable 6RD	Enable IPv6 rapid deployment to tunnel IPv6 traffic from the local network through the ISP's IPv4 network.
Automatically configured by DHCP	Select this to have the EMG2926-Q10A detect the relay server IP address automatically through DHCP.
Manually Configured	Select this if you have the IPv4 address of the relay server.
Border Relay IPv4 Address	Specify the relay server IPv4 address.
Service Provider IPv6 Prefix	Enter an IPv6 prefix for tunneling IPv6 traffic to the ISP's Border Relay router and connecting to the native IPv6 Internet.
Service Provider IPv6 Prefix length	Enter the IPv6 prefix length. An IPv6 prefix length specifies how many most significant bits (starting from the left) in the address compose the network address.
IPv4 mask length	Enter the subnet mask number (1~32) for the IPv4 network.
DNS Server	
First DNS Server Second DNS Server Third DNS Server	Select Obtained From ISP if your ISP dynamically assigns DNS server information (and the EMG2926-Q10A's WAN IP address). The field to the right displays the (read-only) DNS server IP address that the ISP assigns. Select User-Defined if you have the IP address of a DNS server. Enter the DNS server's IP address in the field to the right. If you chose User-Defined, but leave the IP address set to 0.0.0.0, User-Defined changes to None after you click Apply. If you set a second choice to User-Defined, and enter the same IP address, the second User-Defined changes to None after you click Apply. Select None if you do not want to configure DNS servers. If you do not configure a DNS server, you must know the IP address of a computer in order to access it.

Table 27 Network > WAN > Internet Connection: IPoE Encapsulation (continued)

LABEL	DESCRIPTION
WAN MAC Address	The MAC address section allows users to configure the WAN port's MAC address by either using the EMG2926-Q10A's MAC address, copying the MAC address from a computer on your LAN or manually entering a MAC address.
Factory default	Select Factory default to use the factory assigned default MAC Address.
Clone the computer's MAC address—IP Address	Select Clone the computer's MAC address -- IP Address and enter the IP address of the computer on the LAN whose MAC you are cloning.
Set WAN MAC Address	Select this option and enter the MAC address you want to use.
IPv6 Address This is not available when you select IPv4 Only in the IPv6/IPv4 field.	
Obtain an IP Address Automatically	Select this if you want to obtain an IPv6 address from a DHCPv6 server.
Static IP Address	Select this if you have a fixed IPv6 address assigned by your ISP.
IPv6 Address	Enter the IPv6 address assigned by your ISP.
Prefix length	Enter the address prefix length to specify how many most significant bits in an IPv6 address compose the network address.
IPv6 Default Gateway	Enter the IP address of the next-hop gateway. The gateway is a router or switch on the same segment as your EMG2926-Q10A's interface(s). The gateway helps forward packets to their destinations.
IPv6 DNS server This is not available when you select IPv4 Only in the IPv6/IPv4 field.	
Obtain IPv6 DNS info Automatically	Select this to have the EMG2926-Q10A get the IPv6 DNS server addresses from the ISP automatically.
Use the following Static DNS IPv6 Address	Select this to have the EMG2926-Q10A use the IPv6 DNS server addresses you configure manually.
IPv6 DNS Server	Enter the IPv6 DNS server address assigned by the ISP.
Apply	Click Apply to save your changes back to the EMG2926-Q10A.
Cancel	Click Cancel to begin configuring this screen afresh.

10.4.2 PPPoE Encapsulation

The EMG2926-Q10A supports PPPoE (Point-to-Point Protocol over Ethernet). PPPoE is an IETF standard (RFC 2516) specifying how a personal computer (PC) interacts with a broadband modem (DSL, cable, wireless, etc.) connection. The **PPP over Ethernet** option is for a dial-up connection using PPPoE.

For the service provider, PPPoE offers an access and authentication method that works with existing access control systems (for example Radius).

One of the benefits of PPPoE is the ability to let you access one of multiple network services, a function known as dynamic service selection. This enables the service provider to easily create and offer new IP services for individuals.

Operationally, PPPoE saves significant effort for both you and the ISP or carrier, as it requires no specific configuration of the broadband modem at the customer site.

By implementing PPPoE directly on the EMG2926-Q10A (rather than individual computers), the computers on the LAN do not need PPPoE software installed, since the EMG2926-Q10A does that part of the task. Furthermore, with NAT, all of the LANs' computers will have access.

This screen displays when you select **PPPoE** encapsulation.

Figure 52 Network > WAN > Internet Connection: PPPoE Encapsulation (IPv4 Only)

The screenshot shows the configuration page for PPPoE Encapsulation (IPv4 Only). The page is titled "Internet Connection" and has an "Advanced" tab selected. The configuration is organized into several sections:

- ISP Parameters for Internet Access:** Encapsulation is set to "PPPoE" and IPv4 / IPv6 is set to "IPv4 Only".
- PPP Information:** Fields for PPP Username, PPP Password, MTU Size (1454), PPP Auto Connect (checked), IDLE Timeout [second] (300), and PPPoE Service Name.
- WAN IP Address Assignment:** Radio buttons for "Get automatically from ISP" (selected) and "Use Fixed IP Address". A field for "My WAN IP Address" is present.
- 6RD:** Checkboxes for "Enable 6RD" (checked) and "Manually Configured". Fields for Border Relay IPv4 Address, Service Provider IPv6 Prefix, Service Provider IPv6 Prefix length (32), and IPv4 mask length (0).
- DNS Server:** Fields for First, Second, and Third DNS Server, each with a dropdown menu set to "Obtained From ISP" and an adjacent input field.

At the bottom of the page, there are "Apply" and "Cancel" buttons.

The following table describes the labels in this screen.

Table 28 Network > WAN > Internet Connection: PPPoE Encapsulation

LABEL	DESCRIPTION
ISP Parameters for Internet Access	
Encapsulation	Select PPPoE if you connect to your Internet via dial-up.
IPv4 / IPv6	Select IPv4 Only if you want the EMG2926-Q10A to run IPv4 only. Select Dual Stack to allow the EMG2926-Q10A to run IPv4 and IPv6 at the same time. Select IPv6 Only if you want the EMG2926-Q10A to run IPv6 only.
PPP Information	
PPP Username	Type the user name given to you by your ISP.
PPP Password	Type the password associated with the user name above.
MTU Size	Enter the Maximum Transmission Unit (MTU) or the largest packet size per frame that your EMG2926-Q10A can receive and process.
PPP Auto Connect	Select this option if you do not want the connection to time out.
Idle Timeout (second)	This value specifies the time in minutes that elapses before the router automatically disconnects from the PPPoE server.
PPPoE Service Name	Enter the PPPoE service name specified in the ISP account.
WAN IP Address Assignment	
Get automatically from ISP	Select this option If your ISP did not assign you a fixed IP address. This is the default selection.
Use Fixed IP Address	Select this option If the ISP assigned a fixed IP address.
My WAN IP Address	Enter your WAN IP address in this field if you selected Use Fixed IP Address .
6RD This is available only when you select IPv4 Only in the IPv6/IPv4 field.	
Enable 6RD	Enable IPv6 rapid deployment to tunnel IPv6 traffic from the local network through the ISP's IPv4 network.
Automatically configured by DHCP	Select this to have the EMG2926-Q10A detect the relay server IP address automatically through DHCP.
Manually Configured	Select this if you have the IPv4 address of the relay server.
Border Relay IPv4 Address	Specify the relay server IPv4 address.
Service Provider IPv6 Prefix	Enter an IPv6 prefix for tunneling IPv6 traffic to the ISP's Border Relay router and connecting to the native IPv6 Internet.
Service Provider IPv6 Prefix length	Enter the IPv6 prefix length. An IPv6 prefix length specifies how many most significant bits (starting from the left) in the address compose the network address.
IPv4 mask length	Enter the subnet mask number (1~32) for the IPv4 network.
DNS Server	

Table 28 Network > WAN > Internet Connection: PPPoE Encapsulation (continued)

LABEL	DESCRIPTION
First DNS Server	Select Obtained From ISP if your ISP dynamically assigns DNS server information (and the EMG2926-Q10A's WAN IP address). The field to the right displays the (read-only) DNS server IP address that the ISP assigns.
Second DNS Server	Select User-Defined if you have the IP address of a DNS server. Enter the DNS server's IP address in the field to the right. If you chose User-Defined, but leave the IP address set to 0.0.0.0, User-Defined changes to None after you click Apply. If you set a second choice to User-Defined, and enter the same IP address, the second User-Defined changes to None after you click Apply.
Third DNS Server	Select None if you do not want to configure DNS servers. If you do not configure a DNS server, you must know the IP address of a computer in order to access it.
IPv6 DNS server	This is not available when you select IPv4 Only in the IPv6/IPv4 field.
Obtain IPv6 DNS info Automatically	Select this to have the EMG2926-Q10A get the IPv6 DNS server addresses from the ISP automatically.
Use the following Static DNS IPv6 Address	Select this to have the EMG2926-Q10A use the IPv6 DNS server addresses you configure manually.
IPv6 DNS Server	Enter the IPv6 DNS server address assigned by the ISP.
WAN MAC Address	The MAC address section allows users to configure the WAN port's MAC address by using the EMG2926-Q10A's MAC address, copying the MAC address from a computer on your LAN or manually entering a MAC address.
Factory default	Select Factory default to use the factory assigned default MAC Address.
Clone the computer's MAC address - IP Address	Select Clone the computer's MAC address - IP Address and enter the IP address of the computer on the LAN whose MAC you are cloning.
Set WAN MAC Address	Select this option and enter the MAC address you want to use.
Apply	Click Apply to save your changes back to the EMG2926-Q10A.
Cancel	Click Cancel to begin configuring this screen afresh.

10.5 Advanced WAN Screen

To change your EMG2926-Q10A's advanced WAN settings, click **Network > WAN > Advanced**. The screen appears as shown.

Figure 53 Network > WAN > Advanced

The screenshot shows the 'Advanced' configuration page for WAN. It features two main sections: 'Multicast Setup' and 'Auto-Subnet Configuration'. In the 'Multicast Setup' section, there is a dropdown menu labeled 'Multicast Setup' with 'IGMPv1/v2' selected. The 'Auto-Subnet Configuration' section has a checkbox labeled 'Enable Auto-IP-Change Mode' which is checked. At the bottom of the page, there are two buttons: 'Apply' and 'Cancel'.

The following table describes the labels in this screen.

Table 29 Network > WAN > Advanced

LABEL	DESCRIPTION
Multicast Setup	
Multicast	Select IGMPv1/v2 to enable multicasting. This applies to traffic routed from the WAN to the LAN. Select None to disable this feature. This may cause incoming traffic to be dropped or sent to all connected network devices.
Auto-Subnet Configuration	
Enable Auto-IP-Change mode	Select this option to have the EMG2926-Q10A change its LAN IP address to 10.0.0.1 or 192.168.0.1 accordingly when the EMG2926-Q10A gets a dynamic WAN IP address in the same subnet as the LAN IP address 192.168.0.1 or 10.0.0.1. The NAT, DHCP server and firewall functions on the EMG2926-Q10A are still available in this mode.
Apply	Click Apply to save your changes back to the EMG2926-Q10A.
Cancel	Click Cancel to begin configuring this screen afresh.

Wireless LAN

11.1 Overview

This chapter discusses how to configure the wireless network settings in your EMG2926-Q10A. The EMG2926-Q10A is able to function both 2.4GHz and 5GHz network at the same time. You can have different wireless and wireless security settings for 2.4GHz and 5GHz wireless LANs. Click **Configuration > Network > Wireless LAN 2.4G** or **Wireless LAN 5G** to configure to do so.

See the appendices for more detailed information about wireless networks.

The following figure provides an example of a wireless network.

Figure 54 Example of a Wireless Network

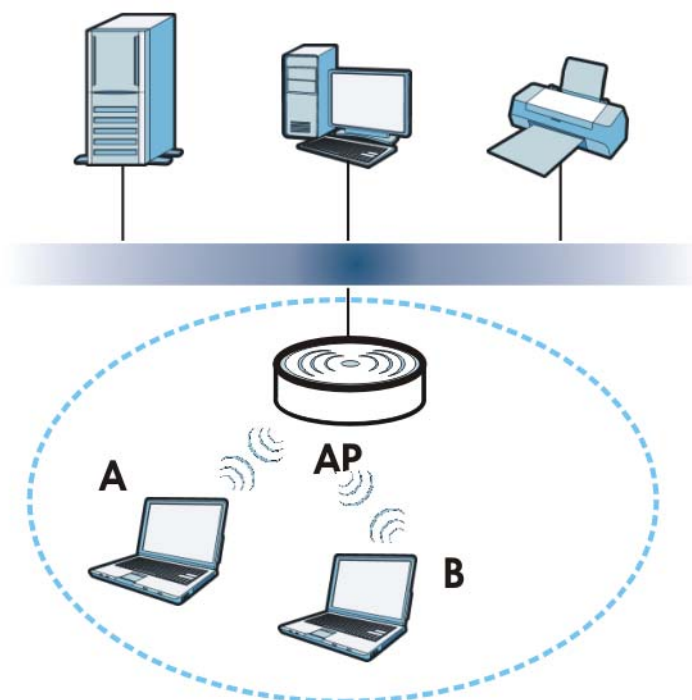

The wireless network is the part in the blue circle. In this wireless network, devices **A** and **B** are called wireless clients. The wireless clients use the access point (AP) to interact with other devices (such as the printer) or with the Internet. Your EMG2926-Q10A is the AP.

11.1.1 What You Can Do

- Use the **General** screen to turn the wireless connection on or off, set up wireless security between the EMG2926-Q10A and the wireless clients, and make other basic configuration changes ([Section 11.2 on page 91](#)).
- Use the **More AP** screen to set up multiple wireless networks on your EMG2926-Q10A ([Section 11.4 on page 99](#)).
- Use the **MAC Filter** screen to allow or deny wireless stations based on their MAC addresses from connecting to the EMG2926-Q10A ([Section 11.5 on page 102](#)).
- Use the **Advanced** screen to allow intra-BSS networking and set the RTS/CTS Threshold ([Section 11.6 on page 104](#)).
- Use the **QoS** screen to ensure Quality of Service (QoS) in your wireless network ([Section 11.7 on page 105](#)).
- Use the **WPS** screen to quickly set up a wireless network with strong security, without having to configure security settings manually ([Section 11.8 on page 105](#)).
- Use the **WPS Station** screen to add a wireless station using WPS ([Section 11.9 on page 107](#)).
- Use the **Scheduling** screen to set the times your wireless LAN is turned on and off ([Section 11.10 on page 107](#)).

11.1.2 What You Should Know

Every wireless network must follow these basic guidelines.

- Every wireless client in the same wireless network must use the same SSID.
The SSID is the name of the wireless network. It stands for Service Set IDentity.
- If two wireless networks overlap, they should use different channels.
Like radio stations or television channels, each wireless network uses a specific channel, or frequency, to send and receive information.
- Every wireless client in the same wireless network must use security compatible with the AP.
Security stops unauthorized devices from using the wireless network. It can also protect the information that is sent in the wireless network.

Wireless Security Overview

The following sections introduce different types of wireless security you can set up in the wireless network.

SSID

Normally, the AP acts like a beacon and regularly broadcasts the SSID in the area. You can hide the SSID instead, in which case the AP does not broadcast the SSID. In addition, you should change the default SSID to something that is difficult to guess.

This type of security is fairly weak, however, because there are ways for unauthorized devices to get the SSID. In addition, unauthorized devices can still see the information that is sent in the wireless network.

MAC Address Filter

Every wireless client has a unique identification number, called a MAC address.¹ A MAC address is usually written using twelve hexadecimal characters²; for example, 00A0C5000002 or 00:A0:C5:00:00:02. To get the MAC address for each wireless client, see the appropriate User's Guide or other documentation.

You can use the MAC address filter to tell the AP which wireless clients are allowed or not allowed to use the wireless network. If a wireless client is allowed to use the wireless network, it still has to have the correct settings (SSID, channel, and security). If a wireless client is not allowed to use the wireless network, it does not matter if it has the correct settings.

This type of security does not protect the information that is sent in the wireless network. Furthermore, there are ways for unauthorized devices to get the MAC address of an authorized wireless client. Then, they can use that MAC address to use the wireless network.

User Authentication

You can make every user log in to the wireless network before they can use it. This is called user authentication. However, every wireless client in the wireless network has to support IEEE 802.1x to do this.

For wireless networks, there are two typical places to store the user names and passwords for each user.

- In the AP: this feature is called a local user database or a local database.
- In a RADIUS server: this is a server used in businesses more than in homes.

If your AP does not provide a local user database and if you do not have a RADIUS server, you cannot set up user names and passwords for your users.

Unauthorized devices can still see the information that is sent in the wireless network, even if they cannot use the wireless network. Furthermore, there are ways for unauthorized wireless users to get a valid user name and password. Then, they can use that user name and password to use the wireless network.

Local user databases also have an additional limitation that is explained in the next section.

Encryption

Wireless networks can use encryption to protect the information that is sent in the wireless network. Encryption is like a secret code. If you do not know the secret code, you cannot understand the message.

1. Some wireless devices, such as scanners, can detect wireless networks but cannot use wireless networks. These kinds of wireless devices might not have MAC addresses.

2. Hexadecimal characters are 0, 1, 2, 3, 4, 5, 6, 7, 8, 9, A, B, C, D, E, and F.

The types of encryption you can choose depend on the type of user authentication. (See [page 88](#) for information about this.)

Table 30 Types of Encryption for Each Type of Authentication

	NO AUTHENTICATION	RADIUS SERVER
Weakest  Strongest	No Security	WPA
	Static WEP	
	WPA-PSK	
	WPA2-PSK	WPA2

For example, if the wireless network has a RADIUS server, you can choose **WPA** or **WPA2**. If users do not log in to the wireless network, you can choose no encryption, **Static WEP**, **WPA-PSK**, or **WPA2-PSK**.

Usually, you should set up the strongest encryption that every wireless client in the wireless network supports. For example, suppose the AP does not have a local user database, and you do not have a RADIUS server. Therefore, there is no user authentication. Suppose the wireless network has two wireless clients. Device A only supports WEP, and device B supports WEP and WPA. Therefore, you should set up **Static WEP** in the wireless network.

Note: It is recommended that wireless networks use **WPA-PSK**, **WPA**, or stronger encryption. IEEE 802.1x and WEP encryption are better than none at all, but it is still possible for unauthorized devices to figure out the original information pretty quickly.

Note: It is not possible to use **WPA-PSK**, **WPA** or stronger encryption with a local user database. In this case, it is better to set up stronger encryption with no authentication than to set up weaker encryption with the local user database.

When you select **WPA2** or **WPA2-PSK** in your EMG2926-Q10A, you can also select an option (**WPA/WPA-PSK Compatible**) to support WPA/WPA-PSK as well. In this case, if some wireless clients support WPA and some support WPA2, you should set up **WPA2-PSK** or **WPA2** (depending on the type of wireless network login) and select the **WPA/WPA-PSK Compatible** option in the EMG2926-Q10A.

Many types of encryption use a key to protect the information in the wireless network. The longer the key, the stronger the encryption. Every wireless client in the wireless network must have the same key.

Guest WLAN

Guest WLAN allows you to set up a wireless network where users can access to Internet via the EMG2926-Q10A (**Z**), but not other networks connected to the **Z**. In the following figure, a guest user can access the Internet from the guest wireless network **A** via **Z** but not the home or company network **N**.

Note: The home or company network **N** and Guest WLAN network are independent networks.

Note: Only Router mode supports guest WLAN.

Figure 55 Guest Wireless LAN Network

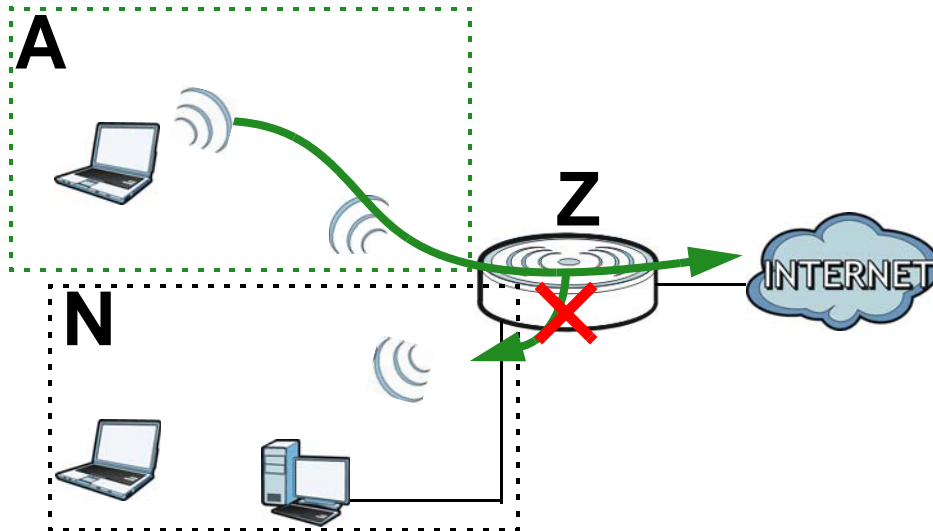

Guest WLAN Bandwidth

The Guest WLAN Bandwidth function allows you to restrict the maximum bandwidth for the guest wireless network. Additionally, you can also define bandwidth for your home or office network. An example is shown next to define maximum bandwidth for your networks (A is Guest WLAN and N is home or company network.)

Figure 56 Example: Bandwidth for Different Networks

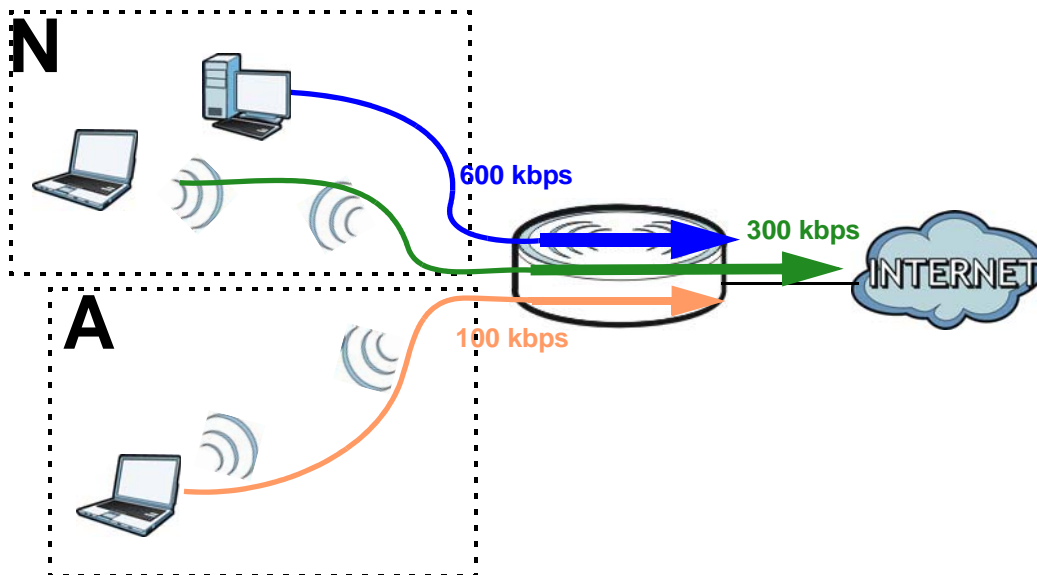

WPS

WiFi Protected Setup (WPS) is an industry standard specification, defined by the WiFi Alliance. WPS allows you to quickly set up a wireless network with strong security, without having to configure security settings manually. Depending on the devices in your network, you can either press a button (on the device itself, or in its configuration utility) or enter a PIN (Personal Identification

Number) in the devices. Then, they connect and set up a secure network by themselves. See how to set up a secure wireless network using WPS in the [Section 8.2 on page 57](#).

11.2 General Wireless LAN Screen

Use this screen to configure the SSID and wireless security of the wireless LAN.

Note: If you are configuring the EMG2926-Q10A from a computer connected to the wireless LAN and you change the EMG2926-Q10A's SSID, channel or security settings, you will lose your wireless connection when you press **Apply** to confirm. You must then change the wireless settings of your computer to match the EMG2926-Q10A's new settings.

Click **Network > Wireless LAN 2.4G/5G** to open the **General** screen.

Figure 57 Network > Wireless LAN 2.4G/5G > General

The following table describes the general wireless LAN labels in this screen.

Table 31 Network > Wireless LAN 2.4G/5G > General

LABEL	DESCRIPTION
Wireless LAN	Select Enable to activate the 2.4GHz and/or 5GHz wireless LAN. Select Disable to turn it off. You can enable or disable both 2.4GHz and 5GHz wireless LANs by using the WIFI button located on the side panel of the EMG2926-Q10A.
Name (SSID)	The SSID (Service Set IDentity) identifies the Service Set with which a wireless client is associated. Enter a descriptive name (up to 32 printable characters found on a typical English language keyboard) for the wireless LAN.
Hide SSID	Select this check box to hide the SSID in the outgoing beacon frame so a station cannot obtain the SSID through scanning using a site survey tool.

Table 31 Network > Wireless LAN 2.4G/5G > General (continued)

LABEL	DESCRIPTION
Channel Selection	<p>Set the operating frequency/channel depending on your particular region.</p> <p>Select a channel from the drop-down list box. The options vary depending on the frequency band and the country you are in.</p> <p>Refer to the Connection Wizard chapter for more information on channels. This option is only available if Auto Channel Selection is disabled.</p>
Auto Channel Selection	<p>Select this check box for the EMG2926-Q10A to automatically choose the channel with the least interference. Deselect this check box if you wish to manually select the channel using the Channel Selection field.</p>
Operating Channel	<p>This displays the channel the EMG2926-Q10A is currently using.</p>
Channel Width	<p>Select the wireless channel width used by EMG2926-Q10A.</p> <p>A standard 20MHz channel offers transfer speeds of up to 144Mbps (2.4GHz) or 217Mbps (5GHZ) whereas a 40MHz channel uses two standard channels and offers speeds of up to 300Mbps (2.4GHz) or 450Mbps (5GHZ). An IEEE 802.11ac-specific 80MHz channel offers speeds of up to 1.3Gbps.</p> <p>Because not all devices support 40 MHz and/or 80 MHz channels, select Auto 20/40 MHz or Auto 20/40/80 MHz to allow the EMG2926-Q10A to adjust the channel bandwidth automatically.</p> <p>40 MHz (channel bonding or dual channel) bonds two adjacent radio channels to increase throughput. A 80 MHz channel consists of two adjacent 40 MHz channels. The wireless clients must also support 40 MHz or 80 MHz. It is often better to use the 20 MHz setting in a location where the environment hinders the wireless signal.</p> <p>Select 20 MHz if you want to lessen radio interference with other wireless devices in your neighborhood or the wireless clients do not support channel bonding.</p>
802.11 Mode	<p>If you are in the Wireless LAN 2.4G > General screen, you can select from the following:</p> <ul style="list-style-type: none"> • 802.11b: allows either IEEE 802.11b or IEEE 802.11g compliant WLAN devices to associate with the EMG2926-Q10A. In this mode, all wireless devices can only transmit at the data rates supported by IEEE 802.11b. • 802.11g: allows IEEE 802.11g compliant WLAN devices to associate with the Device. IEEE 802.11b compliant WLAN devices can associate with the EMG2926-Q10A only when they use the short preamble type. • 802.11bg: allows either IEEE 802.11b or IEEE 802.11g compliant WLAN devices to associate with the EMG2926-Q10A. The EMG2926-Q10A adjusts the transmission rate automatically according to the wireless standard supported by the wireless devices. • 802.11n: allows IEEE 802.11n compliant WLAN devices to associate with the EMG2926-Q10A. This can increase transmission rates, although IEEE 802.11b or IEEE 802.11g clients will not be able to connect to the EMG2926-Q10A. I • 802.11gn: allows either IEEE 802.11g or IEEE 802.11n compliant WLAN devices to associate with the EMG2926-Q10A. The transmission rate of your EMG2926-Q10A might be reduced. • 802.11 bgn: allows IEEE802.11b, IEEE802.11g and IEEE802.11n compliant WLAN devices to associate with the EMG2926-Q10A. The transmission rate of your EMG2926-Q10A might be reduced. <p>If you are in the Wireless LAN 5G > General screen, you can select from the following:</p> <ul style="list-style-type: none"> • 802.11a: allows only IEEE 802.11a compliant WLAN devices to associate with the EMG2926-Q10A. • 802.11an: allows both IEEE802.11n and IEEE802.11a compliant WLAN devices to associate with the EMG2926-Q10A. The transmission rate of your EMG2926-Q10A might be reduced. • 802.11ac: allows only IEEE 802.11ac compliant WLAN devices to associate with the EMG2926-Q10A.

Table 31 Network > Wireless LAN 2.4G/5G > General (continued)

LABEL	DESCRIPTION
Security Mode	Select Static WEP , WPA-PSK , WPA , WPA2-PSK or WPA2 to add security on this wireless network. The wireless clients which want to associate to this network must have same wireless security settings as this device. After you select to use a security, additional options appears in this screen. See Section 11.3 on page 93 for detailed information on different security modes. Or you can select No Security to allow any client to associate this network without authentication. Note: If the WPS function is enabled (default), only No Security and WPA2-PSK are available in this field.
Apply	Click Apply to save your changes back to the EMG2926-Q10A.
Cancel	Click Cancel to reload the previous configuration for this screen.

See the rest of this chapter for information on the other labels in this screen.

11.3 Wireless Security

The screen varies depending on what you select in the **Security Mode** field.

11.3.1 No Security

Select **No Security** to allow wireless clients to communicate with the access points without any data encryption.

Note: If you do not enable any wireless security on your EMG2926-Q10A, your network is accessible to any wireless networking device that is within range.

Figure 58 Network > Wireless LAN 2.4G/5G > General: No Security

The screenshot shows the configuration interface for the wireless LAN. The 'General' tab is selected. Under 'Wireless Setup', 'Wireless LAN' is enabled. The SSID is 'VIDEOTRON0065'. Channel selection is set to 'Channel-6 2437MHz' with 'Auto Channel Selection' checked. The operating channel is 'Channel-6', channel width is 'Auto 20/40 MHz', and the 802.11 mode is '802.11bgn'. Under the 'Security' section, 'Security Mode' is set to 'No Security'. A note at the bottom states: 'Note: No Security and WPA2-PSK can be configured when WPS enabled.' Buttons for 'Apply' and 'Cancel' are at the bottom.

The following table describes the labels in this screen.

Table 32 Network > Wireless LAN 2.4G/5G > General: No Security

LABEL	DESCRIPTION
Security Mode	Choose No Security from the drop-down list box.
Apply	Click Apply to save your changes back to the EMG2926-Q10A.
Cancel	Click Cancel to reload the previous configuration for this screen.

11.3.2 WEP Encryption

WEP encryption scrambles the data transmitted between the wireless stations and the access points to keep network communications private. It encrypts unicast and multicast communications in a network. Both the wireless stations and the access points must use the same WEP key.

Your EMG2926-Q10A allows you to configure up to four 64-bit or 128-bit WEP keys but only one key can be enabled at any one time.

Select **Static WEP** from the **Security Mode** list.

Figure 59 Network > Wireless LAN 2.4G/5G > General: Static WEP

Wireless Setup

Wireless LAN : Enable Disable

Name (SSID) :

Hide SSID

Channel Selection : Auto Channel Selection

Operating Channel : Channel-6

Channel Width :

802.11 Mode :

Security

Security Mode :

PassPhrase :

WEP Encryption :

Authentication Method :

Note:
64-bit WEP: Enter 5 ASCII characters or 10 hexadecimal characters ("0-9", "A-F") for each Key (1-4).
128-bit WEP: Enter 13 ASCII characters or 26 hexadecimal characters ("0-9", "A-F") for each Key (1-4).
 (Select one WEP key as an active key to encrypt wireless data transmission.)

ASCII Hex

Key 1

Key 2

Key 3

Key 4

Note: No Security and WPA2-PSK can be configured when WPS enabled.

The following table describes the wireless LAN security labels in this screen.

Table 33 Network > Wireless LAN 2.4G/5G > General: Static WEP

LABEL	DESCRIPTION
Security Mode	Select Static WEP to enable data encryption.
PassPhrase	Enter a Passphrase (up to 26 printable characters) and click Generate . A passphrase functions like a password. In WEP security mode, it is further converted by the EMG2926-Q10A into a complicated string that is referred to as the "key". This key is requested from all devices wishing to connect to a wireless network.
WEP Encryption	Select 64-bits or 128-bits . This dictates the length of the security key that the network is going to use.

Table 33 Network > Wireless LAN 2.4G/5G > General: Static WEP (continued)

LABEL	DESCRIPTION
Authentication Method	Select Auto or Shared Key from the drop-down list box. This field specifies whether the wireless clients have to provide the WEP key to login to the wireless client. Keep this setting at Auto unless you want to force a key verification before communication between the wireless client and the EMG2926-Q10A occurs. Select Shared Key to force the clients to provide the WEP key prior to communication.
ASCII	Select this option in order to enter ASCII characters as WEP key.
Hex	Select this option in order to enter hexadecimal characters as a WEP key. The preceding "0x", that identifies a hexadecimal key, is entered automatically.
Key 1 to Key 4	The WEP keys are used to encrypt data. Both the EMG2926-Q10A and the wireless stations must use the same WEP key for data transmission. If you chose 64-bits , then enter any 5 ASCII characters or 10 hexadecimal characters ("0-9", "A-F"). If you chose 128-bits , then enter 13 ASCII characters or 26 hexadecimal characters ("0-9", "A-F"). You must configure at least one key, only one key can be activated at any one time. The default key is key 1.
Apply	Click Apply to save your changes back to the EMG2926-Q10A.
Cancel	Click Cancel to reload the previous configuration for this screen.

11.3.3 WPA-PSK/WPA2-PSK

Select **WPA-PSK** or **WPA2-PSK** from the **Security Mode** list.

Figure 60 Network > Wireless LAN 2.4G/5G > General: WPA-PSK/WPA2-PSK

General | More AP | MAC Filter | Advanced | QoS | WPS | WPS Station | Scheduling

Wireless Setup

Wireless LAN : Enable Disable

Name (SSID) :

Hide SSID

Channel Selection : Auto Channel Selection

Operating Channel :

Channel Width :

802.11 Mode :

Security

Security Mode :

WPA-PSK Compatible

Pre-Shared Key

Group Key Update Timer seconds

Note: No Security and WPA2-PSK can be configured when WPS enabled.

The following table describes the labels in this screen.

Table 34 Network > Wireless LAN 2.4G/5G > General: WPA-PSK/WPA2-PSK

LABEL	DESCRIPTION
Security Mode	Select WPA-PSK or WPA2-PSK to enable data encryption.
WPA-PSK Compatible	This field appears when you choose WPA2-PSK as the Security Mode . Check this field to allow wireless devices using WPA-PSK security mode to connect to your EMG2926-Q10A.
Pre-Shared Key	WPA-PSK/WPA2-PSK uses a simple common password for authentication. Type a pre-shared key from 8 to 63 case-sensitive keyboard characters.
Group Key Update Timer	The Group Key Update Timer is the rate at which the AP sends a new group key out to all clients. The default is 3600 seconds (60 minutes).
Apply	Click Apply to save your changes back to the EMG2926-Q10A.
Cancel	Click Cancel to reload the previous configuration for this screen.

11.3.4 WPA/WPA2

Select **WPA** or **WPA2** from the **Security Mode** list.

Note: WPA or WPA2 is not available if you enable WPS before you configure WPA or WPA2 in the **Wireless LAN 2.4G/5G > General** screen.

Figure 61 Network > Wireless LAN 2.4G/5G > General: WPA/WPA2

General More AP MAC Filter Advanced QoS WPS WPS Station Scheduling

Wireless Setup

Wireless LAN : Enable Disable

Name (SSID) :

Hide SSID

Channel Selection : Auto Channel Selection

Operating Channel : Channel-6

Channel Width :

802.11 Mode :

Security

Security Mode :

WPA Compatible

Group Key Update Timer seconds

PMK Cache Period minutes

Pre-Authentication Enable Disable

Authentication Server

IP Address

Port Number

Shared Secret

Session Timeout(0 or 60~) seconds

Note: No Security and WPA2-PSK can be configured when WPS enabled.

The following table describes the labels in this screen.

Table 35 Network > Wireless LAN 2.4G/5G > General: WPA/WPA2

LABEL	DESCRIPTION
Security Mode	Select WPA or WPA2 to enable data encryption.
WPA Compatible	This check box is available only when you select WPA2-PSK or WPA2 in the Security Mode field. Select the check box to have both WPA2 and WPA wireless clients be able to communicate with the EMG2926-Q10A even when the EMG2926-Q10A is using WPA2-PSK or WPA2.
Group Key Update Timer	The Group Key Update Timer is the rate at which the AP (if using WPA-PSK/WPA2-PSK key management) or RADIUS server (if using WPA/WPA2 key management) sends a new group key out to all clients. The re-keying process is the WPA/WPA2 equivalent of automatically changing the WEP key for an AP and all stations in a WLAN on a periodic basis. Setting of the Group Key Update Timer is also supported in WPA-PSK/WPA2-PSK mode.

Table 35 Network > Wireless LAN 2.4G/5G > General: WPA/WPA2 (continued)

LABEL	DESCRIPTION
PMK Cache Period	This field is available only when you select WPA2 . Specify how often wireless clients have to resend usernames and passwords in order to stay connected. Enter a time interval between 10 and 999999 minutes. Note: If wireless client authentication is done using a RADIUS server, the reauthentication timer on the RADIUS server has priority.
Pre-Authentication	This field is available only when you select WPA2 . Pre-authentication enables fast roaming by allowing the wireless client (already connecting to an AP) to perform IEEE 802.1x authentication with another AP before connecting to it. Select Enable to turn on preauthentication in WAP2. Otherwise, select Disable .
Authentication Server	
IP Address	Enter the IP address of the external authentication server in dotted decimal notation.
Port Number	Enter the port number of the external authentication server. You need not change this value unless your network administrator instructs you to do so with additional information.
Shared Secret	Enter a password (up to 127 alphanumeric characters) as the key to be shared between the external authentication server and the EMG2926-Q10A. The key must be the same on the external authentication server and your EMG2926-Q10A. The key is not sent over the network.
Session Timeout	The EMG2926-Q10A automatically disconnects a wireless client from the wireless and wired networks after a period of inactivity. The wireless client needs to send the username and password again before it can use the wireless and wired networks again. Some wireless clients may prompt users for a username and password; other clients may use saved login credentials. In either case, there is usually a short delay while the wireless client logs in to the wireless network again. Enter the time in seconds from 0 to 999999.
Apply	Click Apply to save your changes back to the EMG2926-Q10A.
Cancel	Click Cancel to reload the previous configuration for this screen.

11.4 More AP Screen

This screen allows you to enable and configure multiple wireless networks and guest wireless network settings on the EMG2926-Q10A.

You can configure up to four SSIDs to enable multiple BSSs (Basic Service Sets) on the EMG2926-Q10A. This allows you to use one access point to provide several BSSs simultaneously. You can then assign varying security types to different SSIDs. Wireless clients can use different SSIDs to associate with the same access point.

Click **Network > Wireless LAN 2.4G/5G > More AP**. The following screen displays.

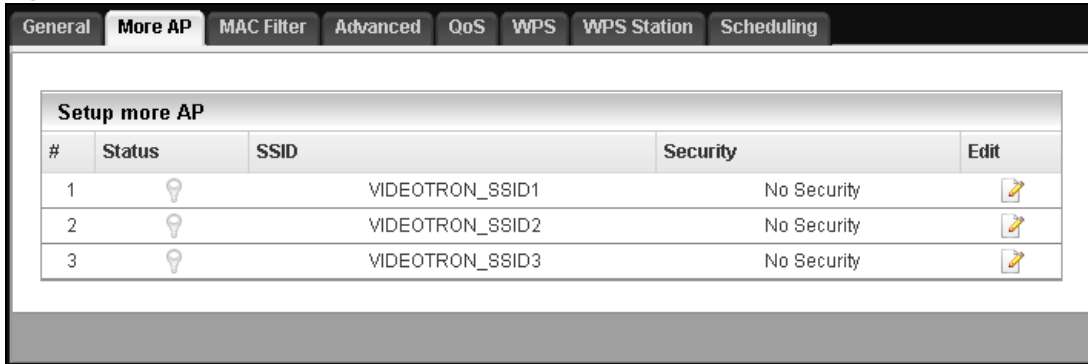
Figure 62 Network > Wireless LAN 2.4G/5G > More AP

The following table describes the labels in this screen.

Table 36 Network > Wireless LAN 2.4G/5G > More AP

LABEL	DESCRIPTION
#	This is the index number of each SSID profile.
Status	This shows whether the SSID profile is active (a yellow bulb) or not (a gray bulb).
SSID	An SSID profile is the set of parameters relating to one of the EMG2926-Q10A's BSSs. The SSID (Service Set Identifier) identifies the Service Set with which a wireless device is associated. This field displays the name of the wireless profile on the network. When a wireless client scans for an AP to associate with, this is the name that is broadcast and seen in the wireless client utility.
Security	This field indicates the security mode of the SSID profile.
Edit	Click the Edit icon to configure the SSID profile.

11.4.1 More AP Edit

Use this screen to edit an SSID profile. Click the **Edit** icon next to an SSID in the **More AP** screen. The following screen displays.

Figure 63 Network > Wireless LAN 2.4G/5G > More AP: Edit

Figure 64 Network > Wireless LAN 2.4G/5G > More AP: Edit (the last SSID)

Wireless Setup

Active :

Name (SSID) :

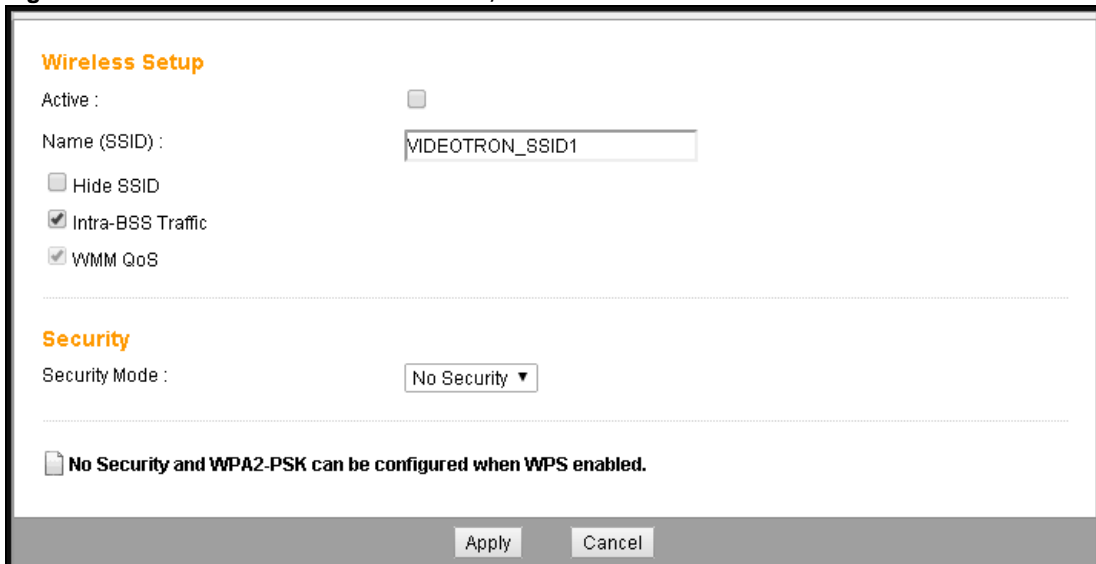
Hide SSID

Intra-BSS Traffic

WMM QoS

Enable Guest WLAN

IP Address :

IP Subnet Mask :

Enable Bandwidth Management for Guest WLAN

Maximum Bandwidth (kbps)

Security

Security Mode :

No Security and WPA2-PSK can be configured when WPS enabled.

The following table describes the labels in this screen.

Table 37 Network > Wireless LAN 2.4G/5G > More AP: Edit

LABEL	DESCRIPTION
Active	Select this to activate the SSID profile.
Name (SSID)	The SSID (Service Set IDentity) identifies the Service Set with which a wireless client is associated. Enter a descriptive name (up to 32 printable characters found on a typical English language keyboard) for the wireless LAN.
Hide SSID	Select this check box to hide the SSID in the outgoing beacon frame so a station cannot obtain the SSID through scanning using a site survey tool.
Intra-BSS Traffic	A Basic Service Set (BSS) exists when all communications between wireless clients or between a wireless client and a wired network client go through one access point (AP). Intra-BSS traffic is traffic between wireless clients in the BSS. When Intra-BSS is enabled, wireless clients can access the wired network and communicate with each other. When Intra-BSS is disabled, wireless clients can still access the wired network but cannot communicate with each other.
WMM QoS	Check this to have the EMG2926-Q10A automatically give a service a priority level according to the ToS value in the IP header of packets it sends. WMM QoS (Wifi MultiMedia Quality of Service) gives high priority to voice and video, which makes them run more smoothly.
Enable Guest WLAN	Select the check box to activate guest wireless LAN. This is available only for the last SSID on the EMG2926-Q10A. Note: Only Router mode supports guest WLAN. AP mode, Universal Repeater mode, WISP mode and WISP + Universal Repeater mode don't support guest WLAN.
IP Address	Type an IP address for the devices on the Guest WLAN using this as the gateway IP address.

Table 37 Network > Wireless LAN 2.4G/5G > More AP: Edit (continued)

LABEL	DESCRIPTION
IP Subnet Mask	Type the subnet mask for the guest wireless LAN.
Enable Bandwidth Management for Guest WLAN	Select this to turn on bandwidth management for the Guest WLAN network.
Maximum Bandwidth	Enter a number to specify maximum bandwidth the Guest WLAN network can use.
Security Mode	Select Static WEP , WPA-PSK , WPA , WPA2-PSK or WPA2 to add security on this wireless network. The wireless clients which want to associate to this network must have same wireless security settings as this device. After you select to use a security, additional options appears in this screen. See Section 11.3 on page 93 for detailed information on different security modes. Or you can select No Security to allow any client to associate this network without authentication. Note: If the WPS function is enabled (default), only No Security and WPA2-PSK are available in this field.
Apply	Click Apply to save your changes back to the EMG2926-Q10A.
Cancel	Click Cancel to reload the previous configuration for this screen.

11.5 MAC Filter Screen

The MAC filter screen allows you to configure the EMG2926-Q10A to give exclusive access to devices (**Allow**) or exclude devices from accessing the EMG2926-Q10A (**Deny**). Every Ethernet device has a unique MAC (Media Access Control) address. The MAC address is assigned at the factory and consists of six pairs of hexadecimal characters, for example, 00:A0:C5:00:00:02. You need to know the MAC address of the devices to configure this screen.

To change your EMG2926-Q10A's MAC filter settings, click **Network > Wireless LAN 2.4G/5G > MAC Filter**. The screen appears as shown.

Figure 65 Network > Wireless LAN 2.4G/5G > MAC Filter

General More AP **MAC Filter** Advanced QoS WPS WPS Station Scheduling

SSID Select:

MAC Address Filter: Enable Disable

Filter Action: Allow Deny

MAC Filter Summary			
Set	MAC Address	Set	MAC Address
1	<input type="text" value="00:00:00:00:00:00"/>	17	<input type="text" value="00:00:00:00:00:00"/>
2	<input type="text" value="00:00:00:00:00:00"/>	18	<input type="text" value="00:00:00:00:00:00"/>
3	<input type="text" value="00:00:00:00:00:00"/>	19	<input type="text" value="00:00:00:00:00:00"/>
4	<input type="text" value="00:00:00:00:00:00"/>	20	<input type="text" value="00:00:00:00:00:00"/>
5	<input type="text" value="00:00:00:00:00:00"/>	21	<input type="text" value="00:00:00:00:00:00"/>
6	<input type="text" value="00:00:00:00:00:00"/>	22	<input type="text" value="00:00:00:00:00:00"/>
7	<input type="text" value="00:00:00:00:00:00"/>	23	<input type="text" value="00:00:00:00:00:00"/>
8	<input type="text" value="00:00:00:00:00:00"/>	24	<input type="text" value="00:00:00:00:00:00"/>
9	<input type="text" value="00:00:00:00:00:00"/>	25	<input type="text" value="00:00:00:00:00:00"/>
10	<input type="text" value="00:00:00:00:00:00"/>	26	<input type="text" value="00:00:00:00:00:00"/>
11	<input type="text" value="00:00:00:00:00:00"/>	27	<input type="text" value="00:00:00:00:00:00"/>
12	<input type="text" value="00:00:00:00:00:00"/>	28	<input type="text" value="00:00:00:00:00:00"/>
13	<input type="text" value="00:00:00:00:00:00"/>	29	<input type="text" value="00:00:00:00:00:00"/>
14	<input type="text" value="00:00:00:00:00:00"/>	30	<input type="text" value="00:00:00:00:00:00"/>
15	<input type="text" value="00:00:00:00:00:00"/>	31	<input type="text" value="00:00:00:00:00:00"/>
16	<input type="text" value="00:00:00:00:00:00"/>	32	<input type="text" value="00:00:00:00:00:00"/>

Apply Cancel

The following table describes the labels in this menu.

Table 38 Network > Wireless LAN 2.4G/5G > MAC Filter

LABEL	DESCRIPTION
SSID Select	Select the SSID for which you want to configure MAC filtering.
MAC Address Filter	Select to turn on (Enable) or off (Disable) MAC address filtering.
Filter Action	Define the filter action for the list of MAC addresses in the MAC Filter Summary table. Select Allow to permit access to the EMG2926-Q10A, MAC addresses not listed will be denied access to the EMG2926-Q10A. Select Deny to block access to the EMG2926-Q10A, MAC addresses not listed will be allowed to access the EMG2926-Q10A.
MAC Filter Summary	
Set	This is the index number of the MAC address.
MAC Address	Enter the MAC address of the wireless station that are allowed or denied access to the EMG2926-Q10A.
Apply	Click Apply to save your changes back to the EMG2926-Q10A.
Cancel	Click Cancel to reload the previous configuration for this screen.

11.6 Wireless LAN Advanced Screen

Use this screen to allow wireless advanced features, such as the output power, RTS/CTS Threshold settings.

Click **Network > Wireless LAN 2.4G/5G > Advanced**. The screen appears as shown.

Figure 66 Network > Wireless LAN 2.4G/5G > Advanced

Wireless Advanced Setup

RTS/CTS Threshold : (256 ~ 2346)

Fragmentation Threshold : (256 ~ 2346)

Intra-BSS Traffic : Enable Disable

Short Gating Interval : Enable Disable

Tx Power :

The following table describes the labels in this screen.

Table 39 Network > Wireless LAN 2.4G/5G > Advanced

LABEL	DESCRIPTION
RTS/CTS Threshold	Data with its frame size larger than this value will perform the RTS (Request To Send)/CTS (Clear To Send) handshake. This field is not configurable and the EMG2926-Q10A automatically changes to use the maximum value if you select 802.11n , 802.11an , 802.11gn , 802.11bgn or 802.11ac in the Wireless LAN 2.4G/5G > General screen.
Fragmentation Threshold	The threshold (number of bytes) for the fragmentation boundary for directed messages. It is the maximum data fragment size that can be sent. This field is not configurable and the EMG2926-Q10A automatically changes to use the maximum value if you select 802.11n , 802.11an , 802.11gn , 802.11bgn or 802.11ac in the Wireless LAN 2.4G/5G > General screen.
Intra-BSS Traffic	A Basic Service Set (BSS) exists when all communications between wireless clients or between a wireless client and a wired network client go through one access point (AP). Intra-BSS traffic is traffic between wireless clients in the BSS. When Intra-BSS is enabled, wireless clients can access the wired network and communicate with each other. When Intra-BSS is disabled, wireless clients can still access the wired network but cannot communicate with each other.
Short Guarding Interval	The guard interval is the gap introduced between data transmission from users in order to reduce interference. Reducing the interval increases data transfer rates but also increases interference. Increasing the interval reduces data transfer rates but also reduces interference. Select Enable to use the short guard interval. Otherwise, select Disable to use the long guard interval.
Tx Power	Set the output power of the EMG2926-Q10A in this field. If there is a high density of APs in an area, decrease the output power of the EMG2926-Q10A to reduce interference with other APs. Select one of the following 100% , 90% , 75% , 50% , 25% or 10% .
Apply	Click Apply to save your changes back to the EMG2926-Q10A.
Cancel	Click Cancel to reload the previous configuration for this screen.

11.7 Quality of Service (QoS) Screen

The QoS screen allows you to automatically give a service (such as VoIP and video) a priority level.

Click **Network > Wireless LAN 2.4G/5G > QoS**. The following screen appears.

Figure 67 Network > Wireless LAN 2.4G/5G > QoS

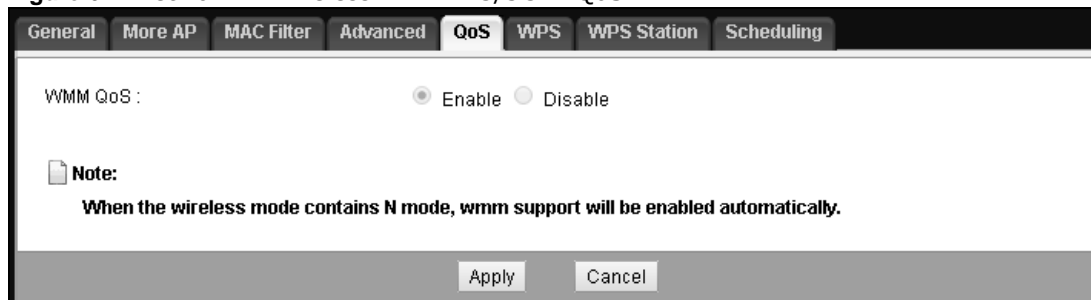

The following table describes the labels in this screen.

Table 40 Network > Wireless LAN 2.4G/5G > QoS

LABEL	DESCRIPTION
WMM QoS	Select Enable to have the EMG2926-Q10A automatically give a service a priority level according to the ToS value in the IP header of packets it sends. WMM QoS (Wifi MultiMedia Quality of Service) gives high priority to voice and video, which makes them run more smoothly. This field is not configurable and the EMG2926-Q10A automatically enables WMM QoS if you select 802.11n , 802.11an , 802.11gn , 802.11bgn or 802.11ac in the Wireless LAN 24G/5G > General screen.
Apply	Click Apply to save your changes to the EMG2926-Q10A.
Cancel	Click Cancel to reload the previous configuration for this screen.

11.8 WPS Screen

Use this screen to enable/disable WPS, view or generate a new PIN number and check current WPS status. To open this screen, click **Network > Wireless LAN 2.4G/5G > WPS**.

Note: With WPS, wireless clients can only connect to the wireless network using the first SSID on the EMG2926-Q10A.

Figure 68 Network > Wireless LAN 2.4G/5G > WPS

The following table describes the labels in this screen.

Table 41 Network > Wireless LAN 2.4G/5G > WPS

LABEL	DESCRIPTION
WPS Setup	
WPS	Select Enable to turn on the WPS feature. Otherwise, select Disable .
PIN Code	Select Enable and click Apply to allow the PIN Configuration method. If you select Disable , you cannot create a new PIN number.
PIN Number	This is the WPS PIN (Personal Identification Number) of the EMG2926-Q10A. Enter this PIN in the configuration utility of the device you want to connect to the EMG2926-Q10A using WPS. The PIN is not necessary when you use WPS push-button method. Click Generate to generate a new PIN number.
WPS Status	
Status	This displays Configured when the EMG2926-Q10A has connected to a wireless network using WPS or when WPS Enable is selected and wireless or wireless security settings have been changed. The current wireless and wireless security settings also appear in the screen. This displays Unconfigured if WPS is disabled and there are no wireless or wireless security changes on the EMG2926-Q10A or you click Release Configuration to remove the configured wireless and wireless security settings.
Release Configuration	This button is only available when the WPS status displays Configured . Click this button to remove all configured wireless and wireless security settings for WPS connections on the EMG2926-Q10A.
802.11 Mode	This is the 802.11 mode used. Only compliant WLAN devices can associate with the EMG2926-Q10A.
SSID	This is the name of the wireless network (the EMG2926-Q10A's first SSID).
Security	This is the type of wireless security employed by the network.

Table 41 Network > Wireless LAN 2.4G/5G > WPS (continued)

LABEL	DESCRIPTION
Apply	Click Apply to save your changes back to the EMG2926-Q10A.
Cancel	Click Cancel to reload the previous configuration for this screen.

11.9 WPS Station Screen

Use this screen when you want to add a wireless station using WPS. To open this screen, click **Network > Wireless LAN 2.4G/5G > WPS Station** tab.

Note: After you click **Push Button** on this screen, you have to press a similar button in the wireless station utility within 2 minutes. To add the second wireless station, you have to press these buttons on both device and the wireless station again after the first 2 minutes.

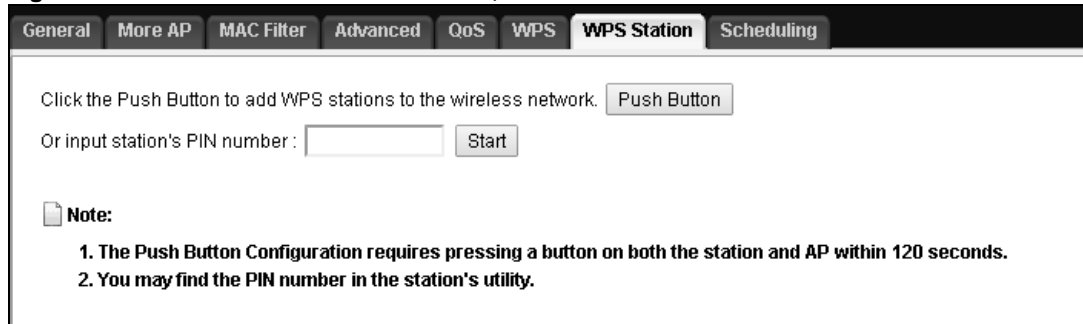
Figure 69 Network > Wireless LAN 2.4G/5G > WPS Station

The following table describes the labels in this screen.

Table 42 Network > Wireless LAN 2.4G/5G > WPS Station

LABEL	DESCRIPTION
Push Button	Use this button when you use the PBC (Push Button Configuration) method to configure wireless stations's wireless settings. Click this to start WPS-aware wireless station scanning and the wireless security information synchronization.
Or input station's PIN number	Use this button when you use the PIN Configuration method to configure wireless station's wireless settings. Type the same PIN number generated in the wireless station's utility. Then click Start to associate to each other and perform the wireless security information synchronization.

11.10 Scheduling Screen

Use this screen to set the times your wireless LAN is turned on and off. Wireless LAN scheduling is disabled by default. The wireless LAN can be scheduled to turn on or off on certain days and at certain times. To open this screen, click **Network > Wireless LAN 2.4G/5G > Scheduling** tab.

Figure 70 Network > Wireless LAN 2.4G/5G > Scheduling

Wireless LAN Scheduling : Enable Disable

Scheduling		
WLAN status	Day	For the following times (24-Hour Format)
<input type="radio"/> On <input checked="" type="radio"/> Off	<input type="checkbox"/> Everyday	00 (hour) 00 (min) ~ 00 (hour) 00 (min)
<input type="radio"/> On <input checked="" type="radio"/> Off	<input type="checkbox"/> Mon	00 (hour) 00 (min) ~ 00 (hour) 00 (min)
<input type="radio"/> On <input checked="" type="radio"/> Off	<input type="checkbox"/> Tue	00 (hour) 00 (min) ~ 00 (hour) 00 (min)
<input type="radio"/> On <input checked="" type="radio"/> Off	<input type="checkbox"/> Wed	00 (hour) 00 (min) ~ 00 (hour) 00 (min)
<input type="radio"/> On <input checked="" type="radio"/> Off	<input type="checkbox"/> Thu	00 (hour) 00 (min) ~ 00 (hour) 00 (min)
<input type="radio"/> On <input checked="" type="radio"/> Off	<input type="checkbox"/> Fri	00 (hour) 00 (min) ~ 00 (hour) 00 (min)
<input type="radio"/> On <input checked="" type="radio"/> Off	<input type="checkbox"/> Sat	00 (hour) 00 (min) ~ 00 (hour) 00 (min)
<input type="radio"/> On <input checked="" type="radio"/> Off	<input type="checkbox"/> Sun	00 (hour) 00 (min) ~ 00 (hour) 00 (min)

Note:
Specifying the same start time and end time means the whole day's schedule.

Apply Cancel

The following table describes the labels in this screen.

Table 43 Network > Wireless LAN 2.4G/5G > Scheduling

LABEL	DESCRIPTION
Wireless LAN Scheduling	
Wireless LAN Scheduling	Select Enable to activate the wireless LAN scheduling feature. Select Disable to turn it off.
Scheduling	
WLAN Status	Select On or Off to specify whether the Wireless LAN is turned on or off. This field works in conjunction with the Day and For the following times fields.
Day	Select Everyday or the specific days to turn the Wireless LAN on or off. If you select Everyday you can not select any specific days. This field works in conjunction with the For the following times field.
For the following times (24-Hour Format)	Select a begin time using the first set of hour and minute (min) drop down boxes and select an end time using the second set of hour and minute (min) drop down boxes. If you have chosen On earlier for the WLAN Status the Wireless LAN will turn on between the two times you enter in these fields. If you have chosen Off earlier for the WLAN Status the Wireless LAN will turn off between the two times you enter in these fields.
Apply	Click Apply to save your changes back to the EMG2926-Q10A.
Cancel	Click Cancel to reload the previous configuration for this screen.

12.1 Overview

This chapter describes how to configure LAN settings.

A Local Area Network (LAN) is a shared communication system to which many computers are attached. A LAN is a computer network limited to the immediate area, usually the same building or floor of a building.

Figure 71 LAN Example

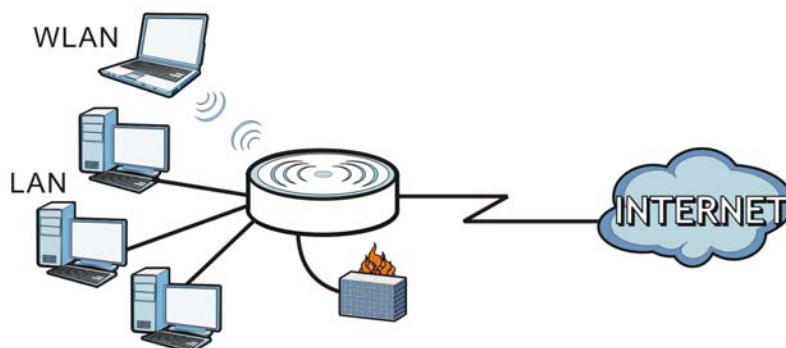

The LAN screens can help you configure a manage IP address, and partition your physical network into logical networks.

12.2 What You Can Do

- Use the **IP** screen to change the **IPv4 address** for your EMG2926-Q10A ([Section 12.4 on page 110](#)).
- Use the **IP Alias** screen to have the EMG2926-Q10A apply IP alias to create LAN subnets ([Section 12.5 on page 111](#)).
- Use the **IPv6 LAN** screen to configure the **IPv6 address** for your EMG2926-Q10A on the LAN ([Section 12.6 on page 112](#)).

12.3 What You Need To Know

The actual physical connection determines whether the EMG2926-Q10A ports are LAN or WAN ports. There are two separate IP networks, one inside the LAN network and the other outside the WAN network as shown next.

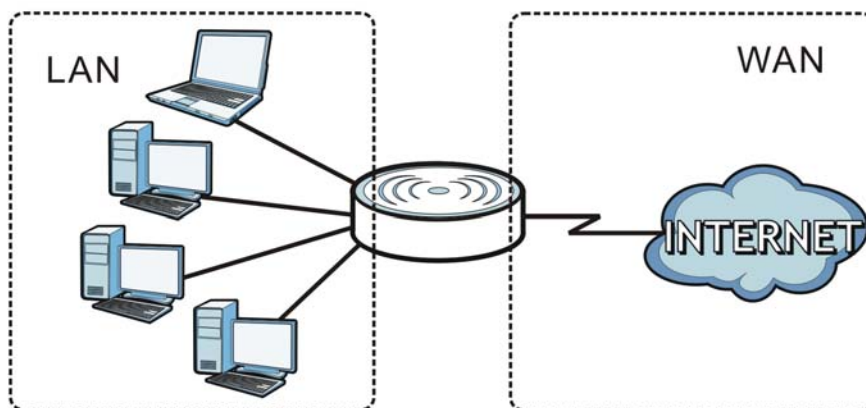
Figure 72 LAN and WAN IP Addresses

The LAN parameters of the EMG2926-Q10A in router mode are preset in the factory with the following values:

- IPv4 address of 192.168.0.1 with subnet mask of 255.255.255.0 (24 bits)
- DHCP server enabled with 32 client IP addresses starting from 192.168.0.33.

These parameters should work for the majority of installations. If your ISP gives you explicit DNS server address(es), read the embedded Web Configurator help regarding what fields need to be configured.

12.3.1 IP Alias

IP alias allows you to partition a physical network into different logical networks over the same Ethernet interface. The EMG2926-Q10A supports three logical LAN interfaces via its single physical Ethernet interface with the EMG2926-Q10A itself as the gateway for each LAN network.

12.4 LAN IP Screen

Use this screen to change the IPv4 address for your EMG2926-Q10A. Click **Network > LAN > IP**.

Figure 73 Network > LAN > IP

The following table describes the labels in this screen.

Table 44 Network > LAN > IP

LABEL	DESCRIPTION
IP Address	Type the IP address of your EMG2926-Q10A in dotted decimal notation.

Table 44 Network > LAN > IP (continued)

LABEL	DESCRIPTION
IP Subnet Mask	The subnet mask specifies the network number portion of an IP address. Your EMG2926-Q10A will automatically calculate the subnet mask based on the IP address that you assign. Unless you are implementing subnetting, use the subnet mask computed by the EMG2926-Q10A.
Apply	Click Apply to save your changes back to the EMG2926-Q10A.
Cancel	Click Cancel to begin configuring this screen afresh.

12.5 IP Alias Screen

Use this screen to have the EMG2926-Q10A apply IP alias to create LAN subnets. Click **LAN > IP Alias**.

Figure 74 Network > LAN > IP Alias

The following table describes the labels in this screen.

Table 45 Network > LAN > IP Alias

LABEL	DESCRIPTION
IP Alias 1, 2	Check this to enable IP alias to configure another LAN network for the EMG2926-Q10A.
IP Address	Type the IP alias address of your EMG2926-Q10A in dotted decimal notation.
IP Subnet Mask	The subnet mask specifies the network number portion of an IP address. Your EMG2926-Q10A will automatically calculate the subnet mask based on the IP address that you assign. Unless you are implementing subnetting, use the subnet mask computed by the EMG2926-Q10A.
Apply	Click Apply to save your changes back to the EMG2926-Q10A.
Cancel	Click Cancel to begin configuring this screen afresh.

12.6 IPv6 LAN Screen

Use this screen to configure the IPv6 address for your EMG2926-Q10A on the LAN. Click **Network > LAN > IPv6 LAN**.

Figure 75 Network > LAN > IPv6 LAN

The following table describes the labels in this screen.

Table 46 Network > LAN > IPv6 LAN

LABEL	DESCRIPTION
Enable DHCPv6-PD	Select this option to use DHCPv6 prefix delegation. The EMG2926-Q10A will obtain an IPv6 prefix from the ISP or a connected uplink router for the LAN.
Static IP Address	Select this option to manually enter an IPv6 address if you want to use a static IP address.
LAN IPv6 Address	Enter the IPv6 address for the EMG2926-Q10A on the LAN.
Apply	Click Apply to save your changes back to the EMG2926-Q10A.
Cancel	Click Cancel to begin configuring this screen afresh.

DHCP Server

13.1 Overview

DHCP (Dynamic Host Configuration Protocol, RFC 2131 and RFC 2132) allows individual clients to obtain TCP/IP configuration at start-up from a server. You can configure the EMG2926-Q10A's LAN as a DHCP server or disable it. When configured as a server, the EMG2926-Q10A provides the TCP/IP configuration for the clients. If DHCP service is disabled, you must have another DHCP server on your LAN, or else the computer must be manually configured.

13.1.1 What You Can Do

- Use the **General** screen to enable the DHCP server ([Section 13.2 on page 114](#)).
- Use the **Advanced** screen to assign IP addresses on the LAN to specific individual computers based on their MAC Addresses ([Section 13.3 on page 114](#)).
- Use the **Client List** screen to view the current DHCP client information ([Section 13.4 on page 116](#)).

13.1.2 What You Need To Know

The following terms and concepts may help as you read through this chapter.

LAN TCP/IP

The EMG2926-Q10A has built-in DHCP server capability that assigns IP addresses and DNS servers to systems that support DHCP client capability.

IP Pool Setup

The EMG2926-Q10A is pre-configured with a pool of **32 IP addresses starting from 192.168.0.33 to 192.168.0.64**. This configuration leaves 31 IP addresses (excluding the EMG2926-Q10A itself) in the lower range (**192.168.0.2 to 192.168.0.32**) for other server computers, for instance, servers for mail, FTP, TFTP, web, etc., that you may have.

MAC Addresses

Every Ethernet device has a unique MAC (Media Access Control) address. The MAC address is assigned at the factory and consists of six pairs of hexadecimal characters, for example, 00:A0:C5:00:00:02. Find out the MAC addresses of your network devices if you intend to add them to the **DHCP Client List** screen.

13.2 DHCP Server General Screen

Use this screen to enable the DHCP server. Click **Network > DHCP Server**. The following screen displays.

Figure 76 Network > DHCP Server > General

The following table describes the labels in this screen.

Table 47 Network > DHCP Server > General

LABEL	DESCRIPTION
DHCP Server	Select Enable to activate DHCP for LAN. DHCP (Dynamic Host Configuration Protocol, RFC 2131 and RFC 2132) allows individual clients (computers) to obtain TCP/IP configuration at startup from a server. Enable the DHCP server unless your ISP instructs you to do otherwise. Select Disable to stop the EMG2926-Q10A acting as a DHCP server. When configured as a server, the EMG2926-Q10A provides TCP/IP configuration for the clients. If not, DHCP service is disabled and you must have another DHCP server on your LAN, or else the computers must be manually configured. When set as a server, fill in the following four fields.
IP Pool Starting Address	This field specifies the first of the contiguous addresses in the IP address pool for LAN.
Pool Size	This field specifies the size, or count of the IP address pool for LAN.
Lease Time	Specify how long each computer can use the the IP address before it has to request the information again.
Apply	Click Apply to save your changes back to the EMG2926-Q10A.
Cancel	Click Cancel to begin configuring this screen afresh.

13.3 DHCP Server Advanced Screen

This screen allows you to assign IP addresses on the LAN to specific individual computers based on their MAC addresses. You can also use this screen to configure the DNS server information that the EMG2926-Q10A sends to the DHCP clients.

To change your EMG2926-Q10A's static DHCP settings, click **Network > DHCP Server > Advanced**. The following screen displays.

Figure 77 Network > DHCP Server > Advanced

General **Advanced** Client List

Static DHCP Table

#	MAC Address	IP Address
1	00:00:00:00:00:00	0.0.0.0
2	00:00:00:00:00:00	0.0.0.0
3	00:00:00:00:00:00	0.0.0.0
4	00:00:00:00:00:00	0.0.0.0
5	00:00:00:00:00:00	0.0.0.0
6	00:00:00:00:00:00	0.0.0.0
7	00:00:00:00:00:00	0.0.0.0
8	00:00:00:00:00:00	0.0.0.0

DNS Server

DNS Servers Assigned by DHCP Server

First DNS Server :

Second DNS Server :

Third DNS Server :

The following table describes the labels in this screen.

Table 48 Network > DHCP Server > Advanced

LABEL	DESCRIPTION
Static DHCP Table	
#	This is the index number of the static IP table entry (row).
MAC Address	Type the MAC address (with colons) of a computer on your LAN.
IP Address	Type the LAN IP address of a computer on your LAN.
DNS Server	
DNS Servers Assigned by DHCP Server	The EMG2926-Q10A passes a DNS (Domain Name System) server IP address (in the order you specify here) to the DHCP clients. The EMG2926-Q10A only passes this information to the LAN DHCP clients when you enable DHCP Server . When you disable DHCP Server , DHCP service is disabled and you must have another DHCP sever on your LAN, or else the computers must have their DNS server addresses manually configured.

Table 48 Network > DHCP Server > Advanced (continued)

LABEL	DESCRIPTION
First DNS Server Second DNS Server Third DNS Server	Select Obtained From ISP if your ISP dynamically assigns DNS server information (and the EMG2926-Q10A's WAN IP address). The field to the right displays the (read-only) DNS server IP address that the ISP assigns. Select User-Defined if you have the IP address of a DNS server. Enter the DNS server's IP address in the field to the right. If you chose User-Defined , but leave the IP address set to 0.0.0.0, User-Defined changes to None after you click Apply . If you set a second choice to User-Defined , and enter the same IP address, the second User-Defined changes to None after you click Apply . Select DNS Relay to have the EMG2926-Q10A act as a DNS proxy. The EMG2926-Q10A's LAN IP address displays in the field to the right (read-only). The EMG2926-Q10A tells the DHCP clients on the LAN that the EMG2926-Q10A itself is the DNS server. When a computer on the LAN sends a DNS query to the EMG2926-Q10A, the EMG2926-Q10A forwards the query to the EMG2926-Q10A's system DNS server (configured in the WAN > Internet Connection screen) and relays the response back to the computer. You can only select DNS Relay for one of the three servers; if you select DNS Relay for a second or third DNS server, that choice changes to None after you click Apply . Select None if you do not want to configure DNS servers. If you do not configure a DNS server, you must know the IP address of a computer in order to access it.
Apply	Click Apply to save your changes back to the EMG2926-Q10A.
Cancel	Click Cancel to begin configuring this screen afresh.

13.4 DHCP Client List Screen

The DHCP table shows current DHCP client information (including IP Address, Host Name and MAC Address) of network clients using the EMG2926-Q10A's DHCP servers.

Configure this screen to always assign an IP address to a MAC address (and host name). Click **Network > DHCP Server > Client List**.

Note: You can also view a read-only client list by clicking **Monitor > DHCP Server**.

Figure 78 Network > DHCP Server > Client List

DHCP Client Table					
#	Status	Host Name	IP Address	MAC Address	Reserve
1		twpcMT	192.168.0.45	00:19:cb:32:be:ac	<input type="checkbox"/>

The following table describes the labels in this screen.

Table 49 Network > DHCP Server > Client List

LABEL	DESCRIPTION
#	This is the index number of the host computer.
Status	This field displays whether the connection to the host computer is up (a yellow bulb) or down (a gray bulb).

Table 49 Network > DHCP Server > Client List (continued)

LABEL	DESCRIPTION
Host Name	This field displays the computer host name.
IP Address	This field displays the IP address relative to the # field listed above.
MAC Address	This field shows the MAC address of the computer with the name in the Host Name field. Every Ethernet device has a unique MAC (Media Access Control) address which uniquely identifies a device. The MAC address is assigned at the factory and consists of six pairs of hexadecimal characters, for example, 00:A0:C5:00:00:02.
Reserve	Select this if you want to reserve the IP address for this specific MAC address.
Apply	Click Apply to save your changes back to the EMG2926-Q10A.
Cancel	Click Cancel to reload the previous configuration for this screen.

14.1 Overview

NAT (Network Address Translation - NAT, RFC 1631) is the translation of the IP address of a host in a packet. For example, the source address of an outgoing packet, used within one network is changed to a different IP address known within another network.

The figure below is a simple illustration of a NAT network. You want to assign ports 21-25 to one FTP, Telnet and SMTP server (**A** in the example), port 80 to another (**B** in the example) and assign a default server IP address of 192.168.0.35 to a third (**C** in the example).

You assign the LAN IP addresses to the devices (**A** to **D**) connected to your EMG2926-Q10A. The ISP assigns the WAN IP address. The NAT network appears as a single host on the Internet. All traffic coming from **A** to **D** going out to the Internet use the IP address of the EMG2926-Q10A, which is 192.168.0.1.

Figure 79 NAT Example

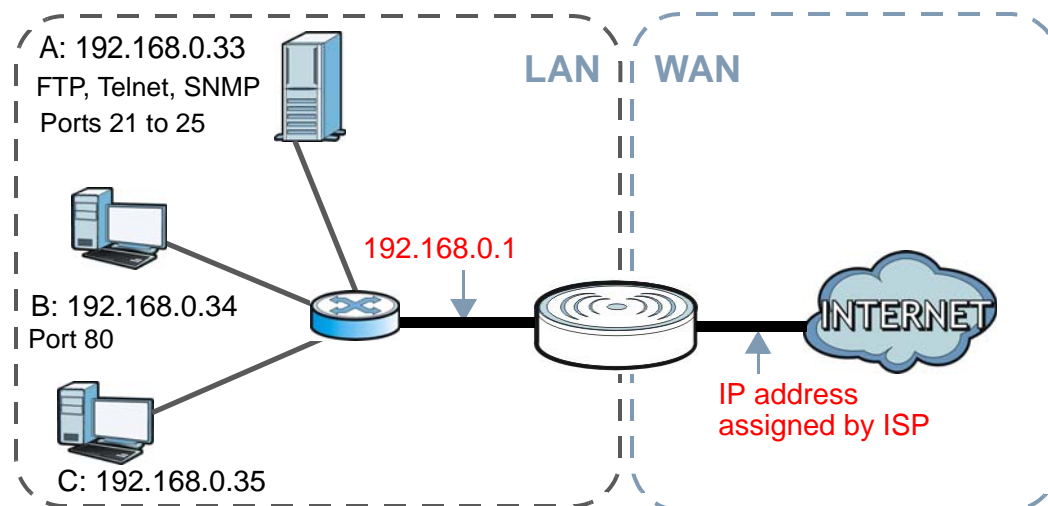

This chapter discusses how to configure NAT on the EMG2926-Q10A.

Note: You must create a firewall rule in addition to setting up NAT, to allow traffic from the WAN to be forwarded through the EMG2926-Q10A.

14.1.1 What You Can Do

- Use the **General** screen to enable NAT ([Section 14.2 on page 120](#)).

- Use the **Port Forwarding** screen to set a default server and change your EMG2926-Q10A's port forwarding settings to forward incoming service requests to the server(s) on your local network ([Section 14.3 on page 121](#)).
- Use the **Port Trigger** screen to change your EMG2926-Q10A's trigger port settings ([Section 14.5.3 on page 127](#)).

14.1.2 What You Need To Know

The following terms and concepts may help as you read through this chapter.

Inside/Outside

This denotes where a host is located relative to the EMG2926-Q10A, for example, the computers of your subscribers are the inside hosts, while the web servers on the Internet are the outside hosts.

Global/Local

This denotes the IP address of a host in a packet as the packet traverses a router, for example, the local address refers to the IP address of a host when the packet is in the local network, while the global address refers to the IP address of the host when the same packet is traveling in the WAN side.

Note: Inside/outside refers to the location of a host, while global/local refers to the IP address of a host used in a packet.

An inside local address (ILA) is the IP address of an inside host in a packet when the packet is still in the local network, while an inside global address (IGA) is the IP address of the same inside host when the packet is on the WAN side. The following table summarizes this information.

Table 50 NAT Definitions

ITEM	DESCRIPTION
Inside	This refers to the host on the LAN.
Outside	This refers to the host on the WAN.
Local	This refers to the packet address (source or destination) as the packet travels on the LAN.
Global	This refers to the packet address (source or destination) as the packet travels on the WAN.

Note: NAT never changes the IP address (either local or global) of an outside host.

What NAT Does

In the simplest form, NAT changes the source IP address in a packet received from a subscriber (the inside local address) to another (the inside global address) before forwarding the packet to the WAN side. When the response comes back, NAT translates the destination address (the inside global address) back to the inside local address before forwarding it to the original inside host. Note that the IP address (either local or global) of an outside host is never changed.

The global IP addresses for the inside hosts can be either static or dynamically assigned by the ISP. In addition, you can designate servers, for example, a web server and a telnet server, on your local

network and make them accessible to the outside world. If you do not define any servers, NAT offers the additional benefit of firewall protection. With no servers defined, your EMG2926-Q10A filters out all incoming inquiries, thus preventing intruders from probing your network. For more information on IP address translation, refer to *RFC 1631, The IP Network Address Translator (NAT)*.

How NAT Works

Each packet has two addresses – a source address and a destination address. For outgoing packets, the ILA (Inside Local Address) is the source address on the LAN, and the IGA (Inside Global Address) is the source address on the WAN. For incoming packets, the ILA is the destination address on the LAN, and the IGA is the destination address on the WAN. NAT maps private (local) IP addresses to globally unique ones required for communication with hosts on other networks. It replaces the original IP source address in each packet and then forwards it to the Internet. The EMG2926-Q10A keeps track of the original addresses and port numbers so incoming reply packets can have their original values restored. The following figure illustrates this.

Figure 80 How NAT Works

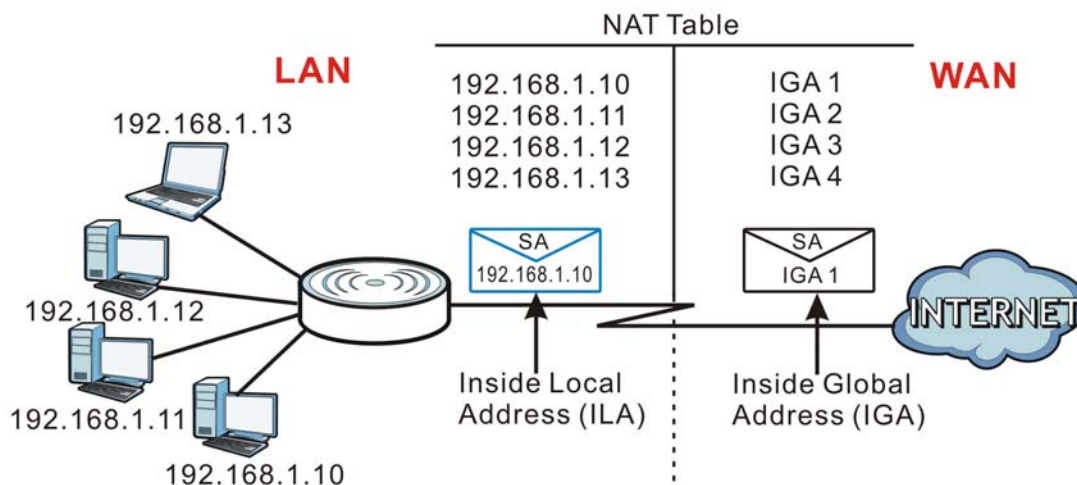

14.2 NAT General Screen

Use this screen to enable NAT and set a default server. Click **Network > NAT** to open the **General** screen.

Figure 81 Network > NAT > General

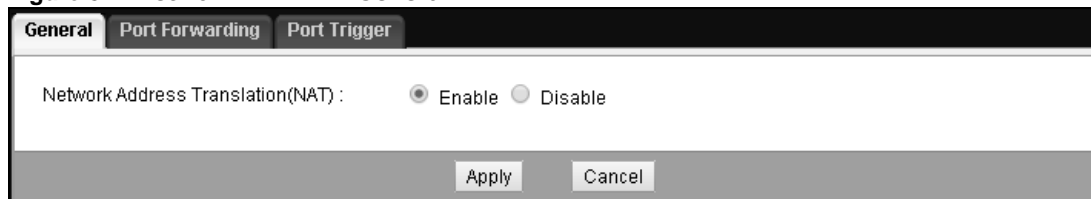

The following table describes the labels in this screen.

Table 51 Network > NAT > General

LABEL	DESCRIPTION
Network Address Translation (NAT)	Network Address Translation (NAT) allows the translation of an Internet protocol address used within one network (for example a private IP address used in a local network) to a different IP address known within another network (for example a public IP address used on the Internet). Select Enable to activate NAT. Select Disable to turn it off.
Apply	Click Apply to save your changes back to the EMG2926-Q10A.
Cancel	Click Cancel to begin configuring this screen afresh.

14.3 Port Forwarding Screen

Use this screen to forward incoming service requests to the server(s) on your local network and set a default server. You may enter a single port number or a range of port numbers to be forwarded, and the local IP address of the desired server. The port number identifies a service; for example, web service is on port 80 and FTP on port 21. In some cases, such as for unknown services or where one server can support more than one service (for example both FTP and web service), it might be better to specify a range of port numbers.

In addition to the servers for specified services, NAT supports a default server. A service request that does not have a server explicitly designated for it is forwarded to the default server. If the default is not defined, the service request is simply discarded.

Note: Many residential broadband ISP accounts do not allow you to run any server processes (such as a Web or FTP server) from your location. Your ISP may periodically check for servers and may suspend your account if it discovers any active services at your location. If you are unsure, refer to your ISP.

Port forwarding allows you to define the local servers to which the incoming services will be forwarded. To change your EMG2926-Q10A's port forwarding settings, click **Network > NAT > Port Forwarding**. The screen appears as shown.

Note: If you do not assign a **Default Server**, the EMG2926-Q10A discards all packets received for ports that are not specified in this screen or remote management.

Refer to [Appendix C on page 221](#) for port numbers commonly used for particular services.

Figure 82 Network > NAT > Port Forwarding

Default Server Setup

Default Server : 192.168.0.1
 Change To Server :

Note:
DMZ always uses default WAN.

Service Name :
 Service Protocol :
 Port Range : -
 Translation Port Range : -
 Server IP Address :

#	Status	Name	Protocol	WAN Interface	Port	Translation Port	Server IP Address	Modify
1		SIP	TCP_UDP	WAN	5060	5060	192.168.0.55	

The following table describes the labels in this screen.

Table 52 Network > NAT > Port Forwarding

LABEL	DESCRIPTION
Default Server Setup	
Default Server	In addition to the servers for specified services, NAT supports a default server. A default server receives packets from ports that are not specified in the Port Forwarding screen. You can decide whether you want to use the default server or specify a server manually. Select this to use the default server.
Change to Server	Select this and manually enter the server's IP address.
Service Name	Select a pre-defined service in the second field next to Service Name . The pre-defined service port number(s) and protocol will be displayed in the port forwarding summary table. Otherwise, select User define and type a name (of up to 31 printable characters) to identify this rule in the first field next to Service Name . You need to manually enter the port number(s) and select the IP protocol.
Service Protocol	Select the transport layer protocol supported by this virtual server. Choices are TCP , UDP , or TCP_UDP . If you have chosen a pre-defined service in the Service Name field, the protocol will be configured automatically this field is not available.
Port Range	Type the first and last internal port number that identifies a service.
Translation Port Range	Type the first and last external port number that identifies a service.

Table 52 Network > NAT > Port Forwarding (continued)

LABEL	DESCRIPTION
Server IP Address	Select a DHCP client as the virtual server and click Add to add it in the port forwarding summary table. Otherwise, select Custom and manually enter the inside IP address of the virtual server here.
#	This is the number of an individual port forwarding server entry.
Status	This icon is turned on when the rule is enabled.
Name	This field displays a name to identify this rule.
Protocol	This is the transport layer protocol used for the service.
WAN Interface	This is the WAN interface of the rule.
Port	This is the internal port number(s) that identifies the service.
Translation Port Range	This is the external port number(s) that identifies the service.
Server IP Address	This field displays the inside IP address of the server.
Modify	Click the Edit icon to open the edit screen where you can modify an existing rule. Click the Delete icon to remove a rule.
Apply	Click Apply to save your changes back to the EMG2926-Q10A.
Cancel	Click Cancel to begin configuring this screen afresh.

14.3.1 Port Forwarding Edit Screen

This screen lets you edit a port forwarding rule. Click a rule's **Edit** icon in the **Port Forwarding** screen to open the following screen.

Figure 83 Network > NAT > Port Forwarding Edit

The screenshot shows the 'Port Forwarding Edit' configuration screen. It includes the following fields and controls:

- Port Forwarding :** Radio buttons for Enable and Disable.
- Service Name :** Text input field containing 'example' and a dropdown menu set to 'User define'.
- Protocol :** Dropdown menu set to 'TCP_UDP'.
- Port Range :** Two text input fields, both containing '66666', separated by a hyphen.
- Translation Port Range :** Two text input fields, both containing '66666', separated by a hyphen.
- Server IP Address :** A dropdown menu set to 'Custom' and a text input field containing '192.168.0.55'.

At the bottom of the screen are three buttons: **Back**, **Apply**, and **Cancel**.

The following table describes the labels in this screen.

Table 53 Network > NAT > Port Forwarding Edit

LABEL	DESCRIPTION
Port Forwarding	<p>Select Enable to turn on this rule and the requested service can be forwarded to the host with a specified internal IP address.</p> <p>Select Disable to disallow forwarding of these ports to an inside server without having to delete the entry.</p>
Service Name	<p>Type a name (of up to 31 printable characters) to identify this rule in the first field next to Service Name. Otherwise, select a predefined service in the second field next to Service Name. The predefined service name and port number(s) will display in the Service Name and Port fields.</p>
Protocol	<p>Select the transport layer protocol supported by this virtual server. Choices are TCP, UDP, or TCP_UDP.</p> <p>If you have chosen a pre-defined service in the Service Name field, the protocol will be configured automatically.</p>
Port Range	<p>Type an internal port number(s) to define the service to be forwarded to the specified server.</p> <p>To specify a range of ports, enter a hyphen (-) between the first port and the last port, such as 10-.</p>
Translation Port Range	<p>Type the first and last external port number that identifies a service.</p>
Server IP Address	<p>Type the IP address of the server on your LAN that receives packets from the port(s) specified in the Port field.</p>
Back	<p>Click Back to return to the previous screen.</p>
Apply	<p>Click Apply to save your changes back to the EMG2926-Q10A.</p>
Cancel	<p>Click Cancel to begin configuring this screen afresh.</p>

14.4 Port Trigger Screen

To change your EMG2926-Q10A's trigger port settings, click **Network > NAT > Port Trigger**. The screen appears as shown.

Note: Only one LAN computer can use a trigger port (range) at a time.

Figure 84 Network > NAT > Port Trigger

Port Trigger Rules					
#	Name	incoming		trigger	
		Port	End Port	Port	End Port
1		0	0	0	0
2		0	0	0	0
3		0	0	0	0
4		0	0	0	0
5		0	0	0	0
6		0	0	0	0
7		0	0	0	0
8		0	0	0	0
9		0	0	0	0
10		0	0	0	0
11		0	0	0	0
12		0	0	0	0

The following table describes the labels in this screen.

Table 54 Network > NAT > Port Trigger

LABEL	DESCRIPTION
#	This is the rule index number (read-only).
Name	Type a unique name (up to 15 characters) for identification purposes. All characters are permitted - including spaces.
Incoming	Incoming is a port (or a range of ports) that a server on the WAN uses when it sends out a particular service. The EMG2926-Q10A forwards the traffic with this port (or range of ports) to the client computer on the LAN that requested the service.
Port	Type a port number or the starting port number in a range of port numbers.
End Port	Type a port number or the ending port number in a range of port numbers.
Trigger	The trigger port is a port (or a range of ports) that causes (or triggers) the EMG2926-Q10A to record the IP address of the LAN computer that sent the traffic to a server on the WAN.
Port	Type a port number or the starting port number in a range of port numbers.
End Port	Type a port number or the ending port number in a range of port numbers.

Table 54 Network > NAT > Port Trigger (continued)

LABEL	DESCRIPTION
Apply	Click Apply to save your changes back to the EMG2926-Q10A.
Cancel	Click Cancel to begin configuring this screen afresh.

14.5 Technical Reference

The following section contains additional technical information about the EMG2926-Q10A features described in this chapter.

14.5.1 NATPort Forwarding: Services and Port Numbers

A port forwarding set is a list of inside (behind NAT on the LAN) servers, for example, web or FTP, that you can make accessible to the outside world even though NAT makes your whole inside network appear as a single machine to the outside world.

Use the **Port Forwarding** screen to forward incoming service requests to the server(s) on your local network. You may enter a single port number or a range of port numbers to be forwarded, and the local IP address of the desired server. The port number identifies a service; for example, web service is on port 80 and FTP on port 21. In some cases, such as for unknown services or where one server can support more than one service (for example both FTP and web service), it might be better to specify a range of port numbers.

In addition to the servers for specified services, NAT supports a default server. A service request that does not have a server explicitly designated for it is forwarded to the default server. If the default is not defined, the service request is simply discarded.

Note: Many residential broadband ISP accounts do not allow you to run any server processes (such as a Web or FTP server) from your location. Your ISP may periodically check for servers and may suspend your account if it discovers any active services at your location. If you are unsure, refer to your ISP.

14.5.2 NAT Port Forwarding Example

Let's say you want to assign ports 21-25 to one FTP, Telnet and SMTP server (**A** in the example), port 80 to another (**B** in the example) and assign a default server **IP address of 192.168.0.35** to a third (**C** in the example). You assign the LAN IP addresses and the ISP assigns the WAN IP address. The NAT network appears as a single host on the Internet.

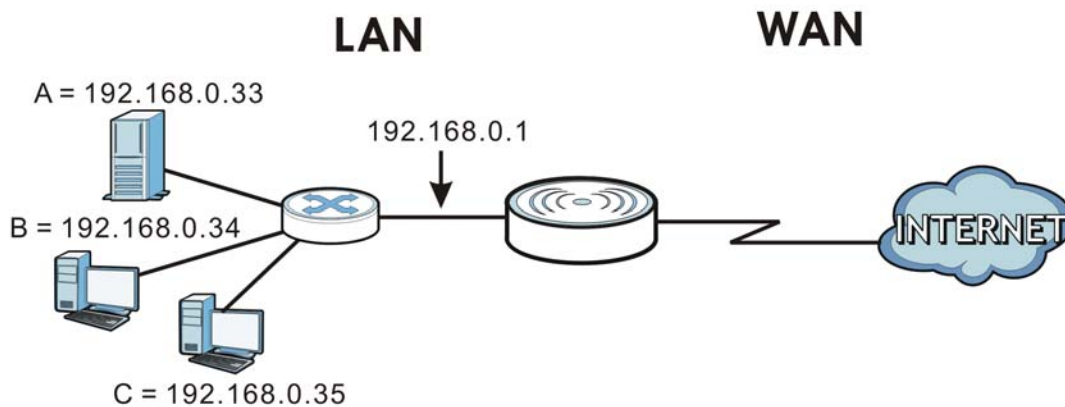
Figure 85 Multiple Servers Behind NAT Example

14.5.3 Trigger Port Forwarding

Some services use a dedicated range of ports on the client side and a dedicated range of ports on the server side. With regular port forwarding you set a forwarding port in NAT to forward a service (coming in from the server on the WAN) to the IP address of a computer on the client side (LAN). The problem is that port forwarding only forwards a service to a single LAN IP address. In order to use the same service on a different LAN computer, you have to manually replace the LAN computer's IP address in the forwarding port with another LAN computer's IP address.

Trigger port forwarding solves this problem by allowing computers on the LAN to dynamically take turns using the service. The EMG2926-Q10A records the IP address of a LAN computer that sends traffic to the WAN to request a service with a specific port number and protocol (a "trigger" port). When the EMG2926-Q10A's WAN port receives a response with a specific port number and protocol ("incoming" port), the EMG2926-Q10A forwards the traffic to the LAN IP address of the computer that sent the request. After that computer's connection for that service closes, another computer on the LAN can use the service in the same manner. This way you do not need to configure a new IP address each time you want a different LAN computer to use the application.

14.5.4 Trigger Port Forwarding Example

The following is an example of trigger port forwarding.

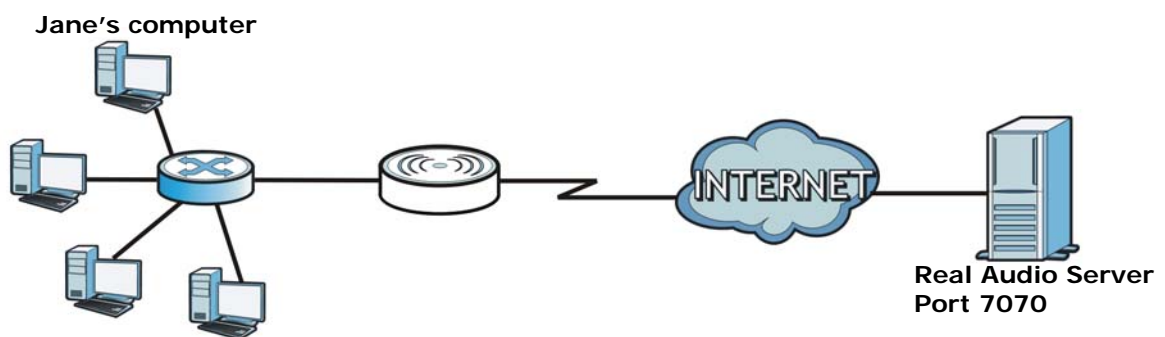
Figure 86 Trigger Port Forwarding Process: Example

- 1 Jane requests a file from the Real Audio server (port 7070).

- 2 Port 7070 is a “trigger” port and causes the EMG2926-Q10A to record Jane’s computer IP address. The EMG2926-Q10A associates Jane's computer IP address with the "incoming" port range of 6970-7170.
- 3 The Real Audio server responds using a port number ranging between 6970-7170.
- 4 The EMG2926-Q10A forwards the traffic to Jane’s computer IP address.
- 5 Only Jane can connect to the Real Audio server until the connection is closed or times out. The EMG2926-Q10A times out in three minutes with UDP (User Datagram Protocol), or two hours with TCP/IP (Transfer Control Protocol/Internet Protocol).

14.5.5 Two Points To Remember About Trigger Ports

- 1 Trigger events only happen on data that is coming from inside the EMG2926-Q10A and going to the outside.
- 2 If an application needs a continuous data stream, that port (range) will be tied up so that another computer on the LAN can’t trigger it.

15.1 Overview

DDNS services let you use a domain name with a dynamic IP address.

15.1.1 What You Need To Know

The following terms and concepts may help as you read through this chapter.

What is DDNS?

Dynamic Domain Name Service (DDNS) services let you use a fixed domain name with a dynamic IP address. Users can always use the same domain name instead of a different dynamic IP address that changes each time to connect to the EMG2926-Q10A or a server in your network.

Note: The EMG2926-Q10A must have a public global IP address and you should have your registered DDNS account information on hand.

15.2 General

To change your EMG2926-Q10A's DDNS, click **Network > DDNS**. The screen appears as shown.

Figure 87 Dynamic DNS



The screenshot shows a window titled "Dynamic DNS" with a sub-header "Dynamic DNS Setup". It contains the following fields and controls:

- Dynamic DNS :** Radio buttons for Enable and Disable.
- Service Provider :** A dropdown menu with "www.DynDNS.org" selected.
- Host Name :** An empty text input field.
- Username :** An empty text input field.
- Password :** An empty text input field.

At the bottom of the window are two buttons: "Apply" and "Cancel".

The following table describes the labels in this screen.

Table 55 Dynamic DNS

LABEL	DESCRIPTION
Dynamic DNS	Select Enable to use dynamic DNS. Select Disable to turn this feature off.
Service Provider	Select the name of your Dynamic DNS service provider.
Host Name	Enter a host names in the field provided. You can specify up to two host names in the field separated by a comma (",").
Username	Enter your user name.
Password	Enter the password assigned to you.
Apply	Click Apply to save your changes back to the EMG2926-Q10A.
Cancel	Click Cancel to begin configuring this screen afresh.

Static Route

16.1 Overview

This chapter shows you how to configure static routes for your EMG2926-Q10A.

The EMG2926-Q10A usually uses the default gateway to route outbound traffic from computers on the LAN to the Internet. To have the EMG2926-Q10A send data to devices not reachable through the default gateway, use static routes.

For example, the next figure shows a computer (**A**) connected to the EMG2926-Q10A's LAN interface. The EMG2926-Q10A routes most traffic from **A** to the Internet through the EMG2926-Q10A's default gateway (**R1**). You create one static route to connect to services offered by your ISP behind router **R2**. You create another static route to communicate with a separate network behind a router **R3** connected to the LAN.

Figure 88 Example of Static Routing Topology

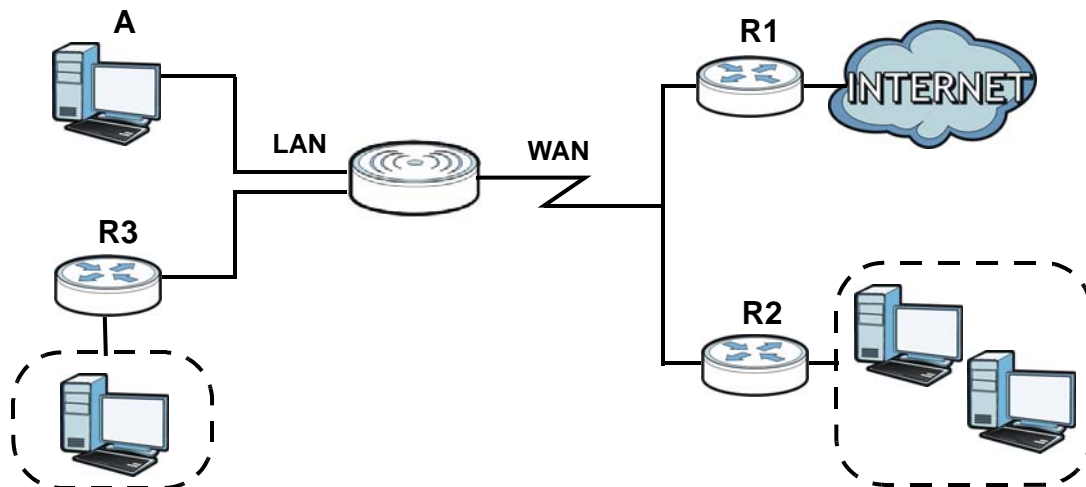

16.2 IP Static Route Screen

Click **Network > Static Route** to open the **Static Route** screen.

Figure 89 Network > Static Route

#	Status	Name	Destination	Gateway	Subnet Mask	Modify
---	--------	------	-------------	---------	-------------	--------

The following table describes the labels in this screen.

Table 56 Network > Static Route

LABEL	DESCRIPTION
Add Static Route	Click this to create a new rule.
#	This is the number of an individual static route.
Status	This field indicates whether the rule is active (yellow bulb) or not (gray bulb).
Name	This field displays a name to identify this rule.
Destination	This parameter specifies the IP network address of the final destination. Routing is always based on network number.
Gateway	This is the IP address of the gateway. The gateway is a router or switch on the same network segment as the device's LAN or WAN port. The gateway helps forward packets to their destinations.
Subnet Mask	This parameter specifies the IP network subnet mask of the final destination.
Modify	Click the Edit icon to open a screen where you can modify an existing rule. Click the Delete icon to remove a rule from the EMG2926-Q10A.
Apply	Click Apply to save your changes back to the EMG2926-Q10A.
Cancel	Click Cancel to begin configuring this screen afresh.

16.2.1 Add/Edit Static Route

Click the **Add Static Route** button or a rule's **Edit** icon in the **Static Route** screen. Use this screen to configure the required information for a static route.

Figure 90 Network > Static Route: Add/Edit

The following table describes the labels in this screen.

Table 57 Network > Static Route: Add/Edit

LABEL	DESCRIPTION
Static Route	Select to enable or disable this rule.
Route Name	Type a name to identify this rule. You can use up to printable English keyboard characters, including spaces.
Destination IP Address	This parameter specifies the IP network address of the final destination. Routing is always based on network number. If you need to specify a route to a single host, use a subnet mask of 255.255.255.255 in the subnet mask field to force the network number to be identical to the host ID.
IP Subnet Mask	Enter the IP subnet mask here.
Gateway IP Address	Enter the IP address of the next-hop gateway. The gateway is a router or switch on the same segment as your EMG2926-Q10A's interface(s). The gateway helps forward packets to their destinations.
Back	Click Back to return to the previous screen without saving.
Apply	Click Apply to save your changes back to the EMG2926-Q10A.
Cancel	Click Cancel to set every field in this screen to its last-saved value.

17.1 Overview

Use these screens to enable and configure the firewall that protects your EMG2926-Q10A and your LAN from unwanted or malicious traffic.

Enable the firewall to protect your LAN computers from attacks by hackers on the Internet and control access between the LAN and WAN. By default the firewall:

- allows traffic that originates from your LAN computers to go to all of the networks.
- blocks traffic that originates on the other networks from going to the LAN.

The following figure illustrates the default firewall action. User **A** can initiate an IM (Instant Messaging) session from the LAN to the WAN (1). Return traffic for this session is also allowed (2). However other traffic initiated from the WAN is blocked (3 and 4).

Figure 91 Default Firewall Action

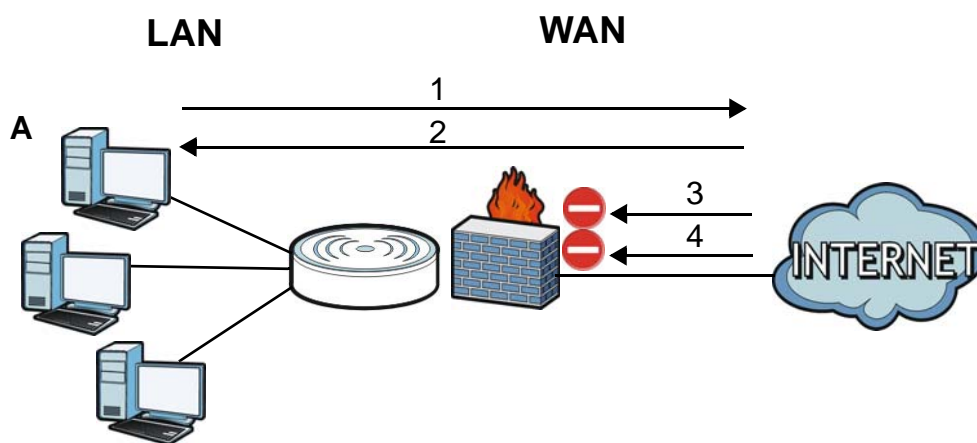

17.1.1 What You Can Do

- Use the **General** screen to enable or disable the EMG2926-Q10A's firewall ([Section 17.2 on page 136](#)).
- Use the **Services** screen to enable service blocking, enter/delete/modify the services you want to block and the date/time you want to block them ([Section 17.3 on page 136](#)).

17.1.2 What You Need To Know

The following terms and concepts may help as you read through this chapter.

What is a Firewall?

Originally, the term "firewall" referred to a construction technique designed to prevent the spread of fire from one room to another. The networking term "firewall" is a system or group of systems that enforces an access-control policy between two networks. It may also be defined as a mechanism used to protect a trusted network from a network that is not trusted. Of course, firewalls cannot solve every security problem. A firewall is one of the mechanisms used to establish a network security perimeter in support of a network security policy. It should never be the only mechanism or method employed. For a firewall to guard effectively, you must design and deploy it appropriately. This requires integrating the firewall into a broad information-security policy. In addition, specific policies must be implemented within the firewall itself.

Stateful Inspection Firewall

Stateful inspection firewalls restrict access by screening data packets against defined access rules. They make access control decisions based on IP address and protocol. They also "inspect" the session data to assure the integrity of the connection and to adapt to dynamic protocols. These firewalls generally provide the best speed and transparency; however, they may lack the granular application level access control or caching that some proxies support. Firewalls, of one type or another, have become an integral part of standard security solutions for enterprises.

About the EMG2926-Q10A Firewall

The EMG2926-Q10A's firewall feature physically separates the LAN and the WAN and acts as a secure gateway for all data passing between the networks.

It is a stateful inspection firewall and is designed to protect against Denial of Service attacks when activated (click the **General** tab under **Firewall** and then click the **Enable Firewall** check box). The EMG2926-Q10A's purpose is to allow a private Local Area Network (LAN) to be securely connected to the Internet. The EMG2926-Q10A can be used to prevent theft, destruction and modification of data, as well as log events, which may be important to the security of your network.

The EMG2926-Q10A is installed between the LAN and a broadband modem connecting to the Internet. This allows it to act as a secure gateway for all data passing between the Internet and the LAN.

The EMG2926-Q10A has one Ethernet WAN port and four Ethernet LAN ports, which are used to physically separate the network into two areas. The WAN (Wide Area Network) port attaches to the broadband (cable or DSL) modem to the Internet.

The LAN (Local Area Network) port attaches to a network of computers, which needs security from the outside world. These computers will have access to Internet services such as e-mail, FTP and the World Wide Web. However, "inbound access" is not allowed (by default) unless the remote host is authorized to use a specific service.

Guidelines For Enhancing Security With Your Firewall

- 1 Change the default password via Web Configurator.
- 2 Think about access control before you connect to the network in any way, including attaching a modem to the port.

- 3 Limit who can access your router.
- 4 Don't enable any local service (such as NTP) that you don't use. Any enabled service could present a potential security risk. A determined hacker might be able to find creative ways to misuse the enabled services to access the firewall or the network.
- 5 For local services that are enabled, protect against misuse. Protect by configuring the services to communicate only with specific peers, and protect by configuring rules to block packets for the services at specific interfaces.
- 6 Protect against IP spoofing by making sure the firewall is active.
- 7 Keep the firewall in a secured (locked) room.

17.2 General Screen

Use this screen to enable or disable the EMG2926-Q10A's firewall, and set up firewall logs. Click **Security > Firewall** to open the **General** screen.

Figure 92 Security > Firewall > General I

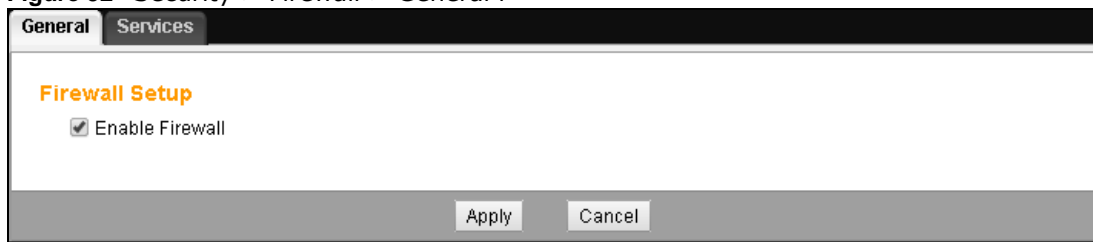

The following table describes the labels in this screen.

Table 58 Security > Firewall > General

LABEL	DESCRIPTION
Enable Firewall	Select this check box to activate the firewall. The EMG2926-Q10A performs access control and protects against Denial of Service (DoS) attacks when the firewall is activated.
Apply	Click Apply to save the settings.
Cancel	Click Cancel to start configuring this screen again.

17.3 Services Screen

If an outside user attempts to probe an unsupported port on your EMG2926-Q10A, an ICMP response packet is automatically returned. This allows the outside user to know the EMG2926-Q10A exists. Use this screen to prevent the ICMP response packet from being sent. This keeps outsiders from discovering your EMG2926-Q10A when unsupported ports are probed.

You can also use this screen to ~~enable service blocking, and enter/delete/modify the services you want to block and the date/time you want to block them~~ enable/add/delete/modify an IPv4 firewall rule.

Click **Security > Firewall > Services**. The screen appears as shown next.

Figure 93 Security > Firewall > Services I

The following table describes the labels in this screen.

Table 59 Security > Firewall > Services

LABEL	DESCRIPTION
ICMP	Internet Control Message Protocol is a message control and error-reporting protocol between a host server and a gateway to the Internet. ICMP uses Internet Protocol (IP) datagrams, but the messages are processed by the TCP/IP software and directly apparent to the application user.
Respond to Ping on	The EMG2926-Q10A will not respond to any incoming Ping requests when Disable is selected. Select LAN to reply to incoming LAN Ping requests. Select WAN to reply to incoming WAN Ping requests. Otherwise select LAN&WAN to reply to all incoming LAN and WAN Ping requests.
Apply	Click Apply to save the settings.
Enable Firewall Rule	
Enable Firewall Rule	Select this check box to activate the firewall rules that you define (see Add Firewall Rule below).
Apply	Click Apply to save the settings.
Add Firewall Rule	
Service Name	Enter a name that identifies or describes the firewall rule.

Table 59 Security > Firewall > Services (continued)

LABEL	DESCRIPTION
Protocol	Select the protocol (TCP , UDP or ICMP) used to transport the packets for which you want to apply the firewall rule.
MAC Address	Enter the MAC address of the computer for which the firewall rule applies.
Dest IP Address	Enter the IP address of the computer to which traffic for the application or service is entering. The EMG2926-Q10A applies the firewall rule to traffic initiating from this computer.
Source IP Address	Enter the IP address of the computer that initializes traffic for the application or service. The EMG2926-Q10A applies the firewall rule to traffic initiating from this computer.
Dest Port Range	Enter the port number/range of the destination that define the traffic type, for example TCP port 80 defines web traffic.
Source Port Range	Enter the port number/range of the source that define the traffic type, for example TCP port 80 defines web traffic.
Add Rule	Click Add to save the firewall rule.
Firewall Rule	
#	This is your firewall rule number. The ordering of your rules is important as rules are applied in turn.
Service Name	This is a name that identifies or describes the firewall rule.
MAC address	This is the MAC address of the computer for which the firewall rule applies.
Dest IP	This is the IP address of the computer to which traffic for the application or service is entering.
Source IP	This is the IP address of the computer from which traffic for the application or service is initialized.
Protocol	This is the protocol (TCP , UDP or ICMP) used to transport the packets for which you want to apply the firewall rule.
Dest Port Range	This is the port number/range of the destination that define the traffic type, for example TCP port 80 defines web traffic.
Source Port Range	This is the port number/range of the source that define the traffic type, for example TCP port 80 defines web traffic.
Action	DROP - Traffic matching the conditions of the firewall rule are stopped.
Delete	Click Delete to remove the firewall rule.
Cancel	Click Cancel to start configuring this screen again.

See [Appendix C on page 221](#) for commonly used services and port numbers.

Content Filtering

18.1 Overview

This chapter provides a brief overview of content filtering using the embedded web GUI.

Internet content filtering allows you to create and enforce Internet access policies tailored to your needs. Content filtering is the ability to block certain web features or specific URL keywords.

18.1.1 What You Need To Know

The following terms and concepts may help as you read through this chapter.

Content Filtering Profiles

Content filtering allows you to block certain web features, such as cookies, and/or block access to specific web sites. For example, you can configure one policy that blocks John Doe's access to arts and entertainment web pages.

A content filtering profile conveniently stores your custom settings for the following features.

Keyword Blocking URL Checking

The EMG2926-Q10A checks the URL's domain name (or IP address) and file path separately when performing keyword blocking.

The URL's domain name or IP address is the characters that come before the first slash in the URL. For example, with the URL www.zyxel.com.tw/news/pressroom.php, the domain name is www.zyxel.com.tw.

The file path is the characters that come after the first slash in the URL. For example, with the URL www.zyxel.com.tw/news/pressroom.php, the file path is news/pressroom.php.

Since the EMG2926-Q10A checks the URL's domain name (or IP address) and file path separately, it will not find items that go across the two. For example, with the URL www.zyxel.com.tw/news/pressroom.php, the EMG2926-Q10A would find "tw" in the domain name (www.zyxel.com.tw). It would also find "news" in the file path (news/pressroom.php) but it would not find "tw/news".

18.2 Content Filter

Use this screen to restrict web features, ~~add keywords for blocking~~ and designate a trusted computer. Click **Security** > **Content Filter** to open the **Content Filter** screen.

Figure 94 Security > Content Filter

The following table describes the labels in this screen.

Table 60 Security > Content Filter

LABEL	DESCRIPTION
Trusted IP Setup	To enable this feature, type an IP address of any one of the computers in your network that you want to have as a trusted computer. This allows the trusted computer to have full access to all features that are configured to be blocked by content filtering. Leave this field blank to have no trusted computers.
Restrict Web Features	Select the box(es) to restrict a feature. When you download a page containing a restricted feature, that part of the web page will appear blank or grayed out.
ActiveX	A tool for building dynamic and active Web pages and distributed object applications. When you visit an ActiveX Web site, ActiveX controls are downloaded to your browser, where they remain in case you visit the site again.
Java	A programming language and development environment for building downloadable Web components or Internet and intranet business applications of all kinds.
Cookies	Used by Web servers to track usage and provide service based on ID.
Web Proxy	A server that acts as an intermediary between a user and the Internet to provide security, administrative control, and caching service. When a proxy server is located on the WAN it is possible for LAN users to circumvent content filtering by pointing to this proxy server.
Enable URL-Keyword Blocking	The EMG2926-Q10A can block Web sites with URLs that contain certain keywords in the domain name or IP address. For example, if the keyword "bad" was enabled, all sites containing this keyword in the domain name or IP address will be blocked, e.g., URL http://www.website.com/bad.html would be blocked. Select this check box to enable this feature.
Keyword	Type a keyword in this field. You may use any character (up to 64 characters). Wildcards are not allowed. You can also enter a numerical IP address.
Add	Click Add after you have typed a keyword. Repeat this procedure to add other keywords. Up to 64 keywords are allowed. When you try to access a web page containing a keyword, you will get a message telling you that the content filter is blocking this request.
Keyword List	This list displays the keywords already added.
Delete	Highlight a keyword in the lower box and click Delete to remove it. The keyword disappears from the text box after you click Apply .
Clear All	Click this button to remove all of the listed keywords.
Apply	Click Apply to save your changes.
Cancel	Click Cancel to begin configuring this screen afresh

18.3 Technical Reference

The following section contains additional technical information about the EMG2926-Q10A features described in this chapter.

18.3.1 Customizing Keyword Blocking URL Checking

You can use commands to set how much of a website's URL the content filter is to check for keyword blocking. See the appendices for information on how to access and use the command interpreter.

Domain Name or IP Address URL Checking

By default, the EMG2926-Q10A checks the URL's domain name or IP address when performing keyword blocking.

This means that the EMG2926-Q10A checks the characters that come before the first slash in the URL.

For example, with the URL www.zyxel.com.tw/news/pressroom.php, content filtering only searches for keywords within www.zyxel.com.tw.

Full Path URL Checking

Full path URL checking has the EMG2926-Q10A check the characters that come before the last slash in the URL.

For example, with the URL www.zyxel.com.tw/news/pressroom.php, full path URL checking searches for keywords within www.zyxel.com.tw/news/.

Use the `ip urlfilter customize actionFlags 6 [disable | enable]` command to extend (or not extend) the keyword blocking search to include the URL's full path.

File Name URL Checking

Filename URL checking has the EMG2926-Q10A check all of the characters in the URL.

For example, filename URL checking searches for keywords within the URL www.zyxel.com.tw/news/pressroom.php.

Use the `ip urlfilter customize actionFlags 8 [disable | enable]` command to extend (or not extend) the keyword blocking search to include the URL's complete filename.

Parental Control

19.1 Overview

Parental control allows you to block web sites with the specific URL. You can also define time periods and days during which the EMG2926-Q10A performs parental control on a specific user.

19.2 The Parental Control Screen

Use this screen to enable parental control, view the parental control rules and schedules.

Click **Configuration > Security > Parental Control** to open the following screen.

Figure 95 Security > Parental Control

#	Status	Rule Name	Home Network User (MAC)	Internet Access Schedule	Network Service	Website Blocked	Modify
1		PCRule1	(00:a0:c5:01:23:45)	Mon,Tue,Wed,Thu,Fri 08:00-17:00	NONE	Configured	

The following table describes the fields in this screen.

Table 61 Security > Parental Control

LABEL	DESCRIPTION
Parental Control	Select Enable to activate parental control.
Add new rules	Click this if you want to configure a new parental control rule.
#	This shows the index number of the rule.
Status	This indicates whether the rule is active or not. A yellow bulb signifies that this rule is active. A gray bulb signifies that this rule is not active.
Rule Name	This shows the name of the rule.
Home Network User (MAC)	This shows the MAC address of the LAN user's computer to which this rule applies.

Table 61 Security > Parental Control (continued)

LABEL	DESCRIPTION
Internet Access Schedule	This shows the day(s) and time on which parental control is enabled.
Network Service	This shows whether the network service is configured. If not, None will be shown.
Website Block	This shows whether the website block is configured. If not, None will be shown.
Modify	Click the Edit icon to go to the screen where you can edit the rule. Click the Delete icon to delete an existing rule.
Apply	Click Apply to save your changes.
Cancel	Click Cancel to restore your previously saved settings.

19.2.1 Add/Edit a Parental Control Rule

Click **Add new rules** in the **Parental Control** screen to add a new rule or click the **Edit** icon next to an existing rule to edit it. Use this screen to configure a restricted access schedule and/or URL filtering settings to block the users on your network from accessing certain web sites.

Figure 96 Security > Parental Control: Add/Edit

Parental Control

General

Active

Parental Control Profile Name :

Home Network User :

Internet Access Schedule

Day : Monday Tuesday Wednesday Thursday
 Friday Saturday Sunday

Time (begin ~ end) : (hour) (min) ~ (hour) (min)

Network Service

Network Service Setting : selected service

Network Service Rules			
#	Service Name	Protocol:Port	Modify

Block Site/URL Keyword

Keyword

Keyword List

The following table describes the fields in this screen.

Table 62 Security > Parental Control: Add/Edit

LABEL	DESCRIPTION
General	
Active	Select the checkbox to activate this parental control rule.
Parental Control Profile Name	Enter a descriptive name for the rule.

Table 62 Security > Parental Control: Add/Edit (continued)

LABEL	DESCRIPTION
Home Network User	Select the LAN user that you want to apply this rule to from the drop-down list box. If you select Custom , enter the LAN user's MAC address. If you select All , the rule applies to all LAN users.
Internet Access Schedule	
Day	Select check boxes for the days that you want the EMG2926-Q10A to perform parental control.
Time	Drag the time bar to define the time that the LAN user is allowed access.
Network Service	
Network Service Setting	If you select Block , the EMG2926-Q10A prohibits the users from viewing the Web sites with the URLs using the services listed below. If you select Allow , the EMG2926-Q10A blocks access to all URLs all services except ones listed below.
Add new service	Click this to show a screen in which you can add a new service rule. You can configure the Service Name , Protocol , and Port of the new rule.
#	This shows the index number of the rule. Select the checkbox next to the rule to activate it.
Service Name	This shows the name of the service .
Protocol:Port	This shows the protocol and the port of the service .
Modify	Click the Edit icon to go to the screen where you can edit the rule. Click the Delete icon to delete an existing rule.
Blocked Site/ URL Keyword	Click Add to show a screen to enter the URL of web site or URL keyword to which the EMG2926-Q10A blocks access. Click Delete to remove it.
Apply	Click Apply to save your settings back to the EMG2926-Q10A.
Cancel	Click Cancel to restore your previously saved settings.

IPv6 Firewall

20.1 Overview

This chapter shows you how to enable and create IPv6 firewall rules to block unwanted IPv6 traffic.

20.2 The IPv6 Firewall Screen

Click **Configuration > Security > IPv6 Firewall**. The **Service** screen appears as shown.

Figure 97 Configuration > Security > IPv6 Firewall

Services

ICMPv6

Respond to Ping on: ▾

Enable Firewall Rule

Enable Firewall Rule

Add Firewall Rule

Service Name :

MAC Address :

Dest_IP_Address :

Source_IP_Address :

Protocol : ▾

DestPortRange : -

SourcePortRange : -

Firewall Rule

Firewall Rule									
#	ServiceName	MACAddress	DestIP	SourceIP	Protocol	DestPortRange	SourcePortRange	Action	Delete

The following table describes the labels in this screen.

Table 63 Configuration > Security > IPv6 Firewall

LABEL	DESCRIPTION
ICMPv6	Internet Control Message Protocol for IPv6 (ICMPv6 or ICMP for IPv6) is defined in RFC 4443. ICMPv6 has a preceding Next Header value of 58, which is different from the value used to identify ICMP for IPv4. ICMPv6 is an integral part of IPv6. IPv6 nodes use ICMPv6 to report errors encountered in packet processing and perform other diagnostic functions, such as "ping".
Respond to Ping on	The EMG2926-Q10A will not respond to any incoming Ping requests when Disable is selected. Select LAN to reply to incoming LAN Ping requests. Select WAN to reply to incoming WAN Ping requests. Otherwise select LAN&WAN to reply to all incoming LAN and WAN Ping requests.
Apply	Click Apply to save the settings.
Enable Firewall Rule	
Enable Firewall Rule	Select this check box to activate the firewall rules that you define (see Add Firewall Rule below).
Apply	Click Apply to save the settings.
Add Firewall Rule	
Service Name	Enter a name that identifies or describes the firewall rule.
MAC Address	Enter the MAC address of the computer for which the firewall rule applies.
Dest_IP_Address	Enter the IPv6 address of the computer to which traffic for the application or service is entering. The EMG2926-Q10A applies the firewall rule to traffic initiations from this computer.
Source_IP_Address	Enter the IPv6 address of the computer that initializes traffic for the application or service. The EMG2926-Q10A applies the firewall rule to traffic initiating from this computer.
Protocol	Select the protocol (TCP , UDP or ICMP) used to transport the packets for which you want to apply the firewall rule.
Dest Port Range	Enter the port number/range of the destination that define the traffic type, for example TCP port 80 defines web traffic.
Source Port Range	Enter the port number/range of the source that define the traffic type, for example TCP port 80 defines web traffic.
Add Rule	Click Add to save the firewall rule.
Firewall Rule	
#	This is your firewall rule number. The ordering of your rules is important as rules are applied in turn.
ServiceName	This is a name that identifies or describes the firewall rule.
MACAddress	This is the MAC address of the computer for which the firewall rule applies.
DestIP	This is the IP address of the computer to which traffic for the application or service is entering.
SourceIP	This is the IP address of the computer to which traffic for the application or service is initialized.
Protocol	This is the protocol (TCP , UDP or ICMP) used to transport the packets for which you want to apply the firewall rule.
DestPortRange	This is the port number/range of the destination that define the traffic type, for example TCP port 80 defines web traffic.
SourcePortRange	This is the port number/range of the source that define the traffic type, for example TCP port 80 defines web traffic.
Action	DROP - Traffic matching the conditions of the firewall rule are stopped.

Table 63 Configuration > Security > IPv6 Firewall (continued)

LABEL	DESCRIPTION
Delete	Click Delete to remove the firewall rule.
Cancel	Click Cancel to restore your previously saved settings.

StreamBoost Management

21.1 Overview

The EMG2926-Q10A supports the new StreamBoost technology, introduced by Qualcomm, to redistribute traffic over the EMG2926-Q10A for the best possible performance in a home network. At the time of writing, the StreamBoost feature is disabled on the EMG2926-Q10A.

Streamboost is smart Quality of Service (QoS). Streamboost detects traffic flows and applies traffic shaping policies automatically. It gives each device and each application the priority and provides the exact amount of bandwidth they need at a given time. This helps free up bandwidth for other applications or connected devices. If there is not enough bandwidth for optimal performance, Streamboost makes sure the application or device has the minimum acceptable bandwidth which is determined according to the StreamBoost's cloud-based database.

Real-time application traffic (such as on-line games or communications) and video/audio streaming are given the highest priority. Downloads or torrent files are classified as best effort and placed lower than general network traffic (general browsing).

In the figure below, the StreamBoost-enabled EMG2926-Q10A differentiates incoming traffic flows going from the LAN device (A) or wireless device (B) to the Internet. It shapes traffic and gives priority and allocate bandwidth according to traffic types.

Figure 98 StreamBoost Management Example

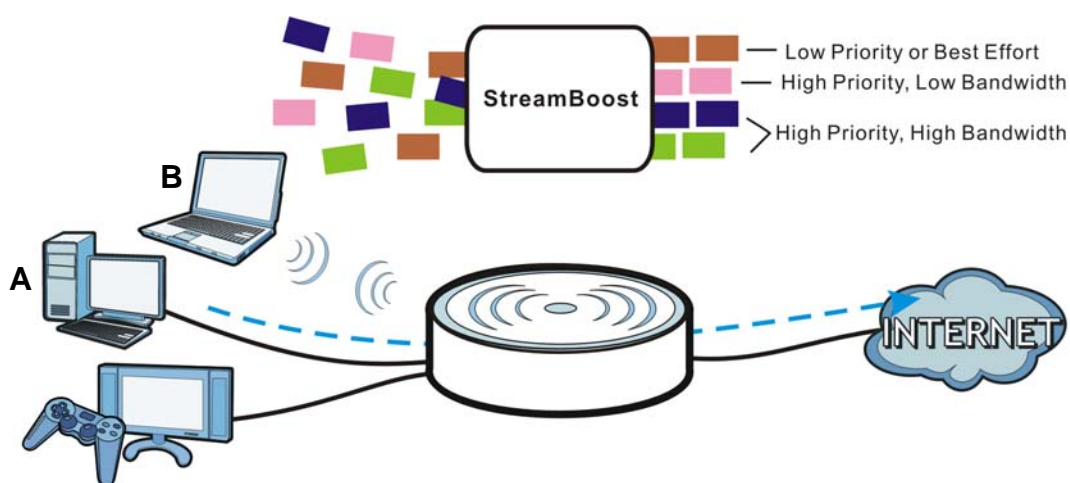

21.2 What You Can Do

- Use the **Network** screen to view transmission data rates between the EMG2926-Q10A and the Internet or connected devices ([Section 21.3 on page 150](#)).
- Use the **Bandwidth** screen to configure the maximum allowable bandwidth and enable automatic update([Section 21.4 on page 150](#)).
- Use the **Priorities** screen to prioritize the connected devices ([Section 21.5 on page 152](#)).
- Use the **Up Time** screen to view the top five traffic flows transmitting from/to the selected LAN device(s) ([Section 21.6 on page 152](#)).
- Use the **Downloads** screen to view the type and percentage of most download traffic ([Section 21.7 on page 152](#)).
- Use the **All Events** screen to view the time at which a traffic flow is given bandwidth for optimal, good or best-effort performance ([Section 21.8 on page 153](#)).

21.3 Network Screen

When the StreamBoost feature is enabled, use this screen to view the current upstream and downstream transmission speeds between the EMG2926-Q10A and the Internet and/or between the EMG2926-Q10A and the connected device(s) (represented by icons indicating the kind of network device), including those connecting wirelessly.

Click **Management > StreamBoost MGMT > Network** to open the **Network** screen.

Figure 99 Management > StreamBoost Management > Network

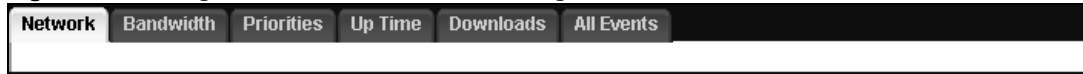

21.4 Bandwidth Screen

Use this screen to configure the maximum allowable bandwidth on the EMG2926-Q10A and allow the EMG2926-Q10A to get StreamBoost database updates automatically.

Click **Management > StreamBoost MGMT > Bandwidth** to open the **Bandwidth** screen.

Figure 100 Management > StreamBoost Management > Bandwidth

Streamboost

Enable Streamboost

Automatic Bandwidth Detection

Up Limit (Mbps)

Down Limit (Mbps)

Run Bandwidth Test

Automatic Update Agreement

Check below to enable your router to receive automatic StreamBoost updates during your initial 3-year manufacturer service term (extendable through the manufacturer). StreamBoost updates may help improve your router's Internet traffic management capabilities. In exchange, your StreamBoost enabled router will send Qualcomm Atheros Inc. anonymous information from your router. If you decline, you can find updates through software or firmware postings from your router's manufacturer.

Your StreamBoost enabled router will provide Qualcomm Atheros Inc. with anonymous data transmitted through the router. Such anonymous data may include small amounts of information when you launch a streaming service (such as video, audio, or gaming) for

Enable Automatic Update

The following table describes the labels in this screen.

Table 64 Management > StreamBoost Management > Bandwidth

LABEL	DESCRIPTION
Enable Streamboost	Select this option to turn on the StreamBoost feature. This field is not configurable at the time of writing.
Automatic Bandwidth Detection	Select this option to control the maximum or minimum amounts of bandwidth that can be used by traffic.
Up Limit	Set the total amount of bandwidth that you want to dedicate to uplink (or outgoing) traffic. This is traffic from LAN/WLAN to WAN.
Down Limit	Set the total amount of bandwidth that you want to dedicate to downlink (or incoming) traffic. This is traffic from WAN to LAN/WLAN.
Run Bandwidth Test	Click Test Bandwidth to determine the maximum bandwidth of your internet connection.
Enable Automatic Update	StreamBoost provides a cloud-based service to learn any new type of traffic which is not in its database and update the table in the EMG2926-Q10A for traffic detection and policies. Select this option to have the EMG2926-Q10A automatically receives the StreamBoost table updates. When there is a new type of traffic which is not in the EMG2926-Q10A's table, the EMG2926-Q10A will capture some packets and send them to the StreamBoost cloud for analysis and database update.

Table 64 Management > StreamBoost Management > Bandwidth (continued)

LABEL	DESCRIPTION
Apply	Click Apply to save your customized settings.
Cancel	Click Cancel to begin configuring this screen afresh.

21.5 Priorities Screen

The StreamBoost engine on the EMG2926-Q10A can identify the types of connected devices (such as PC, smart phone, tablet, TV or game console) in your network. When there is not enough bandwidth to support traffic of the same priority, the EMG2926-Q10A refers to the connected device priority. Traffic from the device with the lowest priority is classified as best-effort traffic.

When the StreamBoost feature is enabled, use this screen to prioritize the connected devices by clicking a device's arrow button to change its position in the list. Click **Save** to apply your settings. Otherwise, click **Cancel** to return the screen to its last-saved settings.

Click **Management > StreamBoost MGMT > Priorities** to open the **Priorities** screen.

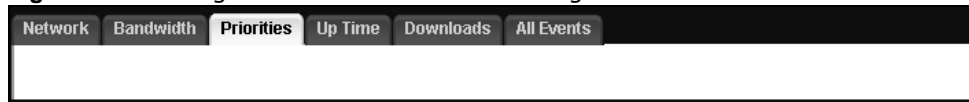
Figure 101 Management > StreamBoost Management > Priorities

21.6 Up Time Screen

When the StreamBoost feature is enabled, use this screen to view the top five traffic flows transmitting from/to the selected LAN device(s) in the past one day, one week or one month.

Click **Management > StreamBoost MGMT > Up Time** to open the **Up Time** screen.

The y-axis shows the time period over which the traffic flow occurred. The x-axis shows the type of the traffic flow.

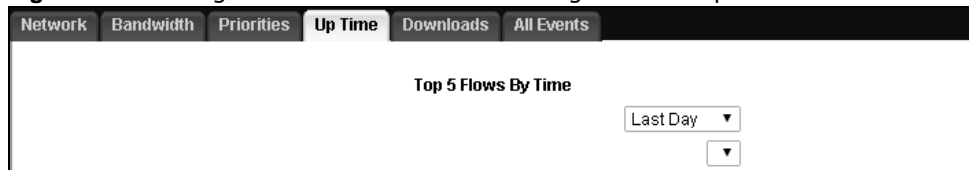
Figure 102 Management > StreamBoost Management > Up Time

21.7 Downloads Screen

When the StreamBoost feature is enabled, use this screen to view the type and percentage of most download traffic on the EMG2926-Q10A.

Click **Management > StreamBoost MGMT > Downloads** to open the **Downloads** screen.

Figure 103 Management > StreamBoost Management > Downloads



21.8 All Events Screen

When the StreamBoost feature is enabled, use this screen to view the time at which a traffic flow is given enough bandwidth for optimal, good or best-effort performance.

Click **Management > StreamBoost MGMT > All Events** to open the **All Events** screen.

The y-axis shows the type of the traffic flow. The x-axis shows the time period over which the traffic flow got the required bandwidth.

Figure 104 Management > StreamBoost Management > All Events



Remote Management

22.1 Overview

This chapter provides information on the Remote Management screens.

Remote Management allows you to manage your EMG2926-Q10A from a remote location through the following interfaces:

- LAN and WAN
- LAN only
- WAN only

Note: The EMG2926-Q10A is managed using the Web Configurator.

22.2 What You Can Do in this Chapter

- Use the **WWW** screen to define the interface/s from which the EMG2926-Q10A can be managed remotely using the web and specify a secure client that can manage the EMG2926-Q10A ([Section 22.4 on page 155](#)).
- Use the **Telnet** screen to define the interface/s from which the EMG2926-Q10A can be managed remotely using Telnet service and specify a secure client that can manage the EMG2926-Q10A ([Section 22.5 on page 156](#)).
- Use the **Wake On LAN** screen to enable Wake on LAN and remotely turn on a device on the local network ([Section 22.7 on page 159](#)).

22.3 What You Need to Know

Remote management over LAN or WAN will not work when:

- 1 The IP address in the **Secured Client IP Address** field ([Section 22.4 on page 155](#)) does not match the client IP address. If it does not match, the EMG2926-Q10A will disconnect the session immediately.
- 2 There is already another remote management session. You may only have one remote management session running at one time.
- 3 There is a firewall rule that blocks it.

22.3.1 Remote Management and NAT

When NAT is enabled:

- Use the EMG2926-Q10A's WAN IP address when configuring from the WAN.
- Use the EMG2926-Q10A's LAN IP address when configuring from the LAN.

22.3.2 System Timeout

There is a default system management idle timeout of five minutes (three hundred seconds). The EMG2926-Q10A automatically logs you out if the management session remains idle for longer than this timeout period. The management session does not time out when a statistics screen is polling. You can change the timeout period in the **Maintenance > General** screen

22.4 WWW Screen

To change your EMG2926-Q10A's remote management settings, click **Management > Remote MGMT > WWW**.

Figure 105 Management > Remote Management > WWW

The following table describes the labels in this screen.

Table 65 Management > Remote Management > WWW

LABEL	DESCRIPTION
Port	You may change the server port number for a service if needed, however you must use the same port number in order to use that service for remote management.
Access Status	Select the interface(s) through which a computer may access the EMG2926-Q10A using this service.
Secured Client IP Address	Select All to allow all computers to access the EMG2926-Q10A. Otherwise, check Selected and specify the IP address of the computer that can access the EMG2926-Q10A.
Apply	Click Apply to save your customized settings.
Cancel	Click Cancel to begin configuring this screen afresh.

22.5 ~~Telnet Screen~~

To change your EMG2926-Q10A's remote management settings, click **Management > Remote MGMT > Telnet** to open the **Telnet** screen.

Figure 106 Management > Remote MGMT > Telnet

The following table describes the labels in this screen.

Table 66 Management > Remote MGMT > Telnet

LABEL	DESCRIPTION
Port	You may change the server port number for a service if needed, however you must use the same port number in order to use that service for remote management.
Access Status	Select the interface(s) through which a computer may access the EMG2926-Q10A using this service.
Secured Client IP Address	Select All to allow all computers to access the EMG2926-Q10A. Otherwise, check Selected and specify the IP address of the computer that can access the EMG2926-Q10A.
Apply	Click Apply to save your customized settings.
Cancel	Click Cancel to begin configuring this screen afresh.

22.6 SNMP

Simple Network Management Protocol is a protocol used for exchanging management information between network devices. Your EMG2926-Q10A supports SNMP agent functionality, which allows a manager station to manage and monitor the EMG2926-Q10A through the network. **The EMG2926-Q10A supports SNMP version one (SNMPv1) and version two (SNMPv2c).** The next figure illustrates an SNMP management operation.

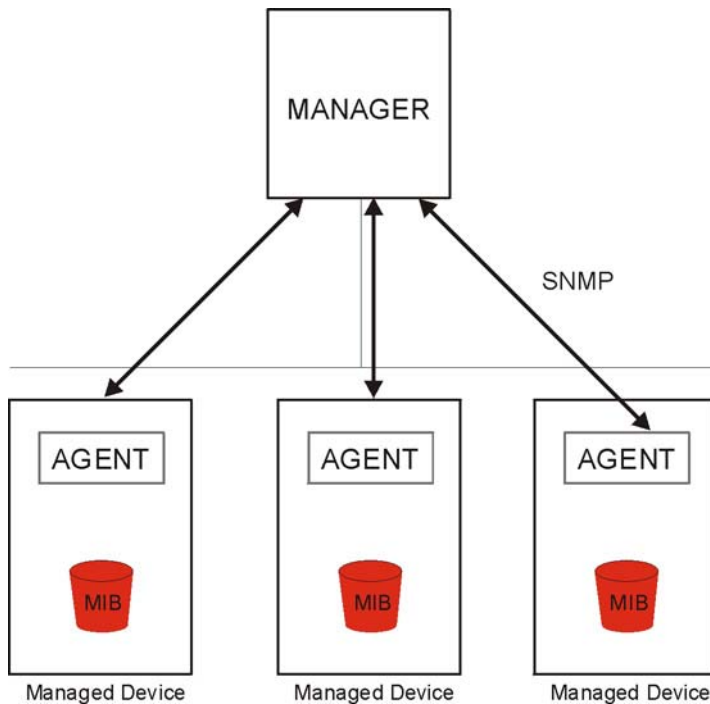
Figure 107 SNMP Management Model

An SNMP managed network consists of two main types of component: agents and a manager.

An agent is a management software module that resides in a managed device (the EMG2926-Q10A). An agent translates the local management information from the managed device into a form compatible with SNMP. The manager is the console through which network administrators perform network management functions. It executes applications that control and monitor managed devices.

The managed devices contain object variables/managed objects that define each piece of information to be collected about a device. Examples of variables include such as number of packets received, node port status etc. A Management Information Base (MIB) is a collection of managed objects. SNMP allows a manager and agents to communicate for the purpose of accessing these objects.

SNMP itself is a simple request/response protocol based on the manager/agent model. The manager issues a request and the agent returns responses using the following protocol operations:

- Get - Allows the manager to retrieve an object variable from the agent.
- GetNext - Allows the manager to retrieve the next object variable from a table or list within an agent. In SNMPv1, when a manager wants to retrieve all elements of a table from an agent, it initiates a Get operation, followed by a series of GetNext operations.
- Set - Allows the manager to set values for object variables within an agent.
- Trap - Used by the agent to inform the manager of some events.

To change your EMG2926-Q10A's SNMP settings, click **Management > Remote MGMT > SNMP**.

Figure 108 Management > Remote Management > SNMP

The following table describes the labels in this screen.

Table 67 Management > Remote Management > SNMP

LABEL	DESCRIPTION
SNMP Settings	
Server Port	You may change the server port number for a service if needed, however you must use the same port number in order to use that service for remote management.
Server Access	Select the interface(s) through which a computer may access the EMG2926-Q10A using this service.
Secured IP	Select All to allow all computers to access the EMG2926-Q10A. Otherwise, check Selected and specify the IP address of the computer that can access the EMG2926-Q10A.
SNMP Enable	Select this to enable SNMP on the EMG2926-Q10A. Select this to allow a manager station to manage and monitor the EMG2926-Q10A through the network via SNMP.
Get Community	Enter the password for the incoming Get and GetNext requests from the management station. The default is public and allows all requests.
Set Community	Enter the password for incoming Set requests from the management station. The default is public and allows all requests.
System Location	Specify the geographic location of the EMG2926-Q10A.
System Contact	Enter the name of the person in charge of the EMG2926-Q10A.
Trap Settings	

Table 67 Management > Remote Management > SNMP (continued)

LABEL	DESCRIPTION
Trap Enable	Select this to have the EMG2926-Q10A send an SNMP trap to the specified IP address when it receives the event. Clear this to disable it.
Trap Manager IP	Type the IP address of the SNMP manager to which your SNMP traps are sent.
Trap Community	Type the password sent with each trap to the SNMP manager. The default is public and allows all requests.
Apply	Click Apply to save your customized settings.
Cancel	Click Cancel to begin configuring this screen afresh.

22.7 Wake On LAN Screen

Wake On LAN (WoL) allows you to remotely turn on a device on the network, such as a computer, storage device or media server. To use this feature the remote hardware (for example the network adapter on a computer) must support Wake On LAN using the “Magic Packet” method.

You need to know the MAC address of the remote device. It may be on a label on the device.

Use this screen to remotely turn on a device on the network. Click the **Management > Remote MGMT > Wake On LAN** to open the following screen.

Figure 109 Management > Remote MGMT > Wake On LAN

The following table describes the labels in this screen.

Table 68 Management > Remote MGMT > Wake On LAN

LABEL	DESCRIPTION
Wake On LAN over WAN Settings	
Enable WOL over WAN	Select this option to have the EMG2926-Q10A forward a WoL “Magic Packet” to all devices on the LAN if the packet comes from the WAN or remote network and uses the port number specified in the Port field. A LAN device whose hardware supports Wake on LAN then will be powered on if it is turned off previously.

Table 68 Management > Remote MGMT > Wake On LAN (continued)

LABEL	DESCRIPTION
Port	Type a port number from which a WoL packet is forwarded to the LAN.
Wake On LAN	
Wake MAC Address	Enter the MAC Address of the device on the network that will be turned on. A MAC address consists of six hexadecimal character pairs.
Start	Click this to have the EMG2926-Q10A generate a WoL packet and forward it to turn the specified device on. A screen pops up displaying MAC address error if you input the MAC address incorrectly.
Apply	Click Apply to save the setting to the EMG2926-Q10A.
Cancel	Click Cancel to begin configuring this screen afresh.

Universal Plug-and-Play (UPnP)

23.1 Overview

This chapter introduces the UPnP feature in the web configurator.

Universal Plug and Play (UPnP) is a distributed, open networking standard that uses TCP/IP for simple peer-to-peer network connectivity between devices. A UPnP device can dynamically join a network, obtain an IP address, convey its capabilities and learn about other devices on the network. In turn, a device can leave a network smoothly and automatically when it is no longer in use.

23.2 What You Need to Know

UPnP hardware is identified as an icon in the Network Connections folder (Windows XP). Each UPnP compatible device installed on your network will appear as a separate icon. Selecting the icon of a UPnP device will allow you to access the information and properties of that device.

23.2.1 NAT Traversal

UPnP NAT traversal automates the process of allowing an application to operate through NAT. UPnP network devices can automatically configure network addressing, announce their presence in the network to other UPnP devices and enable exchange of simple product and service descriptions. NAT traversal allows the following:

- Dynamic port mapping
- Learning public IP addresses
- Assigning lease times to mappings

Windows Messenger is an example of an application that supports NAT traversal and UPnP.

See the NAT chapter for more information on NAT.

23.2.2 Cautions with UPnP

The automated nature of NAT traversal applications in establishing their own services and opening firewall ports may present network security issues. Network information and configuration may also be obtained and modified by users in some network environments.

When a UPnP device joins a network, it announces its presence with a multicast message. For security reasons, the EMG2926-Q10A allows multicast messages on the LAN only.

All UPnP-enabled devices may communicate freely with each other without additional configuration. Disable UPnP if this is not your intention.

23.3 UPnP Screen

Use this screen to enable UPnP on your EMG2926-Q10A.

Click **Management** > **UPnP** to display the screen shown next.

Figure 110 Management > UPnP

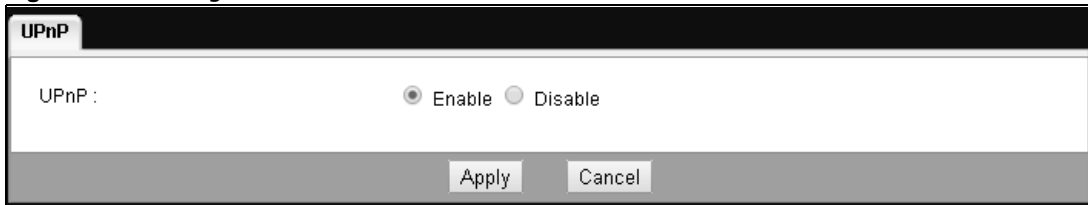

The following table describes the fields in this screen.

Table 69 Management > UPnP

LABEL	DESCRIPTION
UPnP	Select Enable to activate UPnP. Be aware that anyone could use a UPnP application to open the web configurator's login screen without entering the EMG2926-Q10A's IP address (although you must still enter the password to access the web configurator).
Apply	Click Apply to save the setting to the EMG2926-Q10A.
Cancel	Click Cancel to return to the previously saved settings.

23.4 Technical Reference

The sections show examples of using UPnP.

23.4.1 Using UPnP in Windows XP Example

This section shows you how to use the UPnP feature in Windows XP. You must already have UPnP installed in Windows XP and UPnP activated on the EMG2926-Q10A.

Make sure the computer is connected to a LAN port of the EMG2926-Q10A. Turn on your computer and the EMG2926-Q10A.

23.4.1.1 Auto-discover Your UPnP-enabled Network Device

- 1 Click **start** and **Control Panel**. Double-click **Network Connections**. An icon displays under Internet Gateway.
- 2 Right-click the icon and select **Properties**.

Figure 111 Network Connections



- 3 In the **Internet Connection Properties** window, click **Settings** to see the port mappings there were automatically created.

Figure 112 Internet Connection Properties



- 4 You may edit or delete the port mappings or click **Add** to manually add port mappings.

Figure 113 Internet Connection Properties: Advanced Settings

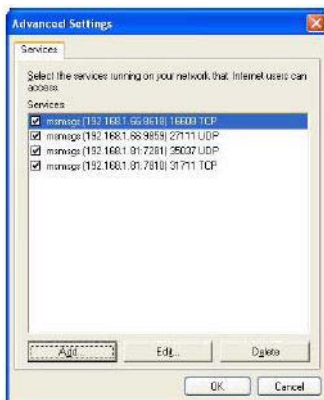
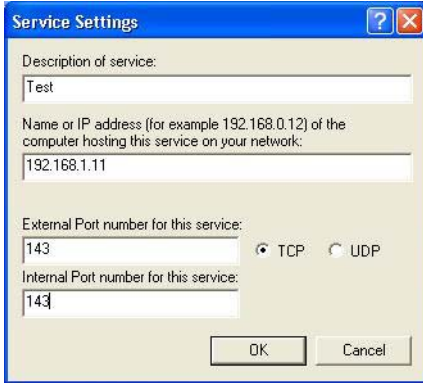

Figure 114 Internet Connection Properties: Advanced Settings: Add

Note: When the UPnP-enabled device is disconnected from your computer, all port mappings will be deleted automatically.

- 5 Select **Show icon in notification area when connected** option and click **OK**. An icon displays in the system tray.

Figure 115 System Tray Icon

- 6 Double-click on the icon to display your current Internet connection status.

Figure 116 Internet Connection Status

23.4.2 Web Configurator Easy Access

With UPnP, you can access the web-based configurator on the EMG2926-Q10A without finding out the IP address of the EMG2926-Q10A first. This comes helpful if you do not know the IP address of the EMG2926-Q10A.

Follow the steps below to access the web configurator.

- 1 Click **Start** and then **Control Panel**.
- 2 Double-click **Network Connections**.

3 Select **My Network Places** under **Other Places**.

Figure 117 Network Connections

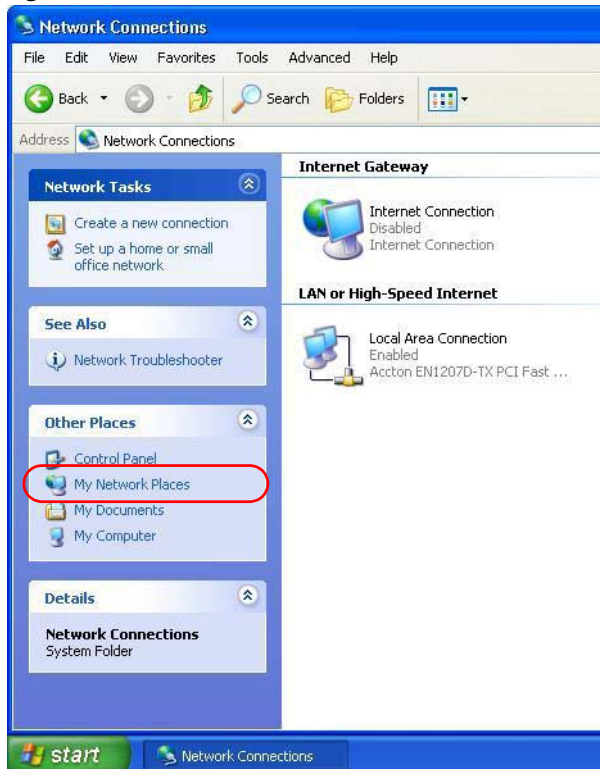

4 An icon with the description for each UPnP-enabled device displays under **Local Network**.

5 Right-click on the icon for your EMG2926-Q10A and select **Invoke**. The web configurator login screen displays.

Figure 118 Network Connections: My Network Places



6 Right-click on the icon for your EMG2926-Q10A and select **Properties**. A properties window displays with basic information about the EMG2926-Q10A.

Figure 119 Network Connections: My Network Places: Properties: Example



USB Media Sharing

24.1 Overview

This chapter describes how to configure the media sharing settings on the EMG2926-Q10A.

Note: The read and write performance may be affected by amount of file-sharing traffic on your network, type of connected USB device and your USB version (1.1 or 2.0).

Media Server

You can set up your EMG2926-Q10A to act as a media server to provide media (like video) to DLNA-compliant players, such as Windows Media Player, ZyXEL DMAs (Digital Media Adapters), Xboxes or PS3s. The media server and clients must have IP addresses in the same subnet.

The EMG2926-Q10A media server enables you to:

- Publish all folders for everyone to play media files in the USB storage device connected to the EMG2926-Q10A.
- Use hardware-based media clients like the DMA-2500 to play the files.

Note: Anyone on your network can play the media files in the published folders. No user name and password nor other form of security is required.

The following figure is an overview of the EMG2926-Q10A's media server feature. DLNA devices **A** and **B** can access and play files on a USB device (**C**) which is connected to the EMG2926-Q10A (**D**).

Figure 120 Media Server Overview

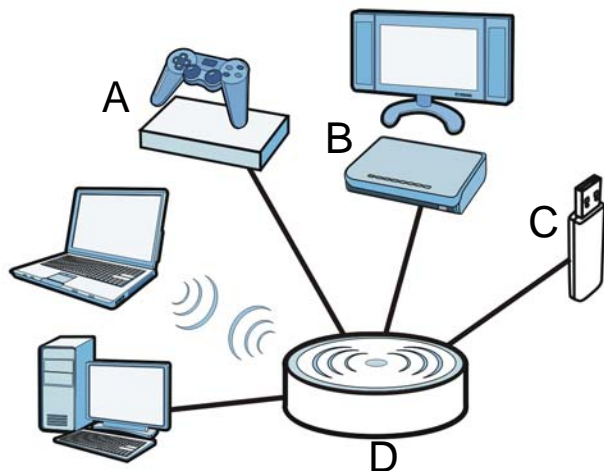

File-Sharing Server

You can also share files on a USB memory stick or hard drive connected to your EMG2926-Q10A with users on your network.

The following figure is an overview of the EMG2926-Q10A's file-sharing server feature. Computers **A** and **B** can access files on a USB device (**C**) which is connected to the EMG2926-Q10A (**D**).

Figure 121 File Sharing Overview

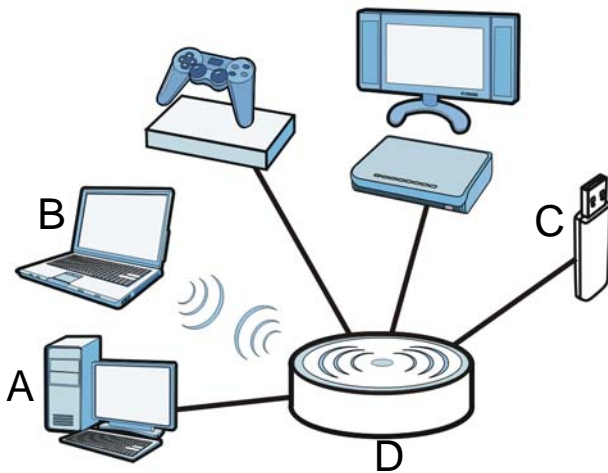

24.2 What You Can Do

- Use the **DLNA** screen to use the EMG2926-Q10A as a media server and allow DLNA-compliant devices to play media files stored in the attached USB device ([Section 24.5 on page 170](#)).
- Use the **SAMBA** screen to enable file-sharing via the EMG2926-Q10A using Windows Explorer or the workgroup name. This screen also allow you to configure the workgroup name and create user accounts ([Section 24.6 on page 171](#)).
- Use the **FTP** screen to allow file sharing via the EMG2926-Q10A using FTP and create user accounts ([Section 24.7 on page 172](#)).

24.3 What You Need To Know

DLNA

The Digital Living Network Alliance (DLNA) is a group of personal computer and electronics companies that works to make products compatible in a home network. DLNA clients play files stored on DLNA servers. The EMG2926-Q10A can function as a DLNA-compliant media server and stream files to DLNA-compliant media clients without any configuration.

Workgroup name

This is the name given to a set of computers that are connected on a network and share resources such as a printer or files. Windows automatically assigns the workgroup name when you set up a network.

File Systems

A file system is a way of storing and organizing files on your hard drive and storage device. Often different operating systems such as Windows or Linux have different file systems. The file-sharing feature on your EMG2926-Q10A supports New Technology File System (NTFS), File Allocation Table (FAT) and FAT32 file systems.

Windows/CIFS

Common Internet File System (CIFS) is a standard protocol supported by most operating systems in order to share files across the network.

CIFS runs over TCP/IP but uses the SMB (Server Message Block) protocol found in Microsoft Windows for file and printer access; therefore, CIFS will allow all applications, not just Web browsers, to open and share files across the Internet.

The EMG2926-Q10A uses Common Internet File System (CIFS) protocol for its file sharing functions. CIFS compatible computers can access the USB file storage devices connected to the EMG2926-Q10A. CIFS protocol is supported on Microsoft Windows, Linux Samba and other operating systems (refer to your systems specifications for CIFS compatibility).

Samba

SMB is a client-server protocol used by Microsoft Windows systems for sharing files, printers, and so on.

Samba is a free SMB server that runs on most Unix and Unix-like systems. It provides an implementation of an SMB client and server for use with non-Microsoft operating systems.

File Transfer Protocol

This is a method of transferring data from one computer to another over a network such as the Internet.

24.4 Before You Begin

Make sure the EMG2926-Q10A is connected to your network and turned on.

- 1 Connect the USB device to one of the EMG2926-Q10A's USB ports.
- 2 The EMG2926-Q10A detects the USB device and makes its contents available for browsing. If you are connecting a USB hard drive that comes with an external power supply, make sure it is connected to an appropriate power source that is on.

Note: If your USB device cannot be detected by the EMG2926-Q10A, see the troubleshooting for suggestions.

24.5 DLNA Screen

Use this screen to have the EMG2926-Q10A act as a DLNA-compliant media server that lets DLNA-compliant media clients on your network play video, music, and photos from the EMG2926-Q10A (without having to copy them to another computer). Click **Management > USB Media Sharing > DLNA**.

Figure 122 Management > USB Media Sharing > DLNA

The following table describes the labels in this screen.

Table 70 Management > USB Media Sharing > DLNA

LABEL	DESCRIPTION
Enable DLNA	Select this to have the EMG2926-Q10A function as a DLNA-compliant media server.
USB1/2	Select the media type that you want to share on the USB device connected to the EMG2926-Q10A's USB port.
Rescan	Click this button to have the EMG2926-Q10A scan the media files on the connected USB device and do indexing of the file list again so that DLNA clients can find the new files if any.
Apply	Click Apply to save your changes back to the EMG2926-Q10A.
Cancel	Click Cancel to begin configuring this screen afresh.

24.6 SAMBA Screen

Use this screen to set up file-sharing via the EMG2926-Q10A using Windows Explorer or the workgroup name. You can also configure the workgroup name and create file-sharing user accounts. Click **Management > USB Media Sharing > SAMBA**.

Figure 123 Management > USB Media Sharing > SAMBA

The following table describes the labels in this screen.

Table 71 Management > USB Media Sharing > SAMBA

LABEL	DESCRIPTION
Enable SAMBA	Select this to enable file sharing through the EMG2926-Q10A using Windows Explorer or by browsing to your work group.
Name	Specify the name to identify the EMG2926-Q10A in a work group.
Work Group	You can add the EMG2926-Q10A to an existing or a new workgroup on your network. Enter the name of the workgroup which your EMG2926-Q10A automatically joins. You can set the EMG2926-Q10A's workgroup name to be exactly the same as the workgroup name to which your computer belongs to. Note: The EMG2926-Q10A will not be able to join the workgroup if your local area network has restrictions set up that do not allow devices to join a workgroup. In this case, contact your network administrator.
Description	Enter the description of the EMG2926-Q10A in a work group.

Table 71 Management > USB Media Sharing > SAMBA (continued)

LABEL	DESCRIPTION
USB1/2	Specify the user's access rights to the USB storage device which is connected to the EMG2926-Q10A's USB port. Read & Write - The user has read and write rights, meaning that the user can create and edit the files on the connected USB device. Read - The user has read rights only and can not create or edit the files on the connected USB device.
User Accounts	Before you can share files you need a user account. Configure the following fields to set up a file-sharing account.
#	This is the index number of the user account.
Enable	This field displays whether a user account is activated or not. Select the check box to enable the account. Clear the check box to disable the account.
User Name	Enter a user name that will be allowed to access the shared files. You can enter up to 20 characters. Only letters and numbers allowed.
Password	Enter the password used to access the shared files. You can enter up to 20 characters. Only letters and numbers are allowed. The password is case sensitive.
USB1/2	Select the USB port(s) of the EMG2926-Q10A. The configured user can access the files on the USB device(s) connected to the selected USB port(s) only.
Apply	Click Apply to save your changes back to the EMG2926-Q10A.
Cancel	Click Cancel to begin configuring this screen afresh.

24.7 FTP Screen

Use this screen to set up file sharing via the EMG2926-Q10A using FTP and create user accounts. Click **Management > USB Media Sharing > FTP**.

Figure 124 Management > USB Media Sharing > FTP

FTP Setup

Enable FTP

Port

User Accounts							
#	Enable	User Name	Password	USB1	USB2	Upstream Bandwidth	Downstream Bandwidth
1	<input type="checkbox"/>	<input type="text"/>	<input type="text"/>	None ▼	None ▼	<input type="text"/> KBytes	<input type="text"/> KBytes
2	<input type="checkbox"/>	<input type="text"/>	<input type="text"/>	None ▼	None ▼	<input type="text"/> KBytes	<input type="text"/> KBytes
3	<input type="checkbox"/>	<input type="text"/>	<input type="text"/>	None ▼	None ▼	<input type="text"/> KBytes	<input type="text"/> KBytes
4	<input type="checkbox"/>	<input type="text"/>	<input type="text"/>	None ▼	None ▼	<input type="text"/> KBytes	<input type="text"/> KBytes
5	<input type="checkbox"/>	<input type="text"/>	<input type="text"/>	None ▼	None ▼	<input type="text"/> KBytes	<input type="text"/> KBytes

Apply Cancel

The following table describes the labels in this screen.

Table 72 Management > USB Media Sharing > FTP

LABEL	DESCRIPTION
Enable FTP	Select this to enable the FTP server on the EMG2926-Q10A for file sharing using FTP.
Port	You may change the server port number for FTP if needed, however you must use the same port number in order to use that service for file sharing.
User Accounts	Before you can share files you need a user account. Configure the following fields to set up a file-sharing account.
#	This is the index number of the user account.
Enable	This field displays whether a user account is activated or not. Select the check box to enable the account. Clear the check box to disable the account.
User Name	Enter a user name that will be allowed to access the shared files. You can enter up to 20 characters. Only letters and numbers allowed.
Password	Enter the password used to access the shared files. You can enter up to 20 characters. Only letters and numbers are allowed. The password is case sensitive.
USB1/2	Specify the user's access rights to the USB storage device which is connected to the EMG2926-Q10A's USB port. Read & Write - The user has read and write rights, meaning that the user can create and edit the files on the connected USB device. Read - The user has read rights only and can not create or edit the files on the connected USB device. None - The user cannot access the files on the USB device(s) connected to the USB port.
Upstream Bandwidth	Enter the maximum bandwidth (in Kbps) allowed for incoming FTP traffic.
Downstream Bandwidth	Enter the maximum bandwidth (in Kbps) allowed for outgoing FTP traffic.
Apply	Click Apply to save your changes back to the EMG2926-Q10A.
Cancel	Click Cancel to begin configuring this screen afresh.

24.8 Example of Accessing Your Shared Files From a Computer

You can use Windows Explorer or FTP to access the USB storage devices connected to the EMG2926-Q10A.

This example shows you how to use Microsoft's Windows XP to browse your shared files. Refer to your operating system's documentation for how to browse your file structure.

24.8.1 Use Windows Explorer to Share Files

You should have enabled file sharing and create a user account (Bob/1234 for example) with read and write access to USB 1 in the **USB Media Sharing > SAMBA** screen.

Open Windows Explorer to access the connected USB device using either Windows Explorer browser or by browsing to your workgroup.

- 1 In Windows Explorer's Address bar type a double backslash "\\ " followed by the IP address of the EMG2926-Q10A (the default IP address of the EMG2926-Q10A in router mode is 192.168.0.1) and press [ENTER]. A screen asking for password authentication appears. Type the user name and password (Bob and 1234 in this example) and click **OK**.

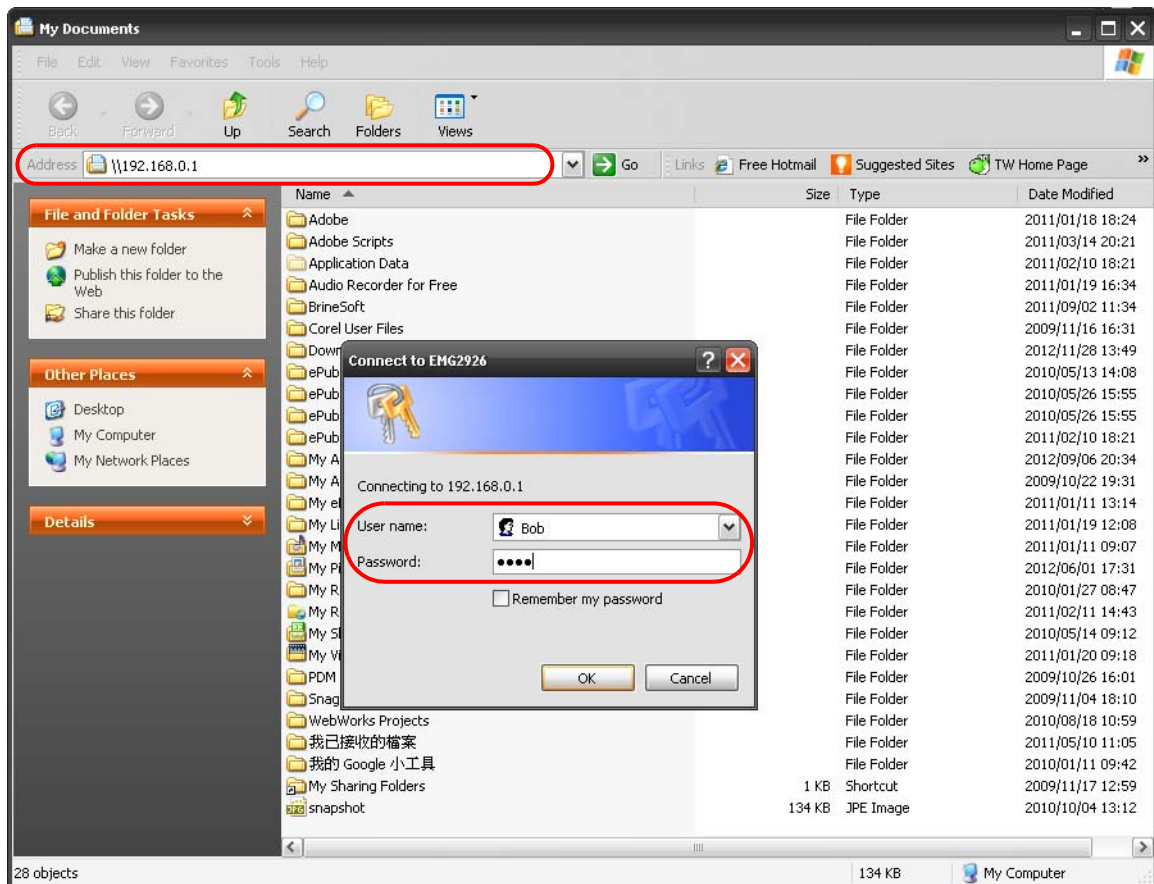

Note: Once you log into the shared folder via your EMG2926-Q10A, you do not have to relogin unless you restart your computer.

- 2 You can also use the workgroup name to access files by browsing to the workgroup folder using the folder tree on the left side of the screen. It is located under **My Network Places**. In this example the workgroup name is the default "Workgroup".

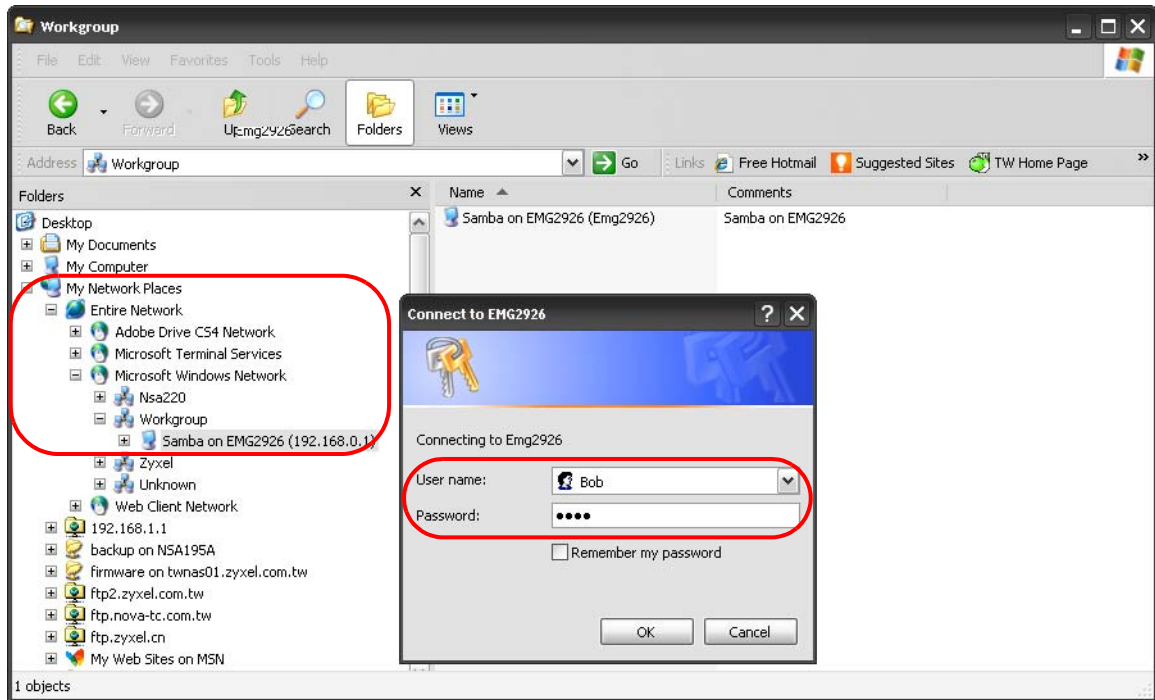

24.8.2 Use FTP to Share Files

You can use FTP to access the USB storage devices connected to the EMG2926-Q10A. In this example, we use the web browser to share files via FTP from the LAN. The way or screen you log into the FTP server (on the EMG2926-Q10A) varies depending on your FTP client. See your FTP client documentation for more information.

You should have enabled file sharing and create a user account (Bob/1234 for example) with read and write access to USB 1 in the **USB Media Sharing > FTP** screen.

- 1 In your web browser's address or URL bar type "ftp://" followed by the IP address of the EMG2926-Q10A (the default LAN IP address of the EMG2926-Q10A in router mode is 192.168.0.1) and click **Go** or press [ENTER].

- 2 A screen asking for password authentication appears. Enter the user name and password (you configured in the **USB Media Sharing > FTP** screen) and click **Log In**.

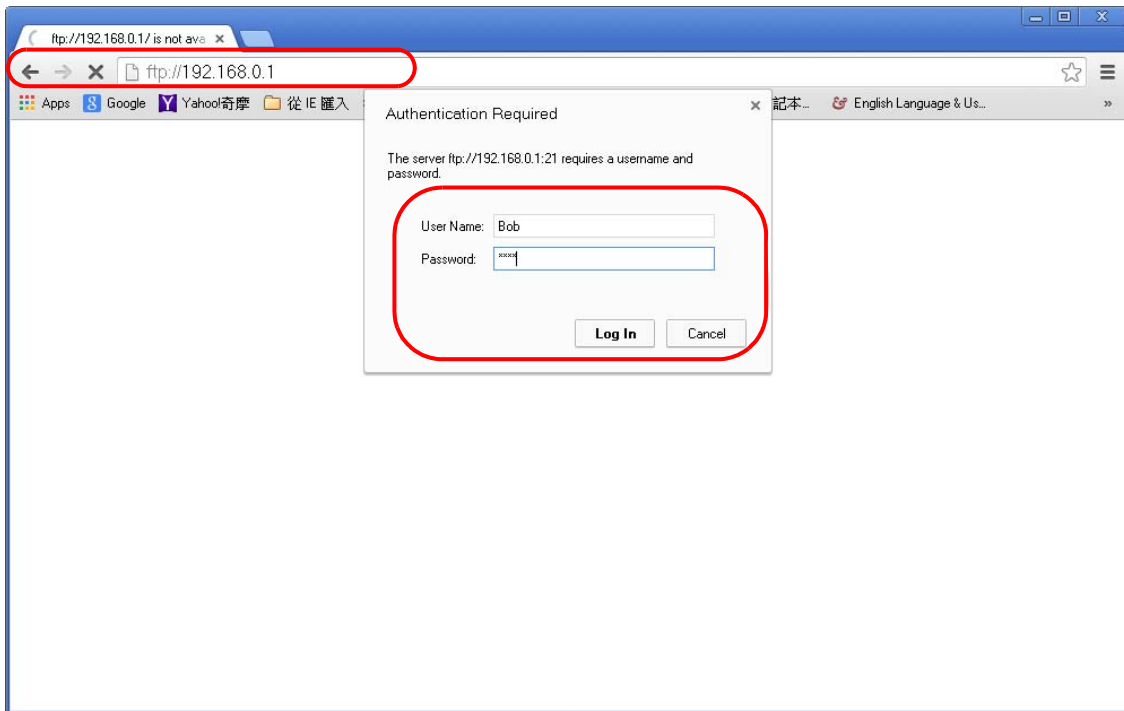

- 3 The screen changes and shows you the folder for the USB storage device connected to your EMG2926-Q10A. Double-click the folder to display the contents in it.

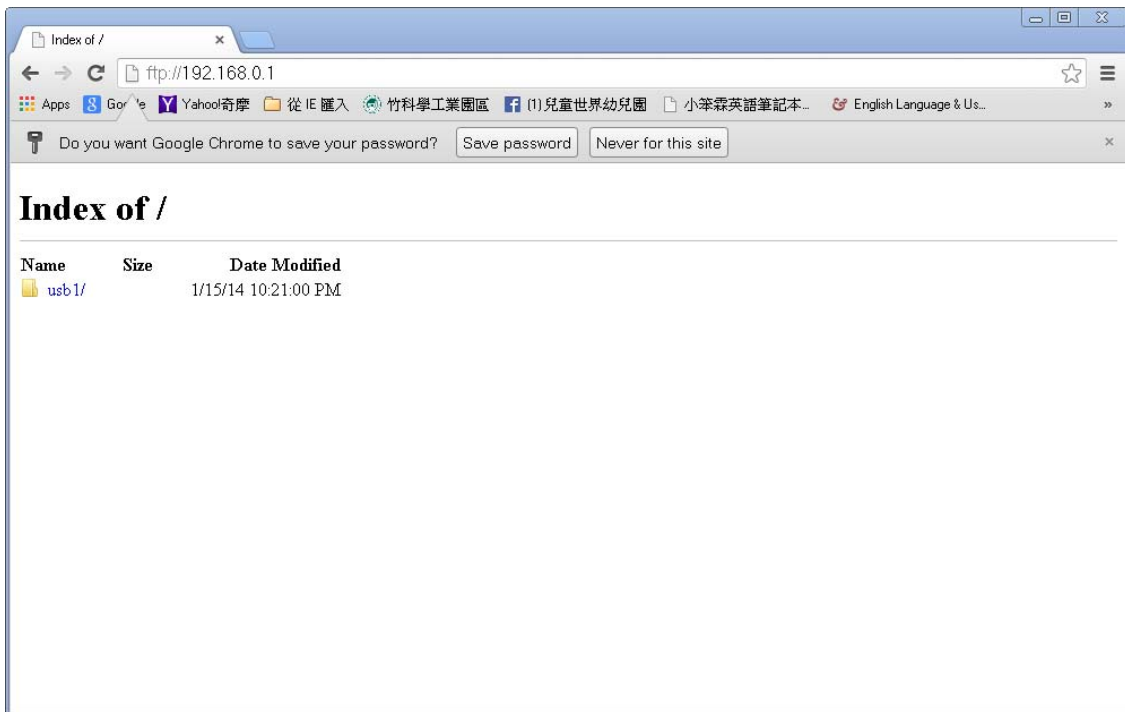

Port Configuration

25.1 Overview

The EMG2926-Q10A has 1000Base-T auto-negotiating Ethernet ports. In 10/100/1000 Mbps Gigabit Ethernet, the speed can be 10 Mbps, 100 Mbps or 1000 Mbps. The duplex mode can be both half or full duplex. An auto-negotiating port can detect and adjust to the optimum Ethernet speed (10/100/1000 Mbps) and duplex mode (full duplex or half duplex) of the connected device.

25.2 Port Configuration Screen

Use this screen to configure the EMG2926-Q10A port speed and duplex settings. Click **Configuration > Management > Port Configuration**.

Figure 125 Management > Port Configuration

The screenshot shows a 'Port Configuration' window with a title bar. Inside, there are five rows of port settings: WAN, LAN1, LAN2, LAN3, and LAN4. Each row contains a 'Speed' dropdown menu and a 'Duplex' dropdown menu, both currently set to 'Auto'. At the bottom of the window, there are two buttons: 'Apply' and 'Cancel'.

The following table describes the labels in this screen.

Table 73 Management > Port Configuration

LABEL	DESCRIPTION
WAN/LAN1~4	This field displays the Ethernet port of the EMG2926-Q10A.
Speed	Select the speed of the Ethernet connection on this port. The choices are Auto , 1000 , 100 and 10 . Selecting Auto (auto-negotiation) allows one port to negotiate with a peer port automatically to obtain the connection speed that both ends support. If the peer port does not support auto-negotiation or turns off this feature, the EMG2926-Q10A determines the connection speed by detecting the signal on the cable and using half duplex mode.

Table 73 Management > Port Configuration (continued)

LABEL	DESCRIPTION
Duplex	<p>Select the duplex mode of the Ethernet connection on this port. The choices are Auto, Full and Half.</p> <p>Selecting Auto (auto-negotiation) allows one port to negotiate with a peer port automatically to obtain the duplex mode that both ends support. If the peer port does not support auto-negotiation or turns off this feature, the EMG2926-Q10A determines the connection speed by detecting the signal on the cable and using half duplex mode.</p>
Apply	Click Apply to save your changes back to the EMG2926-Q10A.
Cancel	Click Cancel to begin configuring this screen afresh.

Maintenance

26.1 Overview

This chapter provides information on the **Maintenance** screens.

26.2 What You Can Do

- Use the **General** screen to set the timeout period of the management session ([Section 26.3 on page 179](#)).
- Use the **Account** screen to change your EMG2926-Q10A's system password ([Section 26.4 on page 180](#)).
- Use the **Time** screen to change your EMG2926-Q10A's time and date ([Section 26.5 on page 181](#)).
- ~~Use the **Firmware Upgrade** screen to upload firmware to your EMG2926-Q10A ([Section 26.6 on page 183](#)).~~
- Use the **Backup/Restore** screen to view information related to factory defaults, backup configuration, and restoring configuration ([Section 26.8 on page 186](#)).
- Use the **Restart** screen to reboot the EMG2926-Q10A without turning the power off ([Section 26.8 on page 186](#)).
- Use the **Language** screen to change the language for the Web Configurator ([Section 26.9 on page 186](#)).
- Use the **Sys OP Mode** screen to select how you want to use your EMG2926-Q10A ([Section 26.11 on page 188](#)).

26.3 General Screen

Use this screen to set the management session timeout period. Click **Maintenance > General**. The following screen displays.

Figure 126 Maintenance > General

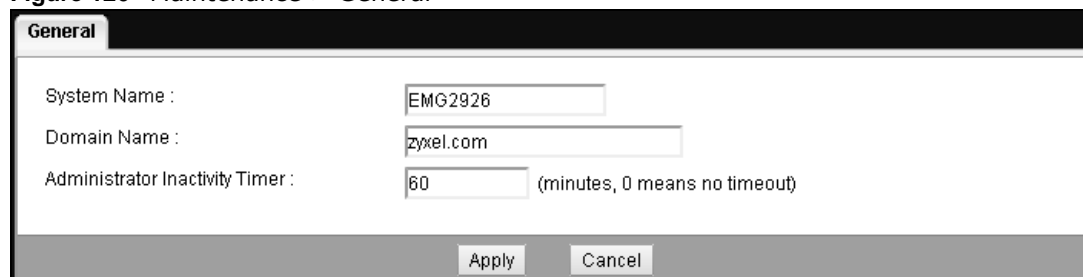

The screenshot shows a web configuration interface for the 'General' screen. It features three input fields: 'System Name' with the value 'EMG2926', 'Domain Name' with the value 'zyxel.com', and 'Administrator Inactivity Timer' with the value '60' and a note '(minutes, 0 means no timeout)'. At the bottom, there are 'Apply' and 'Cancel' buttons.

The following table describes the labels in this screen.

Table 74 Maintenance > General

LABEL	DESCRIPTION
System Name	System Name is a unique name to identify the EMG2926-Q10A in an Ethernet network.
Domain Name	Enter the domain name you want to give to the EMG2926-Q10A.
Administrator Inactivity Timer	Type how many minutes a management session can be left idle before the session times out. The default is 5 minutes. After it times out you have to log in with your password again. Very long idle timeouts may have security risks. A value of "0" means a management session never times out, no matter how long it has been left idle (not recommended).
Apply	Click Apply to save your changes back to the EMG2926-Q10A.
Cancel	Click Cancel to begin configuring this screen afresh.

26.4 Account Screen

It is strongly recommended that you [change the password of the user account](#).

If you forget [your login account password](#) (or IP address), you will need to reset the device. See [Section 26.8 on page 186](#) for details.

Click **Maintenance > Account**. The screen appears as shown.

Figure 127 Maintenance > Account

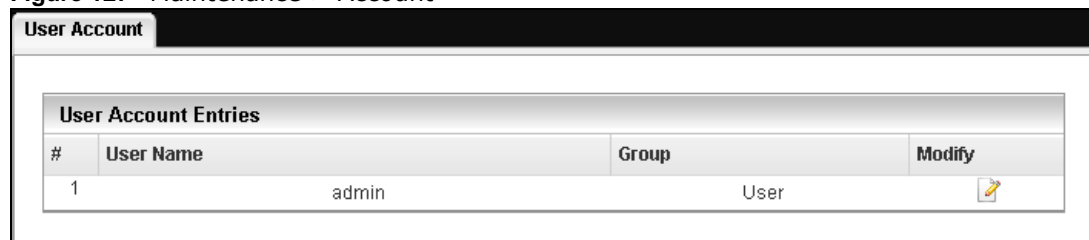

The following table describes the labels in this screen.

Table 75 Maintenance > Account

LABEL	DESCRIPTION
#	This the index number of the entry.
User Name	This field displays the name of the user.
Group	This field displays the login account type of the user. Different login account types have different privilege levels. The web configurator screens and privileges vary depending on which account type you use to log in.
Modify	Click the Edit icon to go to the screen where you can edit the account.

26.4.1 Edit a Users Account

Use this screen to edit a users account. Click the **Edit** icon next to the user account you want to edit. The **Account Setup** screen displays as shown.

Figure 128 Maintenance > Account > Edit

The screenshot shows a web interface titled "Account Setup". It contains the following fields and controls:

- Username :** A text input field containing the text "admin".
- Old Password :** An empty text input field.
- New Password :** An empty text input field.
- Retype to Confirm :** An empty text input field.
- Group :** A dropdown menu with "User" selected.
- Buttons:** "Apply" and "Cancel" buttons are located at the bottom right of the form area.

The following table describes the labels in this screen.

Table 76 Maintenance > Account > Edit

LABEL	DESCRIPTION
Username	Enter a descriptive name for the user account. The user name can be up to 15 alphanumeric characters (0-9, A-Z, a-z, -, _ with no spaces). With advanced account security enabled, the user names must be a minimum length of six characters and include both letters and numbers.
Old Password	Type the default password or the existing password you use to access the system in this field.
New Password	Type your new system password (up to 30 characters). Note that as you type a password, the screen displays an asterisk (*) for each character you type.
Retype to Confirm	Type the new password again in this field.
Group	This is the account type of the user. The web configurator screens and privileges vary depending on which account type you use to log in. Administrator accounts can configure the EMG2926-Q10A and upgrade firmware while User accounts cannot do firmware upgrading.
Apply	Click Apply to save your changes back to the EMG2926-Q10A.
Cancel	Click Cancel to begin configuring this screen afresh.

26.5 Time Setting Screen

Use this screen to configure the EMG2926-Q10A's time based on your local time zone. To change your EMG2926-Q10A's time and date, click **Maintenance > Time**. The screen appears as shown.

Figure 129 Maintenance > Time

The following table describes the labels in this screen.

Table 77 Maintenance > Time

LABEL	DESCRIPTION
Current Time and Date	
Current Time	This field displays the time of your EMG2926-Q10A. Each time you reload this page, the EMG2926-Q10A synchronizes the time with the time server.
Current Date	This field displays the date of your EMG2926-Q10A. Each time you reload this page, the EMG2926-Q10A synchronizes the date with the time server.
Current Time and Date	
Manual	Select this radio button to enter the time and date manually. If you configure a new time and date, Time Zone and Daylight Saving at the same time, the new time and date you entered has priority and the Time Zone and Daylight Saving settings do not affect it.
New Time (hh:mm:ss)	This field displays the last updated time from the time server or the last time configured manually. When you select Manual , enter the new time in this field and then click Apply .
New Date (yyyy/mm/dd)	This field displays the last updated date from the time server or the last date configured manually. When you select Manual , enter the new date in this field and then click Apply .
Get from Time Server	Select this radio button to have the EMG2926-Q10A get the time and date from the time server you specified below.

Table 77 Maintenance > Time (continued)

LABEL	DESCRIPTION
User Defined Time Server Address	Select User Defined Time Server Address and enter the IP address or URL (up to 20 extended ASCII characters in length) of your time server. Check with your ISP/network administrator if you are unsure of this information.
Time Zone Setup	
Time Zone	Choose the time zone of your location. This will set the time difference between your time zone and Greenwich Mean Time (GMT).
Daylight Savings	Daylight saving is a period from late spring to early fall when many countries set their clocks ahead of normal local time by one hour to give more daytime light in the evening. Select this option if you use Daylight Saving Time.
Start Date	Configure the day and time when Daylight Saving Time starts if you selected Daylight Savings . The at field uses the 24 hour format. Here are a couple of examples: Daylight Saving Time starts in most parts of the United States on the second Sunday of March. Each time zone in the United States starts using Daylight Saving Time at 2 A.M. local time. So in the United States you would select Second, Sunday, March and select 2 in the at field. Daylight Saving Time starts in the European Union on the last Sunday of March. All of the time zones in the European Union start using Daylight Saving Time at the same moment (1 A.M. GMT or UTC). So in the European Union you would select Last, Sunday, March . The time you select in the at field depends on your time zone. In Germany for instance, you would select 2 because Germany's time zone is one hour ahead of GMT or UTC (GMT+1).
End Date	Configure the day and time when Daylight Saving Time ends if you selected Daylight Savings . The at field uses the 24 hour format. Here are a couple of examples: Daylight Saving Time ends in the United States on the first Sunday of November. Each time zone in the United States stops using Daylight Saving Time at 2 A.M. local time. So in the United States you would select First, Sunday, November and select 2 in the at field. Daylight Saving Time ends in the European Union on the last Sunday of October. All of the time zones in the European Union stop using Daylight Saving Time at the same moment (1 A.M. GMT or UTC). So in the European Union you would select Last, Sunday, October . The time you select in the at field depends on your time zone. In Germany for instance, you would select 2 because Germany's time zone is one hour ahead of GMT or UTC (GMT+1).
Apply	Click Apply to save your changes back to the EMG2926-Q10A.
Cancel	Click Cancel to begin configuring this screen afresh.

26.6 ~~Firmware Upgrade Screen~~

~~Find firmware at www.zyxel.com in a file that uses the version number and project code with a "*.bin" extension, e.g., "V1.00(AAKG.0).bin". The upload process uses HTTP (Hypertext Transfer Protocol) and may take up to two minutes. After a successful upload, the system will reboot.~~

~~Click **Maintenance** > **Firmware Upgrade**. Follow the instructions in this screen to upload firmware to your EMG2926-Q10A.~~

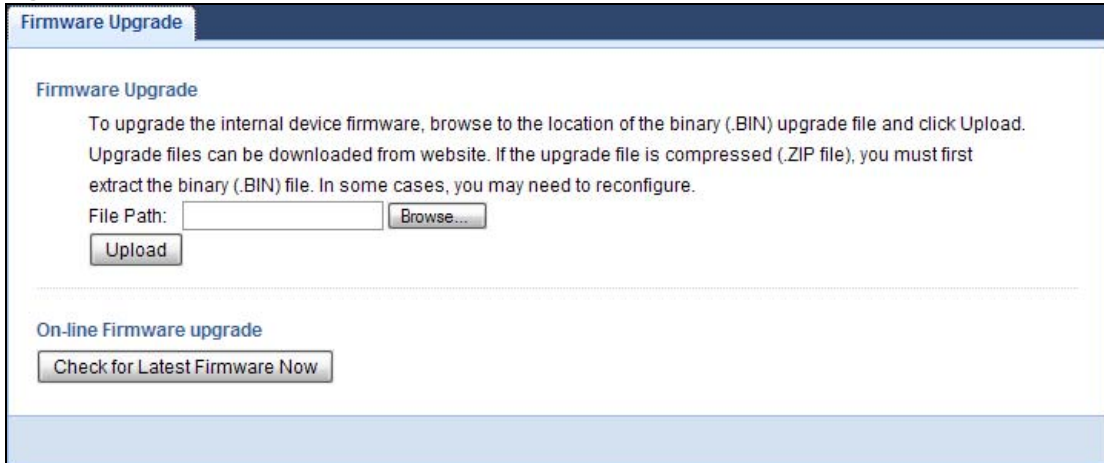
Figure 130 Maintenance > Firmware Upgrade

The following table describes the labels in this screen.

Table 78 Maintenance > Firmware Upgrade

LABEL	DESCRIPTION
File Path	Type in the location of the file you want to upload in this field or click Browse... to find it.
Browse...	Click Browse... to find the .bin file you want to upload. Remember that you must decompress compressed (.zip) files before you can upload them.
Upload	Click Upload to begin the upload process. This process may take up to two minutes.
Check for Latest Firmware Now	Click this to check for the latest updated firmware.

Note: **Do not turn off the EMG2926-Q10A while firmware upload is in progress!**

After you see the **Firmware Upload In Process** screen, wait two minutes before logging into the EMG2926-Q10A again.

The EMG2926-Q10A automatically restarts in this time causing a temporary network disconnect. In some operating systems, you may see the following icon on your desktop.

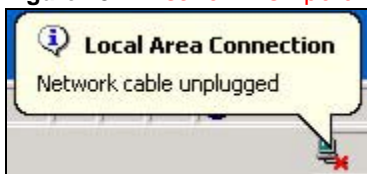
Figure 131 Network Temporarily Disconnected

After two minutes, log in again and check your new firmware version in the **Status** screen.

If the upload was not successful, an error message appears. Click **Return** to go back to the **Firmware Upgrade** screen.

26.7 Configuration Backup/Restore Screen

Backup configuration allows you to back up (save) the EMG2926-Q10A's current configuration to a file on your computer. Once your EMG2926-Q10A is configured and functioning properly, it is highly recommended that you back up your configuration file before making configuration changes. The backup configuration file will be useful in case you need to return to your previous settings.

Restore configuration allows you to upload a new or previously saved configuration file from your computer to your EMG2926-Q10A.

Click **Maintenance > Backup/Restore**. Information related to factory defaults, backup configuration, and restoring configuration appears as shown next.

Figure 132 Maintenance > Backup/Restore

Backup/Restore

Backup Configuration
Click Backup to save the current configuration of your system to your computer.

Restore Configuration
To restore a previously saved configuration file to your system, browse to the location of the configuration file and click Upload.
File Path : No file chosen

Back to Factory Defaults
Click Reset to clear all user-entered configuration information and return to factory defaults. After resetting, the
 - Password will be (blank)
 - LAN IP address will be 192.168.0.1
 - DHCP will be reset to server

The following table describes the labels in this screen.

Table 79 Maintenance > Backup/Restore

LABEL	DESCRIPTION
Backup	Click Backup to save the EMG2926-Q10A's current configuration to your computer.
File Path	Type in the location of the file you want to upload in this field or click Browse... to find it.
Choose File	Click Choose File to find the file you want to upload. Remember that you must decompress compressed (.ZIP) files before you can upload them.

Table 79 Maintenance > Backup/Restore (continued)

LABEL	DESCRIPTION
Upload	<p>Click Upload to begin the upload process.</p> <p>Note: Do not turn off the EMG2926-Q10A while configuration file upload is in progress.</p> <p>After you see a "configuration upload successful" screen, you must then wait one minute before logging into the EMG2926-Q10A again. The EMG2926-Q10A automatically restarts in this time causing a temporary network disconnect.</p> <p>If you see an error screen, click Back to return to the Backup/Restore screen.</p>
Reset	<p>Pressing the Reset button in this section clears all user-entered configuration information and returns the EMG2926-Q10A to its factory defaults.</p> <p>You can also press the RESET button on the rear panel to reset the factory defaults of your EMG2926-Q10A. Refer to the chapter about introducing the Web Configurator for more information on the RESET button.</p>

Note: If you uploaded the default configuration file you may need to change the IP address of your computer to be in the same subnet as that of the default [EMG2926-Q10A IP address \(192.168.0.1\)](#). See [Appendix B on page 193](#) for details on how to set up your computer's IP address.

26.8 Restart Screen

System restart allows you to reboot the EMG2926-Q10A without turning the power off.

Click **Maintenance > Restart** to open the following screen.

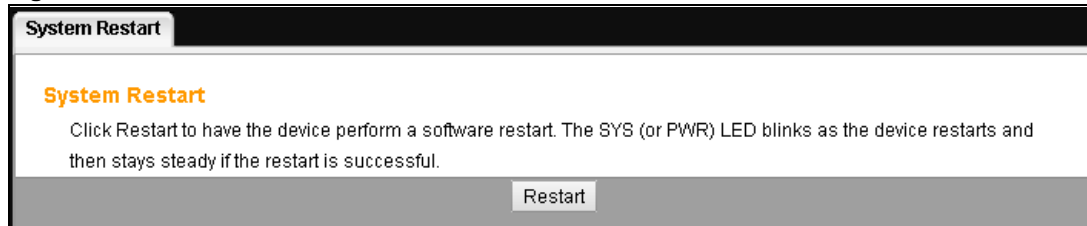
Figure 133 Maintenance > Restart

Click **Restart** to have the EMG2926-Q10A reboot. This does not affect the EMG2926-Q10A's configuration.

26.9 Language Screen

Use this screen to change the language for the Web Configurator.

Select the language you prefer and click **Apply**. The Web Configurator language changes after a while without restarting the EMG2926-Q10A.

Figure 134 Maintenance > Language

The screenshot shows a web interface for language selection. At the top, there is a tab labeled 'Language'. Below it, the text 'Language selection :' is followed by a dropdown menu currently showing 'English'. At the bottom of the interface, there are two buttons: 'Apply' and 'Cancel'.

26.10 System Operation Mode Overview

The **Sys OP Mode** (System Operation Mode) function lets you configure your EMG2926-Q10A as a router or access point. You can choose between **Router Mode**, and **Access Point Mode** depending on your network topology and the features you require from your device.

The following describes the device modes available in your EMG2926-Q10A.

Router

A router connects your local network with another network, such as the Internet. The router has two IP addresses, the LAN IP address and the WAN IP address.

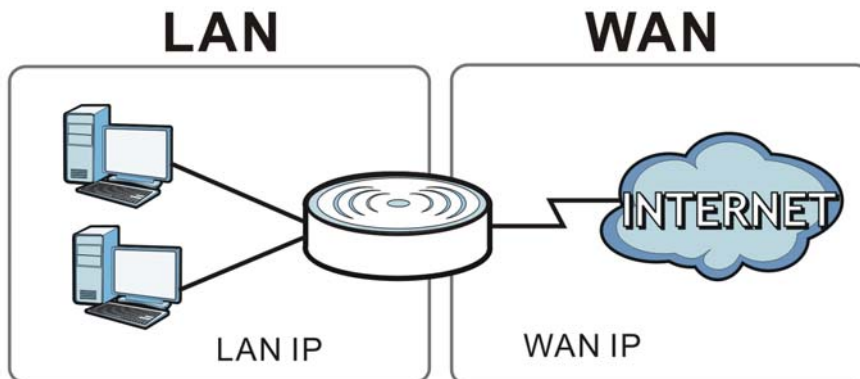
Figure 135 LAN and WAN IP Addresses in Router Mode

Access Point

An access point enabled all ethernet ports to be bridged together and be in the same subnet. To connect to the Internet, another device, such as a router, is required.

Figure 136 Access Point Mode

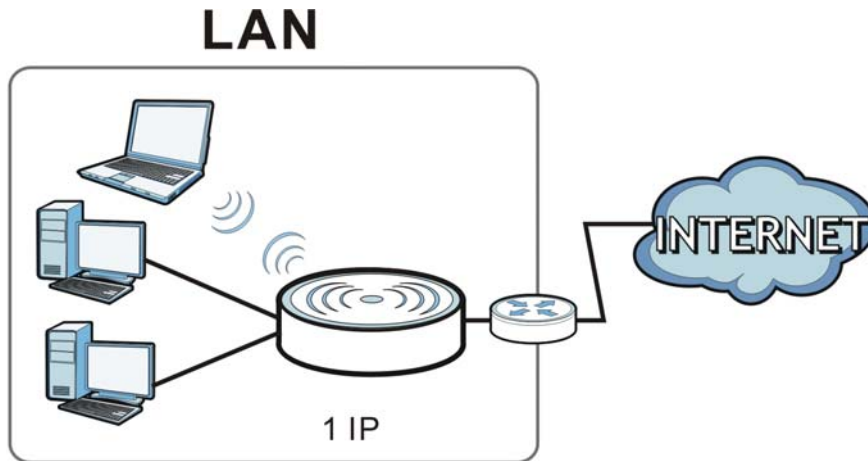

26.11 Sys OP Mode Screen

Use this screen to select how you want to use your EMG2926-Q10A.

Figure 137 Maintenance > Sys OP Mode

The screenshot shows the "Sys OP Mode" configuration screen. Under "Configuration Mode", there are two radio buttons: "Router Mode" (selected) and "Access Point Mode". Below this is a "Note" section with the following text:

Router: In this mode, the device is supported to connect to the internet via an ADSL/Cable Modem. PCs in LAN ports share the same IP to ISP through the WAN Port.

Access Point: In this mode, all Ethernet ports are bridged together. The device allows the wireless-equipped computer communicate with a wired network.

At the bottom of the screen are "Apply" and "Cancel" buttons.

The following table describes the labels in the **General** screen.

Table 80 Maintenance > Sys OP Mode

LABEL	DESCRIPTION
Configuration Mode	
Router Mode	Select Router Mode if your device routes traffic between a local network and another network such as the Internet. This mode offers services such as a firewall or bandwidth management. You can configure the IP address settings on your WAN port. Contact your ISP or system administrator for more information on appropriate settings.

Table 80 Maintenance > Sys OP Mode (continued)

LABEL	DESCRIPTION
Access Point Mode	<p>Select Access Point Mode if your device bridges traffic between clients on the same network.</p> <ul style="list-style-type: none">• In Access Point Mode, all Ethernet ports have the same IP address.• All ports on the rear panel of the device are LAN ports, including the port labeled WAN. There is no WAN port.• The DHCP server on your device is disabled.• Router functions (such as NAT, bandwidth management, remote management, firewall and so on) are not available when the EMG2926-Q10A is in Access Point Mode.• The IP address of the device on the local network is set to 192.168.0.2.
Apply	Click Apply to save your settings.
Cancel	Click Cancel to return your settings to the default (Router).

Note: If you select the incorrect system operation Mode you may not be able to connect to the Internet.

Troubleshooting

27.1 Overview

This chapter offers some suggestions to solve problems you might encounter. The potential problems are divided into the following categories.

- [Power, Hardware Connections, and LEDs](#)
- [EMG2926-Q10A Access and Login](#)
- [Internet Access](#)
- [Resetting the EMG2926-Q10A to Its Factory Defaults](#)
- [Wireless Connections](#)
- [USB Device Problems](#)
- [ZyXEL Share Center Utility Problems](#)

27.2 Power, Hardware Connections, and LEDs

The EMG2926-Q10A does not turn on. None of the LEDs turn on.

- 1 Make sure you are using the power adaptor or cord included with the EMG2926-Q10A.
- 2 Make sure the power adaptor or cord is connected to the EMG2926-Q10A and plugged in to an appropriate power source. Make sure the power source is turned on.
- 3 Disconnect and re-connect the power adaptor or cord to the EMG2926-Q10A.
- 4 If the problem continues, contact the vendor.

One of the LEDs does not behave as expected.

- 1 Make sure you understand the normal behavior of the LED. See [Section 1.7 on page 15](#).
- 2 Check the hardware connections. See the Quick Start Guide.
- 3 Inspect your cables for damage. Contact the vendor to replace any damaged cables.

- 4 Disconnect and re-connect the power adaptor to the EMG2926-Q10A.
- 5 If the problem continues, contact the vendor.

27.3 EMG2926-Q10A Access and Login

I don't know the IP address of my EMG2926-Q10A.

- 1 The default IP address of the EMG2926-Q10A in **Router Mode** is **192.168.0.1**. The default IP address of the EMG2926-Q10A in **Access Point Mode** is **192.168.0.2**.
- 2 If you changed the IP address and have forgotten it, you might get the IP address of the EMG2926-Q10A in **Router Mode** by looking up the IP address of the default gateway for your computer. To do this in most Windows computers, click **Start > Run**, enter **cmd**, and then enter **ipconfig**. The IP address of the **Default Gateway** might be the IP address of the EMG2926-Q10A (it depends on the network), so enter this IP address in your Internet browser.
- 3 If your EMG2926-Q10A in **Access Point Mode** is a DHCP client, you can find your IP address from the DHCP server. This information is only available from the DHCP server which allocates IP addresses on your network. Find this information directly from the DHCP server or contact your system administrator for more information.
- 4 Reset your EMG2926-Q10A to change all settings back to their default. This means your current settings are lost. See [Section 27.5 on page 194](#) in the **Troubleshooting** for information on resetting your EMG2926-Q10A.

~~I forgot the password.~~

- 1 ~~The default password is **1234**.~~
- 2 ~~If this does not work, you have to reset the device to its factory defaults. See [Section 27.5 on page 194](#).~~

I cannot see or access the **Login** screen in the Web Configurator.

- 1 Make sure you are using the correct IP address.
 - The default IP address of the EMG2926-Q10A in **Router Mode** is **192.168.0.1**. The default IP address of the EMG2926-Q10A in **Access Point Mode** is **192.168.0.2**.
 - If you changed the IP address ([Section 12.4 on page 110](#)), use the new IP address.
 - If you changed the IP address and have forgotten it, see the troubleshooting suggestions for [I don't know the IP address of my EMG2926-Q10A](#).

- 2 Check the hardware connections, and make sure the LEDs are behaving as expected. See the Quick Start Guide.
- 3 Make sure your Internet browser does not block pop-up windows and has JavaScript and Java enabled. See [Appendix A on page 184](#).
- 4 Make sure your computer is in the same subnet as the EMG2926-Q10A. (If you know that there are routers between your computer and the EMG2926-Q10A, skip this step.)
 - If there is a DHCP server on your network, make sure your computer is using a dynamic IP address. See [Section 12.4 on page 110](#).
 - If there is no DHCP server on your network, make sure your computer's IP address is in the same subnet as the EMG2926-Q10A. See [Section 12.4 on page 110](#).
- 5 Reset the device to its factory defaults, and try to access the EMG2926-Q10A with the default IP address. See [Section 1.5 on page 14](#).
- 6 If the problem continues, contact the network administrator or vendor, or try one of the advanced suggestions.

Advanced Suggestions

- Try to access the EMG2926-Q10A using another service, such as Telnet. If you can access the EMG2926-Q10A, check the remote management settings and firewall rules to find out why the EMG2926-Q10A does not respond to HTTP.
- If your computer is connected to the **WAN** port or is connected wirelessly, use a computer that is connected to a **LAN/ETHERNET** port.

I can see the **Login** screen, but I cannot log in to the EMG2926-Q10A.

- 1 ~~Make sure you have entered the password correctly. The default password is **1234**. This field is case sensitive, so make sure [Caps Lock] is not on.~~
- 2 This can happen when you fail to log out properly from your last session. Try logging in again after 5 minutes.
- 3 Disconnect and re-connect the power adaptor or cord to the EMG2926-Q10A.
- 4 If this does not work, you have to reset the device to its factory defaults. See [Section 27.5 on page 194](#).

27.4 Internet Access

I cannot access the Internet.

- 1 Check the hardware connections, and make sure the LEDs are behaving as expected. See the Quick Start Guide.
- 2 Go to **Maintenance > Sys OP Mode**. Check your System Operation Mode setting.
 - If the EMG2926-Q10A is in **Router Mode**, make sure the WAN port is connected to a broadband modem or router with Internet access. Your computer and the EMG2926-Q10A should be in the same subnet.
 - If the EMG2926-Q10A is in **Access Point Mode**, make sure the WAN port is connected to a broadband modem or router with Internet access and your computer is set to obtain an dynamic IP address.
- 3 If the EMG2926-Q10A is in **Router Mode**, make sure you entered your ISP account information correctly in the wizard or the WAN screen. These fields are case-sensitive, so make sure [Caps Lock] is not on.
- 4 If you are trying to access the Internet wirelessly, make sure the wireless settings in the wireless client are the same as the settings in the AP.
- 5 Disconnect all the cables from your device, and follow the directions in the Quick Start Guide again.
- 6 If the problem continues, contact your ISP.

I cannot access the Internet anymore. I had access to the Internet (with the EMG2926-Q10A), but my Internet connection is not available anymore.

- 1 Check the hardware connections, and make sure the LEDs are behaving as expected. See the Quick Start Guide and [Section 1.7 on page 15](#).
- 2 Reboot the EMG2926-Q10A.
- 3 If the problem continues, contact your ISP.

The Internet connection is slow or intermittent.

- 1 There might be a lot of traffic on the network. Look at the LEDs, and check [Section 1.7 on page 15](#). If the EMG2926-Q10A is sending or receiving a lot of information, try closing some programs that use the Internet, especially peer-to-peer applications.
- 2 Check the signal strength. If the signal strength is low, try moving the EMG2926-Q10A closer to the AP if possible, and look around to see if there are any devices that might be interfering with the wireless network (for example, microwaves, other wireless networks, and so on).
- 3 Reboot the EMG2926-Q10A.
- 4 If the problem continues, contact the network administrator or vendor, or try one of the advanced suggestions.

Advanced Suggestion

- Check the settings for QoS. If it is disabled, you might consider activating it.

27.5 Resetting the EMG2926-Q10A to Its Factory Defaults

If you reset the EMG2926-Q10A, you lose all of the changes you have made. The EMG2926-Q10A re-loads its default settings, and the password resets to **1234**. You have to make all of your changes again.

You will lose all of your changes when you push the **RESET** button.

To reset the EMG2926-Q10A:

- 1 Make sure the power LED is on.
- 2 Press the **RESET** button for one to four seconds to restart/reboot the EMG2926-Q10A.
- 3 Press the **RESET** button for longer than five seconds to set the EMG2926-Q10A back to its factory-default configurations.

If the EMG2926-Q10A restarts automatically, wait for the EMG2926-Q10A to finish restarting, and log in to the Web Configurator. The password is "1234".

If the EMG2926-Q10A does not restart automatically, disconnect and reconnect the EMG2926-Q10A's power. Then, follow the directions above again.

27.6 Wireless Connections

I cannot access the EMG2926-Q10A or ping any computer from the WLAN.

- 1 Make sure the wireless LAN is enabled on the EMG2926-Q10A.
- 2 Make sure the wireless adapter on your computer is working properly.
- 3 Make sure the wireless adapter installed on your computer is IEEE 802.11 compatible and supports the same wireless standard as the EMG2926-Q10A.
- 4 Make sure your computer (with a wireless adapter installed) is within the transmission range of the EMG2926-Q10A.
- 5 Check that both the EMG2926-Q10A and the wireless adapter on your computer are using the same wireless and wireless security settings.

- 6 Make sure traffic between the WLAN and the LAN is not blocked by the firewall on the EMG2926-Q10A.
- 7 Make sure you allow the EMG2926-Q10A to be remotely accessed through the WLAN interface. Check your remote management settings.
 - See the chapter on [Wireless LAN](#) in the User's Guide for more information.

I set up URL keyword blocking, but I can still access a website that should be blocked.

Make sure that you select the **Enable URL Keyword Blocking** check box in the Content Filtering screen. Make sure that the keywords that you type are listed in the **Keyword List**.

If a keyword that is listed in the **Keyword List** is not blocked when it is found in a URL, customize the keyword blocking using commands. See the [Customizing Keyword Blocking URL Checking](#) section in the [Content Filtering](#) chapter.

I cannot access the Web Configurator after I switched to AP mode.

When you change from router mode to AP mode, your computer must have an IP address in the range between "192.168.0.3" and "192.168.0.254".

Refer to [Appendix B on page 193](#) for instructions on how to change your computer's IP address.

What factors may cause intermittent or unstabled wireless connection? How can I solve this problem?

The following factors may cause interference:

- Obstacles: walls, ceilings, furniture, and so on.
- Building Materials: metal doors, aluminum studs.
- Electrical devices: microwaves, monitors, electric motors, cordless phones, and other wireless devices.

To optimize the speed and quality of your wireless connection, you can:

- Move your wireless device closer to the AP if the signal strength is low.
- Reduce wireless interference that may be caused by other wireless networks or surrounding wireless electronics such as cordless phones.
- Place the AP where there are minimum obstacles (such as walls and ceilings) between the AP and the wireless client.
- Reduce the number of wireless clients connecting to the same AP simultaneously, or add additional APs if necessary.

- Try closing some programs that use the Internet, especially peer-to-peer applications. If the wireless client is sending or receiving a lot of information, it may have too many programs open that use the Internet.
- Position the antennas for best reception. If the AP is placed on a table or floor, point the antennas upwards. If the AP is placed at a high position, point the antennas downwards. Try pointing the antennas in different directions and check which provides the strongest signal to the wireless clients.

27.7 USB Device Problems

I cannot access or see a USB device that is connected to the EMG2926-Q10A.

- 1 Disconnect the problematic USB device, then reconnect it to the EMG2926-Q10A.
- 2 Ensure that the USB device has power.
- 3 Check your cable connections.
- 4 Restart the EMG2926-Q10A by disconnecting the power and then reconnecting it.
- 5 If the USB device requires a special driver, install the driver from the installation disc that came with the device. After driver installation, reconnect the USB device to the EMG2926-Q10A and try to connect to it again with your computer.
- 6 If the problem persists, contact your vendor.

What kind of USB devices do the EMG2926-Q10A support?

- 1 It is strongly recommended to use version 2.0 or lower USB storage devices (such as memory sticks, USB hard drives) and/or USB devices (such as USB printers). Other USB products are not guaranteed to function properly with the EMG2926-Q10A.

27.8 ZyXEL Share Center Utility Problems

I cannot access or see a USB device that is connected to the EMG2926-Q10A.

- 1 Disconnect the problematic USB device, then reconnect it to the EMG2926-Q10A.
- 2 Ensure that the USB device in question has power.

- 3 Check your cable connections.
- 4 Restart the EMG2926-Q10A by disconnecting the power and then reconnecting it.
- 5 If the USB device requires a special driver, install the driver from the installation disc that came with the device. After driver installation, reconnect the USB device to the EMG2926-Q10A and try to connect to it again with your computer.
- 6 If the problem persists, contact your vendor.

I cannot install the ZyXEL Share Center Utility.

- 1 Make sure that the set up program is one required for your operating system.
- 2 Install the latest patches and updates for your operating system.
- 3 Check the zyxel.com download site for a newer version of the utility.

Legal Information

Copyright

Copyright © 2014 by ZyXEL Communications Corporation.

The contents of this publication may not be reproduced in any part or as a whole, transcribed, stored in a retrieval system, translated into any language, or transmitted in any form or by any means, electronic, mechanical, magnetic, optical, chemical, photocopying, manual, or otherwise, without the prior written permission of ZyXEL Communications Corporation.

Published by ZyXEL Communications Corporation. All rights reserved.

Disclaimer

ZyXEL does not assume any liability arising out of the application or use of any products, or software described herein. Neither does it convey any license under its patent rights nor the patent rights of others. ZyXEL further reserves the right to make changes in any products described herein without notice. This publication is subject to change without notice.

Trademarks

Trademarks mentioned in this publication are used for identification purposes only and may be properties of their respective owners.

Certifications

Federal Communications Commission (FCC) Interference Statement

The device complies with Part 15 of FCC rules. Operation is subject to the following two conditions:

- This device may not cause harmful interference.
- This device must accept any interference received, including interference that may cause undesired operations.

This device has been tested and found to comply with the limits for a Class B digital device pursuant to Part 15 of the FCC Rules. These limits are designed to provide reasonable protection against harmful interference in a residential installation. This device generates, uses, and can radiate radio frequency energy, and if not installed and used in accordance with the instructions, may cause harmful interference to radio communications. However, there is no guarantee that interference will not occur in a particular installation.

If this device does cause harmful interference to radio/television reception, which can be determined by turning the device off and on, the user is encouraged to try to correct the interference by one or more of the following measures:

- 1 Reorient or relocate the receiving antenna.
- 2 Increase the separation between the equipment and the receiver.
- 3 Connect the equipment into an outlet on a circuit different from that to which the receiver is connected.
- 4 Consult the dealer or an experienced radio/TV technician for help.

FCC Caution: Any changes or modifications not expressly approved by the party responsible for compliance could void the user's authority to operate this equipment.



FCC Radiation Exposure Statement

- This transmitter must not be co-located or operating in conjunction with any other antenna or transmitter.
- IEEE 802.11b, 802.11g or 802.11n (20MHz) operation of this product in the U.S.A. is firmware-limited to channels 1 through 11. IEEE 802.11n (40MHz) operation of this product in the U.S.A. is firmware-limited to channels 3 through 9.
- To comply with FCC RF exposure compliance requirements, a separation distance of at least 20 cm must be maintained between the antenna of this device and all persons.
- Per FCC regulation, all WiFi product marketed in US must fixed to US operation channels only.
- Operations in the 5.15-5.25GHz band are restricted to indoor usage only.

Industry Canada Statement

This device complies with Industry Canada license-exempt RSS standard(s). Operation is subject to the following two conditions:

- (1) this device may not cause interference, and
- (2) this device must accept any interference, including interference that may cause undesired operation of the device.

Le présent appareil est conforme aux CNR d'Industrie Canada applicables aux appareils radio exempts de licence. L'exploitation est autorisée aux deux conditions suivantes : (1) l'appareil ne doit pas produire de brouillage, et (2) l'utilisateur de l'appareil doit accepter tout brouillage radioélectrique subi, même si le brouillage est susceptible d'en compromettre le fonctionnement.

For product available in the USA/Canada market, only channel 1~11 can be operated. Selection of other channels is not possible.

Pour les produits disponibles aux États-Unis / Canada du marché, seul le canal 1 à 11 peuvent être exploités. Sélection d'autres canaux n'est pas possible.

This device and its antennas(s) must not be co-located or operating in conjunction with any other antenna or transmitter except in accordance with IC multi-transmitter product procedures.

Cet appareil et son antenne (s) ne doit pas être co-localisés ou fonctionnement en association avec une autre antenne ou transmetteur.

Caution :

(i) the device for operation in the band 5150-5250 MHz is only for indoor use to reduce the potential for harmful interference to co-channel mobile satellite systems;

(ii) high-power radars are allocated as primary users (i.e. priority users) of the bands 5250-5350 MHz and 5650-5850 MHz and that these radars could cause interference and/or damage to LE-LAN devices.

Avertissement:

(i) les dispositifs fonctionnant dans la bande 5150-5250 MHz sont réservés uniquement pour une utilisation à l'intérieur afin de réduire les risques de brouillage préjudiciable aux systèmes de satellites mobiles utilisant les mêmes canaux;

(ii) De plus, les utilisateurs devraient aussi être avisés que les utilisateurs de radars de haute puissance sont désignés utilisateurs principaux (c.-à-d., qu'ils ont la priorité) pour les bandes 5250-5350 MHz et 5650-5850 MHz et que ces radars pourraient causer du brouillage et/ou des dommages aux dispositifs LAN-EL.

IC Radiation Exposure Statement

This equipment complies with IC RSS-102 radiation exposure limits set forth for an uncontrolled environment. This equipment should be installed and operated with minimum distance 23cm between the radiator & your body.

Cet équipement est conforme aux limites d'exposition aux rayonnements IC établies pour un environnement non contrôlé. Cet équipement doit être installé et utilisé avec un minimum de 23 cm de distance entre la source de rayonnement et votre corps.

注意 !

依據 低功率電波輻射性電機管理辦法

第十二條 經型式認證合格之低功率射頻電機，非經許可，公司、商號或使用者均不得擅自變更頻率、加大功率或變更原設計之特性及功能。

第十四條 低功率射頻電機之使用不得影響飛航安全及干擾合法通信；經發現有干擾現象時，應立即停用，並改善至無干擾時方得繼續使用。前項合法通信，指依電信規定作業之無線電信。低功率射頻電機須忍受合法通信或工業、科學及醫療用電波輻射性電機設備之干擾。

在 5.25 - 5.35 GHz 頻帶內操作之無線資訊傳輸設備，限於室內使用。

Notices

Changes or modifications not expressly approved by the party responsible for compliance could void the user's authority to operate the equipment.

This Class B digital apparatus complies with Canadian ICES-003.

Cet appareil numérique de la classe B est conforme à la norme NMB-003 du Canada.

Viewing Certifications

Go to <http://www.zyxel.com> to view this product's documentation and certifications.

ZyXEL Limited Warranty

ZyXEL warrants to the original end user (purchaser) that this product is free from any defects in material or workmanship for a specific period (the Warranty Period) from the date of purchase. The Warranty Period varies by region. Check with your vendor and/or the authorized ZyXEL local distributor for details about the Warranty Period of this product. During the warranty period, and upon proof of purchase, should the product have indications of failure due to faulty workmanship and/or materials, ZyXEL will, at its discretion, repair or replace the defective products or components without charge for either parts or labor, and to whatever extent it shall deem necessary to restore the product or components to proper operating condition. Any replacement will consist of a new or re-manufactured functionally equivalent product of equal or higher value, and will be solely at the discretion of ZyXEL. This warranty shall not apply if the product has been modified, misused, tampered with, damaged by an act of God, or subjected to abnormal working conditions.

Note

Repair or replacement, as provided under this warranty, is the exclusive remedy of the purchaser. This warranty is in lieu of all other warranties, express or implied, including any implied warranty of merchantability or fitness for a particular use or purpose. ZyXEL shall in no event be held liable for indirect or consequential damages of any kind to the purchaser.

To obtain the services of this warranty, contact your vendor. You may also refer to the warranty policy for the region in which you bought the device at http://www.zyxel.com/web/support_warranty_info.php.

Registration

Register your product online to receive e-mail notices of firmware upgrades and information at www.zyxel.com for global products, or at www.us.zyxel.com for North American products.

Open Source Licenses

This product contains in part some free software distributed under GPL license terms and/or GPL like licenses. Open source licenses are provided with the firmware package. You can download the latest firmware at www.zyxel.com. To obtain the source code covered under those Licenses, please contact support@zyxel.com.tw to get it.

Regulatory Information

European Union

The following information applies if you use the product within the European Union.

Declaration of Conformity with Regard to EU Directive 1999/5/EC (R&TTE Directive)

Compliance Information for 2.4GHz and 5GHz Wireless Products Relevant to the EU and Other Countries Following the EU Directive 1999/5/EC (R&TTE Directive)

[Czech]	ZyXEL tímto prohlašuje, že tento zařízení je ve shodě se základními požadavky a dalšími příslušnými ustanoveními směrnice 1999/5/EC.
[Danish]	Undertegnede ZyXEL erklærer herved, at følgende udstyr overholder de væsentlige krav og øvrige relevante krav i direktiv 1999/5/EF.
[German]	Hiermit erklärt ZyXEL, dass sich das Gerät Ausstattung in Übereinstimmung mit den grundlegenden Anforderungen und den übrigen einschlägigen Bestimmungen der Richtlinie 1999/5/EU befindet.
[Estonian]	Käesolevaga kinnitab ZyXEL seadme vastavust direktiivi 1999/5/EÜ põhinõuetele ja nimetatud direktiivist tulenevatele teistele asjakohastele sätetele.
English	Hereby, ZyXEL declares that this equipment is in compliance with the essential requirements and other relevant provisions of Directive 1999/5/EC.
[Spanish]	Por medio de la presente ZyXEL declara que el equipo cumple con los requisitos esenciales y cualesquiera otras disposiciones aplicables o exigibles de la Directiva 1999/5/CE.
[Greek]	ΜΕ ΤΗΝ ΠΑΡΟΥΣΑ ΖΥΧΕΛ ΔΗΛΩΝΕΙ ΟΤΙ ΕΞΟΠΛΙΣΜΟΣ ΣΥΜΜΟΡΦΩΝΕΤΑΙ ΠΡΟΣ ΤΙΣ ΟΥΣΙΩΔΕΙΣ ΑΠΑΙΤΗΣΕΙΣ ΚΑΙ ΤΙΣ ΛΟΙΠΕΣ ΣΧΕΤΙΚΕΣ ΔΙΑΤΑΞΕΙΣ ΤΗΣ ΟΔΗΓΙΑΣ 1999/5/ΕΚ.
[French]	Par la présente ZyXEL déclare que l'appareil équipements est conforme aux exigences essentielles et aux autres dispositions pertinentes de la directive 1999/5/CE.
[Italian]	Con la presente ZyXEL dichiara che questo attrezzatura è conforme ai requisiti essenziali ed alle altre disposizioni pertinenti stabilite dalla direttiva 1999/5/CE.
[Latvian]	Ar šo ZyXEL deklarē, ka iekārtas atbilst Direktīvas 1999/5/EK būtiskajām prasībām un citiem ar to saistītajiem noteikumiem.
[Lithuanian]	Šiuo ZyXEL deklaruoja, kad šis įranga atitinka esminius reikalavimus ir kitas 1999/5/EB Direktyvos nuostatas.
[Dutch]	Hierbij verklaart ZyXEL dat het toestel uitrusting in overeenstemming is met de essentiële eisen en de andere relevante bepalingen van richtlijn 1999/5/EC.
[Maltese]	Hawnhekk, ZyXEL, jiddikjara li dan taghmir jikkonforma mal-htigijiet essenzjali u ma provvedimenti oħrajn relevanti li hemm fid-Dirrettiva 1999/5/EC.
[Hungarian]	Alulírott, ZyXEL nyilatkozom, hogy a berendezés megfelel a vonatkozó alapvető követelményeknek és az 1999/5/EK irányelv egyéb előírásainak.
[Polish]	Niniejszym ZyXEL oświadcza, że sprzęt jest zgodny z zasadniczymi wymogami oraz pozostałymi stosownymi postanowieniami Dyrektywy 1999/5/EC.
[Portuguese]	ZyXEL declara que este equipamento está conforme com os requisitos essenciais e outras disposições da Directiva 1999/5/EC.
[Slovenian]	ZyXEL izjavlja, da je ta oprema v skladu z bistvenimi zahtevami in ostalimi relevantnimi določili direktive 1999/5/EC.
[Slovak]	ZyXEL týmto vyhlasuje, že zariadenia spĺňajú základné požiadavky a všetky príslušné ustanovenia Smernice 1999/5/EC.
[Finnish]	ZyXEL vakuuttaa täten että laitteet tyyppinen laite on direktiivin 1999/5/EY oleellisten vaatimusten ja sitä koskevien direktiivin muiden ehtojen mukainen.
[Swedish]	Härmed intygar ZyXEL att denna utrustning står i överensstämmelse med de väsentliga egenskapskrav och övriga relevanta bestämmelser som framgår av direktiv 1999/5/EC.
[Bulgarian]	С настоящото ZyXEL декларира, че това оборудване е в съответствие със съществените изисквания и другите приложими разпоредбите на Директива 1999/5/EC.
[Icelandic]	Hér með lýsir, ZyXEL því yfir að þessi búnaður er í samræmi við grunnkröfur og önnur viðeigandi ákvæði tilskipunar 1999/5/EC.
[Norwegian]	Erklærer herved ZyXEL at dette utstyret er i samsvar med de grunnleggende kravene og andre relevante bestemmelser i direktiv 1999/5/EF.
[Romanian]	Prin prezenta, ZyXEL declară că acest echipament este în conformitate cu cerințele esențiale și alte prevederi relevante ale Directivei 1999/5/EC.



National Restrictions

This product may be used in all EU countries (and other countries following the EU directive 1999/5/EC) without any limitation except for the countries mentioned below:

Ce produit peut être utilisé dans tous les pays de l'UE (et dans tous les pays ayant transposés la directive 1999/5/CE) sans aucune limitation, excepté pour les pays mentionnés ci-dessous:

Questo prodotto è utilizzabile in tutte i paesi EU (ed in tutti gli altri paesi che seguono le direttive EU 1999/5/EC) senza nessuna limitazione, eccetto per i paesi menzionati di seguito:

Das Produkt kann in allen EU Staaten ohne Einschränkungen eingesetzt werden (sowie in anderen Staaten die der EU Direktive 1995/5/CE folgen) mit Ausnahme der folgenden aufgeführten Staaten:

In the majority of the EU and other European countries, the 2, 4- and 5-GHz bands have been made available for the use of wireless local area networks (LANs). Later in this document you will find an overview of countries in which additional restrictions or requirements or both are applicable.

The requirements for any country may evolve. ZyXEL recommends that you check with the local authorities for the latest status of their national regulations for both the 2,4- and 5-GHz wireless LANs.

The following countries have restrictions and/or requirements in addition to those given in the table labeled "Overview of Regulatory Requirements for Wireless LANs":

Overview of Regulatory Requirements for Wireless LANs			
Frequency Band (MHz)	Max Power Level (EIRP) ¹ (mW)	Indoor ONLY	Indoor and Outdoor
2400-2483.5	100		V
5150-5350	200	V	
5470-5725	1000		V

Belgium

The Belgian Institute for Postal Services and Telecommunications (BIPT) must be notified of any outdoor wireless link having a range exceeding 300 meters. Please check <http://www.bipt.be> for more details.

Draadloze verbindingen voor buitengebruik en met een reikwijdte van meer dan 300 meter dienen aangemeld te worden bij het Belgisch Instituut voor postdiensten en telecommunicatie (BIPT). Zie <http://www.bipt.be> voor meer gegevens.

Les liaisons sans fil pour une utilisation en extérieur d'une distance supérieure à 300 mètres doivent être notifiées à l'Institut Belge des services Postaux et des Télécommunications (IBPT). Visitez <http://www.ibpt.be> pour de plus amples détails.

Denmark

In Denmark, the band 5150 - 5350 MHz is also allowed for outdoor usage.

I Danmark må frekvensbåndet 5150 - 5350 også anvendes udendørs.

Italy

This product meets the National Radio Interface and the requirements specified in the National Frequency Allocation Table for Italy. Unless this wireless LAN product is operating within the boundaries of the owner's property, its use requires a "general authorization." Please check <http://www.sviluppoeconomico.gov.it/> for more details.

Questo prodotto è conforme alla specifiche di Interfaccia Radio Nazionali e rispetta il Piano Nazionale di ripartizione delle frequenze in Italia. Se non viene installato all'interno del proprio fondo, l'utilizzo di prodotti Wireless LAN richiede una "Autorizzazione Generale". Consultare <http://www.sviluppoeconomico.gov.it/> per maggiori dettagli.

Latvia

The outdoor usage of the 2.4 GHz band requires an authorization from the Electronic Communications Office. Please check <http://www.esd.lv> for more details.

2.4 GHz frekvenču joslas izmantošanai ārpus telpām nepieciešama atļauja no Elektronisko sakaru direkcijas. Vairāk informācijas: <http://www.esd.lv>.

Notes:

1. Although Norway, Switzerland and Liechtenstein are not EU member states, the EU Directive 1999/5/EC has also been implemented in those countries.
2. The regulatory limits for maximum output power are specified in EIRP. The EIRP level (in dBm) of a device can be calculated by adding the gain of the antenna used (specified in dBi) to the output power available at the connector (specified in dBm).

List of national codes

COUNTRY	ISO 3166 2 LETTER CODE	COUNTRY	ISO 3166 2 LETTER CODE
Austria	AT	Malta	MT
Belgium	BE	Netherlands	NL
Cyprus	CY	Poland	PL
Czech Republic	CR	Portugal	PT
Denmark	DK	Slovakia	SK
Estonia	EE	Slovenia	SI
Finland	FI	Spain	ES
France	FR	Sweden	SE
Germany	DE	United Kingdom	GB
Greece	GR	Iceland	IS
Hungary	HU	Liechtenstein	LI
Ireland	IE	Norway	NO
Italy	IT	Switzerland	CH
Latvia	LV	Bulgaria	BG
Lithuania	LT	Romania	RO
Luxembourg	LU	Turkey	TR

Safety Warnings

- Do NOT use this product near water, for example, in a wet basement or near a swimming pool.
- Do NOT expose your device to dampness, dust or corrosive liquids.
- Do NOT store things on the device.
- Do NOT install, use, or service this device during a thunderstorm. There is a remote risk of electric shock from lightning.
- Connect ONLY suitable accessories to the device.
- Do NOT open the device or unit. Opening or removing covers can expose you to dangerous high voltage points or other risks. ONLY qualified service personnel should service or disassemble this device. Please contact your vendor for further information.
- Make sure to connect the cables to the correct ports.
- Place connecting cables carefully so that no one will step on them or stumble over them.
- Always disconnect all cables from this device before servicing or disassembling.
- Use ONLY an appropriate power adaptor or cord for your device.
- Connect the power adaptor or cord to the right supply voltage (for example, 110V AC in North America or 230V AC in Europe).
- Do NOT allow anything to rest on the power adaptor or cord and do NOT place the product where anyone can walk on the power adaptor or cord.
- Do NOT use the device if the power adaptor or cord is damaged as it might cause electrocution.
- If the power adaptor or cord is damaged, remove it from the power outlet.
- Do NOT attempt to repair the power adaptor or cord. Contact your local vendor to order a new one.
- Do not use the device outside, and make sure all the connections are indoors. There is a remote risk of electric shock from lightning.
- Do NOT obstruct the device ventilation slots, as insufficient airflow may harm your device.
- Antenna Warning! This device meets ETSI and FCC certification requirements when using the included antenna(s). Only use the included antenna(s).
- If you wall mount your device, make sure that no electrical lines, gas or water pipes will be damaged.

Your product is marked with this symbol, which is known as the WEEE mark. WEEE stands for Waste Electronics and Electrical Equipment. It means that used electrical and electronic products should not be mixed with general waste. Used electrical and electronic equipment should be treated separately.



A

ActiveX [140](#)
Address Assignment [76](#)
AP [12](#)
AP Mode
 menu [54](#)
 status screen [52](#)
AP+Bridge [12](#)

B

Bridge/Repeater [12](#)

C

certifications [198](#)
 notices [199](#)
 viewing [199](#)
Channel [45, 46, 53](#)
channel [87](#)
CIFS [169](#)
Common Internet File System, see CIFS
Configuration
 restore [185](#)
content filtering [139](#)
 by keyword (in URL) [139](#)
Cookies [140](#)
copyright [198](#)
CPU usage [46, 54](#)

D

Daylight saving [183](#)
DDNS [129](#)
 see also Dynamic DNS

 service providers [129, 146](#)
DHCP [71, 113](#)
 DHCP server
 see also Dynamic Host Configuration Protocol
DHCP server [110, 113](#)
Digital Living Network Alliance [168](#)
disclaimer [198](#)
DLNA [167, 168](#)
 indexing [170](#)
 overview [167](#)
 rescan [170](#)
DLNA-compliant client [168](#)
DNS [115](#)
DNS Server [76](#)
DNS server [115](#)
documentation
 related [2](#)
Domain Name System [115](#)
Domain Name System. See DNS.
duplex setting [46, 54](#)
Dynamic DNS [129](#)
Dynamic Host Configuration Protocol [113](#)
DynDNS [129, 146](#)
DynDNS see also DDNS [129, 146](#)

E

encryption [88](#)
 and local (user) database [89](#)
 key [89](#)
 WPA compatible [89](#)
ESSID [194](#)

F

FCC interference statement [198](#)
file sharing [168](#)
 access right [172, 173](#)

- bandwidth [173](#)
 - example [173](#)
 - FTP [172](#)
 - overview [168](#)
 - Samba [171](#)
 - user account [172](#), [173](#)
 - Windows Explorer [171](#)
 - work group [171](#)
- F**
- Firewall [135](#)
 - Firewall overview
 - guidelines [135](#)
 - ICMP packets [136](#)
 - network security
 - Stateful inspection [135](#)
 - ZyXEL device firewall [135](#)
 - firewall
 - stateful inspection [134](#)
 - Firmware upload [183](#)
 - file extension
 - using HTTP
 - firmware version [45](#), [53](#)
- G**
- General wireless LAN screen [91](#)
 - Guest WLAN [89](#)
 - Guest WLAN Bandwidth [90](#)
 - Guide
 - Quick Start [2](#)
- I**
- IGMP [77](#)
 - see also Internet Group Multicast Protocol
 - version
 - IGMP version [77](#)
 - Internet Group Multicast Protocol [77](#)
 - IP Address [110](#), [111](#), [121](#)
 - IP alias [110](#)
 - IP Pool [114](#)
- J**
- Java [140](#)
- L**
- LAN [109](#)
 - IP pool setup [113](#)
 - LAN overview [109](#)
 - LAN setup [109](#)
 - LAN TCP/IP [113](#)
 - Language [186](#)
 - Link type [46](#), [54](#)
 - local (user) database [88](#)
 - and encryption [89](#)
 - Local Area Network [109](#)
- M**
- MAC [102](#)
 - MAC address [77](#), [88](#)
 - cloning [77](#)
 - MAC address filter [88](#)
 - MAC address filtering [102](#)
 - MAC filter [102](#)
 - Management Information Base (MIB) [157](#)
 - managing the device
 - good habits [14](#)
 - using the web configurator. See web configurator.
 - using the WPS. See WPS.
 - MBSSID [12](#)
 - Media access control [102](#)
 - media client [167](#)
 - media file [167](#), [170](#)
 - type [170](#)
 - media server [167](#)
 - overview [167](#)
 - media file play [167](#)
 - Memory usage [46](#), [54](#)
 - mode [12](#)
 - Multicast [77](#)
 - IGMP [77](#)

N

- NAT [118, 121](#)
 - global [119](#)
 - how it works [120](#)
 - inside [119](#)
 - local [119](#)
 - outside [119](#)
 - overview [118](#)
 - port forwarding [126](#)
 - see also Network Address Translation
 - server [119](#)
 - server sets [126](#)
- NAT Traversal [161](#)
- Navigation Panel [46, 54](#)
- navigation panel [46, 54](#)
- Network Address Translation [118, 121](#)

O

- operating mode [12](#)
- other documentation [2](#)

P

- Point-to-Point Protocol over Ethernet [81](#)
- Pool Size [114](#)
- Port forwarding [121, 126](#)
 - default server [121, 126](#)
 - example [126](#)
 - local server [121](#)
 - port numbers
 - services
- port speed [46, 54](#)
- PPPoE [81](#)
 - dial-up connection
- product registration [199](#)

Q

- Quality of Service (QoS) [105](#)
- Quick Start Guide [2](#)

R

- RADIUS server [88](#)
- registration
 - product [199](#)
- related documentation [2](#)
- Remote management
 - and NAT [155](#)
 - limitations [154](#)
 - system timeout [155](#)
- Reset button [14](#)
- Reset the device [14](#)
- Restore configuration [185](#)
- Roaming [104](#)
- Router Mode
 - status screen [43](#)
- RTS/CTS Threshold [87, 104](#)

S

- Samba [169](#)
- Scheduling [107](#)
- Server Message Block, see SMB
- Service and port numbers [138](#)
- Service Set [40, 91, 101](#)
- Service Set IDentification [40, 91, 101](#)
- Service Set IDentity. See SSID.
- Simple Network Management Protocol, see SNMP
- SMB [169](#)
- SNMP [156, 157](#)
 - agents [157](#)
 - Get [157](#)
 - GetNext [157](#)
 - Manager [157](#)
 - managers [157](#)
 - MIB [157](#)
 - network components [157](#)
 - Set [157](#)
 - Trap [157](#)
 - versions [156](#)
- SSID [40, 45, 46, 53, 87, 91, 101](#)
- stateful inspection firewall [134](#)
- Static DHCP [114](#)
- Static Route [131](#)

Status [43](#)
StreamBoost [149](#)
 automatic update [150](#)
 bandwidth [149](#)
 bandwidth and performance [153](#)
 data rate [150](#)
 device priority [152](#)
 download traffic [152](#)
 example [149](#)
 maximum bandwidth [150](#)
 overview [149](#)
 QoS [149](#)
 top traffic flows [152](#)
Subnet Mask [111](#)
Summary
 DHCP table [71](#)
 Packet statistics [72](#)
 Wireless station status [73](#)
System General Setup [179](#)
System restart [186](#)

T

TCP/IP configuration [113](#)
Time setting [181](#)
trademarks [198](#)
trigger port [127](#)
Trigger port forwarding [127](#)
 example [127](#)
 process [127](#)

U

Universal Plug and Play [161](#)
 Application [161](#)
 Security issues [161](#)
UPnP [161](#)
URL Keyword Blocking [140](#)
USB media sharing [167](#)
user authentication [88](#)
 local (user) database [88](#)
 RADIUS server [88](#)
User Name [130](#)

W

Wake On LAN [159](#)
WAN (Wide Area Network) [75](#)
WAN MAC address [77](#)
warranty [199](#)
 note [199](#)
Web Configurator
 how to access [28](#)
 Overview [28](#)
web configurator [13](#)
Web Proxy [140](#)
WEP Encryption [95, 97](#)
WEP encryption [94](#)
WEP key [94](#)
windows media player [167](#)
Wireless association list [73](#)
wireless channel [194](#)
wireless LAN [194](#)
wireless LAN scheduling [107](#)
Wireless network
 basic guidelines [87](#)
 channel [87](#)
 encryption [88](#)
 example [86](#)
 MAC address filter [88](#)
 overview [86](#)
 security [87](#)
 SSID [87](#)
Wireless security [87](#)
 overview [87](#)
 type [87](#)
wireless security [194](#)
Wireless tutorial [57](#)
Wizard setup [18](#)
WLAN button [14](#)
WoL [159](#)
work group [169](#)
 name [169](#)
 Windows [169](#)
WPA compatible [89](#)
WPS [13](#)