



VMG3925-B10A

Dual Band Wireless AC/N VDSL2 VoIP Combo WAN Gigabit Gateway with USB

Version 5.11
Edition 1, 11/2015

User's Guide

Default Login Details

LAN IP Address	http://192.168.1.1
User Name	admin, user
Password	1234, user

IMPORTANT!

READ CAREFULLY BEFORE USE.

KEEP THIS GUIDE FOR FUTURE REFERENCE.

Screenshots and graphics in this book may differ slightly from your product due to differences in your product firmware or your computer operating system. Every effort has been made to ensure that the information in this manual is accurate.

Related Documentation

- Quick Start Guide

The Quick Start Guide shows how to connect the VMG and get up and running right away.

- More Information

Go to support.zyxel.com to find other information on the VMG.



Contents Overview

User's Guide	14
Introducing the VMG	15
The Web Configurator	21
Quick Start	29
Tutorials	31
Technical Reference	54
Network Map and Status Screens	55
Broadband	59
Wireless	85
Home Networking	116
Routing	132
Quality of Service (QoS)	139
Network Address Translation (NAT)	157
DNS Setup	173
IGMP/MLD	177
VLAN Group	180
Interface Group	183
USB Service	188
Firewall	193
MAC Filter	200
Parental Control	202
Scheduler Rule	206
Certificates	208
Log	215
Traffic Status	218
ARP Table	221
Routing Table	223
Multicast Status	225
xDSL Statistics	227
3G Statistics	230
System	232
User Account	233
Remote Management	235
SNMP	238
Time Settings	240
E-mail Notification	243
Log Setting	245

Firmware Upgrade	248
Backup Restore	250
Diagnostic	253
Troubleshooting	258
Appendices	265

Table of Contents

Contents Overview	3
Table of Contents	5
Part I: User's Guide	14
Chapter 1	
Introducing the VMG	15
1.1 Overview	15
1.2 Ways to Manage the VMG	15
1.3 Good Habits for Managing the VMG	15
1.4 Applications for the VMG	16
1.4.1 Internet Access	16
1.4.2 VMG's USB Support	16
1.5 LEDs (Lights)	17
1.6 The RESET Button	19
1.7 Wireless Access	20
1.7.1 Using the Wi-Fi and WPS Buttons	20
Chapter 2	
The Web Configurator	21
2.1 Overview	21
2.1.1 Accessing the Web Configurator	21
2.2 Web Configurator Layout	23
2.2.1 Title Bar	23
2.2.2 Main Window	24
2.2.3 Navigation Panel	25
Chapter 3	
Quick Start.....	29
3.1 Overview	29
3.2 Quick Start Setup	29
Chapter 4	
Tutorials.....	31
4.1 Overview	31
4.2 Setting Up an ADSL PPPoE Connection	31
4.3 Setting Up a Secure Wireless Network	34

4.3.1 Configuring the Wireless Network Settings	34
4.3.2 Using WPS	36
4.3.3 Without WPS	40
4.4 Setting Up Multiple Wireless Groups	41
4.5 Configuring Static Route for Routing to Another Network	44
4.6 Configuring QoS Queue and Class Setup	46
4.7 Access the VMG Using DDNS	50
4.7.1 Registering a DDNS Account on www.dyndns.org	50
4.7.2 Configuring DDNS on Your VMG	51
4.7.3 Testing the DDNS Setting	51
4.8 Configuring the MAC Address Filter	51
4.9 Access Your Shared Files From a Computer	53

Part II: Technical Reference..... 54

**Chapter 5
Network Map and Status Screens 55**

5.1 Overview	55
5.2 The Network Map Screen	55
5.3 The Status Screen	56

**Chapter 6
Broadband..... 59**

6.1 Overview	59
6.1.1 What You Can Do in this Chapter	59
6.1.2 What You Need to Know	60
6.1.3 Before You Begin	62
6.2 The Broadband Screen	63
6.2.1 Add/Edit Internet Connection	64
6.3 The 3G Backup Screen	71
6.4 The Advanced Screen	75
6.5 The 802.1x Screen	78
6.5.1 Modify 802.1X Settings	79
6.6 Technical Reference	79

**Chapter 7
Wireless 85**

7.1 Overview	85
7.1.1 What You Can Do in this Chapter	85
7.1.2 What You Need to Know	85
7.2 The General Screen	86

7.2.1 No Security	88
7.2.2 Basic (WEP Encryption)	88
7.2.3 More Secure (WPA(2)-PSK)	89
7.3 The Guest / More AP Screen	91
7.3.1 Edit Guest / More AP	91
7.4 The MAC Authentication Screen	93
7.5 The WPS Screen	94
7.6 The WMM Screen	96
7.7 The WDS Screen	97
7.7.1 WDS Scan	98
7.8 The Others Screen	99
7.9 The Channel Status Screen	101
7.10 Technical Reference	102
7.10.1 Wireless Network Overview	102
7.10.2 Additional Wireless Terms	104
7.10.3 Wireless Security Overview	104
7.10.4 Signal Problems	106
7.10.5 BSS	107
7.10.6 MBSSID	107
7.10.7 Preamble Type	108
7.10.8 Wireless Distribution System (WDS)	108
7.10.9 WiFi Protected Setup (WPS)	108

Chapter 8

Home Networking 116

8.1 Overview	116
8.1.1 What You Can Do in this Chapter	116
8.1.2 What You Need To Know	117
8.1.3 Before You Begin	118
8.2 The LAN Setup Screen	118
8.3 The Static DHCP Screen	122
8.4 The UPnP Screen	123
8.4.1 Turning On UPnP in Windows 7 Example	124
8.5 The Additional Subnet Screen	126
8.6 The STB Vendor ID Screen	127
8.7 The Wake on LAN Screen	127
8.8 The TFTP Server Name Screen	128
8.9 Technical Reference	128
8.9.1 LANs, WANs and the VMG	128
8.9.2 DHCP Setup	129
8.9.3 DNS Server Addresses	129
8.9.4 LAN TCP/IP	130

Chapter 9	
Routing	132
9.1 Overview	132
9.2 The Routing Screen	132
9.2.1 Add/Edit Static Route	133
9.3 The DNS Route Screen	134
9.3.1 The DNS Route Add Screen	135
9.4 The Policy Route Screen	135
9.4.1 Add/Edit Policy Route	137
9.5 RIP	138
9.5.1 The RIP Screen	138
Chapter 10	
Quality of Service (QoS)	139
10.1 Overview	139
10.1.1 What You Can Do in this Chapter	139
10.2 What You Need to Know	140
10.3 The Quality of Service General Screen	141
10.4 The Queue Setup Screen	142
10.4.1 Adding a QoS Queue	144
10.5 The Classification Setup Screen	144
10.5.1 Add/Edit QoS Classifier	145
10.6 The QoS Shaper Setup Screen	149
10.6.1 Add/Edit a QoS Shaper	150
10.7 The QoS Policer Setup Screen	150
10.7.1 Add/Edit a QoS Policer	151
10.8 Technical Reference	152
Chapter 11	
Network Address Translation (NAT)	157
11.1 Overview	157
11.1.1 What You Can Do in this Chapter	157
11.1.2 What You Need To Know	157
11.2 The Port Forwarding Screen	158
11.2.1 Add/Edit Port Forwarding	160
11.3 The Applications Screen	161
11.3.1 Add New Application	162
11.4 The Port Triggering Screen	162
11.4.1 Add/Edit Port Triggering Rule	164
11.5 The DMZ Screen	165
11.6 The ALG Screen	166
11.7 The Address Mapping Screen	166
11.7.1 Add/Edit Address Mapping Rule	167

11.8 The Sessions Screen	168
11.9 Technical Reference	169
11.9.1 NAT Definitions	169
11.9.2 What NAT Does	169
11.9.3 How NAT Works	170
11.9.4 NAT Application	170
Chapter 12	
DNS Setup	173
12.1 Overview	173
12.1.1 What You Can Do in this Chapter	173
12.1.2 What You Need To Know	173
12.2 The DNS Entry Screen	174
12.2.1 Add/Edit DNS Entry	174
12.3 The Dynamic DNS Screen	175
Chapter 13	
IGMP/MLD	177
13.1 Overview	177
13.1.1 What You Need To Know	177
13.2 The IGMP/MLD Screen	177
Chapter 14	
VLAN Group	180
14.1 Overview	180
14.1.1 What You Can Do in this Chapter	180
14.2 The Vlan Group Screen	180
14.2.1 Add/Edit a VLAN Group	181
Chapter 15	
Interface Group	183
15.1 Overview	183
15.1.1 What You Can Do in this Chapter	183
15.2 The Interface Group Screen	183
15.2.1 Interface Group Configuration	184
15.2.2 Interface Grouping Criteria	186
Chapter 16	
USB Service	188
16.1 Overview	188
16.1.1 What You Can Do in this Chapter	188
16.1.2 What You Need To Know	188
16.1.3 Before You Begin	189

16.2 The File Sharing Screen	189
16.2.1 The Add New User Screen	190
16.3 The Media Server Screen	191
Chapter 17	
Firewall	193
17.1 Overview	193
17.1.1 What You Can Do in this Chapter	193
17.1.2 What You Need to Know	194
17.2 The Firewall Screen	194
17.3 The Protocol Screen	195
17.3.1 Add/Edit a Protocol	196
17.4 The Access Control Screen	197
17.4.1 Add/Edit an ACL Rule	197
17.5 The DoS Screen	199
Chapter 18	
MAC Filter	200
18.1 Overview	200
18.2 The MAC Filter Screen	200
Chapter 19	
Parental Control	202
19.1 Overview	202
19.2 The Parental Control Screen	202
19.2.1 Add/Edit a Parental Control Profile	203
Chapter 20	
Scheduler Rule	206
20.1 Overview	206
20.2 The Scheduler Rule Screen	206
20.2.1 Add/Edit a Schedule	206
Chapter 21	
Certificates	208
21.1 Overview	208
21.1.1 What You Can Do in this Chapter	208
21.2 What You Need to Know	208
21.3 The Local Certificates Screen	208
21.3.1 Create Certificate Request	209
21.3.2 Load Signed Certificate	211
21.4 The Trusted CA Screen	212
21.4.1 View Trusted CA Certificate	213

21.4.2 Import Trusted CA Certificate	214
Chapter 22	
Log	215
22.1 Overview	215
22.1.1 What You Can Do in this Chapter	215
22.1.2 What You Need To Know	215
22.2 The System Log Screen	216
22.3 The Security Log Screen	216
Chapter 23	
Traffic Status	218
23.1 Overview	218
23.1.1 What You Can Do in this Chapter	218
23.2 The WAN Status Screen	218
23.3 The LAN Status Screen	219
23.4 The NAT Status Screen	220
Chapter 24	
ARP Table	221
24.1 Overview	221
24.1.1 How ARP Works	221
24.2 ARP Table Screen	221
Chapter 25	
Routing Table	223
25.1 Overview	223
25.2 The Routing Table Screen	223
Chapter 26	
Multicast Status	225
26.1 Overview	225
26.2 The IGMP Status Screen	225
26.3 The MLD Status Screen	225
Chapter 27	
xDSL Statistics	227
27.1 The xDSL Statistics Screen	227
Chapter 28	
3G Statistics	230
28.1 Overview	230
28.2 The 3G Statistics Screen	230

Chapter 29	
System	232
29.1 Overview	232
29.2 The System Screen	232
Chapter 30	
User Account	233
30.1 Overview	233
30.2 The User Account Screen	233
30.2.1 The User Account Add/Edit Screen	233
Chapter 31	
Remote Management	235
31.1 Overview	235
31.2 The Remote MGMT Screen	235
31.3 The Trust Domain Screen	236
31.3.1 The Add Trust Domain Screen	236
Chapter 32	
SNMP	238
32.1 Overview	238
32.2 The SNMP Screen	238
Chapter 33	
Time Settings	240
33.1 Overview	240
33.2 The Time Screen	240
Chapter 34	
E-mail Notification	243
34.1 Overview	243
34.2 The E-mail Notification Screen	243
34.2.1 Email Notification Edit	243
Chapter 35	
Log Setting	245
35.1 Overview	245
35.2 The Log Settings Screen	245
35.2.1 Example E-mail Log	246
Chapter 36	
Firmware Upgrade	248
36.1 Overview	248

36.2 The Firmware Screen	248
Chapter 37	
Backup Restore	250
37.1 Overview	250
37.2 The Backup Restore Screen	250
37.3 The Reboot Screen	252
Chapter 38	
Diagnostic	253
38.1 Overview	253
38.1.1 What You Can Do in this Chapter	253
38.2 What You Need to Know	253
38.3 Ping & TraceRoute & NsLookup	254
38.4 802.1ag	254
38.5 OAM Ping	255
Chapter 39	
Troubleshooting.....	258
39.1 Power, Hardware Connections, and LEDs	258
39.2 VMG Access and Login	259
39.3 Internet Access	261
39.4 Wireless Internet Access	262
39.5 USB Device Connection	263
39.6 UPnP	263
Part III: Appendices	265
Appendix A Customer Support	266
Appendix B Wireless LANs	272
Appendix C IPv6	285
Appendix D Services	293
Appendix E Legal Information.....	297
Index	304

PART I

User's Guide

Introducing the VMG

1.1 Overview

The VMG is a wireless VDSL router and Gigabit Ethernet gateway. It has a DSL port and a Gigabit Ethernet port for super-fast Internet access. The VMG supports both Packet Transfer Mode (PTM) and Asynchronous Transfer Mode (ATM). It is backward compatible with ADSL, ADSL2 and ADSL2+ in case VDSL is not available.

Only use firmware for your VMG's specific model. Refer to the label on the bottom of your VMG.

The VMG works over the analog telephone system, POTS (Plain Old Telephone Service). The VMG has two USB ports for sharing files via a USB storage device or connecting a 3G dongle for a WAN backup connection.

1.2 Ways to Manage the VMG

Use any of the following methods to manage the VMG.

- Web Configurator. This is recommended for everyday management of the VMG using a (supported) web browser.
- TR-069. This is an auto-configuration server used to remotely configure your device.

1.3 Good Habits for Managing the VMG

Do the following things regularly to make the VMG more secure and to manage the VMG more effectively.

- Change the password. Use a password that's not easy to guess and that consists of different types of characters, such as numbers and letters.
- Write down the password and put it in a safe place.
- Back up the configuration (and make sure you know how to restore it). Restoring an earlier working configuration may be useful if the device becomes unstable or even crashes. If you forget your password, you will have to reset the VMG to its factory default settings. If you backed up an earlier configuration file, you would not have to totally re-configure the VMG. You could simply restore your last configuration.

1.4 Applications for the VMG

Here are some example uses for which the VMG is well suited.

1.4.1 Internet Access

Your VMG provides shared Internet access by connecting the DSL port to the **DSL** or **MODEM** jack on a splitter or your telephone jack. You can have multiple WAN services over one ADSL or VDSL. The VMG cannot work in ADSL and VDSL mode at the same time.

Note: The ADSL and VDSL lines share the same WAN (layer-2) interfaces that you configure in the VMG. Refer to [Section 6.2 on page 63](#) for the **Network Setting > Broadband** screen.

Computers can connect to the VMG's LAN ports (or wirelessly).

Figure 1 VMG's Internet Access Application

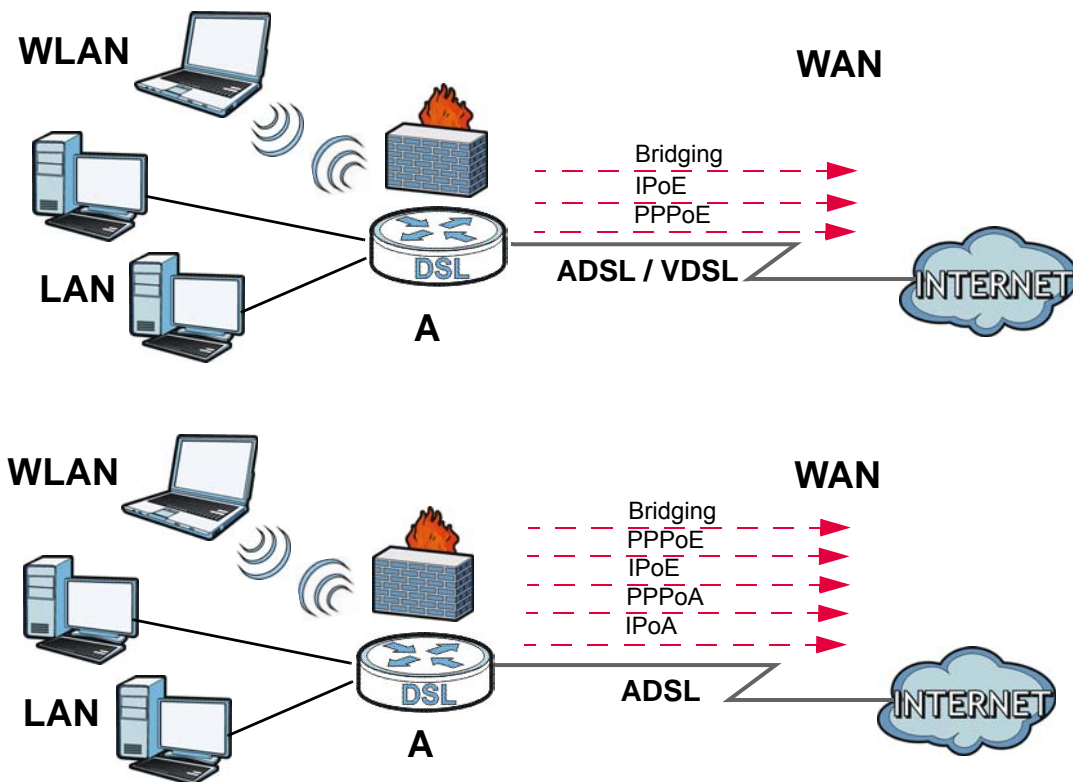

You can also configure IP filtering on the VMG for secure Internet access. When the IP filter is on, all incoming traffic from the Internet to your network is blocked by default unless it is initiated from your network. This means that probes from the outside to your network are not allowed, but you can safely browse the Internet and download files.

1.4.2 VMG's USB Support

The USB port of the VMG is used for file-sharing and media server.

File Sharing

Use the built-in USB 2.0 port to share files on a USB memory stick or a USB hard drive (**B**). You can connect one USB hard drive to the VMG at a time. Use FTP to access the files on the USB device.

Figure 2 USB File Sharing Application

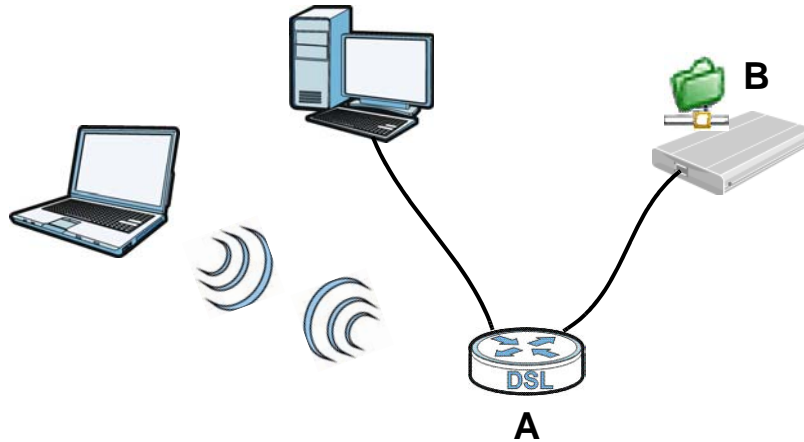

Media Server

You can also use the VMG as a media server. This lets anyone on your network play video, music, and photos from a USB device (**B**) connected to the VMG's USB port (without having to copy them to another computer).

Figure 3 USB Media Server Application

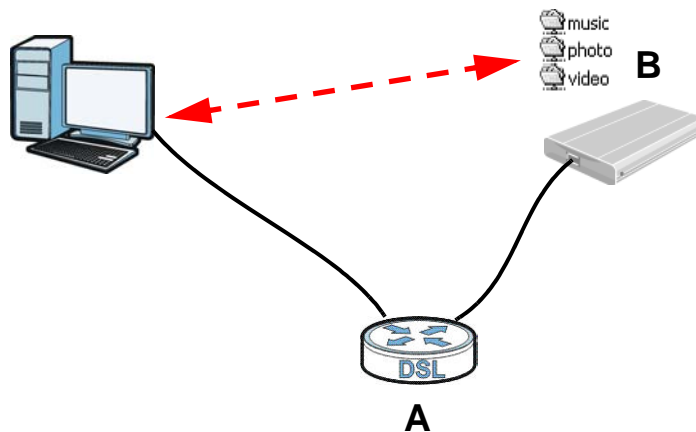

1.5 LEDs (Lights)

The following graphic displays the labels of the LEDs.

Figure 4 LEDs on the VMG

None of the LEDs are on if the VMG is not receiving power.

Table 1 LED Descriptions







LED	COLOR	STATUS	DESCRIPTION
 Power/ System	Green	On	The VMG is receiving power and ready for use.
		Blinking	The VMG is self-testing.
	Red	On	The VMG detected an error while self-testing, or there is a device malfunction.
		Off	The VMG is not receiving power.
 2.4G WLAN/ WPS	Green	On	The 2.4 GHz wireless network is activated.
		Blinking	The VMG is communicating with 2.4 GHz wireless clients.
	Orange	Blinking	The VMG is setting up a WPS connection with a 2.4 GHz wireless client.
		Off	The 2.4 GHz wireless network is not activated.

Table 1 LED Descriptions (continued)

LED	COLOR	STATUS	DESCRIPTION
 5G WLAN/ WPS	Green	On	The 5 GHz wireless network is activated.
		Blinking	The VMG is communicating with 5 GHz wireless clients.
	Orange	Blinking	The VMG is setting up a WPS connection with a 5 GHz wireless client.
		Off	The 5 GHz wireless network is not activated.
 LAN1~4	Green	On	The VMG has a successful 1000 Mbps Ethernet connection with a device on the Local Area Network (LAN).
		Blinking	The VMG is sending or receiving data to/from the LAN at 1000 Mbps.
	Off	The VMG does not have an Ethernet connection with the LAN.	
 Internet	Green	On	The VMG has an IP connection but no traffic. Your device has a WAN IP address (either static or assigned by a DHCP server), PPP negotiation was successfully completed (if used) and the DSL connection is up.
		Blinking	The VMG is sending or receiving IP traffic.
		Off	There is no Internet connection or the gateway is in bridged mode.
	Red	On	The VMG attempted to make an IP connection but failed. Possible causes are no response from a DHCP server, no PPPoE response, PPPoE authentication failed.
 DSL	Green	On	The ADSL line is up.
		Blinking	The VMG is initializing the ADSL line.
	Orange	On	The VDSL line is up.
		Blinking	The VMG is initializing the VDSL line.
	Off	The DSL line is down.	
 Ethernet WAN	Green	On	The VMG has a successful 1000 Mbps Ethernet connection on the WAN.
		Blinking	The VMG is sending or receiving data to/from the WAN at 1000 Mbps.
	Off	There is no Ethernet connection on the WAN.	
 USB	Green	On	The VMG recognizes a USB connection through the USB slot.
		Blinking	The VMG is sending/receiving data to/from the USB device connected to it.
		Off	The VMG does not detect a USB connection through the USB slot.

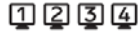
1.6 The RESET Button

If you forget your password or cannot access the Web Configurator, you will need to use the **RESET** button at the back of the device to reload the factory-default configuration file. This means that you will lose all configurations that you had previously and the password will be reset to "1234".

- 1 Make sure the **PWR/SYS** LED is on (not blinking).
- 2 To set the device back to the factory default settings, press the **RESET** button for ten seconds or until the **PWR/SYS** LED begins to blink and then release it. When the **PWR/SYS** LED begins to blink, the defaults have been restored and the device restarts.

1.7 Wireless Access

The VMG is a wireless Access Point (AP) for wireless clients, such as notebook computers or PDAs and iPads. It allows them to connect to the Internet without having to rely on inconvenient Ethernet cables.

You can configure your wireless network in either the built-in Web Configurator, or using the WPS button.

Figure 5 Wireless Access Example

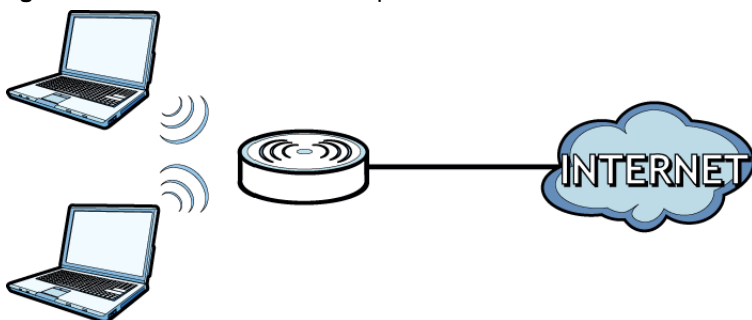

1.7.1 Using the Wi-Fi and WPS Buttons

If the wireless network is turned off, press the **WPS** button for one second. Once the **2.4G WLAN/WPS** or **5G WLAN/WPS** LED turns green, the wireless network is active.

You can also use the **WPS On/Off** button to quickly set up a secure wireless connection between the VMG and a WPS-compatible client by adding one device at a time.

To activate WPS:

- 1 Make sure the **PWR/SYS** LED is on and not blinking.
- 2 Press the **WPS** button for two seconds and release it.
- 3 Press the WPS button on another WPS-enabled device within range of the VMG. The **2.4G WLAN/WPS** or **5G WLAN/WPS** LED flashes orange while the VMG sets up a WPS connection with the other wireless device.
- 4 Once the connection is successfully made, the **2.4G WLAN/WPS** or **5G WLAN/WPS** LED shines green.

To turn off the wireless network, press the **WPS** button for one to five seconds. The **2.4G WLAN/WPS** or **5G WLAN/WPS** LED turns off when the wireless network is off.

The Web Configurator

2.1 Overview

The web configurator is an HTML-based management interface that allows easy VMG setup and management via Internet browser. Use Internet Explorer 8.0 and later versions or Mozilla Firefox 3 and later versions or Safari 2.0 and later versions. The recommended screen resolution is 1024 by 768 pixels.

In order to use the web configurator you need to allow:

- Web browser pop-up windows from your VMG. Web pop-up blocking is enabled by default in Windows XP SP (Service Pack) 2.
- JavaScript (enabled by default).
- Java permissions (enabled by default).

2.1.1 Accessing the Web Configurator

- 1 Make sure your VMG hardware is properly connected (refer to the Quick Start Guide).
- 2 Launch your web browser. If the VMG does not automatically re-direct you to the login screen, go to <http://192.168.1.1>.
- 3 A password screen displays. To access the administrative web configurator and manage the VMG, type the default username **admin** and password **1234** in the password screen and click **Login**. If advanced account security is enabled (see [Section 30.2 on page 233](#)) the number of dots that appears when you type the password changes randomly to prevent anyone watching the password field from knowing the length of your password. If you have changed the password, enter your password and click **Login**.

Figure 6 Password Screen

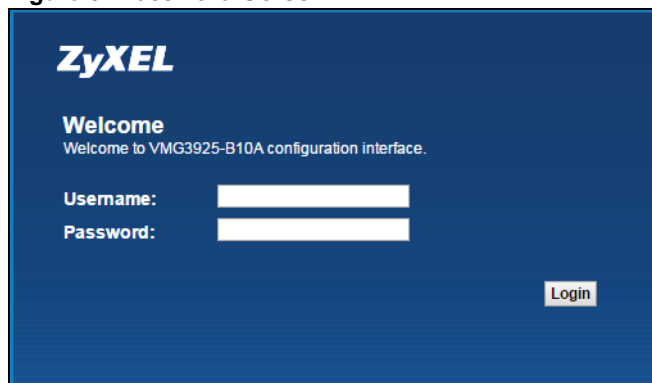

- 4 The **Quick Start Wizard** screen appears. You can configure basic Internet access, and wireless settings. See [Chapter 3 on page 29](#) for more information.

- 5 After you finished or closed the **Quick Start Wizard** screen, the **Network Map** page appears.

Figure 7 Network Map



- 6 Click **Status** to display the **Status** screen, where you can view the VMG's interface and system information.

2.2 Web Configurator Layout

Figure 8 Screen Layout

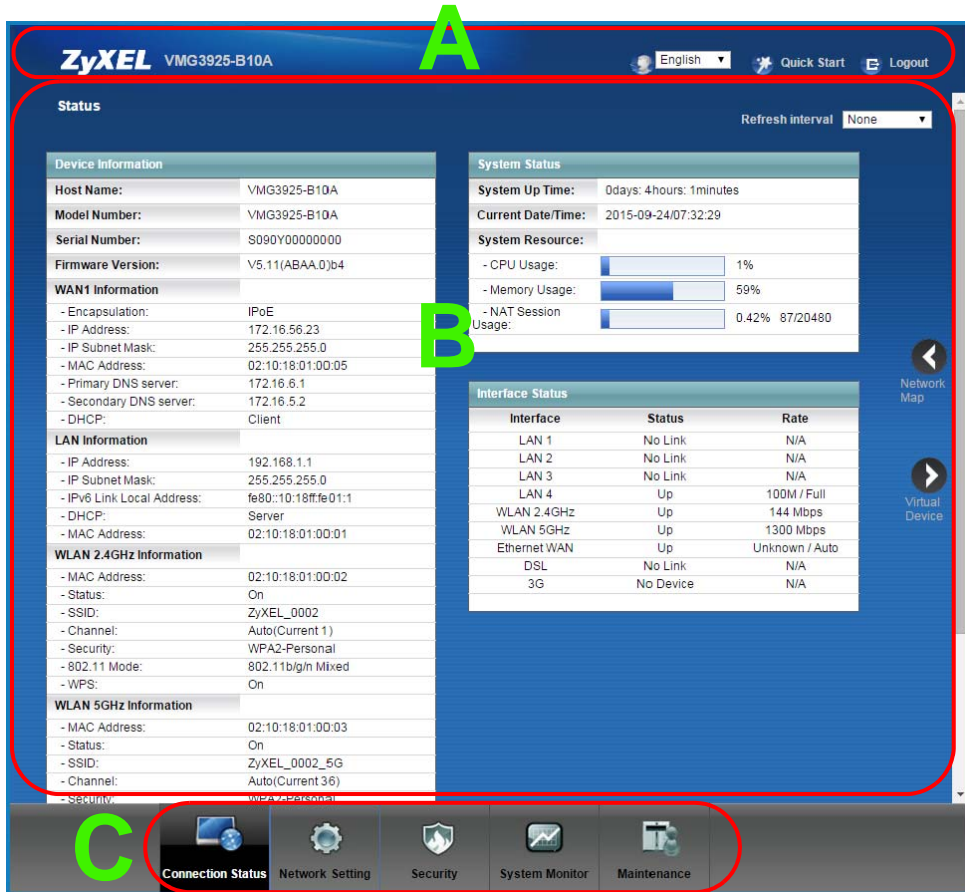

As illustrated above, the main screen is divided into these parts:

- A - title bar
- B - main window
- C - navigation panel

2.2.1 Title Bar

The title bar provides some icons in the upper right corner.

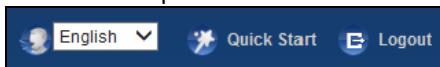



The icons provide the following functions.

Table 2 Web Configurator Icons in the Title Bar

ICON	DESCRIPTION
	Language: Select the language you prefer.

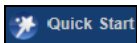
Table 2 Web Configurator Icons in the Title Bar

ICON	DESCRIPTION
	Quick Start: Click this icon to open screens where you can configure the VMG's time zone, Internet access, and wireless settings.
	Logout: Click this icon to log out of the web configurator.

2.2.2 Main Window

The main window displays information and configuration fields. It is discussed in the rest of this document.

After you click **Status** on the **Connection Status (Network Map)** page, the **Status** screen is displayed. See [Chapter 5 on page 56](#) for more information about the **Status** screen.

If you click **Virtual Device** on the **Status** screen, a visual graphic appears, showing the connection status of the VMG's ports. The connected ports are in color and disconnected ports are gray.

Figure 9 Virtual Device

2.2.3 Navigation Panel

Use the menu items on the navigation panel to open screens to configure VMG features. The following tables describe each menu item.

Table 3 Navigation Panel Summary

LINK	TAB	FUNCTION
Connection Status		This screen shows the network status of the VMG and computers/ devices connected to it.
Network Setting		
Broadband	Broadband	Use this screen to view and configure ISP parameters, WAN IP address assignment, and other advanced properties. You can also add new WAN connections.
	3G Backup	Use this screen to configure 3G WAN connection.
	Advanced	Use this screen to enable or disable PTM over ADSL, Annex M/Annex J, and DSL PhyR functions.
	802.1x	Use this screen to view and configure the IEEE 802.1x settings on the VMG.
Wireless	General	Use this screen to configure the wireless LAN settings and WLAN authentication/security settings.
	Guest/More AP	Use this screen to configure multiple BSSs on the VMG.
	MAC Authentication	Use this screen to block or allow wireless traffic from wireless devices of certain SSIDs and MAC addresses to the VMG.
	WPS	Use this screen to configure and view your WPS (Wi-Fi Protected Setup) settings.
	WMM	Use this screen to enable or disable Wi-Fi MultiMedia (WMM).
	WDS	Use this screen to set up Wireless Distribution System (WDS) links to other access points.
	Others	Use this screen to configure advanced wireless settings.
	Channel Status	Use this screen to scan wireless LAN channel noises and view the results.
Home Networking	LAN Setup	Use this screen to configure LAN TCP/IP settings, and other advanced properties.
	Static DHCP	Use this screen to assign specific IP addresses to individual MAC addresses.
	UPnP	Use this screen to turn UPnP and UPnP NAT-T on or off.
	Additional Subnet	Use this screen to configure IP alias and public static IP.
	STB Vendor ID	Use this screen to configure the Vendor IDs of the connected Set Top Box (STB) devices, which have the VMG automatically create static DHCP entries for the STB devices when they request IP addresses.
	Wake on LAN	Use this screen to remotely turn on a device on the local network.
	TFTP Server Name	Use DHCP option 66 to identify a TFTP server name.
Routing	Static Route	Use this screen to view and set up static routes on the VMG.
	DNS Route	Use this screen to forward DNS queries for certain domain names through a specific WAN interface to its DNS server(s).
	Policy Route	Use this screen to configure policy routing on the VMG.
	RIP	Use this screen to configure Routing Information Protocol to exchange routing information with other routers.

Table 3 Navigation Panel Summary (continued)

LINK	TAB	FUNCTION
QoS	General	Use this screen to enable QoS and traffic prioritizing. You can also configure the QoS rules and actions.
	Queue Setup	Use this screen to configure QoS queues.
	Classification Setup	Use this screen to define a classifier.
	Shaper Setup	Use this screen to limit outgoing traffic rate on the selected interface.
	Policer Setup	Use this screen to configure QoS policers.
NAT	Port Forwarding	Use this screen to make your local servers visible to the outside world.
	Applications	Use this screen to configure servers behind the VMG.
	Port Triggering	Use this screen to change your VMG's port triggering settings.
	DMZ	Use this screen to configure a default server which receives packets from ports that are not specified in the Port Forwarding screen.
	ALG	Use this screen to enable or disable SIP ALG.
	Address Mapping	Use this screen to change your VMG's address mapping settings.
	Sessions	Use this screen to configure the maximum number of NAT sessions each client host is allowed to have through the VMG.
DNS	DNS Entry	Use this screen to view and configure DNS routes.
	Dynamic DNS	Use this screen to allow a static hostname alias for a dynamic IP address.
IGMP/MLD	IGMP/MLD	Use this screen to configure multicast settings (IGMP for IPv4 and MLD for IPv6 multicast groups) on the WAN.
Vlan Group	Vlan Group	Use this screen to group and tag VLAN IDs to outgoing traffic from the specified interface.
Interface Grouping	Interface Grouping	Use this screen to map a port to a PVC or bridge group.
USB Service	File Sharing	Use this screen to enable file sharing via the VMG.
	Media Server	Use this screen to use the VMG as a media server.
Security		
Firewall	General	Use this screen to configure the security level of your firewall.
	Protocol	Use this screen to add Internet services and configure firewall rules.
	Access Control	Use this screen to enable specific traffic directions for network services.
	DoS	Use this screen to activate protection against Denial of Service (DoS) attacks.
MAC Filter	MAC Filter	Use this screen to block or allow traffic from devices of certain MAC addresses to the VMG.
Parental Control	Parental Control	Use this screen to block web sites with the specific URL.
Scheduler Rules	Scheduler Rules	Use this screen to configure the days and times when a configured restriction (such as parental control) is enforced.
Certificates	Local Certificates	Use this screen to view a summary list of certificates and manage certificates and certification requests.
	Trusted CA	Use this screen to view and manage the list of the trusted CAs.
System Monitor		

Table 3 Navigation Panel Summary (continued)

LINK	TAB	FUNCTION
Log	System Log	Use this screen to view the status of events that occurred to the VMG. You can export or e-mail the logs.
	Security Log	Use this screen to view all security related events. You can select level and category of the security events in their proper drop-down list window. Levels include: <ul style="list-style-type: none"> • Emergency • Alert • Critical • Error • Warning • Notice • Informational • Debugging Categories include: <ul style="list-style-type: none"> • Account • Attack • Firewall • MAC Filter
Traffic Status	WAN	Use this screen to view the status of all network traffic going through the WAN port of the VMG.
	LAN	Use this screen to view the status of all network traffic going through the LAN ports of the VMG.
	NAT	Use this screen to view NAT statistics for connected hosts.
ARP table	ARP table	Use this screen to view the ARP table. It displays the IP and MAC address of each DHCP connection.
Routing Table	Routing Table	Use this screen to view the routing table on the VMG.
Multicast Status	IGMP Status	Use this screen to view the status of all IGMP settings on the VMG.
	MLD Status	Use this screen to view the status of all MLD settings on the VMG.
xDSL Statistics	xDSL Statistics	Use this screen to view the VMG's xDSL traffic statistics.
3G Statistics	3G Statistics	Use this screen to look at 3G Internet connection status.
Maintenance		
System	System	Use this screen to set Device name and Domain name.
User Account	User Account	Use this screen to change user password on the VMG.
Remote Management	MGMT Services	Use this screen to enable specific traffic directions for network services.
	Trust Domain	Use this screen to view and manage a list of public IP addresses which are allowed to access the VMG through a configured service.
SNMP	SNMP	Use this screen to configure SNMP (Simple Network Management Protocol) settings.
Time	Time	Use this screen to change your VMG's time and date.
E-mail Notification	E-mail Notification	Use this screen to configure up to two mail servers and sender addresses on the VMG.
Log Setting	Log Setting	Use this screen to change your VMG's log settings.
Firmware Upgrade	Firmware Upgrade	Use this screen to upload firmware to your VMG.

Table 3 Navigation Panel Summary (continued)

LINK	TAB	FUNCTION
Backup/ Restore	Backup/Restore	Use this screen to backup and restore your VMG's configuration (settings) or reset the factory default settings.
Reboot	Reboot	Use this screen to reboot the VMG without turning the power off.
Diagnostic	Ping&Traceroute &Nslookup	Use this screen to identify problems with the DSL connection. You can use Ping, TraceRoute, or Nslookup to help you identify problems.
	802.1ag	Use this screen to configure CFM (Connectivity Fault Management) MD (maintenance domain) and MA (maintenance association), perform connectivity tests and view test reports.
	OAM Ping	Use this screen to view information to help you identify problems with the DSL connection.

Quick Start

3.1 Overview

Use the Quick Start screens to configure the VMG's time zone, basic Internet access, and wireless settings.

Note: See the technical reference chapters (starting on [Chapter 4 on page 31](#)) for background information on the features in this chapter.

3.2 Quick Start Setup

- 1 The Quick Start Wizard appears automatically after login. Or you can click the **Quick Start** icon in the top right corner of the web configurator to open the quick start screens. Select the time zone of your location. Click **Next**.

Figure 10 Quick Start - Welcome

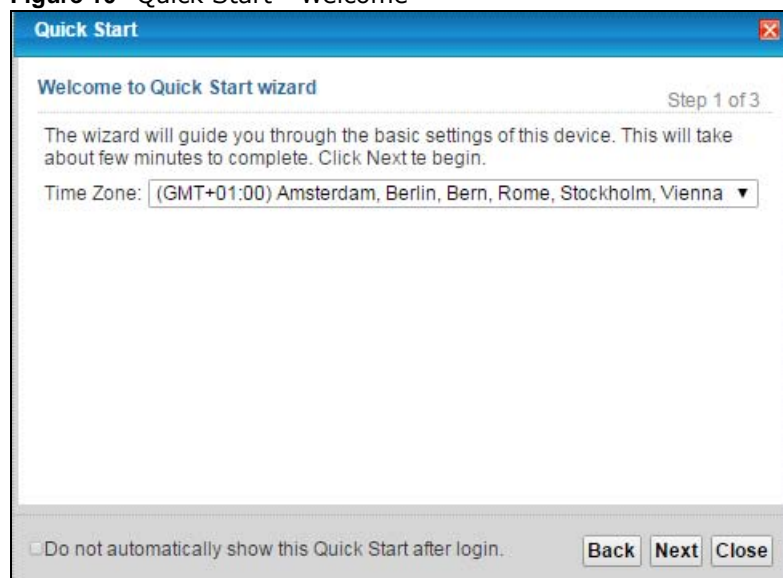

- 2 Enter your Internet connection information in this screen. The screen and fields to enter may vary depending on your current connection type. Click **Next**.

Figure 11 Quick Start - Internet Connection

Quick Start Step 2 of 3

The current connection type is set to **PPPoE** and needs a user name and password to get online.

User Name:

Password:
 password unmask

Is there specific IP address information from your Internet Service Provider (ISP)?
 Yes No

Then the IP Address information will be dynamically assigned to you from your ISP.

Do not automatically show this Quick Start after login. Back Next Close

- 3 Turn the wireless LAN on or off. If you keep it on, record the security settings so you can configure your wireless clients to connect to the VMG. Click **Save**.

Figure 12 Quick Start - Wireless

Quick Start Step 3 of 3

The following settings are the current wireless settings which your wireless client devices need in order to get connected to this device.

Wireless Service: Enable Disable

Wireless Network Name (SSID): ZyXEL_94E1

Security: WPA2-PSK

Password: *****

Do not automatically show this Quick Start after login. Back Save Close

- 4 Your VMG saves your settings and attempts to connect to the Internet.

4.1 Overview

This chapter shows you how to use the VMG's various features.

- [Setting Up an ADSL PPPoE Connection](#), see page 31
- [Setting Up a Secure Wireless Network](#), see page 34
- [Setting Up Multiple Wireless Groups](#), see page 41
- [Configuring Static Route for Routing to Another Network](#), see page 44
- [Configuring QoS Queue and Class Setup](#), see page 46
- [Access the VMG Using DDNS](#), see page 50
- [Configuring the MAC Address Filter](#), see page 51
- [Access Your Shared Files From a Computer](#), see page 53

4.2 Setting Up an ADSL PPPoE Connection

This tutorial shows you how to set up an ADSL Internet connection using the Web Configurator.

If you connect to the Internet through an ADSL connection, use the information from your Internet Service Provider (ISP) to configure the VMG. Be sure to contact your service provider for any information you need to configure the **Broadband** screens.

- 1 Click **Network Setting > Broadband** to open the following screen. Click **Add New WAN Interface**.

#	Name	Type	Mode	Enca...	802.1p	802.1q	IGMP Proxy	NAT	Default Gateway	IPv6	MLD Proxy	Modify
1	ADSL	ATM	Routing	IPoE	N/A	N/A	Y	Y	Y	Y	N	
2	VDSL	PTM	Routing	IPoE	N/A	N/A	Y	Y	Y	Y	N	

- 2 In this example, the DSL connection has the following information.

General	
Name	MyDSLConnection
Type	ADSL

Connection Mode	Routing
Encapsulation	PPPoE
IPv6/IPv4 Mode	IPv4
ATM PVC Configuration	
VPI/VCI	36/48
Encapsulation Mode	LLC/SNAP-Bridging
Service Category	UBR without PCR
Account Information	
PPP User Name	1234@DSL-Ex.com
PPP Password	ABCDEF!
PPPoE Service Name	MyDSL
Static IP Address	192.168.1.32
Others	Authentication Method: AUTO PPPoE Passthrough: Disabled NAT: Enabled IGMP Multicast Proxy: Enabled Apply as Default Gateway: Enabled VLAN: Disabled

- 3 Enter the **General** and **ATM PVC Configuration** settings as provided above.

Set the **Type** to **ADSL over ATM**.

Choose the **Encapsulation** specified by your DSL service provider. For this example, the service provider requires a username and password to establish Internet connection. Therefore, select **PPPoE** as the WAN encapsulation type.

Set the **IPv4/IPv6 Mode** to **IPv4 Only**.

- 4 Enter the account information provided to you by your DSL service provider.
- 5 Configure this rule as your default Internet connection by selecting the **Apply as Default Gateway** check box. Then select DNS as **Static** and enter the DNS server addresses provided to you, such as **192.168.5.2** (DNS server1)/**192.168.5.1** (DNS server2).
- 6 Leave the rest of the fields to the default settings.
- 7 Click **Apply** to save your settings.

Add New WAN Interface

General

Name: MyDSLConnection

Type: ADSL over ATM

Mode: Routing Bridge

Encapsulation: PPPoE

IPv4/IPv6 Mode: IPv4 Only

PPP Information

PPP User Name: 1234@DSL-Ex.com

PPP Password:

password unmask

PPP Connection Trigger: Auto Connect On Demand

PPPoE Passthrough: Enable Disable

IP Address

Obtain an IP Address Automatically

Static IP Address

IP Address: 192.168.1.32

ATM PVC Configuration

VPI [0-255]: 36

VCI [32-65535]: 48

Encapsulation: LLC/SNAP-BRIDGING

Service Category: UBR Without PCR

VLAN

Active: Enable Disable

802.1p: 0

802.1q: (0-4094)

MTU

MTU: 1492

Routing Feature

NAT Enable: Enable Disable

Fullcone NAT Enable: Enable Disable

IGMP Proxy Enable: Enable Disable

Apply as Default Gateway: Enable Disable

DNS server

Obtain DNS Info Automatically

Use Following Static DNS Address

Primary DNS Server: 192.168.5.2

Secondary DNS Server: 192.168.5.1

6RD

6RD: Enable Disable

OK Cancel

- 8 You should see a summary of your new DSL connection setup in the **Broadband** screen as follows.

Broadband 3G Backup Advanced 802.1x

You can configure the Internet settings of this device. Correct configurations build successful Internet connection.

Add New WAN Interface

#	Name	Type	Mode	Encap...	802.1p	802.1q	IgmpP...	NAT	Defau...	IPv6	MLD Proxy	Modify
1	ADSL	ATM	Routin g	IPoE	N/A	N/A	Y	Y	N	N	N	
2	VDSL	PTM	Routin g	PPPoE	N/A	N/A	Y	Y	Y	N	N	
3	ETHW AN	ETH	Routin g	IPoE	N/A	N/A	Y	Y	Y	N	N	
4	MyDSL Conne ction	ATM	Routin g	PPPoE	N/A	N/A	Y	Y	Y	N	N	

Try to connect to a website to see if you have correctly set up your Internet connection. Be sure to contact your service provider for any information you need to configure the WAN screens.

4.3 Setting Up a Secure Wireless Network

Thomas wants to set up a wireless network so that he can use his notebook to access the Internet. In this wireless network, the VMG serves as an access point (AP), and the notebook is the wireless client. The wireless client can access the Internet through the AP.



Thomas has to configure the wireless network settings on the VMG. Then he can set up a wireless network using WPS ([Section 4.3.2 on page 36](#)) or manual configuration ([Section 4.3.3 on page 40](#)).

4.3.1 Configuring the Wireless Network Settings

This example uses the following parameters to set up a wireless network.

SSID	Example
Security Mode	WPA2-PSK
Pre-Shared Key	DoNotStealMyWirelessNetwork
802.11 Mode	802.11b/g/n Mixed

- 1 Click **Network Setting** > **Wireless** to open the **General** screen. Select **More Secure** as the security level and **WPA2-PSK** as the security mode. Configure the screen using the provided parameters (see [page 34](#)). Click **Apply**.

Wireless Network Setup

Bandwidth

Wireless Enable Disable (settings are invalid when disabled)

Channel Current: 6

Bandwidth

Control Sideband

Passphrase Type

Wireless Network Settings

Wireless Network Name

Max Clients

Hide SSID

Multicast Forwarding

Max. Upstream Bandwidth Kbps

Max. Downstream Bandwidth Kbps

Note

1. Max. Upstream Bandwidth: This field allow user configure the maximum bandwidth of this SSID to WAN.
2. Max. Downstream Bandwidth: This field allow user configure the maximum bandwidth of WAN to this SSID.
3. If Max. Upstream/Downstream Bandwidth is empty, the CPE sets the value automatically.

BSSID

Security Level

No Security Basic **More Secure (Recommended)**

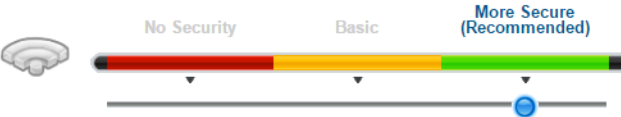

Security Mode

Generate password automatically

Enter 8-63 ASCII characters or 64 hexadecimal digits ("0-9", "A-F").

Password [more...](#)

password unmask

- 2 Go to the **Wireless > Others** screen and select **802.11b/g/n Mixed** in the **802.11 Mode** field. Click **Apply**.

RTS/CTS Threshold :	<input type="text" value="2347"/>
Fragmentation Threshold :	<input type="text" value="2346"/>
Auto Channel Timer :	<input type="text" value="0"/> min
Output Power :	<input type="text" value="100%"/>
Beacon Interval :	<input type="text" value="100"/> ms
DTIM Interval :	<input type="text" value="1"/> ms
802.11 Mode :	<input type="text" value="802.11b/g/n Mixed"/>
802.11 Protection :	<input type="text" value="Off"/>
RIFS Advertisement	<input type="text" value="Auto"/>
Preamble :	<input type="text" value="Long"/>
RX Chain Power Save	<input checked="" type="radio"/> Enable <input type="radio"/> Disable
OBSS Coexistence	<input checked="" type="radio"/> Enable <input type="radio"/> Disable
XPress™ Technology :	<input checked="" type="radio"/> Enable <input type="radio"/> Disable
WPS 2.0 :	<input checked="" type="radio"/> Enable <input type="radio"/> Disable
<input type="button" value="Apply"/> <input type="button" value="Cancel"/>	

Thomas can now use the WPS feature to establish a wireless connection between his notebook and the VMG (see [Section 4.3.2 on page 36](#)). He can also use the notebook's wireless client to search for the VMG (see [Section 4.3.3 on page 40](#)).

4.3.2 Using WPS

This section shows you how to set up a wireless network using WPS. It uses the VMG as the AP and ZyXEL NWD210N as the wireless client which connects to the notebook.

Note: The wireless client must be a WPS-aware device (for example, a WPS USB adapter or PCMCIA card).

There are two WPS methods to set up the wireless client settings:

- **Push Button Configuration (PBC)** - simply press a button. This is the easier of the two methods.
- **PIN Configuration** - configure a Personal Identification Number (PIN) on the VMG. A wireless client must also use the same PIN in order to download the wireless network settings from the VMG.

Push Button Configuration (PBC)

- 1 Make sure that your VMG is turned on and your notebook is within the cover range of the wireless signal.
- 2 Make sure that you have installed the wireless client driver and utility in your notebook.
- 3 In the wireless client utility, go to the WPS setting page. Enable WPS and press the WPS button (**Start** or **WPS** button).

- 4 Push and hold the **WPS** button located on the VMG's front panel for more than 5 seconds. Alternatively, you may log into VMG's web configurator and go to the **Network Setting > Wireless > WPS** screen. Enable the WPS function for method 1 and click **Apply**. Then click the **Connect** button.

General

WPS Enable Disable (settings are invalid when disabled)

Add a new device with WPS Method

Method 1 PBC	Method 2 PIN	Method 3
<input checked="" type="radio"/> Enable <input type="radio"/> Disable	<input checked="" type="radio"/> Enable <input type="radio"/> Disable	<input type="radio"/> Enable <input checked="" type="radio"/> Disable
<p>Step 1. Click WPS button (WPS)</p> <p>Step 2. Press the WPS button on your new wireless client device within 120 seconds</p>	<p>Step 1. Enter the PIN of your new wireless client device and then click Register</p> <p>Enter PIN here <input type="text"/> Register <input type="button"/></p> <p>Step 2. Press the WPS button on your new wireless client device within 120 seconds</p>	<p>Enter AP's PIN Number in Wireless Client</p> <p>Current state: Configured</p> <p>1. Please release configuration if you want to configure the wireless settings</p> <p>Release Configuration <input type="button"/></p> <p>2. Enter current PIN number on your wireless client</p> <p>Generate New PIN <input type="button"/></p>

Note

1.If WPS is Enabled, UPnP will automatically be turned on.
2.This feature is available only when WPA-PSK, WPA2-PSK or No Security mode is configured.

Apply Cancel

Note: Your VMG has a WPS button located on its front panel as well as a WPS button in its configuration utility. Both buttons have exactly the same function: you can use one or the other.

Note: It doesn't matter which button is pressed first. You must press the second button within two minutes of pressing the first one.

The VMG sends the proper configuration settings to the wireless client. This may take up to two minutes. The wireless client is then able to communicate with the VMG securely.

The following figure shows you an example of how to set up a wireless network and its security by pressing a button on both VMG and wireless client.

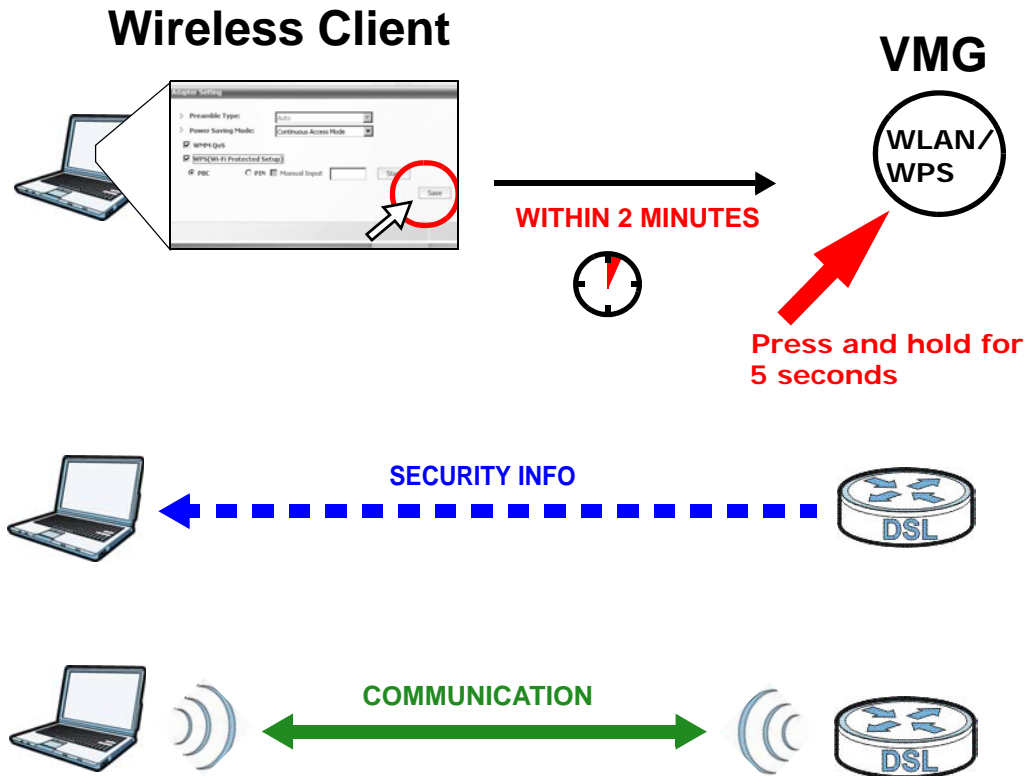

PIN Configuration

When you use the PIN configuration method, you need to use both the VMG's web configurator and the wireless client's utility.

- 1 Launch your wireless client's configuration utility. Go to the WPS settings and select the PIN method to get a PIN number.
- 2 Log into VMG's web configurator and go to the **Network Setting > Wireless > WPS** screen. Enable the WPS function and click **Apply**.

General

WPS Enable Disable (settings are invalid when disabled)

Add a new device with WPS Method

Method 1	Method 2 PIN	Method 3
<input checked="" type="radio"/> Enable <input type="radio"/> Disable PBC	<input checked="" type="radio"/> Enable <input type="radio"/> Disable PIN	<input type="radio"/> Enable <input checked="" type="radio"/> Disable Push Button
<p>Step 1. Click WPS button <input type="button" value="WPS"/></p> <p>Step 2. Press the WPS button on your new wireless client device within 120 seconds</p>	<p>Step 1. Enter the PIN of your new wireless client device and then click Register <input type="button" value="Register"/></p> <p>Step 2. Press the WPS button on your new wireless client device within 120 seconds</p>	<p>Enter AP's PIN Number in Wireless Client Current state: Configured</p> <p>1. Please release configuration if you want to configure the wireless settings <input type="button" value="Release Configuration"/></p> <p>2. Enter current PIN number on your wireless client <input type="button" value="Generate New PIN"/></p>

Note

- If WPS is Enabled, UPnP will automatically be turned on.
- This feature is available only when WPA-PSK, WPA2-PSK or No Security mode is configured.

- Enter the PIN number of the wireless client and click the **Register** button. Activate WPS function on the wireless client utility screen within two minutes.

The VMG authenticates the wireless client and sends the proper configuration settings to the wireless client. This may take up to two minutes. The wireless client is then able to communicate with the VMG securely.

The following figure shows you how to set up a wireless network and its security on a VMG and a wireless client by using PIN method.

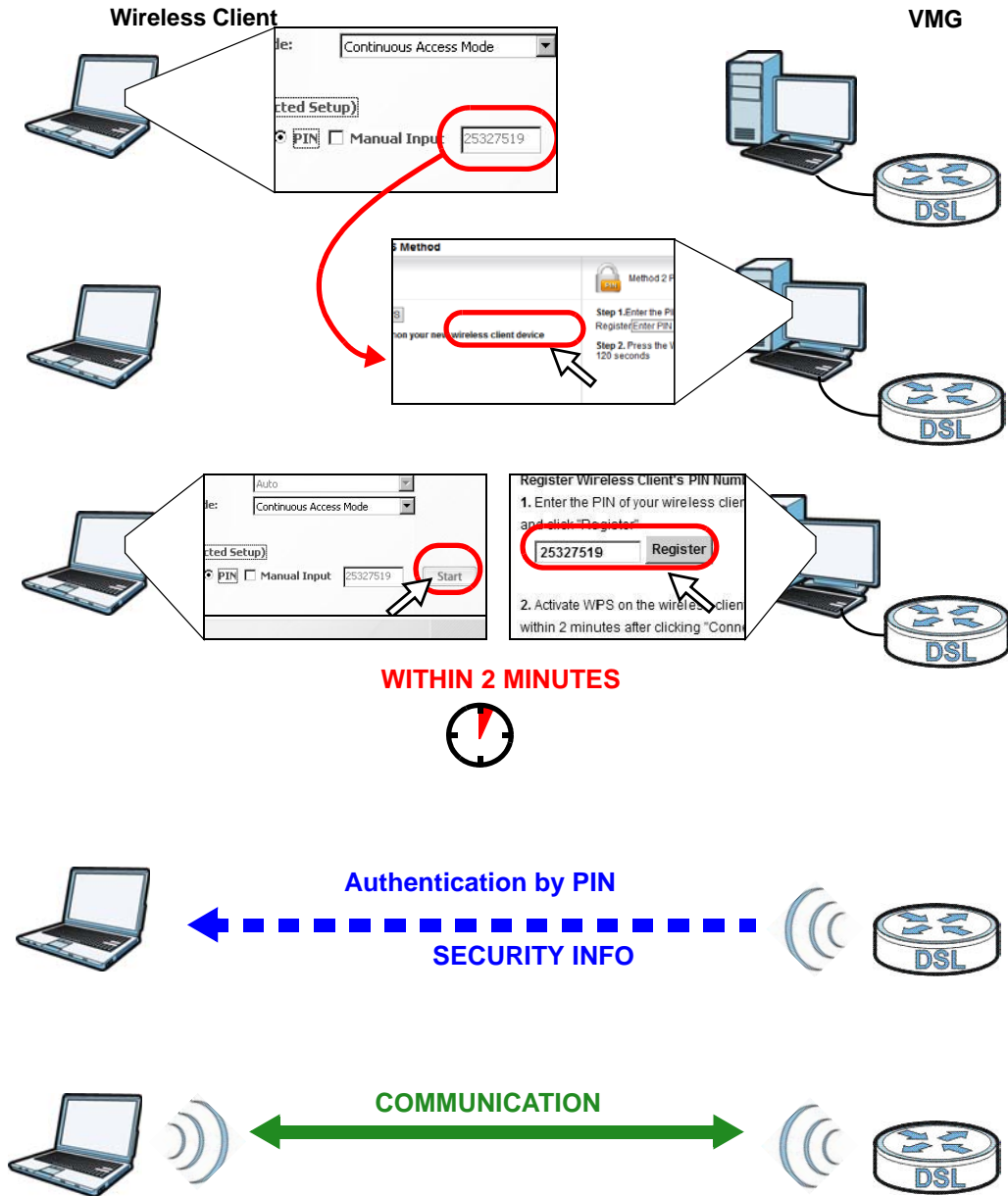

4.3.3 Without WPS

Use the wireless adapter's utility installed on the notebook to search for the "Example" SSID. Then enter the "DoNotStealMyWirelessNetwork" pre-shared key to establish an wireless Internet connection.

Note: The VMG supports IEEE 802.11b and IEEE 802.11g wireless clients. Make sure that your notebook or computer's wireless adapter supports one of these standards.

4.4 Setting Up Multiple Wireless Groups

Company A wants to create different wireless network groups for different types of users as shown in the following figure. Each group has its own SSID and security mode.

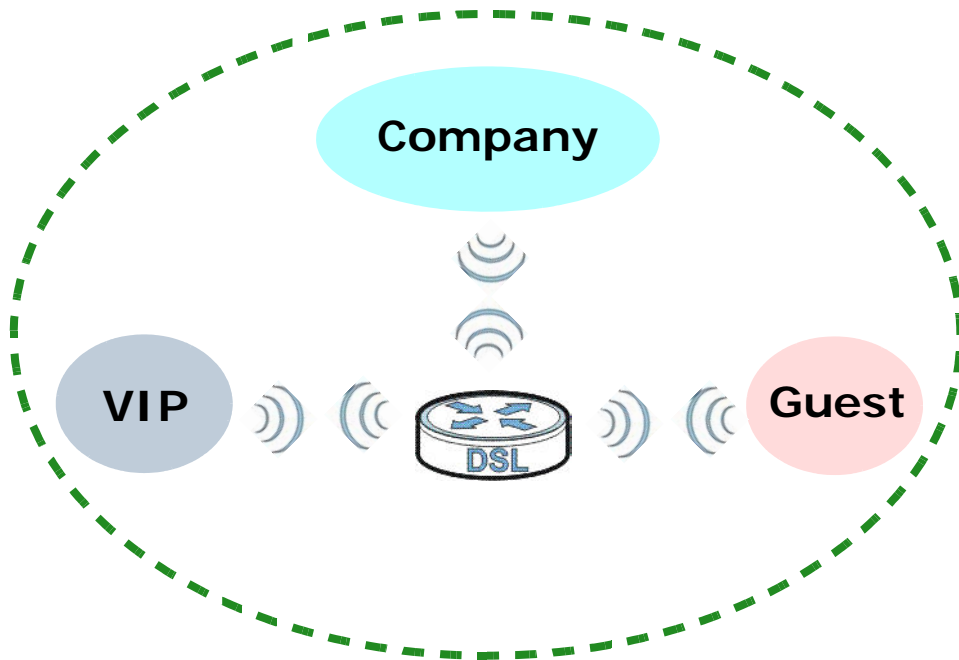

- Employees in Company A will use a general **Company** wireless network group.
- Higher management level and important visitors will use the **VIP** group.
- Visiting guests will use the **Guest** group, which has a different SSID and password.

Company A will use the following parameters to set up the wireless network groups.

	COMPANY	VIP	GUEST
SSID	Company	VIP	Guest
Security Level	More Secure	More Secure	More Secure
Security Mode	WPA2-PSK	WPA2-PSK	WPA2-PSK
Pre-Shared Key	ForCompanyOnly	123456789	guest123

- 1 Click **Network Setting > Wireless** to open the **General** screen. Use this screen to set up the company's general wireless network group. Configure the screen using the provided parameters and click **Apply**.

Wireless Network Setup

Bandwidth: 2.4GHz
 Wireless: Enable Disable (settings are invalid when disabled)
 Channel: Auto Current: 6
 Bandwidth: 40MHz
 Control Sideband: Lower
 Passphrase Type: None

Wireless Network Settings

Wireless Network Name: Company
 Max Clients: 32
 Hide SSID
 Multicast Forwarding
 Max. Upstream Bandwidth: _____ Kbps
 Max. Downstream Bandwidth: _____ Kbps

Note

1. Max. Upstream Bandwidth: This field allow user configure the maximum bandwidth of this SSID to WAN.
2. Max. Downstream Bandwidth: This field allow user configure the maximum bandwidth of WAN to this SSID.
3. If Max. Upstream/Downstream Bandwidth is empty, the CPE sets the value automatically.

BSSID: 02:10:18:01:00:02

Security Level

No Security Basic **More Secure (Recommended)**



Security Mode: WPA2-PSK
 Generate password automatically
 Enter 8-63 ASCII characters or 64 hexadecimal digits ("0-9", "A-F").
 Password: ForCompanyOnly [more...](#)
 password unmask

Apply Cancel

- 2 Click **Network Setting > Wireless > Guest/More AP** to open the following screen. Click the **Edit** icon to configure the second wireless network group.

General **Guest/More AP** MAC Authentication WPS WMM WDS Others Channel Status

This device can enable up to 4 wireless networks to work at the same time. Assign a name and a security level (if needed) to start the 2nd, 3rd, and 4th wireless network services.

#	Status	SSID	Security	Guest WLAN	Modify
1	⚡	ZyXEL_Guest	WPA2-Personal	External Guest	
2	⚡	ZyXEL_Guest	WPA2-Personal	External Guest	
3	⚡	ZyXEL_Guest	WPA2-Personal	External Guest	

- 3 Configure the screen using the provided parameters and click **Apply**.

Wireless Network Setup

Wireless Enable Disable (settings are invalid when disabled)

Passphrase Type

Wireless Network Settings

Wireless Network Name(SSID):

Hide SSID

Multicast Forwarding

Guest WLAN

Access Scenario:

Max. Upstream Bandwidth: Kbps

Max. Downstream Bandwidth: Kbps

Note:

1. Max. Upstream Bandwidth: This field allow user configure the maximum bandwidth of this SSID to WAN.
2. Max. Downstream Bandwidth: This field allow user configure the maximum bandwidth of WAN to this SSID.
3. If Max. Upstream/Downstream Bandwidth is empty, the CPE sets the value automatically.

SSID Subnet: Enable Disable

Security Level

No Security Basic **More Secure (Recommended)**

Security Mode

Generate password automatically

Enter 8-63 ASCII characters or 64 hexadecimal digits ("0-9", "A-F").

Password [more...](#)

password unmask

OK Cancel

- 4 In the **Guest/More AP** screen, click the **Edit** icon to configure the third wireless network group. Configure the screen using the provided parameters and click **Apply**.

Wireless Network Setup

Wireless Enable Disable (settings are invalid when disabled)

Passphrase Type

Wireless Network Settings

Wireless Network Name(SSID):

Hide SSID

Multicast Forwarding

Guest WLAN

Access Scenario:

Max. Upstream Bandwidth: Kbps

Max. Downstream Bandwidth: Kbps

Note:

1. Max. Upstream Bandwidth: This field allow user configure the maximum bandwidth of this SSID to WAN.
2. Max. Downstream Bandwidth: This field allow user configure the maximum bandwidth of WAN to this SSID.
3. If Max. Upstream/Downstream Bandwidth is empty, the CPE sets the value automatically.

SSID Subnet: Enable Disable

Security Level

No Security Basic **More Secure (Recommended)**

Security Mode

Generate password automatically







Enter 8-63 ASCII characters or 64 hexadecimal digits ("0-9", "A-F").

Password [more...](#)

password unmask

OK Cancel

- 5 Check the status of **VIP** and **Guest** in the **Guest/More AP** screen. The yellow bulbs signify that the SSIDs are active and ready for wireless access.

#	Status	SSID	Security	Guest WLAN	Modify
1		VIP	WPA2-Personal	External Guest	
2		Guest	WPA2-Personal	External Guest	
3		ZyXEL_Guest	WPA2-Personal	External Guest	

4.5 Configuring Static Route for Routing to Another Network

In order to extend your Intranet and control traffic flowing directions, you may connect a router to the VMG's LAN. The router may be used to separate two department networks. This tutorial shows how to configure a static routing rule for two network routings.

In the following figure, router **R** is connected to the VMG's LAN. **R** connects to two networks, **N1** (192.168.1.x/24) and **N2** (192.168.10.x/24). If you want to send traffic from computer **A** (in **N1**

network) to computer **B** (in **N2** network), the traffic is sent to the VMG's WAN default gateway by default. In this case, **B** will never receive the traffic.

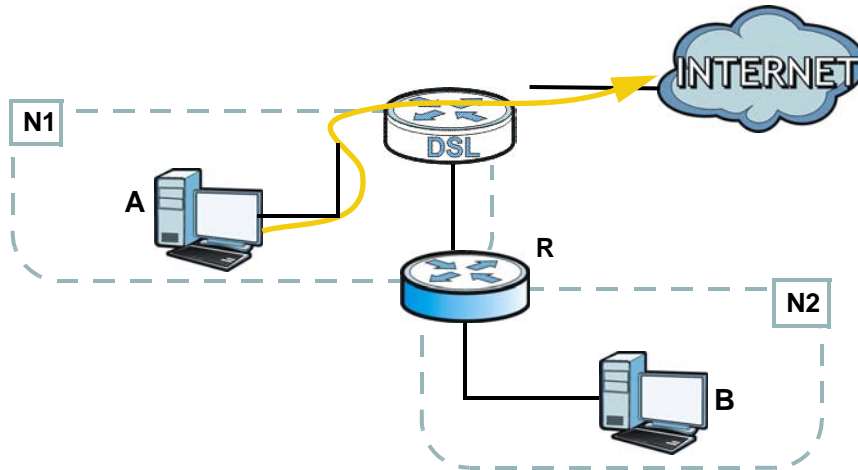

You need to specify a static routing rule on the VMG to specify **R** as the router in charge of forwarding traffic to **N2**. In this case, the VMG routes traffic from **A** to **R** and then **R** routes the traffic to **B**.

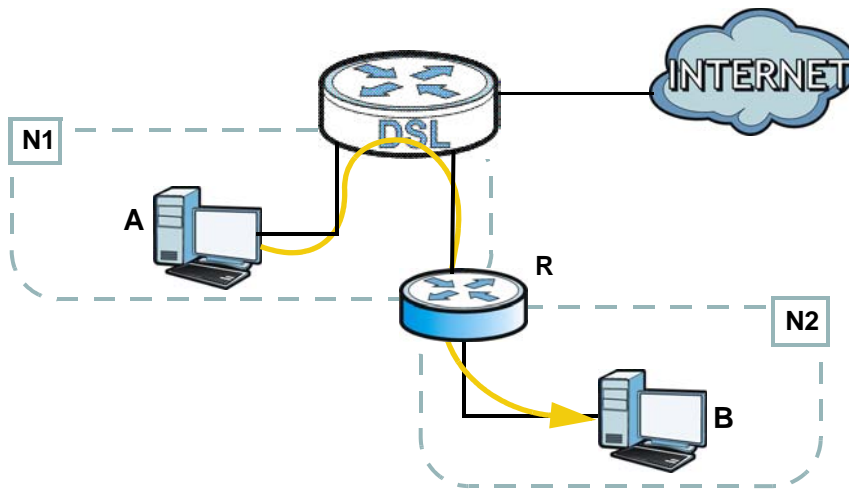

This tutorial uses the following example IP settings:

Table 4 IP Settings in this Tutorial

DEVICE / COMPUTER	IP ADDRESS
The VMG's WAN	172.16.1.1
The VMG's LAN	192.168.1.1
IP Type	IPv4
Use Interface	VDSL/ppp1.1
A	192.168.1.34
R's N1	192.168.1.253

Table 4 IP Settings in this Tutorial

DEVICE / COMPUTER	IP ADDRESS
R's N2	192.168.10.2
B	192.168.10.33

To configure a static route to route traffic from **N1** to **N2**:

- 1 Log into the VMG's Web Configurator in advanced mode.
- 2 Click **Network Setting > Routing**.
- 3 Click **Add new Static Route** in the **Static Route** screen.

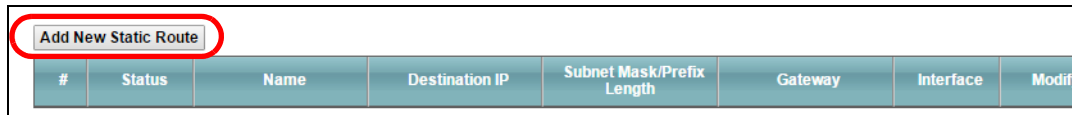

#	Status	Name	Destination IP	Subnet Mask/Prefix Length	Gateway	Interface	Modif
---	--------	------	----------------	---------------------------	---------	-----------	-------

- 4 Configure the **Static Route Setup** screen using the following settings:
 - 4a Select the **Active** check box. Enter the **Route Name** as **R**.
 - 4b Set **IP Type** to **IPv4**.
 - 4c Type **192.168.10.0** and subnet mask **255.255.255.0** for the destination, **N2**.
 - 4d Select **Enable** in the **Use Gateway IP Address** field. Type **192.168.1.253** (**R**'s N1 address) in the **Gateway IP Address** field.
 - 4e Select **VDSL/ppp1.1** as the **Use Interface**.

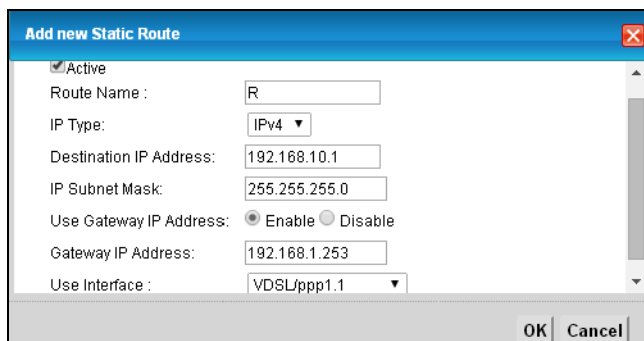

- 4a Click **OK**.

Now **B** should be able to receive traffic from **A**. You may need to additionally configure **B**'s firewall settings to allow specific traffic to pass through.

4.6 Configuring QoS Queue and Class Setup

This section contains tutorials on how you can configure the QoS screen.

Let's say you are a team leader of a small sales branch office. You want to prioritize e-mail traffic because your task includes sending urgent updates to clients at least twice every hour. You also upload data files (such as logs and e-mail archives) to the FTP server throughout the day. Your colleagues use the Internet for research, as well as chat applications for communicating with other branch offices.

In the following figure, your Internet connection has an upstream transmission bandwidth of 10,000 kbps. For this example, you want to configure QoS so that e-mail traffic gets the highest priority with at least 5,000 kbps. You can do the following:

- Configure a queue to assign the highest priority queue (1) to e-mail traffic going to the WAN interface, so that e-mail traffic would not get delayed when there is network congestion.
- Note the IP address (192.168.1.23 for example) and/or MAC address (AA:FF:AA:FF:AA:FF for example) of your computer and map it to queue 7.

Note: QoS is applied to traffic flowing out of the VMG.

Traffic that does not match this class is assigned a priority queue based on the internal QoS mapping table on the VMG.

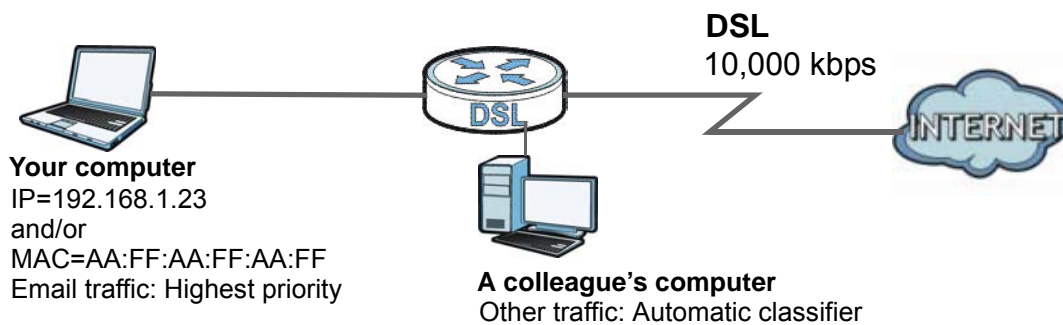

- 1 Click **Network Setting > QoS > General** and select **Enable**. Set your **WAN Managed Upstream Bandwidth** to 10,000 kbps (or leave this blank to have the VMG automatically determine this figure). Click **Apply**.

QoS Enable Disable (settings are invalid when disabled)

WAN Managed Upstream Bandwidth : (kbps)

LAN Managed Downstream Bandwidth : (kbps)

Upstream traffic priority Assigned by:

Note:

You can assign the upstream bandwidth manually. If the field is empty, the CPE sets the value automatically.

If Enable QoS checkbox is selected, choose a default DSCP mark to automatically mark incoming traffic without reference to a particular classifier.

If the setting of WAN managed upstream bandwidth is greater than current WAN interface linkup rate, then the WAN managed upstream bandwidth will become current WAN interface linkup rate.

- 2 Click **Queue Setup > Add new Queue** to create a new queue. In the screen that opens, select **Enable** and enter or select the following values:

- **Name:** E-mail

- **Interface:** WAN
- **Priority:** 1 (High)
- **Weight:** 8
- **Rate Limit:** 5,000 (kbps)

The screenshot shows a dialog box titled "Add New Queue". It contains the following settings:

Active	<input checked="" type="radio"/> Enable <input type="radio"/> Disable
Name	E-mail
Interface	WAN
Priority	1(Highest)
Weight	8
Buffer Management	Drop Tail (DT)
Rate Limit (kbps)	5000 (kbps)

Buttons: OK, Cancel

- 3 Click **Class Setup > Add new Classifier** to create a new class. Check **Active** and follow the settings as shown in the screen below.

Please follow the guidance through step 1~5 to configure a QoS rule

Step1: Class Configuration

Active

Class Name :

Classification Order :

Step2: Criteria configuration

Use the configurations below to specify the characteristics of a data flow need to be managed by this QoS rule

▪ **Basic**

From Interface :

Ether Type :

▪ **Source**

Address Subnet Netmask Exclude

Port Range ~ Exclude

MAC MAC Mask Exclude

▪ **Destination**

Address Subnet Netmask Exclude

Port Range ~ Exclude

MAC MAC Mask Exclude

▪ **Others**

Service Exclude

IP protocol Exclude

DHCP Exclude

Packet Length ~ Exclude

DSCP (0~63) Exclude

802.1P Exclude

VLAN ID (0~4094) Exclude

TCP ACK Exclude

Step3: Packet modification

The content of the packet can be modified by applying the following settings:

DSCP Mark : (0~63)

802.1P Mark :

VLAN ID : (0~4094)

Step4: Policy Forwarding

This module can route or bridge packets to certain interface according to the class settings:

Forward To Interface :

Step5: Outgoing queue selection

Outgoing queue decide the priority of the traffic and how traffic should be shaped in the WAN interface. Choose "None" if you don't want to apply outgoing queue

To Queue Index :

Class Name	Give a class name to this traffic, such as E-mail in this example.
From Interface	This is the interface from which the traffic will be coming from. Select LAN1 for this example.
Ether Type	Select IP to identify the traffic source by its IP address or MAC address.
IP Address	Type the IP address of your computer - 192.168.1.23 . Type the IP Subnet Mask if you know it.
MAC Address	Type the MAC address of your computer - AA:FF:AA:FF:AA:FF . Type the MAC Mask if you know it.
To Queue Index	Link this to an item in the Network Setting > QoS > Queue Setup screen, which is the E-mail queue created in this example.

This maps e-mail traffic coming from port 25 to the highest priority, which you have created in the previous screen (see the **IP Protocol** field). This also maps your computer's IP address and MAC address to the **E-mail** queue (see the **Source** fields).

- 4 Verify that the queue setup works by checking **Network Setting > QoS > Monitor**. This shows the bandwidth allotted to e-mail traffic compared to other network traffic.

4.7 Access the VMG Using DDNS

If you connect your VMG to the Internet and it uses a dynamic WAN IP address, it is inconvenient for you to manage the device from the Internet. The VMG's WAN IP address changes dynamically. Dynamic DNS (DDNS) allows you to access the VMG using a domain name.

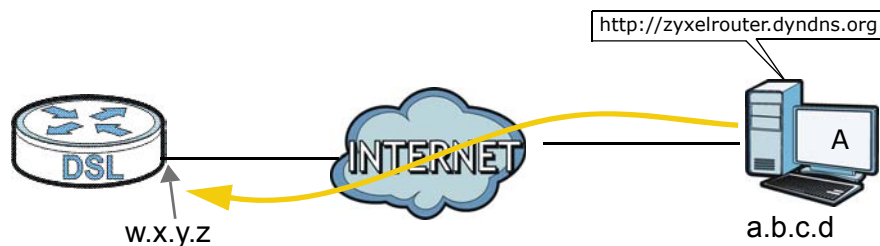

To use this feature, you have to apply for DDNS service at www.dyndns.org.

This tutorial covers:

- [Registering a DDNS Account on \[www.dyndns.org\]\(http://www.dyndns.org\)](#)
- [Configuring DDNS on Your VMG](#)
- [Testing the DDNS Setting](#)

Note: If you have a private WAN IP address, then you cannot use DDNS.

4.7.1 Registering a DDNS Account on www.dyndns.org

- 1 Open a browser and type **http://www.dyndns.org**.
- 2 Apply for a user account. This tutorial uses **UserName1** and **12345** as the username and password.
- 3 Log into www.dyndns.org using your account.
- 4 Add a new DDNS host name. This tutorial uses the following settings as an example.
 - Hostname: **zyxelrouter.dyndns.org**
 - Service Type: **Host with IP address**
 - IP Address: Enter the WAN IP address that your VMG is currently using. You can find the IP address on the VMG's Web Configurator **Status** page.

Then you will need to configure the same account and host name on the VMG later.

4.7.2 Configuring DDNS on Your VMG

Configure the following settings in the **Network Setting > DNS > Dynamic DNS** screen.

- Select **Enable Dynamic DNS**.
- Select **www.DynDNS.com** as the service provider.
- Type **zyxelrouter.dyndns.org** in the **Host Name** field.
- Enter the user name (**UserName1**) and password (**12345**).

Dynamic DNS Setup

Dynamic DNS: Enable Disable

Service Provider:

Hostname:

Username:

Password:

Dynamic DNS Status

User Authentication Result:

Last Updated Time:

Current Dynamic IP:

Click **Apply**.

4.7.3 Testing the DDNS Setting

Now you should be able to access the VMG from the Internet. To test this:

- 1 Open a web browser on the computer (using the IP address **a.b.c.d**) that is connected to the Internet.
- 2 Type **http://zyxelrouter.dyndns.org** and press [Enter].
- 3 The VMG's login page should appear. You can then log into the VMG and manage it.

4.8 Configuring the MAC Address Filter

Thomas noticed that his daughter Josephine spends too much time surfing the web and downloading media files. He decided to prevent Josephine from accessing the Internet so that she can concentrate on preparing for her final exams.

Josephine's computer connects wirelessly to the Internet through the VMG. Thomas decides to use the **Security > MAC Filter** screen to grant wireless network access to his computer but not to Josephine's computer.

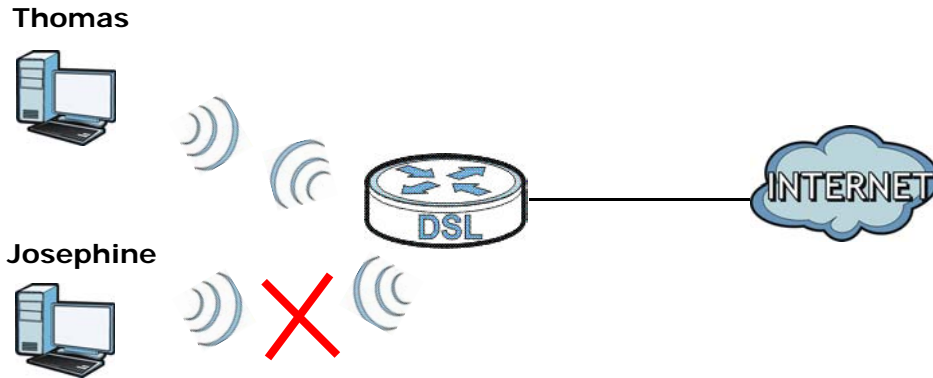

- 1 Click **Security** > **MAC Filter** to open the **MAC Filter** screen. Select **Enable** to activate MAC filter function and **Allow** to permit the listed MAC addresses access to the VMG.
- 2 Select **Active**. Then enter the host name and MAC address of Thomas' computer in this screen. Click **Apply**.

MAC Address Filter

MAC Restrict Mode

Enable Disable (settings are invalid when disabled)

Allow Deny

Set	Active	Host Name	MAC Address
1	<input checked="" type="checkbox"/>	Thomas	00 - 24 - 21 - AB - 1F - 05
2	<input type="checkbox"/>		- - - - -
3	<input type="checkbox"/>		- - - - -
4	<input type="checkbox"/>		- - - - -
5	<input type="checkbox"/>		- - - - -
6	<input type="checkbox"/>		- - - - -
7	<input type="checkbox"/>		- - - - -
8	<input type="checkbox"/>		- - - - -
9	<input type="checkbox"/>		- - - - -
10	<input type="checkbox"/>		- - - - -
...			
32	<input type="checkbox"/>		- - - - -

Note:
Only devices listed here are granted access to the network.

Apply Cancel

Thomas can also grant access to the computers of other members of his family and friends. However, Josephine and others not listed in this screen will no longer be able to access the Internet through the VMG.

4.9 Access Your Shared Files From a Computer

Here is how to use an FTP program to access a file storage device connected to the VMG's USB port.

Note: This example uses the FileZilla FTP program to browse your shared files.

- 1 In FileZilla enter the IP address of the VMG (the default is 192.168.1.1), your account's user name and password and port 21 and click **Quickconnect**. A screen asking for password authentication appears.

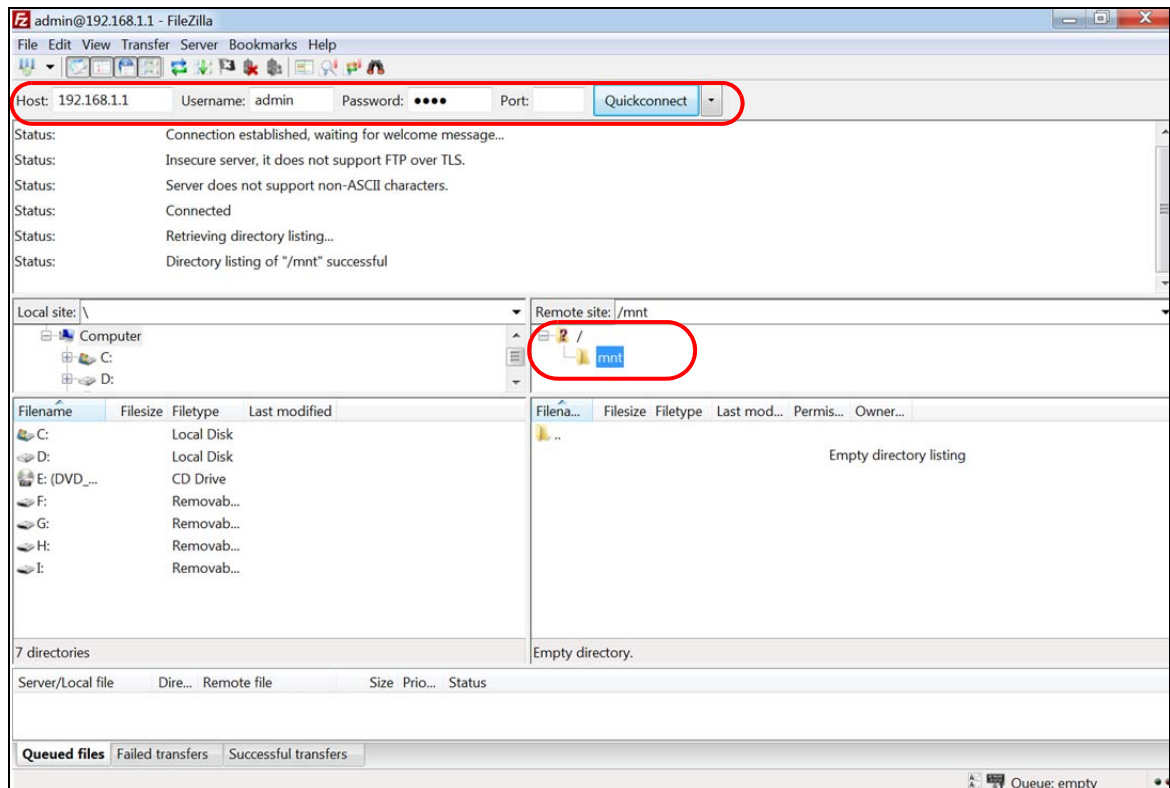

- 2 Once you log in the USB device displays in the **mnt** folder.

PART II

Technical Reference

Network Map and Status Screens

5.1 Overview

After you log into the Web Configurator, the **Network Map** screen appears. This shows the network connection status of the VMG and clients connected to it.

You can use the **Status** screen to look at the current status of the VMG, system resources, and interfaces (LAN, WAN, and WLAN).

5.2 The Network Map Screen

Use this screen to view the network connection status of the device and its clients. A warning message appears if there is a connection problem.

Figure 13 Network Map: Icon View Mode



If you want to view information about a client, click the client's name and **Info**. Click the IP address if you want to change it. If you want to change the name or icon of the client, click **Change name/icon**.

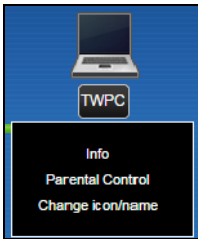

If you prefer to view the status in a list, click **List View** in the **Viewing mode** selection box. You can configure how often you want the VMG to update this screen in **Refresh interval**.

Figure 14 Network Map: List View Mode



5.3 The Status Screen

Use this screen to view the status of the VMG. Click **Status** to open this screen.

Figure 15 Status Screen

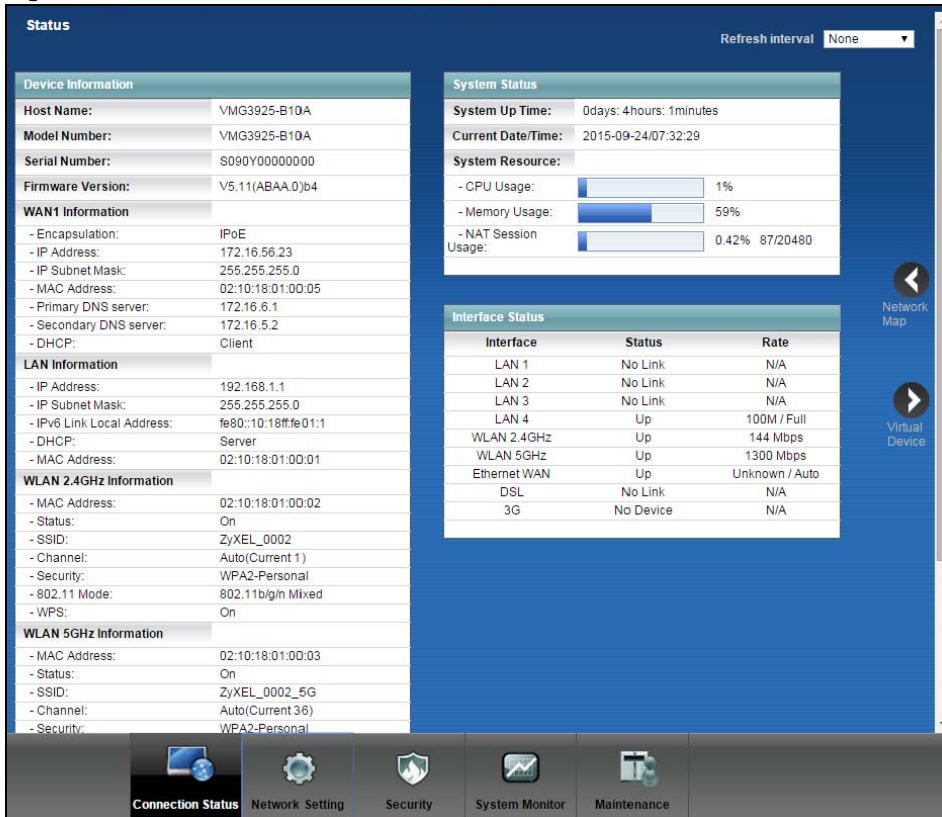

Each field is described in the following table.

Table 5 Status Screen

LABEL	DESCRIPTION
Refresh Interval	Select how often you want the VMG to update this screen.
Device Information	
Host Name	This field displays the VMG system name. It is used for identification.
Model Number	This shows the model number of your VMG.
Firmware Version	This is the current version of the firmware inside the VMG.
WAN Information (These fields display when you have a WAN connection.)	
Encapsulation	This field displays the current encapsulation method.
IP Address	This field displays the current IP address of the VMG in the WAN. Click Release to release your IP address to 0.0.0.0. If you want to renew your IP address, click Renew .
IP Subnet Mask	This field displays the current subnet mask in the WAN.
MAC Address	This shows the WAN Ethernet adapter MAC (Media Access Control) Address of your VMG.
Primary DNS server	This shows the primary DNS server IP address.
Secondary DNS server	This shows the secondary DNS server IP address.
DHCP	This field displays whether the WAN interface is using a DHCP IP address or a static IP address. Choices are: Client - The WAN interface can obtain an IP address from a DHCP server. None - The WAN interface is using a static IP address.
LAN Information	
IP Address	This is the current IP address of the VMG in the LAN.
IP Subnet Mask	This is the current subnet mask in the LAN.
IPv6 Link Local Address	This is the current IPv6 link local address of the VMG in the LAN.
DHCP	This field displays what DHCP services the VMG is providing to the LAN. The possible values are: Server - The VMG is a DHCP server in the LAN. It assigns IP addresses to other computers in the LAN. Relay - The VMG acts as a surrogate DHCP server and relays DHCP requests and responses between the remote server and the clients. None - The VMG is not providing any DHCP services to the LAN.
MAC Address	This shows the LAN Ethernet adapter MAC (Media Access Control) Address of your VMG.
WLAN 2.4GHz Information / WLAN 5GHz Information	
MAC Address	This shows the wireless adapter MAC (Media Access Control) Address of the wireless interface.
Status	This displays whether the WLAN is activated.
SSID	This is the descriptive name used to identify the VMG in a wireless LAN.
Channel	This is the channel number used by the wireless interface now.
Security	This displays the type of security mode the wireless interface is using in the wireless LAN.
802.11 Mode	This displays the type of 802.11 mode the wireless interface is using in the wireless LAN.
WPS	This displays whether WPS is activated on the wireless interface.

Table 5 Status Screen (continued)

LABEL	DESCRIPTION
Security	
Firewall	This displays the firewall's current security level.
System Status	
System Up Time	This field displays how long the VMG has been running since it last started up. The VMG starts up when you plug it in, when you restart it (Maintenance > Reboot), or when you reset it.
Current Date/ Time	This field displays the current date and time in the VMG. You can change this in Maintenance > Time Setting .
System Resource	
CPU Usage	This field displays what percentage of the VMG's processing ability is currently used. When this percentage is close to 100%, the VMG is running at full load, and the throughput is not going to improve anymore. If you want some applications to have more throughput, you should turn off other applications (for example, using QoS; see Chapter 10 on page 139).
Memory Usage	This field displays what percentage of the VMG's memory is currently used. Usually, this percentage should not increase much. If memory usage does get close to 100%, the VMG is probably becoming unstable, and you should restart the device. See Section 37.2 on page 250 , or turn off the device (unplug the power) for a few seconds.
NAT Session Usage	This field displays what percentage of the VMG supported NAT sessions are currently being used. This field also displays the number of active NAT sessions and the maximum number of NAT sessions the VMG can support.
Interface Status	
Interface	This column displays each interface the VMG has.
Status	<p>This field indicates the interface's use status.</p> <p>For the LAN and Ethernet WAN interfaces, this field displays Up when using the interface and No Link when not using the interface.</p> <p>For a WLAN interface, this field displays the enabled (Up) or disabled (Disable) state of the interface.</p> <p>For the DSL interface, this field displays Down (line down), Up (line up or connected), Drop (dropping a call) if you're using PPPoE encapsulation, and No Link when not using the interface.</p> <p>For the 3G interface, this field displays Up when using the interface and No Device when no device is detected in any USB slot.</p>
Rate	<p>For the Ethernet WAN and LAN interface, this displays the port speed and duplex setting.</p> <p>For the DSL interface, it displays the downstream and upstream transmission rate.</p> <p>For the WLAN interface, it displays the maximum transmission rate or N/A with WLAN disabled.</p> <p>For the 3G interface, this field displays Up when a 3G device is installed in a USB slot and N/A when no device is detected in any USB slot.</p>

Broadband

6.1 Overview

This chapter discusses the VMG's **Broadband** screens. Use these screens to configure your VMG for Internet access.

A WAN (Wide Area Network) connection is an outside connection to another network or the Internet. It connects your private networks, such as a LAN (Local Area Network) and other networks, so that a computer in one location can communicate with computers in other locations.

Figure 16 LAN and WAN

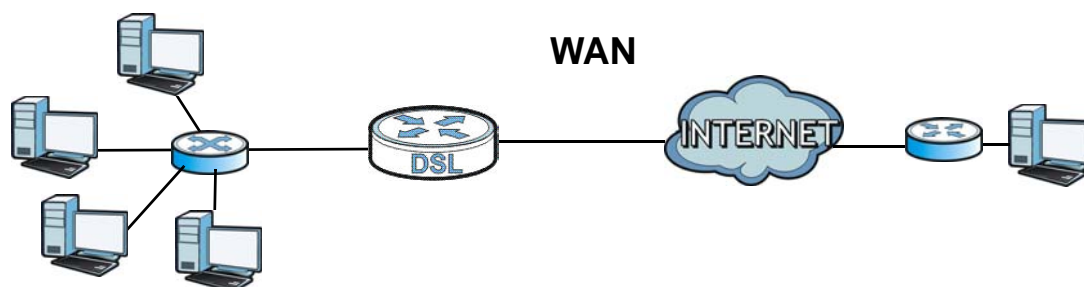

6.1.1 What You Can Do in this Chapter

- Use the **Broadband** screen to view, remove or add a WAN interface. You can also configure the WAN settings on the VMG for Internet access ([Section 6.2 on page 63](#)).
- Use the **3G Backup** screen to configure 3G WAN connection ([Section 6.3 on page 71](#)).
- Use the **Advanced** screen to enable or disable PTM over ADSL, Annex M/Annex J, and DSL PhyR functions ([Section 6.4 on page 75](#)).
- Use the **802.1x** screen to view and configure the IEEE 802.1X settings on the VMG ([Section 6.5 on page 78](#)).

Table 6 WAN Setup Overview

LAYER-2 INTERFACE		INTERNET CONNECTION		
CONNECTION	DSL LINK TYPE	MODE	ENCAPSULATION	CONNECTION SETTINGS
ADSL/VDSL over PTM	N/A	Routing	PPPoE	PPP information, IPv4/IPv6 IP address, routing feature, DNS server, VLAN, QoS, and MTU
			IPoE	IPv4/IPv6 IP address, routing feature, DNS server, VLAN, QoS, and MTU
		Bridge	N/A	VLAN and QoS

Table 6 WAN Setup Overview

LAYER-2 INTERFACE		INTERNET CONNECTION		
CONNECTION	DSL LINK TYPE	MODE	ENCAPSULATION	CONNECTION SETTINGS
ADSL over ATM	EoA	Routing	PPPoE/PPPoA	ATM PVC configuration, PPP information, IPv4/IPv6 IP address, routing feature, DNS server, VLAN, QoS, and MTU
			IPoE/IPoA	ATM PVC configuration, IPv4/IPv6 IP address, routing feature, DNS server, VLAN, QoS, and MTU
		Bridge	N/A	ATM PVC configuration, and QoS
Ethernet	N/A	Routing	PPPoE	PPP user name and password, WAN IPv4/IPv6 IP address, routing feature, DNS server, VLAN, QoS, and MTU
			IPoE	WAN IPv4/IPv6 IP address, NAT, DNS server and routing feature
		Bridge	N/A	VLAN and QoS

6.1.2 What You Need to Know

The following terms and concepts may help as you read this chapter.

WAN IP Address

The WAN IP address is an IP address for the VMG, which makes it accessible from an outside network. It is used by the VMG to communicate with other devices in other networks. It can be static (fixed) or dynamically assigned by the ISP each time the VMG tries to access the Internet.

If your ISP assigns you a static WAN IP address, they should also assign you the subnet mask and DNS server IP address(es).

ATM

Asynchronous Transfer Mode (ATM) is a WAN networking technology that provides high-speed data transfer. ATM uses fixed-size packets of information called cells. With ATM, a high QoS (Quality of Service) can be guaranteed. ATM uses a connection-oriented model and establishes a virtual circuit (VC) between Finding Out More

PTM

Packet Transfer Mode (PTM) is packet-oriented and supported by the VDSL2 standard. In PTM, packets are encapsulated directly in the High-level Data Link Control (HDLC) frames. It is designed to provide a low-overhead, transparent way of transporting packets over DSL links, as an alternative to ATM.

IPv6 Introduction

IPv6 (Internet Protocol version 6), is designed to enhance IP address size and features. The increase in IPv6 address size to 128 bits (from the 32-bit IPv4 address) allows up to 3.4×10^{38} IP addresses. The VMG can use IPv4/IPv6 dual stack to connect to IPv4 and IPv6 networks, and supports IPv6 rapid deployment (6RD).

IPv6 Addressing

The 128-bit IPv6 address is written as eight 16-bit hexadecimal blocks separated by colons (:). This is an example IPv6 address `2001:0db8:1a2b:0015:0000:0000:1a2f:0000`.

IPv6 addresses can be abbreviated in two ways:

- Leading zeros in a block can be omitted. So `2001:0db8:1a2b:0015:0000:0000:1a2f:0000` can be written as `2001:db8:1a2b:15:0:0:1a2f:0`.
- Any number of consecutive blocks of zeros can be replaced by a double colon. A double colon can only appear once in an IPv6 address. So `2001:0db8:0000:0000:1a2f:0000:0000:0015` can be written as `2001:0db8::1a2f:0000:0000:0015`, `2001:0db8:0000:0000:1a2f::0015`, `2001:db8::1a2f:0:0:15` or `2001:db8:0:0:1a2f::15`.

IPv6 Prefix and Prefix Length

Similar to an IPv4 subnet mask, IPv6 uses an address prefix to represent the network address. An IPv6 prefix length specifies how many most significant bits (start from the left) in the address compose the network address. The prefix length is written as "/x" where x is a number. For example,

```
2001:db8:1a2b:15::1a2f:0/32
```

means that the first 32 bits (`2001:db8`) is the subnet prefix.

IPv6 Subnet Masking

Both an IPv6 address and IPv6 subnet mask compose of 128-bit binary digits, which are divided into eight 16-bit blocks and written in hexadecimal notation. Hexadecimal uses four bits for each character (1 ~ 10, A ~ F). Each block's 16 bits are then represented by four hexadecimal characters. For example, `FFFF:FFFF:FFFF:FFFF:FC00:0000:0000:0000`.

IPv6 Rapid Deployment

Use IPv6 Rapid Deployment (6rd) when the local network uses IPv6 and the ISP has an IPv4 network. When the VMG has an IPv4 WAN address and you set **IPv4/IPv6 Mode** to **IPv4 Only**, you can enable 6rd to encapsulate IPv6 packets in IPv4 packets to cross the ISP's IPv4 network.

The VMG generates a global IPv6 prefix from its IPv4 WAN address and tunnels IPv6 traffic to the ISP's Border Relay router (BR in the figure) to connect to the native IPv6 Internet. The local network can also use IPv4 services. The VMG uses its configured IPv4 WAN IP to route IPv4 traffic to the IPv4 Internet.

Figure 17 IPv6 Rapid Deployment

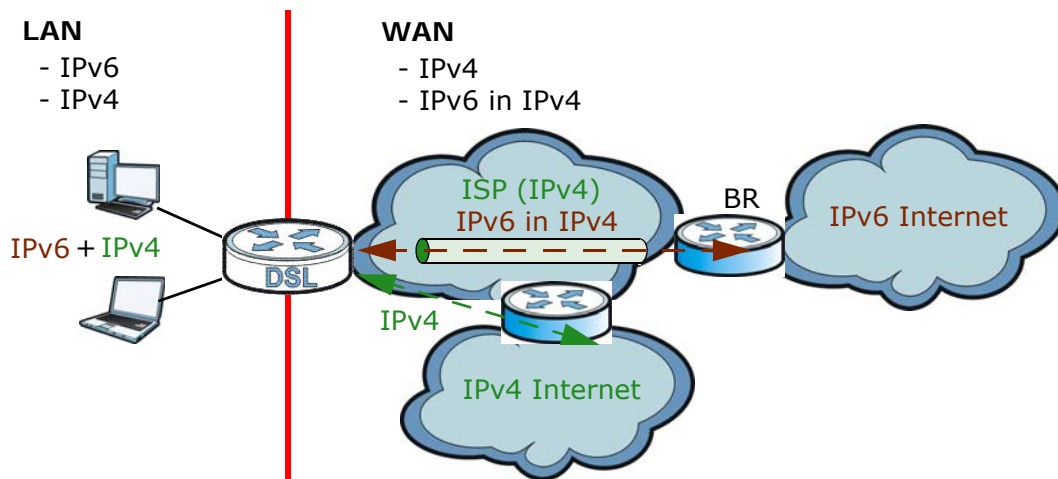

Dual Stack Lite

Use Dual Stack Lite when local network computers use IPv4 and the ISP has an IPv6 network. When the VMG has an IPv6 WAN address and you set **IPv4/IPv6 Mode** to **IPv6 Only**, you can enable Dual Stack Lite to use IPv4 computers and services.

The VMG tunnels IPv4 packets inside IPv6 encapsulation packets to the ISP's Address Family Transition Router (**AFTR** in the graphic) to connect to the IPv4 Internet. The local network can also use IPv6 services. The VMG uses its configured IPv6 WAN IP to route IPv6 traffic to the IPv6 Internet.

Figure 18 Dual Stack Lite

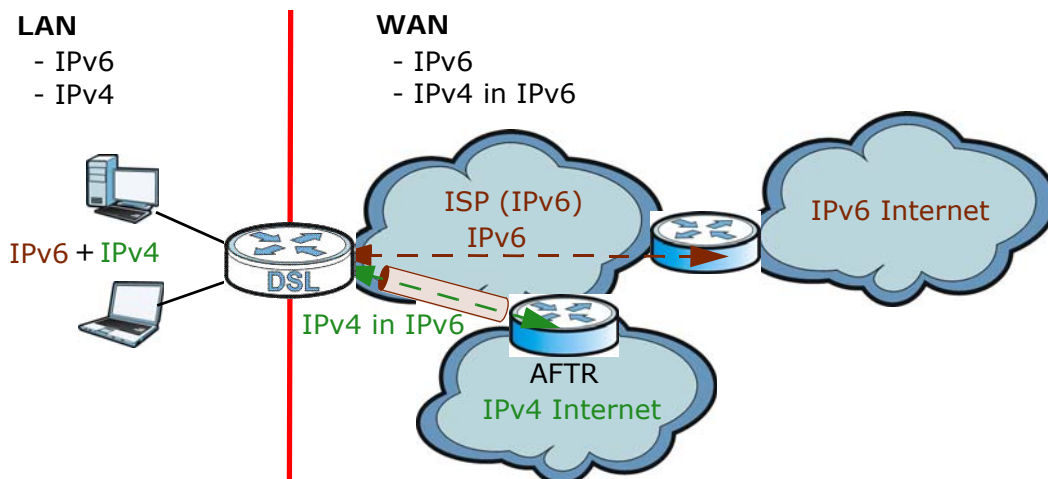







6.1.3 Before You Begin

You need to know your Internet access settings such as encapsulation and WAN IP address. Get this information from your ISP.

6.2 The Broadband Screen

Use this screen to change your VMG's Internet access settings. Click **Network Setting > Broadband** from the menu. The summary table shows you the configured WAN services (connections) on the VMG.

Figure 19 Network Setting > Broadband

Add New WAN Interface												
#	Name	Type	Mode	Encaps...	802.1p	802.1q	IGMP Proxy	NAT	Default Gateway	IPv6	MLD Proxy	Modify
1	ADSL	ATM	Routing	IPoE	N/A	N/A	Y	Y	Y	Y	N	 
2	VDSL	PTM	Routing	IPoE	N/A	N/A	Y	Y	Y	Y	N	 
3	ETHWAN	Ethernet	Routing	IPoE	N/A	N/A	Y	Y	Y	Y	N	 

The following table describes the labels in this screen.

Table 7 Network Setting > Broadband

LABEL	DESCRIPTION
Add New WAN Interface	Click this button to create a new connection.
#	This is the index number of the entry.
Name	This is the service name of the connection.
Type	This shows whether it is an ATM, Ethernet or a PTM connection.
Mode	This shows whether the connection is in routing or bridge mode.
Encapsulation	This is the method of encapsulation used by this connection.
802.1p	This indicates the 802.1p priority level assigned to traffic sent through this connection. This displays N/A when there is no priority level assigned.
802.1q	This indicates the VLAN ID number assigned to traffic sent through this connection. This displays N/A when there is no VLAN ID number assigned.
IGMP Proxy	This shows whether the VMG act as an IGMP proxy on this connection.
NAT	This shows whether NAT is activated or not for this connection.
Default Gateway	This shows whether the VMG use the WAN interface of this connection as the system default gateway.
IPv6	This shows whether IPv6 is activated or not for this connection. IPv6 is not available when the connection uses the bridging service.
MLD Proxy	This shows whether Multicast Listener Discovery (MLD) is activated or not for this connection. MLD is not available when the connection uses the bridging service.
Modify	Click the Edit icon to configure the WAN connection. Click the Delete icon to remove the WAN connection.

6.2.1 Add/Edit Internet Connection

Click **Add New WAN Interface** in the **Broadband** screen or the **Edit** icon next to an existing WAN interface to configure a WAN connection. The screen varies depending on the interface type, mode, encapsulation, and IPv6/IPv4 mode you select.

6.2.1.1 Routing Mode

Use **Routing** mode if your ISP give you one IP address only and you want multiple computers to share an Internet account.

The following example screen displays when you select the **ADSL/VDSL over ATM** connection type, **Routing** mode, and **PPPoE** encapsulation. The screen varies when you select other interface type, encapsulation, and IPv6/IPv4 mode.

Figure 20 Network Setting > Broadband > Add New WAN Interface/Edit (Routing Mode)

The screenshot shows the 'Add New WAN Interface' configuration window with the following settings:

- General**
 - Name: [Empty text box]
 - Type: ADSL/VDSL over PTM (dropdown)
 - Mode: Routing Bridge
 - Encapsulation: PPPoE (dropdown)
 - IPv4/IPv6 Mode: IPv4 Only (dropdown)
- PPP Information**
 - PPP User Name: admin (text box)
 - PPP Password: **** (password field)
 - password unmask:
 - PPP Connection Trigger: Auto Connect On Demand
 - PPPoE Passthrough: Enable Disable
- IP Address**
 - Obtain an IP Address Automatically
 - Static IP Address
- VLAN**
 - Active: Enable Disable
 - 802.1p: 0 (dropdown)
 - 802.1q: 0 (text box) (0-4094)
- MTU**
 - MTU: 1492 (text box)
- Routing Feature**
 - NAT Enable: Enable Disable
 - Fullcone NAT Enable: Enable Disable
 - IGMP Proxy Enable: Enable Disable
 - Apply as Default Gateway: Enable Disable
- DNS server**
 - Obtain DNS Info Automatically
 - Use Following Static DNS Address
 - Primary DNS Server: [Empty text box]
 - Secondary DNS Server: [Empty text box]
- 6RD**
 - 6RD: Enable Disable
 - Automatically configured by DHCP:
 - Manually Configured:
 - Service Provider IPv6 Prefix: [Empty text box]
 - IPv4 Mask Length: [Empty text box]
 - Border Relay IPv4 Address: [Empty text box]

Buttons: OK, Cancel

The following table describes the labels in this screen.

Table 8 Network Setting > Broadband > Add New WAN Interface/Edit (Routing Mode)

LABEL	DESCRIPTION
General	
Name	Specify a descriptive name for this connection.
Type	Select whether it is an ADSL/VDSL over PTM , ADSL over ATM or Ethernet connection.
Mode	Select Routing if your ISP give you one IP address only and you want multiple computers to share an Internet account.
Encapsulation	Select the method of encapsulation used by your ISP from the drop-down list box. This option is available only when you select Routing in the Mode field. The choices depend on the connection type you selected. If your connection type is ADSL/VDSL over PTM , the choices are PPPoE and IPoE . If your connection type is ADSL over ATM , the choices are PPPoE , PPPoA , IPoE and IPoA .
IPv4/IPv6 Mode	Select IPv4 Only if you want the VMG to run IPv4 only. Select IPv4 IPv6 DualStack to allow the VMG to run IPv4 and IPv6 at the same time. Select IPv6 Only if you want the VMG to run IPv6 only.
PPP Information (This is available only when you select PPPoE or PPPoA in the Encapsulation field.)	
PPP User Name	Enter the user name exactly as your ISP assigned. If assigned a name in the form user@domain where domain identifies a service name, then enter both components exactly as given.
PPP Password	Enter the password associated with the user name above. Select password unmask to show your entered password in plain text.
PPP Trigger Type	Select when to have the VMG establish the PPP connection. Auto Connect - select this to not let the connection time out. On Demand - select this to automatically bring up the connection when the VMG receives packets destined for the Internet.
Idle Timeout	This value specifies the time in minutes that elapses before the router automatically disconnects from the PPPoE server. This field is not configurable if you select Auto Connect in the PPP Trigger Type field.
PPPoE Passthrough	This field is available when you select PPPoE encapsulation. In addition to the VMG's built-in PPPoE client, you can enable PPPoE pass through to allow up to ten hosts on the LAN to use PPPoE client software on their computers to connect to the ISP via the VMG. Each host can have a separate account and a public WAN IP address. PPPoE pass through is an alternative to NAT for application where NAT is not appropriate. Disable PPPoE pass through if you do not need to allow hosts on the LAN to use PPPoE client software on their computers to connect to the ISP.
ATM PVC Configuration (These fields appear when the Type is set to ADSL over ATM .)	
VPI	The valid range for the VPI is 0 to 255. Enter the VPI assigned to you.
VCI	The valid range for the VCI is 32 to 65535 (0 to 31 is reserved for local management of ATM traffic). Enter the VCI assigned to you.
Encapsulation	Select the method of multiplexing used by your ISP from the drop-down list box. Choices are: <ul style="list-style-type: none"> LLC/SNAP-BRIDGING: In LCC encapsulation, bridged PDUs are encapsulated by identifying the type of the bridged media in the SNAP header. VC/MUX: In VC multiplexing, each protocol is carried on a single ATM virtual circuit (VC). To transport multiple protocols, the VMG needs separate VCs. There is a binding between a VC and the type of the network protocol carried on the VC. This reduces payload overhead since there is no need to carry protocol information in each Protocol Data Unit (PDU) payload.

Table 8 Network Setting > Broadband > Add New WAN Interface/Edit (Routing Mode) (continued)

LABEL	DESCRIPTION
Service Category	Select UBR Without PCR for applications that are non-time sensitive, such as e-mail. Select CBR (Continuous Bit Rate) to specify fixed (always-on) bandwidth for voice or data traffic. Select Non Realtime VBR (non real-time Variable Bit Rate) for connections that do not require closely controlled delay and delay variation. Select Realtime VBR (real-time Variable Bit Rate) for applications with bursty connections that require closely controlled delay and delay variation.
VLAN (These fields appear when the Type is set to ADSL/VDSL over PTM .)	
Active	Select this to enable VLAN on this WAN interface.
802.1p	IEEE 802.1p defines up to 8 separate traffic types by inserting a tag into a MAC-layer frame that contains bits to define class of service. Select the IEEE 802.1p priority level (from 0 to 7) to add to traffic through this connection. The greater the number, the higher the priority level.
802.1q	Type the VLAN ID number (from 1 to 4094) for traffic through this connection.
IP Address (This is available only when you select IPv4 Only or IPv4 IPv6 DualStack in the IPv4/IPv6 Mode field.)	
Obtain an IP Address Automatically	A static IP address is a fixed IP that your ISP gives you. A dynamic IP address is not fixed; the ISP assigns you a different one each time you connect to the Internet. Select this if you have a dynamic IP address.
Static IP Address	Select this option if the ISP assigned a fixed IP address.
IP Address	Enter the static IP address provided by your ISP.
MTU	
MTU	Enter the MTU (Maximum Transmission Unit) of each data packet, in bytes, that can move through the WAN connection.
Routing Feature (This is available only when you select IPv4 Only or IPv4 IPv6 DualStack in the IPv4/IPv6 Mode field.)	
NAT Enable	Select this option to activate NAT on this connection.
Fullcone NAT Enable	Select this option to enable full cone NAT on this connection. This field is available only when you activate NAT. In full cone NAT, the VMG maps all outgoing packets from an internal IP address and port to a single IP address and port on the external network. The VMG also maps packets coming to that external IP address and port to the internal IP address and port.
IGMP Proxy Enable	Internet Group Multicast Protocol (IGMP) is a network-layer protocol used to establish membership in a Multicast group - it is not used to carry user data. Select this option to have the VMG act as an IGMP proxy on this connection. This allows the VMG to get subscribing information and maintain a joined member list for each multicast group. It can reduce multicast traffic significantly.
Apply as Default Gateway	Select this option to have the VMG use the WAN interface of this connection as the system default gateway.
DNS Server (This is available only when you select IPv4 Only or IPv4 IPv6 DualStack in the IPv4/IPv6 Mode field.)	
	Select Obtain DNS Info Automatically if you want the VMG to use the DNS server addresses assigned by your ISP. Select Use Following Static DNS Address if you want the VMG to use the DNS server addresses you configure manually.

Table 8 Network Setting > Broadband > Add New WAN Interface/Edit (Routing Mode) (continued)

LABEL	DESCRIPTION
Primary DNS Server	Enter the first DNS server address assigned by the ISP.
Secondary DNS Server	Enter the second DNS server address assigned by the ISP.
DHCP Options (This is available only when you select IPv4 Only or IPv4 IPv6 DualStack in the IPv4/IPv6 Mode field.)	
Request Options	Select Option 43 to have the VMG automatically add vendor specific information in the DHCP packets to request the vendor specific options from the DHCP server. Select Option 121 to have the VMG push static routes to clients.
Sent Options	
option 60	Select this and enter the device identity you want the VMG to add in the DHCP discovery packets that go to the DHCP server.
Vendor ID	Enter the Vendor Class Identifier, such as the type of the hardware or firmware.
option 61	Select this and enter any string that identifies the device.
IAID	Enter the Identity Association Identifier (IAID) of the device, for example, the WAN connection index number.
DUID	Enter the hardware type, a time value and the MAC address of the device.
option 125	Select this to have the VMG automatically generate and add vendor specific parameters in the DHCP discovery packets that go to the DHCP server.
Tunnel (This is available only when you select IPv6 Only in the IPv4/IPv6 Mode field.) The DS-Lite (Dual Stack Lite) fields display when you set the IPv4/IPv6 Mode field to IPv6 Only . Enable Dual Stack Lite to let local computers use IPv4 through an ISP's IPv6 network. See Dual Stack Lite on page 62 for more information.	
Enable DS-Lite	Select Enable to let local computers use IPv4 through an ISP's IPv6 network.
DS-Lite Relay Server IP	Specify the transition router's IPv6 address.
6RD (This is available only when you select IPv4 Only in the IPv4/IPv6 Mode field.) See IPv6 Rapid Deployment on page 61 for more information.	
6RD	Select Enable to tunnel IPv6 traffic from the local network through the ISP's IPv4 network. Select Manually Configured if you have the IPv4 address of the relay server. Otherwise, select Automatically configured by DHCP to have the VMG detect it automatically through DHCP. The Automatically configured by DHCP option is configurable only when you set the method of encapsulation to IPoE .
Service Provider IPv6 Prefix	Enter an IPv6 prefix for tunneling IPv6 traffic to the ISP's border relay router and connecting to the native IPv6 Internet.
IPv4 Mask Length	Enter the subnet mask number (1~32) for the IPv4 network.
Border Relay IPv4 Address	When you select Manually Configured , specify the relay server's IPv4 address in this field.
IPv6 Address (This is available only when you select IPv4 IPv6 DualStack or IPv6 Only in the IPv4/IPv6 Mode field.)	
	Select Obtain an IPv6 Address Automatically if you want to have the VMG use the IPv6 prefix from the connected router's Router Advertisement (RA) to generate an IPv6 address. Select Static IPv6 Address if you have a fixed IPv6 address assigned by your ISP.

Table 8 Network Setting > Broadband > Add New WAN Interface/Edit (Routing Mode) (continued)

LABEL	DESCRIPTION
IPv6 Address	Enter the IPv6 address assigned by your ISP.
Prefix Length	Enter the address prefix length to specify how many most significant bits in an IPv6 address compose the network address.
IPv6 Default Gateway	Enter the IP address of the next-hop gateway. The gateway is a router or switch on the same segment as your VMG's interface(s). The gateway helps forward packets to their destinations.
IPv6 Routing Feature (This is available only when you select IPv4 IPv6 DualStack or IPv6 Only in the IPv4/IPv6 Mode field. You can enable IPv6 routing features in the following section.)	
MLD Proxy Enable	Select this checkbox to have the VMG act as an MLD proxy on this connection. This allows the VMG to get subscription information and maintain a joined member list for each multicast group. It can reduce multicast traffic significantly.
Apply as Default Gateway	Select this option to have the VMG use the WAN interface of this connection as the system default gateway.
IPv6 DNS Server	Configure the IPv6 DNS server in the following section.
	Select Obtain IPv6 DNS Info Automatically to have the VMG get the IPv6 DNS server addresses from the ISP automatically. Select Use Following Static IPv6 DNS Address to have the VMG use the IPv6 DNS server addresses you configure manually.
Primary DNS Server	Enter the first IPv6 DNS server address assigned by the ISP.
Secondary DNS Server	Enter the second IPv6 DNS server address assigned by the ISP.
Apply	Click Apply to save your changes back to the VMG.
Cancel	Click Cancel to exit this screen without saving.

6.2.1.2 Bridge Mode

Click the **Add new WAN Interface** in the **Network Setting > Broadband** screen or the **Edit** icon next to the connection you want to configure. Select **Bridge** as the operating mode. The screen varies depending on the interface type you select.

If you select **ADSL/VDSL over PTM** as the interface type, the following screen appears.

Figure 21 Network Setting > Broadband > Add New WAN Interface/Edit (ADSL/VDSL over PTM - Bridge Mode)

The following table describes the fields in this screen.

Table 9 Network Setting > Broadband > Add New WAN Interface/Edit (ADSL/VDSL over PTM - Bridge Mode)

LABEL	DESCRIPTION
General	
Name	Enter a service name of the connection.
Type	Select ADSL/VDSL over PTM as the interface that you want to configure. The VMG uses the VDSL technology for data transmission over the DSL port.
Mode	Select Bridge when your ISP provides you more than one IP address and you want the connected computers to get individual IP address from ISP's DHCP server directly. If you select Bridge , you cannot use routing functions, such as QoS, Firewall, DHCP server and NAT on traffic from the selected LAN port(s).
VLAN	This section is available only when you select ADSL/VDSL over PTM in the Type field.
Active	Select Enable to enable VLAN on this WAN interface.
802.1p	IEEE 802.1p defines up to 8 separate traffic types by inserting a tag into a MAC-layer frame that contains bits to define class of service. Select the IEEE 802.1p priority level (from 0 to 7) to add to traffic through this connection. The greater the number, the higher the priority level.
802.1q	Type the VLAN ID number (from 0 to 4094) for traffic through this connection.
OK	Click OK to save your changes.
Cancel	Click Cancel to exit this screen without saving.

If you select **ADSL over ATM** as the interface type, the following screen appears.

Figure 22 Network Setting > Broadband > Add New WAN Interface/Edit (ADSL over ATM-Bridge Mode)

The following table describes the fields in this screen.

Table 10 Network Setting > Broadband > Add New WAN Interface/Edit (ADSL over ATM-Bridge Mode)

LABEL	DESCRIPTION
General	
Name	Enter a service name of the connection.
Type	Select ADSL over ATM as the interface that you want to configure. The VMG uses the ADSL technology for data transmission over the DSL port.
Mode	Select Bridge when your ISP provides you more than one IP address and you want the connected computers to get individual IP address from ISP's DHCP server directly. If you select Bridge , you cannot use routing functions, such as QoS, Firewall, DHCP server and NAT on traffic from the selected LAN port(s).
ATM PVC Configuration (These fields appear when the Type is set to ADSL over ATM .)	
VPI	The valid range for the VPI is 0 to 255. Enter the VPI assigned to you.
VCI	The valid range for the VCI is 32 to 65535 (0 to 31 is reserved for local management of ATM traffic). Enter the VCI assigned to you.
Encapsulation	Select the method of multiplexing used by your ISP from the drop-down list box. Choices are: <ul style="list-style-type: none"> • LLC/SNAP-BRIDGING: In LCC encapsulation, bridged PDUs are encapsulated by identifying the type of the bridged media in the SNAP header. • VC/MUX: In VC multiplexing, each protocol is carried on a single ATM virtual circuit (VC). To transport multiple protocols, the VMG needs separate VCs. There is a binding between a VC and the type of the network protocol carried on the VC. This reduces payload overhead since there is no need to carry protocol information in each Protocol Data Unit (PDU) payload.

Table 10 Network Setting > Broadband > Add New WAN Interface/Edit (ADSL over ATM-Bridge Mode) (continued)

LABEL	DESCRIPTION
Service Category	Select UBR Without PCR for applications that are non-time sensitive, such as e-mail. Select CBR (Continuous Bit Rate) to specify fixed (always-on) bandwidth for voice or data traffic. Select Non Realtime VBR (non real-time Variable Bit Rate) for connections that do not require closely controlled delay and delay variation. Select Realtime VBR (real-time Variable Bit Rate) for applications with bursty connections that require closely controlled delay and delay variation.
VLAN	This section is available only when you select ADSL/VDSL over PTM in the Type field.
Active	Select Enable to enable VLAN on this WAN interface.
802.1p	IEEE 802.1p defines up to 8 separate traffic types by inserting a tag into a MAC-layer frame that contains bits to define class of service. Select the IEEE 802.1p priority level (from 0 to 7) to add to traffic through this connection. The greater the number, the higher the priority level.
802.1q	Type the VLAN ID number (from 0 to 4094) for traffic through this connection.
OK	Click OK to save your changes.
Cancel	Click Cancel to exit this screen without saving.

6.3 The 3G Backup Screen

The USB ports (at the left side panel of the VMG) allow you to attach a 3G dongle to wirelessly connect to a 3G network for Internet access. You can have the VMG use the 3G WAN connection as a backup. Disconnect the DSL and Ethernet WAN ports to use the 3G dongle as your primary WAN connection. The VMG automatically uses a wired WAN connection when available.

Note: This VMG supports connecting one 3G dongle at a time.

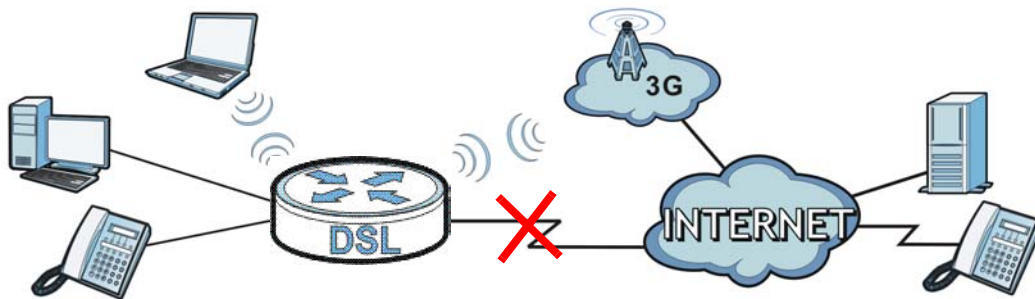
Figure 23 Internet Access Application: 3G WAN

Use this screen to configure your 3G settings. Click **Network Setting > Broadband > 3G Backup**.

Note: The actual data rate you obtain varies depending the 3G card you use, the signal strength to the service provider’s base station, and so on.

Figure 24 Network Setting > Broadband > 3G Backup

Whenever the WAN connection is down, 3G Backup takes over the job and keeps you online. It is valid when a 3G USB dongle is attached to the device and proper settings are configured. You may consult your 3G service provider for the following settings.

General

3G Backup Enable Disable (settings are invalid when disabled)

trigger 3G backup when physical link of primary WAN is down

Ping Check Enable Disable

Check Cycle : Every (20~180 Sec)

Consecutive Fail : (2~5 times)

Ping Default Gateway

Ping the Host (Host Name or IP address)

Note:
Primary WAN is not in service when ping failed after consecutive times.

3G Connection Settings

Card description : N/A

Username : (Optional)

Password : (Optional)

PIN : (Optional) (Only for unlock PIN next time)

(PIN remaining authentication times: N/A)

Dial string :

APN :

Connection :

Obtain an IP Address Automatically

Use the following static IP address

Obtain DNS info Dynamically

Use the following static DNS IP address

Primary DNS server:

Secondary DNS server:

Enable E-mail Notification Enable Disable

Note:
Entering the wrong PIN code 3 times will lock SIM card.

Budget Setup

Enable Budget Control Enable Disable

Time Budget: hours per month

Data Budget: Mbytes per month

Data Budget: kPackets per month

Reset all budget counters on day of the month

Actions before over budget:

Enable % of time budget

Enable % of data budget (Mbytes)

Enable % of data budget (Packets)

Actions when over budget

Current 3G connection:

Actions:

Enable E-mail Notification Enable Disable

Enable Log: Interval minutes

Note:
Budget Control is an approximate value.

[Basic](#)

The following table describes the labels in this screen.

Table 11 Network Setting > Broadband > 3G Backup

LABEL	DESCRIPTION
General	
3G Backup	Select Enable to have the VMG use the 3G connection as your WAN or a backup when the wired WAN connection fails.

Table 11 Network Setting > Broadband > 3G Backup (continued)

LABEL	DESCRIPTION
Ping Check	Select Enable if you want the VMG to ping check the connection status of your WAN. You can configure the frequency of the ping check and number of consecutive failures before triggering 3G backup.
Check Cycle	Enter the frequency of the ping check in this field.
Consecutive Fail	Enter how many consecutive failures are required before 3G backup is triggered.
Ping Default Gateway	Select this to have the VMG ping the WAN interface's default gateway IP address.
Ping the Host	Select this to have the VMG ping the particular host name or IP address you typed in this field.
3G Connection Settings	
Card description	This field displays the manufacturer and model name of your 3G card if you inserted one in the VMG. Otherwise, it displays N/A .
Username	Type the user name (of up to 64 ASCII printable characters) given to you by your service provider.
Password	Type the password (of up to 64 ASCII printable characters) associated with the user name above.
PIN	A PIN (Personal Identification Number) code is a key to a 3G card. Without the PIN code, you cannot use the 3G card. If your ISP enabled PIN code authentication, enter the 4-digit PIN code (0000 for example) provided by your ISP. If you enter the PIN code incorrectly, the 3G card may be blocked by your ISP and you cannot use the account to access the Internet. If your ISP disabled PIN code authentication, leave this field blank.
Dial string	Enter the phone number (dial string) used to dial up a connection to your service provider's base station. Your ISP should provide the phone number. For example, *99# is the dial string to establish a GPRS or 3G connection in Taiwan.
APN	Enter the APN (Access Point Name) provided by your service provider. Connections with different APNs may provide different services (such as Internet access or MMS (Multi-Media Messaging Service)) and charge method. You can enter up to 32 ASCII printable characters. Spaces are allowed.
Connection	Select Nailed UP if you do not want the connection to time out. Select on Demand if you do not want the connection up all the time and specify an idle time-out in the Max Idle Timeout field.
Max Idle Timeout	This value specifies the time in minutes that elapses before the VMG automatically disconnects from the ISP.
Obtain an IP Address Automatically	Select this option if your ISP did not assign you a fixed IP address.
Use the following static IP address	Select this option if the ISP assigned a fixed IP address.
IP Address	Enter your WAN IP address in this field if you selected Use the following static IP address .
Subnet Mask	
Obtain DNS info dynamically	Select this to have the VMG get the DNS server addresses from the ISP automatically.

Table 11 Network Setting > Broadband > 3G Backup (continued)

LABEL	DESCRIPTION
Use the following static DNS IP address	Select this to have the VMG use the DNS server addresses you configure manually.
Primary DNS server	Enter the first DNS server address assigned by the ISP.
Secondary DNS server	Enter the second DNS server address assigned by the ISP.
Enable E-mail Notification	Select this to enable the e-mail notification function. The VMG will e-mail you a notification when the 3G connection is up.
Mail Account	Select a mail account for the e-mail address specified below. If you do not select a mail account, e-mail notifications cannot be sent via e-mail. You must have configured a mail account already in the Maintenance > E-mail Notification screen.
3G Backup E-mail Title	Type a title that you want to be in the subject line of the e-mail notifications that the VMG sends.
Send Notification to E-mail	Notifications are sent to the e-mail address specified in this field. If this field is left blank, notifications cannot be sent via e-mail.
Advanced	Click this to show the advanced 3G backup settings.
Budget Setup	
Enable Budget Control	Select Enable to set a monthly limit for the user account of the installed 3G card. You can set a limit on the total traffic and/or call time. The VMG takes the actions you specified when a limit is exceeded during the month.
Time Budget	Select this and specify the amount of time (in hours) that the 3G connection can be used within one month. If you change the value after you configure and enable budget control, the VMG resets the statistics.
Data Budget (Mbytes)	Select this and specify how much downstream and/or upstream data (in Mega bytes) can be transmitted via the 3G connection within one month. Select Download/Upload to set a limit on the total traffic in both directions. Select Download to set a limit on the downstream traffic (from the ISP to the VMG). Select Upload to set a limit on the upstream traffic (from the VMG to the ISP). If you change the value after you configure and enable budget control, the VMG resets the statistics.
Data Budget (kPackets)	Select this and specify how much downstream and/or upstream data (in k Packets) can be transmitted via the 3G connection within one month. Select Download/Upload to set a limit on the total traffic in both directions. Select Download to set a limit on the downstream traffic (from the ISP to the VMG). Select Upload to set a limit on the upstream traffic (from the VMG to the ISP). If you change the value after you configure and enable budget control, the VMG resets the statistics.
Reset all budget counters on	Select the date on which the VMG resets the budget every month. Select last if you want the VMG to reset the budget on the last day of the month. Select specific and enter the number of the date you want the VMG to reset the budget
Reset time and data budget counters	Click this button to reset the time and data budgets immediately. The count starts over with the 3G connection's full configured monthly time and data budgets. This does not affect the normal monthly budget restart; so if you configured the time and data budget counters to reset on the second day of the month and you use this button on the first, the time and data budget counters will still reset on the second.

Table 11 Network Setting > Broadband > 3G Backup (continued)

LABEL	DESCRIPTION
Actions before over budget	Specify the actions the VMG takes before the time or data limit exceeds.
Enable % of time budget/ data budget (Mbytes)/data budget (kPackets)	Select Enable and enter a number from 1 to 99 in the percentage fields. If you change the value after you configure and enable budget control, the VMG resets the statistics.
Actions when over budget	Specify the actions the VMG takes when the time or data limit is exceeded.
Current 3G connection	Select Keep to maintain an existing 3G connection or Drop to disconnect it.
Actions	
Enable E-mail Notification	Select this to enable the e-mail notification function. The VMG will e-mail you a notification when over budget occurs.
Mail Account	Select a mail server for the e-mail address specified below. If you do not select a mail server, e-mail notifications cannot be sent via e-mail. You must have configured a mail server already in the Maintenance > Email Notification screen.
3G Backup E-mail Title	Type a title that you want to be in the subject line of the e-mail notifications that the VMG sends.
Send Notification to E-mail	Notifications are sent to the e-mail address specified in this field. If this field is left blank, notifications cannot be sent via e-mail.
Enable Log	Select this to activate the logging function at the interval you set in this field.
Basic	Click this to hide the advanced settings of 3G backup.
Apply	Click Apply to save your changes back to the VMG.
Cancel	Click Cancel to return to the previous configuration.

6.4 The Advanced Screen

Use the **Advanced** screen to enable or disable ADSL over PTM, Annex M, DSL PhyR, and SRA (Seamless Rate Adaptation) functions. The VMG supports the PhyR retransmission scheme. PhyR is a retransmission scheme designed to provide protection against noise on the DSL line. It improves voice, video and data transmission resilience by utilizing a retransmission buffer.

ITU-T G.993.2 standard defines a wide range of settings for various parameters, some of which are encompassed in profiles as shown in the next table.

Table 12 VDSL Profiles

PROFILE	BANDWIDTH (MHZ)	NUMBER OF DOWNSTREAM CARRIERS	CARRIER BANDWIDTH (KHZ)	POWER (DBM)	MAX. DOWNSTREAM THROUGHPUT (MBIT/S)
8a	8.832	2048	4.3125	17.5	50
8b	8.832	2048	4.3125	20.5	50
8c	8.5	1972	4.3125	11.5	50
8d	8.832	2048	4.3125	14.5	50

Table 12 VDSL Profiles (continued)

PROFILE	BANDWIDTH (MHZ)	NUMBER OF DOWNSTREAM CARRIERS	CARRIER BANDWIDTH (KHZ)	POWER (DBM)	MAX. DOWNSTREAM THROUGHPUT (MBIT/S)
12a	12	2783	4.3125	14.5	68
12b	12	2783	4.3125	14.5	68
17a	17.664	4096	4.3125	14.5	100
30a	30	3479	8.625	14.5	200

Click **Network Setting > Broadband > Advanced** to display the following screen.

Figure 25 Network Setting > Broadband > Advanced

DSL Capabilities

PhyR US : Enable Disable

PhyR DS : Enable Disable

Bitswap : Enable Disable

SRA : Enable Disable

ADSL Modulation

PTM over ADSL : Enable Disable

G.dmt : Enable Disable

G.lite : Enable Disable

T1.413 : Enable Disable

ADSL2 : Enable Disable

Annex L : Enable Disable

ADSL2+ : Enable Disable

Annex M : Enable Disable

VDSL Profile

8a Enable : Enable Disable

8b Enable : Enable Disable

8c Enable : Enable Disable

8d Enable : Enable Disable

12a Enable : Enable Disable

12b Enable : Enable Disable

17a Enable : Enable Disable

US0 : Enable Disable

The following table describes the labels in this screen.

Table 13 Network Setting > Broadband > Advanced

LABEL	DESCRIPTION
DSL Capabilities	
PhyR US	Enable or disable PhyR US (upstream) for upstream transmission to the WAN. PhyR US should be enabled if data being transmitted upstream is sensitive to noise. However, enabling PhyR US can decrease the US line rate. Enabling or disabling PhyR will require the CPE to retrain. For PhyR to function, the DSLAM must also support PhyR and have it enabled.
PhyR DS	Enable or disable PhyR DS (downstream) for downstream transmission from the WAN. PhyR DS should be enabled if data being transmitted downstream is sensitive to noise. However, enabling PhyR DS can decrease the DS line rate. Enabling or disabling PhyR will require the CPE to retrain. For PhyR to function, the DSLAM must also support PhyR and have it enabled.





Table 13 Network Setting > Broadband > Advanced (continued)

LABEL	DESCRIPTION
Bitswap	Select Enable to allow the VMG to adapt to line changes when you are using G.dmt. Bit-swapping is a way of keeping the line more stable by constantly monitoring and redistributing bits between channels.
SRA	Enable or disable Seamless Rate Adaption (SRA). Select Enable to have the VMG automatically adjust the connection's data rate according to line conditions without interrupting service.
ADSL Modulation	
PTM over ADSL	Select Enable to use PTM over ADSL. Since PTM has less overhead than ATM, some ISPs use this for better performance.
G.Dmt	ITU G.992.1 (better known as G.dmt) is an ITU standard for ADSL using discrete multitone modulation. G.dmt full-rate ADSL expands the usable bandwidth of existing copper telephone lines, delivering high-speed data communications at rates up to 8 Mbit/s downstream and 1.3 Mbit/s upstream.
G.lite	ITU G.992.2 (better known as G.lite) is an ITU standard for ADSL using discrete multitone modulation. G.lite does not strictly require the use of DSL filters, but like all variants of ADSL generally functions better with splitters.
T1.413	ANSI T1.413 is a technical standard that defines the requirements for the single asymmetric digital subscriber line (ADSL) for the interface between the telecommunications network and the customer installation in terms of their interaction and electrical characteristics.
ADSL2	It optionally extends the capability of basic ADSL in data rates to 12 Mbit/s downstream and, depending on Annex version, up to 3.5 Mbit/s upstream (with a mandatory capability of ADSL2 transceivers of 8 Mbit/s downstream and 800 kbit/s upstream).
AnnexL	Annex L is an optional specification in the ITU-T ADSL2 recommendation G.992.3 titled Specific requirements for a Reach Extended ADSL2 (READSL2) system operating in the frequency band above POTS, therefore it is often referred to as Reach Extended ADSL2 or READSL2. The main difference between this specification and commonly deployed Annex A is the maximum distance that can be used. The power of the lower frequencies used for transmitting data is boosted up to increase the reach of this signal up to 7 kilometers (23,000 ft).
ADSL2+	ADSL2+ extends the capability of basic ADSL by doubling the number of downstream channels. The data rates can be as high as 24 Mbit/s downstream and up to 1.4 Mbit/s upstream depending on the distance from the DSLAM to the customer's premises.
AnnexM	Annex M is an optional specification in ITU-T recommendations G.992.3 (ADSL2) and G.992.5 (ADSL2+), also referred to as ADSL2 M and ADSL2+ M. This specification extends the capability of commonly deployed Annex A by more than doubling the number of upstream bits. The data rates can be as high as 12 or 24 Mbit/s downstream and 3 Mbit/s upstream depending on the distance from the DSLAM to the customer's premises.
VDSL Profile	VDSL2 profiles differ in the width of the frequency band used to transmit the broadband signal. Profiles that use a wider frequency band can deliver higher maximum speeds.
8a, 8b, 8c, 8d, 12a, 12b, 17a, US0	The G.993.2 VDSL standard defines a wide range of profiles that can be used in different VDSL deployment settings, such as in a central office, a street cabinet or a building. The VMG must comply with at least one profile specified in G.993.2. but compliance with more than one profile is allowed.
Apply	Click Apply to save your changes back to the VMG.
Cancel	Click Cancel to return to the previous configuration.

6.5 The 802.1x Screen

You can view and configure the 802.1X authentication settings in the **802.1x** screen. Click **Network Setting > Broadband > 802.1x** to display the following screen.

Figure 26 Network Setting > Broadband > 802.1x

802.1x Authentication List.								
#	Status	Interface	EAP Identity	EAP method	Bidirectional A	Certificate	Trusted CA	Modify
1		N/A	N/A	EAP-TLS	No	N/A	N/A	
2		N/A	N/A	EAP-TLS	No	N/A	N/A	

Note:
You need to add WAN interface first, and you can modify authentication rules.

The following table describes the labels in this screen.

Table 14 Network Setting > Network Setting > 802.1x

LABEL	DESCRIPTION
#	This is the index number of the entry.
Status	This field displays whether the authentication is active or not. A yellow bulb signifies that this authentication is active. A gray bulb signifies that this authentication is not active.
Interface	This is the interface that uses the authentication. This displays N/A when there is no interface assigned.
EAP Identity	This shows the EAP identity of the authentication. This displays N/A when there is no EAP identity assigned.
EAP method	This shows the EAP method used in the authentication. This displays N/A when there is no EAP method assigned.
Bidirectional Authentication	This shows whether bidirectional authentication is allowed.
Certificate	This shows the certificate used for this authentication. This displays N/A when there is no certificate assigned.
Trusted CA	This shows the Trusted CA used for this authentication. This displays N/A when there is no Trusted CA assigned.
Modify	Click this icon to edit an item.

6.5.1 Modify 802.1X Settings

Use this screen to edit 802.1X authentication settings. Click the **Edit** icon next to the rule you want to edit. The screen shown next appears.

Figure 27 Network Setting > Broadband > 802.1x > Modify

The following table describes the labels in this screen.

Table 15 Network Setting > Broadband > 802.1x: Edit

LABEL	DESCRIPTION
Active	This field allows you to activate/deactivate the authentication. Select this to enable the authentication. Clear this to disable this authentication without having to delete the entry.
Interface	Select an interface to which the authentication applies.
EAP Identity	Enter the EAP identity of the authentication.
EAP method	This is the EAP method used for this authentication.
Bidirectional Authentication	Select Enable to allow bidirectional authentication.
Certificate	Select the certificate you want to assign to the authentication. You need to import the certificate in the Security > Certificates > Local Certificates screen.
Trusted CA	Select the Trusted CA you want to assign to the authentication. You need to import the certificate in the Security > Certificates > Trusted CA screen.
OK	Click OK to save your changes.
Cancel	Click Cancel to exit this screen without saving.

6.6 Technical Reference

The following section contains additional technical information about the VMG features described in this chapter.

Encapsulation

Be sure to use the encapsulation method required by your ISP. The VMG can work in bridge mode or routing mode. When the VMG is in routing mode, it supports the following methods.

IP over Ethernet

IP over Ethernet (IPoE) is an alternative to PPPoE. IP packets are being delivered across an Ethernet network, without using PPP encapsulation. They are routed between the Ethernet interface and the WAN interface and then formatted so that they can be understood in a bridged environment. For instance, it encapsulates routed Ethernet frames into bridged Ethernet cells.

PPP over ATM (PPPoA)

PPPoA stands for Point to Point Protocol over ATM Adaptation Layer 5 (AAL5). A PPPoA connection functions like a dial-up Internet connection. The VMG encapsulates the PPP session based on RFC1483 and sends it through an ATM PVC (Permanent Virtual Circuit) to the Internet Service Provider's (ISP) DSLAM (digital access multiplexer). Please refer to RFC 2364 for more information on PPPoA. Refer to RFC 1661 for more information on PPP.

PPP over Ethernet (PPPoE)

Point-to-Point Protocol over Ethernet (PPPoE) provides access control and billing functionality in a manner similar to dial-up services using PPP. PPPoE is an IETF standard (RFC 2516) specifying how a personal computer (PC) interacts with a broadband modem (DSL, cable, wireless, etc.) connection.

For the service provider, PPPoE offers an access and authentication method that works with existing access control systems (for example RADIUS).

One of the benefits of PPPoE is the ability to let you access one of multiple network services, a function known as dynamic service selection. This enables the service provider to easily create and offer new IP services for individuals.

Operationally, PPPoE saves significant effort for both you and the ISP or carrier, as it requires no specific configuration of the broadband modem at the customer site.

By implementing PPPoE directly on the VMG (rather than individual computers), the computers on the LAN do not need PPPoE software installed, since the VMG does that part of the task. Furthermore, with NAT, all of the LANs' computers will have access.

RFC 1483

RFC 1483 describes two methods for Multiprotocol Encapsulation over ATM Adaptation Layer 5 (AAL5). The first method allows multiplexing of multiple protocols over a single ATM virtual circuit (LLC-based multiplexing) and the second method assumes that each protocol is carried over a separate ATM virtual circuit (VC-based multiplexing). Please refer to RFC 1483 for more detailed information.

Multiplexing

There are two conventions to identify what protocols the virtual circuit (VC) is carrying. Be sure to use the multiplexing method required by your ISP.

VC-based Multiplexing

In this case, by prior mutual agreement, each protocol is assigned to a specific virtual circuit; for example, VC1 carries IP, etc. VC-based multiplexing may be dominant in environments where dynamic creation of large numbers of ATM VCs is fast and economical.

LLC-based Multiplexing

In this case one VC carries multiple protocols with protocol identifying information being contained in each packet header. Despite the extra bandwidth and processing overhead, this method may be advantageous if it is not practical to have a separate VC for each carried protocol, for example, if charging heavily depends on the number of simultaneous VCs.

Traffic Shaping

Traffic Shaping is an agreement between the carrier and the subscriber to regulate the average rate and fluctuations of data transmission over an ATM network. This agreement helps eliminate congestion, which is important for transmission of real time data such as audio and video connections.

Peak Cell Rate (PCR) is the maximum rate at which the sender can send cells. This parameter may be lower (but not higher) than the maximum line speed. 1 ATM cell is 53 bytes (424 bits), so a maximum speed of 832Kbps gives a maximum PCR of 1962 cells/sec. This rate is not guaranteed because it is dependent on the line speed.

Sustained Cell Rate (SCR) is the mean cell rate of each bursty traffic source. It specifies the maximum average rate at which cells can be sent over the virtual connection. SCR may not be greater than the PCR.

Maximum Burst Size (MBS) is the maximum number of cells that can be sent at the PCR. After MBS is reached, cell rates fall below SCR until cell rate averages to the SCR again. At this time, more cells (up to the MBS) can be sent at the PCR again.

If the PCR, SCR or MBS is set to the default of "0", the system will assign a maximum value that correlates to your upstream line rate.

The following figure illustrates the relationship between PCR, SCR and MBS.

Figure 28 Example of Traffic Shaping

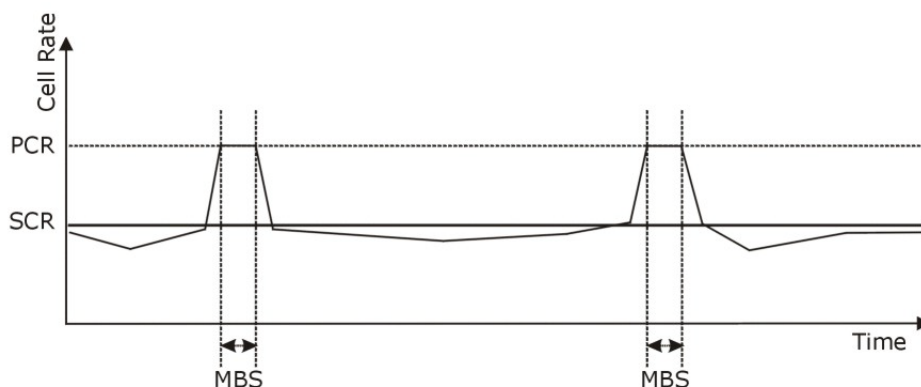

ATM Traffic Classes

These are the basic ATM traffic classes defined by the ATM Forum Traffic Management 4.0 Specification.

Constant Bit Rate (CBR)

Constant Bit Rate (CBR) provides fixed bandwidth that is always available even if no data is being sent. CBR traffic is generally time-sensitive (doesn't tolerate delay). CBR is used for connections that continuously require a specific amount of bandwidth. A PCR is specified and if traffic exceeds this rate, cells may be dropped. Examples of connections that need CBR would be high-resolution video and voice.

Variable Bit Rate (VBR)

The Variable Bit Rate (VBR) ATM traffic class is used with bursty connections. Connections that use the Variable Bit Rate (VBR) traffic class can be grouped into real time (VBR-RT) or non-real time (VBR-nRT) connections.

The VBR-RT (real-time Variable Bit Rate) type is used with bursty connections that require closely controlled delay and delay variation. It also provides a fixed amount of bandwidth (a PCR is specified) but is only available when data is being sent. An example of an VBR-RT connection would be video conferencing. Video conferencing requires real-time data transfers and the bandwidth requirement varies in proportion to the video image's changing dynamics.

The VBR-nRT (non real-time Variable Bit Rate) type is used with bursty connections that do not require closely controlled delay and delay variation. It is commonly used for "bursty" traffic typical on LANs. PCR and MBS define the burst levels, SCR defines the minimum level. An example of an VBR-nRT connection would be non-time sensitive data file transfers.

Unspecified Bit Rate (UBR)

The Unspecified Bit Rate (UBR) ATM traffic class is for bursty data transfers. However, UBR doesn't guarantee any bandwidth and only delivers traffic when the network has spare bandwidth. An example application is background file transfer.

IP Address Assignment

A static IP is a fixed IP that your ISP gives you. A dynamic IP is not fixed; the ISP assigns you a different one each time. The Single User Account feature can be enabled or disabled if you have either a dynamic or static IP. However the encapsulation method assigned influences your choices for IP address and default gateway.

Introduction to VLANs

A Virtual Local Area Network (VLAN) allows a physical network to be partitioned into multiple logical networks. Devices on a logical network belong to one group. A device can belong to more than one group. With VLAN, a device cannot directly talk to or hear from devices that are not in the same group(s); the traffic must first go through a router.

In Multi-Tenant Unit (MTU) applications, VLAN is vital in providing isolation and security among the subscribers. When properly configured, VLAN prevents one subscriber from accessing the network resources of another on the same LAN, thus a user will not see the printers and hard disks of another user in the same building.

VLAN also increases network performance by limiting broadcasts to a smaller and more manageable logical broadcast domain. In traditional switched environments, all broadcast packets go to each and every individual port. With VLAN, all broadcasts are confined to a specific broadcast domain.

Introduction to IEEE 802.1Q Tagged VLAN

A tagged VLAN uses an explicit tag (VLAN ID) in the MAC header to identify the VLAN membership of a frame across bridges - they are not confined to the switch on which they were created. The VLANs can be created statically by hand or dynamically through GVRP. The VLAN ID associates a frame with a specific VLAN and provides the information that switches need to process the frame across the network. A tagged frame is four bytes longer than an untagged frame and contains two bytes of TPID (Tag Protocol Identifier), residing within the type/length field of the Ethernet frame) and two bytes of TCI (Tag Control Information), starts after the source address field of the Ethernet frame).

The CFI (Canonical Format Indicator) is a single-bit flag, always set to zero for Ethernet switches. If a frame received at an Ethernet port has a CFI set to 1, then that frame should not be forwarded as it is to an untagged port. The remaining twelve bits define the VLAN ID, giving a possible maximum number of 4,096 VLANs. Note that user priority and VLAN ID are independent of each other. A frame with VID (VLAN Identifier) of null (0) is called a priority frame, meaning that only the priority level is significant and the default VID of the ingress port is given as the VID of the frame. Of the 4096 possible VIDs, a VID of 0 is used to identify priority frames and value 4095 (FFF) is reserved, so the maximum possible VLAN configurations are 4,094.

TPID	User Priority	CFI	VLAN ID
2 Bytes	3 Bits	1 Bit	12 Bits

Multicast

IP packets are transmitted in either one of two ways - Unicast (1 sender - 1 recipient) or Broadcast (1 sender - everybody on the network). Multicast delivers IP packets to a group of hosts on the network - not everybody and not just 1.

Internet Group Multicast Protocol (IGMP) is a network-layer protocol used to establish membership in a Multicast group - it is not used to carry user data. IGMP version 2 (RFC 2236) is an improvement over version 1 (RFC 1112) but IGMP version 1 is still in wide use. If you would like to read more detailed information about interoperability between IGMP version 2 and version 1, please see sections 4 and 5 of RFC 2236. The class D IP address is used to identify host groups and can be in the range 224.0.0.0 to 239.255.255.255. The address 224.0.0.0 is not assigned to any group and is used by IP multicast computers. The address 224.0.0.1 is used for query messages and is assigned to the permanent group of all IP hosts (including gateways). All hosts must join the 224.0.0.1 group in order to participate in IGMP. The address 224.0.0.2 is assigned to the multicast routers group.

At start up, the VMG queries all directly connected networks to gather group membership. After that, the VMG periodically updates this information.

DNS Server Address Assignment

Use Domain Name System (DNS) to map a domain name to its corresponding IP address and vice versa, for instance, the IP address of www.zyxel.com is 204.217.0.2. The DNS server is extremely

important because without it, you must know the IP address of a computer before you can access it.

The VMG can get the DNS server addresses in the following ways.

- 1 The ISP tells you the DNS server addresses, usually in the form of an information sheet, when you sign up. If your ISP gives you DNS server addresses, manually enter them in the DNS server fields.
- 2 If your ISP dynamically assigns the DNS server IP addresses (along with the VMG's WAN IP address), set the DNS server fields to get the DNS server address from the ISP.

IPv6 Addressing

The 128-bit IPv6 address is written as eight 16-bit hexadecimal blocks separated by colons (:). This is an example IPv6 address `2001:0db8:1a2b:0015:0000:0000:1a2f:0000`.

IPv6 addresses can be abbreviated in two ways:

- Leading zeros in a block can be omitted. So `2001:0db8:1a2b:0015:0000:0000:1a2f:0000` can be written as `2001:db8:1a2b:15:0:0:1a2f:0`.
- Any number of consecutive blocks of zeros can be replaced by a double colon. A double colon can only appear once in an IPv6 address. So `2001:0db8:0000:0000:1a2f:0000:0000:0015` can be written as `2001:0db8::1a2f:0000:0000:0015`, `2001:0db8:0000:0000:1a2f::0015`, `2001:db8::1a2f:0:0:15` or `2001:db8:0:0:1a2f::15`.

IPv6 Prefix and Prefix Length

Similar to an IPv4 subnet mask, IPv6 uses an address prefix to represent the network address. An IPv6 prefix length specifies how many most significant bits (start from the left) in the address compose the network address. The prefix length is written as "/x" where x is a number. For example,

```
2001:db8:1a2b:15::1a2f:0/32
```

means that the first 32 bits (`2001:db8`) is the subnet prefix.

7.1 Overview

This chapter describes the VMG's **Network Setting > Wireless** screens. Use these screens to set up your VMG's wireless connection.

7.1.1 What You Can Do in this Chapter

This section describes the VMG's **Wireless** screens. Use these screens to set up your VMG's wireless connection.

- Use the **General** screen to enable the Wireless LAN, enter the SSID and select the wireless security mode ([Section 7.2 on page 86](#)).
- Use the **Guest / More AP** screen to set up multiple wireless networks on your VMG ([Section 7.3 on page 91](#)).
- Use the **MAC Authentication** screen to allow or deny wireless clients based on their MAC addresses from connecting to the VMG ([Section 7.5 on page 94](#)).
- Use the **WPS** screen to enable or disable WPS, view or generate a security PIN (Personal Identification Number) ([Section 7.5 on page 94](#)).
- Use the **WMM** screen to enable Wi-Fi MultiMedia (WMM) to ensure quality of service in wireless networks for multimedia applications ([Section 7.6 on page 96](#)).
- Use the **WDS** screen to set up a Wireless Distribution System, in which the VMG acts as a bridge with other ZyXEL access points ([Section 7.7 on page 97](#)).
- Use the **Others** screen to configure wireless advanced features, such as the RTS/CTS Threshold ([Section 7.8 on page 99](#)).
- Use the **Channel Status** screen to scan wireless LAN channel noises and view the results ([Section 7.9 on page 101](#)).

7.1.2 What You Need to Know

Wireless Basics

"Wireless" is essentially radio communication. In the same way that walkie-talkie radios send and receive information over the airwaves, wireless networking devices exchange information with one another. A wireless networking device is just like a radio that lets your computer exchange information with radios attached to other computers. Like walkie-talkies, most wireless networking devices operate at radio frequency bands that are open to the public and do not require a license to use. However, wireless networking is different from that of most traditional radio communications in that there are a number of wireless networking standards available with different methods of data encryption.

Finding Out More

See [Section 7.10 on page 102](#) for advanced technical information on wireless networks.

7.2 The General Screen

Use this screen to enable the Wireless LAN, enter the SSID and select the wireless security mode.

Note: If you are configuring the VMG from a computer connected to the wireless LAN and you change the VMG's SSID, channel or security settings, you will lose your wireless connection when you press **Apply** to confirm. You must then change the wireless settings of your computer to match the VMG's new settings.

Click **Network Setting > Wireless** to open the **General** screen.

Figure 29 Network Setting > Wireless > General

Wireless Network Setup

Band:

Wireless: Enable Disable (settings are invalid when disabled)

Channel: Current: 8

Bandwidth:

Control Sideband:

(Lower = channels 1-9; Upper = channels 5-13; Choose the sideband of least interference for the best connection.)

Passphrase Type:

Wireless Network Settings

Wireless Network Name (SSID):

Max Clients:

Hide SSID

Multicast Forwarding

Max. Upstream Bandwidth: Kbps

Max. Downstream Bandwidth: Kbps

Note:

1. Max. Upstream Bandwidth: This field allow user configure the maximum bandwidth of this SSID to WAN.
2. Max. Downstream Bandwidth: This field allow user configure the maximum bandwidth of WAN to this SSID.
3. If Max. Upstream/Downstream Bandwidth is empty, the CPE sets the value automatically.

BSSID: 90:EF:68:D5:94:E1

Security Level

No Security
Basic
More Secure (Recommended)



Security Mode:

Generate password automatically

Enter 8-63 ASCII characters or 64 hexadecimal digits ("0-9", "A-F").

Password: [more...](#)

password unmask

The following table describes the general wireless LAN labels in this screen.

Table 16 Network Setting > Wireless > General

LABEL	DESCRIPTION
Wireless Network Setup	
Bandwidth	This shows the wireless band which this radio profile is using. 2.4GHz is the frequency used by IEEE 802.11b/g/n wireless clients while 5GHz is used by IEEE 802.11a/ac wireless clients.
Wireless	You can Enable or Disable the wireless LAN in this field.
Channel	Use Auto to have the VMG automatically determine a channel to use.
Bandwidth	<p>Select whether the VMG uses a wireless channel width of 20MHz, 40MHz or 80MHz.</p> <p>A standard 20MHz channel offers transfer speeds of up to 150Mbps whereas a 40MHz channel uses two standard channels and offers speeds of up to 300 Mbps.</p> <p>40MHz (channel bonding or dual channel) bonds two adjacent radio channels to increase throughput. The wireless clients must also support 40 MHz. It is often better to use the 20 MHz setting in a location where the environment hinders the wireless signal.</p> <p>An 80MHz channel groups adjacent 40MHz channels into pairs to increase bandwidth even higher.</p> <p>Select 20MHz if you want to lessen radio interference with other wireless devices in your neighborhood or the wireless clients do not support channel bonding.</p>
Control Sideband	This is available for some regions when you select a specific channel and set the wireless channel width to 40MHz . Set whether the control channel (set in the Channel field) should be in the Lower or Upper range of channel bands.
Passphrase Type	<p>If you set security for the wireless LAN and have the VMG generate a password, the setting in this field determines how the VMG generates the password.</p> <p>Select None to set the VMG's password generation to not be based on a passphrase.</p> <p>Select Fixed to use a 16 character passphrase for generating a password.</p> <p>Select Variable to use a 16 to 63 character passphrase for generating a password.</p>
Passphrase Key	<p>For a fixed type passphrase enter 16 alphanumeric characters (0-9, A-Z, with no spaces). It must contain both letters and numbers and is case-sensitive.</p> <p>For a variable type passphrase enter 16 to 63 alphanumeric characters (0-9, A-Z, with no spaces). It must contain both letters and numbers and is case-sensitive.</p>
Wireless Network Settings	
Wireless Network Name	<p>The SSID (Service Set IDentity) identifies the service set with which a wireless device is associated. Wireless devices associating to the access point (AP) must have the same SSID.</p> <p>Enter a descriptive name (up to 32 English keyboard characters) for the wireless LAN.</p>
Max Clients	Specify the maximum number of clients that can connect to this network at the same time.
Hide SSID	Select this check box to hide the SSID in the outgoing beacon frame so a station cannot obtain the SSID through scanning using a site survey tool.
Multicast Forwarding	Select this check box to allow the VMG to convert wireless multicast traffic into wireless unicast traffic.
Max. Upstream Bandwidth	Specify the maximum rate for upstream wireless traffic to the WAN from this WLAN in kilobits per second (Kbps).
Max. Downstream Bandwidth	Specify the maximum rate for downstream wireless traffic to this WLAN from the WAN in kilobits per second (Kbps).
BSSID	This shows the MAC address of the wireless interface on the VMG when wireless LAN is enabled.

Table 16 Network Setting > Wireless > General (continued)

LABEL	DESCRIPTION
Security Level	Select Basic (WEP) or More Secure (WPA(2)-PSK, WPA-WPA2-Personal) to add security on this wireless network. The wireless clients which want to associate to this network must have same wireless security settings as the VMG. When you select to use a security, additional options appears in this screen. Or you can select No Security to allow any client to associate this network without any data encryption or authentication. See the following sections for more details about this field.
Apply	Click Apply to save your changes.
Cancel	Click Cancel to restore your previously saved settings.

7.2.1 No Security

Select **No Security** to allow wireless stations to communicate with the access points without any data encryption or authentication.

Note: If you do not enable any wireless security on your VMG, your network is accessible to any wireless networking device that is within range.

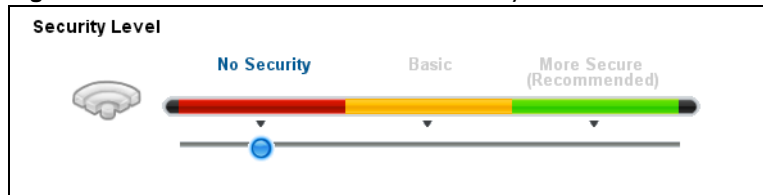
Figure 30 Wireless > General: No Security

The following table describes the labels in this screen.

Table 17 Wireless > General: No Security

LABEL	DESCRIPTION
Security Level	Choose No Security to allow all wireless connections without data encryption or authentication.

7.2.2 Basic (WEP Encryption)

WEP encryption scrambles the data transmitted between the wireless stations and the access points (AP) to keep network communications private. Both the wireless stations and the access points must use the same WEP key.

Note: WEP is extremely insecure. Its encryption can be broken by an attacker, using widely-available software. It is strongly recommended that you use a more effective security mechanism. Use the strongest security mechanism that all the wireless devices in your network support. For example, use WPA-PSK or WPA2-PSK if all your wireless devices support it, or use WPA or WPA2 if your wireless devices support it and you have a RADIUS server. If your wireless devices support nothing stronger than WEP, use the highest encryption level available.

Your VMG allows you to configure up to four 64-bit or 128-bit WEP keys but only one key can be enabled at any one time.

In order to configure and enable WEP encryption, click **Network Setting > Wireless** to display the **General** screen, then select **Basic** as the security level.

Figure 31 Wireless > General: Basic (WEP)

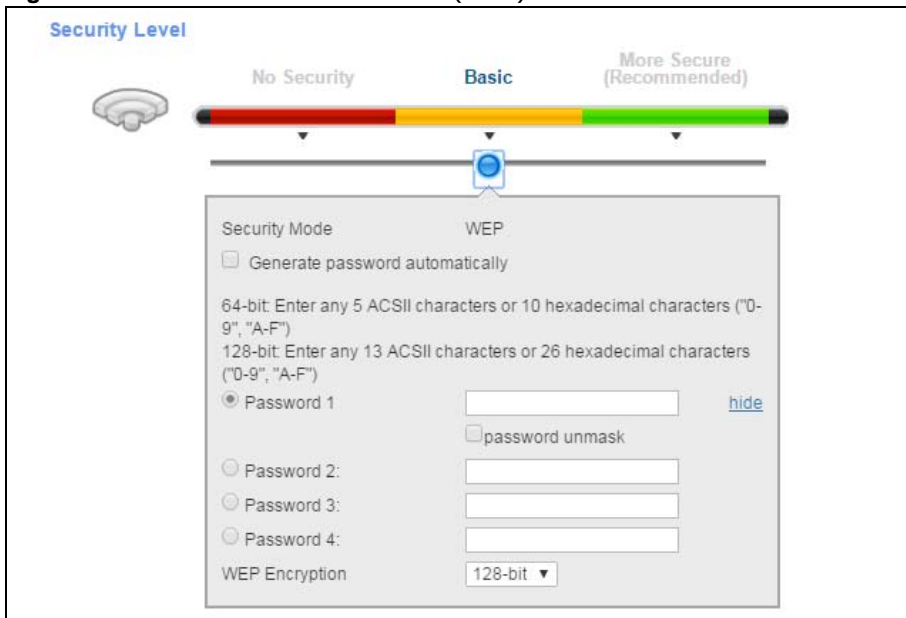

The following table describes the labels in this screen.

Table 18 Wireless > General: Basic (WEP)

LABEL	DESCRIPTION
Security Level	Select Basic to enable WEP data encryption.
Security Mode	This shows WEP when you set Security Level to Basic .
Generate password automatically	Select this option to have the VMG automatically generate a password. The password field will not be configurable when you select this option.
Password 1~4	The password (WEP keys) are used to encrypt data. Both the VMG and the wireless stations must use the same password (WEP key) for data transmission. If you chose 64-bit WEP, then enter any 5 ASCII characters or 10 hexadecimal characters ("0-9", "A-F"). If you chose 128-bit WEP, then enter 13 ASCII characters or 26 hexadecimal characters ("0-9", "A-F"). You must configure at least one password, only one password can be activated at any one time.
more.../less	Click more... to show more fields in this section. Click hide to hide them.
password unmask	Select password unmask to show your entered password in plain text.
WEP Encryption	Select 64-bits or 128-bits . This dictates the length of the security key that the network is going to use.

7.2.3 More Secure (WPA(2)-PSK)

The WPA-PSK security mode provides both improved data encryption and user authentication over WEP. Using a Pre-Shared Key (PSK), both the VMG and the connecting client share a common

password in order to validate the connection. This type of encryption, while robust, is not as strong as WPA, WPA2 or even WPA2-PSK. The WPA2-PSK security mode is a newer, more robust version of the WPA encryption standard. It offers slightly better security, although the use of PSK makes it less robust than it could be.

Click **Network Setting > Wireless** to display the **General** screen.

Note: **WPA-PSK** or **WPA-WPA2-Personal** is not available if you enable WPS before you configure them.

Figure 32 Wireless > General: More Secure: WPA(2)-PSK

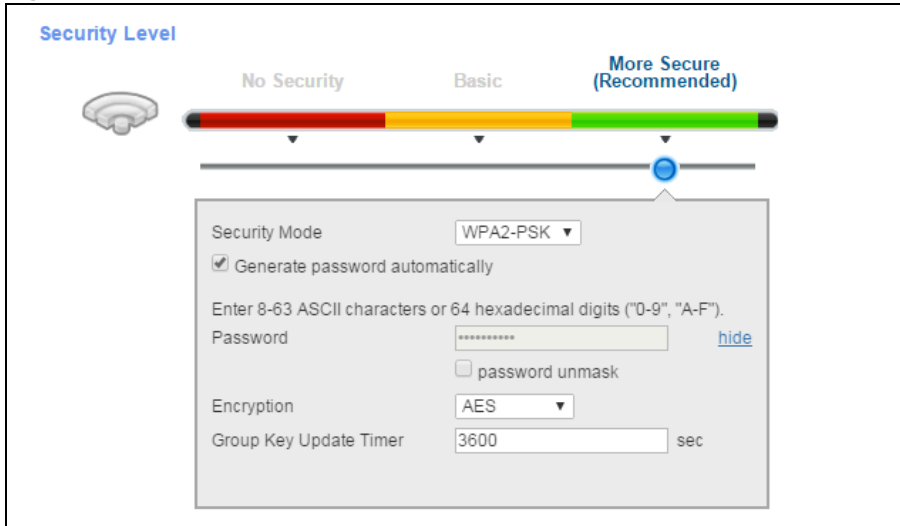

The following table describes the labels in this screen.

Table 19 Wireless > General: More Secure: WPA(2)-PSK

LABEL	DESCRIPTION
Security Level	Select More Secure to enable WPA(2)-PSK data encryption.
Security Mode	Select WPA-PSK , WPA2-PSK or WPA-WPA2-Personal from the drop-down list box.
Generate password automatically	Select this option to have the VMG automatically generate a password. The password field will not be configurable when you select this option.
Password	The encryption mechanisms used for WPA(2) and WPA(2)-PSK are the same. The only difference between the two is that WPA(2)-PSK uses a simple common password, instead of user-specific credentials. If you did not select Generate password automatically , you can manually type a pre-shared key from 8 to 64 case-sensitive keyboard characters.
more.../hide	Click more... to show more fields in this section. Click hide to hide them.
password unmask	Select password unmask to show your entered password in plain text.
Encryption	Select the encryption type (TKIP , AES or TKIP+AES) for data encryption. Select TKIP if your wireless clients can all use TKIP. Select AES if your wireless clients can all use AES. Select TKIP+AES to allow the wireless clients to use either TKIP or AES.
Group Key Update Timer	The Group Key Update Timer is the rate at which the RADIUS server sends a new group key out to all clients.

7.3 The Guest / More AP Screen

This screen allows you to enable and configure multiple Basic Service Sets (BSSs) on the VMG.

Click **Network Setting > Wireless > Guest / More AP**. The following screen displays.

Figure 33 Network Setting > Wireless > Guest / More AP

#	Status	SSID	Security	Guest WLAN	Modify
2		ZyXEL_Guest	WPA2-Personal	External Guest	
3		ZyXEL_Guest	WPA2-Personal	External Guest	
4		ZyXEL_Guest	WPA2-Personal	External Guest	

The following table describes the labels in this screen.

Table 20 Network Setting > Wireless > Guest / More AP

LABEL	DESCRIPTION
#	This is the index number of the entry.
Status	This field indicates whether this SSID is active. A yellow bulb signifies that this SSID is active. A gray bulb signifies that this SSID is not active.
SSID	An SSID profile is the set of parameters relating to one of the VMG's BSSs. The SSID (Service Set Identifier) identifies the Service Set with which a wireless device is associated. This field displays the name of the wireless profile on the network. When a wireless client scans for an AP to associate with, this is the name that is broadcast and seen in the wireless client utility.
Security	This field indicates the security mode of the SSID profile.
Guest WLAN	This displays if the guest WLAN function has been enabled for this WLAN. If Home Guest displays, clients connecting to the same SSID can communicate with each other directly. If External Guest displays, clients are blocked from connecting to each other directly. N/A displays if guest WLAN is disabled.
Modify	Click the Edit icon to configure the SSID profile.

7.3.1 Edit Guest / More AP

Use this screen to edit an SSID profile. Click the **Edit** icon next to an SSID in the **Guest / More AP** screen. The following screen displays.

Figure 34 Network Setting > Wireless > Guest / More AP > Edit

Wireless Network Setup

Wireless Enable Disable (settings are invalid when disabled)

Passphrase Type

Wireless Network Settings

Wireless Network Name(SSID):

Hide SSID

Multicast Forwarding

Guest WLAN

Access Scenario:

Max. Upstream Bandwidth: Kbps

Max. Downstream Bandwidth: Kbps

Note:

1. Max. Upstream Bandwidth: This field allow user configure the maximum bandwidth of this SSID to WAN.
2. Max. Downstream Bandwidth: This field allow user configure the maximum bandwidth of WAN to this SSID.
3. If Max. Upstream/Downstream Bandwidth is empty, the CPE sets the value automatically.

SSID Subnet: Enable Disable

DHCP Start Address:

DHCP End Address:

SSID Subnet Mask:

LAN IP Address:

Security Level

No Security Basic **More Secure (Recommended)**

Security Mode

Generate password automatically

Enter 8-63 ASCII characters or 64 hexadecimal digits ("0-9", "A-F").

Password [more...](#)

password unmask

The following table describes the fields in this screen.

Table 21 Network Setting > Wireless > Guest / More AP > Edit

LABEL	DESCRIPTION
Wireless Network Setup	
Wireless	You can Enable or Disable the wireless LAN in this field.
Passphrase Type	If you set security for the wireless LAN and have the VMG generate a password, the setting in this field determines how the VMG generates the password. Select None to set the VMG's password generation to not be based on a passphrase. Select Fixed to use a 16-character passphrase for generating a password. Select Variable to use a 16 to 63 character passphrase for generating a password.
Wireless Network Settings	

Table 21 Network Setting > Wireless > Guest / More AP > Edit (continued)

LABEL	DESCRIPTION
Wireless Network Name (SSID)	The SSID (Service Set IDentity) identifies the service set with which a wireless device is associated. Wireless devices associating to the access point (AP) must have the same SSID. Enter a descriptive name (up to 32 English keyboard characters) for the wireless LAN.
Max clients	Specify the maximum number of clients that can connect to this network at the same time.
Hide SSID	Select this check box to hide the SSID in the outgoing beacon frame so a station cannot obtain the SSID through scanning using a site survey tool.
Multicast Forwarding	Select this check box to allow the VMG to convert wireless multicast traffic into wireless unicast traffic.
Guest WLAN	Select this to create Guest WLANs for home and external clients. Select the WLAN type in the Access Scenario field.
Access Scenario	If you select Home Guest , clients connecting to the same SSID can communicate with each other directly. If you select External Guest , clients are blocked from connecting to each other directly.
Max. Upstream Bandwidth	Specify the maximum rate for upstream wireless traffic to the WAN from this WLAN in kilobits per second (Kbps).
Max. Downstream Bandwidth	Specify the maximum rate for downstream wireless traffic to this WLAN from the WAN in kilobits per second (Kbps).
SSID Subnet	Select Enable to create an independent subnet for the SSID, which is separated from the LAN subnet(s).
DHCP Start Address	Enter the first of the contiguous addresses in the IP address pool for the SSID subnet. The VMG assigns IP addresses from this DHCP pool to wireless clients connecting to the SSID.
DHCP End Address	Enter the last of the contiguous addresses in the IP address pool for the SSID subnet.
SSID Subnet Mask	Enter the subnet mask of the VMG for the SSID subnet.
LAN IP Address	Enter the IP address of the VMG for the SSID subnet.
Security Level	
Security Mode	Select Basic (WEP) or More Secure (WPA(2)-PSK, WPA-WPA2-Personal) to add security on this wireless network. The wireless clients which want to associate to this network must have same wireless security settings as the VMG. After you select to use a security, additional options appears in this screen. Or you can select No Security to allow any client to associate this network without any data encryption or authentication. See Section 7.2.1 on page 88 for more details about this field.
Apply	Click Apply to save your changes.
Cancel	Click Cancel to exit this screen without saving.

7.4 The MAC Authentication Screen

This screen allows you to configure the VMG to give exclusive access to specific devices (**Allow**) or exclude specific devices from accessing the VMG (**Deny**). Every Ethernet device has a unique MAC (Media Access Control) address. The MAC address is assigned at the factory and consists of six

pairs of hexadecimal characters, for example, 00:A0:C5:01:23:45. You need to know the MAC addresses of the devices to configure this screen.

Use this screen to view your VMG's MAC filter settings and add new MAC filter rules. Click **Network Setting > Wireless > MAC Authentication**. The screen appears as shown.

Figure 35 Wireless > MAC Authentication

MAC Authentication can allow or block the access of the device(s) to your wireless network. Edit the list in the table to decide the rule of the access on device(s).

General

SSID: ZyXEL_0002 ▼

MAC Restrict Mode: Allow ▼

MAC address List

Add new MAC address

#	MAC Address	Modify
1	00-A0-C5-01-23-45	

Apply Cancel

The following table describes the labels in this screen.

Table 22 Wireless > MAC Authentication

LABEL	DESCRIPTION
SSID	Select the SSID for which you want to configure MAC filter settings.
MAC Restrict Mode	Define the filter action for the list of MAC addresses in the MAC Address table. Select Disable to turn off MAC filtering. Select Deny to block access to the VMG. MAC addresses not listed will be allowed to access the VMG. Select Allow to permit access to the VMG. MAC addresses not listed will be denied access to the VMG.
Add new MAC address	Click this if you want to add a new MAC address entry to the MAC filter list below. Enter the MAC addresses of the wireless devices that are allowed or denied access to the VMG in these address fields. Enter the MAC addresses in a valid MAC address format, that is, six hexadecimal character pairs, for example, 12:34:56:78:9a:bc.
#	This is the index number of the entry.
MAC Address	This is the MAC addresses of the wireless devices that are allowed or denied access to the VMG.
Modify	Click the Delete icon to remove the entry. Click the Edit icon to change the MAC address.
Apply	Click Apply to save your changes.
Cancel	Click Cancel to exit this screen without saving.

7.5 The WPS Screen

Use this screen to configure WiFi Protected Setup (WPS) on your VMG.

WPS allows you to quickly set up a wireless network with strong security, without having to configure security settings manually. Set up each WPS connection between two devices. Both devices must support WPS. See [Section 7.10.9.3 on page 111](#) for more information about WPS.

Note: The VMG applies the security settings of the **SSID1** profile (see [Section 7.2 on page 86](#)). If you want to use the WPS feature, make sure you have set the security mode of **SSID1** to **WPA2-PSK** or **No Security**.

Click **Network Setting > Wireless > WPS**. The following screen displays. Select **Enable** and click **Apply** to activate the WPS function. Then you can configure the WPS settings in this screen.

Figure 36 Network Setting > Wireless > WPS

The following table describes the labels in this screen.

Table 23 Network Setting > Wireless > WPS

LABEL	DESCRIPTION
General	
WPS	Select Enable to activate WPS on this VMG.
Add a new device with WPS Method	
Method 1	Use this section to set up a WPS wireless network using Push Button Configuration (PBC). Select Enable and click Apply to activate WPS method 1 on the VMG.
WPS	Click this button to add another WPS-enabled wireless device (within wireless range of the VMG) to your wireless network. This button may either be a physical button on the outside of device, or a menu button similar to the WPS button on this screen. Note: You must press the other wireless device's WPS button within two minutes of pressing this button.
Method 2	Use this section to set up a WPS wireless network by entering the PIN of the client into the VMG. Select Enable and click Apply to activate WPS method 2 on the VMG.

Table 23 Network Setting > Wireless > WPS (continued)

LABEL	DESCRIPTION
Register	Enter the PIN of the device that you are setting up a WPS connection with and click Register to authenticate and add the wireless device to your wireless network. You can find the PIN either on the outside of the device, or by checking the device's settings. Note: You must also activate WPS on that device within two minutes to have it present its PIN to the VMG.
Method 3	Use this section to set up a WPS wireless network by entering the PIN of the VMG into the client. Select Enable and click Apply to activate WPS method 3 on the VMG.
Release Configuration	The default WPS status is configured. Click this button to remove all configured wireless and wireless security settings for WPS connections on the VMG.
Generate New PIN	If this method has been enabled, the PIN (Personal Identification Number) of the VMG is shown here. Enter this PIN in the configuration utility of the device you want to connect to using WPS. The PIN is not necessary when you use WPS push-button method. Click the Generate New PIN button to have the VMG create a new PIN.
Apply	Click Apply to save your changes.
Cancel	Click Cancel to restore your previously saved settings.

7.6 The WMM Screen

Use this screen to enable Wi-Fi MultiMedia (WMM) and WMM Power Save in wireless networks for multimedia applications.

Click **Network Setting > Wireless > WMM**. The following screen displays.

Figure 37 Network Setting > Wireless > WMM

WMM of SSID1 : Enable Disable
WMM of SSID2 : Enable Disable
WMM of SSID3 : Enable Disable
WMM of SSID4 : Enable Disable
WMM Automatic Power Save Delivery(APSD) : Enable Disable

The following table describes the labels in this screen.

Table 24 Network Setting > Wireless > WMM

LABEL	DESCRIPTION
WMM of SSID1~4	Select Enable to have the VMG automatically give the wireless network (SSIDx) a priority level according to the ToS value in the IP header of packets it sends. WMM QoS (Wifi MultiMedia Quality of Service) gives high priority to voice and video, which makes them run more smoothly.
WMM Automatic Power Save Delivery(APSD)	Select Enable to extend the battery life of your mobile devices (especially useful for small devices that are running multimedia applications). The VMG goes to sleep mode to save power when it is not transmitting data. The AP buffers the packets sent to the VMG until the VMG "wakes up". The VMG wakes up periodically to check for incoming data. Note: This works only if the wireless device to which the VMG is connected also supports this feature.
Apply	Click Apply to save your changes.
Cancel	Click Cancel to restore your previously saved settings.

7.7 The WDS Screen

An AP using the Wireless Distribution System (WDS) can function as a wireless network bridge allowing you to wirelessly connect two wired network segments. The **WDS** screen allows you to configure the VMG to connect to two or more APs wirelessly when WDS is enabled.

Use this screen to set up your WDS (Wireless Distribution System) links between the VMG and other wireless APs. You need to know the MAC address of the peer device. Once the security settings of peer sides match one another, the connection between devices is made.

Note: WDS security is independent of the security settings between the VMG and any wireless clients.

Note: At the time of writing, WDS is compatible with other ZyXEL APs only. Not all models support WDS links. Check your other AP's documentation.

Click **Network Setting > Wireless > WDS**. The following screen displays.

Figure 38 Network Setting > Wireless > WDS

2.4GHz Wireless Bridge Setup

AP Mode:
 Bridge Restrict: Enable Disable

Remote Bridges MAC Address

#	MAC Address	Modify	Scan
1			
2			
3			
4			

Note:

1. The WDS function only works when the security mode is set to No Security, WEP, WPA-PSK and WPA2-PSK.
2. The WDS connection security mode is based on the settings configured in the Wireless > General screen.
3. The WDS function only works with the first SSID.
4. If the AP mode is Wireless Bridge, WPS will be disabled.
5. The SSID should be the same in both WPA-PSK or WPA2-PSK security modes.

The following table describes the labels in this screen.

Table 25 Network Setting > Wireless > WDS

LABEL	DESCRIPTION
2.4GHz Wireless Bridge Setup	
AP Mode	Select the operating mode for your VMG. <ul style="list-style-type: none"> • Access Point - The VMG functions as a bridge and access point simultaneously. • Wireless Bridge - The VMG acts as a wireless network bridge and establishes wireless links with other APs. In this mode, clients cannot connect to the VMG wirelessly.
Bridge Restrict	This field is available only when you set operating mode to Access Point . Select Enabled to turn on WDS and enter the peer device's MAC address manually in the table below. Select Disable to turn off WDS.
Remote Bridge MAC Address	You can enter the MAC address of the peer device by clicking the Edit icon under Modify .
#	This is the index number of the entry.
MAC Address	This shows the MAC address of the peer device. You can connect to up to 4 peer devices.
Modify	Click the Edit icon and type the MAC address of the peer device in a valid MAC address format (six hexadecimal character pairs, for example 12:34:56:78:9a:bc). Click the Delete icon to remove this entry.
Scan	Click the Scan icon to search and display the available APs within range.
Apply	Click Apply to save your changes.
Cancel	Click Cancel to restore your previously saved settings.

7.7.1 WDS Scan

You can click the **Scan** icon in **Wireless > WDS** to have the VMG automatically search and display the available APs within range. Select an AP and click **Apply** to have the VMG establish a wireless link with the selected wireless device.

Figure 39 Network Setting > Wireless > WDS: Scan

The following table describes the labels in this screen.

Table 26 Network Setting > Wireless > WDS: Scan

LABEL	DESCRIPTION
Wireless Bridge Scan Setup	
Refresh	Click Refresh to update the table.
#	This is the index number of the entry.
SSID	This shows the SSID of the available wireless device within range.
BSSID	This shows the MAC address of the available wireless device within range.
Apply	Click Apply to save your changes.
Cancel	Click Cancel to restore your previously saved settings.

7.8 The Others Screen

Use this screen to configure advanced wireless settings. Click **Network Setting > Wireless > Others**. The screen appears as shown.

See [Section 7.10.2 on page 104](#) for detailed definitions of the terms listed in this screen.

Figure 40 Network Setting > Wireless > Others

RTS/CTS Threshold :	<input type="text" value="2347"/>
Fragmentation Threshold :	<input type="text" value="2346"/>
Auto Channel Timer :	<input type="text" value="0"/> min
Output Power :	<input type="text" value="100%"/> ▼
Beacon Interval :	<input type="text" value="100"/> ms
DTIM Interval :	<input type="text" value="1"/> ms
802.11 Mode :	<input type="text" value="802.11b/g/n Mixed"/> ▼
802.11 Protection :	<input type="text" value="Off"/> ▼
RIFS Advertisement	<input type="text" value="Auto"/> ▼
Preamble :	<input type="text" value="Long"/> ▼
RX Chain Power Save	<input checked="" type="radio"/> Enable <input type="radio"/> Disable
OBSS Coexistence	<input checked="" type="radio"/> Enable <input type="radio"/> Disable
XPress™ Technology :	<input checked="" type="radio"/> Enable <input type="radio"/> Disable
WPS 2.0 :	<input checked="" type="radio"/> Enable <input type="radio"/> Disable
<input type="button" value="Apply"/> <input type="button" value="Cancel"/>	

The following table describes the labels in this screen.

Table 27 Network Setting > Wireless > Others

LABEL	DESCRIPTION
RTS/CTS Threshold	Data with its frame size larger than this value will perform the RTS (Request To Send)/CTS (Clear To Send) handshake. Enter a value between 0 and 2347.
Fragmentation Threshold	This is the maximum data fragment size that can be sent. Enter a value between 256 and 2346.
Auto Channel Timer	If you set the channel to Auto in the Network Setting > Wireless > General screen, specify the interval in minutes for how often the VMG scans for the best channel. Enter 0 to disable the periodical scan.
Output Power	Set the output power of the VMG. If there is a high density of APs in an area, decrease the output power to reduce interference with other APs. Select one of the following: 20% , 40% , 60% , 80% or 100% .
Beacon Interval	When a wirelessly networked device sends a beacon, it includes with it a beacon interval. This specifies the time period before the device sends the beacon again. The interval tells receiving devices on the network how long they can wait in low power mode before waking up to handle the beacon. This value can be set from 50ms to 1000ms. A high value helps save current consumption of the access point.
DTIM Interval	Delivery Traffic Indication Message (DTIM) is the time period after which broadcast and multicast packets are transmitted to mobile clients in the Power Saving mode. A high DTIM value can cause clients to lose connectivity with the network. This value can be set from 1 to 255.

Table 27 Network Setting > Wireless > Others (continued)

LABEL	DESCRIPTION
802.11 Mode	<p>Select 802.11b Only to allow only IEEE 802.11b compliant WLAN devices to associate with the VMG.</p> <p>Select 802.11g Only to allow only IEEE 802.11g compliant WLAN devices to associate with the VMG.</p> <p>Select 802.11n Only to allow only IEEE 802.11n compliant WLAN devices to associate with the VMG.</p> <p>Select 802.11b/g Mixed to allow either IEEE 802.11b or IEEE 802.11g compliant WLAN devices to associate with the VMG. The transmission rate of your VMG might be reduced.</p> <p>Select 802.11b/g/n Mixed to allow IEEE 802.11b, IEEE 802.11g or IEEE802.11n compliant WLAN devices to associate with the VMG. The transmission rate of your VMG might be reduced.</p>
802.11 Protection	<p>Enabling this feature can help prevent collisions in mixed-mode networks (networks with both IEEE 802.11b and IEEE 802.11g traffic).</p> <p>Select Auto to have the wireless devices transmit data after a RTS/CTS handshake. This helps improve IEEE 802.11g performance.</p> <p>Select Off to disable 802.11 protection. The transmission rate of your VMG might be reduced in a mixed-mode network.</p> <p>This field displays Off and is not configurable when you set 802.11 Mode to 802.11b Only.</p>
RIFS Advertisement	<p>Select Auto to enable the Reduced Inter-frame Spacing (RIFS) feature. It improves the Device's performance by reducing the amount of dead time required between OFDM transmissions. Select Off to disable the feature.</p>
Preamble	<p>Select a preamble type from the drop-down list box. Choices are Long or Short. See Section 7.10.7 on page 108 for more information.</p> <p>This field is configurable only when you set 802.11 Mode to 802.11b.</p>
RX Chain Power Save	<p>Select Enable to activate the RX Chain Power Save feature. It turns off one of the Receive chains to save power when it is not in use. Select Disable to disable this feature.</p>
OBSS Coexistence	<p>Select Enable to allow the coexistence of 20 MHz and 40 MHz Overlapping Basic Service Sets (OBSS) in wireless local area networks. Select Disable to disable this feature.</p>
XPress™ Technology	<p>Select Enable for higher speeds, especially if you have both IEEE 802.11b and IEEE 802.11g wireless clients. The wireless clients do not have to support XPress™ Technology, although the performance enhancement is greater if they do. Select Disable to disable this feature.</p>
WPS 2.0	<p>Select Enable to support WPS 2.0 which enhances WPS security and flexibility on configuration. Select Disable to disable this feature.</p>
Apply	<p>Click Apply to save your changes.</p>
Cancel	<p>Click Cancel to restore your previously saved settings.</p>

7.9 The Channel Status Screen

Use the **Channel Status** screen to scan wireless LAN channel noises and view the results. Click **Network Setting > Wireless > Channel Status**. The screen appears as shown. Click **Scan** to scan the wireless LAN channels. You can view the results in the **Channel Scan Result** section.

Note: The **Scan** button only works when the VMG uses 20MHz for the wireless channel width. You can go to the **Network Setting > Wireless > General** screen, click the **more** link, and then change the channel width setting in the **Bandwidth** field.

Figure 41 Network Setting > Wireless > Channel Status

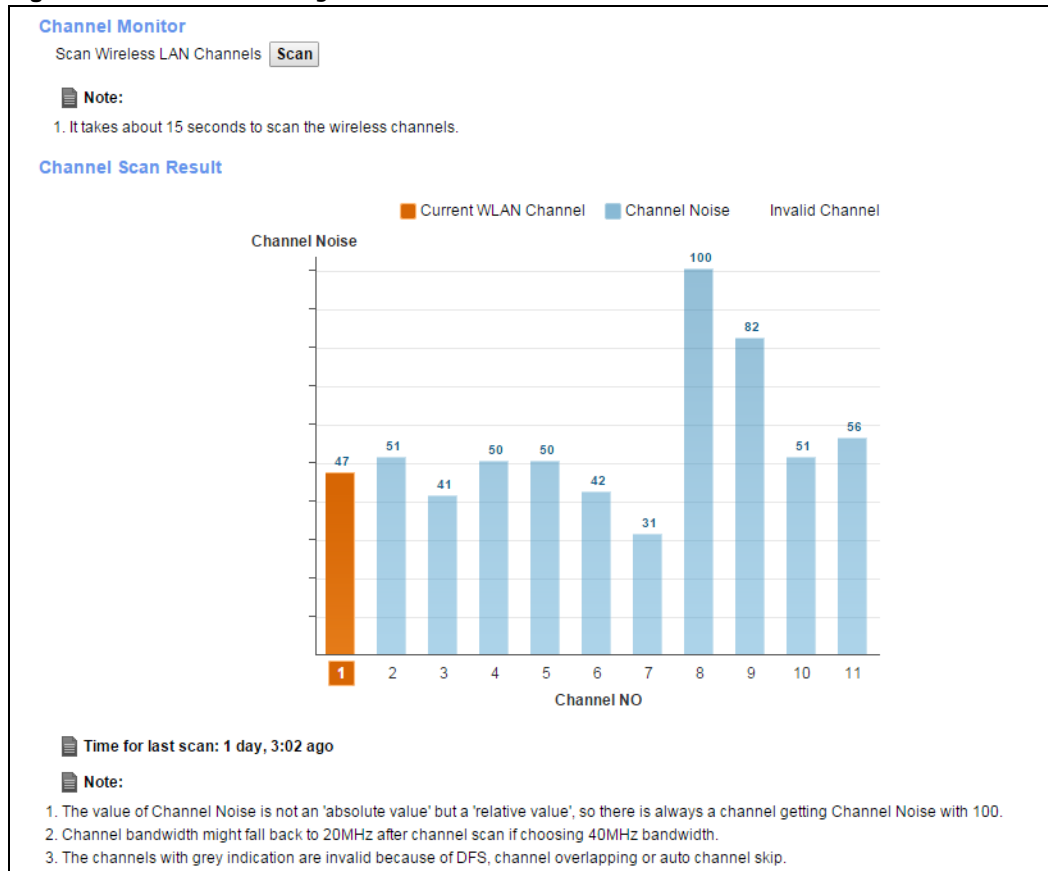

7.10 Technical Reference

This section discusses wireless LANs in depth. For more information, see [Appendix B on page 272](#).

7.10.1 Wireless Network Overview

Wireless networks consist of wireless clients, access points and bridges.

- A wireless client is a radio connected to a user's computer.
- An access point is a radio with a wired connection to a network, which can connect with numerous wireless clients and let them access the network.
- A bridge is a radio that relays communications between access points and wireless clients, extending a network's range.

Traditionally, a wireless network operates in one of two ways.

- An “infrastructure” type of network has one or more access points and one or more wireless clients. The wireless clients connect to the access points.
- An “ad-hoc” type of network is one in which there is no access point. Wireless clients connect to one another in order to exchange information.

The following figure provides an example of a wireless network.

Figure 42 Example of a Wireless Network

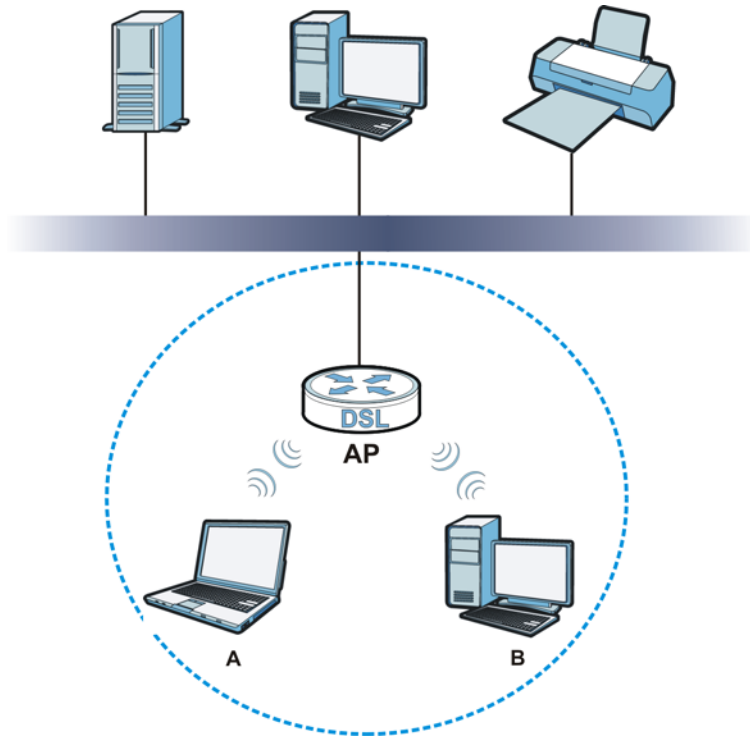

The wireless network is the part in the blue circle. In this wireless network, devices **A** and **B** use the access point (**AP**) to interact with the other devices (such as the printer) or with the Internet. Your VMG is the AP.

Every wireless network must follow these basic guidelines.

- Every device in the same wireless network must use the same SSID.
The SSID is the name of the wireless network. It stands for Service Set IDentifier.
- If two wireless networks overlap, they should use a different channel.
Like radio stations or television channels, each wireless network uses a specific channel, or frequency, to send and receive information.
- Every device in the same wireless network must use security compatible with the AP.
Security stops unauthorized devices from using the wireless network. It can also protect the information that is sent in the wireless network.

Radio Channels

In the radio spectrum, there are certain frequency bands allocated for unlicensed, civilian use. For the purposes of wireless networking, these bands are divided into numerous channels. This allows a

variety of networks to exist in the same place without interfering with one another. When you create a network, you must select a channel to use.

Since the available unlicensed spectrum varies from one country to another, the number of available channels also varies.

7.10.2 Additional Wireless Terms

The following table describes some wireless network terms and acronyms used in the VMG's Web Configurator.

Table 28 Additional Wireless Terms

TERM	DESCRIPTION
RTS/CTS Threshold	<p>In a wireless network which covers a large area, wireless devices are sometimes not aware of each other's presence. This may cause them to send information to the AP at the same time and result in information colliding and not getting through.</p> <p>By setting this value lower than the default value, the wireless devices must sometimes get permission to send information to the VMG. The lower the value, the more often the devices must get permission.</p> <p>If this value is greater than the fragmentation threshold value (see below), then wireless devices never have to get permission to send information to the VMG.</p>
Preamble	A preamble affects the timing in your wireless network. There are two preamble modes: long and short. If a device uses a different preamble mode than the VMG does, it cannot communicate with the VMG.
Authentication	The process of verifying whether a wireless device is allowed to use the wireless network.
Fragmentation Threshold	A small fragmentation threshold is recommended for busy networks, while a larger threshold provides faster performance if the network is not very busy.

7.10.3 Wireless Security Overview

By their nature, radio communications are simple to intercept. For wireless data networks, this means that anyone within range of a wireless network without security can not only read the data passing over the airwaves, but also join the network. Once an unauthorized person has access to the network, he or she can steal information or introduce malware (malicious software) intended to compromise the network. For these reasons, a variety of security systems have been developed to ensure that only authorized people can use a wireless data network, or understand the data carried on it.

These security standards do two things. First, they authenticate. This means that only people presenting the right credentials (often a username and password, or a "key" phrase) can access the network. Second, they encrypt. This means that the information sent over the air is encoded. Only people with the code key can understand the information, and only people who have been authenticated are given the code key.

These security standards vary in effectiveness. Some can be broken, such as the old Wired Equivalent Protocol (WEP). Using WEP is better than using no security at all, but it will not keep a determined attacker out. Other security standards are secure in themselves but can be broken if a user does not use them properly. For example, the WPA-PSK security standard is very secure if you use a long key which is difficult for an attacker's software to guess - for example, a twenty-letter long string of apparently random numbers and letters - but it is not very secure if you use a short key which is very easy to guess - for example, a three-letter word from the dictionary.

Because of the damage that can be done by a malicious attacker, it's not just people who have sensitive information on their network who should use security. Everybody who uses any wireless network should ensure that effective security is in place.

A good way to come up with effective security keys, passwords and so on is to use obscure information that you personally will easily remember, and to enter it in a way that appears random and does not include real words. For example, if your mother owns a 1970 Dodge Challenger and her favorite movie is Vanishing Point (which you know was made in 1971) you could use "70dodchal71vanpoi" as your security key.

The following sections introduce different types of wireless security you can set up in the wireless network.

7.10.3.1 SSID

Normally, the VMG acts like a beacon and regularly broadcasts the SSID in the area. You can hide the SSID instead, in which case the VMG does not broadcast the SSID. In addition, you should change the default SSID to something that is difficult to guess.

This type of security is fairly weak, however, because there are ways for unauthorized wireless devices to get the SSID. In addition, unauthorized wireless devices can still see the information that is sent in the wireless network.

7.10.3.2 MAC Address Filter

Every device that can use a wireless network has a unique identification number, called a MAC address.¹ A MAC address is usually written using twelve hexadecimal characters²; for example, 00A0C5000002 or 00:A0:C5:00:00:02. To get the MAC address for each device in the wireless network, see the device's User's Guide or other documentation.

You can use the MAC address filter to tell the VMG which devices are allowed or not allowed to use the wireless network. If a device is allowed to use the wireless network, it still has to have the correct information (SSID, channel, and security). If a device is not allowed to use the wireless network, it does not matter if it has the correct information.

This type of security does not protect the information that is sent in the wireless network. Furthermore, there are ways for unauthorized wireless devices to get the MAC address of an authorized device. Then, they can use that MAC address to use the wireless network.

7.10.3.3 User Authentication

Authentication is the process of verifying whether a wireless device is allowed to use the wireless network. You can make every user log in to the wireless network before using it. However, every device in the wireless network has to support IEEE 802.1x to do this.

For wireless networks, you can store the user names and passwords for each user in a RADIUS server. This is a server used in businesses more than in homes. If you do not have a RADIUS server, you cannot set up user names and passwords for your users.

Unauthorized wireless devices can still see the information that is sent in the wireless network, even if they cannot use the wireless network. Furthermore, there are ways for unauthorized

-
1. Some wireless devices, such as scanners, can detect wireless networks but cannot use wireless networks. These kinds of wireless devices might not have MAC addresses.
 2. Hexadecimal characters are 0, 1, 2, 3, 4, 5, 6, 7, 8, 9, A, B, C, D, E, and F.

wireless users to get a valid user name and password. Then, they can use that user name and password to use the wireless network.

7.10.3.4 Encryption

Wireless networks can use encryption to protect the information that is sent in the wireless network. Encryption is like a secret code. If you do not know the secret code, you cannot understand the message.

The types of encryption you can choose depend on the type of authentication. (See [Section 7.10.3.3 on page 105](#) for information about this.)

Table 29 Types of Encryption for Each Type of Authentication

	NO AUTHENTICATION	RADIUS SERVER
Weakest 	No Security	WPA
	Static WEP	
	WPA-PSK	
Strongest	WPA2-PSK	WPA2

For example, if the wireless network has a RADIUS server, you can choose **WPA** or **WPA2**. If users do not log in to the wireless network, you can choose no encryption, **Static WEP**, **WPA-PSK**, or **WPA2-PSK**.

Usually, you should set up the strongest encryption that every device in the wireless network supports. For example, suppose you have a wireless network with the VMG and you do not have a RADIUS server. Therefore, there is no authentication. Suppose the wireless network has two devices. Device A only supports WEP, and device B supports WEP and WPA. Therefore, you should set up **Static WEP** in the wireless network.

Note: It is recommended that wireless networks use **WPA-PSK**, **WPA**, or stronger encryption. The other types of encryption are better than none at all, but it is still possible for unauthorized wireless devices to figure out the original information pretty quickly.

When you select **WPA2** or **WPA2-PSK** in your VMG, you can also select an option (**WPA compatible**) to support WPA as well. In this case, if some of the devices support WPA and some support WPA2, you should set up **WPA2-PSK** or **WPA2** (depending on the type of wireless network login) and select the **WPA compatible** option in the VMG.

Many types of encryption use a key to protect the information in the wireless network. The longer the key, the stronger the encryption. Every device in the wireless network must have the same key.

7.10.4 Signal Problems

Because wireless networks are radio networks, their signals are subject to limitations of distance, interference and absorption.

Problems with distance occur when the two radios are too far apart. Problems with interference occur when other radio waves interrupt the data signal. Interference may come from other radio transmissions, such as military or air traffic control communications, or from machines that are

coincidental emitters such as electric motors or microwaves. Problems with absorption occur when physical objects (such as thick walls) are between the two radios, muffling the signal.

7.10.5 BSS

A Basic Service Set (BSS) exists when all communications between wireless stations or between a wireless station and a wired network client go through one access point (AP).

Intra-BSS traffic is traffic between wireless stations in the BSS. When Intra-BSS traffic blocking is disabled, wireless station A and B can access the wired network and communicate with each other. When Intra-BSS traffic blocking is enabled, wireless station A and B can still access the wired network but cannot communicate with each other.

Figure 43 Basic Service set

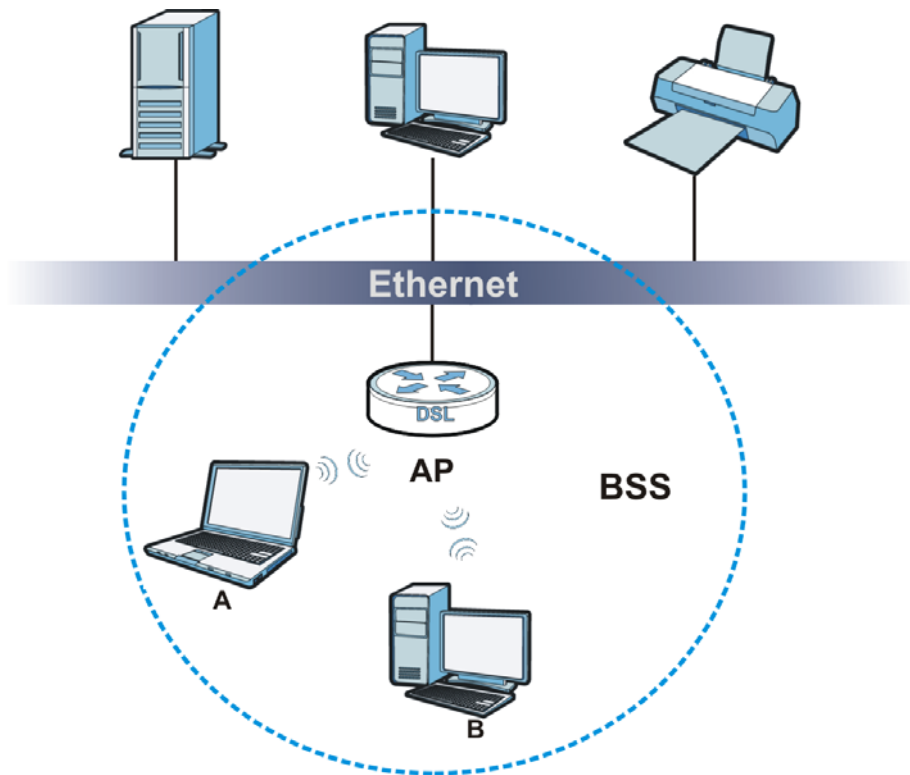

7.10.6 MBSSID

Traditionally, you need to use different APs to configure different Basic Service Sets (BSSs). As well as the cost of buying extra APs, there is also the possibility of channel interference. The VMG's MBSSID (Multiple Basic Service Set IDentifier) function allows you to use one access point to provide several BSSs simultaneously. You can then assign varying QoS priorities and/or security modes to different SSIDs.

Wireless devices can use different BSSIDs to associate with the same AP.

7.10.6.1 Notes on Multiple BSSs

- A maximum of eight BSSs are allowed on one AP simultaneously.

- You must use different keys for different BSSs. If two wireless devices have different BSSIDs (they are in different BSSs), but have the same keys, they may hear each other's communications (but not communicate with each other).
- MBSSID should not replace but rather be used in conjunction with 802.1x security.

7.10.7 Preamble Type

Preamble is used to signal that data is coming to the receiver. Short and long refer to the length of the synchronization field in a packet.

Short preamble increases performance as less time sending preamble means more time for sending data. All IEEE 802.11 compliant wireless adapters support long preamble, but not all support short preamble.

Use long preamble if you are unsure what preamble mode other wireless devices on the network support, and to provide more reliable communications in busy wireless networks.

Use short preamble if you are sure all wireless devices on the network support it, and to provide more efficient communications.

Use the dynamic setting to automatically use short preamble when all wireless devices on the network support it, otherwise the VMG uses long preamble.

Note: The wireless devices MUST use the same preamble mode in order to communicate.

7.10.8 Wireless Distribution System (WDS)

The VMG can act as a wireless network bridge and establish WDS (Wireless Distribution System) links with other APs. You need to know the MAC addresses of the APs you want to link to. Once the security settings of peer sides match one another, the connection between devices is made.

At the time of writing, WDS security is compatible with other ZyXEL access points only. Refer to your other access point's documentation for details.

The following figure illustrates how WDS link works between APs. Notebook computer **A** is a wireless client connecting to access point **AP 1**. **AP 1** has no wired Internet connection, but it can establish a WDS link with access point **AP 2**, which has a wired Internet connection. When **AP 1** has a WDS link with **AP 2**, the notebook computer can access the Internet through **AP 2**.

Figure 44 WDS Link Example



7.10.9 WiFi Protected Setup (WPS)

Your VMG supports WiFi Protected Setup (WPS), which is an easy way to set up a secure wireless network. WPS is an industry standard specification, defined by the WiFi Alliance.

WPS allows you to quickly set up a wireless network with strong security, without having to configure security settings manually. Each WPS connection works between two devices. Both devices must support WPS (check each device's documentation to make sure).

Depending on the devices you have, you can either press a button (on the device itself, or in its configuration utility) or enter a PIN (a unique Personal Identification Number that allows one device to authenticate the other) in each of the two devices. When WPS is activated on a device, it has two minutes to find another device that also has WPS activated. Then, the two devices connect and set up a secure network by themselves.

7.10.9.1 Push Button Configuration

WPS Push Button Configuration (PBC) is initiated by pressing a button on each WPS-enabled device, and allowing them to connect automatically. You do not need to enter any information.

Not every WPS-enabled device has a physical WPS button. Some may have a WPS PBC button in their configuration utilities instead of or in addition to the physical button.

Take the following steps to set up WPS using the button.

- 1 Ensure that the two devices you want to set up are within wireless range of one another.
- 2 Look for a WPS button on each device. If the device does not have one, log into its configuration utility and locate the button (see the device's User's Guide for how to do this - for the VMG, see [Section 7.6 on page 96](#)).
- 3 Press the button on one of the devices (it doesn't matter which). For the VMG you must press the WPS button for more than three seconds.
- 4 Within two minutes, press the button on the other device. The registrar sends the network name (SSID) and security key through an secure connection to the enrollee.

If you need to make sure that WPS worked, check the list of associated wireless clients in the AP's configuration utility. If you see the wireless client in the list, WPS was successful.

7.10.9.2 PIN Configuration

Each WPS-enabled device has its own PIN (Personal Identification Number). This may either be static (it cannot be changed) or dynamic (in some devices you can generate a new PIN by clicking on a button in the configuration interface).

Use the PIN method instead of the push-button configuration (PBC) method if you want to ensure that the connection is established between the devices you specify, not just the first two devices to activate WPS in range of each other. However, you need to log into the configuration interfaces of both devices to use the PIN method.

When you use the PIN method, you must enter the PIN from one device (usually the wireless client) into the second device (usually the Access Point or wireless router). Then, when WPS is activated on the first device, it presents its PIN to the second device. If the PIN matches, one device sends the network and security information to the other, allowing it to join the network.

Take the following steps to set up a WPS connection between an access point or wireless router (referred to here as the AP) and a client device using the PIN method.

- 1 Ensure WPS is enabled on both devices.
- 2 Access the WPS section of the AP's configuration interface. See the device's User's Guide for how to do this.
- 3 Look for the client's WPS PIN; it will be displayed either on the device, or in the WPS section of the client's configuration interface (see the device's User's Guide for how to find the WPS PIN - for the VMG, see [Section 7.5 on page 94](#)).
- 4 Enter the client's PIN in the AP's configuration interface.
- 5 If the client device's configuration interface has an area for entering another device's PIN, you can either enter the client's PIN in the AP, or enter the AP's PIN in the client - it does not matter which.
- 6 Start WPS on both devices within two minutes.
- 7 Use the configuration utility to activate WPS, not the push-button on the device itself.
- 8 On a computer connected to the wireless client, try to connect to the Internet. If you can connect, WPS was successful.

If you cannot connect, check the list of associated wireless clients in the AP's configuration utility. If you see the wireless client in the list, WPS was successful.

The following figure shows a WPS-enabled wireless client (installed in a notebook computer) connecting to the WPS-enabled AP via the PIN method.

Figure 45 Example WPS Process: PIN Method

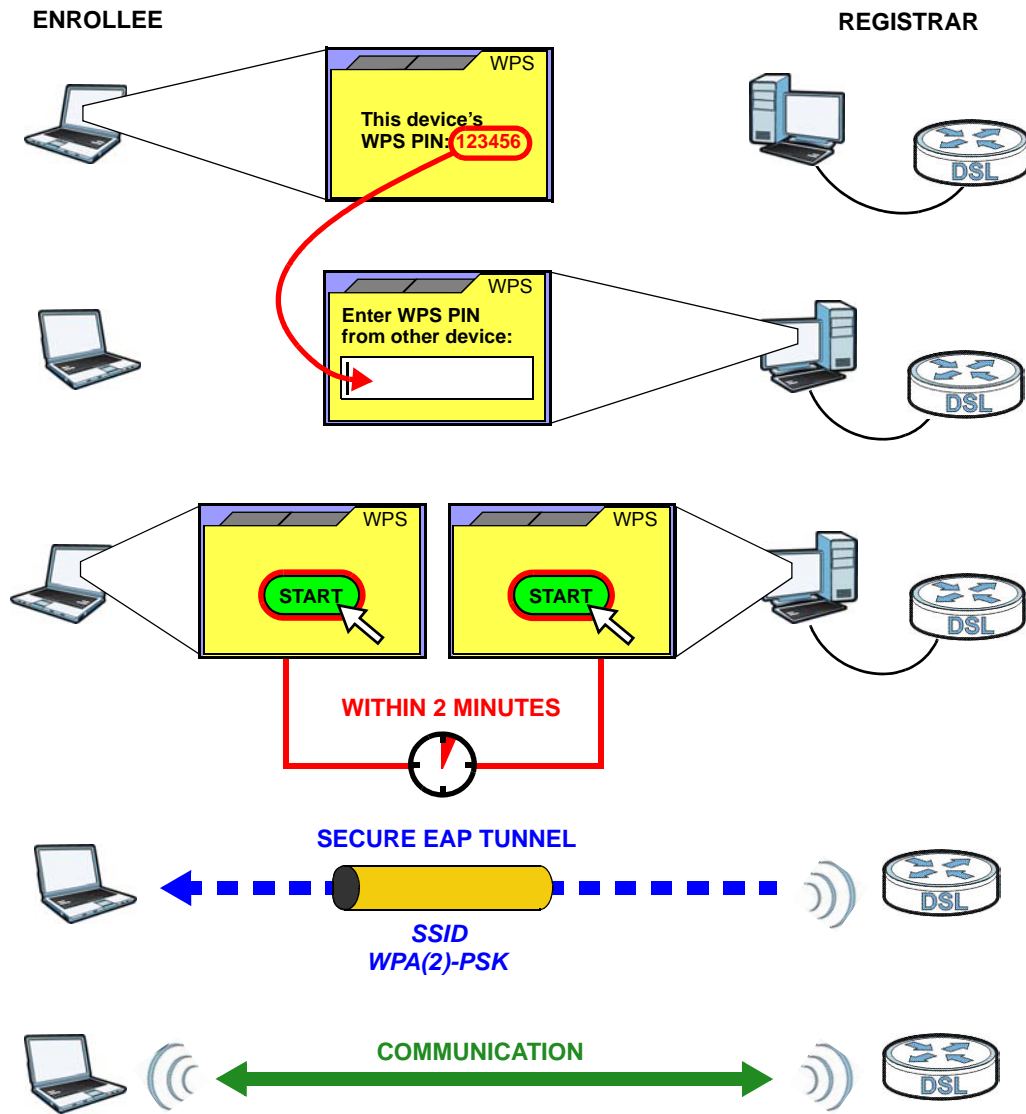

7.10.9.3 How WPS Works

When two WPS-enabled devices connect, each device must assume a specific role. One device acts as the registrar (the device that supplies network and security settings) and the other device acts as the enrollee (the device that receives network and security settings). The registrar creates a secure EAP (Extensible Authentication Protocol) tunnel and sends the network name (SSID) and the WPA-PSK or WPA2-PSK pre-shared key to the enrollee. Whether WPA-PSK or WPA2-PSK is used depends on the standards supported by the devices. If the registrar is already part of a network, it sends the existing information. If not, it generates the SSID and WPA(2)-PSK randomly.

The following figure shows a WPS-enabled client (installed in a notebook computer) connecting to a WPS-enabled access point.

Figure 46 How WPS works

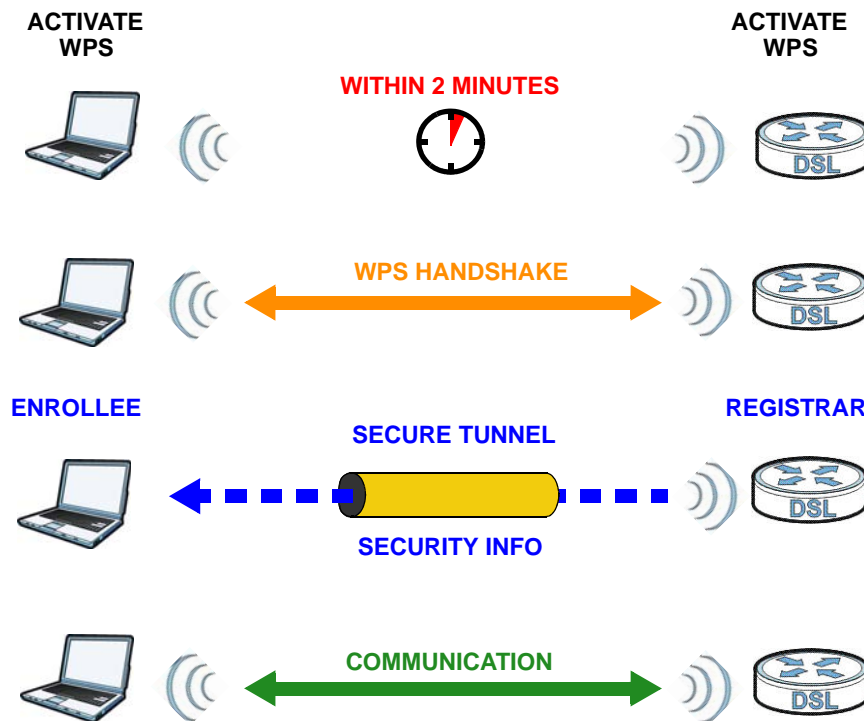

The roles of registrar and enrollee last only as long as the WPS setup process is active (two minutes). The next time you use WPS, a different device can be the registrar if necessary.

The WPS connection process is like a handshake; only two devices participate in each WPS transaction. If you want to add more devices you should repeat the process with one of the existing networked devices and the new device.

Note that the access point (AP) is not always the registrar, and the wireless client is not always the enrollee. All WPS-certified APs can be a registrar, and so can some WPS-enabled wireless clients.

By default, a WPS device is “unconfigured”. This means that it is not part of an existing network and can act as either enrollee or registrar (if it supports both functions). If the registrar is unconfigured, the security settings it transmits to the enrollee are randomly-generated. Once a WPS-enabled device has connected to another device using WPS, it becomes “configured”. A configured wireless client can still act as enrollee or registrar in subsequent WPS connections, but a configured access point can no longer act as enrollee. It will be the registrar in all subsequent WPS connections in which it is involved. If you want a configured AP to act as an enrollee, you must reset it to its factory defaults.

7.10.9.4 Example WPS Network Setup

This section shows how security settings are distributed in an example WPS setup.

The following figure shows an example network. In step 1, both **AP1** and **Client 1** are unconfigured. When WPS is activated on both, they perform the handshake. In this example, **AP1** is the registrar, and **Client 1** is the enrollee. The registrar randomly generates the security information to set up the network, since it is unconfigured and has no existing information.

Figure 47 WPS: Example Network Step 1

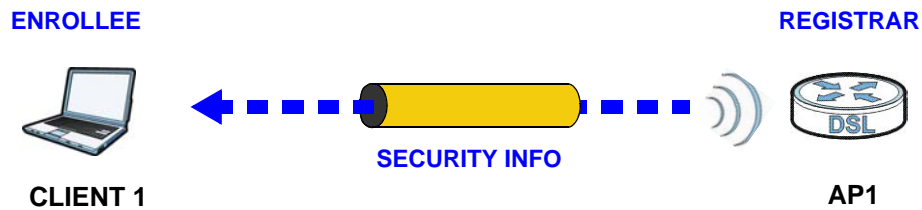

In step 2, you add another wireless client to the network. You know that **Client 1** supports registrar mode, but it is better to use **AP1** for the WPS handshake with the new client since you must connect to the access point anyway in order to use the network. In this case, **AP1** must be the registrar, since it is configured (it already has security information for the network). **AP1** supplies the existing security information to **Client 2**.

Figure 48 WPS: Example Network Step 2

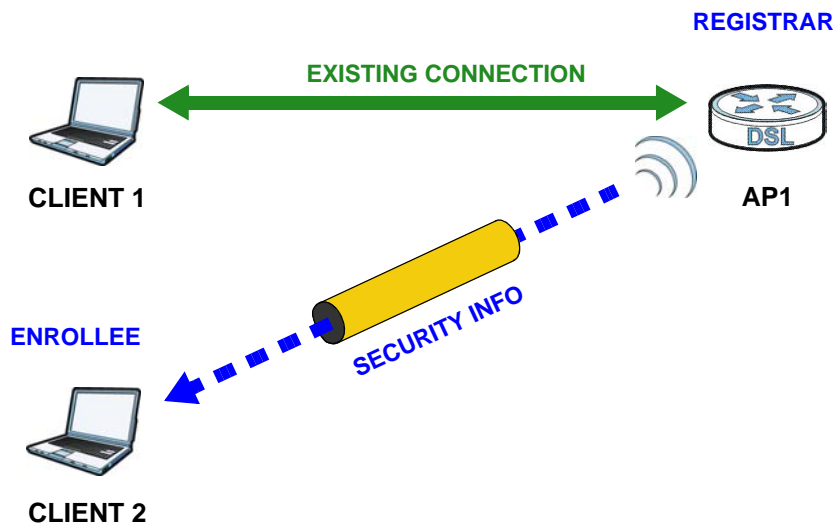

In step 3, you add another access point (**AP2**) to your network. **AP2** is out of range of **AP1**, so you cannot use **AP1** for the WPS handshake with the new access point. However, you know that **Client 2** supports the registrar function, so you use it to perform the WPS handshake instead.

Figure 49 WPS: Example Network Step 3

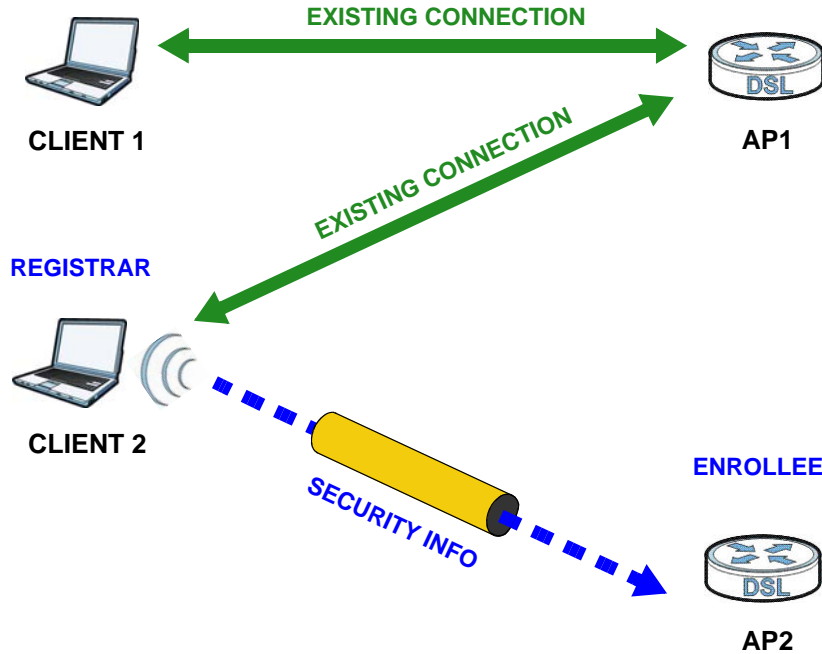

7.10.9.5 Limitations of WPS

WPS has some limitations of which you should be aware.

- WPS works in Infrastructure networks only (where an AP and a wireless client communicate). It does not work in Ad-Hoc networks (where there is no AP).
- When you use WPS, it works between two devices only. You cannot enroll multiple devices simultaneously, you must enroll one after the other.

For instance, if you have two enrollees and one registrar you must set up the first enrollee (by pressing the WPS button on the registrar and the first enrollee, for example), then check that it successfully enrolled, then set up the second device in the same way.

- WPS works only with other WPS-enabled devices. However, you can still add non-WPS devices to a network you already set up using WPS.

WPS works by automatically issuing a randomly-generated WPA-PSK or WPA2-PSK pre-shared key from the registrar device to the enrollee devices. Whether the network uses WPA-PSK or WPA2-PSK depends on the device. You can check the configuration interface of the registrar device to discover the key the network is using (if the device supports this feature). Then, you can enter the key into the non-WPS device and join the network as normal (the non-WPS device must also support WPA-PSK or WPA2-PSK).

- When you use the PBC method, there is a short period (from the moment you press the button on one device to the moment you press the button on the other device) when any WPS-enabled device could join the network. This is because the registrar has no way of identifying the “correct” enrollee, and cannot differentiate between your enrollee and a rogue device. This is a possible way for a hacker to gain access to a network.

You can easily check to see if this has happened. WPS works between only two devices simultaneously, so if another device has enrolled your device will be unable to enroll, and will not have access to the network. If this happens, open the access point’s configuration interface and look at the list of associated clients (usually displayed by MAC address). It does not matter if the

access point is the WPS registrar, the enrollee, or was not involved in the WPS handshake; a rogue device must still associate with the access point to gain access to the network. Check the MAC addresses of your wireless clients (usually printed on a label on the bottom of the device). If there is an unknown MAC address you can remove it or reset the AP.

Home Networking

8.1 Overview

A Local Area Network (LAN) is a shared communication system to which many networking devices are connected. It is usually located in one immediate area such as a building or floor of a building.

Use the LAN screens to help you configure a LAN DHCP server and manage IP addresses.

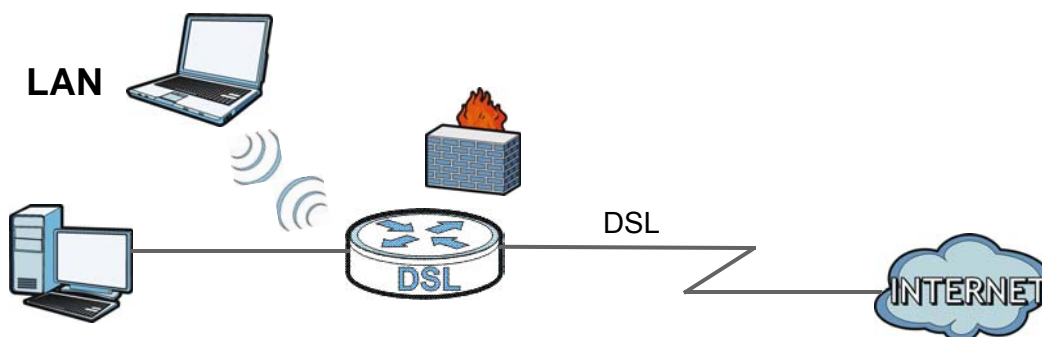

8.1.1 What You Can Do in this Chapter

- Use the **LAN Setup** screen to set the LAN IP address, subnet mask, and DHCP settings of your VMG ([Section 8.2 on page 118](#)).
- Use the **Static DHCP** screen to assign IP addresses on the LAN to specific individual computers based on their MAC Addresses ([Section 8.3 on page 122](#)).
- Use the **UPnP** screen to enable UPnP and UPnP NAT traversal on the VMG ([Section 8.4 on page 123](#)).
- Use the **Additional Subnet** screen to configure IP alias and public static IP ([Section 8.5 on page 126](#)).
- Use the **STB Vendor ID** screen to configure the Vendor IDs of the connected Set Top Box (STB) devices, which have the VMG automatically create static DHCP entries for the STB devices when they request IP addresses ([Section 8.6 on page 127](#)).
- Use the **Wake on Lan** screen to remotely turn on a device on the network. ([Section 8.7 on page 127](#)).
- Use the **TFTP Server Name** screen to identify a TFTP server for configuration file download using DHCP option 66. ([Section 8.8 on page 128](#)).

8.1.2 What You Need To Know

8.1.2.1 About LAN

IP Address

IP addresses identify individual devices on a network. Every networking device (including computers, servers, routers, printers, etc.) needs an IP address to communicate across the network. These networking devices are also known as hosts.

Subnet Mask

Subnet masks determine the maximum number of possible hosts on a network. You can also use subnet masks to divide one network into multiple sub-networks.

DHCP

A DHCP (Dynamic Host Configuration Protocol) server can assign your VMG an IP address, subnet mask, DNS and other routing information when it's turned on.

DNS

DNS (Domain Name System) is for mapping a domain name to its corresponding IP address and vice versa. The DNS server is extremely important because without it, you must know the IP address of a networking device before you can access it.

RADVD (Router Advertisement Daemon)

When an IPv6 host sends a Router Solicitation (RS) request to discover the available routers, RADVD with Router Advertisement (RA) messages in response to the request. It specifies the minimum and maximum intervals of RA broadcasts. RA messages containing the address prefix. IPv6 hosts can be generated with the IPv6 prefix an IPv6 address.

8.1.2.2 About UPnP

Identifying UPnP Devices

UPnP hardware is identified as an icon in the Network Connections folder (Windows XP). Each UPnP compatible device installed on your network will appear as a separate icon. Selecting the icon of a UPnP device will allow you to access the information and properties of that device.

NAT Traversal

UPnP NAT traversal automates the process of allowing an application to operate through NAT. UPnP network devices can automatically configure network addressing, announce their presence in the network to other UPnP devices and enable exchange of simple product and service descriptions. NAT traversal allows the following:

- Dynamic port mapping
- Learning public IP addresses

- Assigning lease times to mappings

Windows Messenger is an example of an application that supports NAT traversal and UPnP.

See the [Chapter 11 on page 157](#) for more information on NAT.

Cautions with UPnP

The automated nature of NAT traversal applications in establishing their own services and opening firewall ports may present network security issues. Network information and configuration may also be obtained and modified by users in some network environments.

When a UPnP device joins a network, it announces its presence with a multicast message. For security reasons, the VMG allows multicast messages on the LAN only.

All UPnP-enabled devices may communicate freely with each other without additional configuration. Disable UPnP if this is not your intention.

UPnP and ZyXEL

ZyXEL has achieved UPnP certification from the Universal Plug and Play Forum UPnP™ Implementers Corp. (UIC). ZyXEL's UPnP implementation supports Internet Gateway Device (IGD) 1.0.

See [Section 8.4.1 on page 124](#) for examples of installing and using UPnP.

Finding Out More

See [Section 8.9 on page 128](#) for technical background information on LANs.

8.1.3 Before You Begin

Find out the MAC addresses of your network devices if you intend to add them to the DHCP Client List screen.

8.2 The LAN Setup Screen

Use this screen to set the Local Area Network IP address and subnet mask of your VMG. Click **Network Setting > Home Networking** to open the **LAN Setup** screen.

Follow these steps to configure your LAN settings.

- 1 Enter an IP address into the **IP Address** field. The IP address must be in dotted decimal notation. This will become the IP address of your VMG.
- 2 Enter the IP subnet mask into the **IP Subnet Mask** field. Unless instructed otherwise it is best to leave this alone, the configurator will automatically compute a subnet mask based upon the IP address you entered.

- 3 Click **Apply** to save your settings.

Figure 50 Network Setting > Home Networking > LAN Setup

The screenshot shows the LAN Setup configuration page with the following sections and settings:

- Interface Group:** Group Name: Default
- LAN IP Setup:** IP Address: 192.168.1.1, Subnet Mask: 255.255.255.0
- IGMP Snooping:** Active: Enable
- DHCP Server State:** DHCP: Enable
- IP Addressing Values:** Beginning IP Address: 192.168.1.2, Ending IP Address: 192.168.1.254, Auto reserve IP for the same host: Disable
- DHCP Server Lease Time:** 1 Days, 0 Hours, 0 Minutes
- DNS Values:** DNS: DNS Proxy
- LAN IPv6 Mode Setup:** IPv6 Active: Enable
- Link Local Address Type:** EU64
- Lan Global Identifier Type:** EU64
- LAN IPv6 Address Setup:** Delegate prefix from WAN: Default
- MLD Snooping:** Active: Enable
- LAN IPv6 Address Assign Setup:** Stateless
- LAN IPv6 DNS Assign Setup:** From DHCPv6 Server
- DHCPv6 Configuration:** DHCPv6 Active: DHCPv6 Server
- IPv6 Router Advertisement State:** RADVD Active: Enable
- IPv6 DNS Values:** IPv6 DNS Server 1, 2, 3: From ISP
- DNS Query Scenario:** IPv4 DNS Server First

Buttons: Apply, Cancel

The following table describes the fields in this screen.

Table 30 Network Setting > Home Networking > LAN Setup

LABEL	DESCRIPTION
Interface Group	
Group Name	Select the interface group name for which you want to configure LAN settings. See Chapter 15 on page 183 for how to create a new interface group.

Table 30 Network Setting > Home Networking > LAN Setup (continued)

LABEL	DESCRIPTION
LAN IP Setup	
IP Address	Enter the LAN IPv4 IP address you want to assign to your VMG in dotted decimal notation, for example, 192.168.1.1 (factory default).
Subnet Mask/	Type the subnet mask of your network in dotted decimal notation, for example 255.255.255.0 (factory default). Your VMG automatically computes the subnet mask based on the IP Address you enter, so do not change this field unless you are instructed to do so.
IGMP Snooping	
Active	Select Enable to allows the VMG to passively learn multicast group.
DHCP Server State	
DHCP	Select Enable to have the VMG act as a DHCP server or DHCP relay agent. Select Disable to stop the DHCP server on the VMG. Select DHCP Relay to have the VMG forward DHCP request to the DHCP server.
DHCP Relay Server Address	This field is only available when you select DHCP Relay in the DHCP field.
IP Address	Enter the IPv4 IP address of the actual remote DHCP server in this field.
IP Addressing Values	This field is only available when you select Enable in the DHCP field.
Beginning IP Address	This field specifies the first of the contiguous addresses in the IP address pool.
Ending IP Address	This field specifies the last of the contiguous addresses in the IP address pool.
Auto reserve IP for the same host	Select Enable to have the VMG record DHCP IP addresses with the MAC addresses the IP addresses are assigned to. The VMG assigns the same IP address to the same MAC address when the host requests an IP address again through DHCP.
DHCP Server Lease Time	This is the period of time DHCP-assigned addresses is used. DHCP automatically assigns IP addresses to clients when they log in. DHCP centralizes IP address management on central computers that run the DHCP server program. DHCP leases addresses, for a period of time, which means that past addresses are "recycled" and made available for future reassignment to other systems. This field is only available when you select Enable in the DHCP field.
Days/Hours/Minutes	Enter the lease time of the DHCP server.
DNS Values	This field is only available when you select Enable in the DHCP field.
DNS	Select the type of service that you are registered for from your DNS service provider (From ISP). Select DNS Proxy if you have the DNS proxy service. The VMG redirects clients' DNS queries to a DNS server for resolving domain names. Select Static if you have the Static DNS service.
LAN IPv6 Mode Setup	
IPv6 Active	Select Enable to activate the IPv6 mode and configure IPv6 settings on the VMG.
Link Local Address Type	
EUI64	Select this to have the VMG generate an interface ID for the LAN interface's link-local address using the EUI-64 format.
Manual	Select this to manually enter an interface ID for the LAN interface's link-local address.
Lan Global Identifier Type	

Table 30 Network Setting > Home Networking > LAN Setup (continued)

LABEL	DESCRIPTION
EUI64	Select this to have the VMG generate an interface ID using the EUI-64 format for its global address .
Manual	Select this to manually enter an interface ID for the LAN interface's global IPv6 address.
LAN IPv6 Address Setup	
Delegate prefix from WAN	Select this option to automatically obtain an IPv6 network prefix from the service provider or an uplink router.
Static	Select this option to configure a fixed IPv6 address for the VMG's LAN IPv6 address.
MLD Snooping	Multicast Listener Discovery (MLD) allows an IPv6 switch or router to discover the presence of MLD hosts who wish to receive multicast packets and the IP addresses of multicast groups the hosts want to join on its network.
Active	Select Enable to activate MLD Snooping on the VMG. This allows the VMG to check MLD packets passing through it and learn the multicast group membership. It helps reduce multicast traffic.
LAN IPv6 Address Assign Setup	Select how you want to obtain an IPv6 address: <ul style="list-style-type: none"> • Stateless: The VMG uses IPv6 stateless autoconfiguration. RADVD (Router Advertisement Daemon) is enabled to have the VMG send IPv6 prefix information in router advertisements periodically and in response to router solicitations. DHCPv6 server is disabled. • Stateful: The VMG uses IPv6 stateful autoconfiguration. The DHCPv6 server is enabled to have the VMG act as a DHCPv6 server and pass IPv6 addresses to DHCPv6 clients. • Stateless and Stateful: The VMG uses both IPv6 stateless and stateful autoconfiguration. The LAN IPv6 clients can obtain IPv6 addresses either through router advertisements or through DHCPv6.
LAN IPv6 DNS Assign Setup	Select how the VMG provide DNS server and domain name information to the clients: <ul style="list-style-type: none"> • From Router Advertisement: The VMG provides DNS information through router advertisements. • From DHCPv6 Server: The VMG provides DNS information through DHCPv6. • From RA & DHCPv6 Server: The VMG provides DNS information through both router advertisements and DHCPv6.
DHCPv6 Configuration	
DHCPv6 Active	This shows the status of the DHCPv6. DHCPv6 Server displays if you configured the VMG to act as a DHCPv6 server which assigns IPv6 addresses and/or DNS information to clients.
IPv6 Router Advertisement State	
RADVD Active	This shows whether RADVD is enabled or not.
IPv6 DNS Values	
IPv6 DNS Server 1-3	Select From ISP if your ISP dynamically assigns IPv6 DNS server information. Select User-Defined if you have the IPv6 address of a DNS server. Enter the DNS server IPv6 addresses the VMG passes to the DHCP clients. Select None if you do not want to configure IPv6 DNS servers.
DNS Query Scenario	Select how the VMG handles clients' DNS information requests. <ul style="list-style-type: none"> • IPv4/IPv6 DNS Server: The VMG forwards the requests to both the IPv4 and IPv6 DNS servers and sends clients the first DNS information it receives. • IPv6 DNS Server Only: The VMG forwards the requests to the IPv6 DNS server and sends clients the DNS information it receives. • IPv4 DNS Server Only: The VMG forwards the requests to the IPv4 DNS server and sends clients the DNS information it receives. • IPv6 DNS Server First: The VMG forwards the requests to the IPv6 DNS server first and then the IPv4 DNS server. Then it sends clients the first DNS information it receives. • IPv4 DNS Server First: The VMG forwards the requests to the IPv4 DNS server first and then the IPv6 DNS server. Then it sends clients the first DNS information it receives.

Table 30 Network Setting > Home Networking > LAN Setup (continued)

LABEL	DESCRIPTION
Apply	Click Apply to save your changes.
Cancel	Click Cancel to restore your previously saved settings.

8.3 The Static DHCP Screen

This table allows you to assign IP addresses on the LAN to specific individual computers based on their MAC Addresses.

Every Ethernet device has a unique MAC (Media Access Control) address. The MAC address is assigned at the factory and consists of six pairs of hexadecimal characters, for example, 00:A0:C5:00:00:02.

Use this screen to change your VMG's static DHCP settings. Click **Network Setting > Home Networking > Static DHCP** to open the following screen.

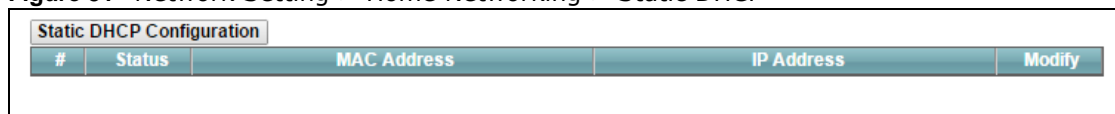
Figure 51 Network Setting > Home Networking > Static DHCP

Static DHCP Configuration				
#	Status	MAC Address	IP Address	Modify

The following table describes the labels in this screen.

Table 31 Network Setting > Home Networking > Static DHCP

LABEL	DESCRIPTION
Static DHCP Configuration	Click this to add a new static DHCP entry.
#	This is the index number of the entry.
Status	This field displays whether the client is connected to the VMG.
MAC Address	The MAC (Media Access Control) or Ethernet address on a LAN (Local Area Network) is unique to your computer (six pairs of hexadecimal notation). A network interface card such as an Ethernet adapter has a hardwired address that is assigned at the factory. This address follows an industry standard that ensures no other adapter has a similar address.
IP Address	This field displays the IP address relative to the # field listed above.
Modify	Click the Edit icon to have the IP address field editable and change it. Click the Delete icon to delete a static DHCP entry. A window displays asking you to confirm that you want to delete the selected entry.

If you click **Static DHCP Configuration** in the **Static DHCP** screen or the Edit icon next to a static DHCP entry, the following screen displays.

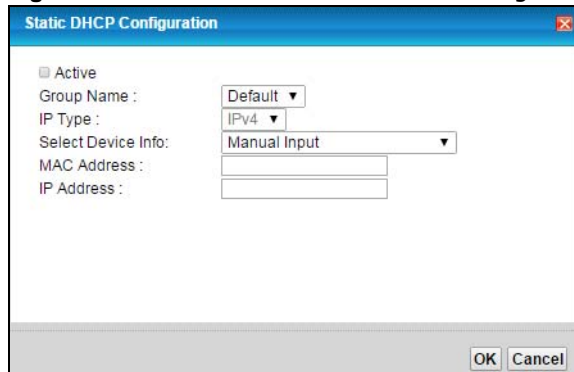
Figure 52 Static DHCP: Static DHCP Configuration/Edit

The following table describes the labels in this screen.

Table 32 Static DHCP: Static DHCP Configuration/Edit

LABEL	DESCRIPTION
Active	Select this to activate the connection between the client and the VMG.
Group Name	Select the interface group name for which you want to configure static DHCP settings. See Chapter 15 on page 183 for how to create a new interface group.
IP Type	This field displays IPv4 for the type of the DHCP IP address. At the time of writing, it is not allowed to select other type.
Select Device Info	Select a device or computer from the drop-down list or select Manual Input to manually enter a device's MAC address and IP address in the following fields.
MAC Address	If you select Manual Input , enter the MAC address of a computer on your LAN.
IP Address	If you select Manual Input , enter the IP address that you want to assign to the computer on your LAN with the MAC address that you will also specify.
OK	Click OK to save your changes.
Cancel	Click Cancel to exit this screen without saving.

8.4 The UPnP Screen

Universal Plug and Play (UPnP) is a distributed, open networking standard that uses TCP/IP for simple peer-to-peer network connectivity between devices. A UPnP device can dynamically join a network, obtain an IP address, convey its capabilities and learn about other devices on the network. In turn, a device can leave a network smoothly and automatically when it is no longer in use.

See [page 117](#) for more information on UPnP.

Use the following screen to configure the UPnP settings on your VMG. Click **Network Setting > Home Networking > UPnP** to display the screen shown next.

Figure 53 Network Setting > Home Networking > UPnP

The screenshot shows the UPnP configuration interface. At the top, under 'UPnP State', there are two radio buttons: 'Enable' (selected) and 'Disable'. Below that, under 'UPnP NAT-T State', there are also two radio buttons: 'Enable' (selected) and 'Disable'. A note icon is followed by the text 'Note : UPnP NAT-T only works when NAT is enable'. Below the note is a table with the following columns: '#', 'Description', 'Destination IP Address', 'External Port', 'Internal Port', and 'Protocol'. At the bottom right of the screen are two buttons: 'Apply' and 'Cancel'.

The following table describes the labels in this screen.

Table 33 Network Setting > Home Networking > UPnP

LABEL	DESCRIPTION
UPnP	Select Enable to activate UPnP. Be aware that anyone could use a UPnP application to open the web configurator's login screen without entering the VMG's IP address (although you must still enter the password to access the web configurator).
UPnP NAT-T	Select Enable to allow UPnP-enabled applications to automatically configure the VMG so that they can communicate through the VMG by using NAT traversal. UPnP applications automatically reserve a NAT forwarding port in order to communicate with another UPnP enabled device; this eliminates the need to manually configure port forwarding for the UPnP enabled application. The table below displays the NAT port forwarding rules added automatically by UPnP NAT-T.
#	This is the index number of the UPnP NAT-T connection.
Description	This is the description of the UPnP NAT-T connection.
Destination IP Address	This is the IP address of the other connected UPnP-enabled device.
External Port	This is the well-known port that the WAN server uses to reply to the LAN computer that made the request using the Internal Port .
Internal Port	This is a port that a LAN computer uses when it requests a particular service.
Protocol	This is the transport layer protocol used for the service.
Apply	Click Apply to save your changes.
Cancel	Click Cancel to exit this screen without saving.

8.4.1 Turning On UPnP in Windows 7 Example

This section shows you how to use the UPnP feature in Windows 7. UPnP server is installed in Windows 7. Activate UPnP on the VMG.

Make sure the computer is connected to a LAN port of the VMG. Turn on your computer and the VMG.

- 1 Click the start icon, **Control Panel** and then the **Network and Sharing Center**.

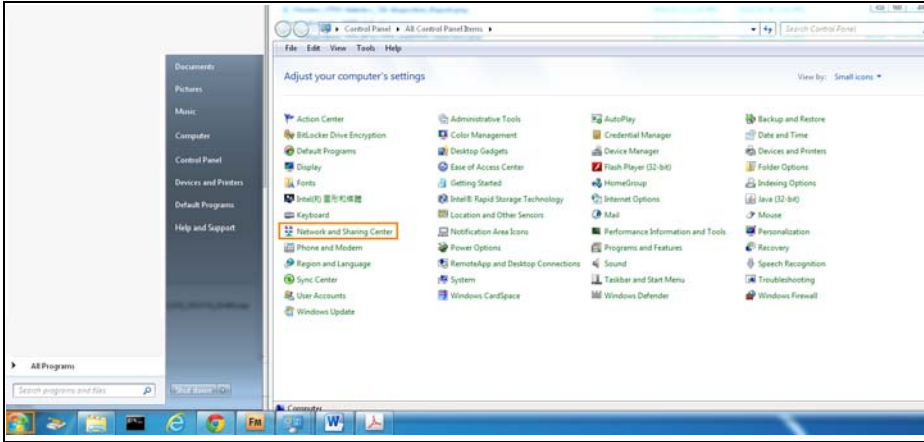

2 Click **Change Advanced Sharing Settings**.

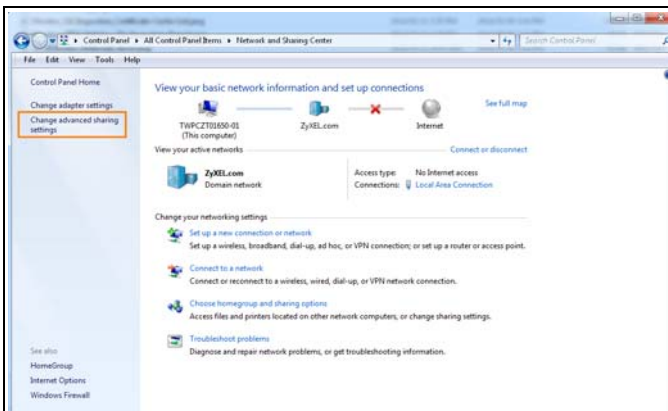

3 Select **Turn on network discovery** and click **Save Changes**. Network discovery allows your computer to find other computers and devices on the network and other computers on the network to find your computer. This makes it easier to share files and printers.

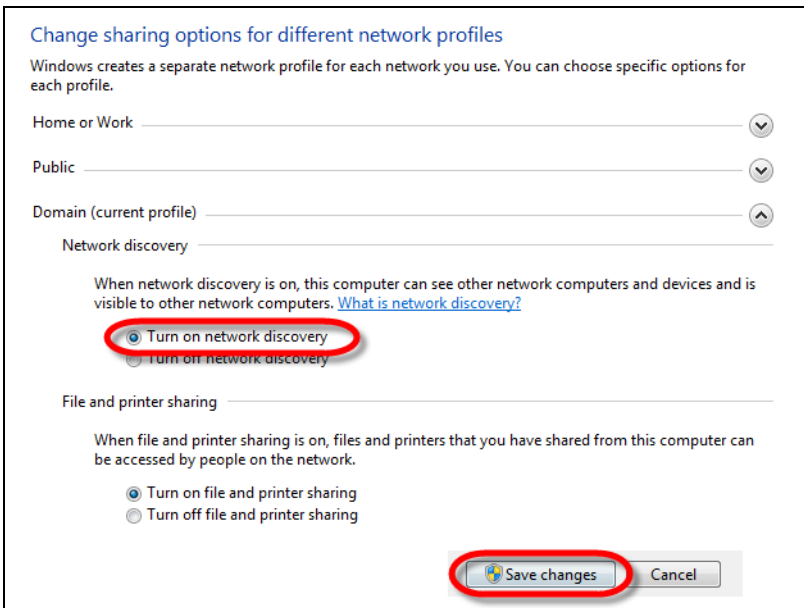

8.5 The Additional Subnet Screen

Use the **Additional Subnet** screen to configure IP alias and public static IP.

IP alias allows you to partition a physical network into different logical networks over the same Ethernet interface. The VMG supports multiple logical LAN interfaces via its physical Ethernet interface with the VMG itself as the gateway for the LAN network. When you use IP alias, you can also configure firewall rules to control access to the LAN's logical network (subnet).

If your ISP provides the Public LAN service, the VMG may use an LAN IP address that can be accessed from the WAN.

Click **Network Setting > Home Networking > Additional Subnet** to display the screen shown next.

Figure 54 Network Setting > Home Networking > Additional Subnet

The following table describes the labels in this screen.

Table 34 Network Setting > Home Networking > Additional Subnet

LABEL	DESCRIPTION
IP Alias Setup	
Group Name	Select the interface group name for which you want to configure the IP alias settings. See Chapter 15 on page 183 for how to create a new interface group.
Active	Select Enable to configure a LAN network for the VMG.
IPv4 Address	Enter the IP address of your VMG in dotted decimal notation.
Subnet Mask	Your VMG will automatically calculate the subnet mask based on the IPv4 address that you assign. Unless you are implementing subnetting, use this value computed by the VMG.
Public LAN	
Active	Select Enable to enable the Public LAN feature. Your ISP must support Public LAN and Static IP.
IPv4 Address	Enter the public IP address provided by your ISP.
Subnet Mask	Enter the public IPv4 subnet mask provided by your ISP.
Offer Public IP by DHCP	Select Enable to enable the VMG to provide public IP addresses by DHCP server.
Enable ARP Proxy	Select Enable to enable the ARP (Address Resolution Protocol) proxy.

Table 34 Network Setting > Home Networking > Additional Subnet (continued)

LABEL	DESCRIPTION
Apply	Click Apply to save your changes.
Cancel	Click Cancel to exit this screen without saving.

8.6 The STB Vendor ID Screen

Set Top Box (STB) devices with dynamic IP addresses sometimes don't renew their IP addresses before the lease time expires. This could lead to IP address conflicts if the STB continues to use an IP address that gets assigned to another device. Use this screen to configure the Vendor IDs of connected STBs, which have the VMG automatically created static DHCP entries for them when they request IP addresses.

Click **Network Setting > Home Networking > STB Vendor ID** to open this screen.

Figure 55 Network Setting > Home Networking > STB Vendor ID

Please enter Vendor ID for STB.

Vendor ID 1:

Vendor ID 2:

Vendor ID 3:

Vendor ID 4:

Vendor ID 5:

The following table describes the labels in this screen.

Table 35 Network Setting > Home Networking > STB Vendor ID

LABEL	DESCRIPTION
Vendor ID 1~5	These are STB's Vendor Class Identifiers (DHCP option 60). A Vendor Class Identifier is usually used to inform the DHCP server a DHCP client's vendor and functionality.
Apply	Click Apply to save your changes.
Cancel	Click Cancel to exit this screen without saving.

8.7 The Wake on LAN Screen

Use this screen to turn on a device on the LAN network. To use this feature, the remote device must also support Wake On LAN.

You need to know the MAC address of the LAN device. It may be on a label on the device or in its documentation.

Click **Network Setting > Home Networking > Wake on Lan** to open this screen.

Figure 56 Network Setting > Home Networking > Wake on Lan

Wake by Address: ▾

IP Address:

MAC Address: : : : : :

The following table describes the labels in this screen.

Table 36 Network Setting > Home Networking > Wake on Lan

LABEL	DESCRIPTION
Wake by Address	Select Manual and enter the IP address or MAC address of the device to turn it on remotely. The drop-down list also lists the IP addresses that can be found in the VMG's ARP table. Select an IP address and it will then automatically update the IP address and MAC address in the following fields.
IP Address	Enter the IPv4 IP address of the device to turn it on.
MAC Address	Enter the MAC address of the device to turn it on. A MAC address consists of six hexadecimal character pairs.
Wake up	Click this to send a wake up packet to wake up the specified device.

8.8 The TFTP Server Name Screen

Use the **TFTP Server Name** screen to identify a TFTP server for configuration file download using DHCP option 66. RFC 2132 defines the option 66 open standard. DHCP option 66 supports the IP address or the hostname of a single TFTP server.

Click **Network Setting > Home Networking > TFTP Server Name** to open this screen.

Figure 57 Network Setting > Home Networking > TFTP Server Name



The following table describes the labels in this screen.

Table 37 Network Setting > Home Networking > TFTP Server Name

LABEL	DESCRIPTION
TFTP Server Name	Enter the the IP address or the hostname of a single TFTP server.
Apply	Click Apply to save your changes.
Cancel	Click Cancel to exit this screen without saving.

8.9 Technical Reference

This section provides some technical background information about the topics covered in this chapter.

8.9.1 LANs, WANs and the VMG

The actual physical connection determines whether the VMG ports are LAN or WAN ports. There are two separate IP networks, one inside the LAN network and the other outside the WAN network as shown next.

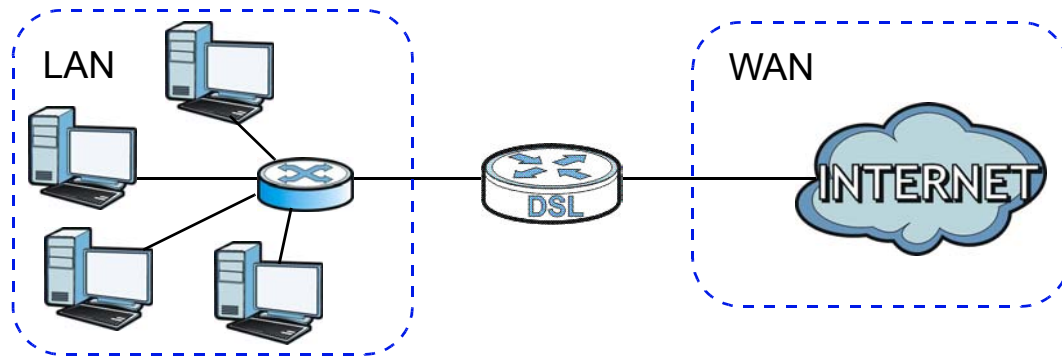
Figure 58 LAN and WAN IP Addresses

8.9.2 DHCP Setup

DHCP (Dynamic Host Configuration Protocol, RFC 2131 and RFC 2132) allows individual clients to obtain TCP/IP configuration at start-up from a server. You can configure the VMG as a DHCP server or disable it. When configured as a server, the VMG provides the TCP/IP configuration for the clients. If you turn DHCP service off, you must have another DHCP server on your LAN, or else the computer must be manually configured.

IP Pool Setup

The VMG is pre-configured with a pool of IP addresses for the DHCP clients (DHCP Pool). See the product specifications in the appendices. Do not assign static IP addresses from the DHCP pool to your LAN computers.

8.9.3 DNS Server Addresses

DNS (Domain Name System) maps a domain name to its corresponding IP address and vice versa. The DNS server is extremely important because without it, you must know the IP address of a computer before you can access it. The DNS server addresses you enter when you set up DHCP are passed to the client machines along with the assigned IP address and subnet mask.

There are two ways that an ISP disseminates the DNS server addresses.

- The ISP tells you the DNS server addresses, usually in the form of an information sheet, when you sign up. If your ISP gives you DNS server addresses, enter them in the **DNS Server** fields in the **DHCP Setup** screen.
- Some ISPs choose to disseminate the DNS server addresses using the DNS server extensions of IPCP (IP Control Protocol) after the connection is up. If your ISP did not give you explicit DNS servers, chances are the DNS servers are conveyed through IPCP negotiation. The VMG supports the IPCP DNS server extensions through the DNS proxy feature.

Please note that DNS proxy works only when the ISP uses the IPCP DNS server extensions. It does not mean you can leave the DNS servers out of the DHCP setup under all circumstances. If your ISP gives you explicit DNS servers, make sure that you enter their IP addresses in the **DHCP Setup** screen.

8.9.4 LAN TCP/IP

The VMG has built-in DHCP server capability that assigns IP addresses and DNS servers to systems that support DHCP client capability.

IP Address and Subnet Mask

Similar to the way houses on a street share a common street name, so too do computers on a LAN share one common network number.

Where you obtain your network number depends on your particular situation. If the ISP or your network administrator assigns you a block of registered IP addresses, follow their instructions in selecting the IP addresses and the subnet mask.

If the ISP did not explicitly give you an IP network number, then most likely you have a single user account and the ISP will assign you a dynamic IP address when the connection is established. If this is the case, it is recommended that you select a network number from 192.168.0.0 to 192.168.255.0 and you must enable the Network Address Translation (NAT) feature of the VMG. The Internet Assigned Number Authority (IANA) reserved this block of addresses specifically for private use; please do not use any other number unless you are told otherwise. Let's say you select 192.168.1.0 as the network number; which covers 254 individual addresses, from 192.168.1.1 to 192.168.1.254 (zero and 255 are reserved). In other words, the first three numbers specify the network number while the last number identifies an individual computer on that network.

Once you have decided on the network number, pick an IP address that is easy to remember, for instance, 192.168.1.1, for your VMG, but make sure that no other device on your network is using that IP address.

The subnet mask specifies the network number portion of an IP address. Your VMG will compute the subnet mask automatically based on the IP address that you entered. You don't need to change the subnet mask computed by the VMG unless you are instructed to do otherwise.

Private IP Addresses

Every machine on the Internet must have a unique address. If your networks are isolated from the Internet, for example, only between your two branch offices, you can assign any IP addresses to the hosts without problems. However, the Internet Assigned Numbers Authority (IANA) has reserved the following three blocks of IP addresses specifically for private networks:

- 10.0.0.0 — 10.255.255.255
- 172.16.0.0 — 172.31.255.255
- 192.168.0.0 — 192.168.255.255

You can obtain your IP address from the IANA, from an ISP or it can be assigned from a private network. If you belong to a small organization and your Internet access is through an ISP, the ISP can provide you with the Internet addresses for your local networks. On the other hand, if you are part of a much larger organization, you should consult your network administrator for the appropriate IP addresses.

Note: Regardless of your particular situation, do not create an arbitrary IP address; always follow the guidelines above. For more information on address assignment, please refer to RFC 1597, "Address Allocation for Private Internets" and RFC 1466, "Guidelines for Management of IP Address Space".

Routing

9.1 Overview

The VMG usually uses the default gateway to route outbound traffic from computers on the LAN to the Internet. To have the VMG send data to devices not reachable through the default gateway, use static routes.

For example, the next figure shows a computer (**A**) connected to the VMG's LAN interface. The VMG routes most traffic from **A** to the Internet through the VMG's default gateway (**R1**). You create one static route to connect to services offered by your ISP behind router **R2**. You create another static route to communicate with a separate network behind a router **R3** connected to the LAN.

Figure 59 Example of Routing Topology

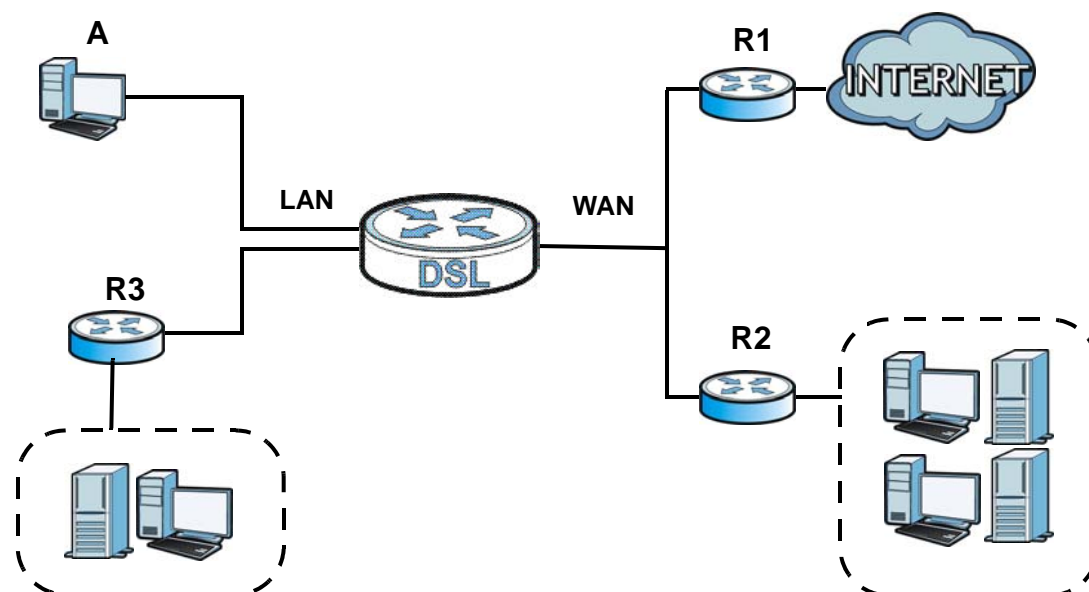

9.2 The Routing Screen

Use this screen to view and configure the static route rules on the VMG. Click **Network Setting > Routing > Static Route** to open the following screen.

Figure 60 Network Setting > Routing > Static Route

Add New Static Route							
#	Status	Name	Destination IP	Subnet Mask/Prefix Length	Gateway	Interface	Modify

The following table describes the labels in this screen.

Table 38 Network Setting > Routing > Static Route

LABEL	DESCRIPTION
Add New Static Route	Click this to configure a new static route.
#	This is the index number of the entry.
Status	This field displays whether the static route is active or not. A yellow bulb signifies that this route is active. A gray bulb signifies that this route is not active.
Name	This is the name that describes or identifies this route.
Destination IP	This parameter specifies the IP network address of the final destination. Routing is always based on network number.
Subnet Mask/ Prefix Length	This parameter specifies the IP network subnet mask or IPv6 prefix length of the final destination.
Gateway	This is the IP address of the gateway. The gateway is a router or switch on the same network segment as the device's LAN or WAN port. The gateway helps forward packets to their destinations.
Interface	This is the WAN interface used for this static route.
Modify	Click the Edit icon to edit the static route on the VMG. Click the Delete icon to remove a static route from the VMG. A window displays asking you to confirm that you want to delete the route.

9.2.1 Add/Edit Static Route

Use this screen to add or edit a static route. Click **Add new static route** in the **Routing** screen or the **Edit** icon next to the static route you want to edit. The screen shown next appears.

Figure 61 Routing: Add/Edit

The following table describes the labels in this screen.

Table 39 Routing: Add/Edit

LABEL	DESCRIPTION
Active	This field allows you to activate/deactivate this static route. Select Enable to activate the static route. Select Disable to deactivate this static route without having to delete the entry.
Route Name	Enter a descriptive name for the static route.
IP Type	Select whether your IP type is IPv4 or IPv6 .
Destination IP Address	Enter the IPv4 or IPv6 network address of the final destination.
IP Subnet Mask / Prefix Length	If you are using IPv4 and need to specify a route to a single host, use a subnet mask of 255.255.255.255 in the subnet mask field to force the network number to be identical to the host ID. Enter the IP subnet mask here. If you select IPv6 , enter the IPv6 prefix length. An IPv6 prefix length specifies how many most significant bits (starting from the left) in the address compose the network address.
Use Gateway IP Address	The gateway is a router or switch on the same network segment as the device's LAN or WAN port. The gateway helps forward packets to their destinations. If you want to use the gateway IP address, select Enable .
Gateway IP Address	Enter the IP address of the gateway.
Use Interface	Select the WAN interface you want to use for this static route.
OK	Click OK to save your changes.
Cancel	Click Cancel to exit this screen without saving.

9.3 The DNS Route Screen

Use this screen to view and configure DNS routes on the VMG. Click **Network Setting > Routing > DNS Route** to open the following screen.

Figure 62 Network Setting > Routing > DNS Route

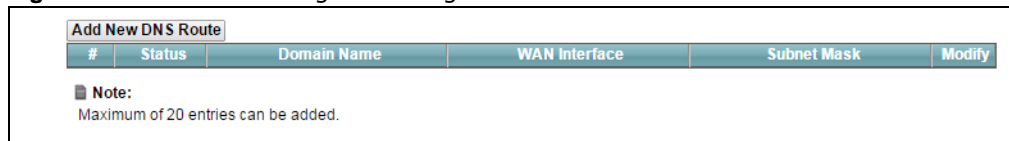

The following table describes the labels in this screen.

Table 40 Network Setting > Routing > DNS Route

LABEL	DESCRIPTION
Add New DNS Route	Click this to add a new DNS route.
#	This is the index number of a DNS route.
Status	This field displays whether the DNS route is active or not. A yellow bulb signifies that this DNS route is active. A gray bulb signifies that this DNS route is not active.
Domain Name	This is the host name or domain name of the DNS route entry.

Table 40 Network Setting > Routing > DNS Route (continued)

LABEL	DESCRIPTION
WAN Interface	This is the WAN connection through which the VMG forwards DNS requests for this domain name.
Subnet Mask	This is the subnet mask of the DNS route entry.
Modify	Click the Edit icon to modify the DNS route. Click the Delete icon to delete the DNS route.

9.3.1 The DNS Route Add Screen

You can manually add the VMG's DNS route entry. Click **Add New DNS Route** in the **Network Setting > Routing > DNS Route** screen. The screen shown next appears.

Figure 63 DNS Route Add

The following table describes the labels in this screen.

Table 41 DNS Route Add

LABEL	DESCRIPTION
Active	Select Enable to activate this DNS route.
Domain Name	Enter the domain name of the DNS route entry.
Subnet Mask	Enter the subnet mask of the DNS route entry.
WAN Interface	Select the WAN connection through which the VMG forwards DNS requests for this domain name. WWAN means the wireless 3G interface.
OK	Click this to save your changes.
Cancel	Click this to exit this screen without saving any changes.

9.4 The Policy Route Screen

Traditionally, routing is based on the destination address only and the VMG takes the shortest path to forward a packet. Policy route allows the VMG to override the default routing behavior and alter the packet forwarding based on the policy defined by the network administrator. Policy-based routing is applied to outgoing packets, prior to the normal routing.

You can use source-based policy forwarding to direct traffic from different users through different connections or distribute traffic among multiple paths for load sharing.

The **Policy Route** screen let you view and configure routing policies on the VMG. Click **Network Setting > Routing > Policy Route** to open the following screen.

Figure 64 Network Setting > Routing > Policy Route

#	Status	Name	Source IP	Source Subnet Mask	Protocol	Source Port	Source MAC	Source Interface	WAN Interface	Modify
---	--------	------	-----------	--------------------	----------	-------------	------------	------------------	---------------	--------

The following table describes the labels in this screen.

Table 42 Network Setting > Routing > Policy Route

LABEL	DESCRIPTION
Add New Policy Route	Click this to create a new policy forwarding rule.
#	This is the index number of the entry.
Status	This field displays whether the DNS route is active or not. A yellow bulb signifies that this DNS route is active. A gray bulb signifies that this DNS route is not active.
Name	This is the name of the rule.
Source IP	This is the source IP address.
Source Subnet Mask	his is the source subnet mask address.
Protocol	This is the transport layer protocol.
Source Port	This is the source port number.
Source MAC	This is the source MAC address.
Source Interface	This is the interface from which the matched traffic is sent.
WAN Interface	This is the WAN interface through which the traffic is routed.
Modify	Click the Edit icon to edit this policy. Click the Delete icon to remove a policy from the VMG. A window displays asking you to confirm that you want to delete the policy.

9.4.1 Add/Edit Policy Route

Click **Add New Policy Route** in the **Policy Route** screen or click the **Edit** icon next to a policy. Use this screen to configure the required information for a policy route.

Figure 65 Network Setting > Routing > Policy Route: Add/Edit

The following table describes the labels in this screen.

Table 43 Network Setting > Routing > Policy Route: Add/Edit

LABEL	DESCRIPTION
Active	Select Enable to activate this policy route.
Route Name	Enter a descriptive name of up to 8 printable English keyboard characters, not including spaces.
Source IP Address	Enter the source IP address.
Source Subnet Mask	Enter the source subnet mask address.
Protocol	Select the transport layer protocol (TCP or UDP).
Source Port	Enter the source port number.
Source MAC	Enter the source MAC address.
Source Interface	Type the name of the interface from which the matched traffic is sent.
WAN Interface	Select a WAN interface through which the traffic is sent. You must have the WAN interface(s) already configured in the Broadband screens.
OK	Click OK to save your changes.
Cancel	Click Cancel to exit this screen without saving.

9.5 RIP

Routing Information Protocol (RIP, RFC 1058 and RFC 1389) allows a device to exchange routing information with other routers.

9.5.1 The RIP Screen

Click **Network Setting > Routing > RIP** to open the **RIP** screen.

Figure 66 Network Setting > Routing > RIP

#	Interface	Version	Operation	Enable	Disable DefaultGateway
<input type="button" value="Apply"/> <input type="button" value="Cancel"/>					
 RIP CANNOT BE CONFIGURED on the WAN interface which has NAT enabled (such as PPPoE).					

The following table describes the labels in this screen.

Table 44 Network Setting > Routing > RIP

LABEL	DESCRIPTION
#	This is the index of the interface in which the RIP setting is used.
Interface	This is the name of the interface in which the RIP setting is used.
Version	The RIP version controls the format and the broadcasting method of the RIP packets that the VMG sends (it recognizes both formats when receiving). RIP version 1 is universally supported but RIP version 2 carries more information. RIP version 1 is probably adequate for most networks, unless you have an unusual network topology.
Operation	Select Passive to have the VMG update the routing table based on the RIP packets received from neighbors but not advertise its route information to other routers in this interface. Select Active to have the VMG advertise its route information and also listen for routing updates from neighboring routers.
Enable	Select the check box to activate the settings.
Disable DefaultGateway	
Apply	Click Apply to save your changes back to the VMG.
Cancel	Click Cancel to restore your previously saved settings.

Quality of Service (QoS)

10.1 Overview

Quality of Service (QoS) refers to both a network's ability to deliver data with minimum delay, and the networking methods used to control the use of bandwidth. Without QoS, all traffic data is equally likely to be dropped when the network is congested. This can cause a reduction in network performance and make the network inadequate for time-critical application such as video-on-demand.

Configure QoS on the VMG to group and prioritize application traffic and fine-tune network performance. Setting up QoS involves these steps:

- 1 Configure classifiers to sort traffic into different flows.
- 2 Assign priority and define actions to be performed for a classified traffic flow.

The VMG assigns each packet a priority and then queues the packet accordingly. Packets assigned a high priority are processed more quickly than those with low priority if there is congestion, allowing time-sensitive applications to flow more smoothly. Time-sensitive applications include both those that require a low level of latency (delay) and a low level of jitter (variations in delay) such as Voice over IP (VoIP) or Internet gaming, and those for which jitter alone is a problem such as Internet radio or streaming video.

This chapter contains information about configuring QoS and editing classifiers.

10.1.1 What You Can Do in this Chapter

- The **General** screen lets you enable or disable QoS and set the upstream bandwidth ([Section 10.3 on page 141](#)).
- The **Queue Setup** screen lets you configure QoS queue assignment ([Section 10.4 on page 142](#)).
- The **Classification Setup** screen lets you add, edit or delete QoS classifiers ([Section 10.5 on page 144](#)).
- The **Shaper Setup** screen limits outgoing traffic transmission rate on the selected interface ([Section 10.6 on page 149](#)).
- The **Policer Setup** screen to control incoming traffic transmission rate and bursts ([Section 10.7 on page 150](#)).

10.2 What You Need to Know

The following terms and concepts may help as you read through this chapter.

QoS versus Cos

QoS is used to prioritize source-to-destination traffic flows. All packets in the same flow are given the same priority. CoS (class of service) is a way of managing traffic in a network by grouping similar types of traffic together and treating each type as a class. You can use CoS to give different priorities to different packet types.

CoS technologies include IEEE 802.1p layer 2 tagging and DiffServ (Differentiated Services or DS). IEEE 802.1p tagging makes use of three bits in the packet header, while DiffServ is a new protocol and defines a new DS field, which replaces the eight-bit ToS (Type of Service) field in the IP header.

Tagging and Marking

In a QoS class, you can configure whether to add or change the DSCP (DiffServ Code Point) value, IEEE 802.1p priority level and VLAN ID number in a matched packet. When the packet passes through a compatible network, the networking device, such as a backbone switch, can provide specific treatment or service based on the tag or marker.

Traffic Shaping

Bursty traffic may cause network congestion. Traffic shaping regulates packets to be transmitted with a pre-configured data transmission rate using buffers (or queues). Your VMG uses the Token Bucket algorithm to allow a certain amount of large bursts while keeping a limit at the average rate.

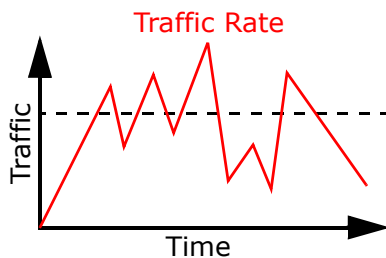

(Before Traffic Shaping)

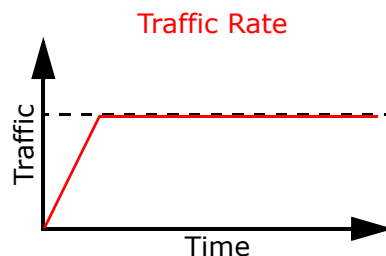

(After Traffic Shaping)

Traffic Policing

Traffic policing is the limiting of the input or output transmission rate of a class of traffic on the basis of user-defined criteria. Traffic policing methods measure traffic flows against user-defined criteria and identify it as either conforming, exceeding or violating the criteria.

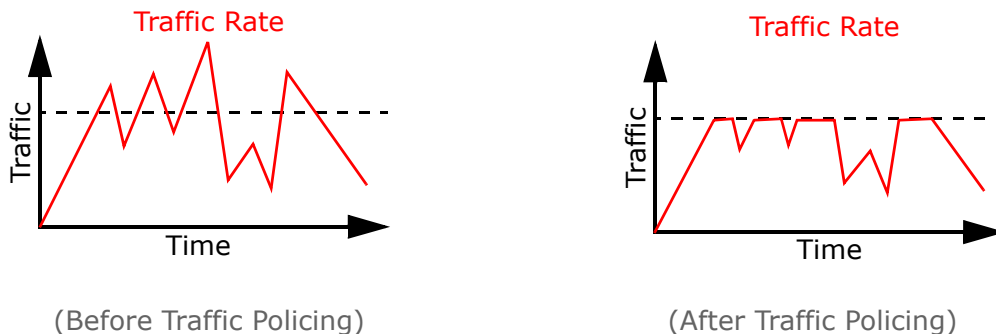

The VMG supports three incoming traffic metering algorithms: Token Bucket Filter (TBF), Single Rate Two Color Marker (srTCM), and Two Rate Two Color Marker (trTCM). You can specify actions which are performed on the colored packets. See [Section 10.8 on page 152](#) for more information on each metering algorithm.

10.3 The Quality of Service General Screen

Click **Network Setting > QoS > General** to open the screen as shown next.

Use this screen to enable or disable QoS and set the upstream bandwidth. See [Section 10.1 on page 139](#) for more information.

Figure 67 Network Settings > QoS > General

QoS Enable Disable (settings are invalid when disabled)

WAN Managed Upstream Bandwidth : (kbps)

LAN Managed Downstream Bandwidth : (kbps)

Upstream Traffic Priority Assigned by: ▼

Note

You can assign the upstream bandwidth manually. If the field is empty, the CPE set the value automatically.
 If Upstream Auto-Priority mapping criteria is selected, 8 level strict priority QoS will be applied automatically according to the selected criteria. In this mode, user manually defined QoS will not be applied until Auto-Priority Mapping is disabled
 If the setting of WAN managed upstream bandwidth is greater than current WAN interface linkup rate, then the WAN managed upstream bandwidth will become current WAN interface linkup rate.

The following table describes the labels in this screen.

Table 45 Network Setting > QoS > General

LABEL	DESCRIPTION
QoS	Select the Enable check box to turn on QoS to improve your network performance.
WAN Managed Upstream Bandwidth	<p>Enter the amount of upstream bandwidth for the WAN interfaces that you want to allocate using QoS.</p> <p>The recommendation is to set this speed to match the interfaces' actual transmission speed. For example, set the WAN interfaces' speed to 100000 kbps if your Internet connection has an upstream transmission speed of 100 Mbps.</p> <p>You can set this number higher than the interfaces' actual transmission speed. The VMG uses up to 95% of the DSL port's actual upstream transmission speed even if you set this number higher than the DSL port's actual transmission speed.</p> <p>You can also set this number lower than the interfaces' actual transmission speed. This will cause the VMG to not use some of the interfaces' available bandwidth.</p> <p>If you leave this field blank, the VMG automatically sets this number to be 95% of the WAN interfaces' actual upstream transmission speed.</p>
LAN Managed Downstream Bandwidth	<p>Enter the amount of downstream bandwidth for the LAN interfaces (including WLAN) that you want to allocate using QoS.</p> <p>The recommendation is to set this speed to match the WAN interfaces' actual transmission speed. For example, set the LAN managed downstream bandwidth to 100000 kbps if you use a 100 Mbps wired Ethernet WAN connection.</p> <p>You can also set this number lower than the WAN interfaces' actual transmission speed. This will cause the VMG to not use some of the interfaces' available bandwidth.</p> <p>If you leave this field blank, the VMG automatically sets this to the LAN interfaces' maximum supported connection speed.</p>
Upstream traffic priority Assigned by	<p>Select how the VMG assigns priorities to various upstream traffic flows.</p> <ul style="list-style-type: none"> • None: Disables auto priority mapping and has the VMG put packets into the queues according to your classification rules. Traffic which does not match any of the classification rules is mapped into the default queue with the lowest priority. • Ethernet Priority: Automatically assign priority based on the IEEE 802.1p priority level. • IP Precedence: Automatically assign priority based on the first three bits of the TOS field in the IP header. • Packet Length: Automatically assign priority based on the packet size. Smaller packets get higher priority since control, signaling, VoIP, internet gaming, or other real-time packets are usually small while larger packets are usually best effort data packets like file transfers.
Apply	Click Apply to save your changes.
Cancel	Click Cancel to restore your previously saved settings.

10.4 The Queue Setup Screen

Click **Network Setting > QoS > Queue Setup** to open the screen as shown next.

Use this screen to configure QoS queue assignment.

Figure 68 Network Setting > QoS > Queue Setup

Add New Queue								
#	Status	Name	Interface	Priority	Weight	Buffer Management	Rate Limit (kbps)	Modify
1		default queue	WAN	8	1	DT		
2		default queue	WAN	1	1	DT		

Note
 Maximum 8 configurable entries for WAN port.
 Priority level 1 is the highest priority for QoS.
 Rate limit 0 is max bandwidth.
 If queue is deleted, then related classifiers will be removed too.

The following table describes the labels in this screen.

Table 46 Network Setting > QoS > Queue Setup

LABEL	DESCRIPTION
Add New Queue	Click this button to create a new queue entry.
#	This is the index number of the entry.
Status	This field displays whether the queue is active or not. A yellow bulb signifies that this queue is active. A gray bulb signifies that this queue is not active.
Name	This shows the descriptive name of this queue.
Interface	This shows the name of the VMG's interface through which traffic in this queue passes.
Priority	This shows the priority of this queue.
Weight	This shows the weight of this queue.
Buffer Management	This shows the queue management algorithm used for this queue. Queue management algorithms determine how the VMG should handle packets when it receives too many (network congestion).
Rate Limit	This shows the maximum transmission rate allowed for traffic on this queue.
Modify	Click the Edit icon to edit the queue. Click the Delete icon to delete an existing queue. Note that subsequent rules move up by one when you take this action.

10.4.1 Adding a QoS Queue

Click **Add New Queue** or the edit icon in the **Queue Setup** screen to configure a queue.

Figure 69 Queue Setup: Add

The following table describes the labels in this screen.

Table 47 Queue Setup: Add

LABEL	DESCRIPTION
Active	Select to enable or disable this queue.
Name	Enter the descriptive name of this queue.
Interface	Select the interface to which this queue is applied. This field is read-only if you are editing the queue.
Priority	Select the priority level (from 1 to 7) of this queue. The smaller the number, the higher the priority level. Traffic assigned to higher priority queues gets through faster while traffic in lower priority queues is dropped if the network is congested.
Weight	Select the weight (from 1 to 8) of this queue. If two queues have the same priority level, the VMG divides the bandwidth across the queues according to their weights. Queues with larger weights get more bandwidth than queues with smaller weights.
Buffer Management	This field displays Drop Tail (DT) . Drop Tail (DT) is a simple queue management algorithm that allows the VMG buffer to accept as many packets as it can until it is full. Once the buffer is full, new packets that arrive are dropped until there is space in the buffer again (packets are transmitted out of it).
Rate Limit	Specify the maximum transmission rate (in Kbps) allowed for traffic on this queue.
OK	Click OK to save your changes.
Cancel	Click Cancel to exit this screen without saving.

10.5 The Classification Setup Screen

Use this screen to add, edit or delete QoS classifiers. A classifier groups traffic into data flows according to specific criteria such as the source address, destination address, source port number,

destination port number or incoming interface. For example, you can configure a classifier to select traffic from the same protocol port (such as Telnet) to form a flow.

You can give different priorities to traffic that the VMG forwards out through the WAN interface. Give high priority to voice and video to make them run more smoothly. Similarly, give low priority to many large file downloads so that they do not reduce the quality of other applications.

Click **Network Setting > QoS > Classification Setup** to open the following screen.

Figure 70 Network Setting > QoS > Classification Setup

Add New Classification								
Order	Status	Class Name	Classification Criteria	DSCP Mark	802.1P Mark	VLAN ID Tag	To Queue	Modify

The following table describes the labels in this screen.

Table 48 Network Setting > QoS > Classification Setup

LABEL	DESCRIPTION
Add New Classification	Click this to create a new classifier.
Order	This is the index number of the entry. The classifiers are applied in order of their numbering.
Status	This field displays whether the classifier is active or not. A yellow bulb signifies that this classifier is active. A gray bulb signifies that this classifier is not active.
Class Name	This is the name of the classifier.
Classification Criteria	This shows criteria specified in this classifier, for example the interface from which traffic of this class should come and the source MAC address of traffic that matches this classifier.
DSCP Mark	This is the DSCP number added to traffic of this classifier.
802.1P Mark	This is the IEEE 802.1p priority level assigned to traffic of this classifier.
VLAN ID Tag	This is the VLAN ID number assigned to traffic of this classifier.
To Queue	This is the name of the queue in which traffic of this classifier is put.
Modify	Click the Edit icon to edit the classifier. Click the Delete icon to delete an existing classifier. Note that subsequent rules move up by one when you take this action.

10.5.1 Add/Edit QoS Classifier

Click **Add New Classification** in the **Classification Setup** screen or the **Edit** icon next to a classifier to open the following screen.

Figure 71 Classification Setup: Add/Edit

✖
Add New Classification

Please follow the guidance through step 1~5 to configure a QoS rule

Step1: Class Configuration

Active Enable Disable

Class Name

Classification Order: ▼

Step2: Criteria Configuration

Use the configurations below to specify the characteristics of a data flow needed to be managed by this QoS rule

Basic

From Interface ▼

Ether Type ▼

Source

<input type="checkbox"/> Address	<input style="width: 100px;" type="text"/>	Subnet Mask	<input style="width: 100px;" type="text"/>	<input type="checkbox"/> Exclude
<input type="checkbox"/> Port Range	<input style="width: 50px;" type="text"/> ~ <input style="width: 50px;" type="text"/>			<input type="checkbox"/> Exclude
<input type="checkbox"/> MAC	<input style="width: 100px;" type="text" value="- - - - -"/>	MAC Mask	<input style="width: 100px;" type="text"/>	<input type="checkbox"/> Exclude

Destination

<input type="checkbox"/> Address	<input style="width: 100px;" type="text"/>	Subnet Mask	<input style="width: 100px;" type="text"/>	<input type="checkbox"/> Exclude
<input type="checkbox"/> Port Range	<input style="width: 50px;" type="text"/> ~ <input style="width: 50px;" type="text"/>			<input type="checkbox"/> Exclude
<input type="checkbox"/> MAC	<input style="width: 100px;" type="text" value="- - - - -"/>	MAC Mask	<input style="width: 100px;" type="text"/>	<input type="checkbox"/> Exclude

Others

<input type="checkbox"/> Service	<input type="text" value="Age of Empires"/> ▼	<input type="checkbox"/> Exclude
<input type="checkbox"/> IP protocol	<input type="text" value="TCP"/> ▼ <input style="width: 50px;" type="text"/>	<input type="checkbox"/> Exclude
<input type="checkbox"/> DHCP	<input type="text" value=""/> ▼	<input type="checkbox"/> Exclude
<input type="checkbox"/> Packet Length	<input style="width: 50px;" type="text"/> ~ <input style="width: 50px;" type="text"/>	<input type="checkbox"/> Exclude
<input type="checkbox"/> DSCP	<input style="width: 50px;" type="text"/> (0~63)	<input type="checkbox"/> Exclude
<input type="checkbox"/> 802.1P	<input type="text" value="0 BE"/> ▼	<input type="checkbox"/> Exclude
<input type="checkbox"/> VLAN ID	<input style="width: 50px;" type="text"/> (1~4095)	<input type="checkbox"/> Exclude
<input type="checkbox"/> TCP ACK		<input type="checkbox"/> Exclude

Step3: Packet Modification

The content of the packet can be modified by applying the following settings

DSCP Mark ▼ (0~63)

802.1P Mark ▼

VLAN ID Tag ▼ (1~4095)

Step4: Class Routing

This module can route a packet to a certain interface according to the class setting

Forward To Interface ▼

Step5: Outgoing Queue Selection

Outgoing queue decides the priority of the traffic and how traffic should be shaped in the WAN interface.

To Queue Index: ▼

The following table describes the labels in this screen.

Table 49 Classification Setup: Add/Edit

LABEL	DESCRIPTION
Step1: Class Configuration	
Active	Select to enable or disable this classifier.
Class Name	Enter a descriptive name of up to 15 printable English keyboard characters, not including spaces.
Classification Order	Select an existing number for where you want to put this classifier to move the classifier to the number you selected after clicking OK . Select Last to put this rule in the back of the classifier list.
Step2: Criteria Configuration	
From Interface	If you want to classify the traffic by an ingress interface, select an interface from the From Interface drop-down list box.
Ether Type	Select a predefined application to configure a class for the matched traffic. If you select IP , you also need to configure source or destination MAC address, IP address, DHCP options, DSCP value or the protocol type. If you select 802.1Q , you can configure an 802.1p priority level.
Source	
Address	Select the check box and enter the source IP address in dotted decimal notation. A blank source IP address means any source IP address.
Subnet Mask	Enter the source subnet mask.
Port Range	If you select TCP or UDP in the IP Protocol field, select the check box and enter the port number(s) of the source.
MAC	Select the check box and enter the source MAC address of the packet.
MAC Mask	Type the mask for the specified MAC address to determine which bits a packet's MAC address should match. Enter "f" for each bit of the specified source MAC address that the traffic's MAC address should match. Enter "0" for the bit(s) of the matched traffic's MAC address, which can be of any hexadecimal character(s). For example, if you set the MAC address to 00:13:49:00:00:00 and the mask to ff:ff:ff:00:00:00, a packet with a MAC address of 00:13:49:12:34:56 matches this criteria.
Exclude	Select this option to exclude the packets that match the specified criteria from this classifier.
Destination	
Address	Select the check box and enter the source IP address in dotted decimal notation. A blank source IP address means any source IP address.
Subnet Mask	Enter the source subnet mask.
Port Range	If you select TCP or UDP in the IP Protocol field, select the check box and enter the port number(s) of the source.
MAC	Select the check box and enter the source MAC address of the packet.
MAC Mask	Type the mask for the specified MAC address to determine which bits a packet's MAC address should match. Enter "f" for each bit of the specified source MAC address that the traffic's MAC address should match. Enter "0" for the bit(s) of the matched traffic's MAC address, which can be of any hexadecimal character(s). For example, if you set the MAC address to 00:13:49:00:00:00 and the mask to ff:ff:ff:00:00:00, a packet with a MAC address of 00:13:49:12:34:56 matches this criteria.
Exclude	Select this option to exclude the packets that match the specified criteria from this classifier.

Table 49 Classification Setup: Add/Edit (continued)

LABEL	DESCRIPTION
Others	
Service	<p>This field is available only when you select IP in the Ether Type field.</p> <p>This field simplifies classifier configuration by allowing you to select a predefined application. When you select a predefined application, you do not configure the rest of the filter fields.</p>
Protocol	<p>This field is available only when you select IP in the Ether Type field.</p> <p>Select this option and select the protocol (service type) from TCP, UDP, ICMP or IGMP. If you select User defined, enter the protocol (service type) number.</p>
DHCP	<p>This field is available only when you select IP in the Ether Type field.</p> <p>Select this option and select a DHCP option.</p> <p>If you select Vendor Class ID (DHCP Option 60), enter the Vendor Class Identifier (Option 60) of the matched traffic, such as the type of the hardware or firmware.</p> <p>If you select Client ID (DHCP Option 61), enter the Identity Association Identifier (IAD Option 61) of the matched traffic, such as the MAC address of the device.</p> <p>If you select User Class ID (DHCP Option 77), enter a string that identifies the user's category or application type in the matched DHCP packets.</p> <p>If you select Vendor Specific Info (DHCP Option 125), enter the vendor specific information of the matched traffic, such as the product class, model name, and serial number of the device.</p>
Packet Length	<p>This field is available only when you select IP in the Ether Type field.</p> <p>Select this option and enter the minimum and maximum packet length (from 46 to 1500) in the fields provided.</p>
DSCP	<p>This field is available only when you select IP in the Ether Type field.</p> <p>Select this option and specify a DSCP (DiffServ Code Point) number between 0 and 63 in the field provided.</p>
802.1P	<p>This field is available only when you select 802.1Q in the Ether Type field.</p> <p>Select this option and select a priority level (between 0 and 7) from the drop-down list box. "0" is the lowest priority level and "7" is the highest.</p>
VLAN ID	<p>This field is available only when you select 802.1Q in the Ether Type field.</p> <p>Select this option and specify a VLAN ID number.</p>
TCP ACK	<p>This field is available only when you select IP in the Ether Type field.</p> <p>If you select this option, the matched TCP packets must contain the ACK (Acknowledge) flag.</p>
Exclude	<p>Select this option to exclude the packets that match the specified criteria from this classifier.</p>
Step3: Packet Modification	
DSCP Mark	<p>This field is available only when you select IP in the Ether Type field.</p> <p>If you select Remark, enter a DSCP value with which the VMG replaces the DSCP field in the packets.</p> <p>If you select Unchange, the VMG keep the DSCP field in the packets.</p>
802.1P Mark	<p>Select a priority level with which the VMG replaces the IEEE 802.1p priority field in the packets.</p> <p>If you select Unchange, the VMG keep the 802.1p priority field in the packets.</p>

Table 49 Classification Setup: Add/Edit (continued)

LABEL	DESCRIPTION
VLAN ID Tag	If you select Remark , enter a VLAN ID number with which the VMG replaces the VLAN ID of the frames. If you select Remove , the VMG deletes the VLAN ID of the frames before forwarding them out. If you select Add , the VMG treat all matched traffic untagged and add a second VLAN ID. If you select Unchange , the VMG keep the VLAN ID in the packets.
Step4: Class Routing	
Forward to Interface	Select a WAN interface through which traffic of this class will be forwarded out. If you select Unchange , the VMG forward traffic of this class according to the default routing table.
Step5: Outgoing Queue Selection	
To Queue Index	Select a queue that applies to this class. You should have configured a queue in the Queue Setup screen already.
OK	Click OK to save your changes.
Cancel	Click Cancel to exit this screen without saving.

10.6 The QoS Shaper Setup Screen

This screen shows that you can use the token bucket algorithm to allow a certain amount of large bursts while keeping a limit for processing outgoing traffic at the average rate. Click **Network Setting > QoS > Shaper Setup**. The screen appears as shown.

Figure 72 Network Setting > QoS > Shaper Setup

#	Status	Outgoing Interface	Rate Limit (kbps)	Modify
Add New Shaper				

The following table describes the labels in this screen.

Table 50 Network Setting > QoS > Shaper Setup

LABEL	DESCRIPTION
Add New Shaper	Click this to create a new entry.
#	This is the index number of the entry.
Status	This field displays whether the shaper is active or not. A yellow bulb signifies that this policer is active. A gray bulb signifies that this shaper is not active.
Outgoing Interface	This shows the name of the VMG's interface through which traffic in this shaper applies.
Rate Limit (kbps)	This shows the average rate limit of traffic bursts for this shaper.
Modify	Click the Edit icon to edit the shaper. Click the Delete icon to delete an existing shaper. Note that subsequent rules move up by one when you take this action.

10.6.1 Add/Edit a QoS Shaper

Click **Add New Shaper** in the **Shaper Setup** screen or the **Edit** icon next to a shaper to show the following screen.

Figure 73 Shaper Setup: Add/Edit

The following table describes the labels in this screen.

Table 51 Shaper Setup: Add/Edit

LABEL	DESCRIPTION
Active	Select to enable or disable this shaper.
Interface	Select the VMG's interface through which traffic in this shaper applies.
Rate Limit	Enter the average rate limit of traffic bursts for this shaper.
OK	Click OK to save your changes.
Cancel	Click Cancel to exit this screen without saving.

10.7 The QoS Policer Setup Screen

Use this screen to view QoS policers that allow you to limit the transmission rate of incoming traffic and apply actions, such as drop, pass, or modify the DSCP value for matched traffic. Click **Network Setting > QoS > Policer Setup**. The screen appears as shown.

Figure 74 Network Setting > QoS > Policer Setup

The following table describes the labels in this screen.

Table 52 Network Setting > QoS > Policer Setup

LABEL	DESCRIPTION
Add New Policer	Click this to create a new entry.
#	This is the index number of the entry.

Table 52 Network Setting > QoS > Policer Setup (continued)

LABEL	DESCRIPTION
Status	This field displays whether the policer is active or not. A yellow bulb signifies that this policer is active. A gray bulb signifies that this policer is not active.
Name	This field displays the descriptive name of this policer.
Regulated Classes	This field displays the name of a QoS classifier
Meter Type	This field displays the type of QoS metering algorithm used in this policer.
Rule	These are the rates and burst sizes against which the policer checks the traffic of the member QoS classes.
Action	This shows the how the policer has the VMG treat different types of traffic belonging to the policer's member QoS classes.
Modify	Click the Edit icon to edit the policer. Click the Delete icon to delete an existing policer. Note that subsequent rules move up by one when you take this action.

10.7.1 Add/Edit a QoS Policer

Click **Add New Policer** in the **Policer Setup** screen or the **Edit** icon next to a policer to show the following screen.

Figure 75 Policer Setup: Add/Edit

The following table describes the labels in this screen.

Table 53 Policer Setup: Add/Edit

LABEL	DESCRIPTION
Active	Select enable or disable this policer.
Name	Enter the descriptive name of this policer.

Table 53 Policer Setup: Add/Edit

LABEL	DESCRIPTION
Meter Type	<p>This shows the traffic metering algorithm used in this policer.</p> <p>The Simple Token Bucket algorithm uses tokens in a bucket to control when traffic can be transmitted. Each token represents one byte. The algorithm allows bursts of up to b bytes which is also the bucket size.</p> <p>The Single Rate Three Color Marker (srTCM) is based on the token bucket filter and identifies packets by comparing them to the Committed Information Rate (CIR), the Committed Burst Size (CBS) and the Excess Burst Size (EBS).</p> <p>The Two Rate Three Color Marker (trTCM) is based on the token bucket filter and identifies packets by comparing them to the Committed Information Rate (CIR) and the Peak Information Rate (PIR).</p>
Committed Rate	Specify the committed rate. When the incoming traffic rate of the member QoS classes is less than the committed rate, the device applies the conforming action to the traffic.
Committed Burst Size	<p>Specify the committed burst size for packet bursts. This must be equal to or less than the peak burst size (two rate three color) or excess burst size (single rate three color) if it is also configured.</p> <p>This is the maximum size of the (first) token bucket in a traffic metering algorithm.</p>
Conforming Action	<p>Specify what the VMG does for packets within the committed rate and burst size (green-marked packets).</p> <ul style="list-style-type: none"> • Pass: Send the packets without modification. • DSCP Mark: Change the DSCP mark value of the packets. Enter the DSCP mark value to use.
Non-Conforming Action	<p>Specify what the VMG does for packets that exceed the excess burst size or peak rate and burst size (red-marked packets).</p> <ul style="list-style-type: none"> • Drop: Discard the packets. • DSCP Mark: Change the DSCP mark value of the packets. Enter the DSCP mark value to use. The packets may be dropped if there is congestion on the network.
Available Class	Select a QoS classifier to apply this QoS policer to traffic that matches the QoS classifier.
Selected Class	<p>Highlight a QoS classifier in the Available Class box and use the > button to move it to the Selected Class box.</p> <p>To remove a QoS classifier from the Selected Class box, select it and use the < button.</p>
OK	Click OK to save your changes.
Cancel	Click Cancel to exit this screen without saving.

10.8 Technical Reference

The following section contains additional technical information about the VMG features described in this chapter.

IEEE 802.1Q Tag

The IEEE 802.1Q standard defines an explicit VLAN tag in the MAC header to identify the VLAN membership of a frame across bridges. A VLAN tag includes the 12-bit VLAN ID and 3-bit user priority. The VLAN ID associates a frame with a specific VLAN and provides the information that devices need to process the frame across the network.

IEEE 802.1p specifies the user priority field and defines up to eight separate traffic types. The following table describes the traffic types defined in the IEEE 802.1d standard (which incorporates the 802.1p).

Table 54 IEEE 802.1p Priority Level and Traffic Type

PRIORITY LEVEL	TRAFFIC TYPE
Level 7	Typically used for network control traffic such as router configuration messages.
Level 6	Typically used for voice traffic that is especially sensitive to jitter (jitter is the variations in delay).
Level 5	Typically used for video that consumes high bandwidth and is sensitive to jitter.
Level 4	Typically used for controlled load, latency-sensitive traffic such as SNA (Systems Network Architecture) transactions.
Level 3	Typically used for "excellent effort" or better than best effort and would include important business traffic that can tolerate some delay.
Level 2	This is for "spare bandwidth".
Level 1	This is typically used for non-critical "background" traffic such as bulk transfers that are allowed but that should not affect other applications and users.
Level 0	Typically used for best-effort traffic.

DiffServ

QoS is used to prioritize source-to-destination traffic flows. All packets in the flow are given the same priority. You can use CoS (class of service) to give different priorities to different packet types.

DiffServ (Differentiated Services) is a class of service (CoS) model that marks packets so that they receive specific per-hop treatment at DiffServ-compliant network devices along the route based on the application types and traffic flow. Packets are marked with DiffServ Code Points (DSCPs) indicating the level of service desired. This allows the intermediary DiffServ-compliant network devices to handle the packets differently depending on the code points without the need to negotiate paths or remember state information for every flow. In addition, applications do not have to request a particular service or give advanced notice of where the traffic is going.

DSCP and Per-Hop Behavior

DiffServ defines a new Differentiated Services (DS) field to replace the Type of Service (TOS) field in the IP header. The DS field contains a 2-bit unused field and a 6-bit DSCP field which can define up to 64 service levels. The following figure illustrates the DS field.

DSCP is backward compatible with the three precedence bits in the ToS octet so that non-DiffServ compliant, ToS-enabled network device will not conflict with the DSCP mapping.

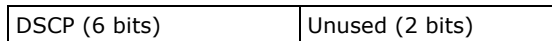

The DSCP value determines the forwarding behavior, the PHB (Per-Hop Behavior), that each packet gets across the DiffServ network. Based on the marking rule, different kinds of traffic can be marked for different kinds of forwarding. Resources can then be allocated according to the DSCP values and the configured policies.

IP Precedence

Similar to IEEE 802.1p prioritization at layer-2, you can use IP precedence to prioritize packets in a layer-3 network. IP precedence uses three bits of the eight-bit ToS (Type of Service) field in the IP header. There are eight classes of services (ranging from zero to seven) in IP precedence. Zero is the lowest priority level and seven is the highest.

Automatic Priority Queue Assignment

If you enable QoS on the VMG, the VMG can automatically base on the IEEE 802.1p priority level, IP precedence and/or packet length to assign priority to traffic which does not match a class.

The following table shows you the internal layer-2 and layer-3 QoS mapping on the VMG. On the VMG, traffic assigned to higher priority queues gets through faster while traffic in lower index queues is dropped if the network is congested.

Table 55 Internal Layer2 and Layer3 QoS Mapping

PRIORITY QUEUE	LAYER 2	LAYER 3		
	IEEE 802.1P USER PRIORITY (ETHERNET PRIORITY)	TOS (IP PRECEDENCE)	DSCP	IP PACKET LENGTH (BYTE)
0	1	0	000000	
1	2			
2	0	0	000000	>1100
3	3	1	001110 001100 001010 001000	250~1100
4	4	2	010110 010100 010010 010000	
5	5	3	011110 011100 011010 011000	<250
6	6	4	100110 100100 100010 100000	
		5	101110 101000	
7	7	6	110000	
		7	111000	

Token Bucket

The token bucket algorithm uses tokens in a bucket to control when traffic can be transmitted. The bucket stores tokens, each of which represents one byte. The algorithm allows bursts of up to b bytes which is also the bucket size, so the bucket can hold up to b tokens. Tokens are generated and added into the bucket at a constant rate. The following shows how tokens work with packets:

- A packet can be transmitted if the number of tokens in the bucket is equal to or greater than the size of the packet (in bytes).
- After a packet is transmitted, a number of tokens corresponding to the packet size is removed from the bucket.
- If there are no tokens in the bucket, the VMG stops transmitting until enough tokens are generated.
- If not enough tokens are available, the VMG treats the packet in either one of the following ways:
 - In traffic shaping:
 - Holds it in the queue until enough tokens are available in the bucket.
 - In traffic policing:
 - Drops it.
 - Transmits it but adds a DSCP mark. The VMG may drop these marked packets if the network is overloaded.

Configure the bucket size to be equal to or less than the amount of the bandwidth that the interface can support. It does not help if you set it to a bucket size over the interface's capability. The smaller the bucket size, the lower the data transmission rate and that may cause outgoing packets to be dropped. A larger transmission rate requires a big bucket size. For example, use a bucket size of 10 kbytes to get the transmission rate up to 10 Mbps.

Single Rate Three Color Marker

The Single Rate Three Color Marker (srTCM, defined in RFC 2697) is a type of traffic policing that identifies packets by comparing them to one user-defined rate, the Committed Information Rate (CIR), and two burst sizes: the Committed Burst Size (CBS) and Excess Burst Size (EBS).

The srTCM evaluates incoming packets and marks them with one of three colors which refer to packet loss priority levels. High packet loss priority level is referred to as red, medium is referred to as yellow and low is referred to as green.

The srTCM is based on the token bucket filter and has two token buckets (CBS and EBS). Tokens are generated and added into the bucket at a constant rate, called Committed Information Rate (CIR). When the first bucket (CBS) is full, new tokens overflow into the second bucket (EBS).

All packets are evaluated against the CBS. If a packet does not exceed the CBS it is marked green. Otherwise it is evaluated against the EBS. If it is below the EBS then it is marked yellow. If it exceeds the EBS then it is marked red.

The following shows how tokens work with incoming packets in srTCM:

- A packet arrives. The packet is marked green and can be transmitted if the number of tokens in the CBS bucket is equal to or greater than the size of the packet (in bytes).
- After a packet is transmitted, a number of tokens corresponding to the packet size is removed from the CBS bucket.

- If there are not enough tokens in the CBS bucket, the VMG checks the EBS bucket. The packet is marked yellow if there are sufficient tokens in the EBS bucket. Otherwise, the packet is marked red. No tokens are removed if the packet is dropped.

Two Rate Three Color Marker

The Two Rate Three Color Marker (trTCM, defined in RFC 2698) is a type of traffic policing that identifies packets by comparing them to two user-defined rates: the Committed Information Rate (CIR) and the Peak Information Rate (PIR). The CIR specifies the average rate at which packets are admitted to the network. The PIR is greater than or equal to the CIR. CIR and PIR values are based on the guaranteed and maximum bandwidth respectively as negotiated between a service provider and client.

The trTCM evaluates incoming packets and marks them with one of three colors which refer to packet loss priority levels. High packet loss priority level is referred to as red, medium is referred to as yellow and low is referred to as green.

The trTCM is based on the token bucket filter and has two token buckets (Committed Burst Size (CBS) and Peak Burst Size (PBS)). Tokens are generated and added into the two buckets at the CIR and PIR respectively.

All packets are evaluated against the PIR. If a packet exceeds the PIR it is marked red. Otherwise it is evaluated against the CIR. If it exceeds the CIR then it is marked yellow. Finally, if it is below the CIR then it is marked green.

The following shows how tokens work with incoming packets in trTCM:

- A packet arrives. If the number of tokens in the PBS bucket is less than the size of the packet (in bytes), the packet is marked red and may be dropped regardless of the CBS bucket. No tokens are removed if the packet is dropped.
- If the PBS bucket has enough tokens, the VMG checks the CBS bucket. The packet is marked green and can be transmitted if the number of tokens in the CBS bucket is equal to or greater than the size of the packet (in bytes). Otherwise, the packet is marked yellow.

Network Address Translation (NAT)

11.1 Overview

This chapter discusses how to configure NAT on the VMG. NAT (Network Address Translation - NAT, RFC 1631) is the translation of the IP address of a host in a packet, for example, the source address of an outgoing packet, used within one network to a different IP address known within another network.

11.1.1 What You Can Do in this Chapter

- Use the **Port Forwarding** screen to configure forward incoming service requests to the server(s) on your local network ([Section 11.2 on page 158](#)).
- Use the **Applications** screen to forward incoming service requests to the server(s) on your local network ([Section 11.3 on page 161](#)).
- Use the **Port Triggering** screen to add and configure the VMG's trigger port settings ([Section 11.4 on page 162](#)).
- Use the **DMZ** screen to configure a default server ([Section 11.5 on page 165](#)).
- Use the **ALG** screen to enable and disable the NAT and SIP (VoIP) ALG in the VMG ([Section 11.6 on page 166](#)).
- Use the **Address Mapping** screen to configure the VMG's address mapping settings ([Section 11.7 on page 166](#)).
- Use the **Sessions** screen to configure the VMG's maximum number of NAT sessions ([Section 11.7 on page 166](#)).

11.1.2 What You Need To Know

Inside/Outside

Inside/outside denotes where a host is located relative to the VMG, for example, the computers of your subscribers are the inside hosts, while the web servers on the Internet are the outside hosts.

Global/Local

Global/local denotes the IP address of a host in a packet as the packet traverses a router, for example, the local address refers to the IP address of a host when the packet is in the local network, while the global address refers to the IP address of the host when the same packet is traveling in the WAN side.

NAT

In the simplest form, NAT changes the source IP address in a packet received from a subscriber (the inside local address) to another (the inside global address) before forwarding the packet to the WAN side. When the response comes back, NAT translates the destination address (the inside global address) back to the inside local address before forwarding it to the original inside host.

Port Forwarding

A port forwarding set is a list of inside (behind NAT on the LAN) servers, for example, web or FTP, that you can make visible to the outside world even though NAT makes your whole inside network appear as a single computer to the outside world.

Finding Out More

See [Section 11.9 on page 169](#) for advanced technical information on NAT.

11.2 The Port Forwarding Screen

Use the **Port Forwarding** screen to forward incoming service requests to the server(s) on your local network.

You may enter a single port number or a range of port numbers to be forwarded, and the local IP address of the desired server. The port number identifies a service; for example, web service is on port 80 and FTP on port 21. In some cases, such as for unknown services or where one server can support more than one service (for example both FTP and web service), it might be better to specify a range of port numbers. You can allocate a server IP address that corresponds to a port or a range of ports.

The most often used port numbers and services are shown in [Appendix D on page 293](#). Please refer to RFC 1700 for further information about port numbers.

Note: Many residential broadband ISP accounts do not allow you to run any server processes (such as a Web or FTP server) from your location. Your ISP may periodically check for servers and may suspend your account if it discovers any active services at your location. If you are unsure, refer to your ISP.

Configuring Servers Behind Port Forwarding (Example)

Let's say you want to assign ports 21-25 to one FTP, Telnet and SMTP server (**A** in the example), port 80 to another (**B** in the example) and assign a default server IP address of 192.168.1.35 to a third (**C** in the example). You assign the LAN IP addresses and the ISP assigns the WAN IP address. The NAT network appears as a single host on the Internet.

Figure 76 Multiple Servers Behind NAT Example

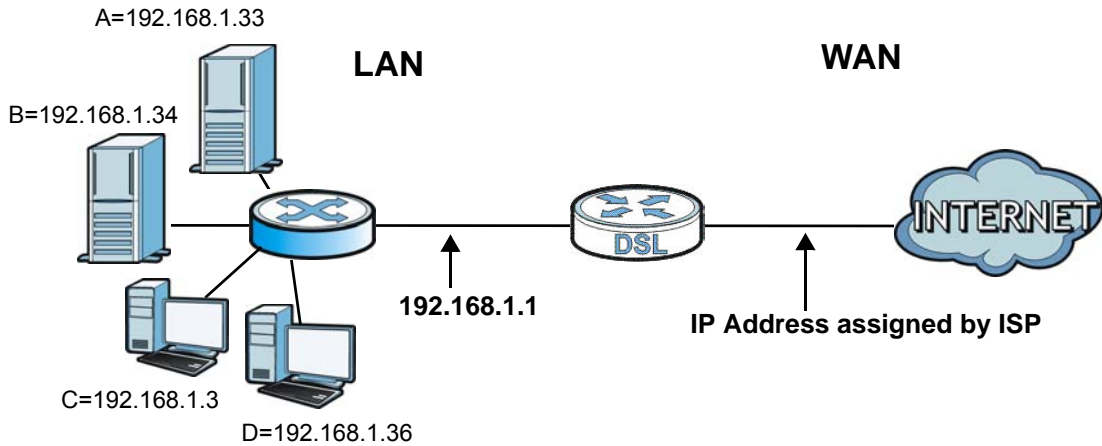

Click **Network Setting > NAT > Port Forwarding** to open the following screen.

See [Appendix D on page 293](#) for port numbers commonly used for particular services.

Figure 77 Network Setting > NAT > Port Forwarding

Add New Rule											
#	Status	Service Name	WAN Interface	WAN IP	Server IP Address	Start Port	End Port	Translation Start Port	Translation End Port	Protocol	Modify
<p>Note: The TCP port 7547 is reserved for TR069 connection request port.</p>											

The following table describes the fields in this screen.

Table 56 Network Setting > NAT > Port Forwarding

LABEL	DESCRIPTION
Add New Rule	Click this to add a new rule.
#	This is the index number of the entry.
Status	This field displays whether the NAT rule is active or not. A yellow bulb signifies that this rule is active. A gray bulb signifies that this rule is not active.
Service Name	This shows the service's name.
WAN Interface	This shows the WAN interface through which the service is forwarded.
WAN IP	This field displays the incoming packet's destination IP address.
Server IP Address	This is the server's IP address.
Start Port	This is the first external port number that identifies a service.
End Port	This is the last external port number that identifies a service.
Translation Start Port	This is the first internal port number that identifies a service.
Translation End Port	This is the last internal port number that identifies a service.
Protocol	This shows the IP protocol supported by this virtual server, whether it is TCP , UDP , or TCP/UDP .
Modify	Click the Edit icon to edit this rule. Click the Delete icon to delete an existing rule.

11.2.1 Add/Edit Port Forwarding

Click **Add New Rule** in the **Port Forwarding** screen or click the **Edit** icon next to an existing rule to open the following screen.

Figure 78 Port Forwarding: Add/Edit

Add New Rule

Active Enable Disable

Service Name

WAN Interface

WAN IP

Start Port

End Port

Translation Start Port

Translation End Port

Server IP Address

Protocol

Wake up this target by Wake On Lan(WOL)

MAC address of WOL device

Note

- If Start Port and Translation Start Port, End Port and Translation End Port is configured the same, then Port Forwarding is configured.
If Start Port and Translation Start Port, End Port and Translation End Port are configured differently, then Port Translation is configured (one to one mapping).
For example: Start Port: 100 End Port: 120; Translation Start Port: 200 Translation End Port: 220
- WAN IP is optional, if Multi-to-Multi NAT is required, enter the WAN IP of the desired device.

OK Cancel

The following table describes the labels in this screen.

Table 57 Port Forwarding: Add/Edit

LABEL	DESCRIPTION
Active	Clear the checkbox to disable the rule. Select the check box to enable it.
Service Name	Enter a name to identify this rule using keyboard characters (A-Z, a-z, 1-2 and so on).
WAN Interface	Select the WAN interface through which the service is forwarded. You must have already configured a WAN connection with NAT enabled.
WAN IP	Enter the WAN IP address for which the incoming service is destined. If the packet's destination IP address doesn't match the one specified here, the port forwarding rule will not be applied.
Start Port	Enter the original destination port for the packets. To forward only one port, enter the port number again in the End Port field. To forward a series of ports, enter the start port number here and the end port number in the End Port field.

Table 57 Port Forwarding: Add/Edit (continued)

LABEL	DESCRIPTION
End Port	Enter the last port of the original destination port range. To forward only one port, enter the port number in the Start Port field above and then enter it again in this field. To forward a series of ports, enter the last port number in a series that begins with the port number in the Start Port field above.
Translation Start Port	This shows the port number to which you want the VMG to translate the incoming port. For a range of ports, enter the first number of the range to which you want the incoming ports translated.
Translation End Port	This shows the last port of the translated port range.
Server IP Address	Enter the inside IP address of the virtual server here.
Protocol	Select the protocol supported by this virtual server. Choices are TCP , UDP , or TCP/UDP .
Wake up this target by Wake On Lan(WOL)	Select this to turn on the virtual server remotely.
MAC address of WOL device	Enter the MAC address of the device to turn it on.
OK	Click OK to save your changes.
Cancel	Click Cancel to exit this screen without saving.

11.3 The Applications Screen

This screen provides a summary of all NAT applications and their configuration. In addition, this screen allows you to create new applications and/or remove existing ones.

To access this screen, click **Network Setting > NAT > Applications**. The following screen appears.

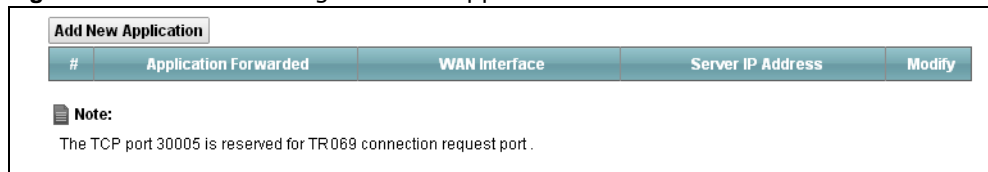
Figure 79 Network Setting > NAT > Applications

Add New Application				
#	Application Forwarded	WAN Interface	Server IP Address	Modify
<p>Note: The TCP port 30005 is reserved for TR069 connection request port.</p>				

The following table describes the labels in this screen.

Table 58 Network Setting > NAT > Applications

LABEL	DESCRIPTION
Add New Application	Click this to add a new NAT application rule.
Application Forwarded	This field shows the type of application that the service forwards.
WAN Interface	This field shows the WAN interface through which the service is forwarded.

Table 58 Network Setting > NAT > Applications (continued)

LABEL	DESCRIPTION
Server IP Address	This field displays the destination IP address for the service.
Modify	Click the Delete icon to delete the rule.

11.3.1 Add New Application

This screen lets you create new NAT application rules. Click **Add New Application** in the **Applications** screen to open the following screen.

Figure 80 Applications: Add

The following table describes the labels in this screen.

Table 59 Applications: Add

LABEL	DESCRIPTION
WAN Interface	Select the WAN interface that you want to apply this NAT rule to.
Server IP Address	Enter the inside IP address of the application here.
Application Category	Select the category of the application from the drop-down list box.
Application Forwarded	Select a service from the drop-down list box and the VMG automatically configures the protocol, start, end, and map port number that define the service.
View Rule	Click this to display the configuration of the service that you have chosen in Application Forwarded .
OK	Click OK to save your changes.
Cancel	Click Cancel to exit this screen without saving.

11.4 The Port Triggering Screen

Some services use a dedicated range of ports on the client side and a dedicated range of ports on the server side. With regular port forwarding you set a forwarding port in NAT to forward a service (coming in from the server on the WAN) to the IP address of a computer on the client side (LAN). The problem is that port forwarding only forwards a service to a single LAN IP address. In order to use the same service on a different LAN computer, you have to manually replace the LAN computer's IP address in the forwarding port with another LAN computer's IP address.

Trigger port forwarding solves this problem by allowing computers on the LAN to dynamically take turns using the service. The VMG records the IP address of a LAN computer that sends traffic to the WAN to request a service with a specific port number and protocol (a "trigger" port). When the VMG's WAN port receives a response with a specific port number and protocol ("open" port), the VMG forwards the traffic to the LAN IP address of the computer that sent the request. After that computer's connection for that service closes, another computer on the LAN can use the service in the same manner. This way you do not need to configure a new IP address each time you want a different LAN computer to use the application.

For example:

Figure 81 Trigger Port Forwarding Process: Example

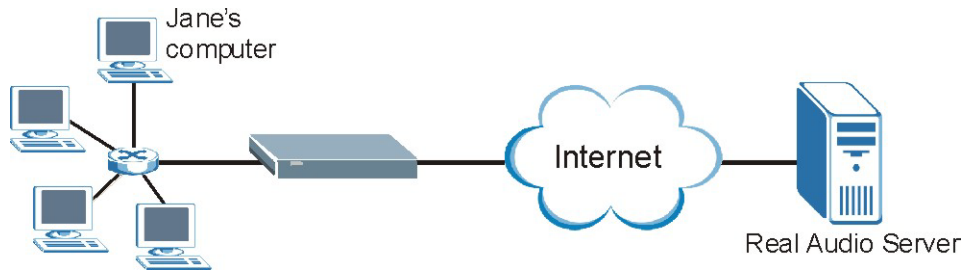

- 1 Jane requests a file from the Real Audio server (port 7070).
- 2 Port 7070 is a "trigger" port and causes the VMG to record Jane's computer IP address. The VMG associates Jane's computer IP address with the "open" port range of 6970-7170.
- 3 The Real Audio server responds using a port number ranging between 6970-7170.
- 4 The VMG forwards the traffic to Jane's computer IP address.
- 5 Only Jane can connect to the Real Audio server until the connection is closed or times out. The VMG times out in three minutes with UDP (User Datagram Protocol) or two hours with TCP/IP (Transfer Control Protocol/Internet Protocol).

Click **Network Setting > NAT > Port Triggering** to open the following screen. Use this screen to view your VMG's trigger port settings.

Figure 82 Network Setting > NAT > Port Triggering

#	Status	Service Name	WAN Interface	Trigger Start Port	Trigger End Port	Trigger Proto.	Open Start Port	Open End Port	Open Proto.	Modify
<p>Note:</p> <ol style="list-style-type: none"> 1. The sum of trigger ports in all rules must be less than 1000 and every open port range must be less than 1000. When the protocol is TCP/UDP, the ports are counted twice. 2. The TCP port 7547 is reserved for TR069 connection request port. 										

The following table describes the labels in this screen.

Table 60 Network Setting > NAT > Port Triggering

LABEL	DESCRIPTION
Add New Rule	Click this to create a new rule.
#	This is the index number of the entry.
Status	This field displays whether the port triggering rule is active or not. A yellow bulb signifies that this rule is active. A gray bulb signifies that this rule is not active.

Table 60 Network Setting > NAT > Port Triggering (continued)

LABEL	DESCRIPTION
Service Name	This field displays the name of the service used by this rule.
WAN Interface	This field shows the WAN interface through which the service is forwarded.
Trigger Start Port	The trigger port is a port (or a range of ports) that causes (or triggers) the VMG to record the IP address of the LAN computer that sent the traffic to a server on the WAN. This is the first port number that identifies a service.
Trigger End Port	This is the last port number that identifies a service.
Trigger Proto.	This is the trigger transport layer protocol.
Open Start Port	The open port is a port (or a range of ports) that a server on the WAN uses when it sends out a particular service. The VMG forwards the traffic with this port (or range of ports) to the client computer on the LAN that requested the service. This is the first port number that identifies a service.
Open End Port	This is the last port number that identifies a service.
Open Proto.	This is the open transport layer protocol.
Modify	Click the Edit icon to edit this rule. Click the Delete icon to delete an existing rule.

11.4.1 Add/Edit Port Triggering Rule

This screen lets you create new port triggering rules. Click **Add new rule** in the **Port Triggering** screen or click a rule's **Edit** icon to open the following screen.

Figure 83 Port Triggering: Add/Edit

The following table describes the labels in this screen.

Table 61 Port Triggering: Configuration Add/Edit

LABEL	DESCRIPTION
Active	Select to enable or disable this rule.
Service Name	Enter a name to identify this rule using keyboard characters (A-Z, a-z, 1-2 and so on).
WAN Interface	Select a WAN interface for which you want to configure port triggering rules.

Table 61 Port Triggering: Configuration Add/Edit (continued)

LABEL	DESCRIPTION
Trigger Start Port	The trigger port is a port (or a range of ports) that causes (or triggers) the VMG to record the IP address of the LAN computer that sent the traffic to a server on the WAN. Type a port number or the starting port number in a range of port numbers.
Trigger End Port	Type a port number or the ending port number in a range of port numbers.
Trigger Protocol	Select the transport layer protocol from TCP , UDP , or TCP/UDP .
Open Start Port	The open port is a port (or a range of ports) that a server on the WAN uses when it sends out a particular service. The VMG forwards the traffic with this port (or range of ports) to the client computer on the LAN that requested the service. Type a port number or the starting port number in a range of port numbers.
Open End Port	Type a port number or the ending port number in a range of port numbers.
Open Protocol	Select the transport layer protocol from TCP , UDP , or TCP/UDP .
OK	Click OK to save your changes.
Cancel	Click Cancel to exit this screen without saving.

11.5 The DMZ Screen

In addition to the servers for specified services, NAT supports a default server IP address. A default server receives packets from ports that are not specified in the **NAT Port Forwarding Setup** screen.

Figure 84 Network Setting > NAT > DMZ

Default Server Address :

Note:
Enter IP address and click 'Apply' to activate the DMZ host.
Clear the IP address field and click 'Apply' to deactivate the DMZ host.

The following table describes the fields in this screen.

Table 62 Network Setting > NAT > DMZ

LABEL	DESCRIPTION
Default Server Address	Enter the IP address of the default server which receives packets from ports that are not specified in the NAT Port Forwarding screen. Note: If you do not assign a Default Server Address , the VMG discards all packets received for ports that are not specified in the NAT Port Forwarding screen.
Apply	Click Apply to save your changes.
Cancel	Click Cancel to restore your previously saved settings.

11.6 The ALG Screen

Some NAT routers may include a SIP Application Layer Gateway (ALG). A SIP ALG allows SIP calls to pass through NAT by examining and translating IP addresses embedded in the data stream. When the VMG registers with the SIP register server, the SIP ALG translates the VMG's private IP address inside the SIP data stream to a public IP address. You do not need to use STUN or an outbound proxy if your VMG is behind a SIP ALG.

Use this screen to enable and disable the NAT and SIP (VoIP) ALG in the VMG. To access this screen, click **Network Setting > NAT > ALG**.

Figure 85 Network Setting > NAT > ALG

NAT ALG: Enable Disable (settings are invalid when disabled)

SIP ALG: Enable Disable

RTSP ALG: Enable Disable

PPTP ALG: Enable Disable

IPSEC ALG: Enable Disable

Apply Cancel

The following table describes the fields in this screen.

Table 63 Network Setting > NAT > ALG

LABEL	DESCRIPTION
NAT ALG	Enable this to make sure applications such as FTP and file transfer in IM applications work correctly with port-forwarding and address-mapping rules.
SIP ALG	Enable this to make sure SIP (VoIP) works correctly with port-forwarding and address-mapping rules.
RTSP ALG	Enable this to have the VMG detect RTSP traffic and help build RTSP sessions through its NAT. The Real Time Streaming (media control) Protocol (RTSP) is a remote control for multimedia on the Internet.
PPTP ALG	Enable this to turn on the PPTP ALG on the VMG to detect PPTP traffic and helps build PPTP sessions through the VMG's NAT.
IPSEC ALG	Enable this to turn on the IPsec ALG on the VMG to detect IPsec traffic and helps build IPsec sessions through the VMG's NAT.
Apply	Click Apply to save your changes.
Cancel	Click Cancel to restore your previously saved settings.

11.7 The Address Mapping Screen

Ordering your rules is important because the VMG applies the rules in the order that you specify. When a rule matches the current packet, the VMG takes the corresponding action and the remaining rules are ignored.

Click **Network Setting > NAT > Address Mapping** to display the following screen.

Figure 86 Network Setting > NAT > Address Mapping

Add new rule

Set	Local Start IP	Local End IP	Global Start IP	Global End IP	Type	Wan Interface Name	Modify
-----	----------------	--------------	-----------------	---------------	------	--------------------	--------

The following table describes the fields in this screen.

Table 64 Network Setting > NAT > Address Mapping

LABEL	DESCRIPTION
Add new rule	Click this to create a new rule.
Set	This is the index number of the address mapping set.
Local Start IP	This is the starting Inside Local IP Address (ILA).
Local End IP	This is the ending Inside Local IP Address (ILA). If the rule is for all local IP addresses, then this field displays 0.0.0.0 as the Local Start IP address and 255.255.255.255 as the Local End IP address. This field is blank for One-to-One mapping types.
Global Start IP	This is the starting Inside Global IP Address (IGA). Enter 0.0.0.0 here if you have a dynamic IP address from your ISP. You can only do this for the Many-to-One mapping type.
Global End IP	This is the ending Inside Global IP Address (IGA). This field is blank for One-to-One and Many-to-One mapping types.
Type	This is the address mapping type. One-to-One: This mode maps one local IP address to one global IP address. Note that port numbers do not change for the One-to-one NAT mapping type. Many-to-One: This mode maps multiple local IP addresses to one global IP address. This is equivalent to SUA (i.e., PAT, port address translation), the VMG's Single User Account feature that previous routers supported only. Many-to-Many: This mode maps multiple local IP addresses to shared global IP addresses.
Wan Interface Name	This is the WAN interface to which the address mapping rule applies.
Modify	Click the Edit icon to go to the screen where you can edit the address mapping rule. Click the Delete icon to delete an existing address mapping rule. Note that subsequent address mapping rules move up by one when you take this action.

11.7.1 Add/Edit Address Mapping Rule

To add or edit an address mapping rule, click **Add new rule** or the rule's edit icon in the **Address Mapping** screen to display the screen shown next.

Figure 87 Address Mapping: Add/Edit

The following table describes the fields in this screen.

Table 65 Address Mapping: Add/Edit

LABEL	DESCRIPTION
Type	Choose the IP/port mapping type from one of the following. One-to-One: This mode maps one local IP address to one global IP address. Note that port numbers do not change for the One-to-one NAT mapping type. Many-to-One: This mode maps multiple local IP addresses to one global IP address. This is equivalent to SUA (i.e., PAT, port address translation), the VMG's Single User Account feature that previous routers supported only. Many-to-Many: This mode maps multiple local IP addresses to shared global IP addresses.
Local Start IP	Enter the starting Inside Local IP Address (ILA).
Local End IP	Enter the ending Inside Local IP Address (ILA). If the rule is for all local IP addresses, then this field displays 0.0.0.0 as the Local Start IP address and 255.255.255.255 as the Local End IP address. This field is blank for One-to-One mapping types.
Global Start IP	Enter the starting Inside Global IP Address (IGA). Enter 0.0.0.0 here if you have a dynamic IP address from your ISP. You can only do this for the Many-to-One mapping type.
Global End IP	Enter the ending Inside Global IP Address (IGA). This field is blank for One-to-One and Many-to-One mapping types.
Set	Select the number of the mapping set for which you want to configure.
WAN Interface	Select a WAN interface to which the address mapping rule applies.
OK	Click OK to save your changes.
Cancel	Click Cancel to exit this screen without saving.

11.8 The Sessions Screen

Use this screen to limit the number of concurrent NAT sessions a client can use. Click **Network Setting > NAT > Sessions** to display the following screen.

Figure 88 Network Setting > NAT > Sessions

MAX NAT Session Per Host:

Note:
Enter session number and click "Apply" to activate this feature.
Clear the session number field and click "Apply" to deactivate this feature.

The following table describes the fields in this screen.

Table 66 Network Setting > NAT > Sessions

LABEL	DESCRIPTION
WAX NAT Session Per Host	Use this field to set a limit to the number of concurrent NAT sessions each client host can have. If only a few clients use peer to peer applications, you can raise this number to improve their performance. With heavy peer-to-peer application use, lower this number to ensure no single client uses too many of the available NAT sessions.
Apply	Click this to save your changes on this screen.
Cancel	Click this to exit this screen without saving any changes.

11.9 Technical Reference

This part contains more information regarding NAT.

11.9.1 NAT Definitions

Inside/outside denotes where a host is located relative to the VMG, for example, the computers of your subscribers are the inside hosts, while the web servers on the Internet are the outside hosts.

Global/local denotes the IP address of a host in a packet as the packet traverses a router, for example, the local address refers to the IP address of a host when the packet is in the local network, while the global address refers to the IP address of the host when the same packet is traveling in the WAN side.

Note that inside/outside refers to the location of a host, while global/local refers to the IP address of a host used in a packet. Thus, an inside local address (ILA) is the IP address of an inside host in a packet when the packet is still in the local network, while an inside global address (IGA) is the IP address of the same inside host when the packet is on the WAN side. The following table summarizes this information.

Table 67 NAT Definitions

ITEM	DESCRIPTION
Inside	This refers to the host on the LAN.
Outside	This refers to the host on the WAN.
Local	This refers to the packet address (source or destination) as the packet travels on the LAN.
Global	This refers to the packet address (source or destination) as the packet travels on the WAN.

NAT never changes the IP address (either local or global) of an outside host.

11.9.2 What NAT Does

In the simplest form, NAT changes the source IP address in a packet received from a subscriber (the inside local address) to another (the inside global address) before forwarding the packet to the WAN side. When the response comes back, NAT translates the destination address (the inside global address) back to the inside local address before forwarding it to the original inside host. Note that the IP address (either local or global) of an outside host is never changed.

The global IP addresses for the inside hosts can be either static or dynamically assigned by the ISP. In addition, you can designate servers, for example, a web server and a telnet server, on your local network and make them accessible to the outside world. If you do not define any servers (for Many-to-One and Many-to-Many Overload mapping), NAT offers the additional benefit of firewall protection. With no servers defined, your VMG filters out all incoming inquiries, thus preventing intruders from probing your network. For more information on IP address translation, refer to *RFC 1631, The IP Network Address Translator (NAT)*.

11.9.3 How NAT Works

Each packet has two addresses – a source address and a destination address. For outgoing packets, the ILA (Inside Local Address) is the source address on the LAN, and the IGA (Inside Global Address) is the source address on the WAN. For incoming packets, the ILA is the destination address on the LAN, and the IGA is the destination address on the WAN. NAT maps private (local) IP addresses to globally unique ones required for communication with hosts on other networks. It replaces the original IP source address (and TCP or UDP source port numbers for Many-to-One and Many-to-Many Overload NAT mapping) in each packet and then forwards it to the Internet. The VMG keeps track of the original addresses and port numbers so incoming reply packets can have their original values restored. The following figure illustrates this.

Figure 89 How NAT Works

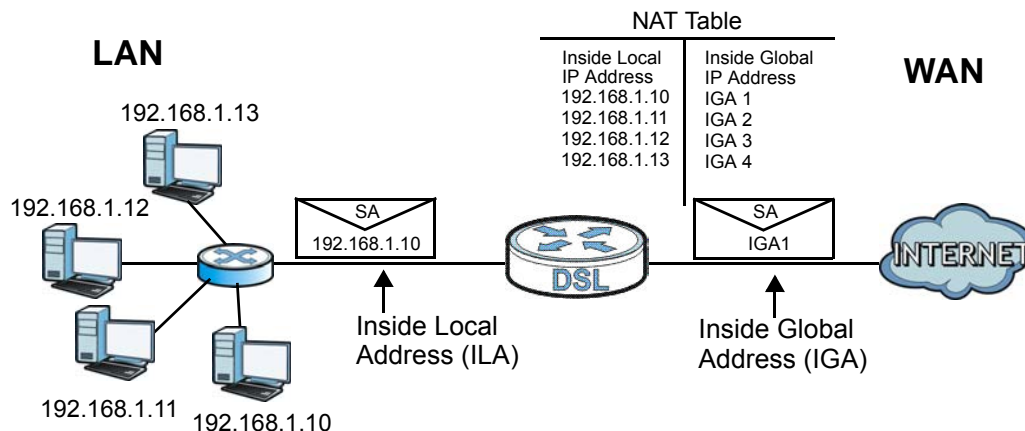

11.9.4 NAT Application

The following figure illustrates a possible NAT application, where three inside LANs (logical LANs using IP alias) behind the VMG can communicate with three distinct WAN networks.

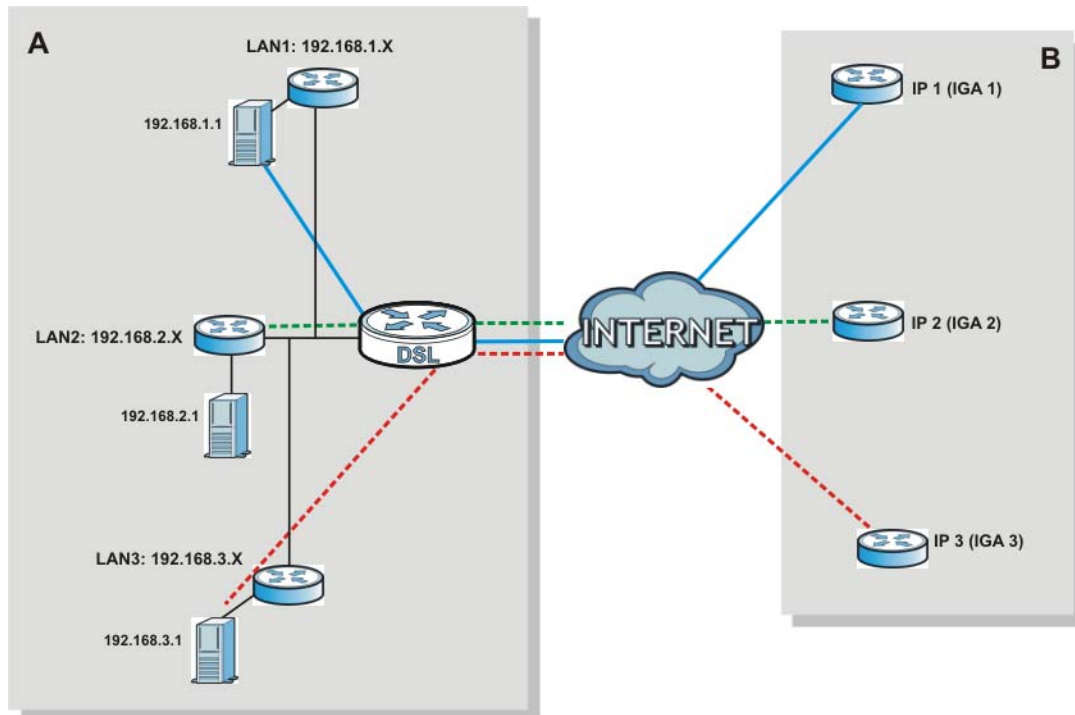
Figure 90 NAT Application With IP Alias

Port Forwarding: Services and Port Numbers

The most often used port numbers are shown in the following table. Please refer to RFC 1700 for further information about port numbers. Please also refer to the Supporting CD for more examples and details on port forwarding and NAT.

Table 68 Services and Port Numbers

SERVICES	PORT NUMBER
ECHO	7
FTP (File Transfer Protocol)	21
SMTP (Simple Mail Transfer Protocol)	25
DNS (Domain Name System)	53
Finger	79
HTTP (Hyper Text Transfer protocol or WWW, Web)	80
POP3 (Post Office Protocol)	110
NNTP (Network News Transport Protocol)	119
SNMP (Simple Network Management Protocol)	161
SNMP trap	162
PPTP (Point-to-Point Tunneling Protocol)	1723

Port Forwarding Example

Let's say you want to assign ports 21-25 to one FTP, Telnet and SMTP server (**A** in the example), port 80 to another (**B** in the example) and assign a default server IP address of 192.168.1.35 to a

third (C in the example). You assign the LAN IP addresses and the ISP assigns the WAN IP address. The NAT network appears as a single host on the Internet.

Figure 91 Multiple Servers Behind NAT Example

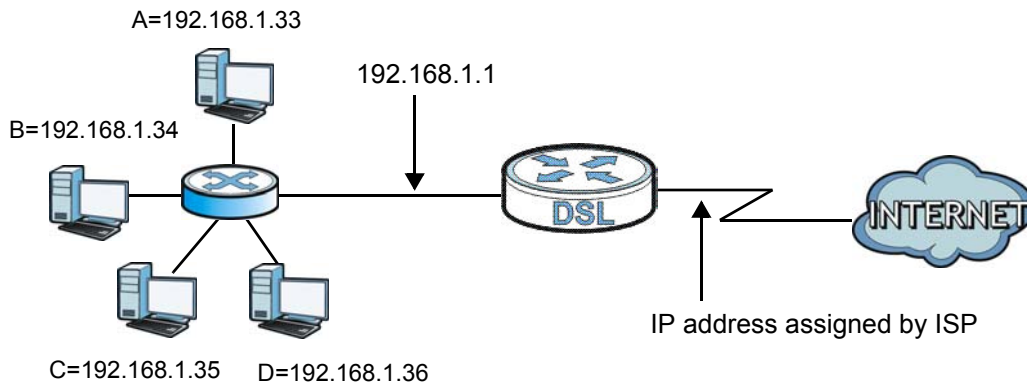

DNS Setup

12.1 Overview

DNS

DNS (Domain Name System) is for mapping a domain name to its corresponding IP address and vice versa. The DNS server is extremely important because without it, you must know the IP address of a machine before you can access it.

In addition to the system DNS server(s), each WAN interface (service) is set to have its own static or dynamic DNS server list. You can configure a DNS static route to forward DNS queries for certain domain names through a specific WAN interface to its DNS server(s). The VMG uses a system DNS server (in the order you specify in the **Broadband** screen) to resolve domain names that do not match any DNS routing entry. After the VMG receives a DNS reply from a DNS server, it creates a new entry for the resolved IP address in the routing table.

Dynamic DNS

Dynamic DNS allows you to update your current dynamic IP address with one or many dynamic DNS services so that anyone can contact you (in NetMeeting, CU-SeeMe, etc.). You can also access your FTP server or Web site on your own computer using a domain name (for instance myhost.dhs.org, where myhost is a name of your choice) that will never change instead of using an IP address that changes each time you reconnect. Your friends or relatives will always be able to call you even if they don't know your IP address.

First of all, you need to have registered a dynamic DNS account with www.dyndns.org. This is for people with a dynamic IP from their ISP or DHCP server that would still like to have a domain name. The Dynamic DNS service provider will give you a password or key.

12.1.1 What You Can Do in this Chapter

- Use the **DNS Entry** screen to view, configure, or remove DNS routes ([Section 12.2 on page 174](#)).
- Use the **Dynamic DNS** screen to enable DDNS and configure the DDNS settings on the VMG ([Section 12.3 on page 175](#)).

12.1.2 What You Need To Know

DYNDNS Wildcard

Enabling the wildcard feature for your host causes *.yourhost.dyndns.org to be aliased to the same IP address as yourhost.dyndns.org. This feature is useful if you want to be able to use, for example, www.yourhost.dyndns.org and still reach your hostname.

If you have a private WAN IP address, then you cannot use Dynamic DNS.

12.2 The DNS Entry Screen

Use this screen to view and configure DNS routes on the VMG. Click **Network Setting > DNS** to open the **DNS Entry** screen.

Figure 92 Network Setting > DNS > DNS Entry

#	HostName	IP Address	Modify
<p>Note: The hostnames needs combination of the host's local name with its domain's name. For example, Mycomputer.home consists of a local hostname (Mycomputer) and the domain name (home).</p>			

The following table describes the fields in this screen.

Table 69 Network Setting > DNS > DNS Entry

LABEL	DESCRIPTION
Add New DNS Entry	Click this to create a new DNS entry.
#	This is the index number of the entry.
Hostname	This indicates the host name or domain name.
IP Address	This indicates the IP address assigned to this computer.
Modify	Click the Edit icon to edit the rule. Click the Delete icon to delete an existing rule.

12.2.1 Add/Edit DNS Entry

You can manually add or edit the VMG's DNS name and IP address entry. Click **Add New DNS Entry** in the **DNS Entry** screen or the **Edit** icon next to the entry you want to edit. The screen shown next appears.

Figure 93 DNS Entry: Add/Edit

DNS Entry Configuration

Host Name :

IPv4 Address :

OK Cancel

The following table describes the labels in this screen.

Table 70 DNS Entry: Add/Edit

LABEL	DESCRIPTION
Host Name	Enter the host name of the DNS entry.
IPv4 Address	Enter the IP address of the DNS entry.
OK	Click OK to save your changes.
Cancel	Click Cancel to exit this screen without saving.

12.3 The Dynamic DNS Screen

Use this screen to change your VMG's DDNS. Click **Network Setting > DNS > Dynamic DNS**. The screen appears as shown.

Figure 94 Network Setting > DNS > Dynamic DNS

The following table describes the fields in this screen.

Table 71 Network Setting > DNS > > Dynamic DNS

LABEL	DESCRIPTION
Dynamic DNS Setup	
Dynamic DNS	Select Enable to use dynamic DNS.
Service Provider	Select your Dynamic DNS service provider from the drop-down list box.
Host Name	Type the domain name assigned to your VMG by your Dynamic DNS provider. You can specify up to two host names in the field separated by a comma (",").
Username	Type your user name.
Password	Type the password assigned to you.
Dynamic DNS Status	
User Authentication Result	This shows Success if the account is correctly set up with the Dynamic DNS provider account.
Last Updated Time	This shows the last time the IP address the Dynamic DNS provider has associated with the hostname was updated.
Current Dynamic IP	This shows the IP address your Dynamic DNS provider has currently associated with the hostname.

Table 71 Network Setting > DNS > > Dynamic DNS (continued)

LABEL	DESCRIPTION
Apply	Click Apply to save your changes.
Cancel	Click Cancel to exit this screen without saving.

13.1 Overview

Use the **IGMP/MLD** screen to configure IGMP/MLD group settings.

13.1.1 What You Need To Know

Multicast and IGMP

See [Multicast on page 83](#) for more information.

Multicast Listener Discovery (MLD)

The Multicast Listener Discovery (MLD) protocol (defined in RFC 2710) is derived from IPv4's Internet Group Management Protocol version 2 (IGMPv2). MLD uses ICMPv6 message types, rather than IGMP message types. MLDv1 is equivalent to IGMPv2 and MLDv2 is equivalent to IGMPv3.

- MLD allows an IPv6 switch or router to discover the presence of MLD hosts who wish to receive multicast packets and the IP addresses of multicast groups the hosts want to join on its network.
- MLD snooping and MLD proxy are analogous to IGMP snooping and IGMP proxy in IPv4.
- MLD filtering controls which multicast groups a port can join.
- An MLD Report message is equivalent to an IGMP Report message, and a MLD Done message is equivalent to an IGMP Leave message.

IGMP Fast Leave

When a host leaves a multicast group (224.1.1.1), it sends an IGMP leave message to inform all routers (224.0.0.2) in the multicast group. When a router receives the leave message, it sends a specific query message to all multicast group (224.1.1.1) members to check if any other hosts are still in the group. Then the router deletes the host's information.

With the IGMP fast leave feature enabled, the router removes the host's information from the group member list once it receives a leave message from a host and the fast leave timer expires.

13.2 The IGMP/MLD Screen

Use this screen to configure multicast groups the VMG has joined and which ports have joined it. To open this screen, click **Network Setting > IGMP/MLD**.

Figure 95 Network Setting > IGMP/MLD

IGMP Configuration	
Default Version :	<input type="text" value="3"/>
Query Interval :	<input type="text" value="125"/>
Query Response Interval :	<input type="text" value="10"/>
Last Member Query Interval :	<input type="text" value="10"/>
Robustness Value :	<input type="text" value="2"/>
Maximum Multicast Groups :	<input type="text" value="25"/>
Maximum Multicast Data Sources (for IGMPv3 : (1-24)) :	<input type="text" value="10"/>
Maximum Multicast Group Members :	<input type="text" value="25"/>
Fast Leave Enable :	<input checked="" type="checkbox"/>
LAN to LAN (Intra LAN) Multicast Enable :	<input checked="" type="checkbox"/>
Membership Join Immediate (IPTV) :	<input checked="" type="checkbox"/>
MLD Configuration	
Default Version :	<input type="text" value="2"/>
Query Interval :	<input type="text" value="125"/>
Query Response Interval :	<input type="text" value="10"/>
Last Member Query Interval :	<input type="text" value="10"/>
Robustness Value :	<input type="text" value="2"/>
Maximum Multicast Groups :	<input type="text" value="10"/>
Maximum Multicast Data Sources (for mldv2) :	<input type="text" value="10"/>
Maximum Multicast Group Members :	<input type="text" value="10"/>
Fast Leave Enable :	<input checked="" type="checkbox"/>
LAN to LAN (Intra LAN) Multicast Enable :	<input checked="" type="checkbox"/>
<input type="button" value="Apply"/> <input type="button" value="Cancel"/>	

The following table describes the labels in this screen.

Table 72 Network Setting > IGMP/MLD

LABEL	DESCRIPTION
IGMP/MLD Configuration	
Default Version	Enter the version of IGMP (1~3) and MLD (1~2) that you want the VMG to use on the WAN.
Query Interval	Enter the number of seconds the VMG sends a query message to hosts to get the group membership information.
Query Response Interval	Enter the maximum number of seconds the VMG can wait for receiving a General Query message. Multicast routers use general queries to learn which multicast groups have members.
Last Member Query Interval	Enter the maximum number of seconds the VMG can wait for receiving a response to a Group-Specific Query message. Multicast routers use group-specific queries to learn whether any member remains in a specific multicast group.
Robustness Value	Enter the number of times (1~7) the VMG can resend a packet if packet loss occurs due to network congestion.
Maximum Multicast Groups	Enter a number to limit the number of multicast groups an interface on the VMG is allowed to join. Once a multicast member is registered in the specified number of multicast groups, any new IGMP or MLD join report frames are dropped by the interface.
Maximum Multicast Data Sources	Enter a number to limit the number of multicast data sources (1-24) a multicast group is allowed to have. Note: The setting only works for IGMPv3 and MLDv2.

Table 72 Network Setting > IGMP/MLD (continued)

LABEL	DESCRIPTION
Maximum Multicast Group Members	Enter a number to limit the number of multicast members a multicast group can have.
Fast Leave Enable	Select this option to set the VMG to remove a port from the multicast tree immediately (without sending an IGMP or MLD membership query message) once it receives an IGMP or MLD leave message. This is helpful if a user wants to quickly change a TV channel (multicast group change) especially for IPTV applications.
LAN to LAN (Intra LAN) Multicast Enable	Select this to enable LAN to LAN IGMP snooping capability.
Membership Join Immediate (IPTV)	Select this to have the VMG add a host to a multicast group immediately once the VMG receives an IGMP or MLD join message.
Apply	Click Apply to save your changes back to the VMG.
Cancel	Click Cancel to exit this screen without saving.

VLAN Group

14.1 Overview

Virtual LAN IDs are used to identify different traffic types over the same physical link.

In the following example, the VMG (DSL) can use VLAN IDs (VID) 100 and 200 to identify Video-on-Demand and IPTV traffic respectively coming from the two VoD and IPTV multicast servers. The VMG (DSL) can also tag outgoing requests to these servers with these VLAN IDs.

Figure 96 VLAN Group Example

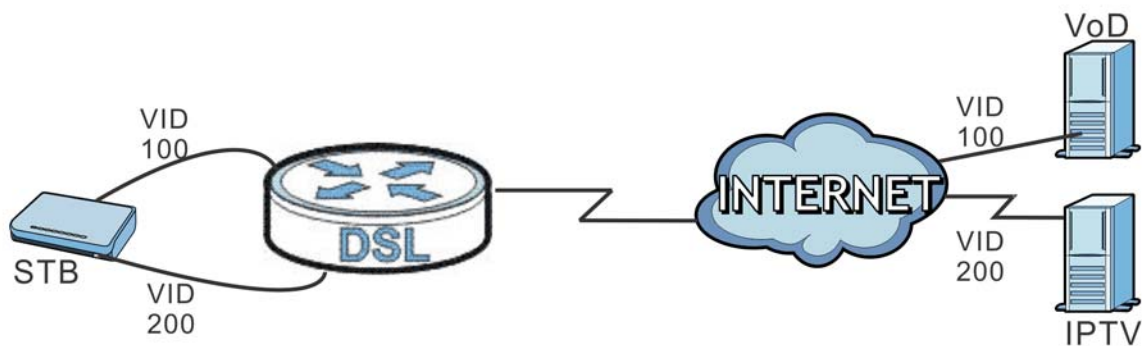

14.1.1 What You Can Do in this Chapter

Use these screens to group separate VLAN groups together to be treated as one VLAN group.

14.2 The Vlan Group Screen

Click **Network Setting > Vlan Group** to open the following screen.

Figure 97 Network Setting > Vlan Group

Add New VLAN Group				
#	Group Name	VLAN ID	Interfaces	Modify
1	GP1	123	LAN1T, LAN2U	

The following table describes the fields in this screen.

Table 73 Network Setting > Vlan Group

LABEL	DESCRIPTION
Add New VLAN Group	Click this button to create a new VLAN group.
#	This is the index number of the VLAN group.
Group Name	This shows the descriptive name of the VLAN group.
VLAN ID	This shows the unique ID number that identifies the VLAN group.
Interfaces	This shows the LAN ports included in the VLAN group and if traffic leaving the port will be tagged with the VLAN ID.
Modify	Click the Edit icon to change an existing VLAN group setting or click the Delete icon to remove the VLAN group.

14.2.1 Add/Edit a VLAN Group

Click the **Add New VLAN Group** button in the **Vlan Group** screen to open the following screen. Use this screen to create a new VLAN group.

Figure 98 Add/Edit VLAN Group

The following table describes the fields in this screen.

Table 74 Add/Edit VLAN Group

LABEL	DESCRIPTION
VLAN Group Name	Enter a name to identify this group. You can enter up to 30 characters. You can use letters, numbers, hyphens (-) and underscores (_). Spaces are not allowed.
VLAN ID	Enter a unique ID number, from 1 to 4,094, to identify this VLAN group. Outgoing traffic is tagged with this ID if Txtagging is selected below.
LANx	Select Include to add the associated LAN interface to this VLAN group. Select Txtagging to tag outgoing traffic from the associated LAN port with the VLAN ID number entered above. Note: LAN5 displays if the WAN port was configured as a LAN port in the Home Networking > 5th Ethernet port screen.

Table 74 Add/Edit VLAN Group (continued)

LABEL	DESCRIPTION
OK	Click OK to save your changes back to the VMG.
Cancel	Click Cancel to exit this screen without saving.

Interface Group

15.1 Overview

By default, all LAN and WAN interfaces on the VMG are in the same group and can communicate with each other. Create interface groups to have the VMG assign the IP addresses in different domains to different groups. Each group acts as an independent network on the VMG. This lets devices connected to an interface group's LAN interfaces communicate through the interface group's WAN or LAN interfaces but not other WAN or LAN interfaces.

15.1.1 What You Can Do in this Chapter

The **Interface Group** screens let you create multiple networks on the VMG ([Section 15.2 on page 183](#)).

15.2 The Interface Group Screen

You can manually add a LAN interface to a new group. Alternatively, you can have the VMG automatically add the incoming traffic and the LAN interface on which traffic is received to an interface group when its DHCP Vendor ID option information matches one listed for the interface group.

Use the **LAN** screen to configure the private IP addresses the DHCP server on the VMG assigns to the clients in the default and/or user-defined groups. If you set the VMG to assign IP addresses based on the client's DHCP Vendor ID option information, you must enable DHCP server and configure LAN TCP/IP settings for both the default and user-defined groups. See [Chapter 8 on page 116](#) for more information.

In the following example, the client that sends packets with the DHCP Vendor ID option set to MSFT 5.0 (meaning it is a Windows 2000 DHCP client) is assigned the IP address 192.168.2.2 and uses the WAN VDSL_PoE/ppp0.1 interface.

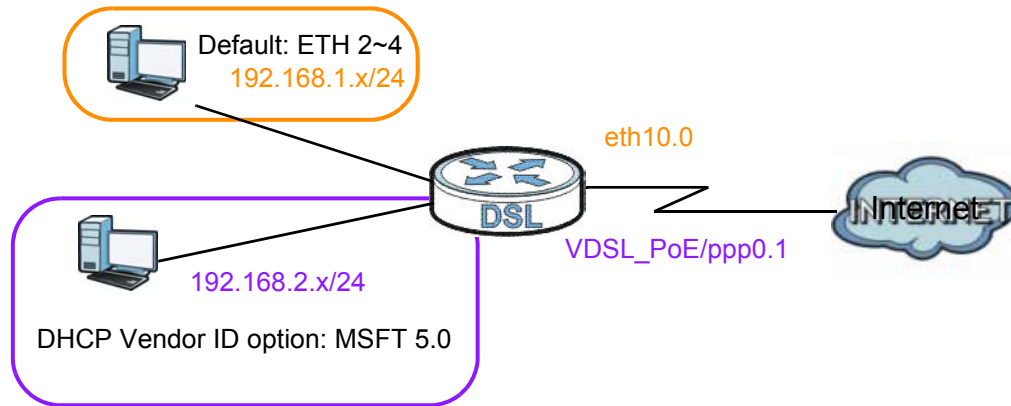
Figure 99 Interface Grouping Application

Click **Network Setting > Interface Group** to open the following screen.

Figure 100 Network Setting > Interface Group

Add New Interface Group				
Group Name	WAN Interface	LAN Interfaces	Criteria	Modify
Default	Any Wan	LAN1,LAN2,LAN3,LAN4,ZyXEL_0002,ZyXEL_0002_5G		

The following table describes the fields in this screen.

Table 75 Network Setting > Interface Group

LABEL	DESCRIPTION
Add New Interface Group	Click this button to create a new interface group.
Group Name	This shows the descriptive name of the group.
WAN Interface	This shows the WAN interfaces in the group.
LAN Interfaces	This shows the LAN interfaces in the group.
Criteria	This shows the filtering criteria for the group.
Modify	Click the Delete icon to remove the group.

15.2.1 Interface Group Configuration

Click the **Add New Interface Group** button in the **Interface Group** screen to open the following screen. Use this screen to create a new interface group.

Note: An interface can belong to only one group at a time.

Figure 101 Interface Group Configuration

The following table describes the fields in this screen.

Table 76 Interface Group Configuration

LABEL	DESCRIPTION
Group Name	Enter a name to identify this group. You can enter up to 30 characters. You can use letters, numbers, hyphens (-) and underscores (_). Spaces are not allowed.
WAN Interfaces used in the grouping	Select the WAN interface this group uses. The group can have up to one PTM interface, up to one ATM interface and up to one ETH interface. Select None to not add a WAN interface to this group.
Grouped LAN Interfaces Available LAN Interfaces	Select one or more LAN interfaces (Ethernet LAN, HPNA or wireless LAN) in the Available LAN Interfaces list and use the left arrow to move them to the Grouped LAN Interfaces list to add the interfaces to this group. To remove a LAN or wireless LAN interface from the Grouped LAN Interfaces , use the right-facing arrow.
Automatically Add Clients With the following DHCP Vendor IDs	Click Add to identify LAN hosts to add to the interface group by criteria such as the type of the hardware or firmware. See Section 15.2.2 on page 186 for more information.
#	This shows the index number of the rule.
Filter Criteria	This shows the filtering criteria. The LAN interface on which the matched traffic is received will belong to this group automatically.
WildCard Support	This shows if wildcard on DHCP option 60 is enabled.
Remove	Click the Remove icon to delete this rule from the VMG.
OK	Click OK to save your changes back to the VMG.
Cancel	Click Cancel to exit this screen without saving.

15.2.2 Interface Grouping Criteria

Click the **Add** button in the **Interface Grouping Configuration** screen to open the following screen.

Figure 102 Interface Grouping Criteria

The following table describes the fields in this screen.

Table 77 Interface Grouping Criteria

LABEL	DESCRIPTION
Source MAC Address	Select this option and enter the source MAC address of the packet.
DHCP Option 60	Select this option and enter the Vendor Class Identifier (Option 60) of the matched traffic, such as the type of the hardware or firmware.
Enable wildcard	Select this option to be able to use wildcards in the Vendor Class Identifier configured for DHCP option 60.
DHCP Option 61	Select this and enter the device identity of the matched traffic.
IAID	Enter the Identity Association Identifier (IAID) of the device, for example, the WAN connection index number.
DUID type	Select DUID-LLT (DUID Based on Link-layer Address Plus Time) to enter the hardware type, a time value and the MAC address of the device. Select DUID-EN (DUID Assigned by Vendor Based upon Enterprise Number) to enter the vendor's registered enterprise number. Select DUID-LL (DUID Based on Link-layer Address) to enter the device's hardware type and hardware address (MAC address) in the following fields. Select Other to enter any string that identifies the device in the field provided.
Hardware Type	Enter the device's hardware type, assigned by the IANA.
Time	Enter the time that the DUID is generated.
Link-layer address	Enter the VMG's hardware address, that is the MAC address.
Enterprise Number	Enter the vendor's registered private enterprise number.

Table 77 Interface Grouping Criteria (continued)

LABEL	DESCRIPTION
Identifier	Enter a unique identifier assigned by the vendor. This field is available when you select DUID-EN in the DUID type field.
DHCP Option 125	Select this and enter vendor specific information of the matched traffic.
Enterprise Number	Enter the vendor's 32-bit enterprise number registered with the IANA (Internet Assigned Numbers Authority).
Manufacturer OUI	Specify the vendor's OUI (Organization Unique Identifier). It is usually the first three bytes of the MAC address.
Product Class	Enter the product class of the device.
Model Name	Enter the model name of the device.
Serial Number	Enter the serial number of the device.
VLAN Group	Select this and choose a pre-defined VLAN group.
OK	Click OK to save your changes back to the VMG.
Cancel	Click Cancel to exit this screen without saving.

USB Service

16.1 Overview

You can share files on a USB memory stick or hard drive connected to your VMG with users on your network.

The following figure is an overview of the VMG's file server feature. Computers **A** and **B** can access files on a USB device (**C**) which is connected to the VMG.

Figure 103 File Sharing Overview

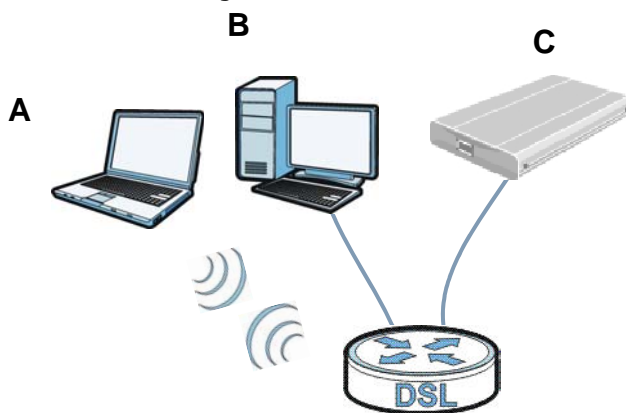

The VMG will not be able to join the workgroup if your local area network has restrictions set up that do not allow devices to join a workgroup. In this case, contact your network administrator.

16.1.1 What You Can Do in this Chapter

- Use the **File Sharing** screen to enable file-sharing server ([Section 16.1.3 on page 189](#)).
- Use the **Media Server** screen to enable or disable the sharing of media files ([Section 16.3 on page 191](#)).

16.1.2 What You Need To Know

The following terms and concepts may help as you read this chapter.

16.1.2.1 About File Sharing

Workgroup name

This is the name given to a set of computers that are connected on a network and share resources such as a printer or files. Windows automatically assigns the workgroup name when you set up a network.

Shares

When settings are set to default, each USB device connected to the VMG is given a folder, called a "share". If a USB hard drive connected to the VMG has more than one partition, then each partition will be allocated a share. You can also configure a "share" to be a sub-folder or file on the USB device.

File Systems

A file system is a way of storing and organizing files on your hard drive and storage device. Often different operating systems such as Windows or Linux have different file systems. The file sharing feature on your VMG supports File Allocation Table (FAT) and FAT32.

Common Internet File System

The VMG uses Common Internet File System (CIFS) protocol for its file sharing functions. CIFS compatible computers can access the USB file storage devices connected to the VMG. CIFS protocol is supported on Microsoft Windows, Linux Samba and other operating systems (refer to your systems specifications for CIFS compatibility).

16.1.3 Before You Begin

Make sure the VMG is connected to your network and turned on.

- 1 Connect the USB device to one of the VMG's USB port. Make sure the VMG is connected to your network.
- 2 The VMG detects the USB device and makes its contents available for browsing. If you are connecting a USB hard drive that comes with an external power supply, make sure it is connected to an appropriate power source that is on.

Note: If your USB device cannot be detected by the VMG, see the troubleshooting for suggestions.

16.2 The File Sharing Screen

Use this screen to set up file sharing through the VMG. The VMG's LAN users can access the shared folder (or share) from the USB device inserted in the VMG. To access this screen, click **Network Setting > USB Service > File Sharing**.

Figure 104 Network Setting > USB Service > File Sharing

Information

Volume	Capacity	Used Space
--------	----------	------------

Server Configuration

File Sharing Services: Enable Disable

Account Management



Add New User

Active	Status	User Name	Modify
--------	--------	-----------	--------

Apply Cancel

Each field is described in the following table.

Table 78 Network Setting > USB Service > File Sharing

LABEL	DESCRIPTION
Information	
Volume	This is the volume name the VMG gives to an inserted USB device.
Capacity	This is the total available memory size (in megabytes) on the USB device.
Used Space	This is the memory size (in megabytes) already used on the USB device.
Server Configuration	
File Sharing Services	Select Enable to activate file sharing through the VMG.
Account Management	
Add New User	Click this button to create a user account to access the secured shares.
Active	Select this to allow the user to access the secured shares.
Status	This field shows the status of the user.  : The user account is not activated for the share.  : The user account is activated for the share.
User Name	This is the name of a user who is allowed to access the secured shares on the USB device.
Modify	Click the Edit icon to modify the user account. Click the Delete icon to remove the user account from the VMG.
Apply	Click this to save your changes to the VMG.
Cancel	Click this to restore your previously saved settings.

16.2.1 The Add New User Screen

Use this screen to create a user account that can access the secured shares on the USB device. To access this screen, click the **Add New User** button in the **Network Setting > USB Service > File Sharing** screen.

Figure 105 Network Setting > USB Service > File Sharing > Add new user

Each field is described in the following table.

Table 79 Network Setting > USB Service > File Sharing > Add new user

LABEL	DESCRIPTION
User Name	Enter a user name. You can enter up to 16 characters. Only letters and numbers allowed.
New Password	Enter the password used to access the secured share. The password must be 5 to 15 characters long. Only letters and numbers are allowed. The password is case sensitive.
Retype New Password	Retype the password that you entered above.
Apply	Click this to save your changes to the VMG.
Cancel	Click Cancel to exit this screen without saving.

16.3 The Media Server Screen

The media server feature lets anyone on your network play video, music, and photos from the USB storage device connected to your VMG (without having to copy them to another computer). The VMG can function as a DLNA-compliant media server. The VMG streams files to DLNA-compliant media clients (like Windows Media Player). The Digital Living Network Alliance (DLNA) is a group of personal computer and electronics companies that works to make products compatible in a home network.

The VMG media server enables you to:

- Publish all shares for everyone to play media files in the USB storage device connected to the VMG.
- Use hardware-based media clients like the DMA-2500 to play the files.

Note: Anyone on your network can play the media files in the published shares. No user name and password or other form of security is used. The media server is enabled by default with the video, photo, and music shares published.

To change your VMG's media server settings, click **Network Setting > USB Service > Media Server**. The screen appears as shown.

Figure 106 Network Setting > USB Service > Media Server

Media Server:	<input type="radio"/> Enable <input checked="" type="radio"/> Disable
Interface:	Default ▼
Media Library Path:	/mnt/
<input type="button" value="Apply"/> <input type="button" value="Cancel"/>	

The following table describes the labels in this menu.

Table 80 Network Setting > USB Service > Media Server

LABEL	DESCRIPTION
Media Server	Select Enable to have the VMG function as a DLNA-compliant media server. Enable the media server to let (DLNA-compliant) media clients on your network play media files located in the shares.
Interface	Select an interface on which you want to enable the media server function.
Media Library Path	Enter the path clients use to access the media files on a USB storage device connected to the VMG.
Apply	Click Apply to save your changes.
Cancel	Click Cancel to restore your previously saved settings.

17.1 Overview

This chapter shows you how to enable and configure the VMG's security settings. Use the firewall to protect your VMG and network from attacks by hackers on the Internet and control access to it. By default the firewall:

- allows traffic that originates from your LAN computers to go to all other networks.
- blocks traffic that originates on other networks from going to the LAN.

The following figure illustrates the default firewall action. User **A** can initiate an IM (Instant Messaging) session from the LAN to the WAN (1). Return traffic for this session is also allowed (2). However other traffic initiated from the WAN is blocked (3 and 4).

Figure 107 Default Firewall Action

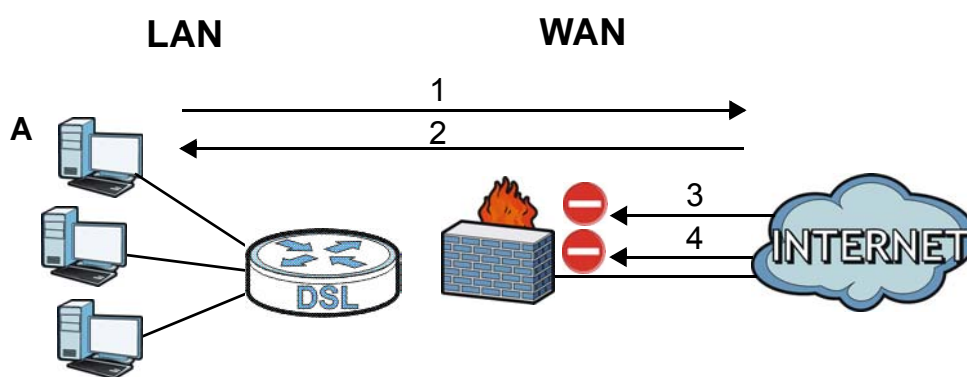

17.1.1 What You Can Do in this Chapter

- Use the **General** screen to configure the security level of the firewall on the VMG ([Section 17.2 on page 194](#)).
- Use the **Protocol** screen to add or remove predefined Internet services and configure firewall rules ([Section 17.3 on page 195](#)).
- Use the **Access Control** screen to view and configure incoming/outgoing filtering rules ([Section 17.4 on page 197](#)).
- Use the **DoS** screen to activate protection against Denial of Service (DoS) attacks ([Section 17.5 on page 199](#)).

17.1.2 What You Need to Know

SYN Attack

A SYN attack floods a targeted system with a series of SYN packets. Each packet causes the targeted system to issue a SYN-ACK response. While the targeted system waits for the ACK that follows the SYN-ACK, it queues up all outstanding SYN-ACK responses on a backlog queue. SYN-ACKs are moved off the queue only when an ACK comes back or when an internal timer terminates the three-way handshake. Once the queue is full, the system will ignore all incoming SYN requests, making the system unavailable for legitimate users.

DoS

Denials of Service (DoS) attacks are aimed at devices and networks with a connection to the Internet. Their goal is not to steal information, but to disable a device or network so users no longer have access to network resources. The VMG is pre-configured to automatically detect and thwart all known DoS attacks.

DDoS

A DDoS attack is one in which multiple compromised systems attack a single target, thereby causing denial of service for users of the targeted system.

LAND Attack

In a LAND attack, hackers flood SYN packets into the network with a spoofed source IP address of the target system. This makes it appear as if the host computer sent the packets to itself, making the system unavailable while the target system tries to respond to itself.

Ping of Death

Ping of Death uses a "ping" utility to create and send an IP packet that exceeds the maximum 65,536 bytes of data allowed by the IP specification. This may cause systems to crash, hang or reboot.

SPI

Stateful Packet Inspection (SPI) tracks each connection crossing the firewall and makes sure it is valid. Filtering decisions are based not only on rules but also context. For example, traffic from the WAN may only be allowed to cross the firewall in response to a request from the LAN.

17.2 The Firewall Screen

Use this screen to set the security level of the firewall on the VMG. Firewall rules are grouped based on the direction of travel of packets to which they apply.

Click **Security** > **Firewall** to display the **General** screen.

Figure 108 Security > Firewall > General

IPv4 Firewall : Enable Disable
 IPv6 Firewall : Enable Disable

Low Medium (Recommended) High

	Low	Medium (Recommended)	High
LAN to WAN	✓	✓	✗
WAN to LAN	✓	✗	✗

Note:
 (1) LAN to WAN: Allow access to all internet services
 (2) WAN to LAN: Allow access from other computers on the Internet
 (3) When the security level is set to 'High', access to the following services is allowed: Telnet, FTP, HTTP, HTTPS, DNS, IMAP, POP3 and SMTP

Apply Cancel

The following table describes the labels in this screen.

Table 81 Security > Firewall > General

LABEL	DESCRIPTION
IPv4 Firewall	Select Enable to activate the firewall feature on the VMG.
IPv6 Firewall	
Low	Select Low to allow LAN to WAN and WAN to LAN packet directions.
Medium	Select Medium to allow LAN to WAN but deny WAN to LAN packet directions.
High	Select High to deny LAN to WAN and WAN to LAN packet directions.
Apply	Click Apply to save your changes.
Cancel	Click Cancel to restore your previously saved settings.

17.3 The Protocol Screen

You can configure customized services and port numbers in the **Protocol** screen. For a comprehensive list of port numbers and services, visit the IANA (Internet Assigned Number Authority) website. See [Appendix D on page 293](#) for some examples.

Click **Security > Firewall > Protocol** to display the following screen.

Figure 109 Security > Firewall > Protocol

Add New Protocol Entry

Name	Description	Ports/Protocol Number	Modify

Note:
 If a protocol rule is removed, related ACL rules will also be removed.

The following table describes the labels in this screen.

Table 82 Security > Firewall > Protocol

LABEL	DESCRIPTION
Add New Protocol Entry	Click this to add a new service.
Name	This is the name of your customized service.
Description	This is the description of your customized service.
Ports/Protocol Number	This shows the IP protocol (TCP , UDP , ICMP , or TCP/UDP) and the port number or range of ports that defines your customized service. Other and the protocol number displays if the service uses another IP protocol.
Modify	Click the Edit icon to edit the entry. Click the Delete icon to remove this entry.

17.3.1 Add/Edit a Protocol

Use this screen to add a customized service rule that you can use in the firewall's ACL rule configuration. Click **Add New Protocol Entry** or the edit icon next to an existing service rule in the **Protocol** screen to display the following screen.

Figure 110 Security > Firewall > Protocol: Add/Edit

The following table describes the labels in this screen.

Table 83 Security > Firewall > Protocol: Add/Edit

LABEL	DESCRIPTION
Protocol	Choose the IP protocol (TCP , UDP , ICMP , or Other) that defines your customized port from the drop-down list box. Select Other to be able to enter a protocol number.
Source Port/ Destination Port	These fields are displayed if you select TCP or UDP as the IP port. Select Single to specify one port only or Range to specify a span of ports that define your customized service. If you select Any , the service is applied to all ports. Type a single port number or the range of port numbers that define your customized service.
Protocol Number	This field is displayed if you select Other as the protocol. Enter the protocol number of your customized port.

Table 83 Security > Firewall > Protocol: Add/Edit (continued)

LABEL	DESCRIPTION
OK	Click OK to save your changes.
Cancel	Click Cancel to exit this screen without saving.

17.4 The Access Control Screen

Click **Security > Firewall > Access Control** to display the following screen. This screen displays a list of the configured incoming or outgoing filtering rules.

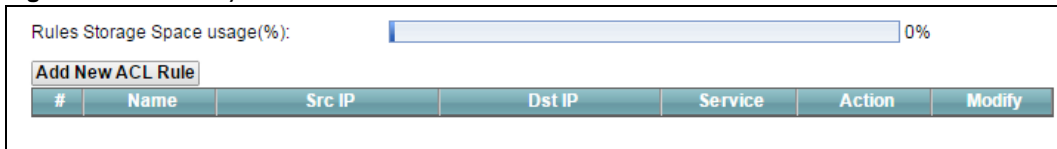
Figure 111 Security > Firewall > Access Control

The following table describes the labels in this screen.

Table 84 Security > Firewall > Access Control

LABEL	DESCRIPTION
Add New ACL Rule	Click this to go to add a filter rule for incoming or outgoing IP traffic.
#	This is the index number of the entry.
Name	This displays the name of the rule.
Src IP	This displays the source IP addresses to which this rule applies. Please note that a blank source address is equivalent to Any .
Dst IP	This displays the destination IP addresses to which this rule applies. Please note that a blank destination address is equivalent to Any .
Service	This displays the transport layer protocol that defines the service and the direction of traffic to which this rule applies.
Action	This field displays whether the rule silently discards packets (DROP), discards packets and sends a TCP reset packet or an ICMP destination-unreachable message to the sender (REJECT) or allows the passage of packets (ACCEPT).
Modify	Click the Edit icon to edit the rule. Click the Delete icon to delete an existing rule. Note that subsequent rules move up by one when you take this action. Click the Move To icon to change the order of the rule. Enter the number in the # field.

17.4.1 Add/Edit an ACL Rule

Click **Add new ACL rule** or the **Edit** icon next to an existing ACL rule in the **Access Control** screen. The following screen displays.

Figure 112 Access Control: Add/Edit

The following table describes the labels in this screen.

Table 85 Access Control: Add/Edit

LABEL	DESCRIPTION
Filter Name	Enter a descriptive name of up to 16 alphanumeric characters, not including spaces, underscores, and dashes. You must enter the filter name to add an ACL rule. This field is read-only if you are editing the ACL rule.
Order	Select the order of the ACL rule.
Select Source Device	Select the source device to which the ACL rule applies. If you select Specific IP Address , enter the source IP address in the field below.
Source IP Address	Enter the source IP address.
Select Destination Device	Select the destination device to which the ACL rule applies. If you select Specific IP Address , enter the destination IP address in the field below.
Destination IP Address	Enter the destination IP address.
IP Type	Select whether your IP type is IPv4 or IPv6 .
Select Service	Select the transport layer protocol that defines your customized port from the drop-down list box. The specific protocol rule sets you add in the Security > Firewall > Service > Add screen display in this list. If you want to configure a customized protocol, select Specific Service .

Table 85 Access Control: Add/Edit (continued)

LABEL	DESCRIPTION
Protocol	This field is displayed only when you select Specific Protocol in Select Protocol . Choose the IP port (TCP/UDP , TCP , UDP , ICMP , or ICMPv6) that defines your customized port from the drop-down list box.
Custom Source Port	This field is displayed only when you select Specific Protocol in Select Protocol . Enter a single port number or the range of port numbers of the source.
Custom Destination Port	This field is displayed only when you select Specific Protocol in Select Protocol . Enter a single port number or the range of port numbers of the destination.
Policy	Use the drop-down list box to select whether to discard (DROP), deny and send an ICMP destination-unreachable message to the sender of (REJECT) or allow the passage of (ACCEPT) packets that match this rule.
Direction	Use the drop-down list box to select the direction of traffic to which this rule applies.
Enable Rate Limit	Select this check box to set a limit on the upstream/downstream transmission rate for the specified protocol. Specify how many packets per minute or second the transmission rate is.
Scheduler Rules	Select a schedule rule for this ACL rule form the drop-down list box. You can configure a new schedule rule by click Add New Rule . This will bring you to the Security > Scheduler Rules screen.
OK	Click OK to save your changes.
Cancel	Click Cancel to exit this screen without saving.

17.5 The DoS Screen

DoS (Denial of Service) attacks can flood your Internet connection with invalid packets and connection requests, using so much bandwidth and so many resources that Internet access becomes unavailable.

Use the **DoS** screen to activate protection against DoS attacks. Click **Security > Firewall > DoS** to display the following screen.

Figure 113 Security > Firewall > DoS

DoS Protection Blocking : Enable Disable (settings are invalid when disabled)

Deny Ping Response : Enable Disable

The following table describes the labels in this screen.

Table 86 Security > Firewall > DoS

LABEL	DESCRIPTION
DoS Protection Blocking	Select Enable to enable protection against DoS attacks.
Deny Ping Response	Select Enable to block ping request packets.
Apply	Click Apply to save your changes.
Cancel	Click Cancel to exit this screen without saving.

MAC Filter

18.1 Overview

You can configure the VMG to permit access to clients based on their MAC addresses in the **MAC Filter** screen. This applies to wired and wireless connections. Every Ethernet device has a unique MAC (Media Access Control) address. The MAC address is assigned at the factory and consists of six pairs of hexadecimal characters, for example, 00:A0:C5:00:00:02. You need to know the MAC addresses of the devices to configure this screen.

18.2 The MAC Filter Screen

Use this screen to allow wireless and LAN clients access to the VMG. Click **Security > MAC Filter**. The screen appears as shown.

Figure 114 Security > MAC Filter

Enable MAC Filter and add the MAC addresses of the LAN clients in your home or office network to the following table, if you wish to allow only them to access your network. Sometimes, MAC Filter is considered a method to increase the security of your network.

MAC Address Filter Enable Disable (settings are invalid when disabled)

MAC Restrict Mode Allow Deny

Set	Active	Host Name	MAC Address
1	<input type="checkbox"/>	<input type="text"/>	<input type="text" value="- - - - -"/>
2	<input type="checkbox"/>	<input type="text"/>	<input type="text" value="- - - - -"/>
3	<input type="checkbox"/>	<input type="text"/>	<input type="text" value="- - - - -"/>
4	<input type="checkbox"/>	<input type="text"/>	<input type="text" value="- - - - -"/>
5	<input type="checkbox"/>	<input type="text"/>	<input type="text" value="- - - - -"/>
6	<input type="checkbox"/>	<input type="text"/>	<input type="text" value="- - - - -"/>
7	<input type="checkbox"/>	<input type="text"/>	<input type="text" value="- - - - -"/>
8	<input type="checkbox"/>	<input type="text"/>	<input type="text" value="- - - - -"/>
9	<input type="checkbox"/>	<input type="text"/>	<input type="text" value="- - - - -"/>
10	<input type="checkbox"/>	<input type="text"/>	<input type="text" value="- - - - -"/>
11	<input type="checkbox"/>	<input type="text"/>	<input type="text" value="- - - - -"/>
32	<input type="checkbox"/>	<input type="text"/>	<input type="text" value="- - - - -"/>

Note:
Only devices listed here are granted access to the network.

The following table describes the labels in this screen.

Table 87 Security > MAC Filter

LABEL	DESCRIPTION
MAC Address Filter	Select Enable to activate the MAC filter function.
MAC Restrict Mode	Select Allow to only permit the listed MAC addresses access to the VMG. Select Deny to permit anyone access to the VMG except the listed MAC addresses.
Set	This is the index number of the MAC address.
Active	Select the check box to enable the MAC filter rule. The rule will not be applied if the check box is not selected.
Host Name	Enter the host name of the wireless or LAN clients that are allowed access to the VMG.
MAC Address	Enter the MAC addresses of the wireless or LAN clients that are allowed access to the VMG in these address fields. Enter the MAC addresses in a valid MAC address format, that is, six hexadecimal character pairs, for example, 12:34:56:78:9a:bc.
Apply	Click Apply to save your changes.
Cancel	Click Cancel to restore your previously saved settings.

Parental Control

19.1 Overview

Parental control allows you to block web sites with the specific URL. You can also define time periods and days during which the VMG performs parental control on a specific user.

19.2 The Parental Control Screen

Use this screen to enable parental control, view the parental control rules and schedules.

Click **Security > Parental Control** to open the following screen.

Figure 115 Security > Parental Control

The screenshot shows the 'Parental Control' configuration screen. At the top, under 'General', there is a 'Parental Control' section with two radio buttons: 'Enable' and 'Disable'. The 'Disable' option is selected, with a note that settings are invalid when disabled. Below this is the 'Parental Control Profile (PCP)' section, which includes an 'Add New PCP' button. A table lists existing profiles with columns for index number, status, name, MAC address, internet access schedule, network service, website blocking, and a modify button. At the bottom right, there are 'Apply' and 'Cancel' buttons.

The following table describes the fields in this screen.

Table 88 Security > Parental Control

LABEL	DESCRIPTION
Parental Control	Select Enable to activate parental control.
Add New PCP	Click this if you want to configure a new Parental Control Profile (PCP).
#	This shows the index number of the rule.
Status	This indicates whether the rule is active or not. A yellow bulb signifies that this rule is active. A gray bulb signifies that this rule is not active.
PCP Name	This shows the name of the rule.
Home Network User (MAC)	This shows the MAC address of the LAN user's computer to which this rule applies.
Internet Access Schedule	This shows the day(s) and time on which parental control is enabled.
Network Service	This shows whether the network service is configured. If not, None will be shown.
Website Block	This shows whether the website block is configured. If not, None will be shown.

Table 88 Security > Parental Control (continued)

LABEL	DESCRIPTION
Modify	Click the Edit icon to go to the screen where you can edit the rule. Click the Delete icon to delete an existing rule.
Apply	Click Apply to save your changes.
Cancel	Click Cancel to restore your previously saved settings.

19.2.1 Add/Edit a Parental Control Profile

Click **Add New PCP** in the **Parental Control** screen to add a new rule or click the **Edit** icon next to an existing rule to edit it. Use this screen to configure a restricted access schedule and/or URL filtering settings to block the users on your network from accessing certain web sites.

Figure 116 Parental Control Rule: Add/Edit Rule

Add New PCP

Active Enable Disable (Settings are invalid when disabled)

Parental Control Profile Name

Home Network User

Rule List

User MAC Address	Delete

Internet Access Schedule

Day Everyday Monday Tuesday Wednesday Thursday Friday Saturday Sunday

Time (Start - End) 00:00 - 24:00

00:00 24:00

Authorized Access

Network Service

Network Service Setting Selected Service(s)

#	Service Name	Protocol:Port	Modify

Site/URL Keyword

Block or Allow the Web Site

#	webSite	Modify

Redirect blocked site to ZyXEL Family Safety page

Figure 117 Parental Control Rule: Add/Edit Rule > Add New Service

Figure 118 Parental Control Rule: Add/Edit Rule > Add Keyword

The following table describes the fields in this screen.

Table 89 Parental Control Rule: Add/Edit

LABEL	DESCRIPTION
General	
Active	Select to enable or disable this parental control rule.
Parental Control Profile Name	Enter a descriptive name for the rule.
Home Network User	Select the LAN user that you want to apply this rule to from the drop-down list box. If you select Custom , enter the LAN user's MAC address. If you select All , the rule applies to all LAN users. Click Add to add the user NAC address to the Rule List .
Rule List	Up to five are allowed. Click the Delete icon to remove one.
Internet Access Schedule	
Day	Select check boxes for the days that you want the VMG to perform parental control.
Time	Drag the time bar to define the time that the LAN user is allowed access (Authorized access). Click the + sign above the time bar to add a new time bar. Up to three are allowed. Click the Delete icon to remove the corresponding one.
Network Service	
Network Service Setting	If you select Block , the VMG prohibits the users from using the service listed below. If you select Allow , the VMG blocks all services except ones listed below.
Add New service	Click this to show a screen in which you can add a new service rule. You can configure the Service Name , Protocol , and Name of the new rule.
#	This shows the index number of the rule. Select the checkbox next to the rule to activate it.
Service Name	This shows the name of the service.
Protocol:Port	This shows the protocol and the port of the service.

Table 89 Parental Control Rule: Add/Edit (continued)

LABEL	DESCRIPTION
Modify	Click the Edit icon to go to the screen where you can edit the rule. Click the Delete icon to delete an existing rule.
Site/URL Keyword	Click Add to show a screen to enter the URL of web site or URL keyword to which the VMG blocks or allows access. Click Delete to remove it.
Block or Allow the Web Site	If you select Block the Web URLs , the VMG prohibits the users from viewing the Web sites with the URLs listed below. If you select Allow the Web URLs , the VMG blocks access to all URLs except ones listed below.
Apply	Click this button to save your settings back to the VMG.
Cancel	Click Cancel to restore your previously saved settings.

Scheduler Rule

20.1 Overview

You can define time periods and days during which the VMG performs scheduled rules of certain features (such as Firewall Access Control) in the **Scheduler Rule** screen.

20.2 The Scheduler Rule Screen

Use this screen to view, add, or edit time schedule rules.

Click **Security > Scheduler Rule** to open the following screen.

Figure 119 Security > Scheduler Rule

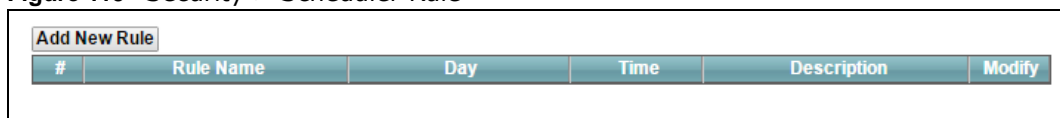

#	Rule Name	Day	Time	Description	Modify
---	-----------	-----	------	-------------	--------

The following table describes the fields in this screen.

Table 90 Security > Scheduler Rule

LABEL	DESCRIPTION
Add New Rule	Click this to create a new rule.
#	This is the index number of the entry.
Rule Name	This shows the name of the rule.
Day	This shows the day(s) on which this rule is enabled.
Time	This shows the period of time on which this rule is enabled.
Description	This shows the description of this rule.
Modify	Click the Edit icon to edit the schedule. Click the Delete icon to delete a scheduler rule. Note: You cannot delete a scheduler rule once it is applied to a certain feature.

20.2.1 Add/Edit a Schedule

Click the **Add New Rule** button in the **Scheduler Rule** screen or click the **Edit** icon next to a schedule rule to open the following screen. Use this screen to configure a restricted access schedule.

Figure 120 Scheduler Rule: Add/Edit

The following table describes the fields in this screen.

Table 91 Scheduler Rule: Add/Edit

LABEL	DESCRIPTION
Rule Name	Enter a name (up to 31 printable English keyboard characters, not including spaces) for this schedule.
Day	Select check boxes for the days that you want the VMG to perform this scheduler rule.
Time if Day Range	Enter the time period of each day, in 24-hour format, during which the rule will be enforced.
Description	Enter a description for this scheduler rule.
OK	Click OK to save your changes.
Cancel	Click Cancel to exit this screen without saving.

Certificates

21.1 Overview

The VMG can use certificates (also called digital IDs) to authenticate users. Certificates are based on public-private key pairs. A certificate contains the certificate owner's identity and public key. Certificates provide a way to exchange public keys for use in authentication.

21.1.1 What You Can Do in this Chapter

- The **Local Certificates** screen lets you generate certification requests and import the VMG's CA-signed certificates ([Section 21.4 on page 212](#)).
- The **Trusted CA** screen lets you save the certificates of trusted CAs to the VMG ([Section 21.4 on page 212](#)).

21.2 What You Need to Know

The following terms and concepts may help as you read through this chapter.

Certification Authority

A Certification Authority (CA) issues certificates and guarantees the identity of each certificate owner. There are commercial certification authorities like CyberTrust or VeriSign and government certification authorities. The certification authority uses its private key to sign certificates. Anyone can then use the certification authority's public key to verify the certificates. You can use the VMG to generate certification requests that contain identifying information and public keys and then send the certification requests to a certification authority.

21.3 The Local Certificates Screen

Click **Security** > **Certificates** to open the **Local Certificates** screen. This is the VMG's summary list of certificates and certification requests.

Figure 211 Security > Certificates > Local Certificates

Replace PrivateKey/Certificate file in PEM format

Private Key is protected by a password.

No file chosen

Current File	Subject	Issuer	Valid From	Valid To	Modify
--------------	---------	--------	------------	----------	--------

The following table describes the labels in this screen.

Table 92 Security > Certificates > Local Certificates

LABEL	DESCRIPTION
Private Key is protected by a password	Select the checkbox and enter the private key into the text box to store it on the VMG. The private key should not exceed 63 ASCII characters (not including spaces).
Choose File	Click this to find the certificate file you want to upload.
Import Certificate	Click this button to save the certificate that you have enrolled from a certification authority from your computer to the VMG.
Create Certificate Request	Click this button to go to the screen where you can have the VMG generate a certification request.
Current File	This field displays the name used to identify this certificate. It is recommended that you give each certificate a unique name.
Subject	This field displays identifying information about the certificate's owner, such as CN (Common Name), OU (Organizational Unit or department), O (Organization or company) and C (Country). It is recommended that each certificate have unique subject information.
Issuer	This field displays identifying information about the certificate's issuing certification authority, such as a common name, organizational unit or department, organization or company and country.
Valid From	This field displays the date that the certificate becomes applicable. The text displays in red and includes a Not Yet Valid! message if the certificate has not yet become applicable.
Valid To	This field displays the date that the certificate expires. The text displays in red and includes an Expiring! or Expired! message if the certificate is about to expire or has already expired.
Modify	<p>Click the Edit icon to open a screen with an in-depth list of information about the certificate (or certification request).</p> <p>For a certification request, click Edit and then Load_Signed to import the signed certificate.</p> <p>Click the Delete icon to remove the certificate (or certification request). You cannot delete a certificate that one or more features is configured to use.</p>

21.3.1 Create Certificate Request

Click **Security > Certificates > Local Certificates** and then **Create Certificate Request** to open the following screen. Use this screen to have the VMG generate a certification request.

Figure 122 Create Certificate Request

The following table describes the labels in this screen.

Table 93 Create Certificate Request

LABEL	DESCRIPTION
Certificate Name	Type up to 63 ASCII characters (not including spaces) to identify this certificate.
Common Name	Select Auto to have the VMG configure this field automatically. Or select Customize to enter it manually. Type the IP address (in dotted decimal notation), domain name or e-mail address in the field provided. The domain name or e-mail address can be up to 63 ASCII characters. The domain name or e-mail address is for identification purposes only and can be any string.
Organization Name	Type up to 63 characters to identify the company or group to which the certificate owner belongs. You may use any character, including spaces, but the VMG drops trailing spaces.
State/Province Name	Type up to 32 characters to identify the state or province where the certificate owner is located. You may use any character, including spaces, but the VMG drops trailing spaces.
Country/Region Name	Select a country to identify the nation where the certificate owner is located.
Apply	Click Apply to save your changes.
Cancel	Click Cancel to exit this screen without saving.

After you click **Apply** to generate a request, you still need to get the certificate request signed by a Certificate Authority. If you already have, click the request's **Edit** icon and then **Load_Signed** to import the signed certificate into the VMG.

Figure 123 Certificate Request Created

The screenshot shows a window titled "View Certificate" with a blue header bar. Below the header is a grey box labeled "Certificate Details". Underneath is a table with the following rows:

Name	
Type	
Subject	
Certificate	<input type="text"/>
Private Key	<input type="text"/>
Signing Request	<input type="text"/>

At the bottom right of the window, there are two buttons: "Load_Signed" and "Back".

21.3.2 Load Signed Certificate

After you create a certificate request and have it signed by a Certificate Authority, in the **View Certificate** screen click the certificate request's **Load_Signed** button to import the signed certificate into the VMG.

Note: You must remove any spaces from the certificate's filename before you can import it.

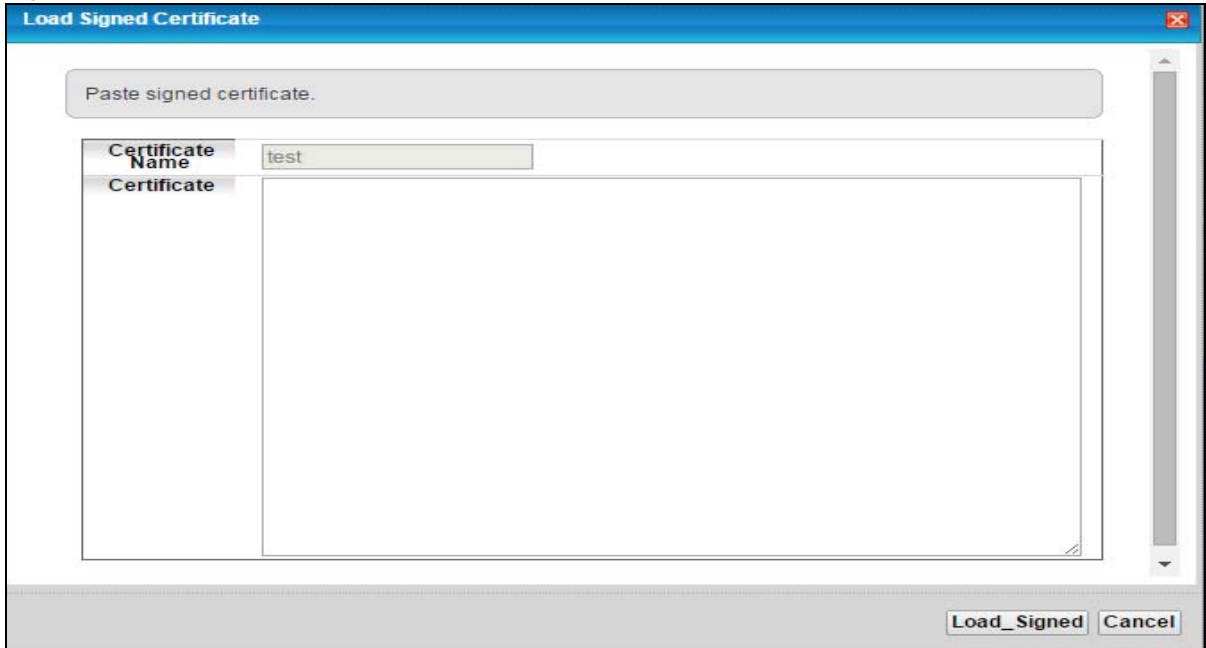
Figure 124 Load Signed Certificate

The following table describes the labels in this screen.

Table 94 Load Signed Certificate

LABEL	DESCRIPTION
Certificate Name	This is the name of the signed certificate.
Certificate	Copy and paste the signed certificate into the text box to store it on the VMG.
Load_Signed	Click Load_Signed to import the signed certificate into the VMG.
Cancel	Click Cancel to exit this screen without saving.

21.4 The Trusted CA Screen

Click **Security > Certificates > Trusted CA** to open the following screen. This screen displays a summary list of certificates of the certification authorities that you have set the VMG to accept as trusted. The VMG accepts any valid certificate signed by a certification authority on this list as being trustworthy; thus you do not need to import any certificate that is signed by one of these certification authorities.

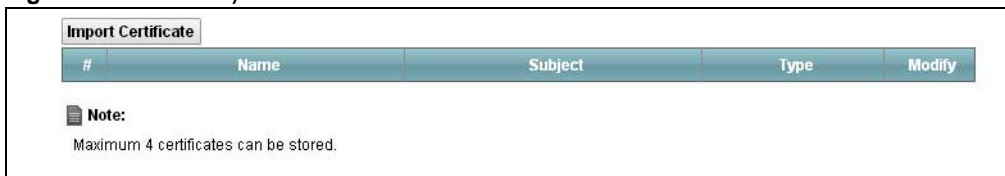
Figure 125 Security > Certificates > Trusted CA

The following table describes the fields in this screen.

Table 95 Security > Certificates > Trusted CA

LABEL	DESCRIPTION
Import Certificate	Click this button to open a screen where you can save the certificate of a certification authority that you trust to the VMG.
#	This is the index number of the entry.
Name	This field displays the name used to identify this certificate.
Subject	This field displays information that identifies the owner of the certificate, such as Common Name (CN), OU (Organizational Unit or department), Organization (O), State (ST) and Country (C). It is recommended that each certificate have unique subject information.
Type	This field displays general information about the certificate. ca means that a Certification Authority signed the certificate.
Modify	Click the View icon to open a screen with an in-depth list of information about the certificate (or certification request). Click the Remove button to delete the certificate (or certification request). You cannot delete a certificate that one or more features is configured to use.

21.4.1 View Trusted CA Certificate

Click the **View** icon in the **Trusted CA** screen to open the following screen. Use this screen to view in-depth information about the certification authority's certificate.

Figure 126 Trusted CA: View

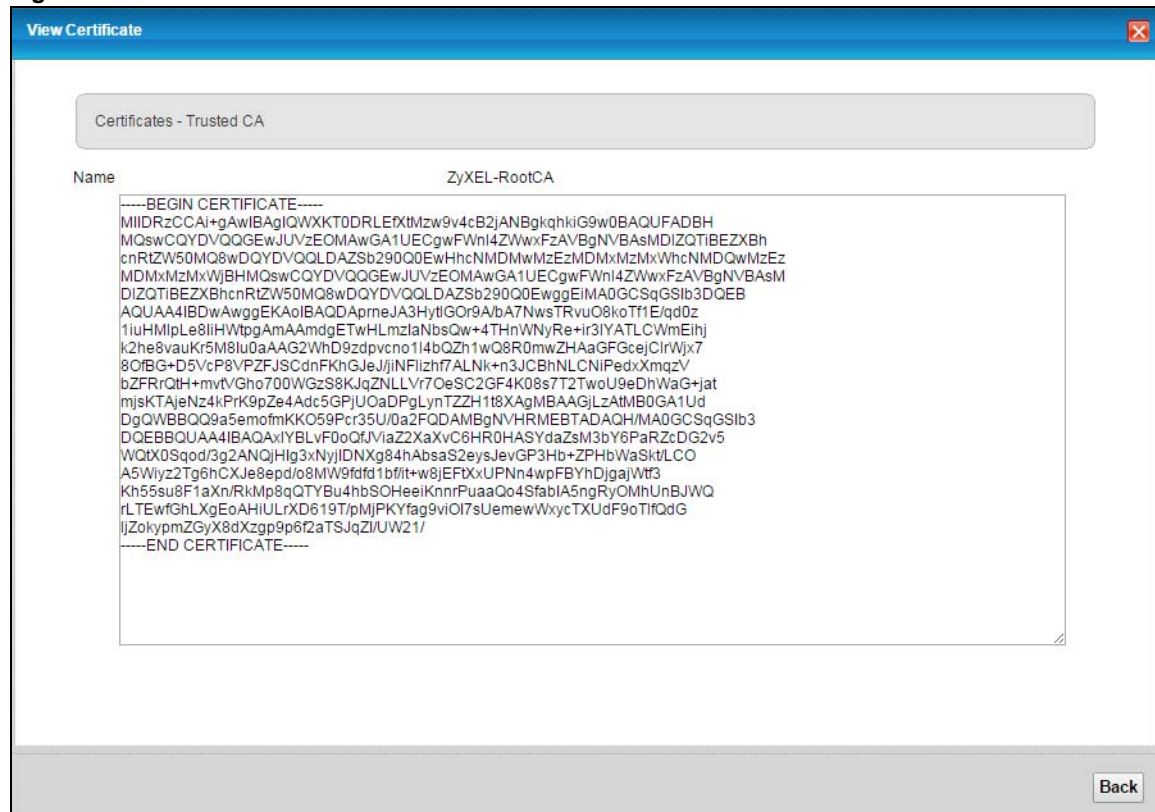

The following table describes the fields in this screen.

Table 96 Trusted CA: View

LABEL	DESCRIPTION
Name	This field displays the identifying name of this certificate.
	This read-only text box displays the certificate in Privacy Enhanced Mail (PEM) format. PEM uses base 64 to convert the binary certificate into a printable form. You can copy and paste the certificate into an e-mail to send to friends or colleagues or you can copy and paste the certificate into a text editor and save the file on a management computer for later distribution (via floppy disk for example).
Back	Click Back to return to the previous screen.

21.4.2 Import Trusted CA Certificate

Click the **Import Certificate** button in the **Trusted CA** screen to open the following screen. The VMG trusts any valid certificate signed by any of the imported trusted CA certificates.

Figure 127 Trusted CA: Import Certificate

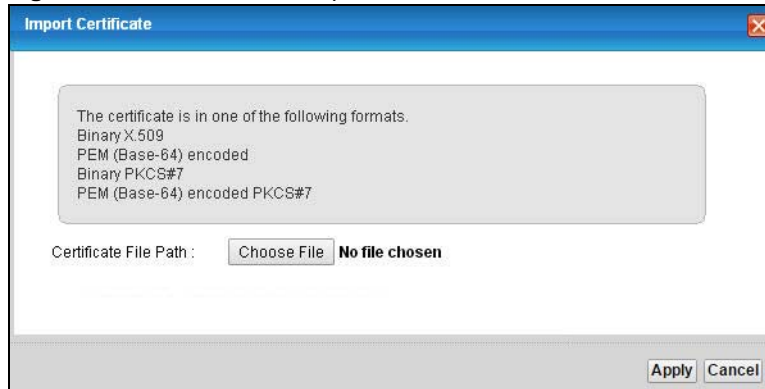

The following table describes the fields in this screen.

Table 97 Trusted CA: Import Certificate

LABEL	DESCRIPTION
Certificate File Path	Type in the location of the certificate you want to upload in this field or click Choose File to find it.
Apply	Click Apply to save your changes.
Cancel	Click Cancel to exit this screen without saving.

22.1 Overview

The web configurator allows you to choose which categories of events and/or alerts to have the VMG log and then display the logs or have the VMG send them to an administrator (as e-mail) or to a syslog server.

22.1.1 What You Can Do in this Chapter

- Use the **System Log** screen to see the system logs ([Section 22.2 on page 216](#)).
- Use the **Security Log** screen to see the security-related logs for the categories that you select ([Section 22.3 on page 216](#)).

22.1.2 What You Need To Know

The following terms and concepts may help as you read this chapter.

Alerts and Logs

An alert is a type of log that warrants more serious attention. They include system errors, attacks (access control) and attempted access to blocked web sites. Some categories such as **System Errors** consist of both logs and alerts. You may differentiate them by their color in the **View Log** screen. Alerts display in red and logs display in black.

Syslog Overview

The syslog protocol allows devices to send event notification messages across an IP network to syslog servers that collect the event messages. A syslog-enabled device can generate a syslog message and send it to a syslog server.

Syslog is defined in RFC 3164. The RFC defines the packet format, content and system log related information of syslog messages. Each syslog message has a facility and severity level. The syslog facility identifies a file in the syslog server. Refer to the documentation of your syslog program for details. The following table describes the syslog severity levels.

Table 98 Syslog Severity Levels

CODE	SEVERITY
0	Emergency: The system is unusable.
1	Alert: Action must be taken immediately.
2	Critical: The system condition is critical.
3	Error: There is an error condition on the system.
4	Warning: There is a warning condition on the system.

Table 98 Syslog Severity Levels

CODE	SEVERITY
5	Notice: There is a normal but significant condition on the system.
6	Informational: The syslog contains an informational message.
7	Debug: The message is intended for debug-level purposes.

22.2 The System Log Screen

Use the **System Log** screen to see the system logs. Click **System Monitor > Log** to open the **System Log** screen.

Figure 128 System Monitor > Log > System Log

The screenshot shows the System Log interface. At the top, there are two dropdown menus: 'Level: All' and 'Category: All'. Below these are four buttons: 'Clear Log', 'Refresh', 'Export Log', and 'Email Log Now'. At the bottom, there is a table header with the following columns: '#', 'Time', 'Facility', 'Level', 'Category', and 'Messages'.

The following table describes the fields in this screen.

Table 99 System Monitor > Log > System Log

LABEL	DESCRIPTION
Level	Select a severity level from the drop-down list box. This filters search results according to the severity level you have selected. When you select a severity, the VMG searches through all logs of that severity or higher.
Category	Select the type of logs to display.
Clear Log	Click this to delete all the logs.
Refresh	Click this to renew the log screen.
Export Log	Click this to export the selected log(s).
Email Log Now	Click this to send the log file(s) to the E-mail address you specify in the Maintenance > Logs Setting screen.
#	This field is a sequential value and is not associated with a specific entry.
Time	This field displays the time the log was recorded.
Facility	The log facility allows you to send logs to different files in the syslog server. Refer to the documentation of your syslog program for more details.
Level	This field displays the severity level of the log that the device is to send to this syslog server.
Category	This field displays the type of the log.
Messages	This field states the reason for the log.

22.3 The Security Log Screen

Use the **Security Log** screen to see the security-related logs for the categories that you select. Click **System Monitor > Log > Security Log** to open the following screen.

Figure 129 System Monitor > Log > Security Log

Level: All Category: All

Clear Log Refresh Export Log Email Log Now

#	Time	Facility	Level	Category	Messages
---	------	----------	-------	----------	----------

The following table describes the fields in this screen.

Table 100 System Monitor > Log > Security Log

LABEL	DESCRIPTION
Level	Select a severity level from the drop-down list box. This filters search results according to the severity level you have selected. When you select a severity, the VMG searches through all logs of that severity or higher.
Category	Select the type of logs to display.
Clear Log	Click this to delete all the logs.
Refresh	Click this to renew the log screen.
Export Log	Click this to export the selected log(s).
Email Log Now	Click this to send the log file(s) to the E-mail address you specify in the Maintenance > Logs Setting screen.
#	This field is a sequential value and is not associated with a specific entry.
Time	This field displays the time the log was recorded.
Facility	The log facility allows you to send logs to different files in the syslog server. Refer to the documentation of your syslog program for more details.
Level	This field displays the severity level of the log that the device is to send to this syslog server.
Category	This field displays the type of the log.
Messages	This field states the reason for the log.

Traffic Status

23.1 Overview

Use the **Traffic Status** screens to look at network traffic status and statistics of the WAN, LAN interfaces and NAT.

23.1.1 What You Can Do in this Chapter

- Use the **WAN** screen to view the WAN traffic statistics ([Section 23.2 on page 218](#)).
- Use the **LAN** screen to view the LAN traffic statistics ([Section 23.3 on page 219](#)).
- Use the **NAT** screen to view the NAT status of the VMG's client(s) ([Section 23.4 on page 220](#))

23.2 The WAN Status Screen

Click **System Monitor > Traffic Status** to open the **WAN** screen. The figure in this screen shows the number of bytes received and sent on the VMG.

Figure 130 System Monitor > Traffic Status > WAN

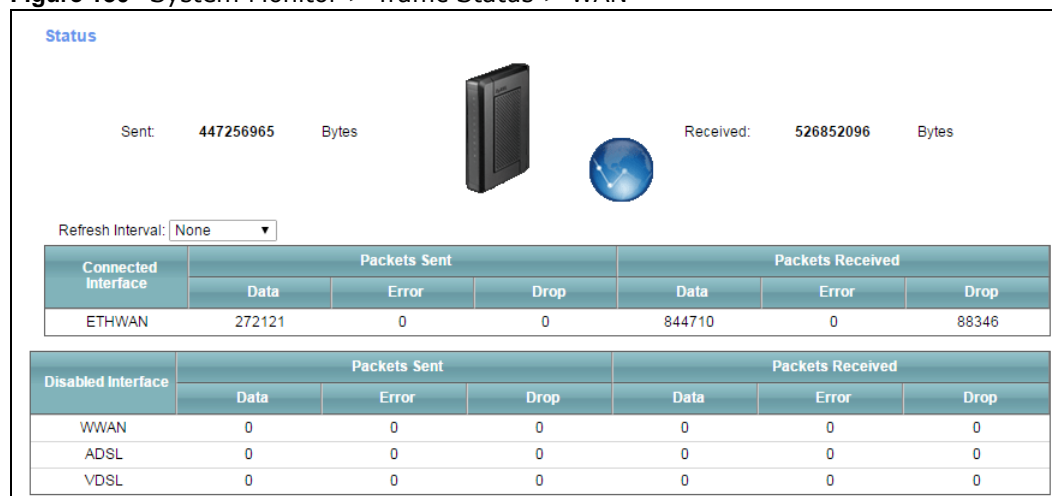

The following table describes the fields in this screen.

Table 101 System Monitor > Traffic Status > WAN

LABEL	DESCRIPTION
Refresh Interval	Select how often you want the VMG to update this screen.
Connected Interface	This shows the name of the WAN interface that is currently connected.
Packets Sent	
Data	This indicates the number of transmitted packets on this interface.
Error	This indicates the number of frames with errors transmitted on this interface.
Drop	This indicates the number of outgoing packets dropped on this interface.
Packets Received	
Data	This indicates the number of received packets on this interface.
Error	This indicates the number of frames with errors received on this interface.
Drop	This indicates the number of received packets dropped on this interface.
Disabled Interface	This shows the name of the WAN interface that is currently disconnected.
Packets Sent	
Data	This indicates the number of transmitted packets on this interface.
Error	This indicates the number of frames with errors transmitted on this interface.
Drop	This indicates the number of outgoing packets dropped on this interface.
Packets Received	
Data	This indicates the number of received packets on this interface.
Error	This indicates the number of frames with errors received on this interface.
Drop	This indicates the number of received packets dropped on this interface.

23.3 The LAN Status Screen

Click **System Monitor > Traffic Status > LAN** to open the following screen. The figure in this screen shows the interface that is currently connected on the VMG.

Figure 131 System Monitor > Traffic Status > LAN

Refresh Interval:							
None							
Interface		LAN1	LAN2	LAN3	LAN4	2.4G WLAN	5G WLAN
Bytes Sent		0	0	0	19866279	2999	8755571
Bytes Received		0	0	0	34707952	2252	0
Interface		LAN1	LAN2	LAN3	LAN4	2.4G WLAN	5G WLAN
Sent (Packet)	Data	0	0	0	119834	21	72917
	Error	0	0	0	0	0	0
	Drop	0	0	0	0	0	94
Received (Packet)	Data	0	0	0	254567	20	0
	Error	0	0	0	0	0	0
	Drop	0	0	0	0	0	2

The following table describes the fields in this screen.

Table 102 System Monitor > Traffic Status > LAN

LABEL	DESCRIPTION
Refresh Interval	Select how often you want the VMG to update this screen.
Interface	This shows the LAN or WLAN interface.
Bytes Sent	This indicates the number of bytes transmitted on this interface.
Bytes Received	This indicates the number of bytes received on this interface.
Interface	This shows the LAN or WLAN interfaces.
Sent (Packets)	
Data	This indicates the number of transmitted packets on this interface.
Error	This indicates the number of frames with errors transmitted on this interface.
Drop	This indicates the number of outgoing packets dropped on this interface.
Received (Packets)	
Data	This indicates the number of received packets on this interface.
Error	This indicates the number of frames with errors received on this interface.
Drop	This indicates the number of received packets dropped on this interface.

23.4 The NAT Status Screen

Click **System Monitor > Traffic Status > NAT** to open the following screen. The figure in this screen shows the NAT session statistics for hosts currently connected on the VMG.

Figure 132 System Monitor > Traffic Status > NAT

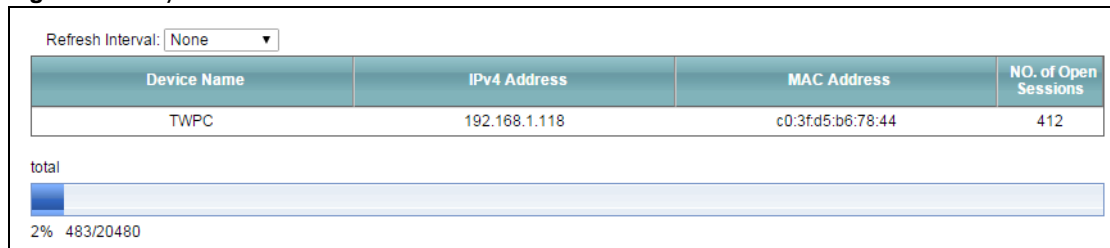

The following table describes the fields in this screen.

Table 103 System Monitor > Traffic Status > NAT

LABEL	DESCRIPTION
Refresh Interval	Select how often you want the VMG to update this screen.
Device Name	This displays the name of the connected host.
IPv4 Address	This displays the IP address of the connected host.
MAC Address	This displays the MAC address of the connected host.
No. of Open Session	This displays the number of NAT sessions currently opened for the connected host.
Total	This displays what percentage of NAT sessions the VMG can support is currently being used by all connected hosts. You can also see the number of active NAT sessions and the maximum number of NAT sessions the VMG can support.

ARP Table

24.1 Overview

Address Resolution Protocol (ARP) is a protocol for mapping an Internet Protocol address (IP address) to a physical machine address, also known as a Media Access Control or MAC address, on the local area network.

An IP (version 4) address is 32 bits long. In an Ethernet LAN, MAC addresses are 48 bits long. The ARP Table maintains an association between each MAC address and its corresponding IP address.

24.1.1 How ARP Works

When an incoming packet destined for a host device on a local area network arrives at the device, the device's ARP program looks in the ARP Table and, if it finds the address, sends it to the device.

If no entry is found for the IP address, ARP broadcasts the request to all the devices on the LAN. The device fills in its own MAC and IP address in the sender address fields, and puts the known IP address of the target in the target IP address field. In addition, the device puts all ones in the target MAC field (FF.FF.FF.FF.FF.FF is the Ethernet broadcast address). The replying device (which is either the IP address of the device being sought or the router that knows the way) replaces the broadcast address with the target's MAC address, swaps the sender and target pairs, and unicasts the answer directly back to the requesting machine. ARP updates the ARP Table for future reference and then sends the packet to the MAC address that replied.

24.2 ARP Table Screen

Use the ARP table to view IP-to-MAC address mapping(s). To open this screen, click **System Monitor > ARP Table**.

Figure 133 System Monitor > ARP Table

IPv4 ARP Table			
#	IPv4 Address	MAC Address	Device
1	192.168.1.174	30:f9:ed:ea:6c:b3	br0

IPv6 Neighbour Table			
#	IPv6 Address	MAC Address	Device

The following table describes the labels in this screen.

Table 104 System Monitor > ARP Table

LABEL	DESCRIPTION
#	This is the ARP table entry number.
IPv4/IPv6 Address	This is the learned IPv4 or IPv6 IP address of a device connected to a port.
MAC Address	This is the MAC address of the device with the listed IP address.
Device	This is the type of interface used by the device. You can click on the device type to go to its configuration screen.

Routing Table

25.1 Overview

Routing is based on the destination address only and the VMG takes the shortest path to forward a packet.

25.2 The Routing Table Screen

Click **System Monitor > Routing Table** to open the following screen.

Figure 134 System Monitor > Routing Table

IPv4 Routing Table					
Destination	Gateway	Subnet Mask	Flag	Metric	Interface
default	172.16.56.254	0.0.0.0	UG	0	eth4.4
172.16.56.0	*	255.255.255.0	U	0	eth4.4
192.168.1.0	*	255.255.255.0	U	0	br0

IPv6 Routing Table				
Destination	Gateway	Flag	Metric	Interface
fe80::/64	::	U	256	eth0.0
fe80::/64	::	U	256	eth1.0
fe80::/64	::	U	256	eth2.0
fe80::/64	::	U	256	eth3.0
fe80::/64	::	U	256	br0
fe80::/64	::	U	256	eth0.123
fe80::/64	::	U	256	eth1.123
::1/128	::	U	0	lo
fe80::/128	::	U	0	lo
fe80::/128	::	U	0	lo
ff00::/8	::	U	256	eth0.123
ff00::/8	::	U	256	eth1.123

The following table describes the labels in this screen.

Table 105 System Monitor > Routing Table

LABEL	DESCRIPTION
IPv4/IPv6 Routing Table	
Destination	This indicates the destination IPv4 address or IPv6 address and prefix of this route.
Gateway	This indicates the IPv4 address or IPv6 address of the gateway that helps forward this route's traffic.

Table 105 System Monitor > Routing Table (continued)

LABEL	DESCRIPTION
Subnet Mask	This indicates the destination subnet mask of the IPv4 route.
Flag	<p>This indicates the route status.</p> <p>U-Up: The route is up.</p> <p>!-Reject: The route is blocked and will force a route lookup to fail.</p> <p>G-Gateway: The route uses a gateway to forward traffic.</p> <p>H-Host: The target of the route is a host.</p> <p>R-Reinstate: The route is reinstated for dynamic routing.</p> <p>D-Dynamic (redirect): The route is dynamically installed by a routing daemon or redirect.</p> <p>M-Modified (redirect): The route is modified from a routing daemon or redirect.</p>
Metric	The metric represents the "cost of transmission". A router determines the best route for transmission by choosing a path with the lowest "cost". The smaller the number, the lower the "cost".
Interface	<p>This indicates the name of the interface through which the route is forwarded.</p> <p>brx indicates a LAN interface where x can be 0~3 to represent LAN1 to LAN4 respectively.</p> <p>ptm0 indicates a WAN interface using IPoE or in bridge mode.</p> <p>ppp0 indicates a WAN interface using PPPoE.</p>

Multicast Status

26.1 Overview

Use the **Multicast Status** screens to look at IGMP/MLD group status and traffic statistics.

26.2 The IGMP Status Screen

Use this screen to look at the current list of multicast groups the VMG has joined and which ports have joined it. To open this screen, click **System Monitor > Multicast Status > IGMP Status**.

Figure 135 System Monitor > Multicast Status > IGMP Status

Refresh				
Interface	Multicast Group	Filter Mode	Source List	Member

The following table describes the labels in this screen.

Table 106 System Monitor > Multicast Status > IGMP Status

LABEL	DESCRIPTION
Refresh	Click this button to update the information on this screen.
Interface	This field displays the name of an interface on the VMG that belongs to an IGMP multicast group.
Multicast Group	This field displays the name of the IGMP multicast group to which the interface belongs.
Filter Mode	INCLUDE means that only the IP addresses in the Source List get to receive the multicast group's traffic. EXCLUDE means that the IP addresses in the Source List are not allowed to receive the multicast group's traffic but other IP addresses can.
Source List	This is the list of IP addresses that are allowed or not allowed to receive the multicast group's traffic depending on the filter mode.
Member	This is the list of the members of the multicast group.

26.3 The MLD Status Screen

Use this screen to look at the current list of multicast groups the VMG has joined and which ports have joined it. To open this screen, click **System Monitor > Multicast Status > MLD Status**.

Figure 136 System Monitor > Multicast Status > MLD Status

Refresh				
Interface	Multicast Group	Filter Mode	Source List	Member

The following table describes the labels in this screen.

Table 107 System Monitor > Multicast Status > MLD Status

LABEL	DESCRIPTION
Refresh	Click this button to update the status on this screen.
Interface	This field displays the name of an interface on the VMG that belongs to an MLD multicast group.
Multicast Group	This field displays the name of the MLD multicast group to which the interface belongs.
Filter Mode	INCLUDE means that only the IP addresses in the Source List get to receive the multicast group's traffic. EXCLUDE means that the IP addresses in the Source List are not allowed to receive the multicast group's traffic but other IP addresses can.
Source List	This is the list of IP addresses that are allowed or not allowed to receive the multicast group's traffic depending on the filter mode.
Member	This is the list of members in the multicast group.

xDSL Statistics

27.1 The xDSL Statistics Screen

Use this screen to view detailed DSL statistics. Click **System Monitor > xDSL Statistics** to open the following screen.

Figure 137 System Monitor > xDSL Statistics

```

Monitor
Refresh Interval: [No Refresh v]
Line: [v]
Status:

=====
xDSL Training Status: Idle
Mode: G.DMT
Traffic Type: Inactive
Link Uptime: N/A
=====

xDSL Port Details      Upstream      Downstream
Line Rate:             0.000 Mbps   0.000 Mbps
Actual Net Data Rate:  0.000 Mbps   0.000 Mbps
Trellis Coding:        N/A           N/A
SNR Margin:            0.0 dB       0.0 dB
Actual Delay:          0 ms         0 ms
Transmit Power:        0.0 dBm      0.0 dBm
Receive Power:         0.0 dBm      0.0 dBm
Actual INP:            0.0 symbols  0.0 symbols
Total Attenuation:     0.0 dB       0.0 dB
Attainable Net Data Rate: 0.000 Mbps  0.000 Mbps
=====

xDSL Counters
Downstream      Upstream
Since Link time = 0 sec
FEC:            0            0
CRC:            0

```

The following table describes the labels in this screen.

Table 108 Status > xDSL Statistics

LABEL	DESCRIPTION
Refresh Interval	Select the time interval for refreshing statistics.
Line	Select which DSL line's statistics you want to display.
xDSL Training Status	This displays the current state of setting up the DSL connection.
Mode	This displays the ITU standard used for this connection.
Traffic Type	This displays the type of traffic the DSL port is sending and receiving. Inactive displays if the DSL port is not currently sending or receiving traffic.

Table 108 Status > xDSL Statistics (continued)

LABEL	DESCRIPTION
Link Uptime	This displays how long the port has been running (or connected) since the last time it was started.
xDSL Port Details	
Upstream	These are the statistics for the traffic direction going out from the port to the service provider.
Downstream	These are the statistics for the traffic direction coming into the port from the service provider.
Line Rate	These are the data transfer rates at which the port is sending and receiving data.
Actual Net Data Rate	These are the rates at which the port is sending and receiving the payload data without transport layer protocol headers and traffic.
Trellis Coding	This displays whether or not the port is using Trellis coding for traffic it is sending and receiving. Trellis coding helps to reduce the noise in ADSL transmissions. Trellis may reduce throughput but it makes the connection more stable.
SNR Margin	This is the upstream and downstream Signal-to-Noise Ratio margin (in dB). A DMT sub-carrier's SNR is the ratio between the received signal power and the received noise power. The signal-to-noise ratio margin is the maximum that the received noise power could increase with the system still being able to meet its transmission targets.
Actual Delay	This is the upstream and downstream interleave delay. It is the wait (in milliseconds) that determines the size of a single block of data to be interleaved (assembled) and then transmitted. Interleave delay is used when transmission error correction (Reed- Solomon) is necessary due to a less than ideal telephone line. The bigger the delay, the bigger the data block size, allowing better error correction to be performed.
Transmit Power	This is the upstream and downstream far end actual aggregate transmit power (in dBm). Upstream is how much power the port is using to transmit to the service provider. Downstream is how much power the service provider is using to transmit to the port.
Receive Power	Upstream is how much power the service provider is receiving from the port. Downstream is how much power the port is receiving from the service provider.
Actual INP	Sudden spikes in the line's level of external noise (impulse noise) can cause errors and result in lost packets. This could especially impact the quality of multimedia traffic such as voice or video. Impulse noise protection (INP) provides a buffer to allow for correction of errors caused by error correction to deal with this. The number of DMT (Discrete Multi-Tone) symbols shows the level of impulse noise protection for the upstream and downstream traffic. A higher symbol value provides higher error correction capability, but it causes overhead and higher delay which may increase error rates in received multimedia data.
Total Attenuation	This is the upstream and downstream line attenuation, measured in decibels (dB). This attenuation is the difference between the power transmitted at the near-end and the power received at the far-end. Attenuation is affected by the channel characteristics (wire gauge, quality, condition and length of the physical line).
Attainable Net Data Rate	These are the highest theoretically possible transfer rates at which the port could send and receive payload data without transport layer protocol headers and traffic.
xDSL Counters	
Downstream	These are the statistics for the traffic direction coming into the port from the service provider.
Upstream	These are the statistics for the traffic direction going out from the port to the service provider.
FEC	This is the number of Far End Corrected blocks.
CRC	This is the number of Cyclic Redundancy Checks.
ES	This is the number of Errored Seconds meaning the number of seconds containing at least one errored block or at least one defect.

Table 108 Status > xDSL Statistics (continued)

LABEL	DESCRIPTION
SES	This is the number of Severely Errored Seconds meaning the number of seconds containing 30% or more errored blocks or at least one defect. This is a subset of ES.
UAS	This is the number of UnAvailable Seconds.
LOS	This is the number of Loss Of Signal seconds.
LOF	This is the number of Loss Of Frame seconds.
LOM	This is the number of Loss of Margin seconds.

3G Statistics

28.1 Overview

Use the **3G Statistics** screens to look at 3G Internet connection status.

28.2 The 3G Statistics Screen

To open this screen, click **System Monitor > 3G Statistics**. The 3G status is available on this screen only when you insert a compatible 3G dongle in a USB port on the VMG.

Figure 138 System Monitor > 3G Statistics

Monitor	
Refresh Interval :	30 Seconds ▼
Status :	
3G Status:	No Device
Service Provider:	N/A
Signal Strength:	N/A
Connection Uptime:	N/A
3G Card Manufacturer:	N/A
3G Card Model:	N/A
3G Card F/W Version:	N/A
SIM Card IMSI:	N/A
VID/PID:	N/A

The following table describes the labels in this screen.

Table 109 System Monitor > 3G Statistics

LABEL	DESCRIPTION
Refresh Interval	Select how often you want the VMG to update this screen. Select No Refresh to stop refreshing.
3G Status	This field displays the status of the 3G Internet connection. This field can display: GSM - Global System for Mobile Communications, 2G GPRS - General Packet Radio Service, 2.5G EDGE - Enhanced Data rates for GSM Evolution, 2.75G WCDMA - Wideband Code Division Multiple Access, 3G HSDPA - High-Speed Downlink Packet Access, 3.5G HSUPA - High-Speed Uplink Packet Access, 3.75G HSPA - HSDPA+HSUPA, 3.75G
Service Provider	This field displays the name of the service provider.
Signal Strength	This field displays the strength of the signal in dBm.
Connection Uptime	This field displays the time the connection has been up.
3G Card Manufacturer	This field displays the manufacturer of the 3G card.
3G Card Model	This field displays the model name of the 3G card.
3G Card F/W Version	This field displays the firmware version of the 3G card.
SIM Card IMSI	The International Mobile Subscriber Identity or IMSI is a unique identification number associated with all cellular networks. This number is provisioned in the SIM card.
VID/PID	This field displays the USB Vendor ID and Product ID of the 3G card.

29.1 Overview

In the **System** screen, you can name your VMG (Host) and give it an associated domain name for identification purposes.

29.2 The System Screen

Click **Maintenance > System** to open the following screen.

Figure 139 Maintenance > System

The screenshot shows a form with two input fields. The first field is labeled 'Host Name :' and contains the text 'VMG3925-B10A'. The second field is labeled 'Domain Name :' and contains the text 'home'. At the bottom right of the form, there are two buttons: 'Apply' and 'Cancel'.

The following table describes the labels in this screen.

Table 110 Maintenance > System

LABEL	DESCRIPTION
Host Name	Type a hostname for your VMG. Enter a descriptive name of up to 16 alphanumeric characters, not including spaces, underscores, and dashes.
Domain Name	Type a Domain name for your host VMG.
Apply	Click Apply to save your changes.
Cancel	Click Cancel to abandon this screen without saving.

User Account

30.1 Overview

In the **User Account** screen, you can view the settings of the “admin” and other user accounts that you used to log in the VMG.

30.2 The User Account Screen

Click **Maintenance > User Account** to open the following screen.

Figure 140 Maintenance > User Account

Add New Account						
#	User Name	Retry Times	Idle Timeout	Lock Period	Group	Modify
1	admin	0	60	15	Administrator	
2	user	0	10	15	User	

The following table describes the labels in this screen.

Table 111 Maintenance > User Account

LABEL	DESCRIPTION
Add New Account	Click this button to add a new user account.
#	This is the index number
User Name	This field displays the name of the account used to log into the VMG web configurator.
Retry Times	This field displays the number of times consecutive wrong passwords can be entered for this account. 0 means there is no limit.
Idle Timeout	This field displays the the length of inactive time before the VMG will automatically log the user out of the web configurator.
Lock Period	This field displays the length of time a user must wait before attempting to log in again after a number if consecutive wrong passwords have been entered as defined in Retry Times .
Group	This field displays whether this user has Administrator or User privileges.
Modify	Click the Edit icon to configure the entry. Click the Delete icon to remove the entry.

30.2.1 The User Account Add/Edit Screen

Click **Add New Account** or the **Edit** icon of an existing account in the **Maintenance > User Account** to open the following screen.

Figure 141 Maintenance > User Account > Add/Edit

The following table describes the labels in this screen.

Table 112 Maintenance > User Account > Add/Edit

LABEL	DESCRIPTION
User Name	Enter a new name for the account. This field displays the name of an existing account.
Password	Type your new system password (up to 256 characters). Note that as you type a password, the screen displays a (*) for each character you type. After you change the password, use the new password to access the VMG.
Verify Password	Type the new password again for confirmation.
Retry Times	Enter the number of times consecutive wrong passwords can be entered for this account. 0 means there is no limit.
Idle Timeout	Enter the length of inactive time before the VMG will automatically log the user out of the web configurator.
Lock Period	Enter the length of time a user must wait before attempting to log in again after a number if consecutive wrong passwords have been entered as defined in Retry Times .
Group	Specify whether this user will have Administrator or User privileges.
OK	Click OK to save your changes.
Cancel	Click Cancel to exit this screen without saving.

Remote Management

31.1 Overview

Remote management controls through which interface(s), which services can access the VMG.

Note: The VMG is managed using the Web Configurator.

31.2 The Remote MGMT Screen

Use this screen to configure through which interface(s), which services can access the VMG. You can also specify the port numbers the services must use to connect to the VMG. Click **Maintenance > Remote MGMT** to open the following screen.

Figure 142 Maintenance > Remote MGMT

service	LAN/WLAN	WAN	Trust Domain	Port
HTTP	<input checked="" type="checkbox"/> Enable	<input type="checkbox"/> Enable	<input checked="" type="checkbox"/> Enable	80
HTTPS	<input checked="" type="checkbox"/> Enable	<input type="checkbox"/> Enable	<input type="checkbox"/> Enable	443
FTP	<input checked="" type="checkbox"/> Enable	<input type="checkbox"/> Enable	<input type="checkbox"/> Enable	21
TELNET	<input checked="" type="checkbox"/> Enable	<input type="checkbox"/> Enable	<input type="checkbox"/> Enable	23
SSH	<input checked="" type="checkbox"/> Enable	<input type="checkbox"/> Enable	<input type="checkbox"/> Enable	22
SNMP	<input checked="" type="checkbox"/> Enable	<input type="checkbox"/> Enable	<input type="checkbox"/> Enable	161

The following table describes the fields in this screen.

Table 113 Maintenance > Remote MGMT

LABEL	DESCRIPTION
WAN Interface used for services	Select Any_WAN to have the VMG automatically activate the remote management service when any WAN connection is up. Select Multi_WAN and then select one or more WAN connections to have the VMG activate the remote management service when the selected WAN connections are up.
service	This is the service you may use to access the VMG.
LAN/WLAN	Select the Enable check box for the corresponding services that you want to allow access to the VMG from the LAN/WLAN.
WAN	Select the Enable check box for the corresponding services that you want to allow access to the VMG from all WAN connections.

Table 113 Maintenance > Remote MGMT (continued)

LABEL	DESCRIPTION
Trust Domain	If you only want certain WAN connections to have access to the VMG using the corresponding services, then clear WAN , select Trust Domain and configure the allowed IP address(es) in the Trust Domain screen.
Port	You may change the server port number for a service if needed, however you must use the same port number in order to use that service for remote management.
Apply	Click Apply to save your changes back to the VMG.
Cancel	Click Cancel to restore your previously saved settings.

31.3 The Trust Domain Screen

Use this screen to view a list of public IP addresses which are allowed to access the VMG through the services configured in the **Maintenance > Remote MGMT** screen. Click **Maintenance > Remote MGMT > Trust Domain** to open the following screen.

Note: If this list is empty, all public IP addresses can access the VMG from the WAN through the specified services.

Figure 143 Maintenance > Remote MGMT > Trust Domain

The following table describes the fields in this screen.

Table 114 Maintenance > Remote MGMT > Trust Domain

LABEL	DESCRIPTION
Add Trust Domain	Click this to add a trusted host IP address.
IP Address	This field shows a trusted host IP address.
Delete	Click the Delete icon to remove the trust IP address.

31.3.1 The Add Trust Domain Screen

Use this screen to configure a public IP address which is allowed to access the VMG. Click the **Add Trust Domain** button in the **Maintenance > Remote MGMT > Trust Domain** screen to open the following screen.

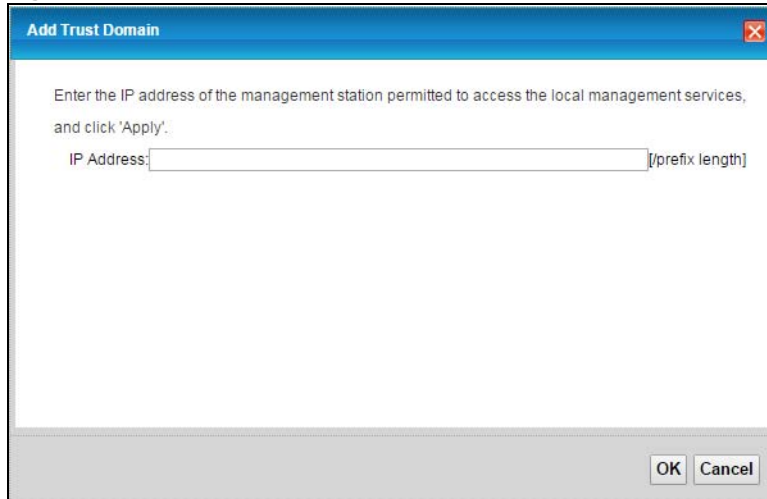
Figure 144 Maintenance > Remote MGMT > Trust Domain > Add Trust Domain

Enter the IP address of the management station permitted to access the local management services, and click 'Apply'.

IP Address: (prefix length)

OK Cancel

The following table describes the fields in this screen.

Table 115 Maintenance > Remote MGMT > Trust Domain > Add Trust Domain

LABEL	DESCRIPTION
IP Address	Enter a public IPv4 IP address which is allowed to access the service on the VMG from the WAN.
OK	Click OK to save your changes back to the VMG.
Cancel	Click Cancel to restore your previously saved settings.

32.1 Overview

This chapter explains how to configure the SNMP settings on the VMG.

32.2 The SNMP Screen

Simple Network Management Protocol is a protocol used for exchanging management information between network devices. Your VMG supports SNMP agent functionality, which allows a manager station to manage and monitor the VMG through the network. The VMG supports SNMP version one (SNMPv1) and version two (SNMPv2c). The next figure illustrates an SNMP management operation.

Figure 145 SNMP Management Model

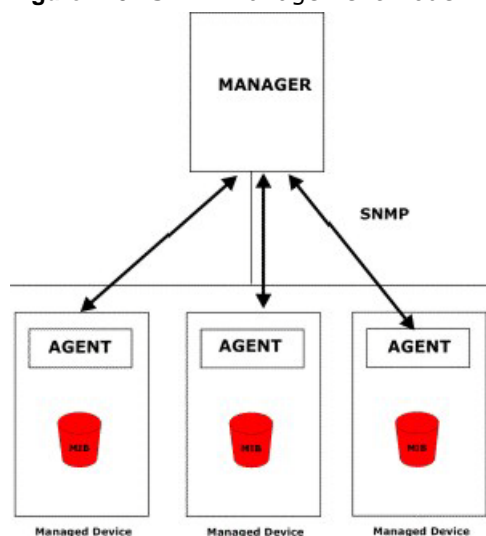

An SNMP managed network consists of two main types of component: agents and a manager.

An agent is a management software module that resides in a managed device (the VMG). An agent translates the local management information from the managed device into a form compatible with SNMP. The manager is the console through which network administrators perform network management functions. It executes applications that control and monitor managed devices.

The managed devices contain object variables/managed objects that define each piece of information to be collected about a device. Examples of variables include such as number of packets received, node port status etc. A Management Information Base (MIB) is a collection of managed objects. SNMP allows a manager and agents to communicate for the purpose of accessing these objects.

SNMP itself is a simple request/response protocol based on the manager/agent model. The manager issues a request and the agent returns responses using the following protocol operations:

- Get - Allows the manager to retrieve an object variable from the agent.
- GetNext - Allows the manager to retrieve the next object variable from a table or list within an agent. In SNMPv1, when a manager wants to retrieve all elements of a table from an agent, it initiates a Get operation, followed by a series of GetNext operations.
- Set - Allows the manager to set values for object variables within an agent.
- Trap - Used by the agent to inform the manager of some events.

Click **Maintenance > SNMP** to open the following screen. Use this screen to configure the VMG SNMP settings.

Figure 146 Maintenance > SNMP

The screenshot shows a configuration window for SNMP settings. On the left, there are labels for each field: 'SNMP Agent', 'Get Community:', 'Set Community', 'Trap Community', 'System Name:', 'System Location:', 'System Contact:', and 'Trap Destination:'. On the right, there are corresponding input controls: a radio button for 'Enable' (selected) and 'Disable', and text input boxes for the community strings, system name, location, contact, and trap destination. The 'System Name' field contains 'VMG3925-B10A' and 'System Location' contains 'Taiwan'. At the bottom right, there are 'Apply' and 'Cancel' buttons.

The following table describes the fields in this screen.

Table 116 Maintenance > SNMP

LABEL	DESCRIPTION
SNMP Agent	Select Enable to let the VMG act as an SNMP agent, which allows a manager station to manage and monitor the VMG through the network. Select Disable to turn this feature off.
Get Community	Enter the Get Community , which is the password for the incoming Get and GetNext requests from the management station.
Set Community	Enter the Set community , which is the password for incoming Set requests from the management station.
Trap Community	Enter the Trap Community , which is the password sent with each trap to the SNMP manager. The default is public and allows all requests.
System Name	Enter the SNMP system name.
System Location	Enter the SNMP system location.
System Contact	Enter the SNMP system contact.
Trap Destination	Type the IP address of the station to send your SNMP traps to.
Apply	Click this to save your changes back to the VMG.
Cancel	Click this to restore your previously saved settings.

Time Settings

33.1 Overview

This chapter shows you how to configure system related settings, such as system time, password, name, the domain name and the inactivity timeout interval.

33.2 The Time Screen

To change your VMG's time and date, click **Maintenance > Time**. The screen appears as shown. Use this screen to configure the VMG's time based on your local time zone.

Figure 147 Maintenance > Time

Current Date/Time
 Current Time : 08:40:35
 Current Date : 2015-10-19

Time and Date Setup
 Time Protocol : SNTP (RFC-1769)
 First Time Server Address : pool.ntp.org
 Second Time Server Address : clock.nyc.he.net
 Third Time Server Address : clock.sjc.he.net
 Fourth Time Server Address : None
 Fifth Time Server Address : None

Time Zone
 Time Zone: (GMT+01:00) Amsterdam, Berlin, Bern, Rome, Stockholm, Vienna

Daylight Savings
 Active Enable Disable

Start Rule
 Day : 1 in
 Sunday in
 Month : March
 Hour : 2 : 0

End Rule
 Day : 1 in
 Sunday in
 Month : October
 Time : 3 : 0

Apply Cancel

The following table describes the fields in this screen.

Table 117 Maintenance > Time

LABEL	DESCRIPTION
Current Date/Time	
Current Time	<p>This field displays the time of your VMG.</p> <p>Each time you reload this page, the VMG synchronizes the time with the time server.</p>
Current Date	<p>This field displays the date of your VMG.</p> <p>Each time you reload this page, the VMG synchronizes the date with the time server.</p>
Time and Date Setup	
First ~ Fifth Time Server Address	<p>Select an NTP time server from the drop-down list box.</p> <p>Otherwise, select Other and enter the IP address or URL (up to 29 extended ASCII characters in length) of your time server.</p> <p>Select None if you don't want to configure the time server.</p> <p>Check with your ISP/network administrator if you are unsure of this information.</p>
Time Zone	
Time zone	Choose the time zone of your location. This will set the time difference between your time zone and Greenwich Mean Time (GMT).
Daylight Savings	Daylight Saving Time is a period from late spring to early fall when many countries set their clocks ahead of normal local time by one hour to give more daytime light in the evening.
State	Select Enable if you use Daylight Saving Time.
Start Rule	<p>Configure the day and time when Daylight Saving Time starts if you enabled Daylight Saving. You can select a specific date in a particular month or a specific day of a specific week in a particular month. The Time field uses the 24 hour format. Here are a couple of examples:</p> <p>Daylight Saving Time starts in most parts of the United States on the second Sunday of March. Each time zone in the United States starts using Daylight Saving Time at 2 A.M. local time. So in the United States, set the day to Second, Sunday, the month to March and the time to 2 in the Hour field.</p> <p>Daylight Saving Time starts in the European Union on the last Sunday of March. All of the time zones in the European Union start using Daylight Saving Time at the same moment (1 A.M. GMT or UTC). So in the European Union you would set the day to Last, Sunday and the month to March. The time you select in the o'clock field depends on your time zone. In Germany for instance, you would select 2 in the Hour field because Germany's time zone is one hour ahead of GMT or UTC (GMT+1).</p>
End Rule	<p>Configure the day and time when Daylight Saving Time ends if you enabled Daylight Saving. You can select a specific date in a particular month or a specific day of a specific week in a particular month. The Time field uses the 24 hour format. Here are a couple of examples:</p> <p>Daylight Saving Time ends in the United States on the first Sunday of November. Each time zone in the United States stops using Daylight Saving Time at 2 A.M. local time. So in the United States you would set the day to First, Sunday, the month to November and the time to 2 in the Hour field.</p> <p>Daylight Saving Time ends in the European Union on the last Sunday of October. All of the time zones in the European Union stop using Daylight Saving Time at the same moment (1 A.M. GMT or UTC). So in the European Union you would set the day to Last, Sunday, and the month to October. The time you select in the o'clock field depends on your time zone. In Germany for instance, you would select 2 in the Hour field because Germany's time zone is one hour ahead of GMT or UTC (GMT+1).</p>

Table 117 Maintenance > Time (continued)

LABEL	DESCRIPTION
Apply	Click Apply to save your changes.
Cancel	Click Cancel to exit this screen without saving.

E-mail Notification

34.1 Overview

A mail server is an application or a computer that runs such an application to receive, forward and deliver e-mail messages.

To have the VMG send reports, logs or notifications via e-mail, you must specify an e-mail server and the e-mail addresses of the sender and receiver.

34.2 The E-mail Notification Screen

Click **Maintenance > E-mail Notification** to open the **E-mail Notification** screen. Use this screen to view, remove and add mail server information on the VMG.

Figure 148 Maintenance > E-mail Notification

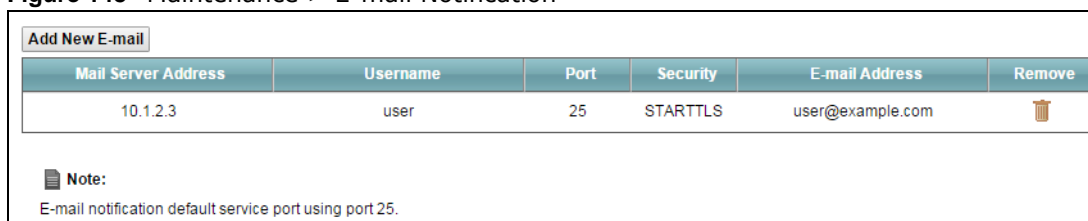

Add New E-mail					
Mail Server Address	Username	Port	Security	E-mail Address	Remove
10.1.2.3	user	25	STARTTLS	user@example.com	

Note:
E-mail notification default service port using port 25.

The following table describes the labels in this screen.

Table 118 Maintenance > E-mail Notification

LABEL	DESCRIPTION
Add New E-mail	Click this button to create a new entry.
Mail Server Address	This field displays the server name or the IP address of the mail server.
Username	This field displays the user name of the sender's mail account.
Port	This field displays the port number of the mail server.
Security	This field displays the protocol used for encryption.
E-mail Address	This field displays the e-mail address that you want to be in the from/sender line of the e-mail that the VMG sends.
Delete	Click this button to delete the selected entry(ies).

34.2.1 Email Notification Edit

Click the **Add** button in the **Email Notification** screen. Use this screen to configure the required information for sending e-mail via a mail server.

Figure 149 Email Notification > Add

The following table describes the labels in this screen.

Table 119 Email Notification > Add

LABEL	DESCRIPTION
Mail Server Address	Enter the server name or the IP address of the mail server for the e-mail address specified in the Account E-mail Address field. If this field is left blank, reports, logs or notifications will not be sent via e-mail.
Port	Enter the same port number here as is on the mail server for mail traffic.
Authentication Username	Enter the user name (up to 32 characters). This is usually the user name of a mail account you specified in the Account E-mail Address field.
Authentication Password	Enter the password associated with the user name above.
Account E-mail Address	Enter the e-mail address that you want to be in the from/sender line of the e-mail notification that the VMG sends. If you activate SSL/TLS authentication, the e-mail address must be able to be authenticated by the mail server as well.
Connection Security	Select SSL to use Secure Sockets Layer (SSL) or Transport Layer Security (TLS) if you want encrypted communications between the mail server and the VMG. Select STARTTLS to upgrade a plain text connection to a secure connection using SSL/TLS.
OK	Click this button to save your changes and return to the previous screen.
Cancel	Click this button to begin configuring this screen afresh.

Log Setting

35.1 Overview

You can configure where the VMG sends logs and which logs and/or immediate alerts the VMG records in the **Logs Setting** screen.

35.2 The Log Settings Screen

To change your VMG's log settings, click **Maintenance > Logs Setting**. The screen appears as shown.

Figure 150 Maintenance > Logs Setting

Syslog Setting

Syslog Logging : Enable Disable (settings are invalid when disabled)

Mode : ▼

Syslog Server : (Server NAME or IPv4/IPv6 Address)

UDP Port : (Server Port)

E-mail Log Settings :

E-mail Log Settings : Enable Disable (settings are invalid when disabled)

Active Log

System Log

- WAN-DHCP
- DHCP Server
- PPPoE
- TR-069
- HTTP
- UPNP
- System
- xDSL
- ACL
- Wireless

Security Log

- Account
- Attack
- Firewall
- MAC Filter

The following table describes the fields in this screen.

Table 120 Maintenance > Logs Setting

LABEL	DESCRIPTION
Syslog Setting	
Syslog Logging	The VMG sends a log to an external syslog server. Select Enable to enable syslog logging.

Table 120 Maintenance > Logs Setting (continued)

LABEL	DESCRIPTION
Mode	Select the syslog destination from the drop-down list box. If you select Remote , the log(s) will be sent to a remote syslog server. If you select Local File , the log(s) will be saved in a local file. If you want to send the log(s) to a remote syslog server and save it in a local file, select Local File and Remote .
Syslog Server	Enter the server name or IP address of the syslog server that will log the selected categories of logs.
UDP Port	Enter the port number used by the syslog server.
E-mail Log Settings	
E-mail Log Settings	Select Enable to have the VMG send logs and alarm messages to the configured e-mail addresses.
Mail Account	Select a mail account from which you want to send logs. You can configure mail accounts in the Maintenance > Email Notification screen.
System Log Mail Subject	Type a title that you want to be in the subject line of the system log e-mail message that the VMG sends.
Security Log Mail Subject	Type a title that you want to be in the subject line of the security log e-mail message that the VMG sends.
Send Log to	The VMG sends logs to the e-mail address specified in this field. If this field is left blank, the VMG does not send logs via E-mail.
Send Alarm to	Alerts are real-time notifications that are sent as soon as an event, such as a DoS attack, system error, or forbidden web access attempt occurs. Enter the E-mail address where the alert messages will be sent. Alerts include system errors, attacks and attempted access to blocked web sites. If this field is left blank, alert messages will not be sent via E-mail.
Alarm Interval	Specify how often the alarm should be updated.
Active Log	
System Log	Select the categories of system logs that you want to record.
Security Log	Select the categories of security logs that you want to record.
Apply	Click Apply to save your changes.
Cancel	Click Cancel to restore your previously saved settings.

35.2.1 Example E-mail Log

An "End of Log" message displays for each mail in which a complete log has been sent. The following is an example of a log sent by e-mail.

- You may edit the subject title.
- The date format here is Day-Month-Year.
- The date format here is Month-Day-Year. The time format is Hour-Minute-Second.
- "End of Log" message shows that a complete log has been sent.

Figure 151 E-mail Log Example

```

Subject:
    Firewall Alert From
Date:
    Fri, 07 Apr 2000 10:05:42
From:
    user@zyxel.com
To:
    user@zyxel.com
1|Apr 7 00 |From:192.168.1.1      To:192.168.1.255  |default policy |forward
  |09:54:03 |UDP      src port:00520 dest port:00520  |<1,00>         |
2|Apr 7 00  |From:192.168.1.131   To:192.168.1.255  |default policy |forward
  |09:54:17  |UDP      src port:00520 dest port:00520  |<1,00>         |
3|Apr 7 00  |From:192.168.1.6     To:10.10.10.10   |match          |forward
  |09:54:19  |UDP      src port:03516 dest port:00053  |<1,01>         |
.....{snip}.....
.....{snip}.....
126|Apr 7 00  |From:192.168.1.1     To:192.168.1.255  |match          |forward
   |10:05:00  |UDP      src port:00520 dest port:00520  |<1,02>         |
127|Apr 7 00  |From:192.168.1.131   To:192.168.1.255  |match          |forward
   |10:05:17  |UDP      src port:00520 dest port:00520  |<1,02>         |
128|Apr 7 00  |From:192.168.1.1     To:192.168.1.255  |match          |forward
   |10:05:30  |UDP      src port:00520 dest port:00520  |<1,02>         |

End of Firewall Log

```

Firmware Upgrade

36.1 Overview

This chapter explains how to upload new firmware to your VMG. You can download new firmware releases from your nearest ZyXEL FTP site (or www.zyxel.com) to use to upgrade your device's performance.

Only use firmware for your device's specific model. Refer to the label on the bottom of your VMG.

36.2 The Firmware Screen

Click **Maintenance > Firmware Upgrade** to open the following screen. The upload process uses HTTP (Hypertext Transfer Protocol) and may take up to two minutes. After a successful upload, the system will reboot.

Do NOT turn off the VMG while firmware upload is in progress!

Figure 152 Maintenance > Firmware Upgrade

The screenshot shows a web interface for firmware upgrade. It has two main sections:

- Upgrade Firmware:** Shows 'Current Firmware Version: V5.11(ABAA.0)C0'. Below it is a 'File Path:' label, a 'Choose File' button, and the text 'No file chosen'. An 'Upload' button is located to the right.
- Upgrade WWAN Package:** Shows 'Current WWAN Package Version: 1.11'. Below it is a 'File Path:' label, a 'Choose File' button, and the text 'No file chosen'. An 'Upload' button is located to the right.

The following table describes the labels in this screen. After you see the firmware updating screen, wait two minutes before logging into the VMG again.

Table 121 Maintenance > Firmware Upgrade

LABEL	DESCRIPTION
Upgrade Firmware	
Current Firmware Version	This is the present Firmware version and the date created.
File Path	Type in the location of the file you want to upload in this field or click Choose File to find it.

Table 121 Maintenance > Firmware Upgrade

LABEL	DESCRIPTION
Choose File	Click this to find the .bin file you want to upload. Remember that you must decompress compressed (.zip) files before you can upload them.
Upload	Click this to begin the upload process. This process may take up to two minutes.
Upgrade WWAN Package	
Current WWAN Package Version	This is the present WWAN Package version and the date created.
File Path	Type in the location of the file you want to upload in this field or click Choose File to find it.
Choose File	Click this to find the .bin file you want to upload. Remember that you must decompress compressed (.zip) files before you can upload them.
Upload	Click this to begin the upload process. This process may take up to two minutes.

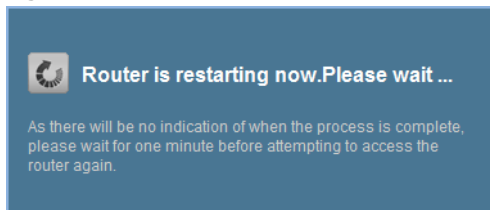
Figure 153 Firmware Uploading

The VMG automatically restarts in this time causing a temporary network disconnect. In some operating systems, you may see the following icon on your desktop.

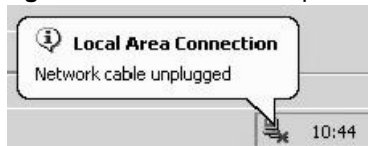
Figure 154 Network Temporarily Disconnected

After two minutes, log in again and check your new firmware version in the **Status** screen.

If the upload was not successful, the following screen will appear. Click **OK** to go back to the **Firmware Upgrade** screen.

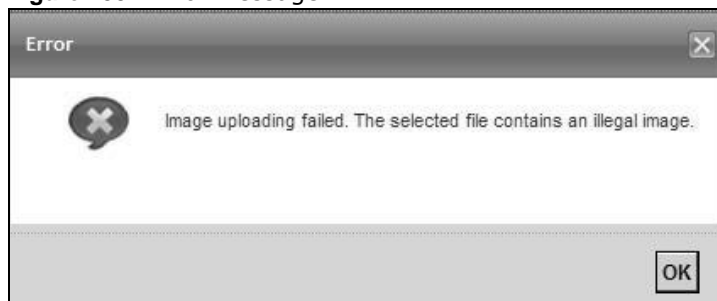
Figure 155 Error Message

Backup Restore

37.1 Overview

The **Backup Restore** screen allows you to backup and restore device configurations. You can also reset your device settings back to the factory default.

37.2 The Backup Restore Screen

Click **Maintenance > Backup Restore**. Information related to factory defaults, backup configuration, and restoring configuration appears in this screen, as shown next.

Figure 156 Maintenance > Backup Restore

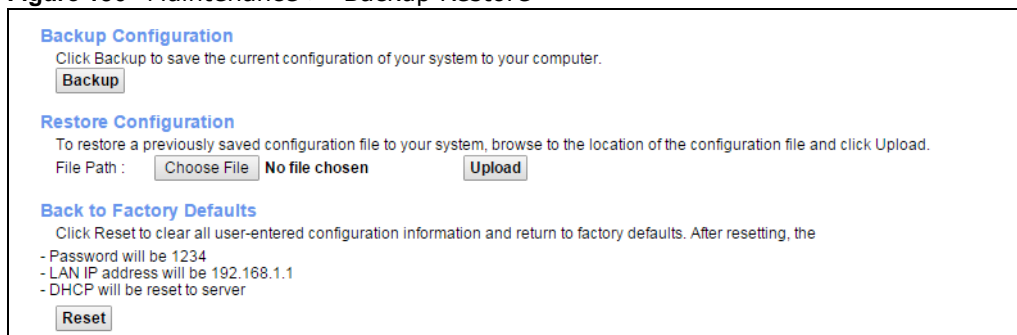

Backup Configuration
Click Backup to save the current configuration of your system to your computer.

Restore Configuration
To restore a previously saved configuration file to your system, browse to the location of the configuration file and click Upload.
File Path : No file chosen

Back to Factory Defaults
Click Reset to clear all user-entered configuration information and return to factory defaults. After resetting, the
- Password will be 1234
- LAN IP address will be 192.168.1.1
- DHCP will be reset to server

Backup Configuration

Backup Configuration allows you to back up (save) the VMG's current configuration to a file on your computer. Once your VMG is configured and functioning properly, it is highly recommended that you back up your configuration file before making configuration changes. The backup configuration file will be useful in case you need to return to your previous settings.

Click **Backup** to save the VMG's current configuration to your computer.

Restore Configuration

Restore Configuration allows you to upload a new or previously saved configuration file from your computer to your VMG.

Table 122 Restore Configuration

LABEL	DESCRIPTION
File Path	Type in the location of the file you want to upload in this field or click Choose File to find it.
Choose File	Click this to find the file you want to upload. Remember that you must decompress compressed (.ZIP) files before you can upload them.
Upload	Click this to begin the upload process.

Do not turn off the VMG while configuration file upload is in progress.

After the VMG configuration has been restored successfully, the login screen appears. Login again to restart the VMG.

The VMG automatically restarts in this time causing a temporary network disconnect. In some operating systems, you may see the following icon on your desktop.

Figure 157 Network Temporarily Disconnected



If you uploaded the default configuration file you may need to change the IP address of your computer to be in the same subnet as that of the default device IP address (192.168.1.1).

If the upload was not successful, the following screen will appear. Click **OK** to go back to the **Configuration** screen.

Figure 158 Configuration Upload Error

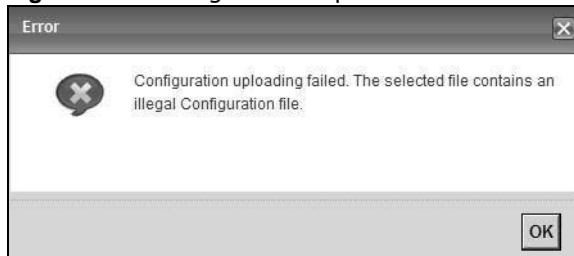

Reset to Factory Defaults

Click the **Reset** button to clear all user-entered configuration information and return the VMG to its factory defaults. The following warning screen appears.

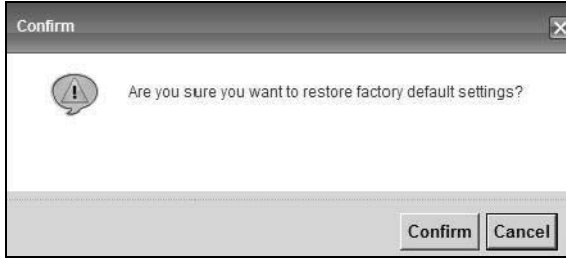
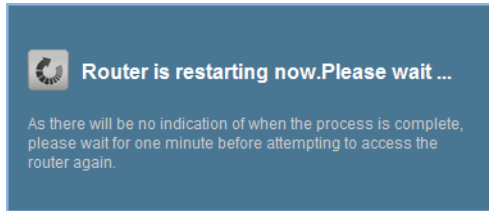
Figure 159 Reset Warning Message**Figure 160** Reset In Process Message

You can also press the **RESET** button on the rear panel to reset the factory defaults of your VMG. Refer to [Section 1.6 on page 19](#) for more information on the **RESET** button.

37.3 The Reboot Screen

System restart allows you to reboot the VMG remotely without turning the power off. You may need to do this if the VMG hangs, for example.

Click **Maintenance > Reboot**. Click **Reboot** to have the VMG reboot. This does not affect the VMG's configuration.

Figure 161 Maintenance > Reboot

38.1 Overview

The **Diagnostic** screens display information to help you identify problems with the VMG.

The route between a CO VDSL switch and one of its CPE may go through switches owned by independent organizations. A connectivity fault point generally takes time to discover and impacts subscriber's network access. In order to eliminate the management and maintenance efforts, IEEE 802.1ag is a Connectivity Fault Management (CFM) specification which allows network administrators to identify and manage connection faults. Through discovery and verification of the path, CFM can detect, analyze and isolate connectivity faults in bridged LANs.

38.1.1 What You Can Do in this Chapter

- The **Ping & TraceRoute & NsLookup** screen lets you ping an IP address or trace the route packets take to a host ([Section 38.3 on page 254](#)).
- The **802.1ag** screen lets you perform CFM actions ([Section 38.5 on page 255](#)).
- The **OAM Ping** screen lets you send an ATM OAM (Operation, Administration and Maintenance) packet to verify the connectivity of a specific PVC. ([Section 38.5 on page 255](#)).

38.2 What You Need to Know

The following terms and concepts may help as you read through this chapter.

How CFM Works

A Maintenance Association (MA) defines a VLAN and associated Maintenance End Point (MEP) ports on the device under a Maintenance Domain (MD) level. An MEP port has the ability to send Connectivity Check Messages (CCMs) and get other MEP ports information from neighbor devices' CCMs within an MA.

CFM provides two tests to discover connectivity faults.

- Loopback test - checks if the MEP port receives its Loop Back Response (LBR) from its target after it sends the Loop Back Message (LBM). If no response is received, there might be a connectivity fault between them.
- Link trace test - provides additional connectivity fault analysis to get more information on where the fault is. If an MEP port does not respond to the source MEP, this may indicate a fault. Administrators can take further action to check and resume services from the fault according to the line connectivity status report.

38.3 Ping & TraceRoute & NsLookup

Use this screen to ping, traceroute, or nslookup an IP address. Click **Maintenance > Diagnostic > Ping&TraceRoute&NsLookup** to open the screen shown next.

Figure 162 Maintenance > Diagnostic > Ping & TraceRoute & NsLookup

The screenshot shows a web interface for network diagnostics. At the top, it says 'Ping/TraceRoute Test' and 'Info-'. Below this is a large, empty rectangular area for displaying test results. At the bottom of the interface, there is a section labeled 'TCP/IP' which contains an 'Address' input field and three buttons: 'Ping', 'Trace Route', and 'Nslookup'.

The following table describes the fields in this screen.

Table 123 Maintenance > Diagnostic > Ping & TraceRoute & NsLookup

LABEL	DESCRIPTION
URL or IP Address	Type the IP address of a computer that you want to perform ping, traceroute, or nslookup in order to test a connection.
Ping	Click this to ping the IP address that you entered.
TraceRoute	Click this button to perform the traceroute function. This determines the path a packet takes to the specified computer.
Nslookup	Click this button to perform a DNS lookup on the IP address of a computer you enter.

38.4 802.1ag

Click **Maintenance > Diagnostic > 8.2.1ag** to open the following screen. Use this screen to perform CFM actions.

Figure 163 Maintenance > Diagnostic > 802.1ag

The following table describes the fields in this screen.

Table 124 Maintenance > Diagnostic > 802.1ag

LABEL	DESCRIPTION
802.1ag Connectivity Fault Management	
Maintenance Domain (MD) Level	Select a level (0-7) under which you want to create an MA.
Destination MAC Address	Enter the target device's MAC address to which the VMG performs a CFM loopback test.
802.1Q VLAN ID	Type a VLAN ID (0-4095) for this MA.
VDSL Traffic Type	This shows whether the VDSL traffic is activated.
Loopback Message (LBM)	This shows how many Loop Back Messages (LBMs) are sent and if there is any in-order or out-of-order Loop Back Response (LBR) received from a remote MEP.
Linktrace Message (LTM)	This shows the destination MAC address in the Link Trace Response (LTR).
Set MD Level	Click this button to configure the MD (Maintenance Domain) level.
Send Loopback	Click this button to have the selected MEP send the LBM (Loop Back Message) to a specified remote end point.
Send Linktrace	Click this button to have the selected MEP send the LTMs (Link Trace Messages) to a specified remote end point.

38.5 OAM Ping

Click **Maintenance > Diagnostic > OAM Ping** to open the screen shown next. Use this screen to perform an OAM (Operation, Administration and Maintenance) F4 or F5 loopback test on a PVC. The VMG sends an OAM F4 or F5 packet to the DSLAM or ATM switch and then returns it to the VMG. The test result then displays in the text box.

ATM sets up virtual circuits over which end systems communicate. The terminology for virtual circuits is as follows:

- Virtual Channel (VC) Logical connections between ATM devices
- Virtual Path (VP) A bundle of virtual channels
- Virtual Circuits A series of virtual paths between circuit end points

Figure 164 Virtual Circuit Topology

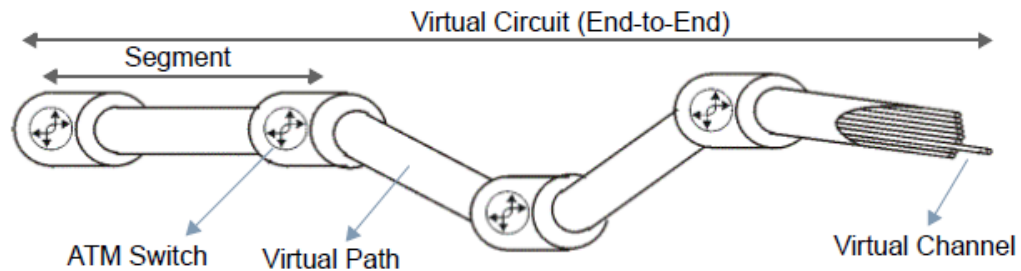

Think of a virtual path as a cable that contains a bundle of wires. The cable connects two points and wires within the cable provide individual circuits between the two points. In an ATM cell header, a VPI (Virtual Path Identifier) identifies a link formed by a virtual path; a VCI (Virtual Channel Identifier) identifies a channel within a virtual path. A series of virtual paths make up a virtual circuit.

F4 cells operate at the virtual path (VP) level, while F5 cells operate at the virtual channel (VC) level. F4 cells use the same VPI as the user data cells on VP connections, but use different predefined VCI values. F5 cells use the same VPI and VCI as the user data cells on the VC connections, and are distinguished from data cells by a predefined Payload Type Identifier (PTI) in the cell header. Both F4 flows and F5 flows are bidirectional and have two types.

- segment F4 flows (VCI=3)
- end-to-end F4 flows (VCI=4)
- segment F5 flows (PTI=100)
- end-to-end F5 flows (PTI=101)

OAM F4 or F5 tests are used to check virtual path or virtual channel availability between two DSL devices. Segment flows are terminated at the connecting point which terminates a VP or VC segment. End-to-end flows are terminated at the end point of a VP or VC connection, where an ATM link is terminated. Segment loopback tests allow you to verify integrity of a PVC to the nearest neighboring ATM device. End-to-end loopback tests allow you to verify integrity of an end-to-end PVC.

Note: The DSLAM to which the VMG is connected must also support ATM F4 and/or F5 to use this test.

Note: This screen is available only when you configure an ATM layer-2 interface.

Figure 165 Maintenance > Diagnostic > OAM Ping

The following table describes the fields in this screen.

Table 125 Maintenance > Diagnostic > OAM Ping

LABEL	DESCRIPTION
	Select a PVC on which you want to perform the loopback test.
F4 segment	Press this to perform an OAM F4 segment loopback test.
F4 end-end	Press this to perform an OAM F4 end-to-end loopback test.
F5 segment	Press this to perform an OAM F5 segment loopback test.
F5 end-end	Press this to perform an OAM F5 end-to-end loopback test.

Troubleshooting

This chapter offers some suggestions to solve problems you might encounter. The potential problems are divided into the following categories.

- [Power, Hardware Connections, and LEDs](#)
- [VMG Access and Login](#)
- [Internet Access](#)
- [Wireless Internet Access](#)
- [USB Device Connection](#)
- [UPnP](#)

39.1 Power, Hardware Connections, and LEDs

The VMG does not turn on. None of the LEDs turn on.

- 1 Make sure the VMG is turned on.
- 2 Make sure you are using the power adaptor or cord included with the VMG.
- 3 Make sure the power adaptor or cord is connected to the VMG and plugged in to an appropriate power source. Make sure the power source is turned on.
- 4 Turn the VMG off and on.
- 5 If the problem continues, contact the vendor.

One of the LEDs does not behave as expected.

- 1 Make sure you understand the normal behavior of the LED. See [Section 1.5 on page 17](#).
- 2 Check the hardware connections.
- 3 Inspect your cables for damage. Contact the vendor to replace any damaged cables.
- 4 Turn the VMG off and on.

- 5 If the problem continues, contact the vendor.

39.2 VMG Access and Login

I forgot the IP address for the VMG.

- 1 The default LAN IP address is 192.168.1.1.
- 2 If you changed the IP address and have forgotten it, you might get the IP address of the VMG by looking up the IP address of the default gateway for your computer. To do this in most Windows computers, click **Start > Run**, enter **cmd**, and then enter **ipconfig**. The IP address of the **Default Gateway** might be the IP address of the VMG (it depends on the network), so enter this IP address in your Internet browser.
- 3 If this does not work, you have to reset the device to its factory defaults. See [Section 1.6 on page 19](#).

I forgot the password.

- 1 See the cover page for the default login names and associated passwords.
- 2 If those do not work, you have to reset the device to its factory defaults. See [Section 1.6 on page 19](#).

I cannot see or access the **Login** screen in the web configurator.

- 1 Make sure you are using the correct IP address.
 - The default IP address is [192.168.1.1](#).
 - If you changed the IP address ([Section 8.2 on page 118](#)), use the new IP address.
 - If you changed the IP address and have forgotten it, see the troubleshooting suggestions for [I forgot the IP address for the VMG](#).
- 2 Check the hardware connections, and make sure the LEDs are behaving as expected. See [Section 1.5 on page 17](#).
- 3 Make sure your Internet browser does not block pop-up windows and has JavaScripts and Java enabled.
- 4 If it is possible to log in from another interface, check the service control settings for HTTP and HTTPS (**Maintenance > Remote Management**).

- 5 Reset the device to its factory defaults, and try to access the VMG with the default IP address. See [Section 1.6 on page 19](#).
- 6 If the problem continues, contact the network administrator or vendor, or try one of the advanced suggestions.

Advanced Suggestions

- Make sure you have logged out of any earlier management sessions using the same user account even if they were through a different interface or using a different browser.
- Try to access the VMG using another service, such as Telnet. If you can access the VMG, check the remote management settings and firewall rules to find out why the VMG does not respond to HTTP.

I can see the **Login** screen, but I cannot log in to the VMG.

- 1 Make sure you have entered the password correctly. See the cover page for the default login names and associated passwords. The field is case-sensitive, so make sure [Caps Lock] is not on.
- 2 You cannot log in to the web configurator while someone is using Telnet to access the VMG. Log out of the VMG in the other session, or ask the person who is logged in to log out.
- 3 Turn the VMG off and on.
- 4 If this does not work, you have to reset the device to its factory defaults. See [Section 39.1 on page 258](#).

I cannot Telnet to the VMG.

See the troubleshooting suggestions for [I cannot see or access the Login screen in the web configurator](#). Ignore the suggestions about your browser.

I cannot use FTP to upload / download the configuration file. / I cannot use FTP to upload new firmware.

See the troubleshooting suggestions for [I cannot see or access the Login screen in the web configurator](#). Ignore the suggestions about your browser.

39.3 Internet Access

I cannot access the Internet.

- 1 Check the hardware connections, and make sure the LEDs are behaving as expected. See the **Quick Start Guide** and [Section 1.5 on page 17](#).
 - 2 Make sure you entered your ISP account information correctly in the **Network Setting > Broadband** screen. These fields are case-sensitive, so make sure [Caps Lock] is not on.
 - 3 If you are trying to access the Internet wirelessly, make sure that you enabled the wireless LAN in the VMG and your wireless client and that the wireless settings in the wireless client are the same as the settings in the VMG.
 - 4 Disconnect all the cables from your device and reconnect them.
 - 5 If the problem continues, contact your ISP.
-

I cannot access the Internet through a DSL connection.

- 1 Make sure you have the **DSL WAN** port connected to a telephone jack (or the DSL or modem jack on a splitter if you have one).
 - 2 Make sure you configured a proper DSL WAN interface (**Network Setting > Broadband** screen) with the Internet account information provided by your ISP and that it is enabled.
 - 3 Check that the LAN interface you are connected to is in the same interface group as the DSL connection (**Network Setting > Interface Grouping**).
 - 4 If you set up a WAN connection using bridging service, make sure you turn off the DHCP feature in the **LAN** screen to have the clients get WAN IP addresses directly from your ISP's DHCP server.
-

I cannot connect to the Internet using a second DSL connection.

ADSL and VDSL connections cannot work at the same time. You can only use one type of DSL connection, either ADSL or VDSL connection at one time.

I cannot connect to the Internet using an Ethernet connection.

- 1 The DSL connection has priority. If the DSL connection is up, then the Ethernet connection will be down.
-

- 2 Make sure you have the Ethernet WAN port connected to a Modem or Router.
- 3 Make sure you configured a proper Ethernet WAN interface (**Network Setting > Broadband** screen) with the Internet account information provided by your ISP and that it is enabled.
- 4 Check that the WAN interface you are connected to is in the same interface group as the Ethernet connection (**Network Setting > Interface Grouping**).
- 5 If you set up a WAN connection using bridging service, make sure you turn off the DHCP feature in the **LAN** screen to have the clients get WAN IP addresses directly from your ISP's DHCP server.

I cannot connect to the Internet using a 3G connection.

- 1 The DSL and Ethernet connections have priority in that order. If the DSL or Ethernet connection is up, then the 3G connection will be down.
- 2 Make sure you have connected a compatible 3G dongle to the USB port.
- 3 Make sure you have configured **Network Setting > Broadband > 3G Backup** correctly.
- 4 Check that the VMG is within range of a 3G base station.

I cannot access the VMG anymore. I had access to the VMG, but my connection is not available anymore.

- 1 Your session with the VMG may have expired. Try logging into the VMG again.
- 2 Check the hardware connections, and make sure the LEDs are behaving as expected. See the **Quick Start Guide** and [Section 1.5 on page 17](#).
- 3 Turn the VMG off and on.
- 4 If the problem continues, contact your vendor.

39.4 Wireless Internet Access

What factors may cause intermittent or unstabled wireless connection? How can I solve this problem?

The following factors may cause interference:

- Obstacles: walls, ceilings, furniture, and so on.
- Building Materials: metal doors, aluminum studs.

- Electrical devices: microwaves, monitors, electric motors, cordless phones, and other wireless devices.

To optimize the speed and quality of your wireless connection, you can:

- Move your wireless device closer to the AP if the signal strength is low.
- Reduce wireless interference that may be caused by other wireless networks or surrounding wireless electronics such as cordless phones.
- Place the AP where there are minimum obstacles (such as walls and ceilings) between the AP and the wireless client.
- Reduce the number of wireless clients connecting to the same AP simultaneously, or add additional APs if necessary.
- Try closing some programs that use the Internet, especially peer-to-peer applications. If the wireless client is sending or receiving a lot of information, it may have too many programs open that use the Internet.

What is a Service Set ID (SSID)?

An SSID is a name that uniquely identifies a wireless network. The AP and all the clients within a wireless network must use the same SSID.

39.5 USB Device Connection

The VMG fails to detect my USB device.

- 1 Disconnect the USB device.
- 2 If you are connecting a USB hard drive that comes with an external power supply, make sure it is connected to an appropriate power source that is on.
- 3 Re-connect your USB device to the VMG.

39.6 UPnP

When using UPnP and the VMG reboots, my computer cannot detect UPnP and refresh **My Network Places > Local Network**.

- 1 Disconnect the Ethernet cable from the VMG's LAN port or from your computer.

- 2 Re-connect the Ethernet cable.

The **Local Area Connection** icon for UPnP disappears in the screen.

Restart your computer.

PART III

Appendices

Appendices contain general information. Some information may not apply to your device.

Customer Support

In the event of problems that cannot be solved by using this manual, you should contact your vendor. If you cannot contact your vendor, then contact a ZyXEL office for the region in which you bought the device.

See <http://www.zyxel.com/homepage.shtml> and also http://www.zyxel.com/about_zyxel/zyxel_worldwide.shtml for the latest information.

Please have the following information ready when you contact an office.

Required Information

- Product model and serial number.
- Warranty Information.
- Date that you received your device.
- Brief description of the problem and the steps you took to solve it.

Corporate Headquarters (Worldwide)

Taiwan

- ZyXEL Communications Corporation
- <http://www.zyxel.com>

Asia

China

- ZyXEL Communications (Shanghai) Corp.
- ZyXEL Communications (Beijing) Corp.
- ZyXEL Communications (Tianjin) Corp.
- <http://www.zyxel.cn>

India

- ZyXEL Technology India Pvt Ltd
- <http://www.zyxel.in>

Kazakhstan

- ZyXEL Kazakhstan
- <http://www.zyxel.kz>

Korea

- ZyXEL Korea Corp.
- <http://www.zyxel.kr>

Malaysia

- ZyXEL Malaysia Sdn Bhd.
- <http://www.zyxel.com.my>

Pakistan

- ZyXEL Pakistan (Pvt.) Ltd.
- <http://www.zyxel.com.pk>

Philippines

- ZyXEL Philippines
- <http://www.zyxel.com.ph>

Singapore

- ZyXEL Singapore Pte Ltd.
- <http://www.zyxel.com.sg>

Taiwan

- ZyXEL Communications Corporation
- <http://www.zyxel.com/tw/zh/>

Thailand

- ZyXEL Thailand Co., Ltd
- <http://www.zyxel.co.th>

Vietnam

- ZyXEL Communications Corporation-Vietnam Office
- <http://www.zyxel.com/vn/vi>

Europe

Austria

- ZyXEL Deutschland GmbH
- <http://www.zyxel.de>

Belarus

- ZyXEL BY
- <http://www.zyxel.by>

Belgium

- ZyXEL Communications B.V.
- <http://www.zyxel.com/be/nl/>
- <http://www.zyxel.com/be/fr/>

Bulgaria

- ZyXEL България
- <http://www.zyxel.com/bg/bg/>

Czech Republic

- ZyXEL Communications Czech s.r.o
- <http://www.zyxel.cz>

Denmark

- ZyXEL Communications A/S
- <http://www.zyxel.dk>

Estonia

- ZyXEL Estonia
- <http://www.zyxel.com/ee/et/>

Finland

- ZyXEL Communications
- <http://www.zyxel.fi>

France

- ZyXEL France
- <http://www.zyxel.fr>

Germany

- ZyXEL Deutschland GmbH
- <http://www.zyxel.de>

Hungary

- ZyXEL Hungary & SEE
- <http://www.zyxel.hu>

Italy

- ZyXEL Communications Italy
- <http://www.zyxel.it/>

Latvia

- ZyXEL Latvia
- <http://www.zyxel.com/lv/lv/homepage.shtml>

Lithuania

- ZyXEL Lithuania
- <http://www.zyxel.com/lt/lt/homepage.shtml>

Netherlands

- ZyXEL Benelux
- <http://www.zyxel.nl>

Norway

- ZyXEL Communications
- <http://www.zyxel.no>

Poland

- ZyXEL Communications Poland
- <http://www.zyxel.pl>

Romania

- ZyXEL Romania
- <http://www.zyxel.com/ro/ro>

Russia

- ZyXEL Russia
- <http://www.zyxel.ru>

Slovakia

- ZyXEL Communications Czech s.r.o. organizacna zlozka
- <http://www.zyxel.sk>

Spain

- ZyXEL Communications ES Ltd
- <http://www.zyxel.es>

Sweden

- ZyXEL Communications
- <http://www.zyxel.se>

Switzerland

- Studerus AG

- <http://www.zyxel.ch/>

Turkey

- ZyXEL Turkey A.S.
- <http://www.zyxel.com.tr>

UK

- ZyXEL Communications UK Ltd.
- <http://www.zyxel.co.uk>

Ukraine

- ZyXEL Ukraine
- <http://www.ua.zyxel.com>

Latin America

Argentina

- ZyXEL Communication Corporation
- <http://www.zyxel.com/ec/es/>

Brazil

- ZyXEL Communications Brasil Ltda.
- <https://www.zyxel.com/br/pt/>

Ecuador

- ZyXEL Communication Corporation
- <http://www.zyxel.com/ec/es/>

Middle East

Israel

- ZyXEL Communication Corporation
- <http://il.zyxel.com/homepage.shtml>

Middle East

- ZyXEL Communication Corporation
- <http://www.zyxel.com/me/en/>

North America

USA

- ZyXEL Communications, Inc. - North America Headquarters
- <http://www.zyxel.com/us/en/>

Oceania

Australia

- ZyXEL Communications Corporation
- <http://www.zyxel.com/au/en/>

Africa

South Africa

- Nology (Pty) Ltd.
- <http://www.zyxel.co.za>

Wireless LANs

Wireless LAN Topologies

This section discusses ad-hoc and infrastructure wireless LAN topologies.

Ad-hoc Wireless LAN Configuration

The simplest WLAN configuration is an independent (Ad-hoc) WLAN that connects a set of computers with wireless adapters (A, B, C). Any time two or more wireless adapters are within range of each other, they can set up an independent network, which is commonly referred to as an ad-hoc network or Independent Basic Service Set (IBSS). The following diagram shows an example of notebook computers using wireless adapters to form an ad-hoc wireless LAN.

Figure 166 Peer-to-Peer Communication in an Ad-hoc Network

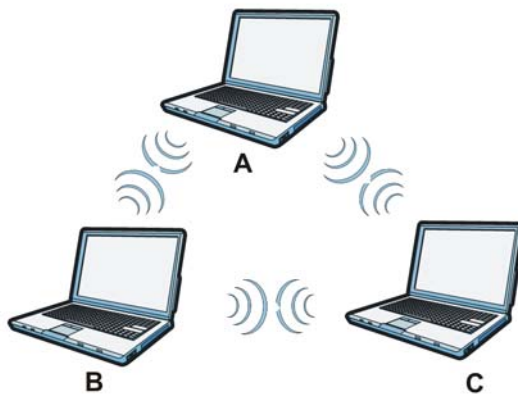

BSS

A Basic Service Set (BSS) exists when all communications between wireless clients or between a wireless client and a wired network client go through one access point (AP).

Intra-BSS traffic is traffic between wireless clients in the BSS. When Intra-BSS is enabled, wireless client **A** and **B** can access the wired network and communicate with each other. When Intra-BSS is disabled, wireless client **A** and **B** can still access the wired network but cannot communicate with each other.

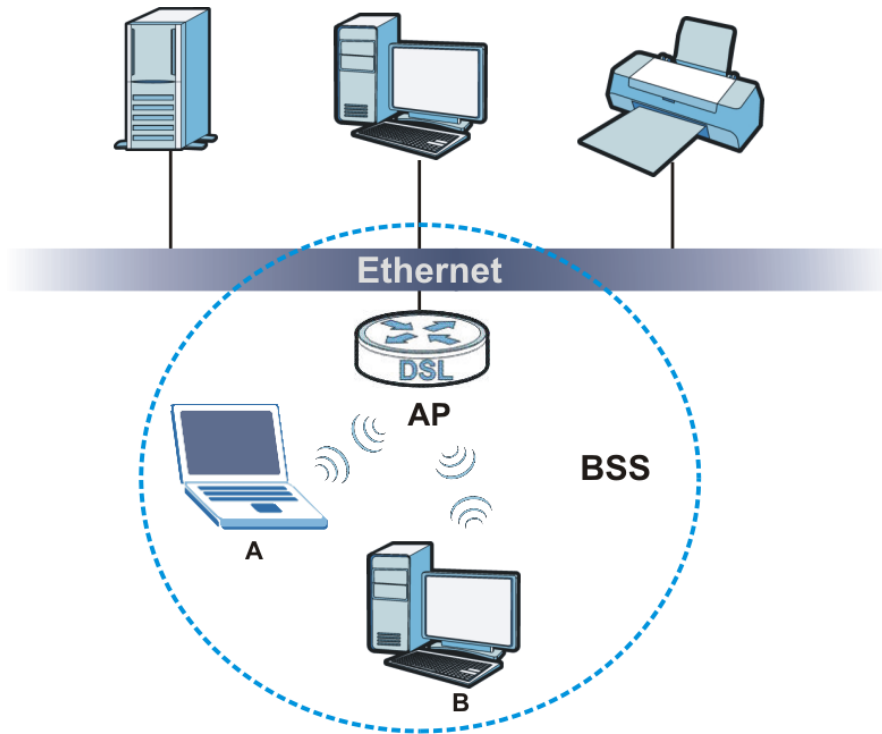
Figure 167 Basic Service Set

ESS

An Extended Service Set (ESS) consists of a series of overlapping BSSs, each containing an access point, with each access point connected together by a wired network. This wired connection between APs is called a Distribution System (DS).

This type of wireless LAN topology is called an Infrastructure WLAN. The Access Points not only provide communication with the wired network but also mediate wireless network traffic in the immediate neighborhood.

An ESSID (ESS IDentification) uniquely identifies each ESS. All access points and their associated wireless clients within the same ESS must have the same ESSID in order to communicate.

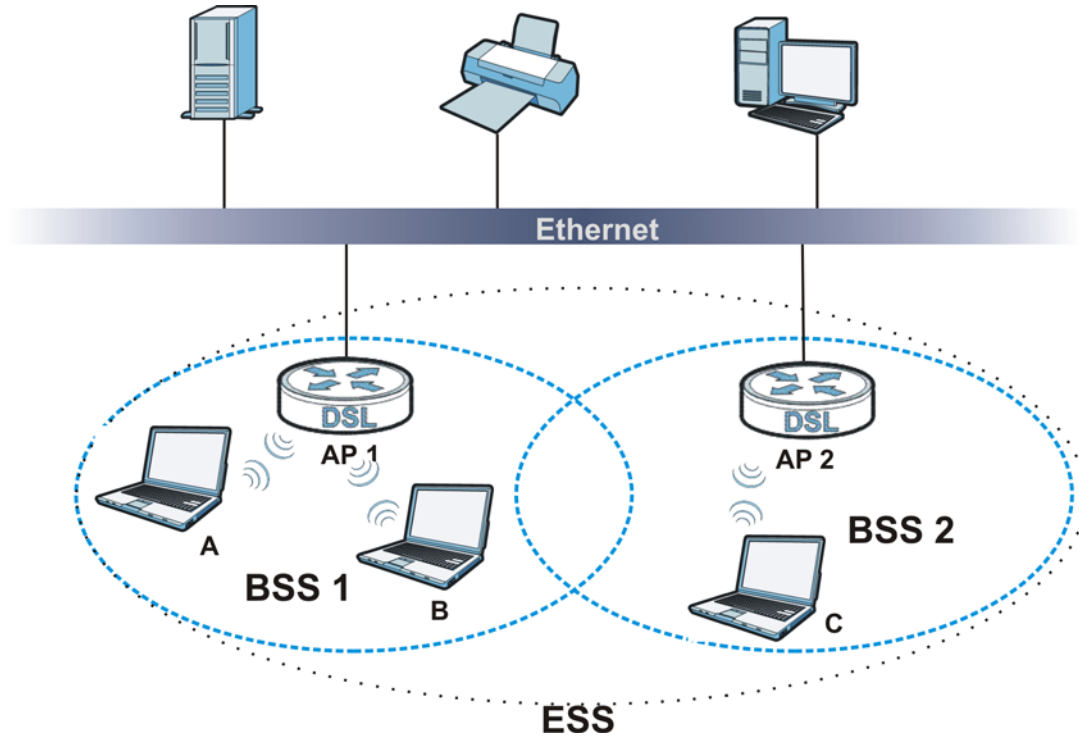
Figure 168 Infrastructure WLAN

Channel

A channel is the radio frequency(ies) used by wireless devices to transmit and receive data. Channels available depend on your geographical area. You may have a choice of channels (for your region) so you should use a channel different from an adjacent AP (access point) to reduce interference. Interference occurs when radio signals from different access points overlap causing interference and degrading performance.

Adjacent channels partially overlap however. To avoid interference due to overlap, your AP should be on a channel at least five channels away from a channel that an adjacent AP is using. For example, if your region has 11 channels and an adjacent AP is using channel 1, then you need to select a channel between 6 or 11.

RTS/CTS

A hidden node occurs when two stations are within range of the same access point, but are not within range of each other. The following figure illustrates a hidden node. Both stations (STA) are within range of the access point (AP) or wireless gateway, but out-of-range of each other, so they cannot "hear" each other, that is they do not know if the channel is currently being used. Therefore, they are considered hidden from each other.

Figure 169 RTS/CTS

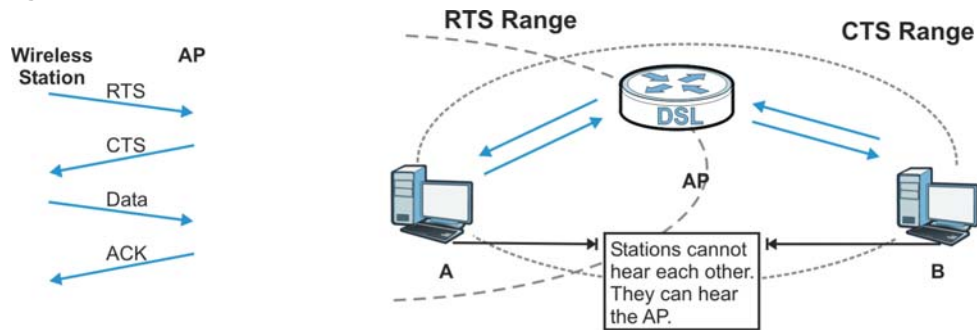

When station **A** sends data to the AP, it might not know that the station **B** is already using the channel. If these two stations send data at the same time, collisions may occur when both sets of data arrive at the AP at the same time, resulting in a loss of messages for both stations.

RTS/CTS is designed to prevent collisions due to hidden nodes. An **RTS/CTS** defines the biggest size data frame you can send before an RTS (Request To Send)/CTS (Clear to Send) handshake is invoked.

When a data frame exceeds the **RTS/CTS** value you set (between 0 to 2432 bytes), the station that wants to transmit this frame must first send an RTS (Request To Send) message to the AP for permission to send it. The AP then responds with a CTS (Clear to Send) message to all other stations within its range to notify them to defer their transmission. It also reserves and confirms with the requesting station the time frame for the requested transmission.

Stations can send frames smaller than the specified **RTS/CTS** directly to the AP without the RTS (Request To Send)/CTS (Clear to Send) handshake.

You should only configure **RTS/CTS** if the possibility of hidden nodes exists on your network and the "cost" of resending large frames is more than the extra network overhead involved in the RTS (Request To Send)/CTS (Clear to Send) handshake.

If the **RTS/CTS** value is greater than the **Fragmentation Threshold** value (see next), then the RTS (Request To Send)/CTS (Clear to Send) handshake will never occur as data frames will be fragmented before they reach **RTS/CTS** size.

Note: Enabling the RTS Threshold causes redundant network overhead that could negatively affect the throughput performance instead of providing a remedy.

Fragmentation Threshold

A **Fragmentation Threshold** is the maximum data fragment size (between 256 and 2432 bytes) that can be sent in the wireless network before the AP will fragment the packet into smaller data frames.

A large **Fragmentation Threshold** is recommended for networks not prone to interference while you should set a smaller threshold for busy networks or networks that are prone to interference.

If the **Fragmentation Threshold** value is smaller than the **RTS/CTS** value (see previously) you set then the RTS (Request To Send)/CTS (Clear to Send) handshake will never occur as data frames will be fragmented before they reach **RTS/CTS** size.

IEEE 802.11g Wireless LAN

IEEE 802.11g is fully compatible with the IEEE 802.11b standard. This means an IEEE 802.11b adapter can interface directly with an IEEE 802.11g access point (and vice versa) at 11 Mbps or lower depending on range. IEEE 802.11g has several intermediate rate steps between the maximum and minimum data rates. The IEEE 802.11g data rate and modulation are as follows:

Table 126 IEEE 802.11g

DATA RATE (MBPS)	MODULATION
1	DBPSK (Differential Binary Phase Shift Keyed)
2	DQPSK (Differential Quadrature Phase Shift Keying)
5.5 / 11	CCK (Complementary Code Keying)
6/9/12/18/24/36/48/ 54	OFDM (Orthogonal Frequency Division Multiplexing)

Wireless Security Overview

Wireless security is vital to your network to protect wireless communication between wireless clients, access points and the wired network.

Wireless security methods available on the VMG are data encryption, wireless client authentication, restricting access by device MAC address and hiding the VMG identity.

The following figure shows the relative effectiveness of these wireless security methods available on your VMG.

Table 127 Wireless Security Levels

SECURITY LEVEL	SECURITY TYPE
Least Secure	Unique SSID (Default)
	Unique SSID with Hide SSID Enabled
	MAC Address Filtering
	WEP Encryption
	IEEE802.1x EAP with RADIUS Server Authentication
Most Secure	Wi-Fi Protected Access (WPA)
	WPA2

Note: You must enable the same wireless security settings on the VMG and on all wireless clients that you want to associate with it.

IEEE 802.1x

In June 2001, the IEEE 802.1x standard was designed to extend the features of IEEE 802.11 to support extended authentication as well as providing additional accounting and control features. It is supported by Windows XP and a number of network devices. Some advantages of IEEE 802.1x are:

- User based identification that allows for roaming.

- Support for RADIUS (Remote Authentication Dial In User Service, RFC 2138, 2139) for centralized user profile and accounting management on a network RADIUS server.
- Support for EAP (Extensible Authentication Protocol, RFC 2486) that allows additional authentication methods to be deployed with no changes to the access point or the wireless clients.

RADIUS

RADIUS is based on a client-server model that supports authentication, authorization and accounting. The access point is the client and the server is the RADIUS server. The RADIUS server handles the following tasks:

- Authentication
Determines the identity of the users.
- Authorization
Determines the network services available to authenticated users once they are connected to the network.
- Accounting
Keeps track of the client's network activity.

RADIUS is a simple package exchange in which your AP acts as a message relay between the wireless client and the network RADIUS server.

Types of RADIUS Messages

The following types of RADIUS messages are exchanged between the access point and the RADIUS server for user authentication:

- Access-Request
Sent by an access point requesting authentication.
- Access-Reject
Sent by a RADIUS server rejecting access.
- Access-Accept
Sent by a RADIUS server allowing access.
- Access-Challenge
Sent by a RADIUS server requesting more information in order to allow access. The access point sends a proper response from the user and then sends another Access-Request message.

The following types of RADIUS messages are exchanged between the access point and the RADIUS server for user accounting:

- Accounting-Request
Sent by the access point requesting accounting.
- Accounting-Response
Sent by the RADIUS server to indicate that it has started or stopped accounting.

In order to ensure network security, the access point and the RADIUS server use a shared secret key, which is a password, they both know. The key is not sent over the network. In addition to the

shared key, password information exchanged is also encrypted to protect the network from unauthorized access.

Types of EAP Authentication

This section discusses some popular authentication types: EAP-MD5, EAP-TLS, EAP-TTLS, PEAP and LEAP. Your wireless LAN device may not support all authentication types.

EAP (Extensible Authentication Protocol) is an authentication protocol that runs on top of the IEEE 802.1x transport mechanism in order to support multiple types of user authentication. By using EAP to interact with an EAP-compatible RADIUS server, an access point helps a wireless station and a RADIUS server perform authentication.

The type of authentication you use depends on the RADIUS server and an intermediary AP(s) that supports IEEE 802.1x.

For EAP-TLS authentication type, you must first have a wired connection to the network and obtain the certificate(s) from a certificate authority (CA). A certificate (also called digital IDs) can be used to authenticate users and a CA issues certificates and guarantees the identity of each certificate owner.

EAP-MD5 (Message-Digest Algorithm 5)

MD5 authentication is the simplest one-way authentication method. The authentication server sends a challenge to the wireless client. The wireless client 'proves' that it knows the password by encrypting the password with the challenge and sends back the information. Password is not sent in plain text.

However, MD5 authentication has some weaknesses. Since the authentication server needs to get the plaintext passwords, the passwords must be stored. Thus someone other than the authentication server may access the password file. In addition, it is possible to impersonate an authentication server as MD5 authentication method does not perform mutual authentication. Finally, MD5 authentication method does not support data encryption with dynamic session key. You must configure WEP encryption keys for data encryption.

EAP-TLS (Transport Layer Security)

With EAP-TLS, digital certifications are needed by both the server and the wireless clients for mutual authentication. The server presents a certificate to the client. After validating the identity of the server, the client sends a different certificate to the server. The exchange of certificates is done in the open before a secured tunnel is created. This makes user identity vulnerable to passive attacks. A digital certificate is an electronic ID card that authenticates the sender's identity. However, to implement EAP-TLS, you need a Certificate Authority (CA) to handle certificates, which imposes a management overhead.

EAP-TTLS (Tunneled Transport Layer Service)

EAP-TTLS is an extension of the EAP-TLS authentication that uses certificates for only the server-side authentications to establish a secure connection. Client authentication is then done by sending username and password through the secure connection, thus client identity is protected. For client authentication, EAP-TTLS supports EAP methods and legacy authentication methods such as PAP, CHAP, MS-CHAP and MS-CHAP v2.

PEAP (Protected EAP)

Like EAP-TTLS, server-side certificate authentication is used to establish a secure connection, then use simple username and password methods through the secured connection to authenticate the clients, thus hiding client identity. However, PEAP only supports EAP methods, such as EAP-MD5, EAP-MSCHAPv2 and EAP-GTC (EAP-Generic Token Card), for client authentication. EAP-GTC is implemented only by Cisco.

LEAP

LEAP (Lightweight Extensible Authentication Protocol) is a Cisco implementation of IEEE 802.1x.

Dynamic WEP Key Exchange

The AP maps a unique key that is generated with the RADIUS server. This key expires when the wireless connection times out, disconnects or reauthentication times out. A new WEP key is generated each time reauthentication is performed.

If this feature is enabled, it is not necessary to configure a default encryption key in the wireless security configuration screen. You may still configure and store keys, but they will not be used while dynamic WEP is enabled.

Note: EAP-MD5 cannot be used with Dynamic WEP Key Exchange

For added security, certificate-based authentications (EAP-TLS, EAP-TTLS and PEAP) use dynamic keys for data encryption. They are often deployed in corporate environments, but for public deployment, a simple user name and password pair is more practical. The following table is a comparison of the features of authentication types.

Table 128 Comparison of EAP Authentication Types

	EAP-MD5	EAP-TLS	EAP-TTLS	PEAP	LEAP
Mutual Authentication	No	Yes	Yes	Yes	Yes
Certificate – Client	No	Yes	Optional	Optional	No
Certificate – Server	No	Yes	Yes	Yes	No
Dynamic Key Exchange	No	Yes	Yes	Yes	Yes
Credential Integrity	None	Strong	Strong	Strong	Moderate
Deployment Difficulty	Easy	Hard	Moderate	Moderate	Moderate
Client Identity Protection	No	No	Yes	Yes	No

WPA and WPA2

Wi-Fi Protected Access (WPA) is a subset of the IEEE 802.11i standard. WPA2 (IEEE 802.11i) is a wireless security standard that defines stronger encryption, authentication and key management than WPA.

Key differences between WPA or WPA2 and WEP are improved data encryption and user authentication.

If both an AP and the wireless clients support WPA2 and you have an external RADIUS server, use WPA2 for stronger data encryption. If you don't have an external RADIUS server, you should use

WPA2-PSK (WPA2-Pre-Shared Key) that only requires a single (identical) password entered into each access point, wireless gateway and wireless client. As long as the passwords match, a wireless client will be granted access to a WLAN.

If the AP or the wireless clients do not support WPA2, just use WPA or WPA-PSK depending on whether you have an external RADIUS server or not.

Select WEP only when the AP and/or wireless clients do not support WPA or WPA2. WEP is less secure than WPA or WPA2.

Encryption

WPA improves data encryption by using Temporal Key Integrity Protocol (TKIP), Message Integrity Check (MIC) and IEEE 802.1x. WPA2 also uses TKIP when required for compatibility reasons, but offers stronger encryption than TKIP with Advanced Encryption Standard (AES) in the Counter mode with Cipher block chaining Message authentication code Protocol (CCMP).

TKIP uses 128-bit keys that are dynamically generated and distributed by the authentication server. AES (Advanced Encryption Standard) is a block cipher that uses a 256-bit mathematical algorithm called Rijndael. They both include a per-packet key mixing function, a Message Integrity Check (MIC) named Michael, an extended initialization vector (IV) with sequencing rules, and a re-keying mechanism.

WPA and WPA2 regularly change and rotate the encryption keys so that the same encryption key is never used twice.

The RADIUS server distributes a Pairwise Master Key (PMK) key to the AP that then sets up a key hierarchy and management system, using the PMK to dynamically generate unique data encryption keys to encrypt every data packet that is wirelessly communicated between the AP and the wireless clients. This all happens in the background automatically.

The Message Integrity Check (MIC) is designed to prevent an attacker from capturing data packets, altering them and resending them. The MIC provides a strong mathematical function in which the receiver and the transmitter each compute and then compare the MIC. If they do not match, it is assumed that the data has been tampered with and the packet is dropped.

By generating unique data encryption keys for every data packet and by creating an integrity checking mechanism (MIC), with TKIP and AES it is more difficult to decrypt data on a Wi-Fi network than WEP and difficult for an intruder to break into the network.

The encryption mechanisms used for WPA(2) and WPA(2)-PSK are the same. The only difference between the two is that WPA(2)-PSK uses a simple common password, instead of user-specific credentials. The common-password approach makes WPA(2)-PSK susceptible to brute-force password-guessing attacks but it's still an improvement over WEP as it employs a consistent, single, alphanumeric password to derive a PMK which is used to generate unique temporal encryption keys. This prevents all wireless devices sharing the same encryption keys. (a weakness of WEP)

User Authentication

WPA and WPA2 apply IEEE 802.1x and Extensible Authentication Protocol (EAP) to authenticate wireless clients using an external RADIUS database. WPA2 reduces the number of key exchange messages from six to four (CCMP 4-way handshake) and shortens the time required to connect to a network. Other WPA2 authentication features that are different from WPA include key caching and

pre-authentication. These two features are optional and may not be supported in all wireless devices.

Key caching allows a wireless client to store the PMK it derived through a successful authentication with an AP. The wireless client uses the PMK when it tries to connect to the same AP and does not need to go with the authentication process again.

Pre-authentication enables fast roaming by allowing the wireless client (already connecting to an AP) to perform IEEE 802.1x authentication with another AP before connecting to it.

Wireless Client WPA Supplicants

A wireless client supplicant is the software that runs on an operating system instructing the wireless client how to use WPA. At the time of writing, the most widely available supplicant is the WPA patch for Windows XP, Funk Software's Odyssey client.

The Windows XP patch is a free download that adds WPA capability to Windows XP's built-in "Zero Configuration" wireless client. However, you must run Windows XP to use it.

WPA(2) with RADIUS Application Example

To set up WPA(2), you need the IP address of the RADIUS server, its port number (default is 1812), and the RADIUS shared secret. A WPA(2) application example with an external RADIUS server looks as follows. "A" is the RADIUS server. "DS" is the distribution system.

- 1 The AP passes the wireless client's authentication request to the RADIUS server.
- 2 The RADIUS server then checks the user's identification against its database and grants or denies network access accordingly.
- 3 A 256-bit Pairwise Master Key (PMK) is derived from the authentication process by the RADIUS server and the client.
- 4 The RADIUS server distributes the PMK to the AP. The AP then sets up a key hierarchy and management system, using the PMK to dynamically generate unique data encryption keys. The keys are used to encrypt every data packet that is wirelessly communicated between the AP and the wireless clients.

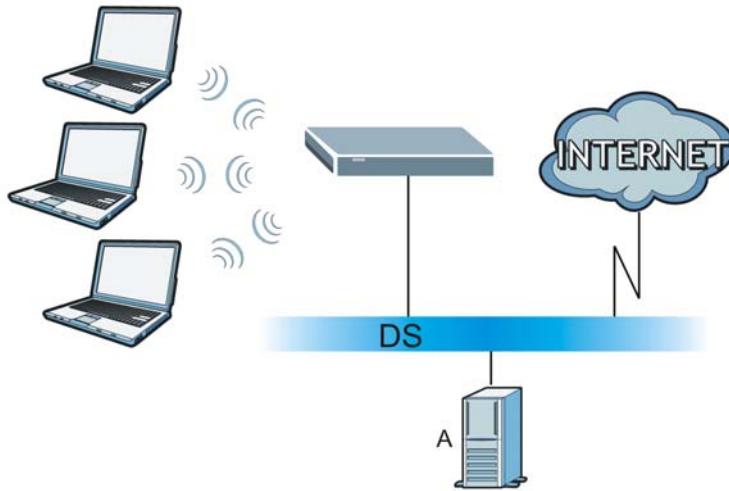
Figure 170 WPA(2) with RADIUS Application Example

WPA(2)-PSK Application Example

A WPA(2)-PSK application looks as follows.

- 1 First enter identical passwords into the AP and all wireless clients. The Pre-Shared Key (PSK) must consist of between 8 and 63 ASCII characters or 64 hexadecimal characters (including spaces and symbols).
- 2 The AP checks each wireless client's password and allows it to join the network only if the password matches.
- 3 The AP and wireless clients generate a common PMK (Pairwise Master Key). The key itself is not sent over the network, but is derived from the PSK and the SSID.
- 4 The AP and wireless clients use the TKIP or AES encryption process, the PMK and information exchanged in a handshake to create temporal encryption keys. They use these keys to encrypt data exchanged between them.

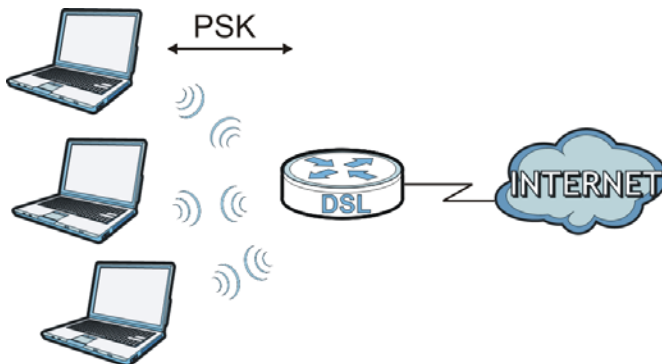
Figure 171 WPA(2)-PSK Authentication

Security Parameters Summary

Refer to this table to see what other security parameters you should configure for each authentication method or key management protocol type. MAC address filters are not dependent on how you configure these security features.

Table 129 Wireless Security Relational Matrix

AUTHENTICATION METHOD/ KEY MANAGEMENT PROTOCOL	ENCRYPTION METHOD	ENTER MANUAL KEY	IEEE 802.1X
Open	None	No	Disable
			Enable without Dynamic WEP Key
Open	WEP	No	Enable with Dynamic WEP Key
		Yes	Enable without Dynamic WEP Key
		Yes	Disable
Shared	WEP	No	Enable with Dynamic WEP Key
		Yes	Enable without Dynamic WEP Key
		Yes	Disable
WPA	TKIP/AES	No	Enable
WPA-PSK	TKIP/AES	Yes	Disable
WPA2	TKIP/AES	No	Enable
WPA2-PSK	TKIP/AES	Yes	Disable

Antenna Overview

An antenna couples RF signals onto air. A transmitter within a wireless device sends an RF signal to the antenna, which propagates the signal through the air. The antenna also operates in reverse by capturing RF signals from the air.

Positioning the antennas properly increases the range and coverage area of a wireless LAN.

Antenna Characteristics

Frequency

An antenna in the frequency of 2.4GHz (IEEE 802.11b and IEEE 802.11g) or 5GHz (IEEE 802.11a) is needed to communicate efficiently in a wireless LAN

Radiation Pattern

A radiation pattern is a diagram that allows you to visualize the shape of the antenna's coverage area.

Antenna Gain

Antenna gain, measured in dB (decibel), is the increase in coverage within the RF beam width. Higher antenna gain improves the range of the signal for better communications.

For an indoor site, each 1 dB increase in antenna gain results in a range increase of approximately

2.5%. For an unobstructed outdoor site, each 1dB increase in gain results in a range increase of approximately 5%. Actual results may vary depending on the network environment.

Antenna gain is sometimes specified in dBi, which is how much the antenna increases the signal power compared to using an isotropic antenna. An isotropic antenna is a theoretical perfect antenna that sends out radio signals equally well in all directions. dBi represents the true gain that the antenna provides.

Types of Antennas for WLAN

There are two types of antennas used for wireless LAN applications.

- Omni-directional antennas send the RF signal out in all directions on a horizontal plane. The coverage area is torus-shaped (like a donut) which makes these antennas ideal for a room environment. With a wide coverage area, it is possible to make circular overlapping coverage areas with multiple access points.
- Directional antennas concentrate the RF signal in a beam, like a flashlight does with the light from its bulb. The angle of the beam determines the width of the coverage pattern. Angles typically range from 20 degrees (very directional) to 120 degrees (less directional). Directional antennas are ideal for hallways and outdoor point-to-point applications.

Positioning Antennas

In general, antennas should be mounted as high as practically possible and free of obstructions. In point-to-point application, position both antennas at the same height and in a direct line of sight to each other to attain the best performance.

For omni-directional antennas mounted on a table, desk, and so on, point the antenna up. For omni-directional antennas mounted on a wall or ceiling, point the antenna down. For a single AP application, place omni-directional antennas as close to the center of the coverage area as possible.

For directional antennas, point the antenna in the direction of the desired coverage area.

Overview

IPv6 (Internet Protocol version 6), is designed to enhance IP address size and features. The increase in IPv6 address size to 128 bits (from the 32-bit IPv4 address) allows up to 3.4×10^{38} IP addresses.

IPv6 Addressing

The 128-bit IPv6 address is written as eight 16-bit hexadecimal blocks separated by colons (:). This is an example IPv6 address `2001:0db8:1a2b:0015:0000:0000:1a2f:0000`.

IPv6 addresses can be abbreviated in two ways:

- Leading zeros in a block can be omitted. So `2001:0db8:1a2b:0015:0000:0000:1a2f:0000` can be written as `2001:db8:1a2b:15:0:0:1a2f:0`.
- Any number of consecutive blocks of zeros can be replaced by a double colon. A double colon can only appear once in an IPv6 address. So `2001:0db8:0000:0000:1a2f:0000:0000:0015` can be written as `2001:0db8::1a2f:0000:0000:0015`, `2001:0db8:0000:0000:1a2f::0015`, `2001:db8::1a2f:0:0:15` or `2001:db8:0:0:1a2f::15`.

Prefix and Prefix Length

Similar to an IPv4 subnet mask, IPv6 uses an address prefix to represent the network address. An IPv6 prefix length specifies how many most significant bits (start from the left) in the address compose the network address. The prefix length is written as "/x" where x is a number. For example,

```
2001:db8:1a2b:15::1a2f:0/32
```

means that the first 32 bits (`2001:db8`) is the subnet prefix.

Link-local Address

A link-local address uniquely identifies a device on the local network (the LAN). It is similar to a "private IP address" in IPv4. You can have the same link-local address on multiple interfaces on a device. A link-local unicast address has a predefined prefix of `fe80::/10`. The link-local unicast address format is as follows.

Table 130 Link-local Unicast Address Format

1111 1110 10	0	Interface ID
10 bits	54 bits	64 bits

Global Address

A global address uniquely identifies a device on the Internet. It is similar to a “public IP address” in IPv4. A global unicast address starts with a 2 or 3.

Unspecified Address

An unspecified address (0:0:0:0:0:0:0:0 or ::) is used as the source address when a device does not have its own address. It is similar to “0.0.0.0” in IPv4.

Loopback Address

A loopback address (0:0:0:0:0:0:0:1 or ::1) allows a host to send packets to itself. It is similar to “127.0.0.1” in IPv4.

Multicast Address

In IPv6, multicast addresses provide the same functionality as IPv4 broadcast addresses. Broadcasting is not supported in IPv6. A multicast address allows a host to send packets to all hosts in a multicast group.

Multicast scope allows you to determine the size of the multicast group. A multicast address has a predefined prefix of ff00::/8. The following table describes some of the predefined multicast addresses.

Table 131 Predefined Multicast Address

MULTICAST ADDRESS	DESCRIPTION
FF01:0:0:0:0:0:0:1	All hosts on a local node.
FF01:0:0:0:0:0:0:2	All routers on a local node.
FF02:0:0:0:0:0:0:1	All hosts on a local connected link.
FF02:0:0:0:0:0:0:2	All routers on a local connected link.
FF05:0:0:0:0:0:0:2	All routers on a local site.
FF05:0:0:0:0:0:1:3	All DHCP servers on a local site.

The following table describes the multicast addresses which are reserved and can not be assigned to a multicast group.

Table 132 Reserved Multicast Address

MULTICAST ADDRESS
FF00:0:0:0:0:0:0:0
FF01:0:0:0:0:0:0:0
FF02:0:0:0:0:0:0:0
FF03:0:0:0:0:0:0:0
FF04:0:0:0:0:0:0:0
FF05:0:0:0:0:0:0:0
FF06:0:0:0:0:0:0:0
FF07:0:0:0:0:0:0:0

Table 132 Reserved Multicast Address (continued)

MULTICAST ADDRESS
FF08:0:0:0:0:0:0:0
FF09:0:0:0:0:0:0:0
FF0A:0:0:0:0:0:0:0
FF0B:0:0:0:0:0:0:0
FF0C:0:0:0:0:0:0:0
FF0D:0:0:0:0:0:0:0
FF0E:0:0:0:0:0:0:0
FF0F:0:0:0:0:0:0:0

Subnet Masking

Both an IPv6 address and IPv6 subnet mask compose of 128-bit binary digits, which are divided into eight 16-bit blocks and written in hexadecimal notation. Hexadecimal uses four bits for each character (1 ~ 10, A ~ F). Each block's 16 bits are then represented by four hexadecimal characters. For example, FFFF:FFFF:FFFF:FFFF:FC00:0000:0000:0000.

Interface ID

In IPv6, an interface ID is a 64-bit identifier. It identifies a physical interface (for example, an Ethernet port) or a virtual interface (for example, the management IP address for a VLAN). One interface should have a unique interface ID.

EUI-64

The EUI-64 (Extended Unique Identifier) defined by the IEEE (Institute of Electrical and Electronics Engineers) is an interface ID format designed to adapt with IPv6. It is derived from the 48-bit (6-byte) Ethernet MAC address as shown next. EUI-64 inserts the hex digits ffe between the third and fourth bytes of the MAC address and complements the seventh bit of the first byte of the MAC address. See the following example.

MAC	00 : 13 : 49 : 12 : 34 : 56
EUI-64	02 : 13 : 49 : FF : FE : 12 : 34 : 56

Identity Association

An Identity Association (IA) is a collection of addresses assigned to a DHCP client, through which the server and client can manage a set of related IP addresses. Each IA must be associated with exactly one interface. The DHCP client uses the IA assigned to an interface to obtain configuration from a DHCP server for that interface. Each IA consists of a unique IAID and associated IP information.

The IA type is the type of address in the IA. Each IA holds one type of address. IA_NA means an identity association for non-temporary addresses and IA_TA is an identity association for temporary addresses. An IA_NA option contains the T1 and T2 fields, but an IA_TA option does not. The DHCPv6 server uses T1 and T2 to control the time at which the client contacts with the server to extend the lifetimes on any addresses in the IA_NA before the lifetimes expire. After T1, the client sends the server (S1) (from which the addresses in the IA_NA were obtained) a Renew message. If

the time T2 is reached and the server does not respond, the client sends a Rebind message to any available server (S2). For an IA_TA, the client may send a Renew or Rebind message at the client's discretion.

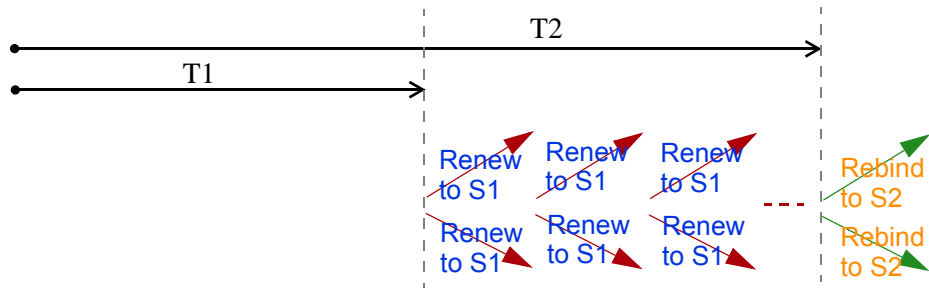

DHCP Relay Agent

A DHCP relay agent is on the same network as the DHCP clients and helps forward messages between the DHCP server and clients. When a client cannot use its link-local address and a well-known multicast address to locate a DHCP server on its network, it then needs a DHCP relay agent to send a message to a DHCP server that is not attached to the same network.

The DHCP relay agent can add the remote identification (remote-ID) option and the interface-ID option to the Relay-Forward DHCPv6 messages. The remote-ID option carries a user-defined string, such as the system name. The interface-ID option provides slot number, port information and the VLAN ID to the DHCPv6 server. The remote-ID option (if any) is stripped from the Relay-Reply messages before the relay agent sends the packets to the clients. The DHCP server copies the interface-ID option from the Relay-Forward message into the Relay-Reply message and sends it to the relay agent. The interface-ID should not change even after the relay agent restarts.

Prefix Delegation

Prefix delegation enables an IPv6 router to use the IPv6 prefix (network address) received from the ISP (or a connected uplink router) for its LAN. The VMG uses the received IPv6 prefix (for example, 2001:db2::/48) to generate its LAN IP address. Through sending Router Advertisements (RAs) regularly by multicast, the VMG passes the IPv6 prefix information to its LAN hosts. The hosts then can use the prefix to generate their IPv6 addresses.

ICMPv6

Internet Control Message Protocol for IPv6 (ICMPv6 or ICMP for IPv6) is defined in RFC 4443. ICMPv6 has a preceding Next Header value of 58, which is different from the value used to identify ICMP for IPv4. ICMPv6 is an integral part of IPv6. IPv6 nodes use ICMPv6 to report errors encountered in packet processing and perform other diagnostic functions, such as "ping".

Neighbor Discovery Protocol (NDP)

The Neighbor Discovery Protocol (NDP) is a protocol used to discover other IPv6 devices and track neighbor's reachability in a network. An IPv6 device uses the following ICMPv6 messages types:

- Neighbor solicitation: A request from a host to determine a neighbor's link-layer address (MAC address) and detect if the neighbor is still reachable. A neighbor being "reachable" means it responds to a neighbor solicitation message (from the host) with a neighbor advertisement message.

- Neighbor advertisement: A response from a node to announce its link-layer address.
- Router solicitation: A request from a host to locate a router that can act as the default router and forward packets.
- Router advertisement: A response to a router solicitation or a periodical multicast advertisement from a router to advertise its presence and other parameters.

IPv6 Cache

An IPv6 host is required to have a neighbor cache, destination cache, prefix list and default router list. The VMG maintains and updates its IPv6 caches constantly using the information from response messages. In IPv6, the VMG configures a link-local address automatically, and then sends a neighbor solicitation message to check if the address is unique. If there is an address to be resolved or verified, the VMG also sends out a neighbor solicitation message. When the VMG receives a neighbor advertisement in response, it stores the neighbor's link-layer address in the neighbor cache. When the VMG uses a router solicitation message to query for a router and receives a router advertisement message, it adds the router's information to the neighbor cache, prefix list and destination cache. The VMG creates an entry in the default router list cache if the router can be used as a default router.

When the VMG needs to send a packet, it first consults the destination cache to determine the next hop. If there is no matching entry in the destination cache, the VMG uses the prefix list to determine whether the destination address is on-link and can be reached directly without passing through a router. If the address is un-link, the address is considered as the next hop. Otherwise, the VMG determines the next-hop from the default router list or routing table. Once the next hop IP address is known, the VMG looks into the neighbor cache to get the link-layer address and sends the packet when the neighbor is reachable. If the VMG cannot find an entry in the neighbor cache or the state for the neighbor is not reachable, it starts the address resolution process. This helps reduce the number of IPv6 solicitation and advertisement messages.

Multicast Listener Discovery

The Multicast Listener Discovery (MLD) protocol (defined in RFC 2710) is derived from IPv4's Internet Group Management Protocol version 2 (IGMPv2). MLD uses ICMPv6 message types, rather than IGMP message types. MLDv1 is equivalent to IGMPv2 and MLDv2 is equivalent to IGMPv3.

MLD allows an IPv6 switch or router to discover the presence of MLD listeners who wish to receive multicast packets and the IP addresses of multicast groups the hosts want to join on its network.

MLD snooping and MLD proxy are analogous to IGMP snooping and IGMP proxy in IPv4.

MLD filtering controls which multicast groups a port can join.

MLD Messages

A multicast router or switch periodically sends general queries to MLD hosts to update the multicast forwarding table. When an MLD host wants to join a multicast group, it sends an MLD Report message for that address.

An MLD Done message is equivalent to an IGMP Leave message. When an MLD host wants to leave a multicast group, it can send a Done message to the router or switch. The router or switch then sends a group-specific query to the port on which the Done message is received to determine if other devices connected to this port should remain in the group.

Example - Enabling IPv6 on Windows XP/2003/Vista

By default, Windows XP and Windows 2003 support IPv6. This example shows you how to use the `ipv6 install` command on Windows XP/2003 to enable IPv6. This also displays how to use the `ipconfig` command to see auto-generated IP addresses.

```
C:\>ipv6 install
Installing...
Succeeded.

C:\>ipconfig

Windows IP Configuration

Ethernet adapter Local Area Connection:

    Connection-specific DNS Suffix  . :
    IP Address. . . . . : 10.1.1.46
    Subnet Mask . . . . . : 255.255.255.0
    IP Address. . . . . : fe80::2d0:59ff:feb8:103c%4
    Default Gateway . . . . . : 10.1.1.254
```

IPv6 is installed and enabled by default in Windows Vista. Use the `ipconfig` command to check your automatic configured IPv6 address as well. You should see at least one IPv6 address available for the interface on your computer.

Example - Enabling DHCPv6 on Windows XP

Windows XP does not support DHCPv6. If your network uses DHCPv6 for IP address assignment, you have to additionally install a DHCPv6 client software on your Windows XP. (Note: If you use static IP addresses or Router Advertisement for IPv6 address assignment in your network, ignore this section.)

This example uses Dibbler as the DHCPv6 client. To enable DHCPv6 client on your computer:

- 1 Install Dibbler and select the DHCPv6 client option on your computer.
- 2 After the installation is complete, select **Start > All Programs > Dibbler-DHCPv6 > Client Install as service**.
- 3 Select **Start > Control Panel > Administrative Tools > Services**.
- 4 Double click **Dibbler - a DHCPv6 client**.

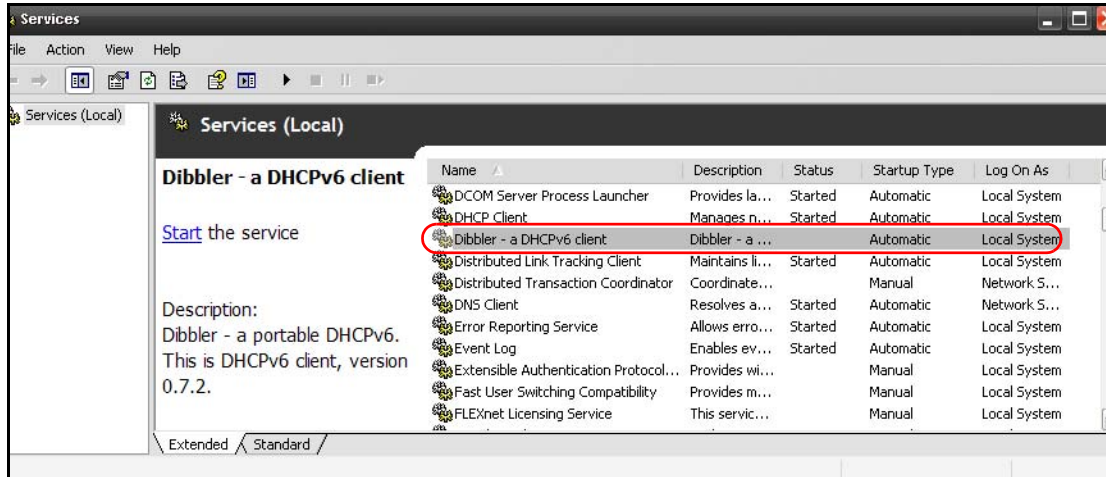

- 5 Click **Start** and then **OK**.

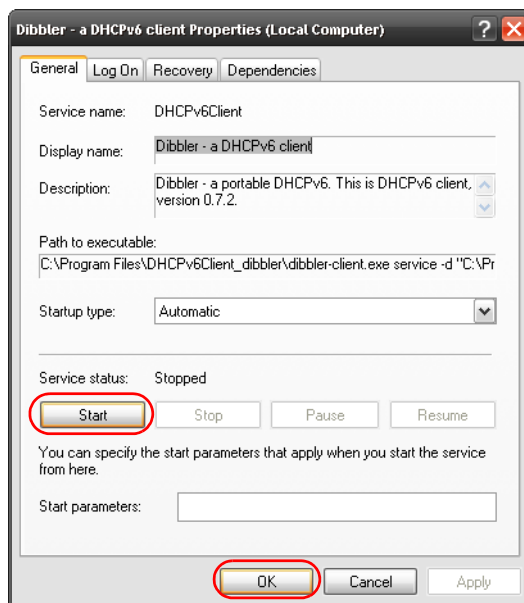

- 6 Now your computer can obtain an IPv6 address from a DHCPv6 server.

Example - Enabling IPv6 on Windows 7

Windows 7 supports IPv6 by default. DHCPv6 is also enabled when you enable IPv6 on a Windows 7 computer.

To enable IPv6 in Windows 7:

- 1 Select **Control Panel > Network and Sharing Center > Local Area Connection**.
- 2 Select the **Internet Protocol Version 6 (TCP/IPv6)** checkbox to enable it.
- 3 Click **OK** to save the change.

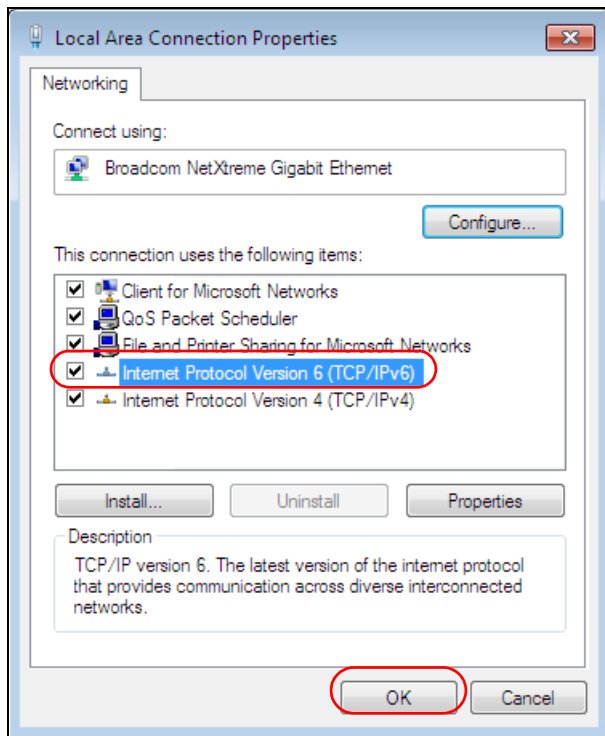

- 4 Click **Close** to exit the **Local Area Connection Status** screen.
- 5 Select **Start > All Programs > Accessories > Command Prompt**.
- 6 Use the `ipconfig` command to check your dynamic IPv6 address. This example shows a global address (2001:b021:2d::1000) obtained from a DHCP server.

```

C:\>ipconfig

Windows IP Configuration

Ethernet adapter Local Area Connection:

    Connection-specific DNS Suffix  . :
    IPv6 Address. . . . . : 2001:b021:2d::1000
    Link-local IPv6 Address . . . . . : fe80::25d8:dcab:c80a:5189%11
    IPv4 Address. . . . . : 172.16.100.61
    Subnet Mask . . . . . : 255.255.255.0
    Default Gateway . . . . . : fe80::213:49ff:feaa:7125%11
                                172.16.100.254
  
```

Services

The following table lists some commonly-used services and their associated protocols and port numbers.

- **Name:** This is a short, descriptive name for the service. You can use this one or create a different one, if you like.
- **Protocol:** This is the type of IP protocol used by the service. If this is **TCP/UDP**, then the service uses the same port number with TCP and UDP. If this is **USER-DEFINED**, the **Port(s)** is the IP protocol number, not the port number.
- **Port(s):** This value depends on the **Protocol**.
 - If the **Protocol** is **TCP, UDP, or TCP/UDP**, this is the IP port number.
 - If the **Protocol** is **USER**, this is the IP protocol number.
- **Description:** This is a brief explanation of the applications that use this service or the situations in which this service is used.

Table 133 Examples of Services

NAME	PROTOCOL	PORT(S)	DESCRIPTION
AH (IPSEC_TUNNEL)	User-Defined	51	The IPSEC AH (Authentication Header) tunneling protocol uses this service.
AIM	TCP	5190	AOL's Internet Messenger service.
AUTH	TCP	113	Authentication protocol used by some servers.
BGP	TCP	179	Border Gateway Protocol.
BOOTP_CLIENT	UDP	68	DHCP Client.
BOOTP_SERVER	UDP	67	DHCP Server.
CU-SEEME	TCP/UDP TCP/UDP	7648 24032	A popular videoconferencing solution from White Pines Software.
DNS	TCP/UDP	53	Domain Name Server, a service that matches web names (for instance www.zyxel.com) to IP numbers.
ESP (IPSEC_TUNNEL)	User-Defined	50	The IPSEC ESP (Encapsulation Security Protocol) tunneling protocol uses this service.
FINGER	TCP	79	Finger is a UNIX or Internet related command that can be used to find out if a user is logged on.
FTP	TCP TCP	20 21	File Transfer Protocol, a program to enable fast transfer of files, including large files that may not be possible by e-mail.
H.323	TCP	1720	NetMeeting uses this protocol.
HTTP	TCP	80	Hyper Text Transfer Protocol - a client/server protocol for the world wide web.
HTTPS	TCP	443	HTTPS is a secured http session often used in e-commerce.
ICMP	User-Defined	1	Internet Control Message Protocol is often used for diagnostic purposes.
ICQ	UDP	4000	This is a popular Internet chat program.
IGMP (MULTICAST)	User-Defined	2	Internet Group Multicast Protocol is used when sending packets to a specific group of hosts.
IKE	UDP	500	The Internet Key Exchange algorithm is used for key distribution and management.
IMAP4	TCP	143	The Internet Message Access Protocol is used for e-mail.
IMAP4S	TCP	993	This is a more secure version of IMAP4 that runs over SSL.
IRC	TCP/UDP	6667	This is another popular Internet chat program.
MSN Messenger	TCP	1863	Microsoft Networks' messenger service uses this protocol.
NetBIOS	TCP/UDP TCP/UDP TCP/UDP TCP/UDP	137 138 139 445	The Network Basic Input/Output System is used for communication between computers in a LAN.
NEW-ICQ	TCP	5190	An Internet chat program.
NEWS	TCP	144	A protocol for news groups.

Table 133 Examples of Services (continued)

NAME	PROTOCOL	PORT(S)	DESCRIPTION
NFS	UDP	2049	Network File System - NFS is a client/server distributed file service that provides transparent file sharing for network environments.
NNTP	TCP	119	Network News Transport Protocol is the delivery mechanism for the USENET newsgroup service.
PING	User-Defined	1	Packet INternet Groper is a protocol that sends out ICMP echo requests to test whether or not a remote host is reachable.
POP3	TCP	110	Post Office Protocol version 3 lets a client computer get e-mail from a POP3 server through a temporary connection (TCP/IP or other).
POP3S	TCP	995	This is a more secure version of POP3 that runs over SSL.
PPTP	TCP	1723	Point-to-Point Tunneling Protocol enables secure transfer of data over public networks. This is the control channel.
PPTP_TUNNEL (GRE)	User-Defined	47	PPTP (Point-to-Point Tunneling Protocol) enables secure transfer of data over public networks. This is the data channel.
RCMD	TCP	512	Remote Command Service.
REAL_AUDIO	TCP	7070	A streaming audio service that enables real time sound over the web.
REXEC	TCP	514	Remote Execution Daemon.
RLOGIN	TCP	513	Remote Login.
ROADRUNNER	TCP/UDP	1026	This is an ISP that provides services mainly for cable modems.
RTELNET	TCP	107	Remote Telnet.
RTSP	TCP/UDP	554	The Real Time Streaming (media control) Protocol (RTSP) is a remote control for multimedia on the Internet.
SFTP	TCP	115	The Simple File Transfer Protocol is an old way of transferring files between computers.
SMTP	TCP	25	Simple Mail Transfer Protocol is the message-exchange standard for the Internet. SMTP enables you to move messages from one e-mail server to another.
SMTPS	TCP	465	This is a more secure version of SMTP that runs over SSL.
SNMP	TCP/UDP	161	Simple Network Management Program.
SNMP-TRAPS	TCP/UDP	162	Traps for use with the SNMP (RFC:1215).
SQL-NET	TCP	1521	Structured Query Language is an interface to access data on many different types of database systems, including mainframes, midrange systems, UNIX systems and network servers.
SSDP	UDP	1900	The Simple Service Discovery Protocol supports Universal Plug-and-Play (UPnP).
SSH	TCP/UDP	22	Secure Shell Remote Login Program.
STRM WORKS	UDP	1558	Stream Works Protocol.

Table 133 Examples of Services (continued)

NAME	PROTOCOL	PORT(S)	DESCRIPTION
SYSLOG	UDP	514	Syslog allows you to send system logs to a UNIX server.
TACACS	UDP	49	Login Host Protocol used for (Terminal Access Controller Access Control System).
TELNET	TCP	23	Telnet is the login and terminal emulation protocol common on the Internet and in UNIX environments. It operates over TCP/IP networks. Its primary function is to allow users to log into remote host systems.
VDOLIVE	TCP UDP	7000 user- defined	A videoconferencing solution. The UDP port number is specified in the application.

Legal Information

Copyright

Copyright © 2015 by ZyXEL Communications Corporation.

The contents of this publication may not be reproduced in any part or as a whole, transcribed, stored in a retrieval system, translated into any language, or transmitted in any form or by any means, electronic, mechanical, magnetic, optical, chemical, photocopying, manual, or otherwise, without the prior written permission of ZyXEL Communications Corporation.

Published by ZyXEL Communications Corporation. All rights reserved.

Disclaimers

ZyXEL does not assume any liability arising out of the application or use of any products, or software described herein. Neither does it convey any license under its patent rights nor the patent rights of others. ZyXEL further reserves the right to make changes in any products described herein without notice. This publication is subject to change without notice.

Your use of the VMG is subject to the terms and conditions of any related service providers.

Trademarks

Trademarks mentioned in this publication are used for identification purposes only and may be properties of their respective owners.

Regulatory Notice and Statement

UNITED STATE AMERICA



The following information applies if you use the product within USA area.

FCC EMC Statement

• This device complies with part 15 of the FCC Rules. Operation is subject to the following two conditions:

- 1 This device may not cause harmful interference, and
 - 2 this device must accept any interference received, including interference that may cause undesired operation.
- Changes or modifications not expressly approved by the party responsible for compliance could void the user's authority to operate the equipment.
 - This product has been tested and complies with the specifications for a Class B digital device, pursuant to Part 15 of the FCC Rules. These limits are designed to provide reasonable protection against harmful interference in a residential installation. This equipment generates, uses, and can radiate radio frequency energy and, if not installed and used according to the instructions, may cause harmful interference to radio communications. However, there is no guarantee that interference will not occur in a particular installation.
 - If this equipment does cause harmful interference to radio or television reception, which is found by turning the equipment off and on, the user is encouraged to try to correct the interference by one or more of the following measures:
 - 1 Reorient or relocate the receiving antenna.
 - 2 Increase the separation between the equipment or devices.
 - 3 Connect the equipment to an outlet other than the receiver's.
 - 4 Consult a dealer or an experienced radio/TV technician for assistance.

FCC Radiation Exposure Statement

- This equipment complies with FCC RF radiation exposure limits set forth for an uncontrolled environment.
- This transmitter must be at least 20 cm from the user and must not be co-located or operating in conjunction with any other antenna or transmitter.

CANADA

The following information applies if you use the product within Canada area.

Industry Canada ICES statement

CAN ICES-3 (B)/NMB-3(B)

Industry Canada RSS-GEN & RSS-247 statement

- This device complies with Industry Canada license-exempt RSS standard(s). Operation is subject to the following two conditions: (1) this device may not cause interference, and (2) this device must accept any interference, including interference that may cause undesired operation of the device.
- Under Industry Canada regulations, this radio transmitter may only operate using an antenna of a type and maximum (or lesser) gain approved for the transmitter by Industry Canada. To reduce potential radio interference to other users, the antenna type and its gain should be so chosen that the equivalent isotropically radiated power (e.i.r.p.) is not more than that necessary for successful communication.
- This radio transmitter has been approved by Industry Canada to operate with the antenna types listed below with the maximum permissible gain and required antenna impedance for each antenna type indicated. Antenna types not included in this list, having a gain greater than the maximum gain indicated for that type, are strictly prohibited for use with this device.
- Le présent appareil est conforme aux CNR d'Industrie Canada applicables aux appareils radio exempts de licence. L'exploitation est autorisée aux deux conditions suivantes : (1) l'appareil ne doit pas produire de brouillage, et (2) l'utilisateur de l'appareil doit accepter tout brouillage radioélectrique subi, même si le brouillage est susceptible d'en compromettre le fonctionnement.
- Conformément à la réglementation d'Industrie Canada, le présent émetteur radio peut fonctionner avec une antenne d'un type et d'un gain maximal (ou inférieur) approuvé pour l'émetteur par Industrie Canada. Dans le but de réduire les risques de brouillage radioélectrique à l'intention des autres utilisateurs, il faut choisir le type d'antenne et son gain de sorte que la puissance isotrope rayonnée équivalente (p.i.r.e.) ne dépasse pas l'intensité nécessaire à l'établissement d'une communication satisfaisante.
- Le présent émetteur radio de modèle s'il fait partie du matériel de catégorie I) a été approuvé par Industrie Canada pour fonctionner avec les types d'antenne énumérés ci-dessous et ayant un gain admissible maximal et l'impédance requise pour chaque type d'antenne. Les types d'antenne non inclus dans cette liste, ou dont le gain est supérieur au gain maximal indiqué, sont strictement interdits pour l'exploitation de l'émetteur.

Industry Canada radiation exposure statement

This equipment complies with IC radiation exposure limits set forth for an uncontrolled environment. This equipment should be installed and operated with a minimum distance of 20cm between the radiator and your body.

Déclaration d'exposition aux radiations:

Cet équipement est conforme aux limites d'exposition aux rayonnements IC établies pour un environnement non contrôlé. Cet équipement doit être installé et utilisé avec un minimum de 20 cm de distance entre la source de rayonnement et votre corps.

EUROPEAN UNION



The following information applies if you use the product within the European Union.

Declaration of Conformity with Regard to EU Directive 1999/5/EC (R&TTE Directive)

Compliance information for 2.4GHz and/or 5GHz wireless products relevant to the EU and other Countries following the EU Directive 1999/5/EC (R&TTE).

Български (Bulgarian)	С настоящото ZyXEL декларира, че това оборудване е в съответствие със съществените изисквания и другите приложими разпоредбите на Директива 1999/5/EC.
Español (Spanish)	Por medio de la presente ZyXEL declara que el equipo cumple con los requisitos esenciales y cualesquiera otras disposiciones aplicables o exigibles de la Directiva 1999/5/CE.
Čeština (Czech)	ZyXEL tímto prohlašuje, že tento zařízení je ve shodě se základními požadavky a dalšími příslušnými ustanoveními směrnice 1999/5/EC.
Dansk (Danish)	Undertegnede ZyXEL erklærer herved, at følgende udstyr overholder de væsentlige krav og øvrige relevante krav i direktiv 1999/5/EF.
Deutsch (German)	Hiermit erklärt ZyXEL, dass sich das Gerät Ausstattung in Übereinstimmung mit den grundlegenden Anforderungen und den übrigen einschlägigen Bestimmungen der Richtlinie 1999/5/EU befindet.
Eesti keel (Estonian)	Käesolevaga kinnitab ZyXEL seadme seadmed vastavust direktiivi 1999/5/EÜ põhinõuetele ja nimetatud direktiivist tulenevatele teistele asjakohastele sätetele.
Ελληνικά (Greek)	ΜΕ ΤΗΝ ΠΑΡΟΥΣΑ ΖΥΧΕΛ ΔΗΛΩΝΕΙ ΟΤΙ ΕΞΟΠΛΙΣΜΟΣ ΣΥΜΜΟΡΦΩΝΕΤΑΙ ΠΡΟΣ ΤΙΣ ΟΥΣΙΩΔΕΙΣ ΑΠΑΙΤΗΣΕΙΣ ΚΑΙ ΤΙΣ ΛΟΙΠΕΣ ΣΧΕΤΙΚΕΣ ΔΙΑΤΑΞΕΙΣ ΤΗΣ ΟΔΗΓΙΑΣ 1999/5/ΕΚ.
English	Hereby, ZyXEL declares that this equipment is in compliance with the essential requirements and other relevant provisions of Directive 1999/5/EC.
Français (French)	Par la présente ZyXEL déclare que l'appareil équipements est conforme aux exigences essentielles et aux autres dispositions pertinentes de la directive 1999/5/EC.
Hrvatski (Croatian)	ZyXEL ovime izjavljuje da je radijska oprema tipa u skladu s Direktivom 1999/5/EC.
Íslenska (Icelandic)	Hér með lýsir, ZyXEL því yfir að þessi búnaður er í samræmi við grunnkröfur og önnur viðeigandi ákvæði tilskipunar 1999/5/EC.

Italiano (Italian)	Con la presente ZyXEL dichiara che questo attrezzatura è conforme ai requisiti essenziali ed alle altre disposizioni pertinenti stabilite dalla direttiva 1999/5/CE.
Latviešu valoda (Latvian)	Ar šo ZyXEL deklarē, ka iekārtas atbilst Direktīvas 1999/5/EK būtiskajām prasībām un citiem ar to saistītajiem noteikumiem.
Lietuvių kalba (Lithuanian)	Šiuo ZyXEL deklaruoją, kad šis įranga atitinka esminius reikalavimus ir kitas 1999/5/EB Direktyvos nuostatas.
Magyar (Hungarian)	Alulírott, ZyXEL nyilatkozom, hogy a berendezés megfelel a vonatkozó alapvető követelményeknek és az 1999/5/EK irányelv egyéb előírásainak.
Malti (Maltese)	Hawnhekk, ZyXEL, jiddikjara li dan taghmir jikkonforma mal-htigijiet essenzjali u ma provvedimenti oħrajn relevanti li hemm fid-Dirrettiva 1999/5/EC.
Nederlands (Dutch)	Hierbij verklaart ZyXEL dat het toestel uitrusting in overeenstemming is met de essentiële eisen en de andere relevante bepalingen van richtlijn 1999/5/EC.
Polski (Polish)	Niniejszym ZyXEL oświadcza, że sprzęt jest zgodny z zasadniczymi wymogami oraz pozostałymi stosownymi postanowieniami Dyrektywy 1999/5/EC.
Português (Portuguese)	ZyXEL declara que este equipamento está conforme com os requisitos essenciais e outras disposições da Directiva 1999/5/EC.
Română (Romanian)	Prin prezenta, ZyXEL declară că acest echipament este în conformitate cu cerințele esențiale și alte prevederi relevante ale Directivei 1999/5/EC.
Slovenčina (Slovak)	ZyXEL týmto vyhlasuje, že zariadenia spĺňa základné požiadavky a všetky príslušné ustanovenia Smernice 1999/5/EC.
Slovenščina (Slovene)	ZyXEL izjavlja, da je ta oprema v skladu z bistvenimi zahtevami in ostalimi relevantnimi določili direktive 1999/5/EC.
Suomi (Finnish)	ZyXEL vakuuttaa täten että laitteet tyyppinen laite on direktiivin 1999/5/EY oleellisten vaatimusten ja sitä koskevien direktiivin muiden ehtojen mukainen.
Svenska (Swedish)	Härmed intygar ZyXEL att denna utrustning står i överensstämmelse med de väsentliga egenskapskrav och övriga relevanta bestämmelser som framgår av direktiv 1999/5/EC.
Norsk (Norwegian)	Erklærer herved ZyXEL at dette utstyret er i samsvar med de grunnleggende kravene og andre relevante bestemmelser i direktiv 1999/5/EF.

National Restrictions

This product may be used in all EU countries (and other countries following the EU Directive 2014/53/EU) without any limitation except for the countries mentioned below:

Ce produit peut être utilisé dans tous les pays de l'UE (et dans tous les pays ayant transposés la directive 2014/53/UE) sans aucune limitation, excepté pour les pays mentionnés ci-dessous:

Questo prodotto è utilizzabile in tutte i paesi EU (ed in tutti gli altri paesi che seguono le direttiva 2014/53/UE) senza nessuna limitazione, eccetto per i paesi menzionati di seguito:

Das Produkt kann in allen EU Staaten ohne Einschränkungen eingesetzt werden (sowie in anderen Staaten die der Richtlinie 2014/53/EU folgen) mit Ausnahme der folgenden aufgeführten Staaten:

In the majority of the EU and other European countries, the 2.4GHz and 5GHz bands have been made available for the use of wireless local area networks (LANs). Later in this document you will find an overview of countries in which additional restrictions or requirements or both are applicable.

The requirements for any country may evolve. ZyXEL recommends that you check with the local authorities for the latest status of their national regulations for both the 2.4GHz and 5GHz wireless LANs.

The following countries have restrictions and/or requirements in addition to those given in the table labeled "Overview of Regulatory Requirements for Wireless LANs":.

Belgium

The Belgian Institute for Postal Services and Telecommunications (BIPT) must be notified of any outdoor wireless link having a range exceeding 300 meters. Please check <http://www.bipt.be> for more details.

Draadloze verbindingen voor buitengebruik en met een reikwijdte van meer dan 300 meter dienen aangemeld te worden bij het Belgisch Instituut voor postdiensten en telecommunicatie (BIPT). Zie <http://www.bipt.be> voor meer gegevens.

Les liaisons sans fil pour une utilisation en extérieur d'une distance supérieure à 300 mètres doivent être notifiées à l'Institut Belge des services Postaux et des Télécommunications (IBPT). Visitez <http://www.ibpt.be> pour de plus amples détails.

Denmark

In Denmark, the band 5150 - 5350 MHz is also allowed for outdoor usage.

I Danmark må frekvensbåndet 5150 - 5350 også anvendes udendørs.

Italy

This product meets the National Radio Interface and the requirements specified in the National Frequency Allocation Table for Italy. Unless this wireless LAN product is operating within the boundaries of the owner's property, its use requires a "general authorization." Please check <http://www.sviluppoeconomico.gov.it/> for more details.

Questo prodotto è conforme alla specifiche di Interfaccia Radio Nazionali e rispetta il Piano Nazionale di ripartizione delle frequenze in Italia. Se non viene installato all'interno del proprio fondo, l'utilizzo di prodotti Wireless LAN richiede una "Autorizzazione Generale". Consultare <http://www.sviluppoeconomico.gov.it/> per maggiori dettagli.

Latvia

The outdoor usage of the 2.4 GHz band requires an authorization from the Electronic Communications Office. Please check <http://www.esd.lv> for more details.

2.4 GHz frekvenču joslas izmantošanai ārpus telpām nepieciešama atļauja no Elektronisko sakaru direkcijas. Vairāk informācijas: <http://www.esd.lv>.

Notes:

1. Although Norway, Switzerland and Liechtenstein are not EU member states, the EU Directive 2014/53/EU has also been implemented in those countries.
2. The regulatory limits for maximum output power are specified in EIRP. The EIRP level (in dBm) of a device can be calculated by adding the gain of the antenna used (specified in dBi) to the output power available at the connector (specified in dBm).

List of national codes

COUNTRY	ISO 3166 2 LETTER CODE	COUNTRY	ISO 3166 2 LETTER CODE
Austria	AT	Liechtenstein	LI
Belgium	BE	Lithuania	LT
Bulgaria	BG	Luxembourg	LU
Croatia	HR	Malta	MT
Cyprus	CY	Netherlands	NL
Czech Republic	CR	Norway	NO
Denmark	DK	Poland	PL
Estonia	EE	Portugal	PT
Finland	FI	Romania	RO
France	FR	Serbia	RS
Germany	DE	Slovakia	SK
Greece	GR	Slovenia	SI
Hungary	HU	Spain	ES
Iceland	IS	Sweden	SE
Ireland	IE	Switzerland	CH
Italy	IT	Turkey	TR
Latvia	LV	United Kingdom	GB

Safety Warnings

- Do NOT use this product near water, for example, in a wet basement or near a swimming pool.
- Do NOT expose your device to dampness, dust or corrosive liquids.
- Do NOT store things on the device.
- Do NOT install, use, or service this device during a thunderstorm. There is a remote risk of electric shock from lightning.
- Connect ONLY suitable accessories to the device.
- Do NOT open the device or unit. Opening or removing covers can expose you to dangerous high voltage points or other risks. ONLY qualified service personnel should service or disassemble this device. Please contact your vendor for further information.
- Make sure to connect the cables to the correct ports.
- Place connecting cables carefully so that no one will step on them or stumble over them.
- Always disconnect all cables from this device before servicing or disassembling.
- Use ONLY an appropriate power adaptor or cord for your device. Connect it to the right supply voltage (for example, 110V AC in North America or 230V AC in Europe).
- Do NOT allow anything to rest on the power adaptor or cord and do NOT place the product where anyone can walk on the power adaptor or cord.
- Do NOT use the device if the power adaptor or cord is damaged as it might cause electrocution.
- If the power adaptor or cord is damaged, remove it from the device and the power source.
- Do NOT attempt to repair the power adaptor or cord. Contact your local vendor to order a new one.
- Do not use the device outside, and make sure all the connections are indoors. There is a remote risk of electric shock from lightning.
- CAUTION: RISK OF EXPLOSION IF BATTERY (on the motherboard) IS REPLACED BY AN INCORRECT TYPE. DISPOSE OF USED BATTERIES ACCORDING TO THE INSTRUCTIONS. Dispose them at the applicable collection point for the recycling of electrical and electronic equipment. For detailed information about recycling of this product, please contact your local city office, your household waste disposal service or the store where you purchased the product.
- Do NOT obstruct the device ventilation slots, as insufficient airflow may harm your device.
- Antenna Warning! This device meets ETSI and FCC certification requirements when using the included antenna(s). Only use the included antenna(s).
- If you wall mount your device, make sure that no electrical lines, gas or water pipes will be damaged.
- The PoE (Power over Ethernet) devices that supply or receive power and their connected Ethernet cables must all be completely indoors.
- This product is for indoor use only (utilisation intérieure exclusivement).
- FOR COUNTRY CODE SELECTION USAGE (WLAN DEVICES)
Note: The country code selection is for non-US model only and is not available to all US model. Per FCC regulation, all Wi-Fi product marketed in US must fixed to US operation channels only.

- The following warning statements apply, where the disconnect device is not incorporated in the equipment or where the plug on the power supply cord is intended to serve as the disconnect device,
 - for PERMANENTLY CONNECTED EQUIPMENT, a readily accessible disconnect device shall be incorporated external to the equipment;
 - for PLUGGABLE EQUIPMENT, the socket-outlet shall be installed near the equipment and shall be easily accessible.

Environment statement

ErP (Energy-related Products)

ZyXEL products put on the EU market in compliance with the requirement of the European Parliament and the Council published Directive 2009/125/EC establishing a framework for the setting of ecodesign requirements for energy-related products (recast), so called as "ErP Directive (Energy-related Products directive) as well as ecodesign requirement laid down in applicable implementing measures, power consumption has satisfied regulation requirements which are:

Network standby power consumption < 12W, and/or

Off mode power consumption < 0.5W, and/or

Standby mode power consumption < 0.5W.

Wireless setting, please refer to "Wireless" chapter for more detail.

European Union - Disposal and Recycling Information

WEEE Directive

The symbol below means that according to local regulations your product and/or its battery shall be disposed of separately from domestic waste. If this product is end of life, take it to a recycling station designated by local authorities. At the time of disposal, the separate collection of your product and/or its battery will help save natural resources and ensure that the environment is sustainable development.

Die folgende Symbol bedeutet, dass Ihr Produkt und/oder seine Batterie gemäß den örtlichen Bestimmungen getrennt vom Hausmüll entsorgt werden muss. Wenden Sie sich an eine Recyclingstation, wenn dieses Produkt das Ende seiner Lebensdauer erreicht hat. Zum Zeitpunkt der Entsorgung wird die getrennte Sammlung von Produkt und/oder seiner Batterie dazu beitragen, natürliche Ressourcen zu sparen und die Umwelt und die menschliche Gesundheit zu schützen.

El símbolo de abajo indica que según las regulaciones locales, su producto y/o su batería deberán depositarse como basura separada de la doméstica. Cuando este producto alcance el final de su vida útil, llévelo a un punto limpio. Cuando llegue el momento de desechar el producto, la recogida por separado éste y/o su batería ayudará a salvar los recursos naturales y a proteger la salud humana y medioambiental.

























Le symbole ci-dessous signifie que selon les réglementations locales votre produit et/ou sa batterie doivent être éliminés séparément des ordures ménagères. Lorsque ce produit atteint sa fin de vie, amenez-le à un centre de recyclage. Au moment de la mise au rebut, la collecte séparée de votre produit et/ou de sa batterie aidera à économiser les ressources naturelles et protéger l'environnement et la santé humaine.

Il simbolo sotto significa che secondo i regolamenti locali il vostro prodotto e/o batteria deve essere smaltito separatamente dai rifiuti domestici. Quando questo prodotto raggiunge la fine della vita di servizio portarlo a una stazione di riciclaggio. Al momento dello smaltimento, la raccolta separata del vostro prodotto e/o della sua batteria aiuta a risparmiare risorse naturali e a proteggere l'ambiente e la salute umana.

Symbolen innebär att enligt lokal lagstiftning ska produkten och/eller dess batteri kastas separat från hushållsavfallet. När den här produkten når slutet av sin livslängd ska du ta den till en återvinningsstation. Vid tiden för kasseringen bidrar du till en bättre miljö och mänsklig hälsa genom att göra dig av med den på ett återvinningsställe.



Environmental Product Declaration

Български (Bulgarian)	Čeština (Czech)	Dansk (Danish)	Deutsch (German)
<p>Екологична продуктова декларация</p> <p>RoHS Директива 2011/65/ЕС WEEE Директива 2012/19/ЕС PPW Директива 94/62/ЕО REACH REGULATION (ЕС) № 1907/2006 ErP Директива 2009/125/ЕС</p> <p>Име/Име: Richard Hsu / Quality Management Division Senior Manager Подпис: Дата (dd/mm/yyyy): 01/10/2014 <i>Richard Hsu</i></p> 	<p>Environmentální prohlášení o produktu</p> <p>RoHS Směrnice 2011/65/EU WEEE Směrnice 2012/19/EU PPW Směrnice 94/62/ES REACH Nařízení (ES) č. 1907/2006 ErP Směrnice 2009/125/ES</p> <p>Jméno/Štít: Richard Hsu / Quality Management Division Senior Manager Podpis: Datum (dd/mm/yyyy): 01/10/2014 <i>Richard Hsu</i></p> 	<p>Miljøvederklæring</p> <p>RoHS Direktiv 2011/65/EU WEEE Direktiv 2012/19/EU PPW Direktiv 94/62/EF REACH Forordning (EF) nr. 1907/2006 ErP Direktiv 2009/125/EF</p> <p>Navn/Štít: Richard Hsu / Quality Management Division Senior Manager Underskrift: Dato (dd/mm/åååå): 01/10/2014 <i>Richard Hsu</i></p> 	<p>Produkt-Umweltdeklaration</p> <p>RoHS Richtlinie 2011/65/EU WEEE Richtlinie 2012/19/EU PPW Richtlinie 94/62/EG REACH VERORDNUNG (EG) Nr. 1907/2006 ErP Richtlinie 2009/125/EG</p> <p>Name/Štít: Richard Hsu / Quality Management Division Senior Manager Unterschrift: Datum (dd/mm/yy): 2014/10/01 <i>Richard Hsu</i></p> 
<p>Tooete keskkonnadeklaratsioon</p> <p>RoHS Direktiv 2011/65/EL WEEE Direktiv 2012/19/EL PPW Direktiv 94/62/EÜ REACH MAARLUS (EÜ) nr 1907/2006 ErP Direktiv 2009/125/EL</p> <p>Nimi/Štiti: Richard Hsu / Quality Management Division Senior Manager Allkirj: Kuupäev (pp/kk/aaaa): 01/10/2014 <i>Richard Hsu</i></p> 	<p>Environmental product declaration</p> <p>RoHS Directive 2011/65/EU WEEE Directive 2012/19/EU PPW Directive 94/62/EC REACH Regulation (EC) No 1907/2006 ErP Directive 2009/125/EC</p> <p>Name/Štít: Richard Hsu / Quality Management Division Senior Manager Signature: Date (dd/mm/yyyy): 01/10/2014 <i>Richard Hsu</i></p> 	<p>Declaraciones Ambientales de Producto</p> <p>RoHS Directiva 2011/65/UE WEEE Directiva 2012/19/UE PPW Directiva 94/62/CE REACH REGLAMENTO (CE) nº 1907/2006 ErP Directiva 2009/125/CE</p> <p>Nombre/Štiti: Richard Hsu / Quality Management Division Senior Manager Firma: Fecha (aaaa/mm/dd): 2014/10/01 <i>Richard Hsu</i></p> 	<p>Profil environnemental de produit</p> <p>RoHS Directive 2011/65/UE WEEE Directive 2012/19/UE PPW Directive 94/62/CE REACH REGLEMENT (CE) N° 1907/2006 ErP Directive 2009/125/UE</p> <p>Nom/Štiti: Richard Hsu / Quality Management Division Senior Manager Signature: Date (aaaa/mm/jj): 2014/10/01 <i>Richard Hsu</i></p> 
<p>Deklaraciju o zbrinjavanju proizvoda</p> <p>RoHS Direktiva 2011/65/EU WEEE Direktiva 2012/19/EU PPW Direktiva 94/62/EZ REACH Uredba (EZ) br. 1907/2006 ErP Direktiva 2009/125/EZ</p> <p>Ime/Ime: Richard Hsu / Quality Management Division Senior Manager Potpis: Datum (dd/mm/yyyy): 01/10/2014 <i>Richard Hsu</i></p> 	<p>Dichiarazione ambientale di prodotto</p> <p>RoHS Direttiva 2011/65/UE WEEE Direttiva 2012/19/UE PPW Direttiva 94/62/CE REACH REGOLAMENTO (CE) n. 1907/2006 ErP Direttiva 2009/125/CE</p> <p>Nome/Štiti: Richard Hsu / Quality Management Division Senior Manager Firma: Data (aaaa/mm/gg): 2014/10/01 <i>Richard Hsu</i></p> 	<p>Produkta vides ietekmējuma deklarācija</p> <p>RoHS Direktīva 2011/65/ES WEEE Direktīva 2012/19/ES PPW Direktīva 94/62/EK REACH Regula (EK) Nr. 1907/2006 ErP Direktīva 2009/125/EK</p> <p>Nosaukums/Štiti: Richard Hsu / Quality Management Division Senior Manager Paraksts: Datums (dd/mm/yyyy): 01/10/2014 <i>Richard Hsu</i></p> 	<p>Apinkosaušingų gaminių deklaraciją</p> <p>RoHS Direktyva 2011/65/ES WEEE Direktyva 2012/19/ES PPW Direktyva 94/62/EE REACH REGLAMENTAS (EB) Nr. 1907/2006 ErP Direktyva 2009/125/EB</p> <p>Vardas/Štiti: Richard Hsu / Quality Management Division Senior Manager Parašas: Data (dd/mm/aaaa): 01/10/2014 <i>Richard Hsu</i></p> 
<p>Környezetvédelmi terméknyilatkozat</p> <p>RoHS 2011/65/EU irányelv WEEE 2012/19/EU irányelv PPW 94/62/EK irányelv REACH 1907/2006/EK rendelet ErP 2009/125/EK irányelv</p> <p>Név/Ime: Richard Hsu / Quality Management Division Senior Manager Aláírás: Dátum (dd/mm/yyyy): 2014/10/01 <i>Richard Hsu</i></p> 	<p>Dikjarazzjoni Ambientali dwar il-Prodott</p> <p>RoHS Direttiva 2011/65/UE WEEE Direttiva 2012/19/UE PPW Direttiva 94/62/CE REACH REGOLAMENTO (CE) NR/1907/2006 ErP Direttiva 2009/125/CE</p> <p>Isim/Štiti: Richard Hsu / Quality Management Division Senior Manager Firma: Data (aaaa/mm/yy): 2014/10/01 <i>Richard Hsu</i></p> 	<p>Miljøproductveklaring</p> <p>RoHS Richtlijn 2011/65/EU WEEE Richtlijn 2012/19/EU PPW Richtlijn 94/62/EG REACH Verordening (EG) nr. 1907/2006 ErP Richtlijn 2009/125/EG</p> <p>Naam/Štít: Richard Hsu / Quality Management Division Senior Manager Handtekening: Datum (dd/mm/jj): 01/10/2014 <i>Richard Hsu</i></p> 	<p>Deklarację środowiskową produktu</p> <p>RoHS Dyrektywa 2011/65/UE WEEE Dyrektywa 2012/19/UE PPW Dyrektywa 94/62/WE REACH Rozporządzenie (WE) nr 1907/2006 ErP Dyrektywa 2009/125/WE</p> <p>Nazwisko/Štiti: Richard Hsu / Quality Management Division Senior Manager Podpis: Data (dd/mm/aaaa): 2014/10/01 <i>Richard Hsu</i></p> 
<p>Declaração ambiental do produto</p> <p>RoHS Directiva 2011/65/UE WEEE Directiva 2012/19/UE PPW 94/62/CE REACH Regulamento (CE) n.º 1907/2006 ErP Directiva 2009/125/CE</p> <p>Nome/Štiti: Richard Hsu / Quality Management Division Senior Manager Assinatura: Data (dd/mm/aaaa): 01/10/2014 <i>Richard Hsu</i></p> 	<p>Declarație de mediu privind produsele</p> <p>RoHS Directivă 2011/65/UE WEEE Directivă 2012/19/UE PPW Directivă 94/62/CE REACH REGULAMENTUL (CE) NR. 1907/2006 ErP Directivă 2009/125/CE</p> <p>Nume/Štiti: Richard Hsu / Quality Management Division Senior Manager Semnatura: Data (dd/mm/aaaa): 01/10/2014 <i>Richard Hsu</i></p> 	<p>Vyhlašení o environmentálnom výrobku</p> <p>RoHS Směrnice 2011/65/EU WEEE Směrnice 2012/19/EU PPW Směrnice 94/62/ES REACH Nařízení (ES) č. 1907/2006 ErP Směrnice 2009/125/ES</p> <p>Menlo/Štít: Richard Hsu / Quality Management Division Senior Manager Podpis: Datum (dd/mm/yyyy): 01/10/2014 <i>Richard Hsu</i></p> 	<p>Okoljsko deklaracija izdelka</p> <p>RoHS Direktiva 2011/65/UE WEEE Direktiva 2012/19/UE PPW Direktiva 94/62/ES REACH Uredba (ES) št. 1907/2006 ErP Direktiva 2009/125/ES</p> <p>Ime/Štiti: Richard Hsu / Quality Management Division Senior Manager Podpis: Datum (dd/mm/aaaa): 01/10/2014 <i>Richard Hsu</i></p> 
<p>Standardin perustava ympäristötietosuosteloste</p> <p>RoHS Direktiv 2011/65/EU WEEE Direktiv 2012/19/EU PPW Direktiv 94/62/EY REACH ASETUS (EY) N:o 1907/2006 ErP Direktiv 2009/125/EY</p> <p>Nimi/Štiti: Richard Hsu / Quality Management Division Senior Manager Allekirjoitus: Päivämäärä (pp/kk/vvvv): 01/10/2014 <i>Richard Hsu</i></p> 	<p>Miljöproduktdeklaration</p> <p>RoHS Direktiv 2011/65/EU WEEE Direktiv 2012/19/EU PPW Direktiv 94/62/EG REACH Förordning (EG) nr 1907/2006 ErP Direktiv 2009/125/EG</p> <p>Namn/Štiti: Richard Hsu / Quality Management Division Senior Manager Namnteckning: Datum (dd/mm/åååå): 01/10/2014 <i>Richard Hsu</i></p> 	<p>Περιβαλλοντική δήλωση προϊόντος</p> <p>RoHS Οδηγία 2011/65/ΕΕ WEEE Οδηγία 2012/19/ΕΕ PPW Οδηγία 94/62/ΕΚ REACH [Ε. ενσωμάτωση (ΕΚ) αριθ. 1907/2006 ErP Οδηγία 2009/125/ΕΚ</p> <p>Όνομα/Štiti: Richard Hsu / Quality Management Division Senior Manager Υπογραφή: Ημερομηνία (ππ/μμ/αααα): 01/10/2014 <i>Richard Hsu</i></p> 	<p>Miljødeklarasjon</p> <p>RoHS Direktiv 2011/65/EU WEEE Direktiv 2012/19/EU PPW Direktiv 94/62/EF REACH Forordning (EF) nr. 1907/2006 ErP Direktiv 2009/125/EF</p> <p>Navn/Štiti: Richard Hsu / Quality Management Division Senior Manager Signatur: Dato (dd/mm/åååå): 01/10/2014 <i>Richard Hsu</i></p> 

台灣



以下訊息僅適用於產品銷售至台灣地區

第十二條 經型式認證合格之低功率射頻電機，非經許可，公司、商號或使用者均不得擅自變更頻率、加大功率或變更原設計之特性及功能。

第十四條 低功率射頻電機之使用不得影響飛航安全及干擾合法通信；經發現有干擾現象時，應立即停用，並改善至無干擾時方得繼續使用。前項合法通信，指依電信法規定作業之無線電通信。低功率射頻電機須忍受合法通信或工業、科學及醫療用電波輻射性電機設備之干擾。

安全警告

- 為了您的安全，請先閱讀以下警告及指示：
- 請勿將此產品接近水、火焰或放置在高溫的環境。
- 避免設備接觸。
- 任何液體 - 切勿讓設備接觸水、雨水、高濕度、污水腐蝕性的液體或其他水份。
- 灰塵及污物 - 切勿接觸灰塵、污物、沙土、食物或其他不適合的材料。
- 雷雨天氣時，不要安裝，使用或維修此設備。有遭受電擊的風險。
- 切勿重摔或撞擊設備，並勿使用不正確的電源變壓器。
- 若接上不正確的電源變壓器會有爆炸的風險。
- 請勿隨意更換產品內的電池。
- 如果更換不正確之電池型式，會有爆炸的風險，請依製造商說明書處理使用過之電池。
- 請將廢電池丟棄在適當的電器或電子設備回收處。
- 請勿將設備解體。
- 請勿阻礙設備的散熱孔，空氣對流不足將會造成設備損害。
- 請插在正確的電壓供給插座（如：北美 / 台灣電壓 110V AC，歐洲是 230V AC）。
- 假若電源變壓器或電源變壓器的纜線損壞，請從插座拔除，若您還繼續插電使用，會有觸電死亡的風險。
- 請勿試圖修理電源變壓器或電源變壓器的纜線，若有毀損，請直接聯絡您購買的店家，購買一個新的電源變壓器。
- 請勿將此設備安裝於室外，此設備僅適合放置於室內。
- 請勿隨一般垃圾丟棄。
- 請參閱產品背貼上的設備額定功率。
- 請參考產品型錄或是彩盒上的作業溫度。
- 產品沒有斷電裝置或者採用電源線的插頭視為斷電裝置的一部分，以下警語將適用：
 - 對永久連接之設備，在設備外部須安裝可觸及之斷電裝置；
 - 對插接式之設備，插座必須接近安裝之地點而且是易於觸及的。

Viewing Certifications

Go to <http://www.zyxel.com> to view this product's documentation and certifications.

ZyXEL Limited Warranty

ZyXEL warrants to the original end user (purchaser) that this product is free from any defects in material or workmanship for a specific period (the Warranty Period) from the date of purchase. The Warranty Period varies by region. Check with your vendor and/or the authorized ZyXEL local distributor for details about the Warranty Period of this product. During the warranty period, and upon proof of purchase, should the product have indications of failure due to faulty workmanship and/or materials, ZyXEL will, at its discretion, repair or replace the defective products or components without charge for either parts or labor, and to whatever extent it shall deem necessary to restore the product or components to proper operating condition. Any replacement will consist of a new or re-manufactured functionally equivalent product of equal or higher value, and will be solely at the discretion of ZyXEL. This warranty shall not apply if the product has been modified, misused, tampered with, damaged by an act of God, or subjected to abnormal working conditions.

Note

Repair or replacement, as provided under this warranty, is the exclusive remedy of the purchaser. This warranty is in lieu of all other warranties, express or implied, including any implied warranty of merchantability or fitness for a particular use or purpose. ZyXEL shall in no event be held liable for indirect or consequential damages of any kind to the purchaser.

To obtain the services of this warranty, contact your vendor. You may also refer to the warranty policy for the region in which you bought the device at http://www.zyxel.com/web/support_warranty_info.php.

Registration

Register your product online to receive e-mail notices of firmware upgrades and information at www.zyxel.com.

Open Source Licenses

This product contains in part some free software distributed under GPL license terms and/or GPL like licenses. Open source licenses are provided with the firmware package. You can download the latest firmware at www.zyxel.com. If you cannot find it there, contact your vendor or ZyXEL Technical Support at support@zyxel.com.tw.

To obtain the source code covered under those Licenses, please contact your vendor or ZyXEL Technical Support at support@zyxel.com.tw.

Index

A

ACL rule [197](#)
activation
 firewalls [194](#)
 media server [192](#)
 SIP ALG [166](#)
 SSID [91](#)
Address Resolution Protocol [221](#)
applications
 Internet access [16](#)
 media server [191](#)
 activation [192](#)
 iTunes server [191](#)
applications, NAT [170](#)
ARP Table [221](#), [223](#)
authentication [104](#), [105](#)
 RADIUS server [105](#)

B

backup
 configuration [250](#)
Basic Service Set, see BSS
blinking LEDs [18](#)
Broadband [59](#)
broadcast [83](#)
BSS [107](#)
 example [107](#)

C

CA [208](#)
Canonical Format Indicator See CFI
CCMs [253](#)
certificate
 factory default [209](#)
certificates [208](#)

 authentication [208](#)
 CA
 creating [209](#)
 public key [208](#)
 replacing [209](#)
 storage space [209](#)
Certification Authority [208](#)
Certification Authority. see CA
certifications
 viewing [303](#)
CFI [83](#)
CFM [253](#)
 CCMs [253](#)
 link trace test [253](#)
 loopback test [253](#)
 MA [253](#)
 MD [253](#)
 MEP [253](#)
 MIP [253](#)
channel, wireless LAN [103](#)
client list [122](#)
compatibility, WDS [97](#)
configuration
 backup [250](#)
 firewalls [194](#)
 reset [251](#)
 restoring [251](#)
 static route [79](#), [133](#), [135](#), [174](#)
Connectivity Check Messages, see CCMs
copyright [297](#)
CoS [153](#)
CoS technologies [140](#)
creating certificates [209](#)
CTS threshold [100](#), [104](#)

D

data fragment threshold [100](#), [104](#)
DDoS [194](#)
default server address [165](#)

Denials of Service, see DoS
DHCP [117](#), [129](#)
Differentiated Services, see DiffServ [153](#)
DiffServ [153](#)
 marking rule [153](#)
digital IDs [208](#)
disclaimer [297](#)
DLNA [191](#)
DMZ [165](#)
DNS [117](#), [129](#)
DNS server address assignment [83](#)
Domain Name [171](#)
Domain Name System, see DNS
Domain Name System. See DNS.
DoS [194](#)
DS field [153](#)
DS, dee differentiated services
DSCP [153](#)
dynamic DNS [173](#)
 wildcard [173](#)
Dynamic Host Configuration Protocol, see DHCP
DYNDNS wildcard [173](#)

E

ECHO [171](#)
Encapsulation [79](#)
 MER [80](#)
 PPP over Ethernet [80](#)
encapsulation
 RFC 1483 [80](#)
encryption [106](#)
Extended Service Set IDentification [87](#), [93](#)

F

FCC interference statement [297](#)
file sharing [17](#)
filters
 MAC address [94](#), [105](#)
Finger [171](#)
firewalls [193](#)

add protocols [195](#)
configuration [194](#)
DDoS [194](#)
DoS [194](#)
LAND attack [194](#)
Ping of Death [194](#)
SYN attack [194](#)
firmware [248](#)
 version [57](#)
forwarding ports [158](#)
fragmentation threshold [100](#), [104](#)
FTP [158](#), [171](#)

G

General wireless LAN screen [86](#)

H

HTTP [171](#)

I

IEEE 802.1Q [83](#)
IGA [169](#)
IGMP [83](#)
 multicast group list [225](#)
 version [83](#)
IGMP Fast Leave [177](#)
ILA [169](#)
Inside Global Address, see IGA
Inside Local Address, see ILA
interface group [183](#)
Internet
 wizard setup [29](#)
Internet access [16](#)
 wizard setup [29](#)
Internet Protocol version 6 [61](#)
introduction [15](#)
IP address [117](#), [130](#)
 ping [254](#)
 private [130](#)

WAN [60](#)

IP Address Assignment [82](#)

IP alias

- NAT applications [171](#)

IPv6 [61](#)

- addressing [61, 84](#)
- prefix [61, 84](#)
- prefix delegation [62](#)
- prefix length [61, 84](#)

iTunes server [191](#)

L

LAN [116](#)

- client list [122](#)
- DHCP [117, 129](#)
- DNS [117, 129](#)
- IP address [117, 118, 130](#)
- MAC address [122](#)
- status [57](#)
- subnet mask [117, 118, 130](#)

LAND attack [194](#)

LBR [253](#)

limitations

- wireless LAN [106](#)
- WPS [114](#)

link trace [253](#)

Link Trace Message, see LTM

Link Trace Response, see LTR

login [21](#)

- passwords [21](#)

logs [215, 218, 225](#)

Loop Back Response, see LBR

loopback [253](#)

LTM [253](#)

LTR [253](#)

M

MA [253](#)

MAC address [94, 122](#)

- filter [94, 105](#)

MAC authentication [94](#)

Mac filter [200](#)

Maintenance Association, see MA

Maintenance Domain, see MD

Maintenance End Point, see MEP

Management Information Base (MIB) [238](#)

managing the device

- good habits [15](#)

Maximum Burst Size (MBS) [81](#)

MBSSID [107](#)

MD [253](#)

media server [191](#)

- activation [192](#)
- iTunes server [191](#)

MEP [253](#)

MLD [177](#)

MTU (Multi-Tenant Unit) [82](#)

multicast [83](#)

Multicast Listener Discovery [177](#)

Multiple BSS, see MBSSID

multiplexing [80](#)

- LLC-based [81](#)
- VC-based [80](#)

multiprotocol encapsulation [80](#)

N

NAT [157, 158, 159, 169](#)

- applications [170](#)
- IP alias [171](#)
- example [170](#)
- global [169](#)
- IGA [169](#)
- ILA [169](#)
- inside [169](#)
- local [169](#)
- outside [169](#)
- port forwarding [158](#)
- port number [171](#)
- services [171](#)
- SIP ALG [166](#)
- activation [166](#)

NAT example [172](#)

Network Address Translation, see NAT

Network Map [55](#)

network map [25](#)

NNTP [171](#)

P

passwords [21](#)

PBC [109](#)

Peak Cell Rate (PCR) [81](#)

Per-Hop Behavior, see PHB [153](#)

PHB [153](#)

PIN, WPS [109](#)

example [111](#)

Ping of Death [194](#)

Point-to-Point Tunneling Protocol, see PPTP

POP3 [171](#)

port forwarding [158](#)

ports [18](#)

PPPoE [80](#)

Benefits [80](#)

PPTP [171](#)

preamble [101](#), [104](#)

preamble mode [108](#)

prefix delegation [62](#)

private IP address [130](#)

product registration [303](#)

push button [20](#)

Push Button Configuration, see PBC

push button, WPS [109](#)

Q

QoS [139](#), [153](#)

marking [140](#)

setup [139](#)

tagging [140](#)

versus CoS [140](#)

Quality of Service, see QoS

R

RADIUS server [105](#)

registration

product [303](#)

reset [19](#), [251](#)

restart [252](#)

restoring configuration [251](#)

RFC 1058. See RIP.

RFC 1389. See RIP.

RFC 1483 [80](#)

RFC 3164 [215](#)

RIP [138](#)

router features [16](#)

Routing Information Protocol. See RIP

RTS threshold [100](#), [104](#)

S

scheduled rules [206](#)

security

wireless LAN [104](#)

Security Log [216](#)

Security Parameter Index, see SPI

service access control [235](#), [236](#)

Service Set [87](#), [93](#)

Services [171](#)

setup

firewalls [194](#)

static route [79](#), [133](#), [135](#), [174](#)

Simple Network Management Protocol, see SNMP

Single Rate Three Color Marker, see srTCM

SIP ALG [166](#)

activation [166](#)

SMTP [171](#)

SNMP [171](#), [239](#)

agents [238](#)

Get [239](#)

GetNext [239](#)

Manager [238](#)

managers [238](#)

MIB [238](#)

network components [238](#)

Set [239](#)

Trap [239](#)

SNMP trap [171](#)

SPI [194](#)

srTCM [155](#)

- SSID [105](#)
 - activation [91](#)
 - MBSSID [107](#)
 - static route [132, 138, 243](#)
 - configuration [79, 133, 135, 174](#)
 - example [132](#)
 - static VLAN
 - status [55](#)
 - firmware version [57](#)
 - LAN [57](#)
 - WAN [57](#)
 - wireless LAN [57](#)
 - status indicators [18](#)
 - subnet mask [117, 130](#)
 - Sustained Cell Rate (SCR) [81](#)
 - SYN attack [194](#)
 - Syslog [245](#)
 - syslog
 - destination [246](#)
 - protocol [215](#)
 - severity levels [215](#)
 - syslog server [246](#)
 - system
 - firmware [248](#)
 - version [57](#)
 - passwords [21](#)
 - reset [19](#)
 - status [55](#)
 - LAN [57](#)
 - WAN [57](#)
 - wireless LAN [57](#)
 - system time [240](#)
- T**
- Tag Control Information See [TCI](#)
 - Tag Protocol Identifier See [TPID](#)
 - TCI
 - The [60](#)
 - thresholds
 - data fragment [100, 104](#)
 - RTS/CTS [100, 104](#)
 - TPID [83](#)
 - trademarks [297](#)
 - traffic shaping [81](#)
 - trTCM [156](#)
 - Two Rate Three Color Marker, see [trTCM](#)
- U**
- unicast [83](#)
 - Universal Plug and Play, see [UPnP](#)
 - upgrading firmware [248](#)
 - UPnP [123](#)
 - cautions [118](#)
 - NAT traversal [117](#)
 - USB features [17](#)
- V**
- Vendor ID [127](#)
 - VID
 - Virtual Circuit (VC) [80](#)
 - Virtual Local Area Network See [VLAN](#)
 - VLAN [82](#)
 - Introduction [82](#)
 - number of possible VIDs
 - priority frame
 - static
 - VLAN ID [83](#)
 - VLAN Identifier See [VID](#)
 - VLAN tag [83](#)
- W**
- Wake on LAN [127](#)
 - WAN
 - status [57](#)
 - Wide Area Network, see [WAN](#) [59](#)
 - warranty [303](#)
 - note [303](#)
 - WDS [97, 108](#)
 - compatibility [97](#)
 - example [108](#)
 - web configurator [21](#)
 - login [21](#)
 - passwords [21](#)

- WEP [106](#)
- WEP Encryption [89, 90](#)
- WEP encryption [88](#)
- WEP key [88](#)
- Wireless Distribution System, see WDS
- wireless LAN [85, 102](#)
 - authentication [104, 105](#)
 - BSS [107](#)
 - example [107](#)
 - channel [103](#)
 - encryption [106](#)
 - example [103](#)
 - fragmentation threshold [100, 104](#)
 - limitations [106](#)
 - MAC address filter [94, 105](#)
 - MBSSID [107](#)
 - preamble [101, 104](#)
 - RADIUS server [105](#)
 - RTS/CTS threshold [100, 104](#)
 - security [104](#)
 - SSID [105](#)
 - activation [91](#)
 - status [57](#)
 - WDS [97, 108](#)
 - compatibility [97](#)
 - example [108](#)
 - WEP [106](#)
 - WPA [106](#)
 - WPA-PSK [106](#)
 - WPS [108, 111](#)
 - example [112](#)
 - limitations [114](#)
 - PIN [109](#)
 - push button [20, 109](#)
- Wireless tutorial [36](#)
- wizard setup
 - Internet [29](#)
- WPA [106](#)
- WPA-PSK [106](#)
- WPS [108, 111](#)
 - example [112](#)
 - limitations [114](#)
 - PIN [109](#)
 - example [111](#)
 - push button [20, 109](#)