

P-660N-T1A

802.11n Wireless ADSL2+ Gateway

User's Guide

Default Login Details

IP Address	http://192.168.1.1
Password	1234

Firmware Version 3.40
Edition 2, 8/2010

www.zyxel.com

The logo for ZyXEL, featuring the word "ZyXEL" in a bold, blue, sans-serif font. The "Z" and "Y" are connected, and the "X" is stylized with a diagonal slash.

About This User's Guide

Intended Audience

This manual is intended for people who want to configure the ZyXEL Device using the web configurator. You should have at least a basic knowledge of TCP/IP networking concepts and topology.

Related Documentation

- Quick Start Guide

The Quick Start Guide is designed to help you get up and running right away. It contains information on setting up your network and configuring for Internet access.

- Support Disc

Refer to the included CD for support documents.

- ZyXEL Web Site

Please refer to www.zyxel.com for additional support documentation and product certifications.

Documentation Feedback

Send your comments, questions or suggestions to: techwriters@zyxel.com.tw

Thank you!

The Technical Writing Team, ZyXEL Communications Corp.,
6 Innovation Road II, Science-Based Industrial Park, Hsinchu, 30099, Taiwan.

Need More Help?

More help is available at www.zyxel.com.



- Download Library

Search for the latest product updates and documentation from this link. Read the Tech Doc Overview to find out how to efficiently use the User Guide, Quick Start Guide and Command Line Interface Reference Guide in order to better understand how to use your product.

- Knowledge Base

If you have a specific question about your product, the answer may be here. This is a collection of answers to previously asked questions about ZyXEL products.

- Forum

This contains discussions on ZyXEL products. Learn from others who use ZyXEL products and share your experiences as well.

Customer Support

In the event of problems that cannot be solved by using this manual, you should contact your vendor. If you cannot contact your vendor, then contact a ZyXEL office for the region in which you bought the device. See http://www.zyxel.com/web/contact_us.php for contact information. Please have the following information ready when you contact an office.

- Product model and serial number.
- Warranty Information.
- Date that you received your device.
- Brief description of the problem and the steps you took to solve it.

Disclaimer

Graphics in this book may differ slightly from the product due to differences in operating systems, operating system versions, or if you installed updated firmware/software for your device. Every effort has been made to ensure that the information in this manual is accurate.

Document Conventions

Warnings and Notes

These are how warnings and notes are shown in this User's Guide.

Warnings tell you about things that could harm you or your device.







Note: Notes tell you other important information (for example, other things you may need to configure or helpful tips) or recommendations.

Syntax Conventions

- The P-660N-T1A may be referred to as the "ZyXEL Device", the "device", the "system" or the "product" in this User's Guide.
- Product labels, screen names, field labels and field choices are all in **bold** font.
- A key stroke is denoted by square brackets and uppercase text, for example, [ENTER] means the "enter" or "return" key on your keyboard.
- "Enter" means for you to type one or more characters and then press the [ENTER] key. "Select" or "choose" means for you to use one of the predefined choices.
- A right angle bracket (>) within a screen name denotes a mouse click. For example, **Maintenance > Log > Log Setting** means you first click **Maintenance** in the navigation panel, then the **Log** sub menu and finally the **Log Setting** tab to get to that screen.
- Units of measurement may denote the "metric" value or the "scientific" value. For example, "k" for kilo may denote "1000" or "1024", "M" for mega may denote "1000000" or "1048576" and so on.
- "e.g.," is a shorthand for "for instance", and "i.e.," means "that is" or "in other words".

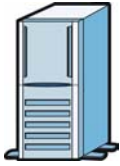
Icons Used in Figures

Figures in this User's Guide may use the following generic icons. The ZyXEL Device icon is not an exact representation of your device.

ZyXEL Device 	Computer 	Notebook computer 
Server 	Firewall 	Telephone 
Router 	Switch 	

Safety Warnings

- Do NOT use this product near water, for example, in a wet basement or near a swimming pool.
- Do NOT expose your device to dampness, dust or corrosive liquids.
- Do NOT store things on the device.
- Do NOT install, use, or service this device during a thunderstorm. There is a remote risk of electric shock from lightning.
- Connect ONLY suitable accessories to the device.
- Do NOT open the device or unit. Opening or removing covers can expose you to dangerous high voltage points or other risks. ONLY qualified service personnel should service or disassemble this device. Please contact your vendor for further information.
- Make sure to connect the cables to the correct ports.
- Place connecting cables carefully so that no one will step on them or stumble over them.
- Always disconnect all cables from this device before servicing or disassembling.
- Use ONLY an appropriate power adaptor or cord for your device.
- Connect the power adaptor or cord to the right supply voltage (for example, 110V AC in North America or 230V AC in Europe).
- Do NOT allow anything to rest on the power adaptor or cord and do NOT place the product where anyone can walk on the power adaptor or cord.
- Do NOT use the device if the power adaptor or cord is damaged as it might cause electrocution.
- If the power adaptor or cord is damaged, remove it from the device and the power source.
- Do NOT attempt to repair the power adaptor or cord. Contact your local vendor to order a new one.
- Do not use the device outside, and make sure all the connections are indoors. There is a remote risk of electric shock from lightning.
- Do NOT obstruct the device ventilation slots, as insufficient airflow may harm your device.
- Use only No. 26 AWG (American Wire Gauge) or larger telecommunication line cord.
- Antenna Warning! This device meets ETSI and FCC certification requirements when using the included antenna(s). Only use the included antenna(s).
- If you wall mount your device, make sure that no electrical lines, gas or water pipes will be damaged.

Your product is marked with this symbol, which is known as the WEEE mark. WEEE stands for Waste Electronics and Electrical Equipment. It means that used electrical and electronic products should not be mixed with general waste. Used electrical and electronic equipment should be treated separately.



Contents Overview

User's Guide	19
Introduction	21
The Web Configurator	27
Status Screen	35
Tutorials	39
Technical Reference	51
Internet and Wireless Setup Wizard	53
WAN Setup	67
LAN Setup	85
Wireless LAN	99
Network Address Translation (NAT)	131
Firewall	147
Filters	151
Static Route	157
802.1Q/1P	161
Quality of Service (QoS)	167
Dynamic DNS Setup	175
Remote Management	177
Universal Plug-and-Play (UPnP)	187
CWMP	197
System Settings	201
Logs	205
Tools	215
Diagnostic	223
Troubleshooting	227
Product Specifications	233

Table of Contents

About This User's Guide	3
Document Conventions.....	5
Safety Warnings.....	7
Contents Overview	9
Table of Contents.....	11
Part I: User's Guide.....	19
Chapter 1	
Introduction.....	21
1.1 Overview	21
1.2 Ways to Manage the ZyXEL Device	21
1.2.1 Good Habits for Managing the ZyXEL Device	22
1.3 Internet Access	22
1.4 Wireless Access	23
1.4.1 Using the WPS/WLAN Button	23
1.5 LEDs (Lights)	25
1.6 The RESET Button	26
1.6.1 Using the Reset Button	26
Chapter 2	
The Web Configurator	27
2.1 Overview	27
2.1.1 Accessing the Web Configurator	27
2.2 Main Screen	30
2.2.1 Title Bar	31
2.2.2 Navigation Panel	31
2.2.3 Main Window	33
2.2.4 Status Bar	34
Chapter 3	
Status Screen	35
3.1 Overview	35
3.2 The Status Screen	35

Chapter 4	
Tutorials	39
4.1 Overview	39
4.2 Setting Up a Secure Wireless Network	39
4.2.1 Configuring the Wireless Network Settings	39
4.2.2 Using WPS	41
4.2.3 Without WPS	45
4.2.4 Setting Up Wireless Network Scheduling	45
4.3 Configuring the MAC Address Filter	46
4.4 Multiple WAN Connections Example	48
Part II: Technical Reference	51
Chapter 5	
Internet and Wireless Setup Wizard	53
5.1 Overview	53
5.2 Internet Access Wizard Setup	53
5.2.1 Manual Configuration	56
5.3 Wireless Connection Wizard Setup	62
5.3.1 Manually Assign a WPA-PSK key	64
5.3.2 Manually Assign a WEP Key	65
Chapter 6	
WAN Setup	67
6.1 Overview	67
6.1.1 What You Can Do in the WAN Screens	67
6.1.2 What You Need to Know	67
6.1.3 Before You Begin	68
6.2 The Internet Connection Screen	69
6.2.1 Advanced Setup	72
6.3 The More Connections Screen	74
6.3.1 More Connections Edit	75
6.3.2 Advanced Setup	77
6.4 Technical Reference	78
6.4.1 Encapsulation	78
6.4.2 Multiplexing	80
6.4.3 VPI and VCI	80
6.4.4 IP Address Assignment	80
6.4.5 Nailed-Up Connection (PPP)	81
6.4.6 NAT	81
6.5 Traffic Shaping	81

6.5.1 ATM Traffic Classes	82
Chapter 7	
LAN Setup.....	85
7.1 Overview	85
7.1.1 What You Can Do in the LAN Screens	85
7.1.2 What You Need To Know	86
7.1.3 Before You Begin	87
7.2 The IP Screen	87
7.2.1 The Advanced Setup Screen	88
7.3 The DHCP Server Screen	89
7.4 The Client List Screen	90
7.5 The IP Alias Screen	91
7.5.1 Configuring the LAN IP Alias Screen	92
7.6 Technical Reference	94
7.6.1 LANs, WANs and the ZyXEL Device	94
7.6.2 DHCP Setup	94
7.6.3 DNS Server Addresses	94
7.6.4 LAN TCP/IP	95
7.6.5 RIP Setup	96
7.6.6 Multicast	97
Chapter 8	
Wireless LAN.....	99
8.1 Overview	99
8.1.1 What You Can Do in the Wireless LAN Screens	99
8.1.2 What You Need to Know	100
8.1.3 Before You Start	101
8.2 The AP Screen	101
8.2.1 No Security	102
8.2.2 WEP Encryption	103
8.2.3 WPA(2)-PSK	104
8.2.4 WPA(2) Authentication	105
8.2.5 Advanced Setup	106
8.2.6 MAC Filter	108
8.3 The More AP Screen	109
8.3.1 More AP Edit	110
8.4 The WPS Screen	111
8.5 The WPS Station Screen	112
8.6 The WDS Screen	113
8.7 The Scheduling Screen	115
8.8 Technical Reference	116
8.8.1 Wireless Network Overview	116

8.8.2 Additional Wireless Terms	118
8.8.3 Wireless Security Overview	118
8.8.4 Signal Problems	121
8.8.5 BSS	121
8.8.6 MBSSID	122
8.8.7 Wireless Distribution System (WDS)	123
8.8.8 WiFi Protected Setup (WPS)	123
Chapter 9	
Network Address Translation (NAT).....	131
9.1 Overview	131
9.1.1 What You Can Do in the NAT Screens	131
9.1.2 What You Need To Know	131
9.2 The General Setup Screen	133
9.3 The Port Forwarding Screen	134
9.3.1 Configuring the Port Forwarding Screen	135
9.3.2 The Port Forwarding Rule Edit Screen	137
9.4 The Address Mapping Screen	138
9.4.1 The Address Mapping Rule Edit Screen	140
9.5 The ALG Screen	141
9.6 Technical Reference	142
9.6.1 NAT Definitions	142
9.6.2 What NAT Does	142
9.6.3 How NAT Works	143
9.6.4 NAT Application	144
9.6.5 NAT Mapping Types	144
Chapter 10	
Firewall.....	147
10.1 Overview	147
10.1.1 What You Can Do in the Firewall Screens	147
10.1.2 What You Need to Know	147
10.2 The Firewall Screen	149
Chapter 11	
Filters	151
11.1 Overview	151
11.1.1 What You Can Do in the Filter Screens	151
11.1.2 What You Need to Know	151
11.2 The URL Filter Screen	152
11.3 The Application Filter Screen	153
11.4 The IP/MAC Filter Screen	154

Chapter 12	
Static Route	157
12.1 Overview	157
12.1.1 What You Can Do in the Static Route Screens	158
12.2 The Static Route Screen	158
12.2.1 Static Route Edit	159
Chapter 13	
802.1Q/1P	161
13.1 Overview	161
13.1.1 What You Can Do in the 802.1Q/1P Screens	161
13.1.2 What You Need to Know	161
13.2 The 802.1Q/1P Group Setting Screen	163
13.2.1 Editing 802.1Q/1P Group Setting	164
13.3 The 802.1Q/1P Port Setting Screen	166
Chapter 14	
Quality of Service (QoS)	167
14.1 Overview	167
14.1.1 What You Can Do in the QoS Screens	168
14.1.2 What You Need to Know	168
14.2 The QoS Screen	169
14.2.1 The QoS Settings Summary Screen	171
14.3 Technical Reference	172
14.3.1 IEEE 802.1p	172
14.3.2 IP Precedence	173
14.3.3 Automatic Priority Queue Assignment	173
Chapter 15	
Dynamic DNS Setup	175
15.1 Overview	175
15.1.1 What You Can Do in the DDNS Screen	175
15.1.2 What You Need To Know	175
15.2 The Dynamic DNS Screen	176
Chapter 16	
Remote Management	177
16.1 Overview	177
16.1.1 What You Can Do in the Remote Management Screens	178
16.1.2 What You Need to Know	178
16.2 The WWW Screen	179
16.2.1 Configuring the WWW Screen	179
16.3 The Telnet Screen	180

16.4 The FTP Screen	181
16.5 The SNMP Screen	182
16.5.1 Supported MIBs	183
16.5.2 SNMP Traps	183
16.5.3 Configuring SNMP	184
16.6 The DNS Screen	184
16.7 The ICMP Screen	185
Chapter 17	
Universal Plug-and-Play (UPnP).....	187
17.1 Overview	187
17.1.1 What You Can Do in the UPnP Screen	187
17.1.2 What You Need to Know	187
17.2 The UPnP Screen	189
17.2.1 Installing UPnP in Windows	190
17.2.2 Using UPnP in Windows XP	192
Chapter 18	
CWMP.....	197
18.1 Overview	197
18.2 The CWMP Setup Screen	198
Chapter 19	
System Settings.....	201
19.1 Overview	201
19.1.1 What You Can Do in the System Settings Screens	201
19.2 The General Screen	201
19.3 The Time and Date Screen	202
Chapter 20	
Logs.....	205
20.1 Overview	205
20.1.1 What You Need To Know	205
20.2 The System Log Screen	205
20.3 Log Descriptions	207
Chapter 21	
Tools.....	215
21.1 Overview	215
21.1.1 What You Can Do in the Tool Screens	215
21.1.2 What You Need To Know	215
21.1.3 Before You Begin	216
21.2 The Firmware Screen	216

21.3 The Configuration Screen	218
21.4 The Restart Screen	221
Chapter 22	
Diagnostic.....	223
22.1 Overview	223
22.1.1 What You Can Do in the Diagnostic Screens	223
22.2 The General Diagnostic Screen	223
22.3 The DSL Line Diagnostic Screen	224
Chapter 23	
Troubleshooting.....	227
23.1 Power, Hardware Connections, and LEDs	227
23.2 ZyXEL Device Access and Login	228
23.3 Internet Access	230
Chapter 24	
Product Specifications	233
24.1 Hardware Specifications	233
24.2 Firmware Specifications	234
24.3 Standards Support	238
Appendix A Setting Up Your Computer's IP Address	241
Appendix B IP Addresses and Subnetting	269
Appendix C Pop-up Windows, JavaScripts and Java Permissions	279
Appendix D Wireless LANs	289
Appendix E Services	305
Appendix F Legal Information	309
Index.....	313

PART I

User's Guide

Introduction

1.1 Overview

The P-660N-T1A is an ADSL2+ router. Integrated DSL and NAT, provides ease of installation and high-speed, shared Internet access. It is also a complete security solution with a robust firewall and content filtering.

Please refer to the following description of the product name format.

- Models ending in "1", for example P-660N-T1A, denote a device that works over the analog telephone system, POTS (Plain Old Telephone Service). Models ending in "3" denote a device that works over ISDN (Integrated Services Digital Network) or T-ISDN (UR-2).

Only use firmware for your ZyXEL Device's specific model. Refer to the label on the bottom of your ZyXEL Device.

Note: All screens displayed in this user's guide are from the **P-660N-T1A** model.

See the product specifications for a full list of features.

1.2 Ways to Manage the ZyXEL Device

Use any of the following methods to manage the ZyXEL Device.

- Web Configurator. This is recommended for everyday management of the ZyXEL Device using a (supported) web browser.
- Command Line Interface. Line commands are mostly used for troubleshooting by service engineers.
- FTP for firmware upgrades and configuration backup/restore.
- TR-069. This is an auto-configuration server used to remotely configure your device.

1.2.1 Good Habits for Managing the ZyXEL Device

Do the following things regularly to make the ZyXEL Device more secure and to manage the ZyXEL Device more effectively.

- Change the password. Use a password that's not easy to guess and that consists of different types of characters, such as numbers and letters.
- Write down the password and put it in a safe place.
- Back up the configuration (and make sure you know how to restore it). Restoring an earlier working configuration may be useful if the device becomes unstable or even crashes. If you forget your password, you will have to reset the ZyXEL Device to its factory default settings. If you backed up an earlier configuration file, you would not have to totally re-configure the ZyXEL Device. You could simply restore your last configuration.

1.3 Internet Access

Your ZyXEL Device provides shared Internet access by connecting the DSL port to the **DSL** or **MODEM** jack on a splitter or your telephone jack. Computers can connect to the ZyXEL Device's LAN port or wirelessly.

Figure 1 Internet Access Example

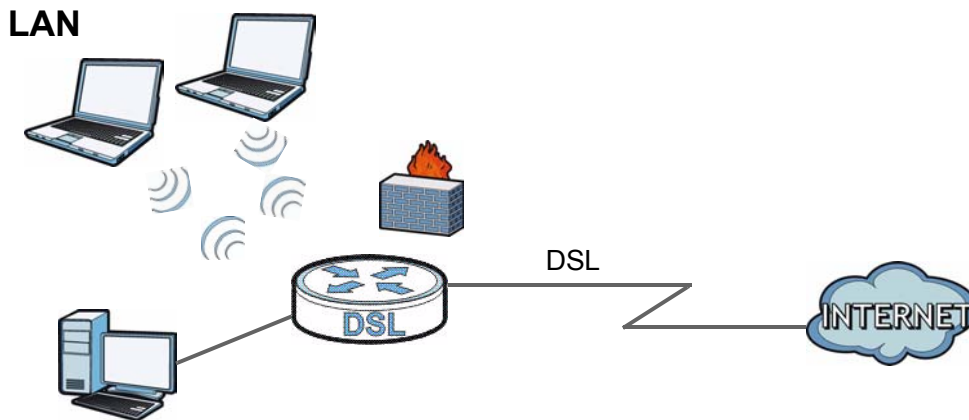

You can also configure firewall and filtering feature on the ZyXEL Device for secure Internet access. When the firewall is on, all incoming traffic from the Internet to your network is blocked unless it is initiated from your network. This means that probes from the outside to your network are not allowed, but you can safely browse the Internet and download files.

Use the filtering feature to block access to specific web sites or Internet applications such as MSN or Yahoo Messenger. You can also configure IP/MAC filtering rules for incoming or outgoing traffic.

Use QoS to efficiently manage traffic on your network by giving priority to certain types of traffic and/or to particular computers. For example, you could make sure that the ZyXEL Device gives Voice over Internet (VoIP) calls high priority, and/or limit bandwidth devoted to the boss's excessive file downloading.

1.4 Wireless Access

The ZyXEL Device is a wireless Access Point (AP) for wireless clients, such as notebook computers or PDAs and iPads. It allows them to connect to the Internet without having to rely on inconvenient Ethernet cables.

You can configure your wireless network in either the built-in Web Configurator, or using the WPS button.

Figure 2 Wireless Access Example

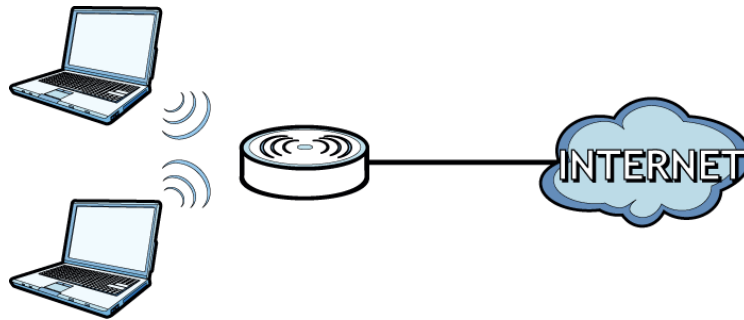

1.4.1 Using the WPS/WLAN Button

By default, the wireless network is turned off on the ZyXEL Device. To turn it on, simply press the **WPS/WLAN** button on top of the device for 1 second. Once the **WPS/WLAN** LED turns green, the wireless network is active.

You can also use the **WPS/WLAN** button to quickly set up a secure wireless connection between the ZyXEL Device and a WPS-compatible client by adding one device at a time.

To activate WPS:

- 1 Make sure the **POWER** LED is on and not blinking.
- 2 Press the **WPS/WLAN** button for five to ten seconds and release it.

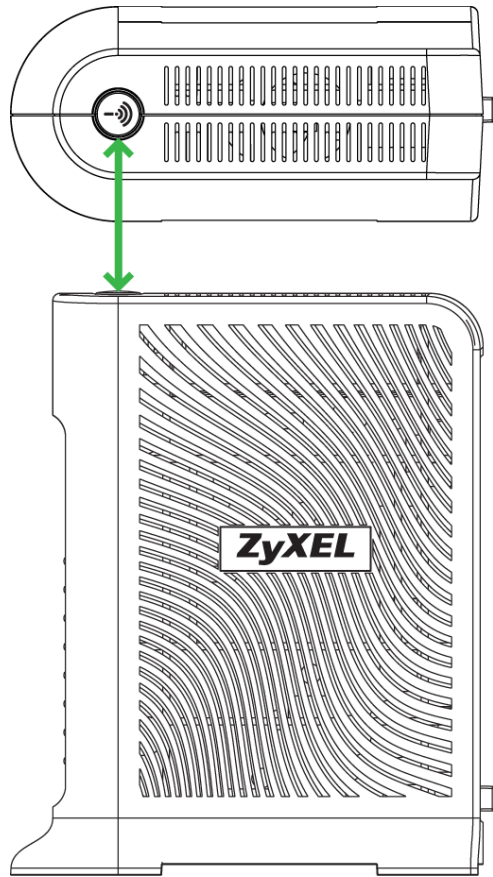

- 3 Press the WPS button on another WPS-enabled device within range of the ZyXEL Device. The **WPS/WLAN** LED should flash while the ZyXEL Device sets up a WPS connection with the other wireless device.
- 4 Once the connection is successfully made, the **WPS/WLAN** LED shines green.

1.5 LEDs (Lights)

The following graphic displays the labels of the LEDs.

Figure 3 LEDs on the Front Panel

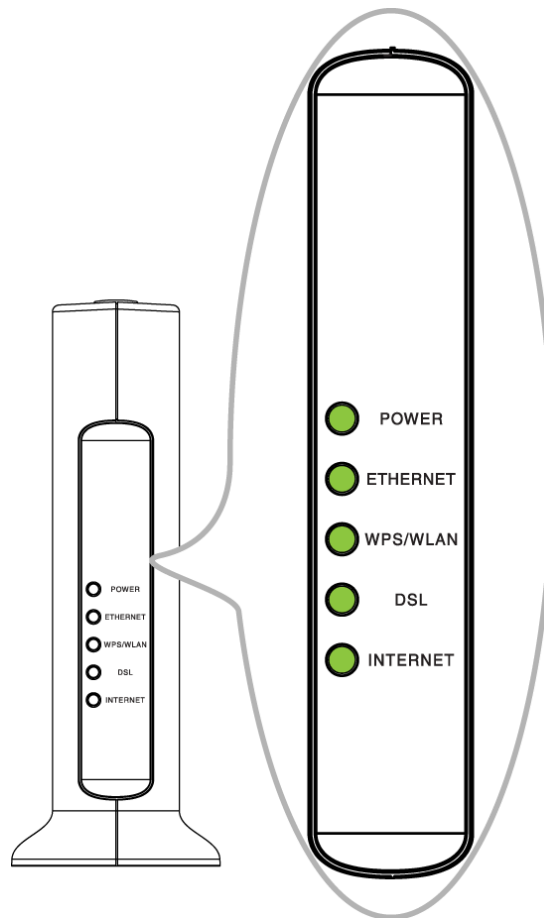

None of the LEDs are on if the ZyXEL Device is not receiving power.

Table 1 LED Descriptions

LED	COLOR	STATUS	DESCRIPTION
POWER	Green	On	The ZyXEL Device is receiving power and ready for use.
		Blinking	The ZyXEL Device is self-testing.
		Off	The ZyXEL Device is not receiving power.
ETHERNET	Green	On	The ZyXEL Device has an Ethernet connection with a device on the Local Area Network (LAN).
		Blinking	The ZyXEL Device is sending/receiving data to /from the LAN.
		Off	The ZyXEL Device does not have an Ethernet connection with the LAN.

Table 1 LED Descriptions

LED	COLOR	STATUS	DESCRIPTION
WPS/ WLAN	Green	On	The wireless network is activated.
		Blinking	The ZyXEL Device is communicating with other wireless clients.
		Off	The wireless network is not activated.
	Orange	Blinking	The ZyXEL Device is setting up a WPS connection.
DSL	Green	On	The DSL line is up.
		Blinking	The ZyXEL Device is initializing the DSL line.
		Off	The DSL line is down.
INTERNET	Green	On	The ZyXEL Device has an IP connection but no traffic. Your device has a WAN IP address (either static or assigned by a DHCP server), PPP negotiation was successfully completed (if used) and the DSL connection is up.
		Blinking	The ZyXEL Device is sending or receiving IP traffic.
		Off	The ZyXEL Device does not have an IP connection.
	Red	On	The ZyXEL Device attempted to make an IP connection but failed. Possible causes are no response from a DHCP server, no PPPoE response, PPPoE authentication failed.

Refer to the Quick Start Guide for information on hardware connections.

1.6 The RESET Button

If you forget your password or cannot access the web configurator, you will need to use the **RESET** button at the back of the device to reload the factory-default configuration file. This means that you will lose all configurations that you had previously and the password will be reset to "1234".

1.6.1 Using the Reset Button

- 1 Make sure the **POWER** LED is on (not blinking).
- 2 To set the device back to the factory default settings, press the **RESET** button for ten seconds or until the **POWER** LED begins to blink and then release it. When the **POWER** LED begins to blink, the defaults have been restored and the device restarts.

The Web Configurator

2.1 Overview

The web configurator is an HTML-based management interface that allows easy device setup and management via Internet browser. Use Internet Explorer 6.0 and later or Netscape Navigator 7.0 and later versions. The recommended screen resolution is 1024 by 768 pixels.

In order to use the web configurator you need to allow:

- Web browser pop-up windows from your device. Web pop-up blocking is enabled by default in Windows XP SP (Service Pack) 2.
- JavaScript (enabled by default).
- Java permissions (enabled by default).

See [Appendix C on page 279](#) if you need to make sure these functions are allowed in Internet Explorer.

2.1.1 Accessing the Web Configurator

- 1 Make sure your ZyXEL Device hardware is properly connected (refer to the Quick Start Guide).
- 2 Launch your web browser.
- 3 Type "192.168.1.1" as the URL.

- 4 A password screen displays. Enter the admin password (1234 by default) in the password screen and click **Login**.

Figure 4 Password Screen

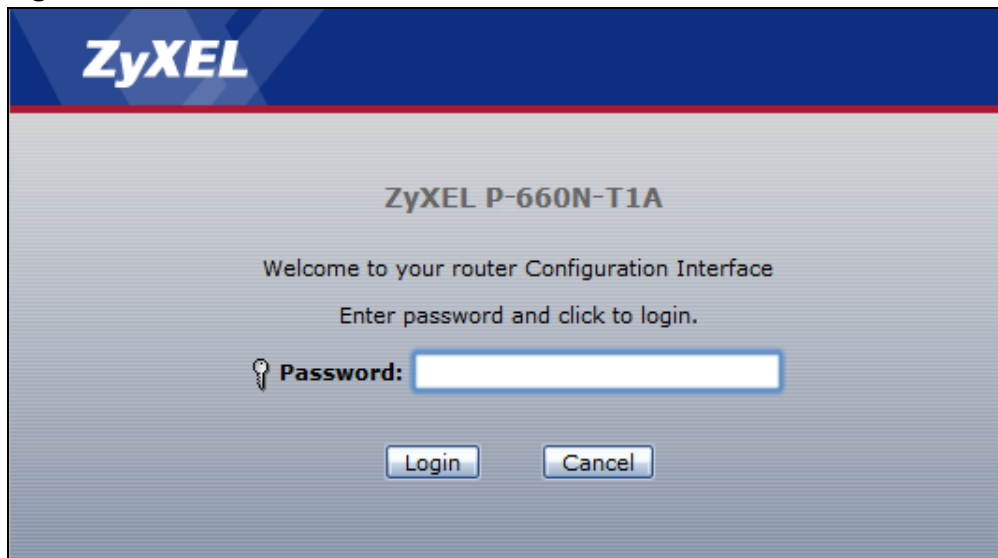

- 5 The following screen displays if you have not yet changed your password. It is strongly recommended you change the default password. Enter a new password, retype it to confirm and click **Apply**; alternatively click **Ignore** to proceed to the main menu if you do not want to change the password now.

Figure 5 Change Password Screen



- 6 Select **Go to Wizard setup** and click **Apply** to display the wizard main screen. Otherwise, select **Go to Advanced setup** and click **Apply** to display the **Status** screen.

Figure 6 Replace Factory Default Certificate Screen

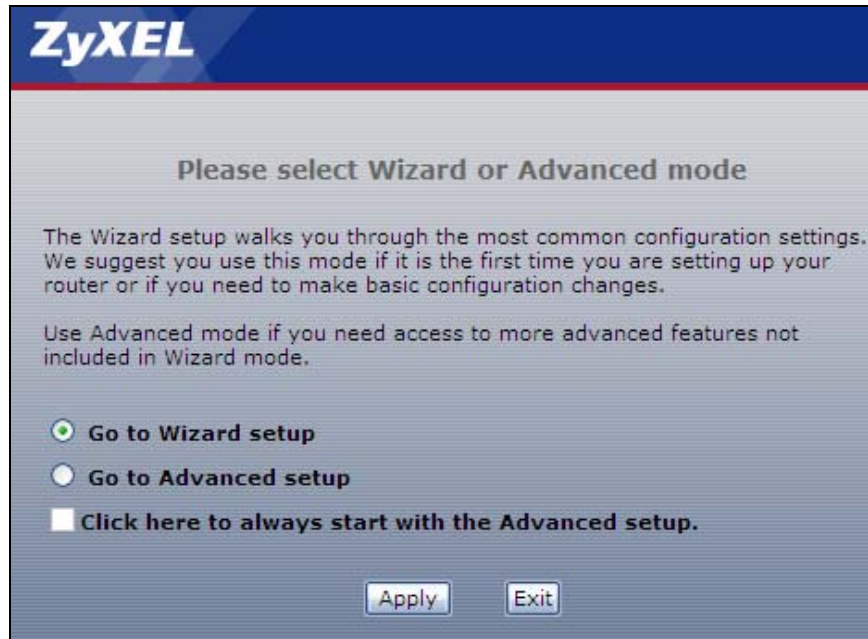

Note: For security reasons, the ZyXEL Device automatically logs you out if you do not use the web configurator for five minutes (default). If this happens, log in again.

2.2 Main Screen

This section introduces the Web Configurator's main screen.

Figure 7 Main Screen

The screenshot shows the ZyXEL Web Configurator main screen. The interface is divided into four main sections:

- A**: Title bar at the top, containing the ZyXEL logo and navigation icons.
- B**: Navigation panel on the left, showing a tree view of menu items including Status, Network (WAN, LAN, Wireless LAN, NAT), Security (Firewall, Filter), Advanced (Static Route, 802.1Q/1P, QoS, Dynamic DNS, Remote MGMT, UPnP, CWMP), and Maintenance (System, Logs, Tools, Diagnostic).
- C**: Main window displaying system status information:
 - Device Information**: Host Name: P-660N-T1A, Model Number: P-660N-T1A, MAC address: 00:a0:c5:14:09:31, ZyNOS Firmware Version: 3.40(BYI.0)b3, DSL Firmware Version: FWVer:3.12.8.140_TC3086, HwVer:T14F7_7.0.
 - System Status**: System Uptime: 0:04:10, Current Date/Time: 01/01/2000 00:06:21, System Mode: Routing / Bridging, CPU Usage: 5%, Memory Usage: 22%.
 - Interface Status**:

Interface	Status	Rate
ADSL	Down	0 / 0
LAN	Up	100M/Full
WLAN	Active	150M
- D**: Status bar at the bottom, showing a message: Message Ready.

The main screen is divided into these parts:

- **A** - title bar
- **B** - navigation panel
- **C** - main window
- **D** - status bar



2.2.1 Title Bar

The title bar provides some icons in the upper right corner.



The icons provide the following functions.

Table 2 Web Configurator Icons in the Title Bar

ICON	DESCRIPTION
	Wizards: Click this icon to go to the configuration wizards. See Chapter 5 on page 53 for more information.
	Logout: Click this icon to log out of the web configurator.

2.2.2 Navigation Panel

Use the menu items on the navigation panel to open screens to configure ZyXEL Device features. The following tables describe each menu item.

Table 3 Navigation Panel Summary

LINK	TAB	FUNCTION
Status		This screen shows the ZyXEL Device's general device and network status information. Use this screen to access the statistics and client list.
Network		
WAN	Internet Connection	Use this screen to configure ISP parameters, WAN IP address assignment, and other advanced properties.
	More Connections	Use this screen to configure additional WAN connections.
LAN	IP	Use this screen to configure LAN TCP/IP settings and other advanced properties.
	DHCP Server	Use this screen to configure LAN DHCP settings and DNS server.
	Client List	Use this screen to view current DHCP client information and to always assign specific IP addresses to individual MAC addresses (and host names).
	IP Alias	Use this screen to partition your LAN interface into subnets.

Table 3 Navigation Panel Summary

LINK	TAB	FUNCTION
Wireless LAN	AP	Use this screen to configure the wireless LAN settings and WLAN authentication/security settings.
	More AP	Use this screen to configure multiple BSSs on the ZyXEL Device.
	WPS	Use this screen to configure and view your WPS (Wi-Fi Protected Setup) settings.
	WPS Station	Use this screen to set up a WPS wireless network.
	WDS	Use this screen to set up Wireless Distribution System links to other access points.
	Scheduling	Use this screen to configure the dates/times to enable or disable the wireless LAN.
NAT	General	Use this screen to enable NAT.
	Port Forwarding	Use this screen to make your local servers visible to the outside world.
	ALG	Use this screen to enable or disable SIP ALG.
Security		
Firewall	General	Use this screen to activate/deactivate the firewall and SPI (Security Parameter Index).
Filter	URL	Use this screen to block access to certain web site URLs.
	Application Filter	Use this screen to block or allow traffic from certain applications.
	IP/MAC Filter	Use this screen to configure IP/MAC filtering rules for incoming or outgoing traffic.
Advanced		
Static Route		Use this screen to configure IP static routes to tell your device about networks beyond the directly connected remote nodes.
802.1Q/1P	Group Setting	Use this screen to activate 802.1Q/1P, specify the management VLAN group, display the VLAN groups and configure the settings for each VLAN group.
	Port Setting	Use this screen to configure the PVID and assign traffic priority for each port.
QoS	General	Use this screen to enable QoS and traffic prioritizing. You can also configure the QoS rules and actions.
Dynamic DNS		This screen allows you to use a static hostname alias for a dynamic IP address.

Table 3 Navigation Panel Summary

LINK	TAB	FUNCTION
Remote MGMT	WWW	Use this screen to configure through which interface(s) and from which IP address(es) users can use HTTP to manage the ZyXEL Device.
	Telnet	Use this screen to configure through which interface(s) and from which IP address(es) users can use Telnet to manage the ZyXEL Device.
	FTP	Use this screen to configure through which interface(s) and from which IP address(es) users can use FTP to access the ZyXEL Device.
	SNMP	Use this screen to configure through which interface and from which IP addresses(es) users can access the SNMP agent on the ZyXEL Device.
	DNS	Use this screen to configure through which interface(s) and from which IP address(es) users can send DNS queries to the ZyXEL Device.
	ICMP	Use this screen to set whether or not your device will respond to pings and probes for services that you have not made available.
UPnP	General	Use this screen to turn UPnP on or off.
CWMP		Use this screen to have a management server manage the ZyXEL Device.
Maintenance		
System	General	Use this screen to configure your device's password.
	Time and Date	Use this screen to change your ZyXEL Device's time and date.
Logs	System Log	Use this screen to select which logs your device is to record.
Tools	Firmware	Use this screen to upload firmware to your device.
	Configuration	Use this screen to backup and restore your device's configuration (settings) or reset the factory default settings.
	Restart	This screen allows you to reboot the ZyXEL Device without turning the power off.
Diagnostic	General	Use this screen to test the connections to other devices.
	DSL Line	This screen displays information to help you identify problems with the DSL connection.

2.2.3 Main Window

The main window displays information and configuration fields. It is discussed in the rest of this document.

Right after you log in, the **Status** screen is displayed. See [Chapter 3 on page 35](#) for more information about the **Status** screen.

2.2.4 Status Bar

Check the status bar when you click **Apply** or **OK** to verify that the configuration has been updated.

Status Screen

3.1 Overview

Use the **Status** screen to look at the current status of the device, system resources, and interfaces (LAN and WAN). The **Status** screen also provides information from DHCP and statistics from bandwidth management and traffic.

3.2 The Status Screen

Use this screen to view the status of the ZyXEL Device. Click **Status** to open this screen.

Figure 8 Status Screen

The screenshot displays the 'Status' screen of a ZyXEL device. It features a 'Refresh Interval' dropdown set to 'None' and an 'Apply' button. The screen is divided into three main sections: Device Information, System Status, and Interface Status.

Device Information:

- Host Name: [P-660N-T1A](#)
- Model Number: P-660N-T1A
- MAC address: 00:a0:c5:14:09:31
- ZyNOS Firmware Version: [3.40\(BY1.0\)b3](#)
- DSL Firmware Version: FwVer:3.12.8.140_TC3086, HwVer:T14F7_7.0
- WAN Information:
 - DSL Mode: PPPoE
 - IP Address: [0.0.0.0](#)
 - IP Subnet Mask: 0.0.0.0
 - Default Gateway: 0.0.0.0
 - VPI/VCI: 8/35
- LAN Information:
 - IP Address: [192.168.1.1](#)
 - IP Subnet Mask: 255.255.255.0
 - DHCP: [Server](#)
- WLAN Information:
 - ESSID: [RT3390_1](#)
 - Channel: Channel-6
 - Security: No Security
 - WPS: [Configured](#)
 - Status: ON
- Security:
 - Firewall: [Disabled](#)

System Status:

- System Uptime: 0:04:10
- Current Date/Time: 01/01/2000 00:06:21
- System Mode: [Routing / Bridging](#)
- CPU Usage: 5%
- Memory Usage: 22%

Interface Status:

Interface	Status	Rate
ADSL	Down	0 / 0
LAN	Up	100M/Full
WLAN	Active	150M

Each field is described in the following table.

Table 4 Status Screen

LABEL	DESCRIPTION
Refresh Interval	Select how often you want the ZyXEL Device to update this screen.
Apply	Click this to update this screen immediately.
Device Information	
Host Name	This field displays the ZyXEL Device system name. It is used for identification.
Model Number	This is the model name of your device.
MAC Address	This is the MAC (Media Access Control) or Ethernet address unique to your ZyXEL Device.
ZyNOS Firmware Version	This is the current version of the firmware inside the device. Click this to go to the screen where you can change it.
DSL Firmware Version	This is the current version of the device's DSL modem code.
WAN Information	
DSL Mode	This is the DSL standard that your ZyXEL Device is using.
IP Address	This is the current IP address of the ZyXEL Device in the WAN. Click this to go to the screen where you can change it.
IP Subnet Mask	This is the current subnet mask in the WAN.
Default Gateway	This is the IP address of the default gateway, if applicable.
VPI/VCI	This is the Virtual Path Identifier and Virtual Channel Identifier that you entered in the wizard or WAN screen.
LAN Information	
IP Address	This is the current IP address of the ZyXEL Device in the LAN. Click this to go to the screen where you can change it.
IP Subnet Mask	This is the current subnet mask in the LAN.
DHCP	<p>This field displays what DHCP services the ZyXEL Device is providing to the LAN. Choices are:</p> <p>Server - The ZyXEL Device is a DHCP server in the LAN. It assigns IP addresses to other computers in the LAN.</p> <p>Relay - The ZyXEL Device acts as a surrogate DHCP server and relays DHCP requests and responses between the remote server and the clients.</p> <p>None - The ZyXEL Device is not providing any DHCP services to the LAN.</p> <p>Click this to go to the screen where you can change it.</p>
WLAN Information	

Table 4 Status Screen

LABEL	DESCRIPTION
ESSID	This is the descriptive name used to identify the ZyXEL Device in a wireless LAN. Click this to go to the screen where you can change it.
Channel	This is the channel number used by the ZyXEL Device now.
Security	This displays the type of security mode the ZyXEL Device is using in the wireless LAN.
WPS	This displays whether WPS is activated. Click this to go to the screen where you can configure the settings.
Status	This displays whether WLAN is activated.
Security	
Firewall	This displays whether or not the ZyXEL Device's firewall is activated. Click this to go to the screen where you can change it.
System Status	
System Uptime	This field displays how long the ZyXEL Device has been running since it last started up. The ZyXEL Device starts up when you plug it in, when you restart it (Maintenance > Tools > Restart), or when you reset it.
Current Date/Time	This field displays the current date and time in the ZyXEL Device. You can change this in Maintenance > System > Time Setting .
System Mode	This displays whether the ZyXEL Device is functioning as a router or a bridge.
CPU Usage	This field displays what percentage of the ZyXEL Device's processing ability is currently used. When this percentage is close to 100%, the ZyXEL Device is running at full load, and the throughput is not going to improve anymore. If you want some applications to have more throughput, you should turn off other applications (for example, using QoS; see Chapter 14 on page 167).
Memory Usage	This field displays what percentage of the ZyXEL Device's memory is currently used. Usually, this percentage should not increase much. If memory usage does get close to 100%, the ZyXEL Device is probably becoming unstable, and you should restart the device. See Section 21.4 on page 221 , or turn off the device (unplug the power) for a few seconds.
Interface Status	
Interface	This column displays each interface the ZyXEL Device has.

Table 4 Status Screen

LABEL	DESCRIPTION
Status	<p>This field indicates whether or not the ZyXEL Device is using the interface.</p> <p>For the DSL interface, this field displays Down (line is down), Up (line is up or connected) if you're using Ethernet encapsulation and Down (line is down), Up (line is up or connected), Idle (line (ppp) idle), Dial (starting to trigger a call) and Drop (dropping a call) if you're using PPPoE encapsulation.</p> <p>For the LAN interface, this field displays Up when the ZyXEL Device is using the interface and Down when the ZyXEL Device is not using the interface.</p> <p>For the WLAN interface, it displays Active when WLAN is enabled or InActive when WLAN is disabled.</p>
Rate	<p>For the LAN interface, this displays the port speed and duplex setting.</p> <p>For the DSL interface, it displays the downstream and upstream transmission rate.</p> <p>For the WLAN interface, it displays the maximum transmission rate when WLAN is enabled or N/A when WLAN is disabled.</p>

Tutorials

4.1 Overview

This chapter shows you how to use the ZyXEL Device's various features.

- [Setting Up a Secure Wireless Network](#), see page 39
- [Configuring the MAC Address Filter](#), see page 46
- [Multiple WAN Connections Example](#), see page 48

4.2 Setting Up a Secure Wireless Network

Thomas wants to set up a wireless network so that he can use his notebook to access the Internet. In this wireless network, the ZyXEL Device serves as an access point (AP), and the notebook is the wireless client. The wireless client can access the Internet through the AP.



Thomas has to configure the wireless network settings on the ZyXEL Device. Then he can set up a wireless network using WPS ([Section 4.2.2 on page 41](#)) or manual configuration ([Section 4.2.3 on page 45](#)).

4.2.1 Configuring the Wireless Network Settings

This example uses the following parameters to set up a wireless network.

SSID	Example
Security Mode	WPA-PSK
Pre-Shared Key	1234567key7654321yek
802.11 Mode	802.11b+g+n

- 1 Click **Network > Wireless LAN** to open the **AP** screen. Configure the screen using the provided parameters (see [page 39](#)). Click **Apply**.

The screenshot shows the 'Wireless Setup' configuration page. The 'Common Setup' section is highlighted with a red box. The fields in this section are:

- Name(SSID): Example
- Hide SSID:
- Security Mode: WPA-PSK
- Pre-Shared Key: 1234567key7654321yek
- WPA Group Key Update Timer: 10 (In Seconds)
- MAC Filter: Allow Association
- QoS: Enable QoS

The 'Apply' button at the bottom is circled in red.

- 2 Click the **Advanced Setup** button and select **802.11b+g+n** in the **802.11 Mode** field. Click **Apply**.

The screenshot shows the 'Wireless Advanced Setup' configuration page. The '802.11 Mode' field is highlighted with a red box, showing the selection of '802.11b+g+n'. The fields in this section are:

- RTS/CTS Threshold: 2347 (1 ~ 2347)
- Fragmentation Threshold: 2346 (256 ~ 2346, even numbers only)
- Output Power: 100%
- Preamble: Long
- 802.11 Mode: 802.11b+g+n

The 'Apply' button at the bottom is circled in red.

Thomas can now use the WPS feature to establish a wireless connection between his notebook and the ZyXEL Device (see [Section 4.2.2 on page 41](#)). He can also use the notebook's wireless client to search for the ZyXEL Device (see [Section 4.2.3 on page 45](#)).

4.2.2 Using WPS

This section shows you how to set up a wireless network using WPS. It uses the ZyXEL Device as the AP and ZyXEL NWD210N as the wireless client which connects to the notebook.

Note: The wireless client must be a WPS-aware device (for example, a WPS USB adapter or PCMCIA card).

There are two WPS methods to set up the wireless client settings:

- **Push Button Configuration (PBC)** - simply press a button. This is the easier of the two methods.
- **PIN Configuration** - configure a Personal Identification Number (PIN) on the ZyXEL Device. A wireless client must also use the same PIN in order to download the wireless network settings from the ZyXEL Device.

Push Button Configuration (PBC)

- 1 Make sure that your ZyXEL Device is turned on and your notebook is within the cover range of the wireless signal.
- 2 Make sure that you have installed the wireless client driver and utility in your notebook.
- 3 In the wireless client utility, go to the WPS setting page. Enable WPS and press the WPS button (**Start** or **WPS** button).
- 4 Push and hold the **WPS** button located on the ZyXEL Device's rear panel for more than 5 seconds. Alternatively, you may log into ZyXEL Device's web configurator and click the **Push Button** in the **Network > Wireless LAN > WPS Station** screen.

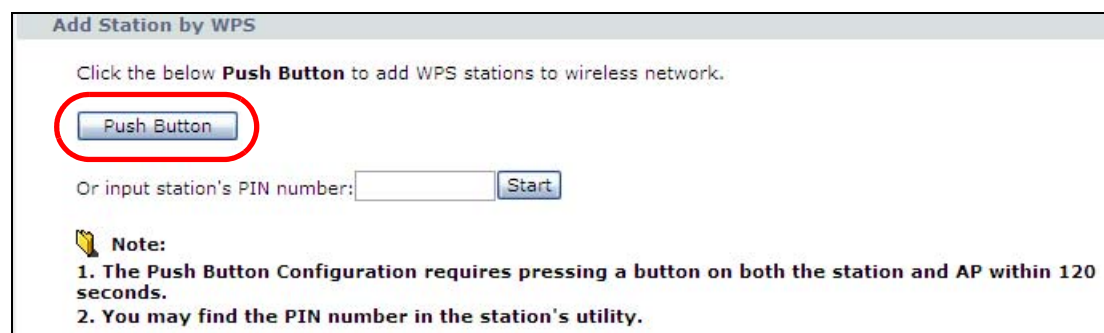

Note: Your ZyXEL Device has a WPS button located on its rear panel as well as a WPS button in its configuration utility. Both buttons have exactly the same function: you can use one or the other.

Note: It doesn't matter which button is pressed first. You must press the second button within two minutes of pressing the first one.

The ZyXEL Device sends the proper configuration settings to the wireless client. This may take up to two minutes. The wireless client is then able to communicate with the ZyXEL Device securely.

The following figure shows you an example of how to set up a wireless network and its security by pressing a button on both ZyXEL Device and wireless client.

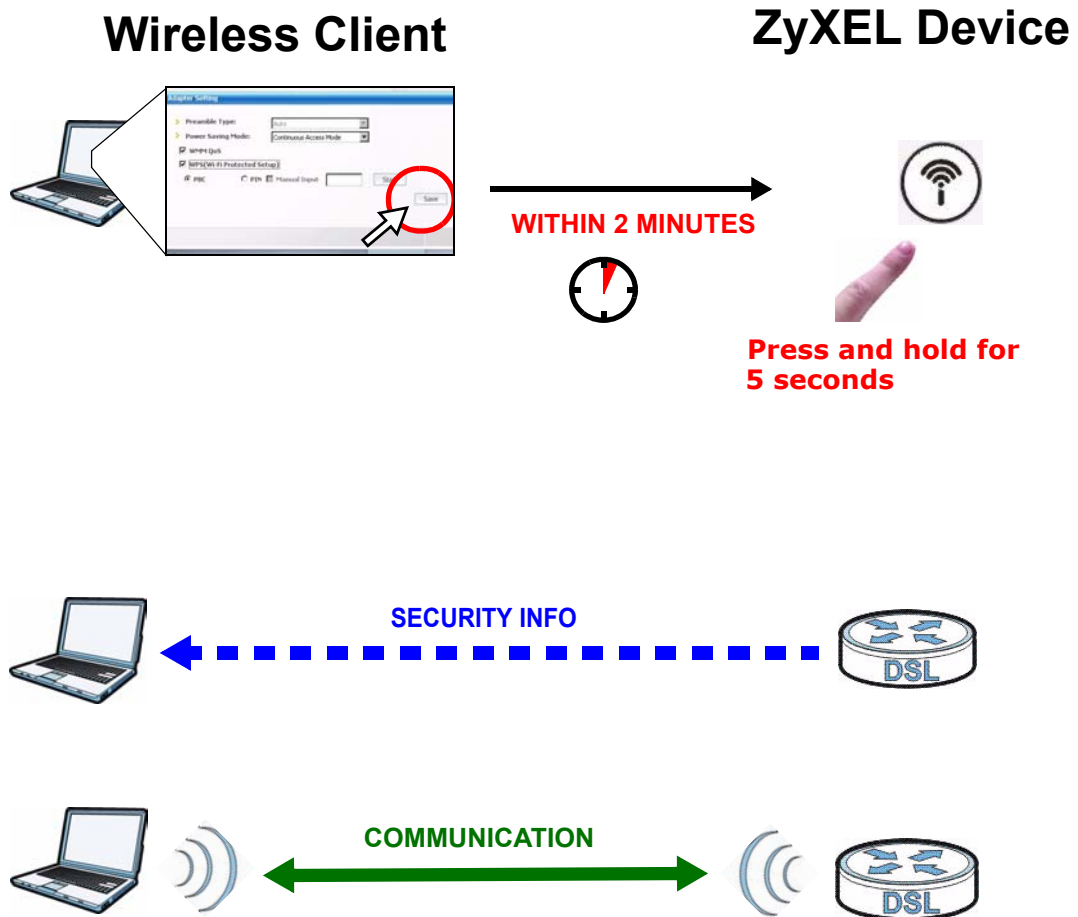

PIN Configuration

When you use the PIN configuration method, you need to use both the ZyXEL Device's web configurator and the wireless client's utility.

- 1 Launch your wireless client's configuration utility. Go to the WPS settings and select the PIN method to get a PIN number.
- 2 Enter the PIN number in the **PIN** field in the **Network > Wireless LAN > WPS Station** screen on the ZyXEL Device.

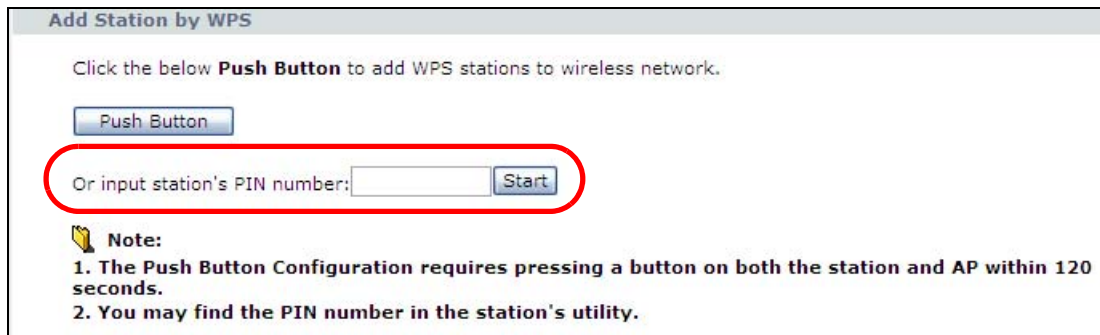

Add Station by WPS

Click the below **Push Button** to add WPS stations to wireless network.

Or input station's PIN number:

Note:

1. The **Push Button Configuration** requires pressing a button on both the station and AP within 120 seconds.
2. You may find the PIN number in the station's utility.

- 3 Click the **Start** buttons (or the button next to the PIN field) on both the wireless client utility screen and the ZyXEL Device's **WPS Station** screen within two minutes.

The ZyXEL Device authenticates the wireless client and sends the proper configuration settings to the wireless client. This may take up to two minutes. The wireless client is then able to communicate with the ZyXEL Device securely.

The following figure shows you how to set up a wireless network and its security on a ZyXEL Device and a wireless client by using PIN method.

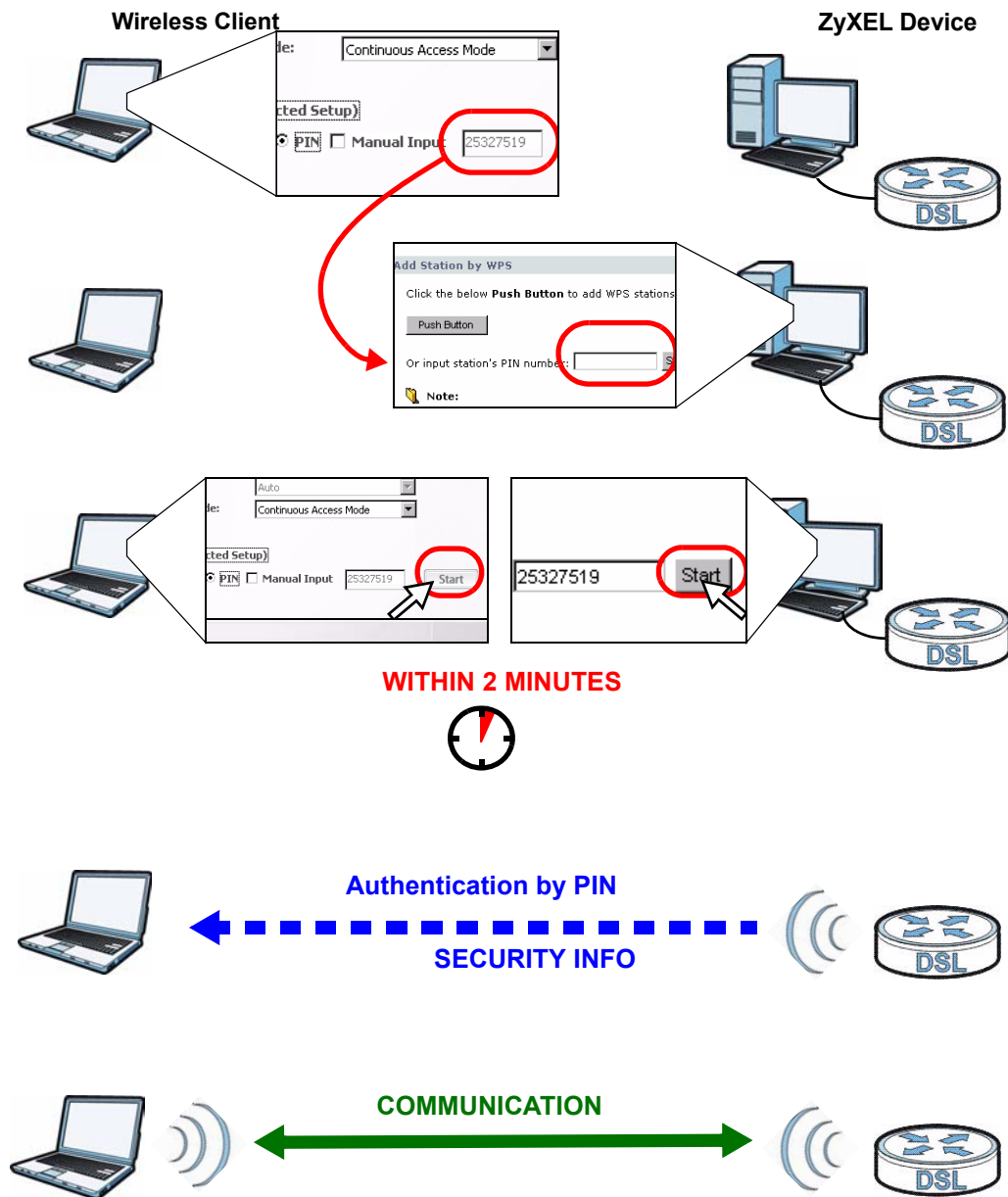

4.2.3 Without WPS

Use the wireless adapter's utility installed on the notebook to search for the "Example" SSID. Then enter the "DoNotStealMyWirelessNetwork" pre-shared key to establish an wireless Internet connection.

Note: The ZyXEL Device supports IEEE 802.11b and IEEE 802.11g wireless clients. Make sure that your notebook or computer's wireless adapter supports one of these standards.

4.2.4 Setting Up Wireless Network Scheduling

Thomas mostly uses his notebook to access the Internet on weekends; occasionally he uses it at night on weekdays. Here is how Thomas can set up a schedule to turn on the wireless network at specific time and days.

- 1 Click **Network > Wireless Network > Scheduling** to open the following screen.

Wireless LAN Scheduling

Enable Wireless LAN Scheduling

Action	Day	Except for the following times (24-Hour Format)
<input type="radio"/> On <input checked="" type="radio"/> Off	<input type="checkbox"/> Everyday	00 (hour) 00 (min) ~ 00 (hour) 00 (min)
<input type="radio"/> On <input checked="" type="radio"/> Off	<input type="checkbox"/> Monday	00 (hour) 00 (min) ~ 00 (hour) 00 (min)
<input type="radio"/> On <input checked="" type="radio"/> Off	<input type="checkbox"/> Tuesday	00 (hour) 00 (min) ~ 00 (hour) 00 (min)
<input type="radio"/> On <input checked="" type="radio"/> Off	<input type="checkbox"/> Wednesday	00 (hour) 00 (min) ~ 00 (hour) 00 (min)
<input type="radio"/> On <input checked="" type="radio"/> Off	<input type="checkbox"/> Thursday	00 (hour) 00 (min) ~ 00 (hour) 00 (min)
<input type="radio"/> On <input checked="" type="radio"/> Off	<input type="checkbox"/> Friday	00 (hour) 00 (min) ~ 00 (hour) 00 (min)
<input type="radio"/> On <input checked="" type="radio"/> Off	<input type="checkbox"/> Saturday	00 (hour) 00 (min) ~ 00 (hour) 00 (min)
<input type="radio"/> On <input checked="" type="radio"/> Off	<input type="checkbox"/> Sunday	00 (hour) 00 (min) ~ 00 (hour) 00 (min)

 **Note:** (Wireless signal is currently turned on/off by scheduling.)

- 2 Configure the screen as follows. Turn on the wireless network from Mondays to Fridays between 18:00 and 23:30. Turn on the wireless network all day on Saturdays and Sundays. Click **Apply**.

Wireless LAN Scheduling

Enable Wireless LAN Scheduling

WLAN status	Day	The following times (24-Hour Format)
<input type="radio"/> Off <input type="radio"/> On	<input type="checkbox"/> Everyday	00 (hour) 00 (min) ~ 00 (hour) 00 (min)
<input type="radio"/> Off <input checked="" type="radio"/> On	<input checked="" type="checkbox"/> Mon	18 (hour) 00 (min) ~ 23 (hour) 30 (min)
<input type="radio"/> Off <input checked="" type="radio"/> On	<input checked="" type="checkbox"/> Tue	18 (hour) 00 (min) ~ 23 (hour) 30 (min)
<input type="radio"/> Off <input checked="" type="radio"/> On	<input checked="" type="checkbox"/> Wed	18 (hour) 00 (min) ~ 23 (hour) 30 (min)
<input type="radio"/> Off <input checked="" type="radio"/> On	<input checked="" type="checkbox"/> Thu	18 (hour) 00 (min) ~ 23 (hour) 30 (min)
<input type="radio"/> Off <input checked="" type="radio"/> On	<input checked="" type="checkbox"/> Fri	18 (hour) 00 (min) ~ 23 (hour) 30 (min)
<input type="radio"/> Off <input checked="" type="radio"/> On	<input checked="" type="checkbox"/> Sat	00 (hour) 00 (min) ~ 00 (hour) 00 (min)
<input type="radio"/> Off <input checked="" type="radio"/> On	<input checked="" type="checkbox"/> Sun	00 (hour) 00 (min) ~ 00 (hour) 00 (min)

Note: Specify the same begin time and end time means the whole day schedule.

4.3 Configuring the MAC Address Filter

Thomas noticed that his daughter Josephine spends too much time surfing the web and downloading media files. He decided to prevent Josephine from accessing the Internet so that she can concentrate on preparing for her final exams.

Josephine's computer connects wirelessly to the Internet through the ZyXEL Device. Thomas can deny access to the wireless network using the MAC address of Josephine's computer.

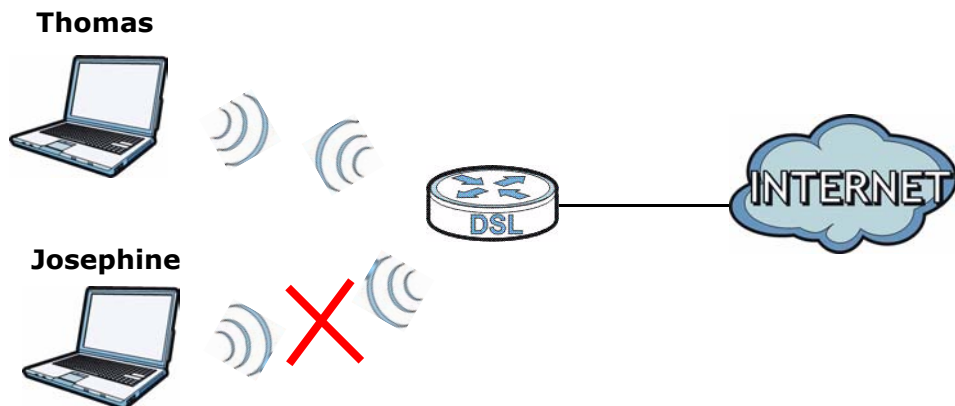

- 1 Click **Network** > **LAN** > **Client List** to open the following screen. Look for the MAC address of Josephine's computer.

DHCP Client Table

IP Address: MAC Address:

#	Status	Host Name	IP Address	MAC Address	Reserve	Modify
1		twpc13477	192.168.1.33	00:0F:FE:32:B4:12	<input type="checkbox"/>	
2		Josephine-PC	192.168.1.34	00:1E:52:C3:5C:1B	<input type="checkbox"/>	

.....

- 2 Click **Network** > **Wireless LAN** to open the **AP** screen. Click the **Edit** button in the **MAC Filter** field.

AP More AP WPS WPS Station WDS Scheduling

Wireless Setup

Enable Wireless LAN

Channel Selection Channel06 2437MHz Current Channel:

Common Setup

Name(SSID)

Hide SSID

Security Mode WPA-PSK

Pre-Shared Key

WPA Group Key Update Timer 10 (In Seconds)

MAC Filter Allow Association

QoS Enable QoS

.....

- 3 Select **Active MAC Filter** and **Deny Filter Action**. Enter the MAC address you found in the **Client List** screen. Click **Apply**.

MAC Filter

Active MAC Filter

Filter Action Allow Deny

Set	MAC Address	Set	MAC Address
1	00:1E:52:C3:5C:1E	2	00:00:00:00:00:00
3	00:00:00:00:00:00	4	00:00:00:00:00:00
5	00:00:00:00:00:00	6	00:00:00:00:00:00
7	00:00:00:00:00:00	8	00:00:00:00:00:00
9	00:00:00:00:00:00	10	00:00:00:00:00:00
29	00:00:00:00:00:00	30	00:00:00:00:00:00
31	00:00:00:00:00:00	32	00:00:00:00:00:00

Back Apply Cancel

Josephine will no longer be able to access the Internet through the ZyXEL Device.

4.4 Multiple WAN Connections Example

This example shows an application for multiple WAN connections.

Your ISP may configure more than one WAN connection on the ZyXEL Device to record traffic statistics or calculate service charges.









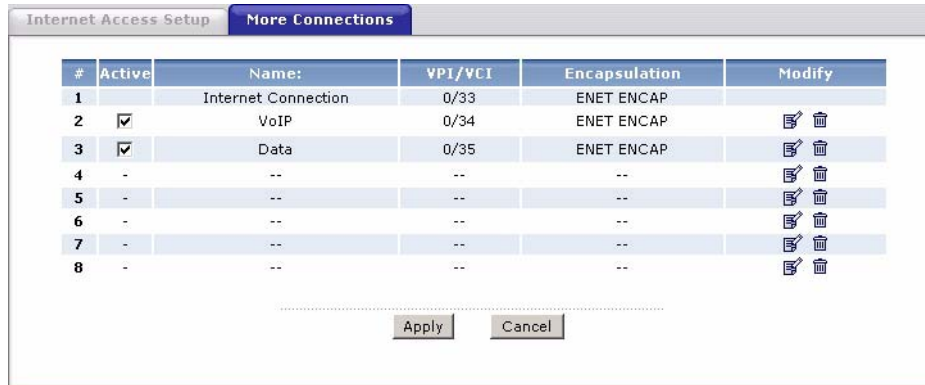





In [Figure 9](#), three WAN connections are configured over the ADSL line:

- The connection with VPI/VCI, **0/33**, is dedicated for Media-On-Demand (MOD) service.
- The connection with VPI/VCI, **0/34**, is dedicated for VoIP service.

- The connection with VPI/VCI, **0/35**, is dedicated for general data transmission.

Figure 9 Example for Multiple WAN Connections



#	Active	Name:	VPI/VCI	Encapsulation	Modify
1		Internet Connection	0/33	ENET ENCAP	
2	<input checked="" type="checkbox"/>	VoIP	0/34	ENET ENCAP	 
3	<input checked="" type="checkbox"/>	Data	0/35	ENET ENCAP	 
4	-	--	--	--	 
5	-	--	--	--	 
6	-	--	--	--	 
7	-	--	--	--	 
8	-	--	--	--	 

PART II

Technical Reference

Internet and Wireless Setup Wizard

5.1 Overview

Use the wizard setup screens to configure your system for Internet access with the information given to you by your ISP.

Note: See the advanced menu chapters for background information on these fields.

5.2 Internet Access Wizard Setup

- 1 After you enter the password to access the web configurator, select **Go to Wizard setup** and click **Apply**. Otherwise, click the wizard icon in the top right corner of the web configurator to go to the wizards.

Figure 10 Select a Mode

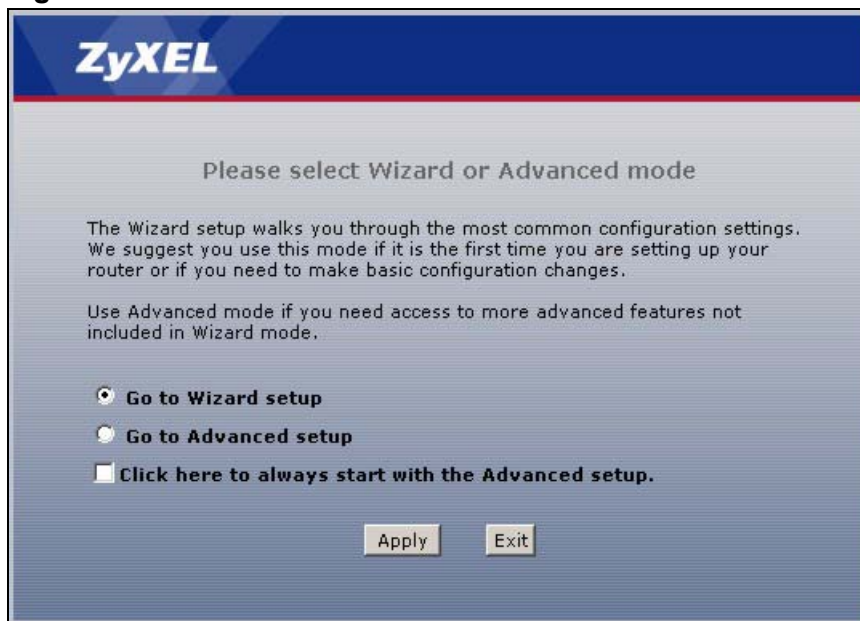

- 2 Click **INTERNET/WIRELESS SETUP** to configure the system for Internet access and wireless connection.

Figure 11 Wizard Welcome

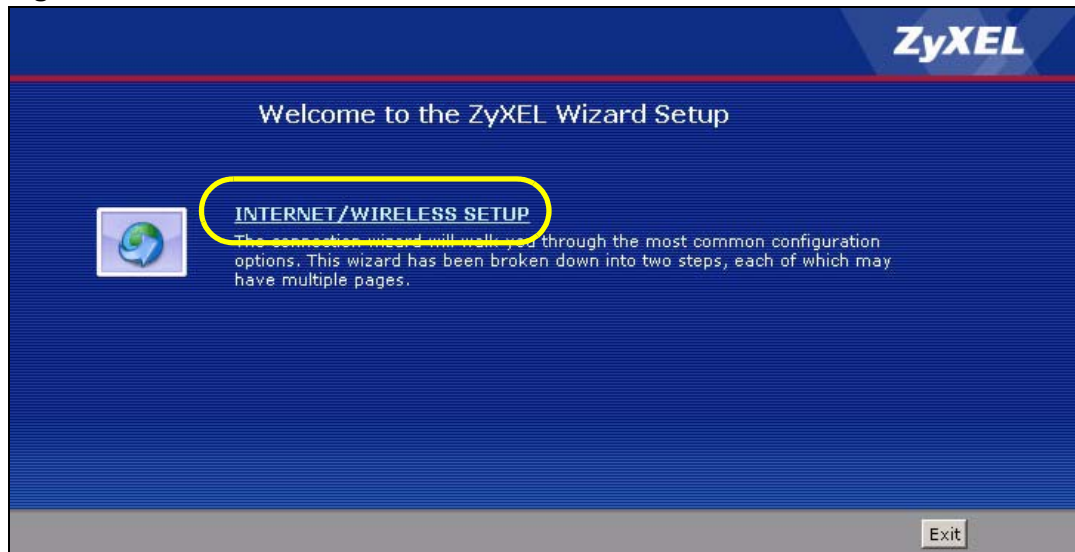

- 3 Your ZyXEL device attempts to detect your DSL connection and your connection type.
 - 3a The following screen appears if a connection is not detected. Check your hardware connections and click **Restart the INTERNET/WIRELESS SETUP Wizard** to return to the wizard welcome screen. If you still cannot connect, click **Manually configure your Internet connection**. Follow the directions in the wizard and enter your Internet setup information as provided to you by your ISP. See [Section 5.2.1 on page 56](#) for more details. If you would like to skip your Internet setup and configure the wireless LAN settings, leave **Yes** selected and click **Next**.

Figure 12 Auto Detection: No DSL Connection



- 3b** The following screen displays if a PPPoE or PPPoA connection is detected. Enter your Internet account information (username, password and/or service name) exactly as provided by your ISP. Then click **Next** and see [Section 5.3 on page 62](#) for wireless connection wizard setup.

Figure 13 Auto-Detection: PPPoE

The screenshot shows the 'Internet Configuration' wizard at Step 1. The 'Auto-Detected ISP' section indicates the 'Connection Type' is 'PPP over Ethernet (PPPoE)'. Below this, the 'ISP Parameters for Internet Access' section provides instructions: 'Please enter the User Name and Password given to you by your Internet Service Provider here. If your ISP gave you a Service Name, enter it in the third field'. There are three input fields: 'User Name', 'Password', and 'Service Name (optional)'. At the bottom, there are three buttons: '< Back', 'Next >', and 'Exit'.

- 3c** The following screen appears if the ZyXEL device detects a connection but not the connection type. Click **Next** and refer to [Section 5.2.1 on page 56](#) on how to manually configure the ZyXEL Device for Internet access.

Figure 14 Auto Detection: Failed

The screenshot shows the 'Internet Configuration' wizard at Step 1. The 'Auto-Detected ISP' section displays a message: 'Detection Failed. Please make sure the DSL cable is connected. Click the 'Next' button below to manually configure your Internet connection'. Below this is a 'Note' section with a yellow icon: 'This wizard can only automatically detect PPP over Ethernet (PPPoE), PPP over ATM (PPPoA), or dynamically assigned Ethernet Internet connections. Your Internet connection may use a Static IP address which cannot be detected automatically.' At the bottom, there are three buttons: '< Back', 'Next >', and 'Exit'.

5.2.1 Manual Configuration

- 1 If the ZyXEL Device fails to detect your DSL connection type but the physical line is connected, enter your Internet access information in the wizard screen exactly as your service provider gave it to you. Leave the defaults in any fields for which you were not given information.

Figure 15 Internet Access Wizard Setup: ISP Parameters

The following table describes the fields in this screen.

Table 5 Internet Access Wizard Setup: ISP Parameters

LABEL	DESCRIPTION
Mode	Select Routing (default) from the drop-down list box if your ISP give you one IP address only and you want multiple computers to share an Internet account. Select Bridge when your ISP provides you more than one IP address and you want the connected computers to get individual IP address from ISP's DHCP server directly. If you select Bridge , you cannot use Firewall, DHCP server and NAT on the ZyXEL Device.
Encapsulation	Select the encapsulation type your ISP uses from the Encapsulation drop-down list box. Choices vary depending on what you select in the Mode field. If you select Bridge in the Mode field, select either PPPoA or RFC 1483 . If you select Routing in the Mode field, select PPPoA , RFC 1483 , ENET ENCAP or PPPoE .

Table 5 Internet Access Wizard Setup: ISP Parameters

LABEL	DESCRIPTION
Multiplexing	Select the multiplexing method used by your ISP from the Multiplex drop-down list box either VC-based or LLC-based.
Virtual Circuit ID	VPI (Virtual Path Identifier) and VCI (Virtual Channel Identifier) define a virtual circuit. Refer to the appendix for more information.
VPI	Enter the VPI assigned to you. This field may already be configured.
VCI	Enter the VCI assigned to you. This field may already be configured.
Back	Click this to return to the previous screen without saving.
Next	Click this to continue to the next wizard screen. The next wizard screen you see depends on what protocol you chose above.
Exit	Click this to close the wizard screen without saving.

- 2 The next wizard screen varies depending on what mode and encapsulation type you use. All screens shown are with routing mode. Configure the fields and click **Next** to continue. See [Section 5.3 on page 62](#) for wireless connection wizard setup

Figure 16 Internet Connection with PPPoE

STEP 1 | STEP 2

Internet Configuration

ISP Parameters for Internet Access
Please enter the User Name and Password given to you by your Internet Service Provider here. If your ISP gave you a Service Name, enter it in the third field

User Name

Password

Service Name (optional)

Note:
Device is automatically configured to obtain an IP address automatically. The ISP will assign you a different one each time you connect to the Internet.

< Back Apply Exit

The following table describes the fields in this screen.

Table 6 Internet Connection with PPPoE

LABEL	DESCRIPTION
User Name	Enter the user name exactly as your ISP assigned. If assigned a name in the form user@domain where domain identifies a service name, then enter both components exactly as given.
Password	Enter the password associated with the user name above.
Service Name	Type the name of your PPPoE service here.
Back	Click this to return to the previous screen without saving.
Apply	Click this to save your changes.
Exit	Click this to close the wizard screen without saving.

Figure 17 Internet Connection with RFC 1483

STEP 1 > STEP 2

Internet Configuration

ISP Parameters for Internet Access

IP Address

< Back Next > Exit

The following table describes the fields in this screen.

Table 7 Internet Connection with RFC 1483

LABEL	DESCRIPTION
IP Address	This field is available if you select Routing in the Mode field. Type your ISP assigned IP address in this field.
Back	Click this to return to the previous screen without saving.
Next	Click this to continue to the next wizard screen.
Exit	Click this to close the wizard screen without saving.

Figure 18 Internet Connection with ENET ENCAP

STEP 1 ▶ STEP 2

Internet Configuration

ISP Parameters for Internet Access

Select 'Obtain an IP Address Automatically' if your ISP assigns you a dynamic IP address (DHCP); otherwise select 'Static IP Address' and type the static IP information your ISP gave you.

Obtain an IP Address Automatically
 Static IP Address

IP Address: 0.0.0.0
 Subnet Mask: 0.0.0.0
 Gateway IP address: 0.0.0.0
 First DNS Server: 0.0.0.0
 Second DNS Server: 0.0.0.0

<Back Apply Exit

The following table describes the fields in this screen.

Table 8 Internet Connection with ENET ENCAP

LABEL	DESCRIPTION
Obtain an IP Address Automatically	A static IP address is a fixed IP that your ISP gives you. A dynamic IP address is not fixed; the ISP assigns you a different one each time you connect to the Internet. Select Obtain an IP Address Automatically if you have a dynamic IP address.
Static IP Address	Select Static IP Address if your ISP gave you an IP address to use.
IP Address	Enter your ISP assigned IP address.
Subnet Mask	Enter a subnet mask in dotted decimal notation. Refer to the appendix to calculate a subnet mask If you are implementing subnetting.
Gateway IP address	You must specify a gateway IP address (supplied by your ISP) when you use ENET ENCAP in the Encapsulation field in the previous screen.
First DNS Server	Enter the IP addresses of the DNS servers. The DNS servers are passed to the DHCP clients along with the IP address and the subnet mask.
Second DNS Server	As above.
Back	Click this to return to the previous screen without saving.
Apply	Click this to save your changes.
Exit	Click this to close the wizard screen without saving.

Figure 19 Internet Connection with PPPoA

STEP 1 | STEP 2

Internet Configuration

ISP Parameters for Internet Access
Please enter the User Name and Password given to you by your Internet Service Provider here

User Name

Password

Note:
Device is automatically configured to obtain an IP address automatically. The ISP will assigns you a different one each time you connect to the Internet.

< Back Apply Exit

The following table describes the fields in this screen.

Table 9 Internet Connection with PPPoA

LABEL	DESCRIPTION
User Name	Enter the login name that your ISP gives you.
Password	Enter the password associated with the user name above.
Back	Click this to return to the previous screen without saving.
Apply	Click this to save your changes.
Exit	Click this to close the wizard screen without saving.

- If the user name and/or password you entered for PPPoE or PPPoA connection are not correct, the screen displays as shown next. Click **Back to Username and Password setup** to go back to the screen where you can modify them.

Figure 20 Connection Test Failed-1



- If the following screen displays, check if your account is activated or click **Restart the Internet/Wireless Setup Wizard** to verify your Internet access settings.

Figure 21 Connection Test Failed-2.

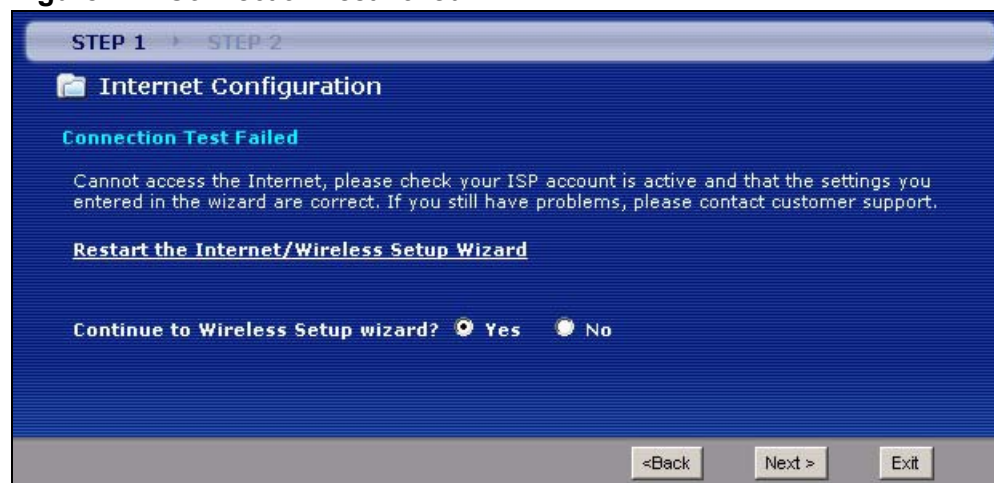

5.3 Wireless Connection Wizard Setup

After you configure the Internet access information, use the following screens to set up your wireless LAN.

- 1 Select **Yes** and click **Next** to configure wireless settings. Otherwise, select **No** and skip to Step 6.

Figure 22 Connection Test Successful

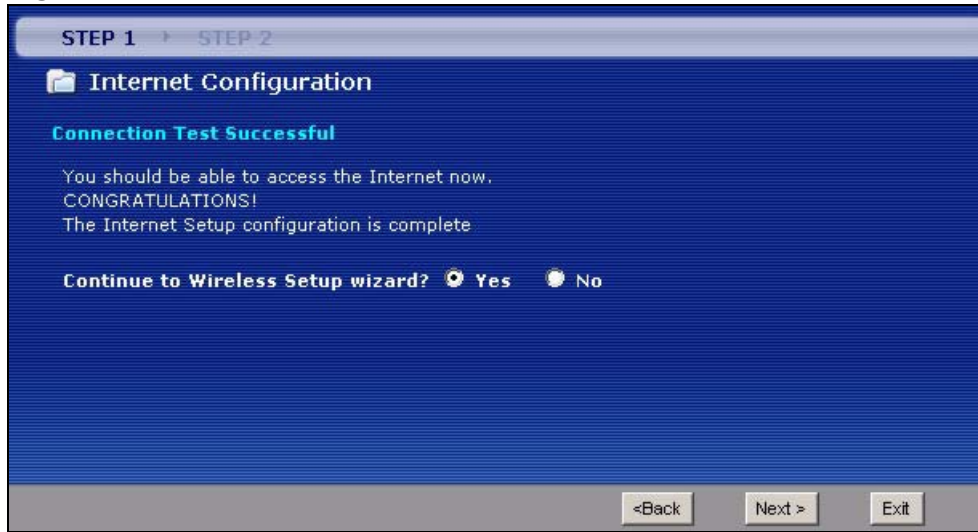

- 2 Use this screen to activate the wireless LAN. Click **Next** to continue.

Figure 23 Wireless LAN Setup Wizard 1

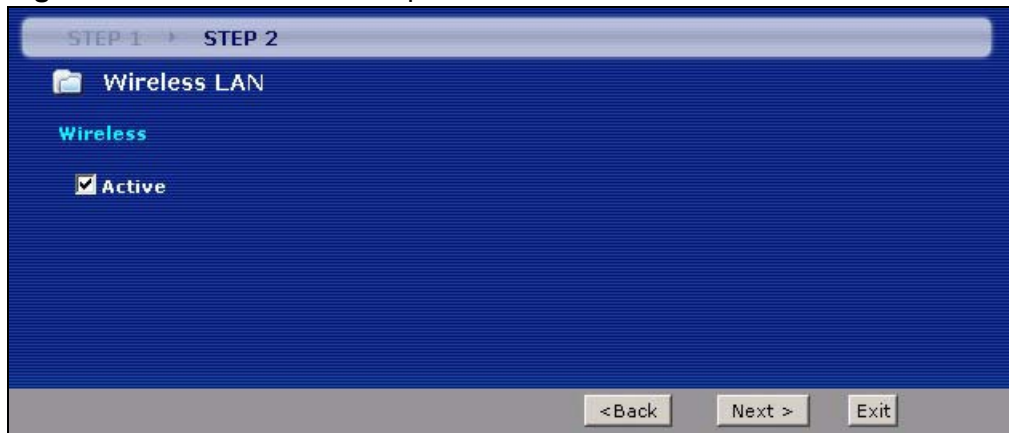

The following table describes the labels in this screen.

Table 10 Wireless LAN Setup Wizard 1

LABEL	DESCRIPTION
Active	Select the check box to turn on the wireless LAN.
Back	Click this to return to the previous screen without saving.

Table 10 Wireless LAN Setup Wizard 1

LABEL	DESCRIPTION
Next	Click this to continue to the next wizard screen.
Exit	Click this to close the wizard screen without saving.

- 3 Configure your wireless settings in this screen. Click **Next**.

Figure 24 Wireless LAN

The screenshot shows the 'Wireless LAN' configuration screen, labeled 'STEP 2'. It features a blue background with white text. At the top, there are navigation tabs for 'STEP 1' and 'STEP 2'. Below the title, there are three main sections: 'Network Name(SSID)' with a text input field containing 'ZyXEL01', 'Channel Selection' with a dropdown menu showing 'Channel-06 2437MHz', and 'Security' with a dropdown menu showing 'Manually assign a WPA-PSK key'. Each section includes a brief explanatory text. At the bottom of the screen, there are three buttons: '< Back', 'Next >', and 'Exit'.

The following table describes the labels in this screen.

Table 11 Wireless LAN Setup Wizard 2

LABEL	DESCRIPTION
Network Name(SSID)	Enter a descriptive name (up to 32 printable 7-bit ASCII characters) for the wireless LAN. If you change this field on the ZyXEL Device, make sure all wireless stations use the same SSID in order to access the network.
Channel Selection	The range of radio frequencies used by IEEE 802.11b/g wireless devices is called a channel. Select a channel ID that is not already in use by a neighboring device.
Security	Select Manually assign a WPA-PSK key to configure a Pre-Shared Key (WPA-PSK). Choose this option only if your wireless clients support WPA. See Section 5.3.1 on page 64 for more information. Select Manually assign a WEP key to configure a WEP Key. See Section 5.3.2 on page 65 for more information. Select Disable wireless security to have no wireless LAN security configured and your network is accessible to any wireless networking device that is within range.
Back	Click this to return to the previous screen without saving.

Table 11 Wireless LAN Setup Wizard 2

LABEL	DESCRIPTION
Next	Click this to continue to the next wizard screen.
Exit	Click this to close the wizard screen without saving.

Note: The wireless stations and ZyXEL Device must use the same SSID, channel ID and WEP encryption key (if WEP is enabled), WPA-PSK (if WPA-PSK is enabled) for wireless communication.

- This screen varies depending on the security mode you selected in the previous screen. Fill in the field (if available) and click **Next**.

5.3.1 Manually Assign a WPA-PSK key

Choose **Manually assign a WPA-PSK key** in the Wireless LAN setup screen to set up a **Pre-Shared Key**.

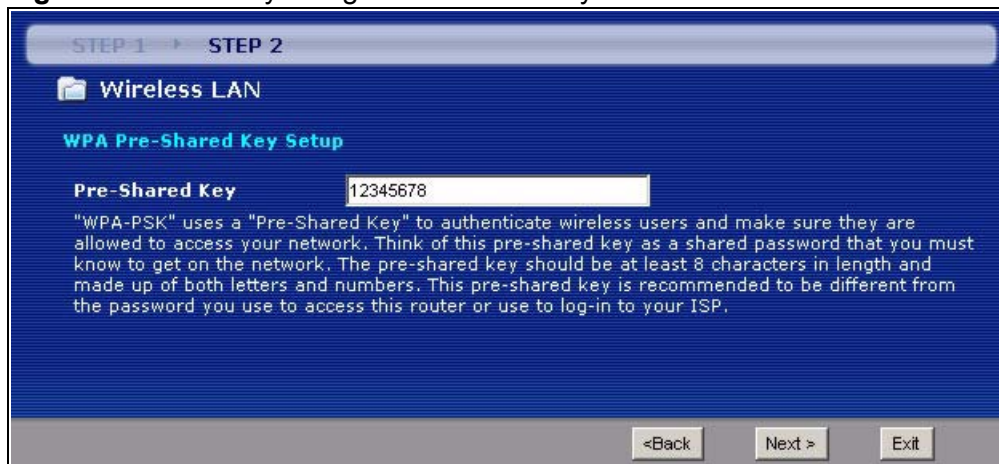
Figure 25 Manually Assign a WPA-PSK key

The following table describes the labels in this screen.

Table 12 Manually Assign a WPA-PSK key

LABEL	DESCRIPTION
Pre-Shared Key	Type from 8 to 63 case-sensitive ASCII characters. You can set up the most secure wireless connection by configuring WPA in the wireless LAN screens. You need to configure an authentication server to do this.
Back	Click this to return to the previous screen without saving.
Next	Click this to continue to the next wizard screen.
Exit	Click this to close the wizard screen without saving.

5.3.2 Manually Assign a WEP Key

Choose **Manually assign a WEP key** to setup WEP Encryption parameters.

Figure 26 Manually Assign a WEP key

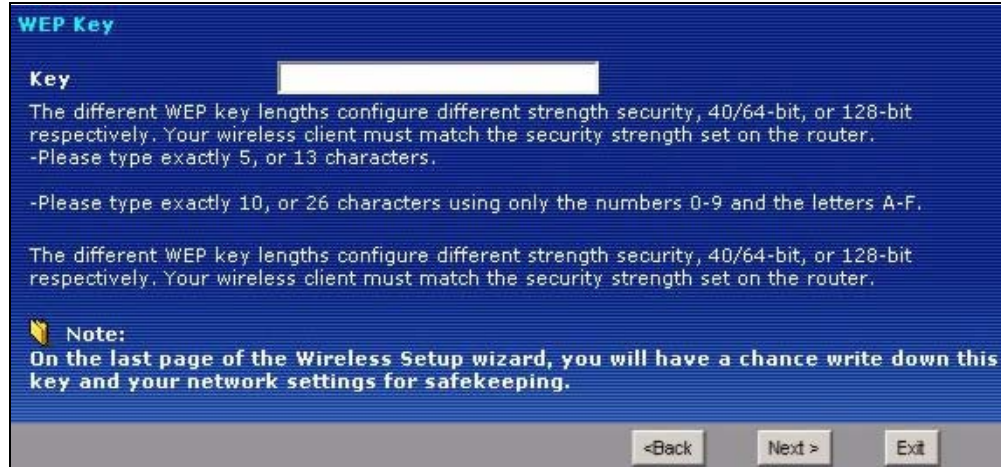

The following table describes the labels in this screen.

Table 13 Manually Assign a WEP key

LABEL	DESCRIPTION
Key	The WEP keys are used to encrypt data. Both the ZyXEL Device and the wireless stations must use the same WEP key for data transmission. Enter any 5 or 13 ASCII characters, or 10 or 26 hexadecimal characters ("0-9", "A-F") for a 64-bit or 128-bit WEP key respectively.
Back	Click this to return to the previous screen without saving.
Next	Click this to continue to the next wizard screen.
Exit	Click this to close the wizard screen without saving.

- 5 Click **Apply** to save your wireless LAN settings.

Figure 27 Wireless LAN Setup 3

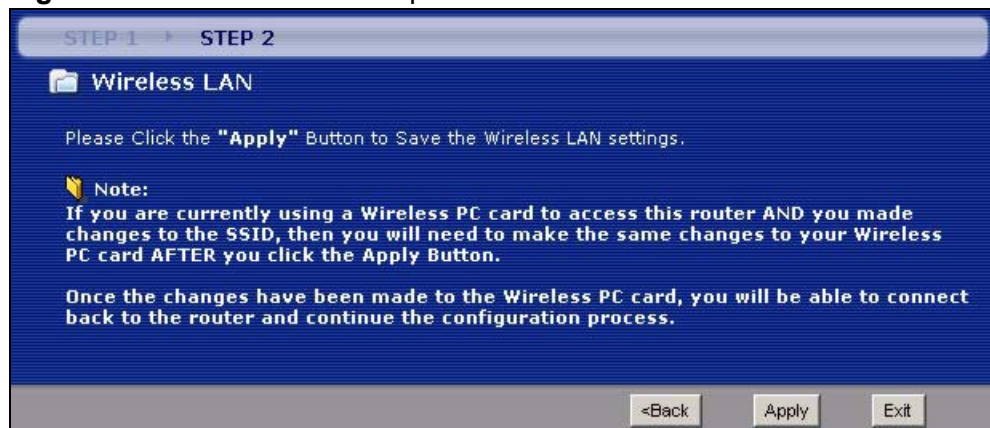

- 6 Use the read-only summary table to check whether what you have configured is correct. Click **Finish** to complete and save the wizard setup.

Note: No wireless LAN settings display if you chose not to configure wireless LAN settings.

Figure 28 Internet Access and WLAN Wizard Setup Complete

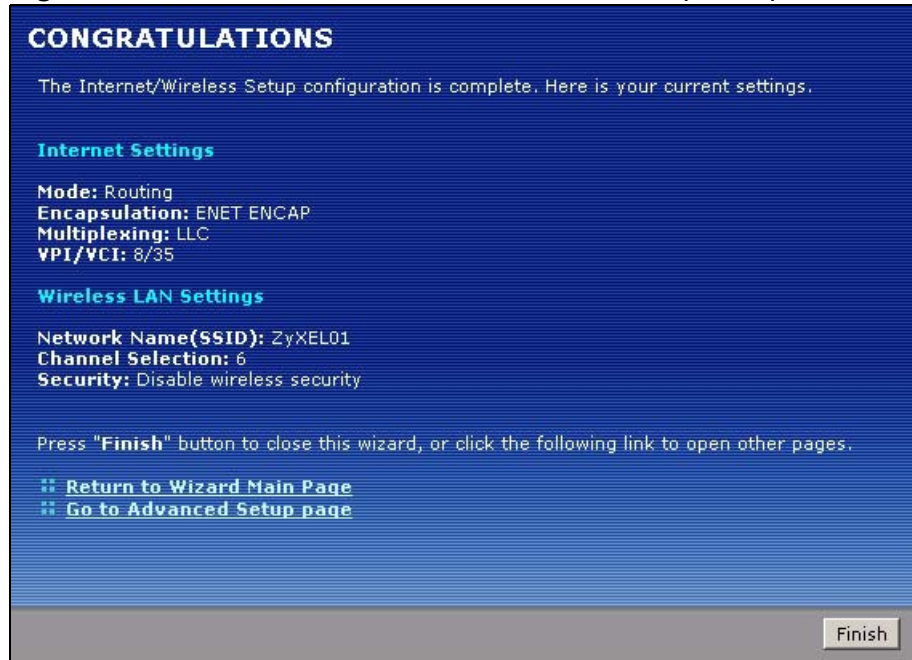

- 7 Launch your web browser and navigate to www.zyxel.com. Internet access is just the beginning. Refer to the rest of this guide for more detailed information on the complete range of ZyXEL Device features. If you cannot access the Internet, open the web configurator again to confirm that the Internet settings you configured in the wizard setup are correct.

WAN Setup

6.1 Overview

This chapter describes how to configure WAN settings from the **WAN** screens. Use these screens to configure your ZyXEL Device for Internet access.

A WAN (Wide Area Network) connection is an outside connection to another network or the Internet. It connects your private networks (such as a LAN (Local Area Network) and other networks, so that a computer in one location can communicate with computers in other locations.

Figure 29 LAN and WAN

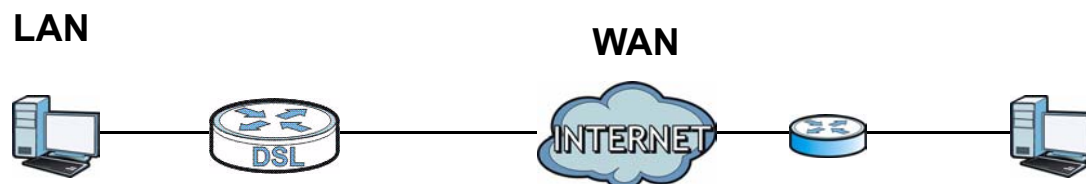

6.1.1 What You Can Do in the WAN Screens

- Use the **Internet Connection** screen ([Section 6.2 on page 69](#)) to configure the WAN settings on the ZyXEL Device for Internet access.
- Use the **More Connections** screen ([Section 6.3 on page 74](#)) to set up additional Internet access connections.

6.1.2 What You Need to Know

The following terms and concepts may help as you this chapter.

Encapsulation Method

Encapsulation is used to include data from an upper layer protocol into a lower layer protocol. To set up a WAN connection to the Internet, you need to use the same encapsulation method used by your ISP (Internet Service Provider). If your ISP offers a dial-up Internet connection using PPPoE (PPP over Ethernet) or PPPoA,

they should also provide a username and password (and service name) for user authentication.

WAN IP Address

The WAN IP address is an IP address for the ZyXEL Device, which makes it accessible from an outside network. It is used by the ZyXEL Device to communicate with other devices in other networks. It can be static (fixed) or dynamically assigned by the ISP each time the ZyXEL Device tries to access the Internet.

If your ISP assigns you a static WAN IP address, they should also assign you the subnet mask and DNS server IP address(es) (and a gateway IP address if you use the Ethernet or ENET ENCAP encapsulation method).

Multicast

Traditionally, IP packets are transmitted in one of either two ways - Unicast (1 sender - 1 recipient) or Broadcast (1 sender - everybody on the network). Multicast delivers IP packets to a group of hosts on the network - not everybody and not just one.

IGMP

IGMP (Internet Group Multicast Protocol) is a network-layer protocol used to establish membership in a Multicast group - it is not used to carry user data. There are three versions of IGMP. IGMP version 2 and 3 are improvements over version 1, but IGMP version 1 is still in wide use.

Finding Out More

See [Section 6.4 on page 78](#) for technical background information on WAN.

6.1.3 Before You Begin

You need to know your Internet access settings such as encapsulation and WAN IP address. Get this information from your ISP.

6.2 The Internet Connection Screen

Use this screen to change your ZyXEL Device's WAN settings. Click **Network > WAN > Internet Connection**. The screen differs by the WAN type and encapsulation you select.

Figure 30 Network > WAN > Internet Connection (PPPoE)

Internet Connection		More Connections	
Line			
ADSL Mode	Auto Sync-Up ▾		
Annex Type	ANNEX A/L ▾		
General			
Mode	Routing ▾		
Encapsulation	PPPoE ▾		
User Name	test		
Password	••••		
Service Name			
Multiplex	LLC ▾		
Virtual Circuit ID			
VPI	8		
VCI	35		
IP address			
<input checked="" type="radio"/> Obtain an IP Address Automatically			
<input type="radio"/> Static IP Address			
IP Address	0.0.0.0		
Subnet Mask	0.0.0.0		
ENET ENCAP Gateway	0.0.0.0		
Connection			
<input checked="" type="radio"/> Keep Alive			
<input type="radio"/> Connect on Demand			
	Max Idle Time	0	Sec
Apply		Cancel	
Advanced Setup			

The following table describes the labels in this screen.

Table 14 Network > WAN > Internet Connection

LABEL	DESCRIPTION
Line	
ADSL Mode	Select the mode supported by your ISP. Use Auto Sync-Up if you are not sure which mode to choose from. The ZyXEL Device dynamically diagnoses the mode supported by the ISP and selects the best compatible one for your connection. Other options are ADSL2+ , ADSL2 , G.DMT , T1.413 and G.lite .
ADSL Type	Select the type supported by your ISP. Available options are ANNEX A , ANNEX A/L , ANNEX M and ANNEX A/L/M .
General	
Mode	Select Routing (default) from the drop-down list box if your ISP gives you one IP address only and you want multiple computers to share an Internet account. Select Bridge when your ISP provides you more than one IP address and you want the connected computers to get individual IP address from ISP's DHCP server directly. If you select Bridge , you cannot use Firewall, DHCP server and NAT on the ZyXEL Device.
Encapsulation	Select the method of encapsulation used by your ISP from the drop-down list box. Choices vary depending on the mode you select in the Mode field. If you select Bridge in the Mode field, select either PPPoA or RFC 1483 . If you select Routing in the Mode field, select PPPoA , RFC 1483 , ENET ENCAP or PPPoE .
User Name	(PPPoA and PPPoE encapsulation only) Enter the user name exactly as your ISP assigned. If assigned a name in the form user@domain where domain identifies a service name, then enter both components exactly as given.
Password	(PPPoA and PPPoE encapsulation only) Enter the password associated with the user name above.
Service Name	(PPPoE only) Type the name of your PPPoE service here.
Multiplexing	Select the method of multiplexing used by your ISP from the drop-down list. Choices are VC or LLC . This field is not available if you set the WAN type to Ethernet .
Virtual Circuit ID	VPI (Virtual Path Identifier) and VCI (Virtual Channel Identifier) define a virtual circuit. Refer to the appendix for more information. These fields are not available if you set the WAN type to Ethernet .
VPI	The valid range for the VPI is 0 to 255. Enter the VPI assigned to you.
VCI	The valid range for the VCI is 32 to 65535 (0 to 31 is reserved for local management of ATM traffic). Enter the VCI assigned to you.

Table 14 Network > WAN > Internet Connection (continued)

LABEL	DESCRIPTION
IP Address	<p>This option is available if you select Routing in the Mode field.</p> <p>A static IP address is a fixed IP that your ISP gives you. A dynamic IP address is not fixed; the ISP assigns you a different one each time you connect to the Internet.</p> <p>Select Obtain an IP Address Automatically if you have a dynamic IP address; otherwise select Static IP Address and type your ISP assigned IP address in the IP Address field below.</p>
Subnet Mask	<p>This option is available if you select ENET ENCAP in the Encapsulation field.</p> <p>Enter a subnet mask in dotted decimal notation.</p>
ENET ENCAP Gateway	<p>This option is available if you select ENET ENCAP in the Encapsulation field.</p> <p>Specify a gateway IP address (supplied by your ISP).</p>
Connection (PPPoA and PPPoE encapsulation only)	
Keep Alive	<p>Select Keep Alive when you want your connection up all the time. The ZyXEL Device will try to bring up the connection automatically if it is disconnected.</p>
Connect on Demand	<p>Select Connect on Demand when you don't want the connection up all the time and specify an idle time-out in the Max Idle Timeout field.</p>
Max Idle Timeout	<p>Specify an idle time-out in the Max Idle Timeout field when you select Connect on Demand. The default setting is 0, which means the Internet session will not timeout.</p>
Apply	<p>Click this to save your changes.</p>
Cancel	<p>Click this to restore your previously saved settings.</p>
Advanced Setup	<p>Click this to display the Advanced WAN Setup screen and edit more details of your WAN setup.</p>

6.2.1 Advanced Setup

Use this screen to edit your ZyXEL Device's advanced WAN settings. Click the **Advanced Setup** button in the **Internet Connection** screen. The screen appears as shown.

Figure 31 Network > WAN > Internet Connection: Advanced Setup

The screenshot shows the 'Advanced Setup' configuration page. It features three main sections with a light blue header: 'RIP & Multicast Setup', 'ATM QoS', and 'MTU'. Each section contains several configuration fields with labels and input controls (dropdown menus or text boxes). At the bottom of the page, there are three buttons: 'Back', 'Apply', and 'Cancel'.

The following table describes the labels in this screen.

Table 15 Network > WAN > Internet Connection: Advanced Setup

LABEL	DESCRIPTION
RIP & Multicast Setup	This section is not available when you configure the ZyXEL Device to be in bridge mode.
RIP Direction	RIP (Routing Information Protocol) allows a router to exchange routing information with other routers. Use this field to control how much routing information the ZyXEL Device sends and receives on the subnet. Select the RIP direction from None , Both , In Only and Out Only .
RIP Version	This field is not configurable if you select None in the RIP Direction field. Select the RIP version from RIP-1 , RIP-2B and RIP-2M .

Table 15 Network > WAN > Internet Connection: Advanced Setup (continued)

LABEL	DESCRIPTION
Multicast	<p>Multicast packets are sent to a group of computers on the LAN and are an alternative to unicast packets (packets sent to one computer) and broadcast packets (packets sent to every computer).</p> <p>Internet Group Multicast Protocol (IGMP) is a network-layer protocol used to establish membership in a multicast group. The ZyXEL Device supports IGMP-v1, IGMP-v2 and IGMP-v3. Select None to disable it.</p>
ATM QoS	
ATM QoS Type	<p>Select CBR (Continuous Bit Rate) to specify fixed (always-on) bandwidth for voice or data traffic. Select UBR (Unspecified Bit Rate) for applications that are non-time sensitive, such as e-mail. Select rtVBR (real-time Variable Bit Rate) type for applications with bursty connections that require closely controlled delay and delay variation. Select nrtVBR (non real-time Variable Bit Rate) type for connections that do not require closely controlled delay and delay variation.</p>
Peak Cell Rate	<p>Divide the DSL line rate (bps) by 424 (the size of an ATM cell) to find the Peak Cell Rate (PCR). This is the maximum rate at which the sender can send cells. Type the PCR here.</p>
Sustain Cell Rate	<p>The Sustain Cell Rate (SCR) sets the average cell rate (long-term) that can be transmitted. Type the SCR, which must be less than the PCR. Note that system default is 0 cells/sec.</p>
Maximum Burst Size	<p>Maximum Burst Size (MBS) refers to the maximum number of cells that can be sent at the peak rate. Type the MBS, which is less than 65535.</p>
MTU	
MTU	<p>The Maximum Transmission Unit (MTU) defines the size of the largest packet allowed on an interface or connection. Enter the MTU in this field.</p> <p>For ENET ENCAP, the MTU value is 1500.</p> <p>For PPPoE, the MTU value is 1492.</p> <p>For PPPoA and RFC 1483, the MTU is 65535.</p>
Back	Click this to return to the previous screen without saving.
Apply	Click this to save your changes.
Cancel	Click this to restore your previously saved settings.

6.3 The More Connections Screen

The ZyXEL Device allows you to configure more than one Internet access connection. To configure additional Internet access connections click **Network > WAN > More Connections**. The screen differs by the encapsulation you select. When you use the **WAN > Internet Access Setup** screen to set up Internet access, you are configuring the first WAN connection.

Figure 32 Network > WAN > More Connections

#	Active	Name:	VPI/VCI	Encapsulation	Modify
1	<input checked="" type="checkbox"/>	Internet Connection	8/35	ENET ENCAP	
2	<input type="checkbox"/>	--	--	--	
3	<input type="checkbox"/>	--	--	--	
4	<input type="checkbox"/>	--	--	--	
5	<input type="checkbox"/>	--	--	--	
6	<input type="checkbox"/>	--	--	--	
7	<input type="checkbox"/>	--	--	--	
8	<input type="checkbox"/>	--	--	--	

The following table describes the labels in this screen.

Table 16 Network > WAN > More Connections

LABEL	DESCRIPTION
#	This is an index number indicating the number of the corresponding connection.
Active	This field indicates whether the connection is active or not. Clear the check box to disable the connection. Select the check box to enable it.
Name	This is the name you gave to the Internet connection.
VPI/VCI	This field displays the Virtual Path Identifier (VPI) and Virtual Channel Identifier (VCI) numbers configured for this WAN connection.
Encapsulation	This field indicates the encapsulation method of the Internet connection.
Modify	The first (ISP) connection is read-only in this screen. Use the WAN > Internet Access Setup screen to edit it. Click the Edit icon to edit the Internet connection settings. Click this icon on an empty configuration to add a new Internet access setup. Click the Remove icon to delete the Internet access setup from your connection list.
Apply	Click this to save your changes.
Cancel	Click this to restore your previously saved settings.

6.3.1 More Connections Edit

Use this screen to configure a connection. Click the edit icon in the **More Connections** screen to display the following screen.

Figure 33 Network > WAN > More Connections: Edit

The following table describes the labels in this screen.

Table 17 Network > WAN > More Connections: Edit

LABEL	DESCRIPTION
General	
Active	Select the check box to activate or clear the check box to deactivate this connection.
Name	Enter a unique, descriptive name of up to 13 ASCII characters for this connection.
Mode	Select Routing from the drop-down list box if your ISP allows multiple computers to share an Internet account. If you select Bridge , the ZyXEL Device will forward any packet that it does not route to this remote node; otherwise, the packets are discarded.

Table 17 Network > WAN > More Connections: Edit (continued)

LABEL	DESCRIPTION
Encapsulation	<p>Select the method of encapsulation used by your ISP from the drop-down list box. Choices vary depending on the mode you select in the Mode field.</p> <p>If you select Bridge in the Mode field, select either PPPoA or RFC 1483.</p> <p>If you select Routing in the Mode field, select PPPoA, RFC 1483, ENET ENCAP or PPPoE.</p>
Multiplexing	<p>Select the method of multiplexing used by your ISP from the drop-down list. Choices are VC or LLC.</p> <p>By prior agreement, a protocol is assigned a specific virtual circuit, for example, VC1 will carry IP. If you select VC, specify separate VPI and VCI numbers for each protocol.</p> <p>For LLC-based multiplexing or PPP encapsulation, one VC carries multiple protocols with protocol identifying information being contained in each packet header. In this case, only one set of VPI and VCI numbers need be specified for all protocols.</p>
VPI	The valid range for the VPI is 0 to 255. Enter the VPI assigned to you.
VCI	The valid range for the VCI is 32 to 65535 (0 to 31 is reserved for local management of ATM traffic). Enter the VCI assigned to you.
IP Address	<p>This option is available if you select Routing in the Mode field.</p> <p>A static IP address is a fixed IP that your ISP gives you. A dynamic IP address is not fixed; the ISP assigns you a different one each time you connect to the Internet.</p> <p>If you use the encapsulation type except RFC 1483, select Obtain an IP Address Automatically when you have a dynamic IP address; otherwise select Static IP Address and type your ISP assigned IP address in the IP Address field below.</p> <p>If you use RFC 1483, enter the IP address given by your ISP in the IP Address field.</p>
Subnet Mask	<p>This option is available if you select ENET ENCAP in the Encapsulation field.</p> <p>Enter a subnet mask in dotted decimal notation.</p>
ENET ENCAP Gateway	<p>This option is available if you select ENET ENCAP in the Encapsulation field.</p> <p>Specify a gateway IP address (supplied by your ISP).</p>
Connection	
Nailed-Up Connection	Select Nailed-Up Connection when you want your connection up all the time. The ZyXEL Device will try to bring up the connection automatically if it is disconnected.
Connect on Demand	Select Connect on Demand when you don't want the connection up all the time and specify an idle time-out in the Max Idle Timeout field.

Table 17 Network > WAN > More Connections: Edit (continued)

LABEL	DESCRIPTION
Max Idle Timeout	Specify an idle time-out in the Max Idle Timeout field when you select Connect on Demand . The default setting is 0, which means the Internet session will not timeout.
NAT	SUA only is available only when you select Routing in the Mode field. Select SUA Only if you have one public IP address and want to use NAT. Click Edit Detail to go to the Port Forwarding screen to edit a server mapping set. Otherwise, select None to disable NAT.
Back	Click this to return to the previous screen without saving.
Apply	Click this to save your changes.
Cancel	Click this to restore your previously saved settings.
Advanced Setup	Click this to display the More Connections Advanced Setup screen and edit more details of your WAN setup.

6.3.2 Advanced Setup

Use this screen to edit your ZyXEL Device's advanced WAN settings. Click the **Advanced Setup** button in the **More Connections Edit** screen. The screen appears as shown.

Figure 34 Network > WAN > More Connections: Edit: Advanced Setup

The screenshot shows the 'Advanced Setup' screen for ATM QoS and MTU. The 'ATM QoS' section has a dropdown menu for 'ATM QoS Type' set to 'UBR'. Below it are three input fields: 'Peak Cell Rate' (0 cell/sec), 'Sustain Cell Rate' (0 cell/sec), and 'Maximum Burst Size' (0 cell). The 'MTU' section has an input field for 'MTU' set to 1500. At the bottom, there are three buttons: 'Back', 'Apply', and 'Cancel'.

The following table describes the labels in this screen.

Table 18 Network > WAN > More Connections: Edit: Advanced Setup

LABEL	DESCRIPTION
ATM QoS	
ATM QoS Type	Select CBR (Continuous Bit Rate) to specify fixed (always-on) bandwidth for voice or data traffic. Select UBR (Unspecified Bit Rate) for applications that are non-time sensitive, such as e-mail. Select nrtVBR (Variable Bit Rate-non Real Time) or rtVBR (Variable Bit Rate-Real Time) for bursty traffic and bandwidth sharing with other applications.
Peak Cell Rate	Divide the DSL line rate (bps) by 424 (the size of an ATM cell) to find the Peak Cell Rate (PCR). This is the maximum rate at which the sender can send cells. Type the PCR here.
Sustain Cell Rate	The Sustain Cell Rate (SCR) sets the average cell rate (long-term) that can be transmitted. Type the SCR, which must be less than the PCR. Note that system default is 0 cells/sec.
Maximum Burst Size	Maximum Burst Size (MBS) refers to the maximum number of cells that can be sent at the peak rate. Type the MBS, which is less than 65535.
MTU	
MTU	The Maximum Transmission Unit (MTU) defines the size of the largest packet allowed on an interface or connection. Enter the MTU in this field. For ENET ENCAP, the MTU value is 1500. For PPPoE, the MTU value is 1492. For PPPoA and RFC, the MTU is 65535.
Back	Click this to return to the previous screen without saving.
Apply	Click this to save your changes.
Cancel	Click this to restore your previously saved settings.

6.4 Technical Reference

This section provides some technical background information about the topics covered in this chapter.

6.4.1 Encapsulation

Be sure to use the encapsulation method required by your ISP. The ZyXEL Device supports the following methods.

6.4.1.1 ENET ENCAP

The MAC Encapsulated Routing Link Protocol (ENET ENCAP) is only implemented with the IP network protocol. IP packets are routed between the Ethernet interface and the WAN interface and then formatted so that they can be understood in a bridged environment. For instance, it encapsulates routed Ethernet frames into bridged ATM cells. ENET ENCAP requires that you specify a gateway IP address in the **Gateway IP Address** field in the wizard or WAN screen. You can get this information from your ISP.

6.4.1.2 PPP over Ethernet

The ZyXEL Device supports PPPoE (Point-to-Point Protocol over Ethernet). PPPoE is an IETF Draft standard (RFC 2516) specifying how a personal computer (PC) interacts with a broadband modem (DSL, cable, wireless, etc.) connection. The PPPoE option is for a dial-up connection using PPPoE.

For the service provider, PPPoE offers an access and authentication method that works with existing access control systems (for example RADIUS).

One of the benefits of PPPoE is the ability to let you access one of multiple network services, a function known as dynamic service selection. This enables the service provider to easily create and offer new IP services for individuals.

Operationally, PPPoE saves significant effort for both you and the ISP or carrier, as it requires no specific configuration of the broadband modem at the customer site.

By implementing PPPoE directly on the ZyXEL Device (rather than individual computers), the computers on the LAN do not need PPPoE software installed, since the ZyXEL Device does that part of the task. Furthermore, with NAT, all of the LANs' computers will have access.

6.4.1.3 PPPoA

PPPoA stands for Point to Point Protocol over ATM Adaptation Layer 5 (AAL5). A PPPoA connection functions like a dial-up Internet connection. The ZyXEL Device encapsulates the PPP session based on RFC1483 and sends it through an ATM PVC (Permanent Virtual Circuit) to the Internet Service Provider's (ISP) DSLAM (Digital Subscriber Line (DSL) Access Multiplexer). Please refer to RFC 2364 for more information on PPPoA. Refer to RFC 1661 for more information on PPP.

6.4.1.4 RFC 1483

RFC 1483 describes two methods for Multiprotocol Encapsulation over ATM Adaptation Layer 5 (AAL5). The first method allows multiplexing of multiple protocols over a single ATM virtual circuit (LLC-based multiplexing) and the second

method assumes that each protocol is carried over a separate ATM virtual circuit (VC-based multiplexing). Please refer to RFC 1483 for more detailed information.

6.4.2 Multiplexing

There are two conventions to identify what protocols the virtual circuit (VC) is carrying. Be sure to use the multiplexing method required by your ISP.

VC-based Multiplexing

In this case, by prior mutual agreement, each protocol is assigned to a specific virtual circuit; for example, VC1 carries IP, etc. VC-based multiplexing may be dominant in environments where dynamic creation of large numbers of ATM VCs is fast and economical.

LLC-based Multiplexing

In this case one VC carries multiple protocols with protocol identifying information being contained in each packet header. Despite the extra bandwidth and processing overhead, this method may be advantageous if it is not practical to have a separate VC for each carried protocol, for example, if charging heavily depends on the number of simultaneous VCs.

6.4.3 VPI and VCI

Be sure to use the correct Virtual Path Identifier (VPI) and Virtual Channel Identifier (VCI) numbers assigned to you. The valid range for the VPI is 0 to 255 and for the VCI is 32 to 65535 (0 to 31 is reserved for local management of ATM traffic). Please see the appendix for more information.

6.4.4 IP Address Assignment

A static IP is a fixed IP that your ISP gives you. A dynamic IP is not fixed; the ISP assigns you a different one each time. The Single User Account feature can be enabled or disabled if you have either a dynamic or static IP. However the encapsulation method assigned influences your choices for IP address and ENET ENCAP gateway.

IP Assignment with PPPoA or PPPoE Encapsulation

If you have a dynamic IP, then the **IP Address** and **Gateway IP Address** fields are not applicable (N/A). If you have a static IP, then you only need to fill in the **IP Address** field and not the **Gateway IP Address** field.

IP Assignment with RFC 1483 Encapsulation

In this case the IP address assignment must be static.

IP Assignment with ENET ENCAP Encapsulation

In this case you can have either a static or dynamic IP. For a static IP you must fill in all the **IP Address** and **Gateway IP Address** fields as supplied by your ISP. However for a dynamic IP, the ZyXEL Device acts as a DHCP client on the WAN port and so the **IP Address** and **Gateway IP Address** fields are not applicable (N/A) as the DHCP server assigns them to the ZyXEL Device.

6.4.5 Nailed-Up Connection (PPP)

A nailed-up connection is a dial-up line where the connection is always up regardless of traffic demand. The ZyXEL Device does two things when you specify a nailed-up connection. The first is that idle timeout is disabled. The second is that the ZyXEL Device will try to bring up the connection when turned on and whenever the connection is down. A nailed-up connection can be very expensive for obvious reasons.

Do not specify a nailed-up connection unless your telephone company offers flat-rate service or you need a constant connection and the cost is of no concern.

6.4.6 NAT

NAT (Network Address Translation - NAT, RFC 1631) is the translation of the IP address of a host in a packet, for example, the source address of an outgoing packet, used within one network to a different IP address known within another network.

6.5 Traffic Shaping

Traffic Shaping is an agreement between the carrier and the subscriber to regulate the average rate and fluctuations of data transmission over an ATM network. This agreement helps eliminate congestion, which is important for transmission of real time data such as audio and video connections.

Peak Cell Rate (PCR) is the maximum rate at which the sender can send cells. This parameter may be lower (but not higher) than the maximum line speed. 1 ATM cell is 53 bytes (424 bits), so a maximum speed of 832Kbps gives a maximum PCR of 1962 cells/sec. This rate is not guaranteed because it is dependent on the line speed.

Sustained Cell Rate (SCR) is the mean cell rate of each bursty traffic source. It specifies the maximum average rate at which cells can be sent over the virtual connection. SCR may not be greater than the PCR.

Maximum Burst Size (MBS) is the maximum number of cells that can be sent at the PCR. After MBS is reached, cell rates fall below SCR until cell rate averages to the SCR again. At this time, more cells (up to the MBS) can be sent at the PCR again.

If the PCR, SCR or MBS is set to the default of "0", the system will assign a maximum value that correlates to your upstream line rate.

The following figure illustrates the relationship between PCR, SCR and MBS.

Figure 35 Example of Traffic Shaping

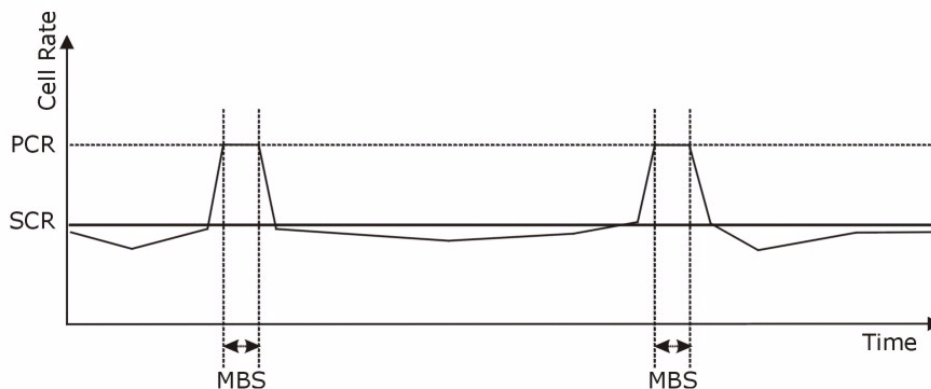

6.5.1 ATM Traffic Classes

These are the basic ATM traffic classes defined by the ATM Forum Traffic Management 4.0 Specification.

Constant Bit Rate (CBR)

Constant Bit Rate (CBR) provides fixed bandwidth that is always available even if no data is being sent. CBR traffic is generally time-sensitive (doesn't tolerate delay). CBR is used for connections that continuously require a specific amount of bandwidth. A PCR is specified and if traffic exceeds this rate, cells may be dropped. Examples of connections that need CBR would be high-resolution video and voice.

Variable Bit Rate (VBR)

The Variable Bit Rate (VBR) ATM traffic class is used with bursty connections. Connections that use the Variable Bit Rate (VBR) traffic class can be grouped into real time (VBR-RT) or non-real time (VBR-nRT) connections.

The VBR-RT (real-time Variable Bit Rate) type is used with bursty connections that require closely controlled delay and delay variation. It also provides a fixed amount of bandwidth (a PCR is specified) but is only available when data is being sent. An example of an VBR-RT connection would be video conferencing. Video conferencing requires real-time data transfers and the bandwidth requirement varies in proportion to the video image's changing dynamics.

The VBR-nRT (non real-time Variable Bit Rate) type is used with bursty connections that do not require closely controlled delay and delay variation. It is commonly used for "bursty" traffic typical on LANs. PCR and MBS define the burst levels, SCR defines the minimum level. An example of an VBR-nRT connection would be non-time sensitive data file transfers.

Unspecified Bit Rate (UBR)

The Unspecified Bit Rate (UBR) ATM traffic class is for bursty data transfers. However, UBR doesn't guarantee any bandwidth and only delivers traffic when the network has spare bandwidth. An example application is background file transfer.

LAN Setup

7.1 Overview

A Local Area Network (LAN) is a shared communication system to which many networking devices are connected. It is usually located in one immediate area such as a building or floor of a building.

Use the LAN screens to help you configure a LAN DHCP server and manage IP addresses.

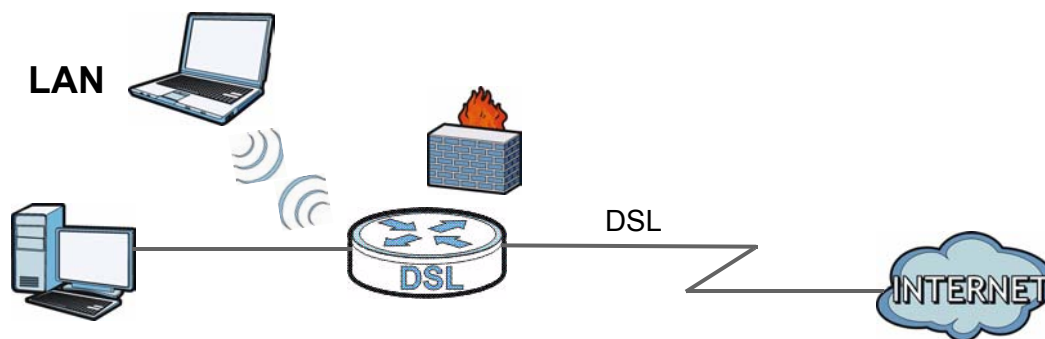

7.1.1 What You Can Do in the LAN Screens

- Use the **IP** screen ([Section 7.2 on page 87](#)) to set the LAN IP address and subnet mask of your ZyXEL device. You can also edit your ZyXEL Device's RIP, multicast, and Windows Networking settings from this screen.
- Use the **DHCP Setup** screen ([Section 7.3 on page 89](#)) to configure the ZyXEL Device's DHCP settings.
- Use the **Client List** screen ([Section 7.4 on page 90](#)) to assign IP addresses on the LAN to specific individual computers based on their MAC Addresses.
- Use the **IP Alias** screen ([Section 7.5 on page 91](#)) to change your ZyXEL Device's IP alias settings.

7.1.2 What You Need To Know

The following terms and concepts may help as you read this chapter.

IP Address

IP addresses identify individual devices on a network. Every networking device (including computers, servers, routers, printers, etc.) needs an IP address to communicate across the network. These networking devices are also known as hosts.

Subnet Mask

Subnet masks determine the maximum number of possible hosts on a network. You can also use subnet masks to divide one network into multiple sub-networks.

DHCP

A DHCP (Dynamic Host Configuration Protocol) server can assign your ZyXEL Device an IP address, subnet mask, DNS and other routing information when it's turned on.

RIP

RIP (Routing Information Protocol) allows a router to exchange routing information with other routers.

Multicast

Traditionally, IP packets are transmitted in one of either two ways - Unicast (1 sender - 1 recipient) or Broadcast (1 sender - everybody on the network). Multicast delivers IP packets to a group of hosts on the network - not everybody and not just 1.

IGMP

IGMP (Internet Group Multicast Protocol) is a network-layer protocol used to establish membership in a Multicast group - it is not used to carry user data. There are three versions of IGMP. IGMP version 2 and 3 are improvements over version 1, but IGMP version 1 is still in wide use.

DNS

DNS (Domain Name System) is for mapping a domain name to its corresponding IP address and vice versa. The DNS server is extremely important because

without it, you must know the IP address of a networking device before you can access it.

Finding Out More

See [Section 7.6 on page 94](#) for technical background information on LANs.

7.1.3 Before You Begin

Find out the MAC addresses of your network devices if you intend to add them to the DHCP Client List screen.

7.2 The IP Screen

Use this screen to set the Local Area Network IP address and subnet mask of your ZyXEL Device. Click **Network > LAN** to open the **IP** screen.

Follow these steps to configure your LAN settings.

- 1 Enter an IP address into the **IP Address** field. The IP address must be in dotted decimal notation. This will become the IP address of your ZyXEL Device.
- 2 Enter the IP subnet mask into the **IP Subnet Mask** field. Unless instructed otherwise it is best to leave this alone, the configurator will automatically compute a subnet mask based upon the IP address you entered.
- 3 Click **Apply** to save your settings.

Figure 36 Network > LAN > IP

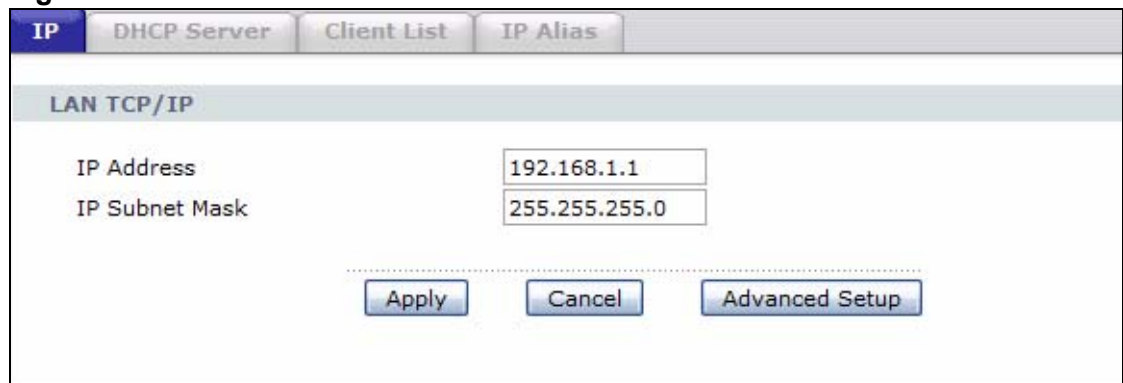

IP	DHCP Server	Client List	IP Alias
LAN TCP/IP			
IP Address	192.168.1.1		
IP Subnet Mask	255.255.255.0		
Apply Cancel Advanced Setup			

The following table describes the fields in this screen.

Table 19 Network > LAN > IP

LABEL	DESCRIPTION
IP Address	Enter the LAN IP address you want to assign to your ZyXEL Device in dotted decimal notation, for example, 192.168.1.1 (factory default).
IP Subnet Mask	Type the subnet mask of your network in dotted decimal notation, for example 255.255.255.0 (factory default). Your ZyXEL Device automatically computes the subnet mask based on the IP Address you enter, so do not change this field unless you are instructed to do so.
Apply	Click this to save your changes.
Cancel	Click this to restore your previously saved settings.
Advanced Setup	Click this to display the Advanced LAN Setup screen and edit more details of your LAN setup.

7.2.1 The Advanced Setup Screen

Use this screen to edit your ZyXEL Device's RIP, multicast and Windows Networking settings. Click the **Advanced Setup** button in the **IP** screen. The screen appears as shown.

Figure 37 Network > LAN > IP: Advanced Setup

The following table describes the labels in this screen.

Table 20 Network > LAN > IP: Advanced Setup

LABEL	DESCRIPTION
RIP & Multicast Setup	
RIP Direction	Select the RIP direction from None , Both , In Only and Out Only .
RIP Version	Select the RIP version from RIP-1 , RIP-2B and RIP-2M .
Multicast	IGMP (Internet Group Multicast Protocol) is a network-layer protocol used to establish membership in a multicast group. The ZyXEL Device supports IGMP-v1 , IGMP-v2 and IGMP-v3 . Select None to disable it.
Back	Click this to return to the previous screen without saving.
Apply	Click this to save your changes.
Cancel	Click this to restore your previously saved settings.

7.3 The DHCP Server Screen

Use this screen to configure the DNS server information that the ZyXEL Device sends to the DHCP client devices on the LAN. Click **Network > DHCP Setup** to open this screen.

Figure 38 Network > LAN > DHCP Setup

The following table describes the labels in this screen.

Table 21 Network > LAN > DHCP Server

LABEL	DESCRIPTION
DHCP Setup	
DHCP	<p>If set to Server, your ZyXEL Device can assign IP addresses, an IP default gateway and DNS servers to Windows 95, Windows NT and other systems that support the DHCP client.</p> <p>If set to None, the DHCP server will be disabled.</p> <p>If set to Relay, the ZyXEL Device acts as a surrogate DHCP server and relays DHCP requests and responses between the remote server and the clients. Enter the IP address of the actual, remote DHCP server in the Remote DHCP Server field in this case.</p> <p>When DHCP is used, the following items need to be set:</p>
IP Pool Starting Address	This field specifies the first of the contiguous addresses in the IP address pool.
Pool Size	This field specifies the size, or count of the IP address pool.
Remote DHCP Server	If Relay is selected in the DHCP field above then enter the IP address of the actual remote DHCP server here.
DNS Server	

Table 21 Network > LAN > DHCP Server

LABEL	DESCRIPTION
DNS Servers Assigned by DHCP Server	The ZyXEL Device passes a DNS (Domain Name System) server IP address to the DHCP clients.
Primary DNS Server	Enter the IP address of your primary/secondary DNS server.
Secondary DNS Server	
Apply	Click this to save your changes.
Cancel	Click this to restore your previously saved settings.

7.4 The Client List Screen

This table allows you to assign IP addresses on the LAN to specific individual computers based on their MAC Addresses.

Every Ethernet device has a unique MAC (Media Access Control) address. The MAC address is assigned at the factory and consists of six pairs of hexadecimal characters, for example, 00:A0:C5:00:00:02.

Use this screen to change your ZyXEL Device's static DHCP settings. Click **Network > LAN > Client List** to open the following screen.

Figure 39 Network > LAN > Client List

The screenshot shows the 'Client List' tab selected. At the top, there are tabs for 'IP', 'DHCP Setup', 'Client List', and 'IP Alias'. Below the tabs is the 'DHCP Client Table' section. It includes input fields for 'IP Address' (192.168.1.66) and 'MAC Address' (AA:BB:CC:EE:EE:EE) with an 'Add' button. The table has the following data:

#	Status	Host Name	IP Address	MAC Address	Reserve	Modify
1		IBM1	192.168.1.33	11:22:33:44:55:66	<input checked="" type="checkbox"/>	
2			192.168.1.34	AA:BB:CC:DD:EE:FF	<input checked="" type="checkbox"/>	
3		HP	192.168.1.99	AA:BB:CC:KK:FF:GG	<input type="checkbox"/>	

At the bottom of the table are 'Apply', 'Cancel', and 'Refresh' buttons.

The following table describes the labels in this screen.

Table 22 Network > LAN > Client List

LABEL	DESCRIPTION
IP Address	Enter the IP address that you want to assign to the computer on your LAN with the MAC address that you will also specify.
MAC Address	Enter the MAC address of a computer on your LAN.

Table 22 Network > LAN > Client List

LABEL	DESCRIPTION
Add	Click this to add a static DHCP entry.
#	This is the index number of the static IP table entry (row).
Status	This field displays whether the client is connected to the ZyXEL Device.
Host Name	This field displays the computer host name.
IP Address	This field displays the IP address relative to the # field listed above.
MAC Address	The MAC (Media Access Control) or Ethernet address on a LAN (Local Area Network) is unique to your computer (six pairs of hexadecimal notation). A network interface card such as an Ethernet adapter has a hardwired address that is assigned at the factory. This address follows an industry standard that ensures no other adapter has a similar address.
Reserve	Select the check box in the heading row to automatically select all check boxes or select the check box(es) in each entry to have the ZyXEL Device always assign the selected entry(ies)'s IP address(es) to the corresponding MAC address(es) (and host name(s)). You can select up to 10 entries in this table.
Modify	Click the modify icon to have the IP address field editable and change it.
Apply	Click this to save your changes.
Cancel	Click this to restore your previously saved settings.
Refresh	Click this to reload the DHCP table.

7.5 The IP Alias Screen

IP alias allows you to partition a physical network into different logical networks over the same Ethernet interface. The ZyXEL Device supports three logical LAN interfaces via its single physical Ethernet interface with the ZyXEL Device itself as the gateway for each LAN network.

When you use IP alias, you can also configure firewall rules to control access between the LAN's logical networks (subnets).

Note: Make sure that the subnets of the logical networks do not overlap.

The following figure shows a LAN divided into subnets A, B, and C.

Figure 40 Physical Network & Partitioned Logical Networks

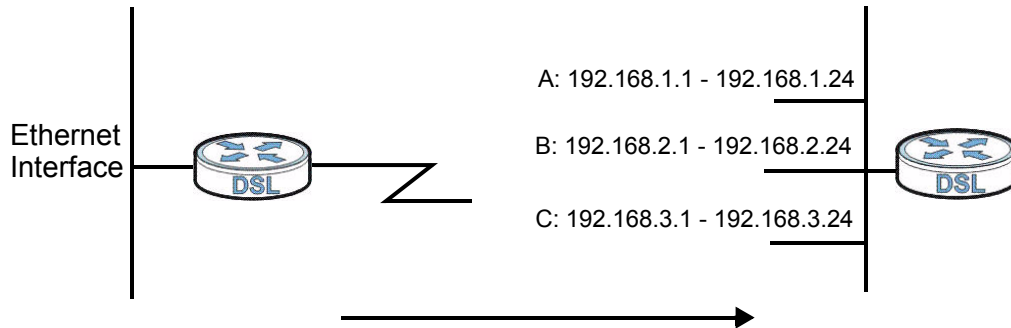

7.5.1 Configuring the LAN IP Alias Screen

Use this screen to change your ZyXEL Device's IP alias settings. Click **Network > LAN > IP Alias** to open the following screen.

Figure 41 Network > LAN > IP Alias

The screenshot shows the 'IP Alias' configuration screen. At the top, there are tabs for 'IP', 'DHCP Server', 'Client List', and 'IP Alias'. The 'IP Alias' tab is selected. Below the tabs, the screen is titled 'IP Alias 1'. There is a checkbox labeled 'IP Alias 1' which is currently unchecked. Below the checkbox are four input fields:

- IP Address: 0.0.0.0
- IP Subnet Mask: 0.0.0.0
- RIP Direction: None (dropdown menu)
- RIP Version: N/A (dropdown menu)

At the bottom of the screen, there are two buttons: 'Apply' and 'Cancel'.

The following table describes the labels in this screen.

Table 23 Network > LAN > IP Alias

LABEL	DESCRIPTION
IP Alias 1	Select the check box to configure another LAN network for the ZyXEL Device.
IP Address	Enter the IP address of your ZyXEL Device in dotted decimal notation. Alternatively, click the right mouse button to copy and/or paste the IP address.
IP Subnet Mask	Your ZyXEL Device will automatically calculate the subnet mask based on the IP address that you assign. Unless you are implementing subnetting, use the subnet mask computed by the ZyXEL Device.

Table 23 Network > LAN > IP Alias

LABEL	DESCRIPTION
RIP Direction	RIP (Routing Information Protocol, RFC 1058 and RFC 1389) allows a router to exchange routing information with other routers. The RIP Direction field controls the sending and receiving of RIP packets. Select the RIP direction from Both/In Only/Out Only/None . When set to Both or Out Only , the ZyXEL Device will broadcast its routing table periodically. When set to Both or In Only , it will incorporate the RIP information that it receives; when set to None , it will not send any RIP packets and will ignore any RIP packets received.
RIP Version	The RIP Version field controls the format and the broadcasting method of the RIP packets that the ZyXEL Device sends (it recognizes both formats when receiving). RIP-1 is universally supported but RIP-2 carries more information. RIP-1 is probably adequate for most networks, unless you have an unusual network topology. Both RIP-2B and RIP-2M sends the routing data in RIP-2 format; the difference being that RIP-2B uses subnet broadcasting while RIP-2M uses multicasting. Multicasting can reduce the load on non-router machines since they generally do not listen to the RIP multicast address and so will not receive the RIP packets. However, if one router uses multicasting, then all routers on your network must use multicasting, also. By default, RIP direction is set to Both and the Version set to RIP-1 .
Apply	Click this to save your changes.
Cancel	Click this to restore your previously saved settings.

7.6 Technical Reference

This section provides some technical background information about the topics covered in this chapter.

7.6.1 LANs, WANs and the ZyXEL Device

The actual physical connection determines whether the ZyXEL Device ports are LAN or WAN ports. There are two separate IP networks, one inside the LAN network and the other outside the WAN network as shown next.

Figure 42 LAN and WAN IP Addresses

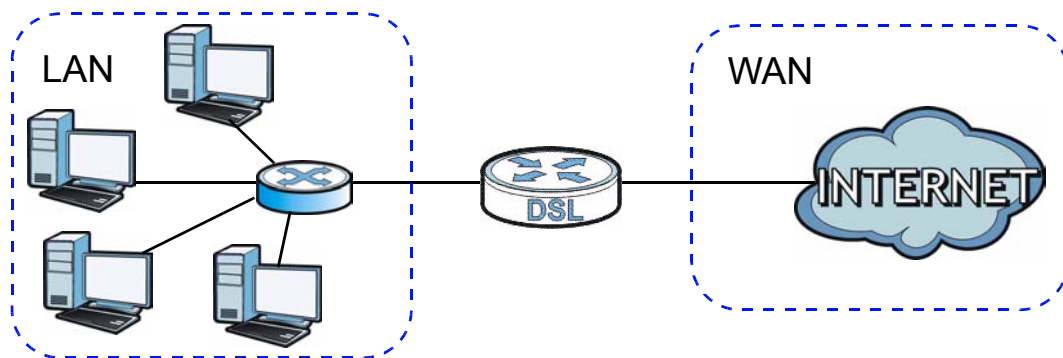

7.6.2 DHCP Setup

DHCP (Dynamic Host Configuration Protocol, RFC 2131 and RFC 2132) allows individual clients to obtain TCP/IP configuration at start-up from a server. You can configure the ZyXEL Device as a DHCP server or disable it. When configured as a server, the ZyXEL Device provides the TCP/IP configuration for the clients. If you turn DHCP service off, you must have another DHCP server on your LAN, or else the computer must be manually configured.

IP Pool Setup

The ZyXEL Device is pre-configured with a pool of IP addresses for the DHCP clients (DHCP Pool). See the product specifications in the appendices. Do not assign static IP addresses from the DHCP pool to your LAN computers.

7.6.3 DNS Server Addresses

DNS (Domain Name System) maps a domain name to its corresponding IP address and vice versa. The DNS server is extremely important because without it, you must know the IP address of a computer before you can access it. The DNS

server addresses you enter when you set up DHCP are passed to the client machines along with the assigned IP address and subnet mask.

There are two ways that an ISP disseminates the DNS server addresses.

- The ISP tells you the DNS server addresses, usually in the form of an information sheet, when you sign up. If your ISP gives you DNS server addresses, enter them in the **DNS Server** fields in the **DHCP Setup** screen.
- Some ISPs choose to disseminate the DNS server addresses using the DNS server extensions of IPCP (IP Control Protocol) after the connection is up. If your ISP did not give you explicit DNS servers, chances are the DNS servers are conveyed through IPCP negotiation. The ZyXEL Device supports the IPCP DNS server extensions through the DNS proxy feature.

Please note that DNS proxy works only when the ISP uses the IPCP DNS server extensions. It does not mean you can leave the DNS servers out of the DHCP setup under all circumstances. If your ISP gives you explicit DNS servers, make sure that you enter their IP addresses in the **DHCP Setup** screen.

7.6.4 LAN TCP/IP

The ZyXEL Device has built-in DHCP server capability that assigns IP addresses and DNS servers to systems that support DHCP client capability.

IP Address and Subnet Mask

Similar to the way houses on a street share a common street name, so too do computers on a LAN share one common network number.

Where you obtain your network number depends on your particular situation. If the ISP or your network administrator assigns you a block of registered IP addresses, follow their instructions in selecting the IP addresses and the subnet mask.

If the ISP did not explicitly give you an IP network number, then most likely you have a single user account and the ISP will assign you a dynamic IP address when the connection is established. If this is the case, it is recommended that you select a network number from 192.168.0.0 to 192.168.255.0 and you must enable the Network Address Translation (NAT) feature of the ZyXEL Device. The Internet Assigned Number Authority (IANA) reserved this block of addresses specifically for private use; please do not use any other number unless you are told otherwise. Let's say you select 192.168.1.0 as the network number; which covers 254 individual addresses, from 192.168.1.1 to 192.168.1.254 (zero and 255 are reserved). In other words, the first three numbers specify the network number while the last number identifies an individual computer on that network.

Once you have decided on the network number, pick an IP address that is easy to remember, for instance, 192.168.1.1, for your ZyXEL Device, but make sure that no other device on your network is using that IP address.

The subnet mask specifies the network number portion of an IP address. Your ZyXEL Device will compute the subnet mask automatically based on the IP address that you entered. You don't need to change the subnet mask computed by the ZyXEL Device unless you are instructed to do otherwise.

Private IP Addresses

Every machine on the Internet must have a unique address. If your networks are isolated from the Internet, for example, only between your two branch offices, you can assign IP addresses to the hosts without problems. However, the Internet Assigned Numbers Authority (IANA) has reserved the following three blocks of IP addresses specifically for private networks:

- 10.0.0.0 — 10.255.255.255
- 172.16.0.0 — 172.31.255.255
- 192.168.0.0 — 192.168.255.255

You can obtain your IP address from the IANA, from an ISP or it can be assigned from a private network. If you belong to a small organization and your Internet access is through an ISP, the ISP can provide you with the Internet addresses for your local networks. On the other hand, if you are part of a much larger organization, you should consult your network administrator for the appropriate IP addresses.

Note: Regardless of your particular situation, do not create an arbitrary IP address; always follow the guidelines above. For more information on address assignment, please refer to RFC 1597, "Address Allocation for Private Internets" and RFC 1466, "Guidelines for Management of IP Address Space".

7.6.5 RIP Setup

RIP (Routing Information Protocol) allows a router to exchange routing information with other routers. The **RIP Direction** field controls the sending and receiving of RIP packets. When set to:

- **Both** - the ZyXEL Device will broadcast its routing table periodically and incorporate the RIP information that it receives.
- **In Only** - the ZyXEL Device will not send any RIP packets but will accept all RIP packets received.
- **Out Only** - the ZyXEL Device will send out RIP packets but will not accept any RIP packets received.

- **None** - the ZyXEL Device will not send any RIP packets and will ignore any RIP packets received.

The **Version** field controls the format and the broadcasting method of the RIP packets that the ZyXEL Device sends (it recognizes both formats when receiving). RIP-1 is universally supported; but RIP-2 carries more information. RIP-1 is probably adequate for most networks, unless you have an unusual network topology.

Both RIP-2B and RIP-2M sends the routing data in RIP-2 format; the difference being that RIP-2B uses subnet broadcasting while RIP-2M uses multicasting.

7.6.6 Multicast

Traditionally, IP packets are transmitted in one of either two ways - Unicast (1 sender - 1 recipient) or Broadcast (1 sender - everybody on the network). Multicast delivers IP packets to a group of hosts on the network - not everybody and not just 1.

IGMP (Internet Group Multicast Protocol) is a network-layer protocol used to establish membership in a Multicast group - it is not used to carry user data. IGMP version 2 (RFC 2236) is an improvement over version 1 (RFC 1112) but IGMP version 1 is still in wide use. IGMP version 3 supports source filtering, reporting or ignoring traffic from specific source address to a particular host on the network. If you would like to read more detailed information about interoperability between IGMP version 2 and version 1, please see sections 4 and 5 of RFC 2236. The class D IP address is used to identify host groups and can be in the range 224.0.0.0 to 239.255.255.255. The address 224.0.0.0 is not assigned to any group and is used by IP multicast computers. The address 224.0.0.1 is used for query messages and is assigned to the permanent group of all IP hosts (including gateways). All hosts must join the 224.0.0.1 group in order to participate in IGMP. The address 224.0.0.2 is assigned to the multicast routers group.

The ZyXEL Device supports IGMP version 1 (**IGMP-v1**), IGMP version 2 (**IGMP-v2**) and IGMP version 3 (**IGMP-v3**). At start up, the ZyXEL Device queries all directly connected networks to gather group membership. After that, the ZyXEL Device periodically updates this information. IP multicasting can be enabled/disabled on the ZyXEL Device LAN and/or WAN interfaces in the web configurator (**LAN; WAN**). Select **None** to disable IP multicasting on these interfaces.

Wireless LAN

8.1 Overview

This chapter describes how to perform tasks related to setting up and optimizing your wireless network, including the following.

- Turning the wireless connection on or off.
- Configuring a name, wireless channel and security for the network.
- Using WiFi Protected Setup (WPS) to configure your wireless network.
- Setting up multiple wireless networks.
- Using a MAC (Media Access Control) address filter to restrict access to the wireless network.
- Setting up a Wireless Distribution System (WDS).
- Performing other performance-related wireless tasks.

8.1.1 What You Can Do in the Wireless LAN Screens

This section describes the ZyXEL Device's **Network > Wireless LAN** screens. Use these screens to set up your ZyXEL Device's wireless connection.

- Use the **AP** screen (see [Section 8.2 on page 101](#)) to turn the wireless connection on or off, set up wireless security, configure the MAC filter, and make other basic configuration changes.
- Use the **More AP** screen (see [Section 8.3 on page 109](#)) to set up multiple wireless networks on your ZyXEL Device.
- Use the **WPS** screen (see [Section 8.4 on page 111](#)) to enable or disable WPS, generate a security PIN (Personal Identification Number) and see information about the ZyXEL Device's WPS status.
- Use the **WPS Station** (see [Section 8.5 on page 112](#)) screen to set up WPS by pressing a button or using a PIN.
- Use the **WDS** screen (see [Section 8.6 on page 113](#)) to set up a Wireless Distribution System, in which the ZyXEL Device acts as a bridge with other ZyXEL access points.
- Use the **Scheduling** screen (see [Section 8.7 on page 115](#)) to configure the dates/times to enable or disable the wireless LAN.

You don't necessarily need to use all these screens to set up your wireless connection. For example, you may just want to set up a network name, a wireless radio channel and security in the **AP** screen.

8.1.2 What You Need to Know

The following terms and concepts may help as you read this chapter.

Wireless Basics

"Wireless" is essentially radio communication. In the same way that walkie-talkie radios send and receive information over the airwaves, wireless networking devices exchange information with one another. A wireless networking device is just like a radio that lets your computer exchange information with radios attached to other computers. Like walkie-talkies, most wireless networking devices operate at radio frequency bands that are open to the public and do not require a license to use. However, wireless networking is different from that of most traditional radio communications in that there a number of wireless networking standards available with different methods of data encryption.

SSID

Each network must have a name, referred to as the SSID - "Service Set Identifier". The "service set" is the network, so the "service set identifier" is the network's name. This helps you identify your wireless network when wireless networks' coverage areas overlap and you have a variety of networks to choose from.

MAC Address Filter

Every Ethernet device has a unique MAC (Media Access Control) address. The MAC address consists of twelve hexadecimal characters (0-9, and A to F), and it is usually written in the following format: "0A:A0:00:BB:CC:DD".

The MAC address filter controls access to the wireless network. You can use the MAC address of each wireless client to allow or deny access to the wireless network.

Finding Out More

See [Section 8.8 on page 116](#) for advanced technical information on wireless networks.

8.1.3 Before You Start

Before you start using these screens, ask yourself the following questions. See [Section 8.1.2 on page 100](#) if some of the terms used here are not familiar to you.

- What wireless standards do the other wireless devices in your network support (IEEE 802.11g, for example)? What is the most appropriate standard to use?
- What security options do the other wireless devices in your network support (WPA-PSK, for example)? What is the strongest security option supported by all the devices in your network?
- Do the other wireless devices in your network support WPS (Wi-Fi Protected Setup)? If so, you can set up a well-secured network very easily.

Even if some of your devices support WPS and some do not, you can use WPS to set up your network and then add the non-WPS devices manually, although this is somewhat more complicated to do.

- What advanced options do you want to configure, if any? If you want to configure advanced options such as Quality of Service, ensure that you know precisely what you want to do. If you do not want to configure advanced options, leave them as they are.

8.2 The AP Screen

Use this screen to configure the wireless settings of your ZyXEL Device. Click **Network > Wireless LAN** to open the **AP** screen.

Figure 43 Network > Wireless LAN > AP

The screenshot shows the configuration interface for the AP (Access Point) settings. The top navigation bar includes tabs for 'AP', 'More AP', 'WPS', 'WPS Station', 'WDS', and 'Scheduling'. The main content area is divided into two sections: 'Wireless Setup' and 'Common Setup'. In the 'Wireless Setup' section, the 'Enable Wireless LAN' checkbox is checked. Below it, the 'Channel Selection' dropdown is set to 'Channel06 2437MHz', and the 'Current Channel' is set to '6'. The 'Common Setup' section contains several fields: 'Name(SSID)' is 'RT3390_1', 'Hide SSID' is unchecked, 'Security Mode' is 'No Security', 'MAC Filter' has an 'Allow Association' button and an 'Edit' button, and 'QoS' has an unchecked 'Enable QoS' checkbox. At the bottom of the screen, there are three buttons: 'Apply', 'Cancel', and 'Advanced Setup'.

The following table describes the labels in this screen.

Table 24 Network > Wireless LAN > AP

LABEL	DESCRIPTION
Wireless Setup	
Enable Wireless LAN	Click the check box to activate wireless LAN.
Channel Selection	Set the operating frequency/channel.
Common Setup	
Network Name (SSID)	The SSID (Service Set IDentity) identifies the service set with which a wireless device is associated. Wireless devices associating to the access point (AP) must have the same SSID. Enter a descriptive name (up to 32 printable 7-bit ASCII characters) for the wireless LAN. Note: If you are configuring the ZyXEL Device from a computer connected to the wireless LAN and you change the ZyXEL Device's SSID or WEP settings, you will lose your wireless connection when you press Apply to confirm. You must then change the wireless settings of your computer to match the ZyXEL Device's new settings.
Hide SSID	Select this check box to hide the SSID in the outgoing beacon frame so a station cannot obtain the SSID through scanning using a site survey tool.
Security Mode	See the following sections for more details about this field.
MAC Filter	This shows whether the wireless devices with the MAC addresses listed are allowed or denied to access the ZyXEL Device using this SSID.
Edit	Click this to go to the MAC Filter screen to configure MAC filter settings. See Section 8.2.6 on page 108 for more details.
Apply	Click this to save your changes.
Cancel	Click this to restore your previously saved settings.
Advanced Setup	Click this to display the Wireless Advanced Setup screen and edit more details of your WLAN setup. See Section 8.2.5 on page 106 for more details.

8.2.1 No Security

In the **Network > Wireless LAN > AP** screen, select **No Security** from the **Security Mode** list to allow wireless devices to communicate with the ZyXEL Device without any data encryption or authentication.

Note: If you do not enable any wireless security on your ZyXEL Device, your network is accessible to any wireless networking device that is within range.

Figure 44 Network > Wireless LAN > AP: No Security

The screenshot shows a web interface titled 'Common Setup'. It contains the following fields and options:

- Network Name(SSID):** A text input field containing 'ZyXEL01'.
- Hide SSID:** A checkbox that is currently unchecked.
- Security Mode:** A dropdown menu with 'No Security' selected.

The following table describes the labels in this screen.

Table 25 Network > Wireless LAN > AP: No Security

LABEL	DESCRIPTION
Security Mode	Choose No Security from the drop-down list box.

8.2.2 WEP Encryption

Use this screen to configure and enable WEP encryption. Click **Network > Wireless LAN** to display the **AP** screen. Select **Static WEP** from the **Security Mode** list.

Note: WEP is extremely insecure. Its encryption can be broken by an attacker, using widely-available software. It is strongly recommended that you use a more effective security mechanism. Use the strongest security mechanism that all the wireless devices in your network support. For example, use WPA-PSK or WPA2-PSK if all your wireless devices support it, or use WPA or WPA2 if your wireless devices support it and you have a RADIUS server. If your wireless devices support nothing stronger than WEP, use the highest encryption level available.

Figure 45 Network > Wireless LAN > AP: Static WEP

The screenshot shows a web interface titled 'Common Setup'. It contains the following fields and options:

- Network Name(SSID):** A text input field containing 'ZyXEL01'.
- Hide SSID:** A checkbox that is currently unchecked.
- Security Mode:** A dropdown menu with 'Static WEP' selected.
- Passphrase:** A text input field with a 'Generate' button to its right.
- WEP Key:** A text input field.

Note:
 The different WEP key lengths configure different strength security, 40/64-bit, or 128-bit respectively. Your wireless client must match the security strength set on the router.
 -Please type exactly 5, or 13 characters.
 -Please type exactly 10, or 26 characters using only the numbers 0-9 and the letters A-F.

The following table describes the wireless LAN security labels in this screen.

Table 26 Network > Wireless LAN > AP: Static WEP

LABEL	DESCRIPTION
Security Mode	Choose Static WEP from the drop-down list box.
Passphrase	Enter a passphrase (up to 32 printable characters) and click Generate . The ZyXEL Device automatically generates a WEP key.
WEP Key	The WEP key is used to encrypt data. Both the ZyXEL Device and the wireless stations must use the same WEP key for data transmission. If you want to manually set the WEP key, enter any 5 or 13 characters (ASCII string) or 10 or 26 hexadecimal characters ("0-9", "A-F") for a 64-bit or 128-bit WEP key respectively.

8.2.3 WPA(2)-PSK

Use this screen to configure and enable WPA(2)-PSK authentication. Click **Network > Wireless LAN** to display the **AP** screen. Select **WPA-PSK** or **WPA2-PSK** from the **Security Mode** list.

Figure 46 Network > Wireless LAN > AP: WPA(2)-PSK

The screenshot shows a configuration window titled 'Common Setup'. It contains the following fields and options:

- Name(SSID): A text box containing 'ZyXEL01'.
- Hide SSID: An unchecked checkbox.
- Security Mode: A dropdown menu with 'WPA-PSK' selected.
- Pre-Shared Key: An empty text box.
- WPA Group Key Update Timer: A text box containing '10' followed by '(In Seconds)'.

The following table describes the wireless LAN security labels in this screen.

Table 27 Network > Wireless LAN > AP: WPA(2)-PSK

LABEL	DESCRIPTION
Security Mode	Choose WPA-PSK or WPA2-PSK from the drop-down list box.
Pre-Shared Key	The encryption mechanisms used for WPA(2) and WPA(2)-PSK are the same. The only difference between the two is that WPA(2)-PSK uses a simple common password, instead of user-specific credentials. Type a pre-shared key from 8 to 63 case-sensitive ASCII characters (including spaces and symbols).
WPA Group Key Update Timer	The Group Key Update Timer is the rate at which the AP (if using WPA(2)-PSK key management) or RADIUS server (if using WPA(2) key management) sends a new group key out to all clients. The re-keying process is the WPA(2) equivalent of automatically changing the WEP key for an AP and all stations in a WLAN on a periodic basis.

8.2.4 WPA(2) Authentication

Use this screen to configure and enable WPA or WPA2 authentication. Click the **Wireless LAN** link under **Network** to display the **AP** screen. Select **WPA**, **WPA2** or **WPAMixed** from the **Security Mode** list.

Figure 47 Network > Wireless LAN > AP: WPA(2)

Common Setup	
Name(SSID)	ZyXEL01
<input type="checkbox"/> Hide SSID	
Security Mode	WPA2
<input type="checkbox"/> WPA Compatible	
ReAuthentication Timer	0 (In Seconds)
Idle Timeout	300 (In Seconds)
WPA Group Key Update Timer	10 (In Seconds)
Authentication Server	
IP Address	0.0.0.0
Port Number	0
Shared Secret	

The following table describes the wireless LAN security labels in this screen.

Table 28 Network > Wireless LAN > AP: WPA(2)

LABEL	DESCRIPTION
Security Mode	Choose WPA or WPA2 from the drop-down list box.
WPA Compatible	This check box is available only when you select WPA2-PSK or WPA2 in the Security Mode field. Select the check box to have both WPA-PSK and WPA wireless clients be able to communicate with the ZyXEL Device even when the ZyXEL Device is using WPA2-PSK or WPA2.
ReAuthentication Timer	Specify how often wireless stations have to resend usernames and passwords in order to stay connected. Enter a time interval between 10 and 9999 seconds. Note: If wireless station authentication is done using a RADIUS server, the reauthentication timer on the RADIUS server has priority.
Idle Timeout	The ZyXEL Device automatically disconnects a wireless station from the wired network after a period of inactivity. The wireless station needs to enter the username and password again before access to the wired network is allowed.
WPA Group Key Update Timer	The Group Key Update Timer is the rate at which the AP (if using WPA(2)-PSK key management) or RADIUS server (if using WPA(2) key management) sends a new group key out to all clients. The re-keying process is the WPA(2) equivalent of automatically changing the WEP key for an AP and all stations in a WLAN on a periodic basis.

Table 28 Network > Wireless LAN > AP: WPA(2)

LABEL	DESCRIPTION
Authentication Server	
IP Address	Enter the IP address of the external authentication server in dotted decimal notation.
Port Number	Enter the port number of the external authentication server. You need not change this value unless your network administrator instructs you to do so with additional information.
Shared Secret	Enter a password (up to 31 alphanumeric characters) as the key to be shared between the external authentication server and the ZyXEL Device. The key must be the same on the external authentication server and your ZyXEL Device. The key is not sent over the network.

8.2.5 Advanced Setup

Use this screen to configure advanced wireless settings. Click the **Advanced Setup** button in the **AP** screen. The screen appears as shown.

See [Section 8.8.2 on page 118](#) for detailed definitions of the terms listed in this screen.

Figure 48 Network > Wireless LAN > AP: Advanced Setup

The following table describes the labels in this screen.

Table 29 Network > Wireless LAN > AP: Advanced Setup

LABEL	DESCRIPTION
RTS/CTS Threshold	Enter a value between 0 and 2432.
Fragmentation Threshold	This is the maximum data fragment size that can be sent. Enter a value between 256 and 2432.

Table 29 Network > Wireless LAN > AP: Advanced Setup

LABEL	DESCRIPTION
Output Power	Set the output power of the ZyXEL Device. If there is a high density of APs in an area, decrease the output power to reduce interference with other APs. Select one of the following: 100% , 75% , 50% or 25% .
Preamble	Select a preamble type from the drop-down list menu. Choices are Long or Short . See the Appendix D on page 293 for more information.
802.11 Mode	<p>Select 802.11b Only to allow only IEEE 802.11b compliant WLAN devices to associate with the ZyXEL Device.</p> <p>Select 802.11g Only to allow only IEEE 802.11g compliant WLAN devices to associate with the ZyXEL Device.</p> <p>Select 802.11b+g to allow either IEEE 802.11b or IEEE 802.11g compliant WLAN devices to associate with the ZyXEL Device. The transmission rate of your ZyXEL Device might be reduced.</p> <p>Select 802.11n to allow only IEEE 802.11n compliant WLAN devices to associate with the ZyXEL Device.</p> <p>Select 802.11g+n to allow either IEEE 802.11g or IEEE 802.11n compliant WLAN devices to associate with the ZyXEL Device. The transmission rate of your ZyXEL Device might be reduced.</p> <p>Select 802.11b+g+n to allow IEEE 802.11b, IEEE 802.11g or IEEE802.11n compliant WLAN devices to associate with the ZyXEL Device. The transmission rate of your ZyXEL Device might be reduced.</p>
Back	Click this to return to the previous screen without saving.
Apply	Click this to save your changes.
Cancel	Click this to restore your previously saved settings.

8.2.6 MAC Filter

Use this screen to change your ZyXEL Device's MAC filter settings. Click the **Edit** button in the **AP** screen. The screen appears as shown.

Figure 49 Network > Wireless LAN > AP: MAC Address Filter

Set	MAC Address	Set	MAC Address
1	00:a0:c5:01:23:45	2	00:00:00:00:00:00
3	00:00:00:00:00:00	4	00:00:00:00:00:00
5	00:00:00:00:00:00	6	00:00:00:00:00:00
7	00:00:00:00:00:00	8	00:00:00:00:00:00
9	00:00:00:00:00:00	10	00:00:00:00:00:00
11	00:00:00:00:00:00	12	00:00:00:00:00:00
13	00:00:00:00:00:00	14	00:00:00:00:00:00
15	00:00:00:00:00:00	16	00:00:00:00:00:00
17	00:00:00:00:00:00	18	00:00:00:00:00:00
19	00:00:00:00:00:00	20	00:00:00:00:00:00
21	00:00:00:00:00:00	22	00:00:00:00:00:00
23	00:00:00:00:00:00	24	00:00:00:00:00:00
25	00:00:00:00:00:00	26	00:00:00:00:00:00
27	00:00:00:00:00:00	28	00:00:00:00:00:00
29	00:00:00:00:00:00	30	00:00:00:00:00:00
31	00:00:00:00:00:00	32	00:00:00:00:00:00

The following table describes the labels in this screen.

Table 30 Network > Wireless LAN > AP: MAC Address Filter

LABEL	DESCRIPTION
Active MAC Filter	Select the check box to enable MAC address filtering.
Filter Action	Define the filter action for the list of MAC addresses in the MAC Address table. Select Deny to block access to the ZyXEL Device. MAC addresses not listed will be allowed to access the ZyXEL Device Select Allow to permit access to the ZyXEL Device. MAC addresses not listed will be denied access to the ZyXEL Device.
Set	This is the index number of the MAC address.
MAC Address	Enter the MAC addresses of the wireless devices that are allowed or denied access to the ZyXEL Device in these address fields. Enter the MAC addresses in a valid MAC address format, that is, six hexadecimal character pairs, for example, 12:34:56:78:9a:bc.

Table 30 Network > Wireless LAN > AP: MAC Address Filter

LABEL	DESCRIPTION
Back	Click this to return to the previous screen without saving.
Apply	Click this to save your changes.
Cancel	Click this to restore your previously saved settings.

8.3 The More AP Screen

This screen allows you to enable and configure multiple Basic Service Sets (BSSs) on the ZyXEL Device.

Click **Network > Wireless LAN > More AP**. The following screen displays.

Figure 50 Network > Wireless LAN > More AP

The following table describes the labels in this screen.

Table 31 Network > Wireless LAN > More AP

LABEL	DESCRIPTION
#	This is the index number of each SSID profile.
Active	This field indicates with a check mark whether this SSID is active. No check mark means it is not active.
SSID	An SSID profile is the set of parameters relating to one of the ZyXEL Device's BSSs. The SSID (Service Set Identifier) identifies the Service Set with which a wireless device is associated. This field displays the name of the wireless profile on the network. When a wireless client scans for an AP to associate with, this is the name that is broadcast and seen in the wireless client utility.
Security	This field indicates the security mode of the SSID profile.
Modify	Click the Edit icon to configure the SSID profile. Click the Remove icon to hide the SSID in the outgoing beacon frame so a station cannot obtain the SSID through scanning using a site survey tool.

Table 31 Network > Wireless LAN > More AP

LABEL	DESCRIPTION
Apply	Click this to save your changes.
Cancel	Click this to restore your previously saved settings.

8.3.1 More AP Edit

Use this screen to edit an SSID profile. Click the **Edit** icon next to an SSID in the **More AP** screen. The following screen displays.

Figure 51 Network > Wireless LAN > More AP: Edit

The screenshot shows a 'Common Setup' window with the following fields and controls:

- Name(SSID): Text input field containing 'ZyXEL02'.
- Hide SSID: Unchecked checkbox.
- Security Mode: Dropdown menu showing 'No Security'.
- MAC Filter: Text input field containing 'Allow Association'.
- QoS: Unchecked checkbox with the label 'Enable QoS'.
- Buttons: 'Back', 'Apply', and 'Cancel' buttons at the bottom.

The following table describes the fields in this screen.

Table 32 Network > Wireless LAN > More AP: Edit

LABEL	DESCRIPTION
Network Name (SSID)	The SSID (Service Set IDentity) identifies the service set with which a wireless device is associated. Enter a descriptive name (up to 32 printable 7-bit ASCII characters) for the wireless LAN. Note: If you are configuring the ZyXEL Device from a computer connected to the wireless LAN and you change the ZyXEL Device's SSID or security settings, you will lose your wireless connection when you press Apply to confirm. You must then change the wireless settings of your computer to match the ZyXEL Device's new settings.
Hide SSID	Select this check box to hide the SSID in the outgoing beacon frame so a station cannot obtain the SSID through scanning using a site survey tool.
Security Mode	See Section 8.2 on page 101 for more details about this field.
MAC Filter	This shows whether the wireless devices with the MAC addresses listed are allowed or denied to access the ZyXEL Device using this SSID.
Edit	Click this to go to the MAC Filter screen to configure MAC filter settings. See Section 8.2.6 on page 108 for more details.

Table 32 Network > Wireless LAN > More AP: Edit

LABEL	DESCRIPTION
QoS	Select this check box to activate Quality of Service (QoS).
Back	Click this to return to the previous screen without saving.
Apply	Click this to save your changes.
Cancel	Click this to restore your previously saved settings.

8.4 The WPS Screen

Use this screen to configure WiFi Protected Setup (WPS) on your ZyXEL Device.

WPS allows you to quickly set up a wireless network with strong security, without having to configure security settings manually. Set up each WPS connection between two devices. Both devices must support WPS.

Click **Network > Wireless LAN > WPS**. The following screen displays.

Figure 52 Network > Wireless LAN > WPS

The following table describes the labels in this screen.

Table 33 Network > Wireless LAN > WPS

LABEL	DESCRIPTION
WPS Setup	
WPS Setup	Select the check box to activate WPS on the ZyXEL Device.

Table 33 Network > Wireless LAN > WPS

LABEL	DESCRIPTION
PIN Number	This shows the PIN (Personal Identification Number) of the ZyXEL Device. Enter this PIN in the configuration utility of the device you want to connect to using WPS. The PIN is not necessary when you use WPS push-button method.
Generate	Click this to have the ZyXEL Device create a new PIN.
WPS Status	This displays Configured when the ZyXEL Device has connected to a wireless network using WPS or Enable WPS is selected and wireless or wireless security settings have been changed. The current wireless and wireless security settings also appear in the screen. This displays Unconfigured if WPS is disabled and there is no wireless or wireless security changes on the ZyXEL Device or you click Release to remove the configured wireless and wireless security settings.
Release	This button is available when the WPS status is Configured . Click this button to remove all configured wireless and wireless security settings for WPS connections on the ZyXEL Device.
Apply	Click this to save your changes.
Refresh	Click this to restore your previously saved settings.

8.5 The WPS Station Screen

Use this screen to set up a WPS wireless network using either Push Button Configuration (PBC) or PIN Configuration.

Click **Network > Wireless LAN > WPS Station**. The following screen displays.

Figure 53 Network > Wireless LAN > WPS Station

AP More AP WPS **WPS Station** WDS Scheduling

Add Station by WPS

Click the below **Push Button** to add WPS stations to wireless network.

Or input station's PIN number:

Note:

1. The Push Button Configuration requires pressing a button on both the station and AP within 120 seconds.
2. You may find the PIN number in the station's utility.

The following table describes the labels in this screen.

Table 34 Network > Wireless LAN > WPS Station

LABEL	DESCRIPTION
Push Button	<p>Click this to add another WPS-enabled wireless device (within wireless range of the ZyXEL Device) to your wireless network. This button may either be a physical button on the outside of device, or a menu button similar to the Push Button on this screen.</p> <p>Note: You must press the other wireless device's WPS button within two minutes of pressing this button.</p>
Or input station's PIN number	<p>Enter the PIN of the device that you are setting up a WPS connection with and click Start to authenticate and add the wireless device to your wireless network.</p> <p>You can find the PIN either on the outside of the device, or by checking the device's settings.</p> <p>Note: You must also activate WPS on that device within two minutes to have it present its PIN to the ZyXEL Device.</p>

8.6 The WDS Screen

An AP using the Wireless Distribution System (WDS) can function as a wireless network bridge allowing you to wirelessly connect two wired network segments. The **WDS** screen allows you to configure the ZyXEL Device to connect to two or more APs wirelessly when WDS is enabled.

Use this screen to set up your WDS (Wireless Distribution System) links between the ZyXEL Device and other wireless APs. You need to know the MAC address of the peer device. Once the security settings of peer sides match one another, the connection between devices is made.

Note: WDS security is independent of the security settings between the ZyXEL Device and any wireless clients.

Note: At the time of writing, WDS is compatible with other ZyXEL APs only. Not all models support WDS links. Check your other AP's documentation.

Click **Network > Wireless LAN > WDS**. The following screen displays.

Figure 54 Network > Wireless LAN > WDS

The screenshot shows the 'WDS' configuration page. At the top, there are tabs for 'AP', 'More AP', 'WPS', 'WPS Station', 'WDS' (selected), and 'Scheduling'. Below the tabs is a 'Link Setup' section. Under 'WDS Security', there are two radio buttons: 'TKIP (ZyAIR Series Compatible)' (selected) and 'AES'. Below the security options is a table with four rows. Each row has a '#' column (1-4), an 'Active' checkbox, a 'Remote Bridge MAC Address' text box (all containing '00:00:00:00:00:00'), and a 'PSK' text box. At the bottom of the table are 'Apply' and 'Cancel' buttons.

The following table describes the labels in this screen.

Table 35 Network > Wireless LAN > WDS

LABEL	DESCRIPTION
WDS Security	Select the type of the key used to encrypt data between APs. All the wireless APs (including the ZyXEL Device) must use the same pre-shared key for data transmission. The option is only available when you set the Security mode to WPA(2) or WPA(2)-PSK in the Wireless LAN > AP screen.
TKIP	Select this to use TKIP (Temporal Key Integrity Protocol) encryption.
AES	Select this to use AES (Advanced Encryption Standard) encryption.
#	This is the index number of the individual WDS link.
Active	Select this to activate the link between the ZyXEL Device and the peer device to which this entry refers. When you do not select the check box this link is down.
Remote Bridge MAC Address	Type the MAC address of the peer device in a valid MAC address format (six hexadecimal character pairs, for example 12:34:56:78:9a:bc).
PSK	Enter a Pre-Shared Key (PSK) from 8 to 63 case-sensitive ASCII characters (including spaces and symbols).
Apply	Click this to save your changes.
Cancel	Click this to restore your previously saved settings.

8.7 The Scheduling Screen

Use the wireless LAN scheduling to configure the days you want to enable or disable the wireless LAN. Click **Network > Wireless LAN > Scheduling**. The following screen displays.

Figure 55 Network > Wireless LAN > Scheduling

Action	Day	Except for the following times (24-Hour Format)
<input type="radio"/> On <input checked="" type="radio"/> Off	<input type="checkbox"/> Everyday	00 (hour) 00 (min) ~ 00 (hour) 00 (min)
<input type="radio"/> On <input checked="" type="radio"/> Off	<input type="checkbox"/> Monday	00 (hour) 00 (min) ~ 00 (hour) 00 (min)
<input type="radio"/> On <input checked="" type="radio"/> Off	<input type="checkbox"/> Tuesday	00 (hour) 00 (min) ~ 00 (hour) 00 (min)
<input type="radio"/> On <input checked="" type="radio"/> Off	<input type="checkbox"/> Wednesday	00 (hour) 00 (min) ~ 00 (hour) 00 (min)
<input type="radio"/> On <input checked="" type="radio"/> Off	<input type="checkbox"/> Thursday	00 (hour) 00 (min) ~ 00 (hour) 00 (min)
<input type="radio"/> On <input checked="" type="radio"/> Off	<input type="checkbox"/> Friday	00 (hour) 00 (min) ~ 00 (hour) 00 (min)
<input type="radio"/> On <input checked="" type="radio"/> Off	<input type="checkbox"/> Saturday	00 (hour) 00 (min) ~ 00 (hour) 00 (min)
<input type="radio"/> On <input checked="" type="radio"/> Off	<input type="checkbox"/> Sunday	00 (hour) 00 (min) ~ 00 (hour) 00 (min)

Note: (Wireless signal is currently turned on/off by scheduling.)

Apply Reset

The following table describes the labels in this screen.

Table 36 Network > Wireless LAN > QoS

LABEL	DESCRIPTION
Enable Wireless LAN Scheduling	Select this box to activate wireless LAN scheduling on your ZyXEL Device.
Action	Select On or Off to enable or disable the wireless LAN.
Day	Check the day(s) you want to turn the wireless LAN on or off.
Except for the following times	Specify a time frame during which the schedule would apply. For example, if you set the time range from 12:00 to 23:00, the wireless LAN will be turned on only during this time period.
Apply	Click this to save your changes.
Reset	Click this to restore your previously saved settings.

8.8 Technical Reference

This section discusses wireless LANs in depth. For more information, see the appendix.

8.8.1 Wireless Network Overview

Wireless networks consist of wireless clients, access points and bridges.

- A wireless client is a radio connected to a user's computer.
- An access point is a radio with a wired connection to a network, which can connect with numerous wireless clients and let them access the network.
- A bridge is a radio that relays communications between access points and wireless clients, extending a network's range.

Traditionally, a wireless network operates in one of two ways.

- An "infrastructure" type of network has one or more access points and one or more wireless clients. The wireless clients connect to the access points.
- An "ad-hoc" type of network is one in which there is no access point. Wireless clients connect to one another in order to exchange information.

The following figure provides an example of a wireless network.

Figure 56 Example of a Wireless Network

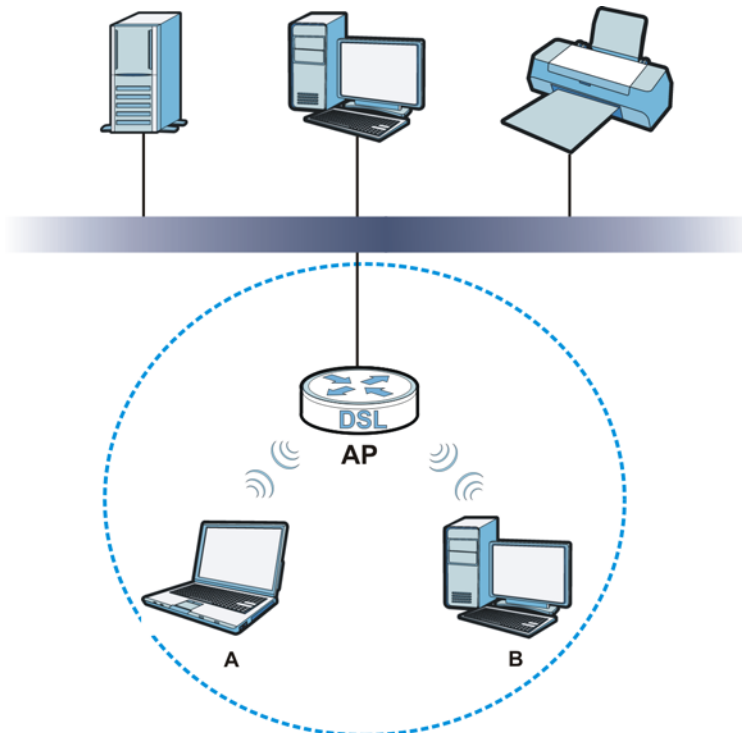

The wireless network is the part in the blue circle. In this wireless network, devices **A** and **B** use the access point (**AP**) to interact with the other devices (such as the printer) or with the Internet. Your ZyXEL Device is the AP.

Every wireless network must follow these basic guidelines.

- Every device in the same wireless network must use the same SSID.
The SSID is the name of the wireless network. It stands for Service Set Identifier.
- If two wireless networks overlap, they should use a different channel.
Like radio stations or television channels, each wireless network uses a specific channel, or frequency, to send and receive information.
- Every device in the same wireless network must use security compatible with the AP.
Security stops unauthorized devices from using the wireless network. It can also protect the information that is sent in the wireless network.

Radio Channels

In the radio spectrum, there are certain frequency bands allocated for unlicensed, civilian use. For the purposes of wireless networking, these bands are divided into numerous channels. This allows a variety of networks to exist in the same place without interfering with one another. When you create a network, you must select a channel to use.

Since the available unlicensed spectrum varies from one country to another, the number of available channels also varies.

8.8.2 Additional Wireless Terms

The following table describes some wireless network terms and acronyms used in the ZyXEL Device's Web Configurator.

Table 37 Additional Wireless Terms

TERM	DESCRIPTION
RTS/CTS Threshold	<p>In a wireless network which covers a large area, wireless devices are sometimes not aware of each other's presence. This may cause them to send information to the AP at the same time and result in information colliding and not getting through.</p> <p>By setting this value lower than the default value, the wireless devices must sometimes get permission to send information to the ZyXEL Device. The lower the value, the more often the devices must get permission.</p> <p>If this value is greater than the fragmentation threshold value (see below), then wireless devices never have to get permission to send information to the ZyXEL Device.</p>
Preamble	A preamble affects the timing in your wireless network. There are two preamble modes: long and short. If a device uses a different preamble mode than the ZyXEL Device does, it cannot communicate with the ZyXEL Device.
Authentication	The process of verifying whether a wireless device is allowed to use the wireless network.
Fragmentation Threshold	A small fragmentation threshold is recommended for busy networks, while a larger threshold provides faster performance if the network is not very busy.

8.8.3 Wireless Security Overview

By their nature, radio communications are simple to intercept. For wireless data networks, this means that anyone within range of a wireless network without security can not only read the data passing over the airwaves, but also join the network. Once an unauthorized person has access to the network, he or she can steal information or introduce malware (malicious software) intended to compromise the network. For these reasons, a variety of security systems have been developed to ensure that only authorized people can use a wireless data network, or understand the data carried on it.

These security standards do two things. First, they authenticate. This means that only people presenting the right credentials (often a username and password, or a "key" phrase) can access the network. Second, they encrypt. This means that the information sent over the air is encoded. Only people with the code key can understand the information, and only people who have been authenticated are given the code key.

These security standards vary in effectiveness. Some can be broken, such as the old Wired Equivalent Protocol (WEP). Using WEP is better than using no security at all, but it will not keep a determined attacker out. Other security standards are secure in themselves but can be broken if a user does not use them properly. For example, the WPA-PSK security standard is very secure if you use a long key which is difficult for an attacker's software to guess - for example, a twenty-letter long string of apparently random numbers and letters - but it is not very secure if you use a short key which is very easy to guess - for example, a three-letter word from the dictionary.

Because of the damage that can be done by a malicious attacker, it's not just people who have sensitive information on their network who should use security. Everybody who uses any wireless network should ensure that effective security is in place.

A good way to come up with effective security keys, passwords and so on is to use obscure information that you personally will easily remember, and to enter it in a way that appears random and does not include real words. For example, if your mother owns a 1970 Dodge Challenger and her favorite movie is Vanishing Point (which you know was made in 1971) you could use "70dodchal71vanpoi" as your security key.

The following sections introduce different types of wireless security you can set up in the wireless network.

8.8.3.1 SSID

Normally, the ZyXEL Device acts like a beacon and regularly broadcasts the SSID in the area. You can hide the SSID instead, in which case the ZyXEL Device does not broadcast the SSID. In addition, you should change the default SSID to something that is difficult to guess.

This type of security is fairly weak, however, because there are ways for unauthorized wireless devices to get the SSID. In addition, unauthorized wireless devices can still see the information that is sent in the wireless network.

8.8.3.2 MAC Address Filter

Every device that can use a wireless network has a unique identification number, called a MAC address.¹ A MAC address is usually written using twelve hexadecimal characters²; for example, 00A0C5000002 or 00:A0:C5:00:00:02. To get the MAC address for each device in the wireless network, see the device's User's Guide or other documentation.

-
1. Some wireless devices, such as scanners, can detect wireless networks but cannot use wireless networks. These kinds of wireless devices might not have MAC addresses.
 2. Hexadecimal characters are 0, 1, 2, 3, 4, 5, 6, 7, 8, 9, A, B, C, D, E, and F.

You can use the MAC address filter to tell the ZyXEL Device which devices are allowed or not allowed to use the wireless network. If a device is allowed to use the wireless network, it still has to have the correct information (SSID, channel, and security). If a device is not allowed to use the wireless network, it does not matter if it has the correct information.

This type of security does not protect the information that is sent in the wireless network. Furthermore, there are ways for unauthorized wireless devices to get the MAC address of an authorized device. Then, they can use that MAC address to use the wireless network.

8.8.3.3 User Authentication

Authentication is the process of verifying whether a wireless device is allowed to use the wireless network. You can make every user log in to the wireless network before using it. However, every device in the wireless network has to support IEEE 802.1x to do this.

For wireless networks, you can store the user names and passwords for each user in a RADIUS server. This is a server used in businesses more than in homes. If you do not have a RADIUS server, you cannot set up user names and passwords for your users.

Unauthorized wireless devices can still see the information that is sent in the wireless network, even if they cannot use the wireless network. Furthermore, there are ways for unauthorized wireless users to get a valid user name and password. Then, they can use that user name and password to use the wireless network.

8.8.3.4 Encryption

Wireless networks can use encryption to protect the information that is sent in the wireless network. Encryption is like a secret code. If you do not know the secret code, you cannot understand the message.

The types of encryption you can choose depend on the type of authentication. (See [Section 8.8.3.3 on page 120](#) for information about this.)

Table 38 Types of Encryption for Each Type of Authentication

	NO AUTHENTICATION	RADIUS SERVER
Weakest	No Security	WPA
↕	Static WEP	
↕	WPA-PSK	
Strongest	WPA2-PSK	WPA2

For example, if the wireless network has a RADIUS server, you can choose **WPA** or **WPA2**. If users do not log in to the wireless network, you can choose no encryption, **Static WEP**, **WPA-PSK**, or **WPA2-PSK**.

Usually, you should set up the strongest encryption that every device in the wireless network supports. For example, suppose you have a wireless network with the ZyXEL Device and you do not have a RADIUS server. Therefore, there is no authentication. Suppose the wireless network has two devices. Device A only supports WEP, and device B supports WEP and WPA. Therefore, you should set up **Static WEP** in the wireless network.

Note: It is recommended that wireless networks use **WPA-PSK**, **WPA**, or stronger encryption. The other types of encryption are better than none at all, but it is still possible for unauthorized wireless devices to figure out the original information pretty quickly.

When you select **WPA2** or **WPA2-PSK** in your ZyXEL Device, you can also select an option (**WPA compatible**) to support WPA as well. In this case, if some of the devices support WPA and some support WPA2, you should set up **WPA2-PSK** or **WPA2** (depending on the type of wireless network login) and select the **WPA compatible** option in the ZyXEL Device.

Many types of encryption use a key to protect the information in the wireless network. The longer the key, the stronger the encryption. Every device in the wireless network must have the same key.

8.8.4 Signal Problems

Because wireless networks are radio networks, their signals are subject to limitations of distance, interference and absorption.

Problems with distance occur when the two radios are too far apart. Problems with interference occur when other radio waves interrupt the data signal. Interference may come from other radio transmissions, such as military or air traffic control communications, or from machines that are coincidental emitters such as electric motors or microwaves. Problems with absorption occur when physical objects (such as thick walls) are between the two radios, muffling the signal.

8.8.5 BSS

A Basic Service Set (BSS) exists when all communications between wireless stations or between a wireless station and a wired network client go through one access point (AP).

Intra-BSS traffic is traffic between wireless stations in the BSS. When Intra-BSS traffic blocking is disabled, wireless station A and B can access the wired network

and communicate with each other. When Intra-BSS traffic blocking is enabled, wireless station A and B can still access the wired network but cannot communicate with each other.

Figure 57 Basic Service set

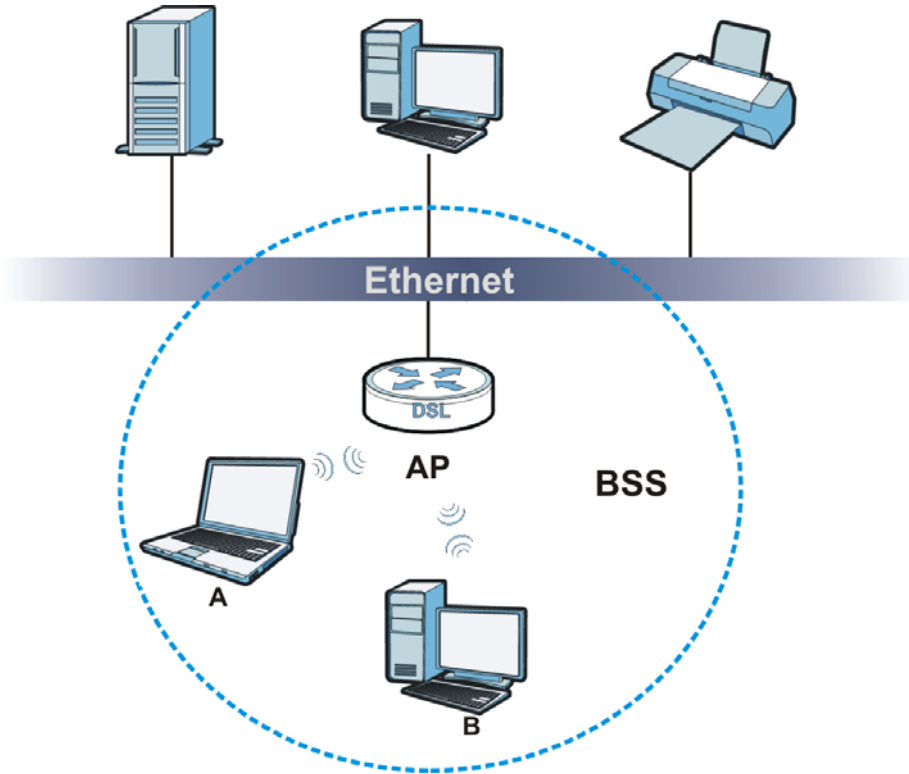

8.8.6 MBSSID

Traditionally, you need to use different APs to configure different Basic Service Sets (BSSs). As well as the cost of buying extra APs, there is also the possibility of channel interference. The ZyXEL Device's MBSSID (Multiple Basic Service Set Identifier) function allows you to use one access point to provide several BSSs simultaneously. You can then assign varying QoS priorities and/or security modes to different SSIDs.

Wireless devices can use different BSSIDs to associate with the same AP.

8.8.6.1 Notes on Multiple BSSs

- A maximum of eight BSSs are allowed on one AP simultaneously.
- You must use different keys for different BSSs. If two wireless devices have different BSSIDs (they are in different BSSs), but have the same keys, they may hear each other's communications (but not communicate with each other).
- MBSSID should not replace but rather be used in conjunction with 802.1x security.

8.8.7 Wireless Distribution System (WDS)

The ZyXEL Device can act as a wireless network bridge and establish WDS (Wireless Distribution System) links with other APs. You need to know the MAC addresses of the APs you want to link to. Once the security settings of peer sides match one another, the connection between devices is made.

At the time of writing, WDS security is compatible with other ZyXEL access points only. Refer to your other access point's documentation for details.

The following figure illustrates how WDS link works between APs. Notebook computer **A** is a wireless client connecting to access point **AP 1**. **AP 1** has no wired Internet connection, but it can establish a WDS link with access point **AP 2**, which has a wired Internet connection. When **AP 1** has a WDS link with **AP 2**, the notebook computer can access the Internet through **AP 2**.

Figure 58 WDS Link Example



8.8.8 WiFi Protected Setup (WPS)

Your ZyXEL Device supports WiFi Protected Setup (WPS), which is an easy way to set up a secure wireless network. WPS is an industry standard specification, defined by the WiFi Alliance.

WPS allows you to quickly set up a wireless network with strong security, without having to configure security settings manually. Each WPS connection works between two devices. Both devices must support WPS (check each device's documentation to make sure).

Depending on the devices you have, you can either press a button (on the device itself, or in its configuration utility) or enter a PIN (a unique Personal Identification Number that allows one device to authenticate the other) in each of the two devices. When WPS is activated on a device, it has two minutes to find another device that also has WPS activated. Then, the two devices connect and set up a secure network by themselves.

8.8.8.1 Push Button Configuration

WPS Push Button Configuration (PBC) is initiated by pressing a button on each WPS-enabled device, and allowing them to connect automatically. You do not need to enter any information.

Not every WPS-enabled device has a physical WPS button. Some may have a WPS PBC button in their configuration utilities instead of or in addition to the physical button.

Take the following steps to set up WPS using the button.

- 1 Ensure that the two devices you want to set up are within wireless range of one another.
- 2 Look for a WPS button on each device. If the device does not have one, log into its configuration utility and locate the button (see the device's User's Guide for how to do this - for the ZyXEL Device, see [Section 8.5 on page 112](#)).
- 3 Press the button on one of the devices (it doesn't matter which). For the ZyXEL Device you must press the WPS button for more than three seconds.
- 4 Within two minutes, press the button on the other device. The registrar sends the network name (SSID) and security key through an secure connection to the enrollee.

If you need to make sure that WPS worked, check the list of associated wireless clients in the AP's configuration utility. If you see the wireless client in the list, WPS was successful.

8.8.8.2 PIN Configuration

Each WPS-enabled device has its own PIN (Personal Identification Number). This may either be static (it cannot be changed) or dynamic (in some devices you can generate a new PIN by clicking on a button in the configuration interface).

Use the PIN method instead of the push-button configuration (PBC) method if you want to ensure that the connection is established between the devices you specify, not just the first two devices to activate WPS in range of each other. However, you need to log into the configuration interfaces of both devices to use the PIN method.

When you use the PIN method, you must enter the PIN from one device (usually the wireless client) into the second device (usually the Access Point or wireless router). Then, when WPS is activated on the first device, it presents its PIN to the second device. If the PIN matches, one device sends the network and security information to the other, allowing it to join the network.

Take the following steps to set up a WPS connection between an access point or wireless router (referred to here as the AP) and a client device using the PIN method.

- 1 Ensure WPS is enabled on both devices.
- 2 Access the WPS section of the AP's configuration interface. See the device's User's Guide for how to do this.
- 3 Look for the client's WPS PIN; it will be displayed either on the device, or in the WPS section of the client's configuration interface (see the device's User's Guide for how to find the WPS PIN - for the ZyXEL Device, see [Section 8.4 on page 111](#)).
- 4 Enter the client's PIN in the AP's configuration interface.
- 5 If the client device's configuration interface has an area for entering another device's PIN, you can either enter the client's PIN in the AP, or enter the AP's PIN in the client - it does not matter which.
- 6 Start WPS on both devices within two minutes.
- 7 Use the configuration utility to activate WPS, not the push-button on the device itself.
- 8 On a computer connected to the wireless client, try to connect to the Internet. If you can connect, WPS was successful.

If you cannot connect, check the list of associated wireless clients in the AP's configuration utility. If you see the wireless client in the list, WPS was successful.

The following figure shows a WPS-enabled wireless client (installed in a notebook computer) connecting to the WPS-enabled AP via the PIN method.

Figure 59 Example WPS Process: PIN Method

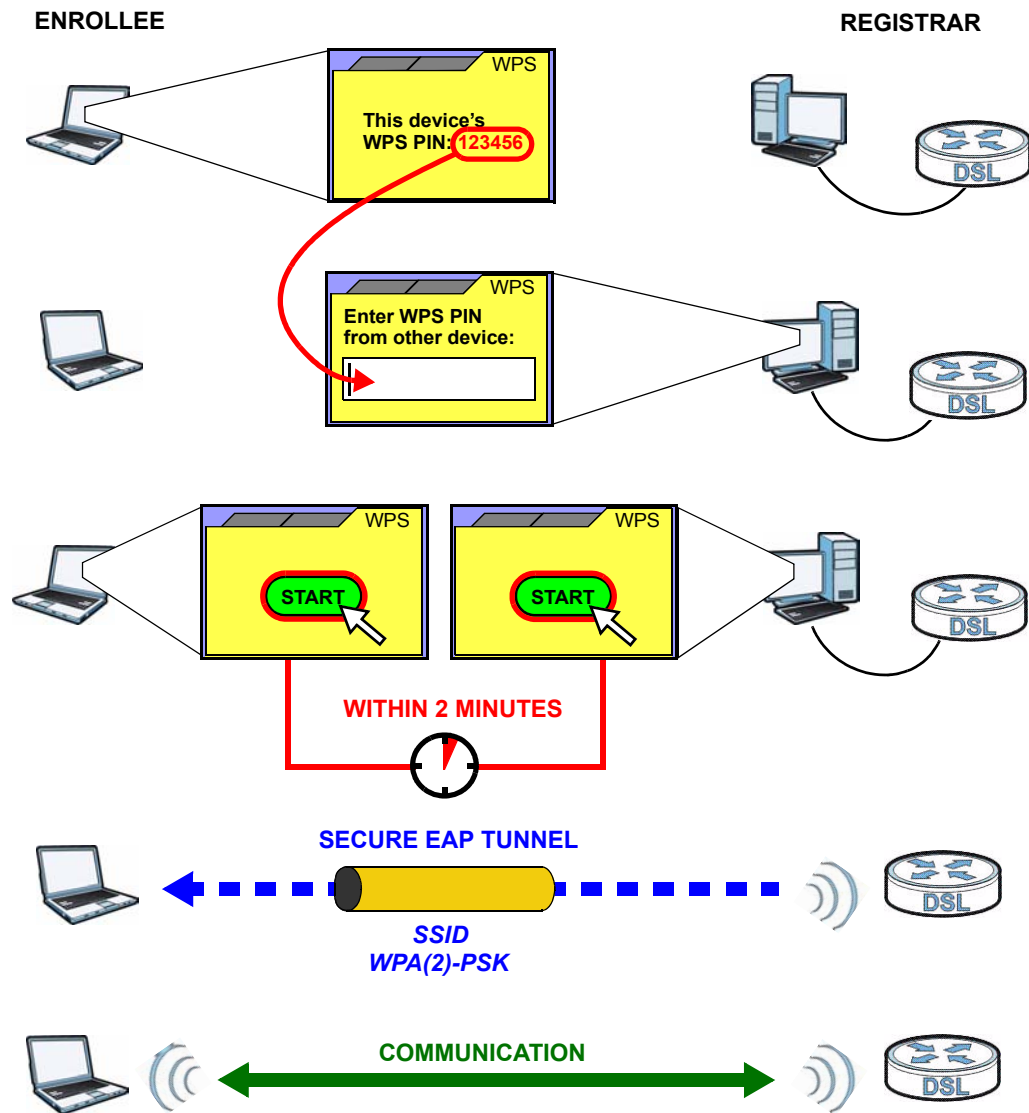

8.8.8.3 How WPS Works

When two WPS-enabled devices connect, each device must assume a specific role. One device acts as the registrar (the device that supplies network and security settings) and the other device acts as the enrollee (the device that receives network and security settings). The registrar creates a secure EAP (Extensible Authentication Protocol) tunnel and sends the network name (SSID) and the WPA-PSK or WPA2-PSK pre-shared key to the enrollee. Whether WPA-PSK or WPA2-PSK is used depends on the standards supported by the devices. If the registrar is already part of a network, it sends the existing information. If not, it generates the SSID and WPA(2)-PSK randomly.

The following figure shows a WPS-enabled client (installed in a notebook computer) connecting to a WPS-enabled access point.

Figure 60 How WPS works

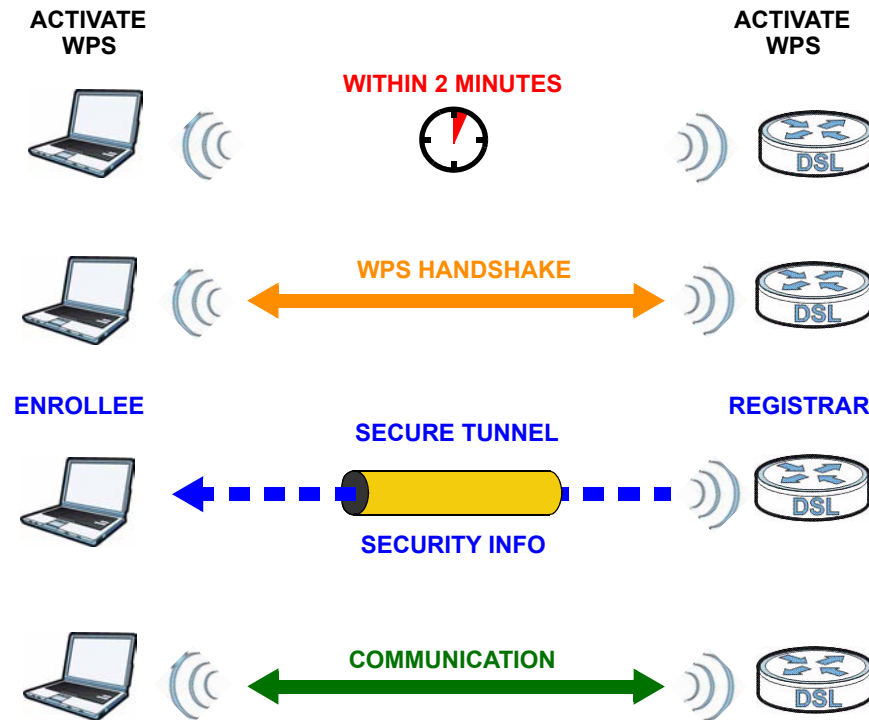

The roles of registrar and enrollee last only as long as the WPS setup process is active (two minutes). The next time you use WPS, a different device can be the registrar if necessary.

The WPS connection process is like a handshake; only two devices participate in each WPS transaction. If you want to add more devices you should repeat the process with one of the existing networked devices and the new device.

Note that the access point (AP) is not always the registrar, and the wireless client is not always the enrollee. All WPS-certified APs can be a registrar, and so can some WPS-enabled wireless clients.

By default, a WPS device is "unconfigured". This means that it is not part of an existing network and can act as either enrollee or registrar (if it supports both functions). If the registrar is unconfigured, the security settings it transmits to the enrollee are randomly-generated. Once a WPS-enabled device has connected to another device using WPS, it becomes "configured". A configured wireless client can still act as enrollee or registrar in subsequent WPS connections, but a configured access point can no longer act as enrollee. It will be the registrar in all subsequent WPS connections in which it is involved. If you want a configured AP to act as an enrollee, you must reset it to its factory defaults.

8.8.8.4 Example WPS Network Setup

This section shows how security settings are distributed in an example WPS setup.

The following figure shows an example network. In step **1**, both **AP1** and **Client 1** are unconfigured. When WPS is activated on both, they perform the handshake. In this example, **AP1** is the registrar, and **Client 1** is the enrollee. The registrar randomly generates the security information to set up the network, since it is unconfigured and has no existing information.

Figure 61 WPS: Example Network Step 1

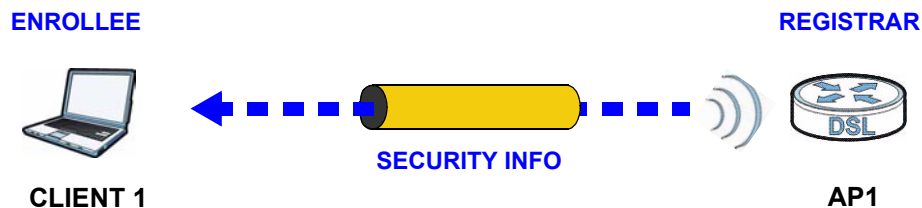

In step **2**, you add another wireless client to the network. You know that **Client 1** supports registrar mode, but it is better to use **AP1** for the WPS handshake with the new client since you must connect to the access point anyway in order to use the network. In this case, **AP1** must be the registrar, since it is configured (it already has security information for the network). **AP1** supplies the existing security information to **Client 2**.

Figure 62 WPS: Example Network Step 2

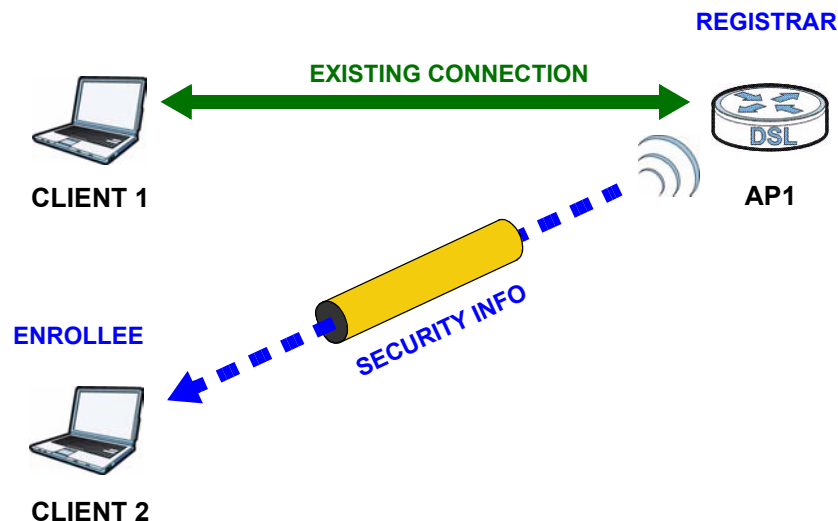

In step **3**, you add another access point (**AP2**) to your network. **AP2** is out of range of **AP1**, so you cannot use **AP1** for the WPS handshake with the new access

point. However, you know that **Client 2** supports the registrar function, so you use it to perform the WPS handshake instead.

Figure 63 WPS: Example Network Step 3

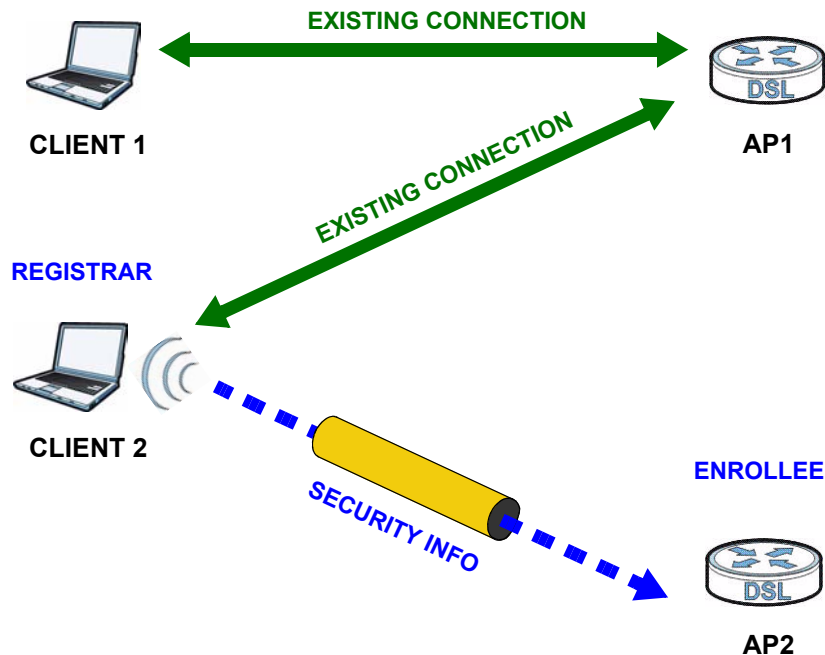

8.8.8.5 Limitations of WPS

WPS has some limitations of which you should be aware.

- WPS works in Infrastructure networks only (where an AP and a wireless client communicate). It does not work in Ad-Hoc networks (where there is no AP).
- When you use WPS, it works between two devices only. You cannot enroll multiple devices simultaneously, you must enroll one after the other.

For instance, if you have two enrollees and one registrar you must set up the first enrollee (by pressing the WPS button on the registrar and the first enrollee, for example), then check that it successfully enrolled, then set up the second device in the same way.

- WPS works only with other WPS-enabled devices. However, you can still add non-WPS devices to a network you already set up using WPS.

WPS works by automatically issuing a randomly-generated WPA-PSK or WPA2-PSK pre-shared key from the registrar device to the enrollee devices. Whether the network uses WPA-PSK or WPA2-PSK depends on the device. You can check the configuration interface of the registrar device to discover the key the network is using (if the device supports this feature). Then, you can enter the key into the non-WPS device and join the network as normal (the non-WPS device must also support WPA-PSK or WPA2-PSK).

- When you use the PBC method, there is a short period (from the moment you press the button on one device to the moment you press the button on the other device) when any WPS-enabled device could join the network. This is because the registrar has no way of identifying the “correct” enrollee, and cannot differentiate between your enrollee and a rogue device. This is a possible way for a hacker to gain access to a network.

You can easily check to see if this has happened. WPS works between only two devices simultaneously, so if another device has enrolled your device will be unable to enroll, and will not have access to the network. If this happens, open the access point’s configuration interface and look at the list of associated clients (usually displayed by MAC address). It does not matter if the access point is the WPS registrar, the enrollee, or was not involved in the WPS handshake; a rogue device must still associate with the access point to gain access to the network. Check the MAC addresses of your wireless clients (usually printed on a label on the bottom of the device). If there is an unknown MAC address you can remove it or reset the AP.

Network Address Translation (NAT)

9.1 Overview

This chapter discusses how to configure NAT on the ZyXEL Device. NAT (Network Address Translation - NAT, RFC 1631) is the translation of the IP address of a host in a packet, for example, the source address of an outgoing packet, used within one network to a different IP address known within another network.

9.1.1 What You Can Do in the NAT Screens

- Use the **General** screen ([Section 9.2 on page 133](#)) to configure the NAT setup settings.
- Use the **Port Forwarding** screen ([Section 9.3 on page 134](#)) to configure forward incoming service requests to the server(s) on your local network.
- Use the **Address Mapping** screen ([Section 9.4 on page 138](#)) to change your ZyXEL Device's address mapping settings.
- Use the **ALG** screen ([Section 9.5 on page 141](#)) to enable and disable the SIP (VoIP) ALG in the ZyXEL Device.

9.1.2 What You Need To Know

The following terms and concepts may help as you read this chapter.

Inside/Outside

Inside/outside denotes where a host is located relative to the ZyXEL Device, for example, the computers of your subscribers are the inside hosts, while the web servers on the Internet are the outside hosts.

Global/Local

Global/local denotes the IP address of a host in a packet as the packet traverses a router, for example, the local address refers to the IP address of a host when the

packet is in the local network, while the global address refers to the IP address of the host when the same packet is traveling in the WAN side.

NAT

In the simplest form, NAT changes the source IP address in a packet received from a subscriber (the inside local address) to another (the inside global address) before forwarding the packet to the WAN side. When the response comes back, NAT translates the destination address (the inside global address) back to the inside local address before forwarding it to the original inside host.

Port Forwarding

A port forwarding set is a list of inside (behind NAT on the LAN) servers, for example, web or FTP, that you can make visible to the outside world even though NAT makes your whole inside network appear as a single computer to the outside world.

SUA (Single User Account) Versus NAT

SUA (Single User Account) is a ZyNOS implementation of a subset of NAT that supports two types of mapping, **Many-to-One** and **Server**. The ZyXEL Device also supports **Full Feature** NAT to map multiple global IP addresses to multiple private LAN IP addresses of clients or servers using mapping types as outlined in [Table 46 on page 145](#).

- Choose **SUA Only** if you have just one public WAN IP address for your ZyXEL Device.
- Choose **Full Feature** if you have multiple public WAN IP addresses for your ZyXEL Device.

Finding Out More

See [Section 9.6 on page 142](#) for advanced technical information on NAT.

9.2 The General Setup Screen

Use this screen to activate NAT. Click **Network > NAT** to open the following screen.

Note: You must create a firewall rule in addition to setting up SUA/NAT, to allow traffic from the WAN to be forwarded through the ZyXEL Device.

Figure 64 Network > NAT > General

The following table describes the labels in this screen.

Table 39 Network > NAT > General

LABEL	DESCRIPTION
Active Network Address Translation	Select this check box to enable NAT.
SUA Only	Select this radio button if you have just one public WAN IP address for your ZyXEL Device.
Full Feature	Select this radio button if you have multiple public WAN IP addresses for your ZyXEL Device.
Max NAT/Firewall Session Per User	<p>When computers use peer to peer applications, such as file sharing applications, they need to establish NAT sessions. If you do not limit the number of NAT sessions a single client can establish, this can result in all of the available NAT sessions being used. In this case, no additional NAT sessions can be established, and users may not be able to access the Internet.</p> <p>Each NAT session establishes a corresponding firewall session. Use this field to limit the number of NAT/Firewall sessions client computers can establish through the ZyXEL Device.</p> <p>If your network has a small number of clients using peer to peer applications, you can raise this number to ensure that their performance is not degraded by the number of NAT sessions they can establish. If your network has a large number of users using peer to peer applications, you can lower this number to ensure no single client is exhausting all of the available NAT sessions.</p>

Table 39 Network > NAT > General (continued)

LABEL	DESCRIPTION
Apply	Click this to save your changes.
Cancel	Click this to restore your previously saved settings.

9.3 The Port Forwarding Screen

Note: This screen is available only when you select **SUA only** in the **NAT > General** screen.

Use this screen to forward incoming service requests to the server(s) on your local network.

You may enter a single port number or a range of port numbers to be forwarded, and the local IP address of the desired server. The port number identifies a service; for example, web service is on port 80 and FTP on port 21. In some cases, such as for unknown services or where one server can support more than one service (for example both FTP and web service), it might be better to specify a range of port numbers. You can allocate a server IP address that corresponds to a port or a range of ports.

The most often used port numbers and services are shown in [Appendix E on page 305](#). Please refer to RFC 1700 for further information about port numbers.

Note: Many residential broadband ISP accounts do not allow you to run any server processes (such as a Web or FTP server) from your location. Your ISP may periodically check for servers and may suspend your account if it discovers any active services at your location. If you are unsure, refer to your ISP.

Default Server IP Address

In addition to the servers for specified services, NAT supports a default server IP address. A default server receives packets from ports that are not specified in this screen.

Note: If you do not assign a **Default Server** IP address, the ZyXEL Device discards all packets received for ports that are not specified here or in the remote management setup.

Configuring Servers Behind Port Forwarding (Example)

Let's say you want to assign ports 21-25 to one FTP, Telnet and SMTP server (**A** in the example), port 80 to another (**B** in the example) and assign a default server IP address of 192.168.1.35 to a third (**C** in the example). You assign the LAN IP addresses and the ISP assigns the WAN IP address. The NAT network appears as a single host on the Internet.

Figure 65 Multiple Servers Behind NAT Example

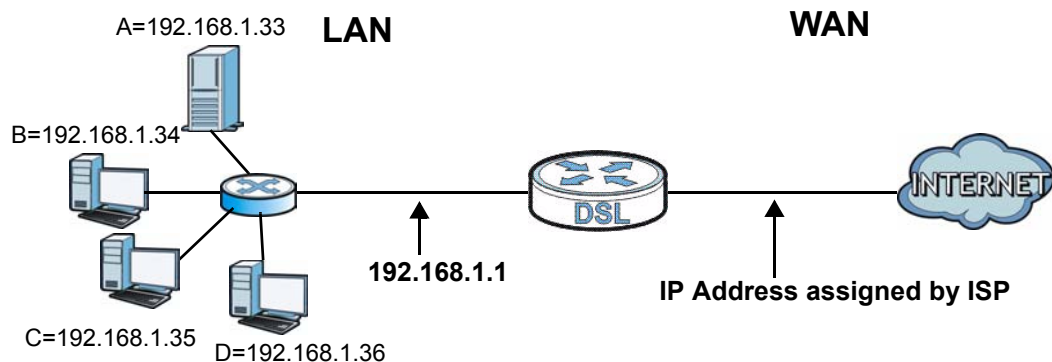

9.3.1 Configuring the Port Forwarding Screen

Click **Network > NAT > Port Forwarding** to open the following screen.

See [Appendix E on page 305](#) for port numbers commonly used for particular services.

Figure 66 Network > NAT > Port Forwarding

The screenshot shows the configuration interface for Port Forwarding. It includes a 'Default Server Setup' section with a 'Default Server' field set to 0.0.0.0. Below that is the 'Port Forwarding' section, which has a 'Service Name' dropdown set to 'WWW' and a 'Server IP Address' field set to 0.0.0.0. An 'Add' button is next to the Server IP field. A table below lists the port forwarding rules:

#	Active	Service Name	Start Port	End Port	Port Translation Start Port	End Port	Server IP Address	Modify
1	<input checked="" type="checkbox"/>	WWW	80	80	80	80	192.168.1.2	

At the bottom of the screen are 'Apply' and 'Cancel' buttons.

The following table describes the fields in this screen.

Table 40 Network > NAT > Port Forwarding

LABEL	DESCRIPTION
Default Server Setup	
Default Server	In addition to the servers for specified services, NAT supports a default server. A default server receives packets from ports that are not specified in this screen. If you do not assign a Default Server IP address, the ZyXEL Device discards all packets received for ports that are not specified here or in the remote management setup.
Port Forwarding	
Service Name	Select a service from the drop-down list box.
Server IP Address	Enter the IP address of the server for the specified service.
Add	Click this button to add a rule to the table below.
#	This is the rule index number (read-only).
Active	This field indicates whether the rule is active or not. Clear the check box to disable the rule. Select the check box to enable it.
Service Name	This is a service's name.
Start Port	This is the first port number that identifies a service.
End Port	This is the last port number that identifies a service.
Port Translation Start/End Port	This is the start/end port number that the device translates.
Server IP Address	This is the server's IP address.
Modify	Click the edit icon to go to the screen where you can edit the port forwarding rule. Click the delete icon to delete an existing port forwarding rule. Note that subsequent address mapping rules move up by one when you take this action.
Apply	Click this to save your changes.
Cancel	Click this to restore your previously saved settings.

9.3.2 The Port Forwarding Rule Edit Screen

Use this screen to edit a port forwarding rule. Click the rule's edit icon in the **Port Forwarding** screen to display the screen shown next.

Figure 67 Network > NAT > Port Forwarding: Edit

The following table describes the fields in this screen.

Table 41 Network > NAT > Port Forwarding: Edit

LABEL	DESCRIPTION
Rule Setup	
Active	Click this check box to enable the rule.
Service Name	Enter a name to identify this port-forwarding rule.
Start Port	Enter a port number in this field. To forward only one port, enter the port number again in the End Port field. To forward a series of ports, enter the start port number here and the end port number in the End Port field.
End Port	Enter a port number in this field. To forward only one port, enter the port number again in the Start Port field above and then enter it again in this field. To forward a series of ports, enter the last port number in a series that begins with the port number in the Start Port field above.
Server IP Address	Enter the inside IP address of the server here.
Port Translation Start / End Port	Enter the start port number here to which you want the device to translate the incoming port. For a range of ports, you only need to enter the first number of the range to which you want the incoming ports translated, the device automatically calculates the last port of the translated port range.
Back	Click this to return to the previous screen without saving.

Table 41 Network > NAT > Port Forwarding: Edit (continued)

LABEL	DESCRIPTION
Apply	Click this to save your changes.
Cancel	Click this to restore your previously saved settings.





















9.4 The Address Mapping Screen

Note: The **Address Mapping** screen is available only when you select **Full Feature** in the **NAT > General** screen.

Ordering your rules is important because the ZyXEL Device applies the rules in the order that you specify. When a rule matches the current packet, the ZyXEL Device takes the corresponding action and the remaining rules are ignored. If there are any empty rules before your new configured rule, your configured rule will be pushed up by that number of empty rules. For example, if you have already configured rules 1 to 6 in your current set and now you configure rule number 9. In the set summary screen, the new rule will be rule 7, not 9. Now if you delete rule 4, rules 5 to 7 will be pushed up by 1 rule, so old rules 5, 6 and 7 become new rules 4, 5 and 6.

To change your ZyXEL Device's address mapping settings, click **Network > NAT > Address Mapping** to open the following screen.

Figure 68 Network > NAT > Address Mapping

Address Mapping Rules						
#	Local Start IP	Local End IP	Global Start IP	Global End IP	Type	Modify
1	-	-	-	-	-	 
2	-	-	-	-	-	 
3	-	-	-	-	-	 
4	-	-	-	-	-	 
5	-	-	-	-	-	 
6	-	-	-	-	-	 
7	-	-	-	-	-	 
8	-	-	-	-	-	 
9	-	-	-	-	-	 
10	-	-	-	-	-	 

The following table describes the fields in this screen.

Table 42 Network > NAT > Address Mapping

LABEL	DESCRIPTION
#	This is the rule index number.
Local Start IP	This is the starting Inside Local IP Address (ILA). Local IP addresses are N/A for Server port mapping.
Local End IP	This is the end Inside Local IP Address (ILA). If the rule is for all local IP addresses, then this field displays 0.0.0.0 as the Local Start IP address and 255.255.255.255 as the Local End IP address. This field is N/A for One-to-one and Server mapping types.
Global Start IP	This is the starting Inside Global IP Address (IGA). Enter 0.0.0.0 here if you have a dynamic IP address from your ISP. You can only do this for Many-to-One and Server mapping types.
Global End IP	This is the ending Inside Global IP Address (IGA). This field is N/A for One-to-one , Many-to-One and Server mapping types.
Type	<p>1-1: One-to-one mode maps one local IP address to one global IP address. Note that port numbers do not change for the One-to-one NAT mapping type.</p> <p>M-1: Many-to-One mode maps multiple local IP addresses to one global IP address. This is equivalent to SUA (i.e., PAT, port address translation), ZyXEL's Single User Account feature that previous ZyXEL routers supported only.</p> <p>M-M Ov (Overload): Many-to-Many Overload mode maps multiple local IP addresses to shared global IP addresses.</p> <p>MM No (No Overload): Many-to-Many No Overload mode maps each local IP address to unique global IP addresses.</p> <p>Server: This type allows you to specify inside servers of different services behind the NAT to be accessible to the outside world.</p>
Modify	<p>Click the edit icon to go to the screen where you can edit the address mapping rule.</p> <p>Click the delete icon to delete an existing address mapping rule. Note that subsequent address mapping rules move up by one when you take this action.</p>

9.4.1 The Address Mapping Rule Edit Screen

Use this screen to edit an address mapping rule. Click the rule's edit icon in the **Address Mapping** screen to display the screen shown next.

Figure 69 Network > NAT > Address Mapping: Edit

The screenshot shows a web-based configuration interface titled "Edit Address Mapping Rule1". It contains the following fields and controls:

- Type:** A dropdown menu set to "One-to-One".
- Local Start IP:** A text input field containing "0.0.0.0".
- Local End IP:** A text input field containing "N/A".
- Global Start IP:** A text input field containing "0.0.0.0".
- Global End IP:** A text input field containing "N/A".
- Server Mapping Set:** A text input field containing "PVC0" with a blue link "Edit Details" next to it.

At the bottom of the form, there are three buttons: "Back", "Apply", and "Cancel".

The following table describes the fields in this screen.

Table 43 Network > NAT > Address Mapping: Edit

LABEL	DESCRIPTION
Type	<p>Choose the port mapping type from one of the following.</p> <p>One-to-One: One-to-One mode maps one local IP address to one global IP address. Note that port numbers do not change for One-to-one NAT mapping type.</p> <p>Many-to-One: Many-to-One mode maps multiple local IP addresses to one global IP address. This is equivalent to SUA (i.e., PAT, port address translation), ZyXEL's Single User Account feature that previous ZyXEL routers supported only.</p> <p>Many-to-Many Overload: Many-to-Many Overload mode maps multiple local IP addresses to shared global IP addresses.</p> <p>Many-to-Many No Overload: Many-to-Many No Overload mode maps each local IP address to unique global IP addresses.</p> <p>Server: This type allows you to specify inside servers of different services behind the NAT to be accessible to the outside world.</p>
Local Start IP	This is the starting local IP address (ILA). Local IP addresses are N/A for Server port mapping.
Local End IP	<p>This is the end local IP address (ILA). If your rule is for all local IP addresses, then enter 0.0.0.0 as the Local Start IP address and 255.255.255.255 as the Local End IP address.</p> <p>This field is N/A for One-to-One and Server mapping types.</p>
Global Start IP	This is the starting global IP address (IGA). Enter 0.0.0.0 here if you have a dynamic IP address from your ISP.

Table 43 Network > NAT > Address Mapping: Edit (continued)

LABEL	DESCRIPTION
Global End IP	This is the ending global IP address (IGA). This field is N/A for One-to-One , Many-to-One and Server mapping types.
Server Mapping Set Edit Details	Click this link to go to the Port Forwarding screen to edit a port forwarding set that you have selected in the Server Mapping Set field.
Back	Click this to return to the previous screen without saving.
Apply	Click this to save your changes.
Cancel	Click this to restore your previously saved settings.

9.5 The ALG Screen

Some NAT routers may include a SIP Application Layer Gateway (ALG). A SIP ALG allows SIP calls to pass through NAT by examining and translating IP addresses embedded in the data stream. When the ZyXEL Device registers with the SIP register server, the SIP ALG translates the ZyXEL Device's private IP address inside the SIP data stream to a public IP address. You do not need to use STUN or an outbound proxy if your ZyXEL Device is behind a SIP ALG.

Use this screen to enable and disable the SIP (VoIP) ALG in the ZyXEL Device. To access this screen, click **Network > NAT > ALG**.

Figure 70 Network > NAT > ALG

The following table describes the fields in this screen.

Table 44 Network > NAT > ALG

LABEL	DESCRIPTION
Enable SIP ALG	Select this to make sure SIP (VoIP) works correctly with port-forwarding and address-mapping rules.
Apply	Click this to save your changes.
Reset	Click this to restore your previously saved settings.

9.6 Technical Reference

This chapter contains more information regarding NAT.

9.6.1 NAT Definitions

Inside/outside denotes where a host is located relative to the ZyXEL Device, for example, the computers of your subscribers are the inside hosts, while the web servers on the Internet are the outside hosts.

Global/local denotes the IP address of a host in a packet as the packet traverses a router, for example, the local address refers to the IP address of a host when the packet is in the local network, while the global address refers to the IP address of the host when the same packet is traveling in the WAN side.

Note that inside/outside refers to the location of a host, while global/local refers to the IP address of a host used in a packet. Thus, an inside local address (ILA) is the IP address of an inside host in a packet when the packet is still in the local network, while an inside global address (IGA) is the IP address of the same inside host when the packet is on the WAN side. The following table summarizes this information.

Table 45 NAT Definitions

ITEM	DESCRIPTION
Inside	This refers to the host on the LAN.
Outside	This refers to the host on the WAN.
Local	This refers to the packet address (source or destination) as the packet travels on the LAN.
Global	This refers to the packet address (source or destination) as the packet travels on the WAN.

NAT never changes the IP address (either local or global) of an outside host.

9.6.2 What NAT Does

In the simplest form, NAT changes the source IP address in a packet received from a subscriber (the inside local address) to another (the inside global address) before forwarding the packet to the WAN side. When the response comes back, NAT translates the destination address (the inside global address) back to the inside local address before forwarding it to the original inside host. Note that the IP address (either local or global) of an outside host is never changed.

The global IP addresses for the inside hosts can be either static or dynamically assigned by the ISP. In addition, you can designate servers, for example, a web server and a telnet server, on your local network and make them accessible to the

outside world. If you do not define any servers (for Many-to-One and Many-to-Many Overload mapping – see [Table 46 on page 145](#)), NAT offers the additional benefit of firewall protection. With no servers defined, your ZyXEL Device filters out all incoming inquiries, thus preventing intruders from probing your network. For more information on IP address translation, refer to *RFC 1631, The IP Network Address Translator (NAT)*.

9.6.3 How NAT Works

Each packet has two addresses – a source address and a destination address. For outgoing packets, the ILA (Inside Local Address) is the source address on the LAN, and the IGA (Inside Global Address) is the source address on the WAN. For incoming packets, the ILA is the destination address on the LAN, and the IGA is the destination address on the WAN. NAT maps private (local) IP addresses to globally unique ones required for communication with hosts on other networks. It replaces the original IP source address (and TCP or UDP source port numbers for Many-to-One and Many-to-Many Overload NAT mapping) in each packet and then forwards it to the Internet. The ZyXEL Device keeps track of the original addresses and port numbers so incoming reply packets can have their original values restored. The following figure illustrates this.

Figure 71 How NAT Works

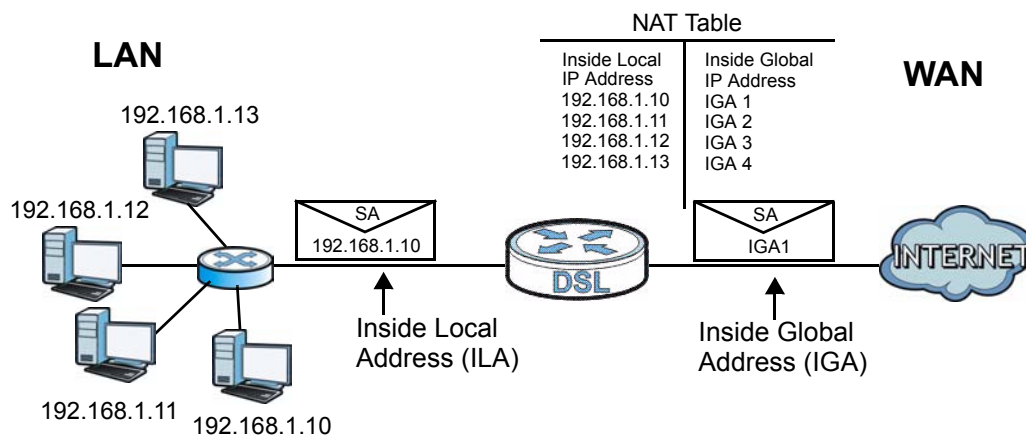

9.6.4 NAT Application

The following figure illustrates a possible NAT application, where three inside LANs (logical LANs using IP alias) behind the ZyXEL Device can communicate with three distinct WAN networks.

Figure 72 NAT Application With IP Alias

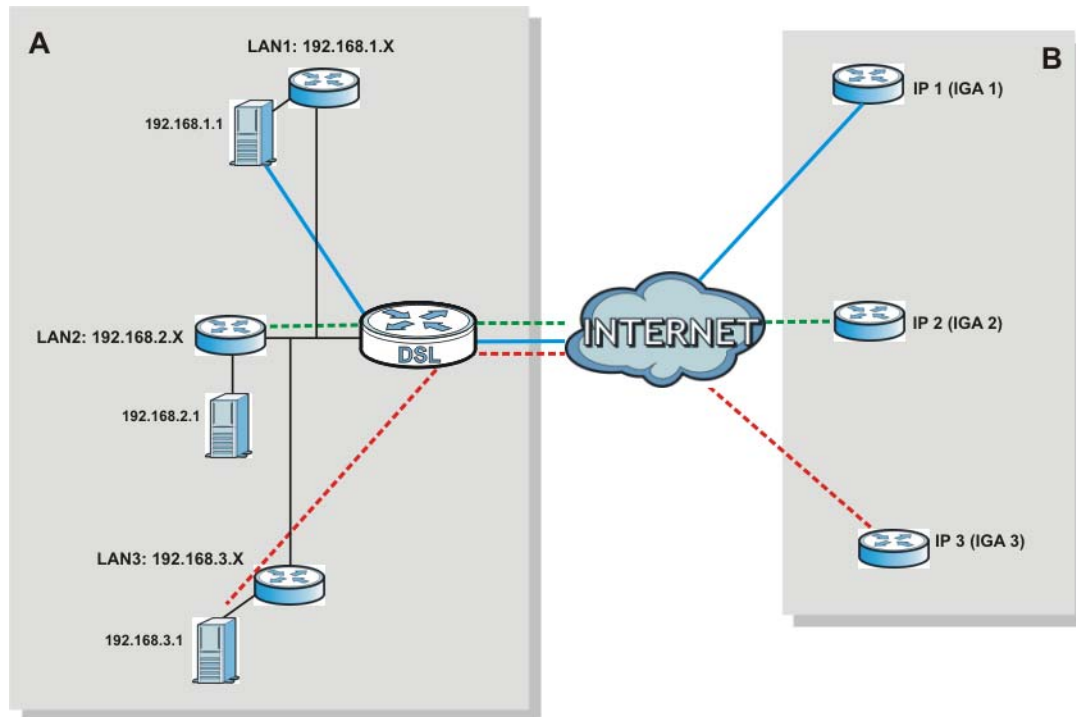

9.6.5 NAT Mapping Types

NAT supports five types of IP/port mapping. They are:

- **One to One:** In One-to-One mode, the ZyXEL Device maps one local IP address to one global IP address.
- **Many to One:** In Many-to-One mode, the ZyXEL Device maps multiple local IP addresses to one global IP address. This is equivalent to SUA (for instance, PAT, port address translation), ZyXEL's Single User Account feature that previous ZyXEL routers supported (the **SUA Only** option in today's routers).
- **Many to Many Overload:** In Many-to-Many Overload mode, the ZyXEL Device maps the multiple local IP addresses to shared global IP addresses.
- **Many-to-Many No Overload:** In Many-to-Many No Overload mode, the ZyXEL Device maps each local IP address to a unique global IP address.
- **Server:** This type allows you to specify inside servers of different services behind the NAT to be accessible to the outside world.

Port numbers do NOT change for **One-to-One** and **Many-to-Many No Overload** NAT mapping types.

The following table summarizes these types.

Table 46 NAT Mapping Types

TYPE	IP MAPPING
One-to-One	ILA1 \leftrightarrow IGA1
Many-to-One (SUA/PAT)	ILA1 \leftrightarrow IGA1 ILA2 \leftrightarrow IGA1 ...
Many-to-Many Overload	ILA1 \leftrightarrow IGA1 ILA2 \leftrightarrow IGA2 ILA3 \leftrightarrow IGA1 ILA4 \leftrightarrow IGA2 ...
Many-to-Many No Overload	ILA1 \leftrightarrow IGA1 ILA2 \leftrightarrow IGA2 ILA3 \leftrightarrow IGA3 ...
Server	Server 1 IP \leftrightarrow IGA1 Server 2 IP \leftrightarrow IGA1 Server 3 IP \leftrightarrow IGA1

Firewall

10.1 Overview

This chapter shows you how to enable the ZyXEL Device firewall. Use the firewall to protect your ZyXEL Device and network from attacks by hackers on the Internet and control access to it. By default the firewall:

- allows traffic that originates from your LAN computers to go to all other networks.
- blocks traffic that originates on other networks from going to the LAN.
- blocks SYN and port scanner attacks.

By default, the ZyXEL Device blocks DDOS, LAND and Ping of Death attacks whether the firewall is enabled or disabled.

10.1.1 What You Can Do in the Firewall Screens

Use the **Firewall** screen ([Section 10.2 on page 149](#)) to enable firewall and/or SPI on the ZyXEL Device.

10.1.2 What You Need to Know

The following terms and concepts may help as you read this chapter.

SYN Attack

A SYN attack floods a targeted system with a series of SYN packets. Each packet causes the targeted system to issue a SYN-ACK response. While the targeted system waits for the ACK that follows the SYN-ACK, it queues up all outstanding SYN-ACK responses on a backlog queue. SYN-ACKs are moved off the queue only when an ACK comes back or when an internal timer terminates the three-way handshake. Once the queue is full, the system will ignore all incoming SYN requests, making the system unavailable for legitimate users.

DoS

Denials of Service (DoS) attacks are aimed at devices and networks with a connection to the Internet. Their goal is not to steal information, but to disable a device or network so users no longer have access to network resources. The ZyXEL Device is pre-configured to automatically detect and thwart all known DoS attacks.

DDoS

A DDoS attack is one in which multiple compromised systems attack a single target, thereby causing denial of service for users of the targeted system.

LAND Attack

In a LAND attack, hackers flood SYN packets into the network with a spoofed source IP address of the target system. This makes it appear as if the host computer sent the packets to itself, making the system unavailable while the target system tries to respond to itself.

Ping of Death

Ping of Death uses a "ping" utility to create and send an IP packet that exceeds the maximum 65,536 bytes of data allowed by the IP specification. This may cause systems to crash, hang or reboot.

SPI

Stateful Packet Inspection (SPI) tracks each connection crossing the firewall and makes sure it is valid. Filtering decisions are based not only on rules but also context. For example, traffic from the WAN may only be allowed to cross the firewall in response to a request from the LAN.

10.2 The Firewall Screen

Use this screen to enable firewall and/or SPI. Click **Advanced Setup > Firewall** to display the following screen.

Figure 73 Advanced Setup > Firewall

The screenshot shows a web-based configuration interface for the Firewall. At the top, there is a blue header with the word 'Firewall'. Below this is a light gray bar with the word 'Firewall' again. The main content area contains two rows of radio buttons. The first row is for 'Firewall' and the second is for 'SPI'. Each row has two radio buttons: 'Enabled' and 'Disabled'. In both rows, the 'Disabled' radio button is selected. Below these options is a yellow note icon followed by the text: 'Note : (WARNING: If You enabled SPI, all traffics initiated from WAN would be blocked, including DMZ, Virtual Server, and ACL WAN side.)'. At the bottom of the screen, there are two buttons: 'Apply' and 'Cancel'.

The following table describes the labels in this screen.

Table 47 Advanced > Firewall

LABEL	DESCRIPTION
Firewall	Use this field to enable or disable firewall on your ZyXEL Device.
SPI	Use this field to enable or disable SPI on your ZyXEL Device.
SAVE	Click this to save your changes.
CANCEL	Click this to restore your previously saved settings.

Enabling SPI blocks all traffic initiated from the WAN side, including the DMZ, virtual server and ACL on the WAN side.

11.1 Overview

This chapter introduces three types of filters supported by the ZyXEL Device. You can configure rules to restrict traffic by IP addresses, MAC addresses, application types and/or URLs.

11.1.1 What You Can Do in the Filter Screens

- Use the **URL Filter** screen ([Section 11.2 on page 152](#)) to block access to web sites.
- Use the **Application Filter** screen ([Section 11.3 on page 153](#)) to allow or deny traffic from certain types of applications.
- Use the **IP/MAC Filter** screen ([Section 11.4 on page 154](#)) to create IP/MAC filter rules.

11.1.2 What You Need to Know

The following terms and concepts may help as you read this chapter.

URL

The URL (Uniform Resource Locator) identifies and helps locates resources on a network. On the Internet the URL is the web address that you type in the address bar of your Internet browser, for example "http://www.zyxel.com".

IP/MAC Filter Structure

An IP/MAC filter set consists of one or more filter rules. The ZyXEL Device allows you to configure up to twelve filter sets with six rules in each set, for a total of 72 filter rules in the system.

11.2 The URL Filter Screen

Use this screen to block websites by URL. Click **Security > Filter > URL Filter**. The screen appears as shown.

Figure 74 Security > Filter > URL Filter

The screenshot shows the 'URL Filter' configuration interface. It includes a 'URL Filter Editing' section with radio buttons for 'Activated' and 'Deactivated' (selected), a 'URL Index' dropdown menu set to '1', and a text input field for 'URL'. Below is a 'URL Filter Listing' table with 16 rows, each with a '#' column and a 'URL' column. At the bottom are 'Apply', 'Delete', and 'Cancel' buttons.

The following table describes the labels in this screen.

Table 48 Access Management > Filter (URL)

LABEL	DESCRIPTION
URL Filter Editing	
Active	Use this field to enable or disable the URL filter.
URL Index	Select the index number of the filter.
URL Filter Listing	
Index	This is the index number of the filter rule.
URL	This is the URL you have configured the ZyXEL Device to block.
Apply	Click this to save your changes.
Delete	Click this to remove the filter rule.
Cancel	Click this to restore your previously saved settings.

11.3 The Application Filter Screen

Use this screen to allow or deny traffic for certain types of applications. The application filter provides a convenient way to manage the use of various applications on the network.

Click **Security > Filter > Application Filter**. The screen appears as shown.

Figure 75 Security > Filter > Application Filter

The following table describes the labels in this screen.

Table 49 Access Management > Filter (Application)

LABEL	DESCRIPTION
Application Filter Editing	
Application Filter	Use this field to enable or disable the application filter.
ICQ	Use this field to allow or deny ICQ traffic.
MSN	Use this field to allow or deny MSN traffic.
YMSG	Use this field to allow or deny Yahoo Messenger traffic
Apply	Click this to save your changes.
Cancel	Click this to restore your previously saved settings.

11.4 The IP/MAC Filter Screen

Use this screen to create and apply IP/MAC filters. Click **Security > Filter > IP/MAC Filter**. The screen appears as shown.

Figure 76 Security > Filter > IP/MAC Filter

The screenshot shows the 'IP/MAC Filter' configuration screen. It has three tabs: 'URL Filter', 'Application Filter', and 'IP/MAC Filter'. The 'IP/MAC Filter' tab is active. The screen is divided into three sections:

- IP / MAC Filter Set Editing:**
 - IP / MAC Filter Set Index: 1
 - Interface: PVC0
 - Direction: Both
- IP / MAC Filter Rule Editing:**
 - IP / MAC Filter Rule Index: 1
 - Rule Type: IP
 - Active: Yes No
 - Source IP Address: (0.0.0.0 means Don't care)
 - Subnet Mask:
 - Port Number: 0 (0 means Don't care)
 - Destination IP Address: (0.0.0.0 means Don't care)
 - Subnet Mask:
 - Port Number: 0 (0 means Don't care)
 - Protocol: TCP
 - Rule Unmatched: Forward
- IP Filter Listing:**
 - IP Filter Set Index: 1
 - Interface: -
 - Direction: -

#	Active	Src Address/Mask	Dest IP/Mask	Src Port	Dest Port	Protocol	Unmatched
1	-	-	-	-	-	-	-
2	-	-	-	-	-	-	-
3	-	-	-	-	-	-	-
4	-	-	-	-	-	-	-
5	-	-	-	-	-	-	-
6	-	-	-	-	-	-	-

Buttons: SAVE, DELETE, CANCEL

The following table describes the labels in this screen.

Table 50 Access Management > Filter (IP/MAC)

LABEL	DESCRIPTION
IP/MAC Filter Set Editing	
IP/MAC Filter Set Index	Select the index number of the filter set.
Interface	Select the PVC to which to apply the filter.
Direction	Apply the filter to Both , Incoming or Outgoing traffic direction.
IP/MAC Filter Rule Editing	
IP/MAC Filter Rule Index	Select the index number of the filter rule.

Table 50 Access Management > Filter (IP/MAC) (continued)

LABEL	DESCRIPTION
Rule Type	Select IP or MAC type to configure the rule. Use the IP Filter to block traffic by IP addresses. Use the MAC Filter to block traffic by MAC address.
Active	Use this field to enable or disable the rule.
Source IP Address	Enter the source IP address of the packets you wish to filter. This field is ignored if it is 0.0.0.0.
Subnet Mask	Enter the IP subnet mask for the source IP address
Port Number	Enter the source port of the packets that you wish to filter. The range of this field is 0 to 65535. This field is ignored if it is 0.
Destination IP Address	Enter the destination IP address of the packets you wish to filter. This field is ignored if it is 0.0.0.0.
Subnet Mask	Enter the IP subnet mask for the destination IP address.
Port Number	Enter the destination port of the packets that you wish to filter. The range of this field is 0 to 65535. This field is ignored if it is 0.
Protocol	Select ICMP , TCP or UDP for the upper layer protocol.
MAC Address	This field is only available when you select MAC in the Rule Type field. Enter the MAC address of the packets you wish to filter.
Rule Unmatched	Select the action for a packet not matching the rule. Select Forward to forward traffic immediately and skip checking the remaining rules. Select Next to check the next rule.
IP/MAC Filter Listing	
IP/MAC Filter Set Index	Select the index number of the filter set from the drop-down list box.
Interface	This is the interface that the filter set applies to.
Direction	The filter set applies to this traffic direction.
#	This is the index number of the rule in a filter set.
Active	This field shows whether the rule is activated.
Src Address/Mask	This is the source IP address and subnet mask when you select IP as the rule type. This is the MAC address when you select MAC as the rule type.
Dest IP/Mask	This is the destination IP address and subnet mask.
Src Port	This is the source port number.
Dest Port	This is the destination port number.
Protocol	This is the upper layer protocol.
Unmatched	When a packet doesn't match the rule, this is the action the ZyXEL Device takes on the packet.
SAVE	Click this to save your changes.

Table 50 Access Management > Filter (IP/MAC) (continued)

LABEL	DESCRIPTION
DELETE	Click this to remove the filter rule.
CANCEL	Click this to restore your previously saved settings.

Static Route

12.1 Overview

The ZyXEL Device usually uses the default gateway to route outbound traffic from computers on the LAN to the Internet. To have the ZyXEL Device send data to devices not reachable through the default gateway, use static routes.

For example, the next figure shows a computer (**A**) connected to the ZyXEL Device's LAN interface. The ZyXEL Device routes most traffic from **A** to the Internet through the ZyXEL Device's default gateway (**R1**). You create one static route to connect to services offered by your ISP behind router **R2**. You create another static route to communicate with a separate network behind a router **R3** connected to the LAN.

Figure 77 Example of Static Routing Topology

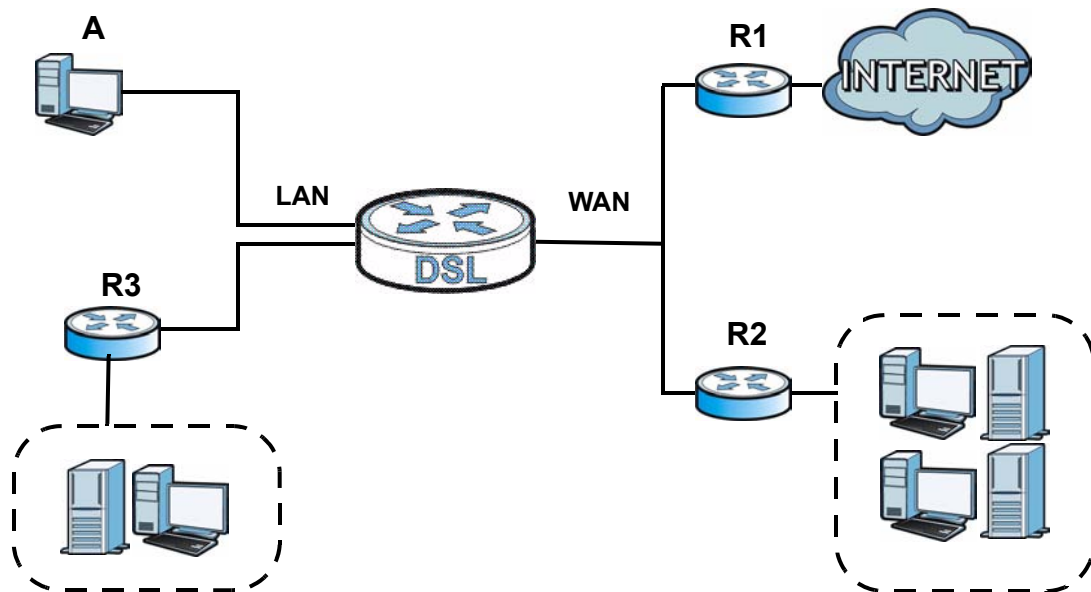

12.1.1 What You Can Do in the Static Route Screens

Use the **Static Route** screens (Section 12.2 on page 158) to view and configure IP static routes on the ZyXEL Device.

12.2 The Static Route Screen

Use this screen to view the static route rules. Click **Advanced > Static Route** to open the **Static Route** screen.

Figure 78 Advanced > Static Route

Static Route				
Static Route Rules				
#	Destination	Netmask	Gateway	Modify
1	0.0.0.0	0.0.0.0	0.0.0.0	✎ 🗑
2	0.0.0.0	0.0.0.0	0.0.0.0	✎ 🗑
3	0.0.0.0	0.0.0.0	0.0.0.0	✎ 🗑
4	0.0.0.0	0.0.0.0	0.0.0.0	✎ 🗑
5	0.0.0.0	0.0.0.0	0.0.0.0	✎ 🗑
6	0.0.0.0	0.0.0.0	0.0.0.0	✎ 🗑
7	0.0.0.0	0.0.0.0	0.0.0.0	✎ 🗑
8	0.0.0.0	0.0.0.0	0.0.0.0	✎ 🗑
9	0.0.0.0	0.0.0.0	0.0.0.0	✎ 🗑
10	0.0.0.0	0.0.0.0	0.0.0.0	✎ 🗑
11	0.0.0.0	0.0.0.0	0.0.0.0	✎ 🗑
12	0.0.0.0	0.0.0.0	0.0.0.0	✎ 🗑
13	0.0.0.0	0.0.0.0	0.0.0.0	✎ 🗑
14	0.0.0.0	0.0.0.0	0.0.0.0	✎ 🗑
15	0.0.0.0	0.0.0.0	0.0.0.0	✎ 🗑
16	0.0.0.0	0.0.0.0	0.0.0.0	✎ 🗑

The following table describes the labels in this screen.

Table 51 Advanced > Static Route

LABEL	DESCRIPTION
#	This is the number of an individual static route.
Destination	This parameter specifies the IP network address of the final destination. Routing is always based on network number.
Netmask	This parameter specifies the IP network subnet mask of the final destination.
Gateway	This is the IP address of the gateway. The gateway is a router or switch on the same network segment as the device's LAN or WAN port. The gateway helps forward packets to their destinations.

Table 51 Advanced > Static Route

LABEL	DESCRIPTION
Modify	Click the Edit icon to go to the screen where you can set up a static route on the ZyXEL Device. Click the Remove icon to remove a static route from the ZyXEL Device. A window displays asking you to confirm that you want to delete the route.
Apply	Click this to save your changes.
Cancel	Click this to restore your previously saved settings.

12.2.1 Static Route Edit

Use this screen to configure the required information for a static route. Select a static route index number and click **Edit**. The screen shown next appears.

Figure 79 Advanced > Static Route: Edit

The following table describes the labels in this screen.

Table 52 Advanced > Static Route: Edit

LABEL	DESCRIPTION
Static Route Setup	
Destination IP Address	This parameter specifies the IP network address of the final destination. Routing is always based on network number. If you need to specify a route to a single host, use a subnet mask of 255.255.255.255 in the subnet mask field to force the network number to be identical to the host ID.
IP Subnet Mask	Enter the IP subnet mask here.
Gateway IP Address	Enter the IP address of the gateway. The gateway is a router or switch on the same network segment as the device's LAN or WAN port. The gateway helps forward packets to their destinations.
Back	Click this to return to the previous screen without saving.
Apply	Click this to save your changes.
Cancel	Click this to restore your previously saved settings.

802.1Q/1P

13.1 Overview

This chapter describes how to configure the 802.1Q/1P settings.

A Virtual Local Area Network (VLAN) allows a physical network to be partitioned into multiple logical networks. A VLAN group can be treated as an individual device. Each group can have its own rules about where and how to forward traffic. You can assign any ports on the ZyXEL Device to a VLAN group and configure the settings for the group. You may also set the priority level for traffic transmitted through the ports.

Figure 80 802.1Q/1P

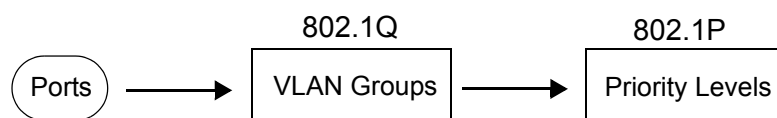

13.1.1 What You Can Do in the 802.1Q/1P Screens

- Use the **Group Setting** screen ([Section 13.2 on page 163](#)) to activate 802.1Q/1P, specify the management VLAN group, display the VLAN groups and configure the settings for each VLAN group.
- Use the **Port Setting** screen ([Section 13.3 on page 166](#)) to configure the PVID for each port.

13.1.2 What You Need to Know

The following terms and concepts may help as you read this chapter.

IEEE 802.1P Priority

IEEE 802.1P specifies the user priority field and defines up to eight separate traffic types by inserting a tag into a MAC-layer frame that contains bits to define class of service.

IEEE 802.1Q Tagged VLAN

Tagged VLAN uses an explicit tag (VLAN ID) in the MAC header to identify the VLAN membership of a frame across bridges - they are not confined to the device on which they were created. The VLAN ID associates a frame with a specific VLAN and provides the information that devices need to process the frame across the network.

PVC

A virtual circuit is a logical point-to-point circuit between customer sites. Permanent means that the circuit is preprogrammed by the carrier as a path through the network. It does not need to be set up or torn down for each session.

Forwarding Tagged and Untagged Frames

Each port on the device is capable of passing tagged or untagged frames. To forward a frame from an 802.1Q VLAN-aware device to an 802.1Q VLAN-unaware device, the ZyXEL Device first decides where to forward the frame and then strips off the VLAN tag. To forward a frame from an 802.1Q VLAN-unaware device to an 802.1Q VLAN-aware switch, the ZyXEL Device first decides where to forward the frame, and then inserts a VLAN tag reflecting the ingress port's default VID. The default PVID is VLAN 1 for all ports, but this can be changed.

Whether to tag an outgoing frame depends on the setting of the egress port on a per-VLAN, per-port basis (recall that a port can belong to multiple VLANs). If the tagging on the egress port is enabled for the VID of a frame, then the frame is transmitted as a tagged frame; otherwise, it is transmitted as an untagged frame.

13.2 The 802.1Q/1P Group Setting Screen

Use this screen to activate 802.1Q/1P and display the VLAN groups.

Note: If the WAN interface in the VLAN group is not the default router, you need to create a static route to communicate with the WAN.

Click **Advanced > 802.1Q/1P** to display the following screen.

Figure 81 Advanced > 802.1Q/1P > Group Setting

#	Active	VID	Port Number								Modify							
			LAN	SSID1	SSID2	SSID3	SSID4	PVC1	PVC2	PVC3		PVC4	PVC5	PVC6	PVC7	PVC8		
1	Yes	1	U	U	-	-	-	U	U	U	U	U	U	U	U	U		
2	-	-	-	-	-	-	-	-	-	-	-	-	-	-	-	-	-	
3	-	-	-	-	-	-	-	-	-	-	-	-	-	-	-	-	-	
4	-	-	-	-	-	-	-	-	-	-	-	-	-	-	-	-	-	
5	-	-	-	-	-	-	-	-	-	-	-	-	-	-	-	-	-	
6	-	-	-	-	-	-	-	-	-	-	-	-	-	-	-	-	-	
7	-	-	-	-	-	-	-	-	-	-	-	-	-	-	-	-	-	
8	-	-	-	-	-	-	-	-	-	-	-	-	-	-	-	-	-	
9	-	-	-	-	-	-	-	-	-	-	-	-	-	-	-	-	-	
10	-	-	-	-	-	-	-	-	-	-	-	-	-	-	-	-	-	
11	-	-	-	-	-	-	-	-	-	-	-	-	-	-	-	-	-	
12	-	-	-	-	-	-	-	-	-	-	-	-	-	-	-	-	-	

The following table describes the labels in this screen.

Table 53 Advanced > 802.1Q/1P > Group Setting

LABEL	DESCRIPTION
802.1Q/1P	
Active	Select this check box to activate the 802.1P/1Q feature.
Summary	
#	This field displays the index number of the VLAN group.
Active	This field displays whether 802.1P/1Q is active for the VLAN group.
VID	This field displays the ID number of the VLAN group.

Table 53 Advanced > 802.1Q/1P > Group Setting (continued)

LABEL	DESCRIPTION
Port Number	These columns display the VLAN's settings for each port. A tagged port is marked as T , an untagged port is marked as U and ports not participating in a VLAN are marked as "-".
Modify	Click the Edit button to configure the the ports in the VLAN group. Click the Remove button to delete the VLAN group.
Apply	Click this to save your changes.
Cancel	Click this to restore your previously saved settings.

13.2.1 Editing 802.1Q/1P Group Setting

Use this screen to configure the settings for each VLAN group.

In the **802.1Q/1P** screen, click the **Edit** button from the **Modify** filed to display the following screen.

Figure 82 Advanced > 802.1Q/1P > Group Setting > Edit

Group Setup

Active

VLAN ID

Ports	Control	Tx Tag
LAN	<input checked="" type="radio"/> Fixed <input type="radio"/> Forbidden	<input type="checkbox"/> Tx Tagging
SSID1	<input checked="" type="radio"/> Fixed <input type="radio"/> Forbidden	<input type="checkbox"/> Tx Tagging
SSID2	<input type="radio"/> Fixed <input checked="" type="radio"/> Forbidden	<input type="checkbox"/> Tx Tagging
SSID3	<input type="radio"/> Fixed <input checked="" type="radio"/> Forbidden	<input type="checkbox"/> Tx Tagging
SSID4	<input type="radio"/> Fixed <input checked="" type="radio"/> Forbidden	<input type="checkbox"/> Tx Tagging
PVC1	<input checked="" type="radio"/> Fixed <input type="radio"/> Forbidden	<input type="checkbox"/> Tx Tagging
PVC2	<input checked="" type="radio"/> Fixed <input type="radio"/> Forbidden	<input type="checkbox"/> Tx Tagging
PVC3	<input checked="" type="radio"/> Fixed <input type="radio"/> Forbidden	<input type="checkbox"/> Tx Tagging
PVC4	<input checked="" type="radio"/> Fixed <input type="radio"/> Forbidden	<input type="checkbox"/> Tx Tagging
PVC5	<input checked="" type="radio"/> Fixed <input type="radio"/> Forbidden	<input type="checkbox"/> Tx Tagging
PVC6	<input checked="" type="radio"/> Fixed <input type="radio"/> Forbidden	<input type="checkbox"/> Tx Tagging
PVC7	<input checked="" type="radio"/> Fixed <input type="radio"/> Forbidden	<input type="checkbox"/> Tx Tagging
PVC8	<input checked="" type="radio"/> Fixed <input type="radio"/> Forbidden	<input type="checkbox"/> Tx Tagging

Back Apply Cancel

The following table describes the labels in this screen.

Table 54 Advanced > 802.1Q/1P > Group Setting > Edit

LABEL	DESCRIPTION
Active	Select this check box to activate the group setting.
VLAN ID	Assign a VLAN ID for the VLAN group. The valid VID range is between 1 and 4094.
Default Gateway	Select the default gateway for the VLAN group.
Ports	This field displays the types of ports available to join the VLAN group.
Control	Select Fixed for the port to be a permanent member of the VLAN group. Select Forbidden if you want to prohibit the port from joining the VLAN group.
Tx Tag	Select Tx Tagging if you want the port to tag all outgoing traffic transmitted through this VLAN. You select this if you want to create VLANs across different devices and not just the ZyxEL Device.
Back	Click this to return to the previous screen without saving.
Apply	Click this to save your changes.
Cancel	Click this to restore your previously saved settings.

13.3 The 802.1Q/1P Port Setting Screen

Use this screen to configure the PVID for each port. Click **Advanced** > **802.1Q/1P** > **Port Setting** to display the following screen.

Figure 83 Advanced > 802.1Q/1P > Port Setting

Ports	802.1Q PVID
LAN	1
SSID1	1
SSID2	1
SSID3	1
SSID4	1
PVC1	1
PVC2	1
PVC3	1
PVC4	1
PVC5	1
PVC6	1
PVC7	1
PVC8	1

The following table describes the labels in this screen.

Table 55 Advanced > 802.1Q/1P > Port Setting

LABEL	DESCRIPTION
Ports	This field displays the types of ports available to join the VLAN group.
802.1Q PVID	Assign a VLAN ID for the port. The valid VID range is between 1 and 4094. The ZyXEL Device assigns the PVID to untagged frames or priority-tagged frames received on this port.
Apply	Click this to save your changes.
Cancel	Click this to restore your previously saved settings.

Quality of Service (QoS)

14.1 Overview

Use the **QoS** screen to set up your ZyXEL Device to use QoS for traffic management.

Quality of Service (QoS) refers to both a network's ability to deliver data with minimum delay, and the networking methods used to control bandwidth. QoS allows the ZyXEL Device to group and prioritize application traffic and fine-tune network performance.

Without QoS, all traffic data are equally likely to be dropped when the network is congested. This can cause a reduction in network performance and make the network inadequate for time-critical applications such as video-on-demand.

The ZyXEL Device assigns each packet a priority and then queues the packet accordingly. Packets assigned with a high priority are processed more quickly than those with low priorities if there is congestion, allowing time-sensitive applications to flow more smoothly. Time-sensitive applications include both those that require a low level of latency (delay) and a low level of jitter (variations in delay) such as Voice over IP (VoIP) or Internet gaming, and those for which jitter alone is a problem such as Internet radio or streaming video.

In the following figure, your Internet connection has an upstream transmission speed of 50 Mbps. You configure a classifier to assign the highest priority queue (6) to VoIP traffic from the LAN interface, so that voice traffic would not get delayed when there is network congestion. Traffic from the boss's IP address (192.168.1.23 for example) is mapped to queue 5. Traffic that does not match

these two classes are assigned priority queue based on the internal QoS mapping table on the ZyXEL Device.

Figure 84 QoS Example

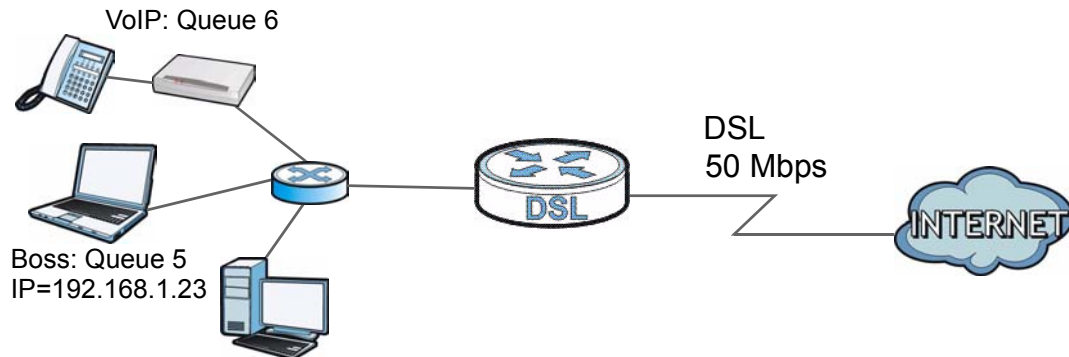

14.1.1 What You Can Do in the QoS Screens

- Use the **QoS** screen ([Section 14.2 on page 169](#)) to configure QoS settings on the ZyXEL Device.
- Use the **QoS Settings Summary** screen ([Section 14.2.1 on page 171](#)) to check the summary of QoS rules and actions you configured for the ZyXEL Device.

14.1.2 What You Need to Know

The following terms and concepts may help as you read this chapter.

802.1p

QoS is used to prioritize source-to-destination traffic flows. All packets in the same flow are given the same priority. 802.1p is a way of managing traffic in a network by grouping similar types of traffic together and treating each type as a class. You can use 802.1p to give different priorities to different packet types.

Tagging and Marking

In a QoS class, you can configure whether to add or change the DiffServ Code Point (DSCP) value, IEEE 802.1p priority level and VLAN ID number in a matched packet. When the packet passes through a compatible network, the networking device, such as a backbone switch, can provide specific treatment or service based on the tag or marker.

Finding Out More

See [Section 14.3 on page 172](#) for advanced technical information on QoS.

14.2 The QoS Screen

Use this screen to enable or disable QoS and have the ZyXEL Device assign priority levels to traffic according to the port range, IEEE 802.1p priority level and/or IP precedence.

Click **Advanced Setup > QoS** to open the screen as shown next.

Figure 85 Advanced Setup > QoS

The screenshot displays the 'Advanced Setup > QoS' configuration interface. It is divided into three main sections: General, Rule, and Action.

- General:**
 - Quality of Service:** QoS is set to Deactivated. A 'Summary' button labeled 'QoS Settings Summary' is available.
- Rule:**
 - Rule Index:** 1
 - Active:** Activated, Deactivated
 - Application:** [Empty dropdown]
 - Physical Ports:** WLAN, Enet1
 - Destination MAC:** [Empty text field]
 - IP:** [Empty text field]
 - Mask:** [Empty text field]
 - Port Range:** [Empty text field]
 - Source MAC:** [Empty text field]
 - IP:** [Empty text field]
 - Mask:** [Empty text field]
 - Port Range:** [Empty text field]
 - Protocol ID:** [Empty dropdown]
 - Vlan ID Range:** [Empty text field]
 - IPP/DS Field:** IPP/TOS, DSCP
 - IP Precedence Range:** [Empty dropdown]
 - Type of Service:** [Empty dropdown]
 - DSCP Range:** [Empty text field] (Value Range: 0 ~ 63)
 - 802.1p:** [Empty dropdown]
- Action:**
 - IPP/DS Field:** IPP/TOS, DSCP
 - IP Precedence Remarking:** [Empty dropdown]
 - Type of Service Remarking:** [Empty dropdown]
 - DSCP Remarking:** [Empty text field] (Value Range: 0 ~ 63)
 - 802.1p Remarking:** [Empty dropdown]
 - Queue #:** [Empty dropdown]

At the bottom of the screen, there are three buttons: **ADD**, **DELETE**, and **CANCEL**.

The following table describes the labels in this screen.

Table 56 Advanced Setup > QoS

LABEL	DESCRIPTION
Quality of Service	
QoS	Use this field to turn on QoS to improve your network performance. You can give priority to traffic that the ZyXEL Device forwards out through the WAN interface. Give high priority to voice and video to make them run more smoothly. Similarly, give low priority to many large file downloads so that they do not reduce the quality of other applications.
Summary	Click this to open a summary table showing the QoS settings. See Section 14.2.1 on page 171 for more details.
Rule	
Rule Index	Select the rule's index number from the drop-down list box.
Active	Use this field to enable or disable the rule.
Application	Select an application from the drop-down list box. The Destination Port Range and Protocol ID fields may change depending on the type of applications you choose.
Physical Ports	Select Enet1 to apply the rule to the Ethernet port or WLAN to apply the rule to wireless traffic.
Destination MAC	Type a destination MAC address here. QoS is then applied to traffic containing this destination MAC address. Leave it blank to apply the rule to all MAC addresses.
IP	Enter a destination IP address in dotted decimal notation. QoS is then applied to traffic containing this destination IP address. A blank destination IP address means any destination IP address.
Mask	Enter a destination subnet mask here.
Port Range	Either use the default value set by the application you choose, or enter the port number to which the rule should be applied.
Source MAC	Type a source MAC address here. QoS is then applied to traffic containing this source MAC address. Leave it blank to apply the rule to all MAC addresses.
IP	Enter a source IP address in dotted decimal notation. QoS is then applied to traffic containing this source IP address. A blank source IP address means any source IP address.
Mask	Enter a source subnet mask here.
Port Range	Enter the port number to which the rule should be applied. 0 means any source port number. See Appendix E on page 305 for some common services and port numbers.
Protocol ID	Select an IP protocol type from the drop-down list box.
Vlan ID Range	Enter the source VLAN ID in this field.
IPP/DS Field	Select IPP/TOS to specify an IP precedence range and type of services. Select DSCP to specify a DiffServ Code Point (DSCP) range.
IP Precedence Range	Enter a range from 0 to 7 for IP precedence. Zero is the lowest priority and seven is the highest.

Table 56 Advanced Setup > QoS

LABEL	DESCRIPTION
Type of Service	Select a type of service from the drop-down list box. Available options are: Normal service, Minimize delay, Maximize throughput, Maximize reliability and Minimize monetary cost.
DSCP Range	Specify a DSCP number between 0 and 63 in this field.
802.1p	Select a priority level (0 to 7) from the drop-down list box.
Action	
IPP/DS Field	Select IPP/TOS to specify an IP precedence range and type of services. Select DSCP to specify a DiffServ Code Point (DSCP) range.
IP Precedence Remarking	Enter a range from 0 to 7 to re-assign IP precedence to matched traffic. Zero is the lowest priority and seven is the highest.
Type of Service Remarking	Select a type of service to re-assign the priority level to matched traffic. Available options are: Normal service, Minimize delay, Maximize throughput, Maximize reliability and Minimize monetary cost.
DSCP Remarking	Specify a DSCP number between 0 and 63 to re-assign the priority level to matched traffic.
802.1p Remarking	Select a priority level (0 to 7) to re-assign the priority level to matched traffic.
Queue #	Specify a Low, Medium, High or Highest queue tag to matched traffic. Traffic assigned to a higher queue gets through faster while traffic in lower queues is dropped when there is network congestion.
ADD	Click this to add the rule.
DELETE	Click this to remove the rule.
CANCEL	Click this to restore previously saved settings.

14.2.1 The QoS Settings Summary Screen

Use this screen to display a summary of rules and actions configured for the ZyXEL Device. In the **Advanced > QoS** screen, click the **QoS Settings Summary** button to open the following screen.

Figure 86 Advanced Setup > QoS > QoS Settings Summary

ZyXEL											
QoS Settings Summary											
Rules								Actions			
#	Active	Physical Ports	Destination	Source	Protocol ID	VLAN ID	IPP/TOS (DSCP)	802.1p	IPP/TOS (DSCP) Remarking	802.1p Remarking	Queue #
			MAC IP/Mask Port Range	MAC IP/Mask Port Range							
-	N	-	-	-	-	-	-	-	-	-	-

e:ethernet, w:wlan, NS: Normal service, MD: Minimize delay, MT: Maximize throughput, MR: Maximize reliability, MC: Minimize monetary cost, HH: Highest, H: High, M: Medium, L: Low.

The following table describes the labels in this screen.

Table 57 Advanced Setup > QoS > QoS Settings Summary

LABEL	DESCRIPTION
Rules	
#	This is the rule's index number.
Active	This shows whether the rule is enabled or disabled.
Physical Ports	This is the physical port associated with the rule.
Destination MAC and IP/Mask Port Ranges	This is the port range for destination MAC address and IP address.
Source MAC and IP/Mask Port Ranges	This is the port range for source MAC address and IP address.
Protocol ID	This is the protocol ID associated with the rule.
VLAN ID	This is the VLAN ID associated with the rule.
IPP/TOS (DSCP)	This shows the IPP/TOS or DSCP settings.
802.1p	This is the 802.1p priority level.
Actions	
IPP/TOS (DSCP) Remarking	The ZyXEL Device re-assigns the priority values specified in this field to matched traffic.
802.1p Remarking	The ZyXEL Device re-assigns the priority levels specified in this field to matched traffic.
Queue #	The ZyXEL Device assigns the queue level specified in this field to matched traffic.

14.3 Technical Reference

This section provides some technical background information about the topics covered in this chapter.

14.3.1 IEEE 802.1p

IEEE 802.1p specifies the user priority field and defines up to eight separate traffic types. The following table describes the traffic types defined in the IEEE 802.1d standard (which incorporates the 802.1p).

Table 58 IEEE 802.1p Priority Level and Traffic Type

PRIORITY LEVEL	TRAFFIC TYPE
Level 7	Typically used for network control traffic such as router configuration messages.
Level 6	Typically used for voice traffic that is especially sensitive to jitter (jitter is the variations in delay).

Table 58 IEEE 802.1p Priority Level and Traffic Type

PRIORITY LEVEL	TRAFFIC TYPE
Level 5	Typically used for video that consumes high bandwidth and is sensitive to jitter.
Level 4	Typically used for controlled load, latency-sensitive traffic such as SNA (Systems Network Architecture) transactions.
Level 3	Typically used for "excellent effort" or better than best effort and would include important business traffic that can tolerate some delay.
Level 2	This is for "spare bandwidth".
Level 1	This is typically used for non-critical "background" traffic such as bulk transfers that are allowed but that should not affect other applications and users.
Level 0	Typically used for best-effort traffic.

14.3.2 IP Precedence

Similar to IEEE 802.1p prioritization at layer-2, you can use IP precedence to prioritize packets in a layer-3 network. IP precedence uses three bits of the eight-bit ToS (Type of Service) field in the IP header. There are eight classes of services (ranging from zero to seven) in IP precedence. Zero is the lowest priority level and seven is the highest.

14.3.3 Automatic Priority Queue Assignment

If you enable QoS on the ZyXEL Device, the ZyXEL Device can automatically base on the IEEE 802.1p priority level, IP precedence and/or packet length to assign priority to traffic which does not match a class.

The following table shows you the internal layer-2 and layer-3 QoS mapping on the ZyXEL Device. On the ZyXEL Device, traffic assigned to higher priority queues gets through faster while traffic in lower index queues is dropped if the network is congested.

Table 59 Internal Layer2 and Layer3 QoS Mapping

PRIORITY QUEUE	LAYER 2	LAYER 3		
	IEEE 802.1P USER PRIORITY (ETHERNET PRIORITY)	TOS (IP PRECEDENCE)	DSCP	IP PACKET LENGTH (BYTE)
0	1	0	000000	
1	2			
2	0	0	000000	>1100

Table 59 Internal Layer2 and Layer3 QoS Mapping

PRIORITY QUEUE	LAYER 2	LAYER 3		
	IEEE 802.1P USER PRIORITY (ETHERNET PRIORITY)	TOS (IP PRECEDENCE)	DSCP	IP PACKET LENGTH (BYTE)
3	3	1	001110 001100 001010 001000	250~1100
4	4	2	010110 010100 010010 010000	
5	5	3	011110 011100 011010 011000	<250
6	6	4	100110 100100 100010 100000	
		5	101110 101000	
7	7	6	110000	
		7	111000	

Dynamic DNS Setup

15.1 Overview

Dynamic DNS allows you to update your current dynamic IP address with one or many dynamic DNS services so that anyone can contact you (in NetMeeting, CU-SeeMe, etc.). You can also access your FTP server or Web site on your own computer using a domain name (for instance myhost.dhs.org, where myhost is a name of your choice) that will never change instead of using an IP address that changes each time you reconnect. Your friends or relatives will always be able to call you even if they don't know your IP address.

First of all, you need to have registered a dynamic DNS account with www.dyndns.org. This is for people with a dynamic IP from their ISP or DHCP server that would still like to have a domain name. The Dynamic DNS service provider will give you a password or key.

15.1.1 What You Can Do in the DDNS Screen

Use the **Dynamic DNS** screen ([Section 15.2 on page 176](#)) to enable DDNS and configure the DDNS settings on the ZyXEL Device.

15.1.2 What You Need To Know

The following terms and concepts may help as you read this chapter.

DYNDNS Wildcard

Enabling the wildcard feature for your host causes *.yourhost.dyndns.org to be aliased to the same IP address as yourhost.dyndns.org. This feature is useful if you want to be able to use, for example, www.yourhost.dyndns.org and still reach your hostname.

If you have a private WAN IP address, then you cannot use Dynamic DNS.

15.2 The Dynamic DNS Screen

Use this screen to change your ZyXEL Device's DDNS. Click **Advanced > Dynamic DNS**. The screen appears as shown.

Figure 87 Advanced > Dynamic DNS

The screenshot shows a web-based configuration interface for Dynamic DNS. The main heading is 'Dynamic DNS Setup'. Below this, there are several configuration options:

- Active Dynamic DNS
- Service Provider: www.dyndns.org
- Host Name: [Text Input Field]
- User Name: [Text Input Field]
- Password: [Text Input Field]
- Enable Wildcard Option

At the bottom of the form, there are two buttons: 'Apply' and 'Cancel'.

The following table describes the fields in this screen.

Table 60 Advanced > Dynamic DNS

LABEL	DESCRIPTION
Dynamic DNS Setup	
Active Dynamic DNS	Select this check box to use dynamic DNS.
Service Provider	This is the name of your Dynamic DNS service provider.
Dynamic DNS Type	Select the type of service that you are registered for from your Dynamic DNS service provider.
Host Name	Type the domain name assigned to your ZyXEL Device by your Dynamic DNS provider. You can specify up to two host names in the field separated by a comma (",").
User Name	Type your user name.
Password	Type the password assigned to you.
Enable Wildcard Option	Select the check box to enable DynDNS Wildcard.
Apply	Click this to save your changes.
Cancel	Click this to restore your previously saved settings.

Remote Management

16.1 Overview

Remote management allows you to determine which services/protocols can access which ZyXEL Device interface (if any) from which computers.

The following figure shows remote management of the ZyXEL Device coming in from the WAN.

Figure 88 Remote Management From the WAN

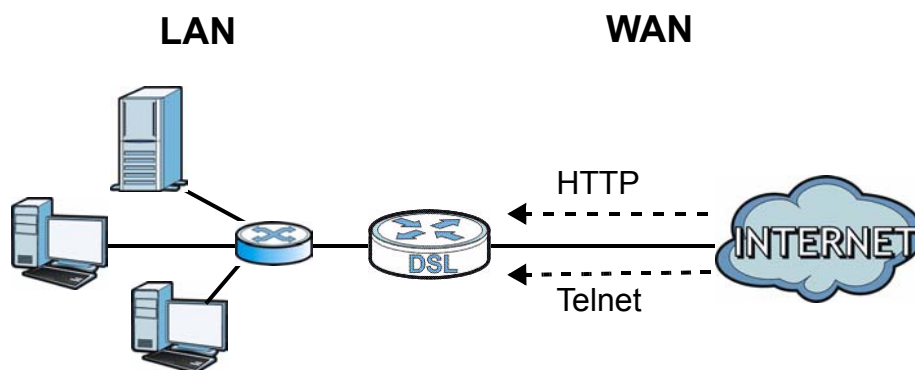

Note: When you configure remote management to allow management from the WAN, you still need to configure a firewall rule to allow access.

You may manage your ZyXEL Device from a remote location via:

- Internet (WAN only)
- LAN only
- WLAN only
- LAN and WAN
- LAN and WLAN
- WLAN and WAN
- ALL (WAN, LAN and WLAN)
- None (Disable)

To disable remote management of a service, select **Disable** in the corresponding **Service Access** field.

You may only have one remote management session running at a time. The ZyXEL Device automatically disconnects a remote management session of lower priority when another remote management session of higher priority starts. The priorities for the different types of remote management sessions are as follows.

- 1 Telnet
- 2 HTTP

16.1.1 What You Can Do in the Remote Management Screens

- Use the **WWW** screen ([Section 16.2 on page 179](#)) to configure through which interface(s) and from which IP address(es) users can use HTTP to manage the ZyXEL Device.
- Use the **Telnet** screen ([Section 16.3 on page 180](#)) to configure through which interface(s) and from which IP address(es) users can use Telnet to manage the ZyXEL Device.
- Use the **FTP** screen ([Section 16.4 on page 181](#)) to configure through which interface(s) and from which IP address(es) users can use FTP to access the ZyXEL Device.
- Use the **SNMP** screen ([Section 16.5 on page 182](#)) to change your ZyXEL Device's SNMP settings.
- Use the **DNS** screen ([Section 16.6 on page 184](#)) to configure through which interface(s) and from which IP address(es) users can send DNS queries to the ZyXEL Device.
- Use the **ICMP** screen ([Section 16.7 on page 185](#)) to set whether or not your ZyXEL Device will respond to pings and probes for services that you have not made available.

16.1.2 What You Need to Know

The following terms and concepts may help as you read this chapter.

Remote Management Limitations

Remote management does not work when:

- You have not enabled that service on the interface in the corresponding remote management screen.
- You have disabled that service in one of the remote management screens.
- The IP address in the **Secured Client IP Address** field does not match the client IP address. If it does not match, the ZyXEL Device will disconnect the session immediately.

- There is already another remote management session with an equal or higher priority running. You may only have one remote management session running at one time.
- There is a firewall rule that blocks it.

Remote Management and NAT

When NAT is enabled:

- Use the ZyXEL Device's WAN IP address when configuring from the WAN.
- Use the ZyXEL Device's LAN IP address when configuring from the LAN.

System Timeout

There is a default system management idle timeout of five minutes (three hundred seconds). The ZyXEL Device automatically logs you out if the management session remains idle for longer than this timeout period. The management session does not time out when a statistics screen is polling.

16.2 The WWW Screen

Use this screen to specify how to connect to the ZyXEL Device from a web browser, such as Internet Explorer.

Note: If you disable the **WWW** service in the **Remote MGMT > WWW** screen, then the ZyXEL Device blocks all HTTP connection attempts.

16.2.1 Configuring the WWW Screen

Click **Advanced > Remote MGMT** to display the **WWW** screen.

Figure 89 Advanced > Remote MGMT > WWW

The screenshot shows the configuration interface for the WWW service. At the top, there are tabs for 'WWW', 'Telnet', 'FTP', 'SNMP', 'DNS', and 'ICMP'. The 'WWW' tab is selected. Below the tabs, the configuration options are as follows:

- Server Port:** A text box containing the value '80'.
- Server Access:** A dropdown menu currently set to 'LAN & WAN'.
- Secured Client IP Address:** Radio buttons for 'All' (selected) and 'Selected', followed by a text box containing '0.0.0.0'.

Below these fields is a **Note** icon and text: "Note: For UPnP to function normally, the HTTP service must be available for LAN computers using UPnP." At the bottom of the configuration area, there are two buttons: 'Apply' and 'Cancel'.

The following table describes the labels in this screen.

Table 61 Advanced > Remote Management > WWW

LABEL	DESCRIPTION
Server Port	You may change the server port number for a service, if needed. However, you must use the same port number in order to use that service for remote management.
Server Access	Select the interface(s) through which a computer may access the ZyXEL Device using this service.
Secured Client IP Address	A secured client is a "trusted" computer that is allowed to communicate with the ZyXEL Device using this service. Select All to allow any computer to access the ZyXEL Device using this service. Choose Selected to just allow the computer with the IP address that you specify to access the ZyXEL Device using this service.
Apply	Click this to save your changes.
Cancel	Click this to restore your previously saved settings.

16.3 The Telnet Screen

You can use Telnet to access the ZyXEL Device's command line interface. Specify which interfaces allow Telnet access and from which IP address the access can come.

Click **Advanced > Remote MGMT > Telnet** tab to display the screen as shown.

Figure 90 Advanced > Remote MGMT > Telnet

The screenshot shows the 'Telnet' configuration screen. At the top, there are tabs for 'WWW', 'Telnet', 'FTP', 'SNMP', 'DNS', and 'ICMP'. The 'Telnet' tab is active. Below the tabs, the 'Telnet' section contains the following fields:

- Server Port:** A text input field containing the number '23'.
- Server Access:** A dropdown menu currently set to 'LAN & WAN'.
- Secured Client IP Address:** Two radio buttons, 'All' (which is selected) and 'Selected', followed by a text input field containing '0.0.0.0'.

At the bottom of the configuration area, there are two buttons: 'Apply' and 'Cancel'.

The following table describes the labels in this screen.

Table 62 Advanced > Remote Management > Telnet

LABEL	DESCRIPTION
Server Port	You may change the server port number for a service if needed, however you must use the same port number in order to use that service for remote management.
Server Access	Select the interface(s) through which a computer may access the ZyXEL Device using this service.
Secured Client IP Address	A secured client is a "trusted" computer that is allowed to communicate with the ZyXEL Device using this service. Select All to allow any computer to access the ZyXEL Device using this service. Choose Selected to just allow the computer with the IP address that you specify to access the ZyXEL Device using this service.
Apply	Click this to save your changes.
Cancel	Click this to restore your previously saved settings.

16.4 The FTP Screen

You can use FTP (File Transfer Protocol) to upload and download the ZyXEL Device's firmware and configuration files. Please see the User's Guide chapter on firmware and configuration file maintenance for details. To use this feature, your computer must have an FTP client.

Use this screen to specify which interfaces allow FTP access and from which IP address the access can come. To change your ZyXEL Device's FTP settings, click **Advanced > Remote MGMT > FTP**. The screen appears as shown.

Figure 91 Advanced > Remote MGMT > FTP

The screenshot shows the FTP configuration interface. At the top, there are navigation tabs: WWW, Telnet, FTP (highlighted in blue), SNMP, DNS, and ICMP. Below the tabs, the title 'FTP' is displayed. The configuration fields are as follows:

- Server Port:** A text input field containing the number '21'.
- Server Access:** A dropdown menu currently set to 'LAN & WAN'.
- Secured Client IP Address:** Radio buttons for 'All' (which is selected) and 'Selected', followed by a text input field containing '0.0.0.0'.

At the bottom of the configuration area, there are two buttons: 'Apply' and 'Cancel'.

The following table describes the labels in this screen.

Table 63 Advanced > Remote MGMT > FTP

LABEL	DESCRIPTION
Server Port	You may change the server port number for a service, if needed. However, you must use the same port number in order to use that service for remote management.
Server Access	Select the interface(s) through which a computer may access the ZyXEL Device using this service.
Secured Client IP Address	A secured client is a "trusted" computer that is allowed to communicate with the ZyXEL Device using this service. Select All to allow any computer to access the ZyXEL Device using this service. Choose Selected to just allow the computer with the IP address that you specify to access the ZyXEL Device using this service.
Apply	Click this to save your changes.
Cancel	Click this to restore your previously saved settings.

16.5 The SNMP Screen

Simple Network Management Protocol is a protocol used for exchanging management information between network devices. Your ZyXEL Device supports SNMP agent functionality, which allows a manager station to manage and monitor the ZyXEL Device through the network. The ZyXEL Device supports SNMP version one (SNMPv1) and version two (SNMPv2c). The next figure illustrates an SNMP management operation.

Figure 92 SNMP Management Model

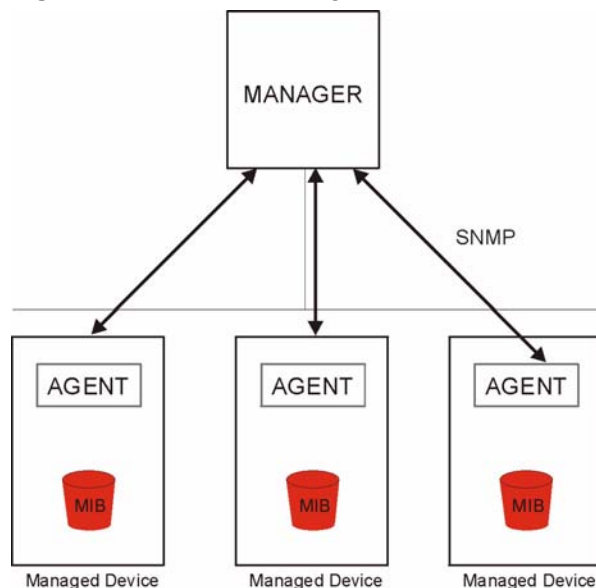

An SNMP managed network consists of two main types of component: agents and a manager.

An agent is a management software module that resides in a managed device (the ZyXEL Device). An agent translates the local management information from the managed device into a form compatible with SNMP. The manager is the console through which network administrators perform network management functions. It executes applications that control and monitor managed devices.

The managed devices contain object variables/managed objects that define each piece of information to be collected about a device. Examples of variables include such as number of packets received, node port status etc. A Management Information Base (MIB) is a collection of managed objects. SNMP allows a manager and agents to communicate for the purpose of accessing these objects.

16.5.1 Supported MIBs

The ZyXEL Device supports MIB II that is defined in RFC-1213 and RFC-1215. The ZyXEL Device also supports private MIBs (zywall.mib and zyxel-zywall-ZLD-Common.mib) to collect information about CPU and memory usage and VPN total throughput. The focus of the MIBs is to let administrators collect statistical data and monitor status and performance. You can download the ZyXEL Device's MIBs from www.zyxel.com.

16.5.2 SNMP Traps

The ZyXEL Device will send traps to the SNMP manager when any one of the following events occurs.

Table 64 SNMP Traps

OBJECT LABEL	OBJECT ID	DESCRIPTION
Cold Start	1.3.6.1.6.3.1.1.5.1	This trap is sent when the ZyXEL Device is turned on or an agent restarts.
linkDown	1.3.6.1.6.3.1.1.5.3	This trap is sent when the Ethernet link is down.
linkUp	1.3.6.1.6.3.1.1.5.4	This trap is sent when the Ethernet link is up.
authenticationFailure	1.3.6.1.6.3.1.1.5.5	This trap is sent when an SNMP request comes from non-authenticated hosts.

16.5.3 Configuring SNMP

To change your ZyXEL Device's SNMP settings, click **Advanced > Remote MGMT > SNMP** tab. The screen appears as shown.

Figure 93 Advanced > Remote MGMT > SNMP

The screenshot shows the SNMP configuration interface. At the top, there are navigation tabs: WWW, Telnet, FTP, **SNMP**, DNS, and ICMP. Below the tabs, the title 'SNMP' is displayed. The configuration area contains three main settings: 'Server Port' with a text input field containing '161'; 'Server Access' with a dropdown menu showing 'LAN & WAN'; and 'Secured Client IP Address' with two radio buttons, 'All' (which is selected) and 'Selected', followed by a text input field containing '0.0.0.0'. At the bottom of the configuration area, there are two buttons: 'Apply' and 'Cancel'.

The following table describes the labels in this screen.

Table 65 Advanced > Remote MGMT > SNMP

LABEL	DESCRIPTION
Server Port	The SNMP agent listens on port 161 by default. If you change the SNMP server port to a different number on the ZyXEL Device, for example 8161, then you must notify people who need to access the ZyXEL Device SNMP agent to use the same port.
Server Access	Select the interface(s) through which a computer may access the ZyXEL Device using this service.
Secured Client IP Address	A secured client is a "trusted" computer that is allowed to access the SNMP agent on the ZyXEL Device. Select All to allow any computer to access the SNMP agent. Choose Selected to just allow the computer with the IP address that you specify to access the SNMP agent.
Apply	Click Apply to save your changes back to the ZyXEL Device.
Cancel	Click Cancel to begin configuring this screen afresh.

16.6 The DNS Screen

Use DNS (Domain Name System) to map a domain name to its corresponding IP address and vice versa. Refer to [Chapter 7 on page 85](#) for background information.

Use this screen to set from which IP address the ZyXEL Device will accept DNS queries and on which interface it can send them your ZyXEL Device's DNS settings. This feature is not available when the ZyXEL Device is set to bridge

mode. Click **Advanced > Remote MGMT > DNS** to change your ZyXEL Device's DNS settings.

Figure 94 Advanced > Remote Management > DNS

The screenshot shows the DNS configuration page. At the top, there are navigation tabs: WWW, Telnet, FTP, SNMP, DNS (highlighted), and ICMP. Below the tabs, the page title is 'DNS'. The configuration fields are: 'Server Port' with a text box containing '53'; 'Server Access' with a dropdown menu showing 'LAN & WAN'; and 'Secured Client IP Address' with radio buttons for 'All' (selected) and 'Selected', followed by a text box containing '0.0.0.0'. At the bottom, there are 'Apply' and 'Cancel' buttons.

The following table describes the labels in this screen.

Table 66 Advanced > Remote Management > DNS

LABEL	DESCRIPTION
Server Port	The DNS service port number is 53 and cannot be changed here.
Server Access	Select the interface(s) through which a computer may send DNS queries to the ZyXEL Device.
Secured Client IP Address	A secured client is a "trusted" computer that is allowed to send DNS queries to the ZyXEL Device. Select All to allow any computer to send DNS queries to the ZyXEL Device. Choose Selected to just allow the computer with the IP address that you specify to send DNS queries to the ZyXEL Device.
Apply	Click this to save your changes.
Cancel	Click this to restore your previously saved settings.

16.7 The ICMP Screen

To change your ZyXEL Device's security settings, click **Advanced > Remote MGMT > ICMP**. The screen appears as shown.

If an outside user attempts to probe an unsupported port on your ZyXEL Device, an ICMP response packet is automatically returned. This allows the outside user to know the ZyXEL Device exists. Your ZyXEL Device supports anti-probing, which prevents the ICMP response packet from being sent. This keeps outsiders from discovering your ZyXEL Device when unsupported ports are probed.

Note: If you want your device to respond to pings and requests for unauthorized services, you may also need to configure the firewall anti probing settings to match.

Figure 95 Advanced > Remote Management > ICMP

The following table describes the labels in this screen.

Table 67 Advanced > Remote Management > ICMP

LABEL	DESCRIPTION
ICMP	Internet Control Message Protocol is a message control and error-reporting protocol between a host server and a gateway to the Internet. ICMP uses Internet Protocol (IP) datagrams, but the messages are processed by the TCP/IP software and directly apparent to the application user.
Respond to Ping on	The ZyXEL Device will not respond to any incoming Ping requests when Disable is selected. Select LAN to reply to incoming LAN Ping requests. Select WAN to reply to incoming WAN Ping requests. Otherwise select LAN & WAN to reply to both incoming LAN and WAN Ping requests.
Apply	Click this to save your changes.
Cancel	Click this to restore your previously saved settings.

Universal Plug-and-Play (UPnP)

17.1 Overview

Universal Plug and Play (UPnP) is a distributed, open networking standard that uses TCP/IP for simple peer-to-peer network connectivity between devices. A UPnP device can dynamically join a network, obtain an IP address, convey its capabilities and learn about other devices on the network. In turn, a device can leave a network smoothly and automatically when it is no longer in use.

17.1.1 What You Can Do in the UPnP Screen

Use the **UPnP** screen ([Section 17.2 on page 189](#)) to enable UPnP on the ZyXEL Device and allow UPnP-enabled applications to automatically configure the ZyXEL Device.

17.1.2 What You Need to Know

The following terms and concepts may help as you read this chapter.

Identifying UPnP Devices

UPnP hardware is identified as an icon in the Network Connections folder (Windows XP). Each UPnP compatible device installed on your network will appear as a separate icon. Selecting the icon of a UPnP device will allow you to access the information and properties of that device.

NAT Traversal

UPnP NAT traversal automates the process of allowing an application to operate through NAT. UPnP network devices can automatically configure network addressing, announce their presence in the network to other UPnP devices and enable exchange of simple product and service descriptions. NAT traversal allows the following:

- Dynamic port mapping
- Learning public IP addresses

- Assigning lease times to mappings

Windows Messenger is an example of an application that supports NAT traversal and UPnP.

See the NAT chapter for more information on NAT.

Cautions with UPnP

The automated nature of NAT traversal applications in establishing their own services and opening firewall ports may present network security issues. Network information and configuration may also be obtained and modified by users in some network environments.

When a UPnP device joins a network, it announces its presence with a multicast message. For security reasons, the ZyXEL Device allows multicast messages on the LAN only.

All UPnP-enabled devices may communicate freely with each other without additional configuration. Disable UPnP if this is not your intention.

UPnP and ZyXEL

ZyXEL has achieved UPnP certification from the Universal Plug and Play Forum UPnP™ Implementers Corp. (UIC). ZyXEL's UPnP implementation supports Internet Gateway Device (IGD) 1.0.

See the following sections for examples of installing and using UPnP.

17.2 The UPnP Screen

Use the following screen to configure the UPnP settings on your ZyXEL Device. Click **Advanced > UPnP** to display the screen shown next.

See [Section 17.1 on page 187](#) for more information.

Figure 96 Advanced > UPnP > General

The following table describes the fields in this screen.

Table 68 Advanced > UPnP > General

LABEL	DESCRIPTION
Active the Universal Plug and Play (UPnP) Feature	Select this check box to activate UPnP. Be aware that anyone could use a UPnP application to open the web configurator's login screen without entering the ZyXEL Device's IP address (although you must still enter the password to access the web configurator).
Allow users to make configuration changes through UPnP	Select this check box to allow UPnP-enabled applications to automatically configure the ZyXEL Device so that they can communicate through the ZyXEL Device, for example by using NAT traversal, UPnP applications automatically reserve a NAT forwarding port in order to communicate with another UPnP enabled device; this eliminates the need to manually configure port forwarding for the UPnP enabled application.
Apply	Click this to save your changes.
Cancel	Click this to restore your previously saved settings.

17.2.1 Installing UPnP in Windows

This section shows you how to configure or install UPnP in Windows.

17.2.1.1 Windows 7

Windows 7 already has UPnP installed. To enable it:

- 1 Click **Start > Control Panel** and select **Network and Internet**.
- 2 Click **Network and Sharing Center**.
- 3 In the **Network and Sharing** window, set **Network Discovery** to **On**. This activates the UPnP feature in Windows 7

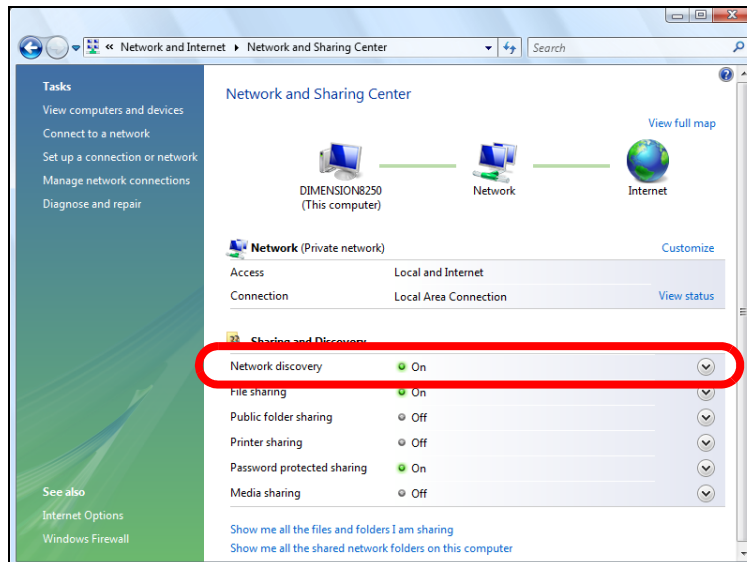

17.2.1.2 Windows XP

To install the UPnP in Windows XP:

- 1 Click **Start** and **Control Panel**.
- 2 Double-click **Network Connections**.
- 3 In the **Network Connections** window, click **Advanced** in the main menu and select **Optional Networking Components ...**

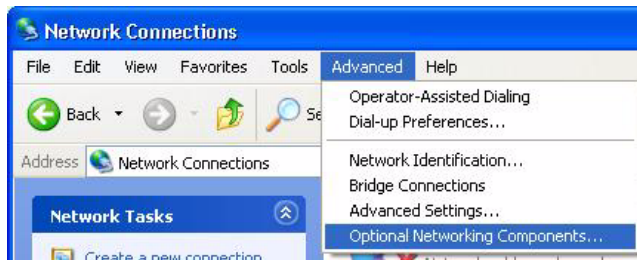

- 4 The **Windows Optional Networking Components Wizard** window displays. Select **Networking Service** in the **Components** selection box and click **Details**.

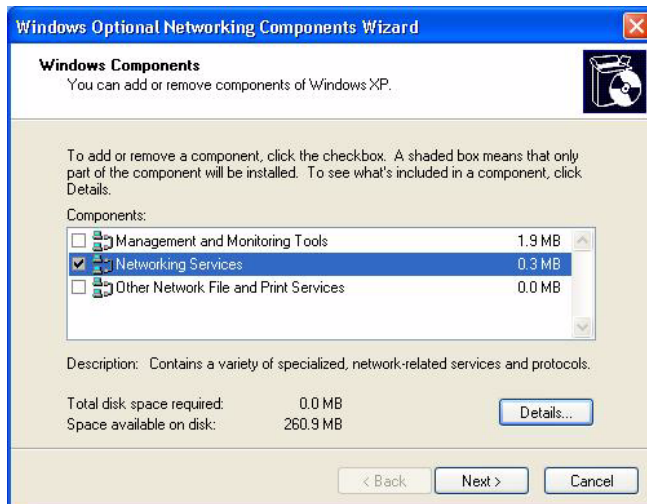

- 5 In the **Networking Services** window, select the **Universal Plug and Play** check box.

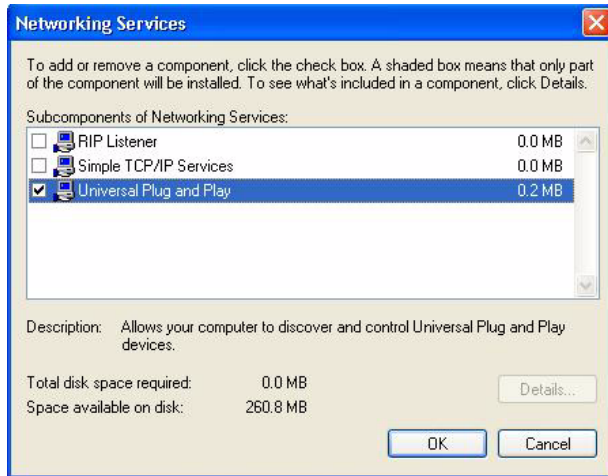

- 6 Click **OK** to go back to the **Windows Optional Networking Component Wizard** window and click **Next**.

17.2.2 Using UPnP in Windows XP

This section shows you how to use the UPnP feature in Windows XP. You must already have UPnP installed in Windows XP and UPnP activated on the ZyXEL Device.

Make sure the computer is connected to a LAN port of the ZyXEL Device. Turn on your computer and the ZyXEL Device.

17.2.2.1 Auto-discover Your UPnP-enabled Network Device

- 1 Click **Start** and **Control Panel**. Double-click **Network Connections**. An icon displays under Internet Gateway.
- 2 Right-click the icon and select **Properties**.



- 3 In the **Internet Connection Properties** window, click **Settings** to see the port mappings there were automatically created.

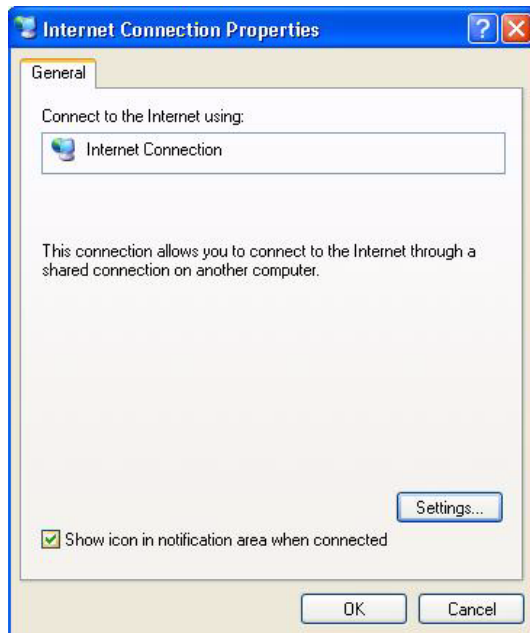

- 4 You may edit or delete the port mappings or click **Add** to manually add port mappings.

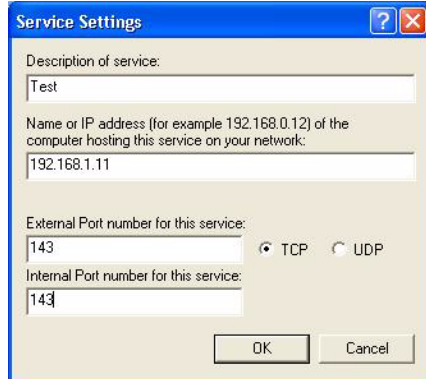
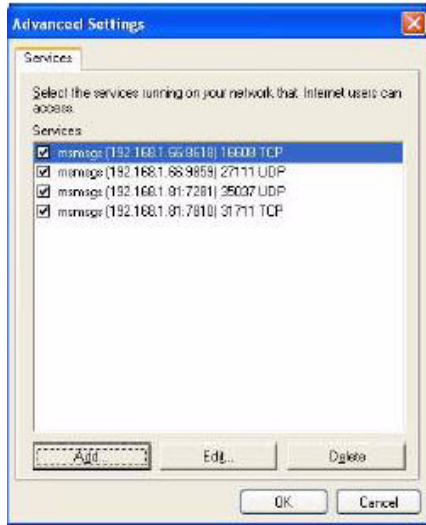

- 5 When the UPnP-enabled device is disconnected from your computer, all port mappings will be deleted automatically.
- 6 Select **Show icon in notification area when connected** option and click **OK**. An icon displays in the system tray.



- 7 Double-click on the icon to display your current Internet connection status.



17.2.2.2 Web Configurator Easy Access

With UPnP, you can access the web-based configurator on the ZyXEL Device without finding out the IP address of the ZyXEL Device first. This comes helpful if you do not know the IP address of the ZyXEL Device.

Follow the steps below to access the web configurator.

- 1 Click **Start** and then **Control Panel**.
- 2 Double-click **Network Connections**.
- 3 Select **My Network Places** under **Other Places**.



- 4 An icon with the description for each UPnP-enabled device displays under **Local Network**.

- 5 Right-click on the icon for your ZyXEL Device and select **Invoke**. The web configurator login screen displays.

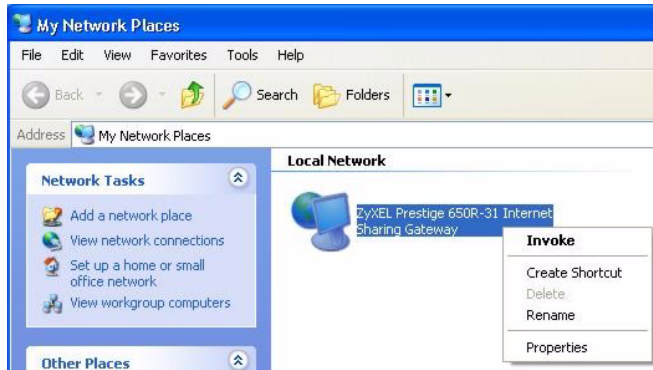

- 6 Right-click on the icon for your ZyXEL Device and select **Properties**. A properties window displays with basic information about the ZyXEL Device.



18.1 Overview

The ZyXEL Device supports TR-069 Amendment 1 (CPE WAN Management Protocol Release 2.0) and TR-069 Amendment 2 (CPE WAN Management Protocol v1.1, Release 3.0).

TR-069 is a protocol that defines how your ZyXEL Device (**ZD**) can be managed via a management server (**MS**) such as ZyXEL's Vantage Access.

Figure 97 LAN and WAN

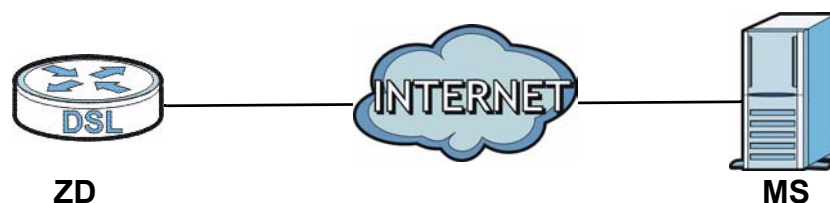

An administrator can use a management server to remotely set up the ZyXEL device, modify settings, perform firmware upgrades as well as monitor and diagnose the ZyXEL device.

In order to use CWMP, you need to configure the following steps:

- 1 Activate CWMP
- 2 Specify the URL, username and password.
- 3 Activate periodic inform and specify an interval value.

18.2 The CWMP Setup Screen

Use this screen to configure your ZyXEL Device to be managed by a management server. Click **Advanced > CWMP** to display the following screen.

Figure 98 Advanced > CWMP

The following table describes the fields in this screen.

Table 69 Advanced > CWMP

LINK	DESCRIPTION
CWMP Setup	
CWMP	Select Activated to allow the ZyXEL Device to be managed by a management server or select Deactivated to not allow the ZyXEL Device to be managed by a management server.
Login ACS	Configure this part of the screen to log into the management server.
URL	Type the IP address or domain name of the management server. If the ZyXEL Device is behind a NAT router that assigns it a private IP address, you will have to configure a NAT port forwarding rule on the NAT router.
User Name	The user name is used to authenticate the ZyXEL Device when making a connection to the management server. This user name on the management server and the ZyXEL Device must be the same. Type a user name of up to 255 printable characters found on an English-language keyboard. Spaces and characters such as @#\$\$%^&*()_+ are allowed.

Table 69 Advanced > CWMP (continued)

LINK	DESCRIPTION
Password	The password is used to authenticate the ZyXEL Device when making a connection to the management server. This password on the management server and the ZyXEL Device must be the same. Type a password of up to 255 printable characters found on an English-language keyboard.
Connection Request	Use this part of the screen to allow the management server to connect to the ZyXEL Device after a successful login.
Path	Type the IP address or domain name of the ZyXEL Device. The management server uses this path to verify the ZyXEL Device.
Port	The default port for access to the ZyXEL Device from the management server is the HTTP port, port 80. If you change it, make sure it does not conflict with another port on your network and it is recommended to use a port number above 1024 (not a commonly used port). The management server should use this port to connect to the ZyXEL Device. You may need to alter your NAT port forwarding rules if they were already configured.
UserName	The user name is used to authenticate the management server when connecting to the ZyXEL Device. Type a user name of up to 255 printable characters found on an English-language keyboard. Spaces and characters such as @#\$%^&*()_+ are allowed.
Password	The password is used to authenticate the management server when connecting to the ZyXEL Device. Type a password of up to 255 printable characters found on an English-language keyboard. Spaces are not allowed.
Periodic Inform	Select Activated to have the ZyXEL Device periodically send information to the management server (recommended if CWMP is enabled) or select Deactivated to not have the ZyXEL Device periodically send information to the management server
Interval	The interval is the duration in seconds for which the ZyXEL Device must attempt to connect with the management server to send information and check for configuration updates. Enter a value between 1 and 86400 seconds.
Apply	Click this to save your changes.
Cancel	Click this to restore your previously saved settings.

System Settings

19.1 Overview

This chapter shows you how to configure system related settings, such as system time, password, name, the domain name and the inactivity timeout interval.

19.1.1 What You Can Do in the System Settings Screens

- Use the **General** screen ([Section 19.2 on page 201](#)) to configure system settings.
- Use the **Time and Date** screen ([Section 19.3 on page 202](#)) to set the system time.

19.2 The General Screen

Use this screen to configure system admin password.

Click **Maintenance > System** to open the **General** screen.

Figure 99 Maintenance > System > General

The screenshot shows a web-based configuration interface. At the top, there are two tabs: 'General' and 'Time and Date'. The 'General' tab is active. Below the tabs, there is a section titled 'Password'. This section contains three input fields: 'Old Password', 'New Password', and 'Retype to confirm'. Below the input fields, there is a caution message: 'Caution: Please record your new password whenever you change it. The system will lock you out if you have forgotten your password.' At the bottom of the screen, there are two buttons: 'Apply' and 'Cancel'.

The following table describes the labels in this screen.

Table 70 Maintenance > System > General

LABEL	DESCRIPTION
Admin Password	
Old Password	Type the default password or the existing password you use to access the system in this field.
New Password	Type your new system password (up to 30 characters). Note that as you type a password, the screen displays a (*) for each character you type. After you change the password, use the new password to access the ZyXEL Device.
Retype to confirm	Type the new password again for confirmation.
Apply	Click this to save your changes.
Cancel	Click this to restore your previously saved settings.

19.3 The Time and Date Screen

Use this screen to configure the ZyXEL Device's time based on your local time zone. To change your ZyXEL Device's time and date, click **Maintenance > System > Time and Date**. The screen appears as shown.

Figure 100 Maintenance > System > Time and Date

The following table describes the fields in this screen.

Table 71 Maintenance > System > Time and Date

LABEL	DESCRIPTION
Current Time and Date	
Current Time	This field displays the time of your ZyXEL Device. Each time you reload this page, the ZyXEL Device synchronizes the time with the time server.
Current Date	This field displays the date of your ZyXEL Device. Each time you reload this page, the ZyXEL Device synchronizes the date with the time server.
Time and Date Setup	
Manual	Select this radio button to enter the time and date manually. If you configure a new time and date, Time Zone and Daylight Saving at the same time, the new time and date you entered has priority and the Time Zone and Daylight Saving settings do not affect it.
New Time (hh:mm:ss)	This field displays the last updated time from the time server or the last time configured manually. When you set Time and Date Setup to Manual , enter the new time in this field and then click Apply .
New Date (yyyy/mm/dd)	This field displays the last updated date from the time server or the last date configured manually. When you set Time and Date Setup to Manual , enter the new date in this field and then click Apply .
Get from Time Server	Select this radio button to have the ZyXEL Device get the time and date from the time server you specified below.
Time Server Address	Enter the IP address or URL (up to 20 extended ASCII characters in length) of your time server. Check with your ISP/network administrator if you are unsure of this information.
Time Zone Setup	
Time Zone	Choose the time zone of your location. This will set the time difference between your time zone and Greenwich Mean Time (GMT).
Daylight Savings	Daylight saving is a period from late spring to early fall when many countries set their clocks ahead of normal local time by one hour to give more daytime light in the evening. Select this option if you use Daylight Saving Time.

Table 71 Maintenance > System > Time and Date (continued)

LABEL	DESCRIPTION
Start Date	<p>Configure the day and time when Daylight Saving Time starts if you selected Enable Daylight Saving. The o'clock field uses the 24 hour format. Here are a couple of examples:</p> <p>Daylight Saving Time starts in most parts of the United States on the second Sunday of March. Each time zone in the United States starts using Daylight Saving Time at 2 A.M. local time. So in the United States you would select Second, Sunday, March and type 2 in the o'clock field.</p> <p>Daylight Saving Time starts in the European Union on the last Sunday of March. All of the time zones in the European Union start using Daylight Saving Time at the same moment (1 A.M. GMT or UTC). So in the European Union you would select Last, Sunday, March. The time you type in the o'clock field depends on your time zone. In Germany for instance, you would type 2 because Germany's time zone is one hour ahead of GMT or UTC (GMT+1).</p>
End Date	<p>Configure the day and time when Daylight Saving Time ends if you selected Enable Daylight Saving. The o'clock field uses the 24 hour format. Here are a couple of examples:</p> <p>Daylight Saving Time ends in the United States on the first Sunday of November. Each time zone in the United States stops using Daylight Saving Time at 2 A.M. local time. So in the United States you would select First, Sunday, November and type 2 in the o'clock field.</p> <p>Daylight Saving Time ends in the European Union on the last Sunday of October. All of the time zones in the European Union stop using Daylight Saving Time at the same moment (1 A.M. GMT or UTC). So in the European Union you would select Last, Sunday, October. The time you type in the o'clock field depends on your time zone. In Germany for instance, you would type 2 because Germany's time zone is one hour ahead of GMT or UTC (GMT+1).</p>
Apply	Click this to save your changes.
Cancel	Click this to restore your previously saved settings.

20.1 Overview

This chapter contains information about viewing the ZyXEL Device's logs.

The web configurator allows you to choose which types of events and/or alerts to have the ZyXEL Device log and then display the logs.

20.1.1 What You Need To Know

The following terms and concepts may help as you read this chapter.

Alerts

An alert is a message that is enabled as soon as the event occurs. They include system errors, attacks (access control) and attempted access to blocked web sites. Some categories such as **System Errors** consist of both logs and alerts. You may differentiate them by their color in the **View Log** screen. Alerts display in red and logs display in black.

Logs

A log is a message about an event that occurred on your ZyXEL Device. For example, when someone logs in to the ZyXEL Device, you can set a schedule for how often logs should be enabled, or sent to a syslog server.

20.2 The System Log Screen

Use the **System Log** screen to configure and view the logs you wish to display.

To change your ZyXEL Device's log settings, click **Maintenance > Logs > Log Settings**. The screen appears as shown.

Alerts are e-mailed as soon as they happen. Logs may be e-mailed as soon as the log is full. Selecting many alert and/or log categories (especially **Access Control**) may result in many e-mails being sent.

Figure 101 Maintenance > System Logs

The following table describes the fields in this screen.

Table 72 Maintenance > Logs > Log Settings

LABEL	DESCRIPTION
System Log	
Log Type	Select the types of logs that you want to display and record. Then click Submit to display the details.
Clear Log	Click this to delete all the logs.
Save Log	Click this to save the logs in a text file.

20.3 Log Descriptions

This section provides descriptions of example log messages.

Table 73 System Maintenance Logs

LOG MESSAGE	DESCRIPTION
Time calibration is successful	The router has adjusted its time based on information from the time server.
Time calibration failed	The router failed to get information from the time server.
WAN interface gets IP: %s	A WAN interface got a new IP address from the DHCP, PPPoE, or dial-up server.
DHCP client IP expired	A DHCP client's IP address has expired.
DHCP server assigns %s	The DHCP server assigned an IP address to a client.
Successful WEB login	Someone has logged on to the router's web configurator interface.
WEB login failed	Someone has failed to log on to the router's web configurator interface.
Successful TELNET login	Someone has logged on to the router via telnet.
TELNET login failed	Someone has failed to log on to the router via telnet.
Successful FTP login	Someone has logged on to the router via ftp.
FTP login failed	Someone has failed to log on to the router via ftp.
NAT Session Table is Full!	The maximum number of NAT session table entries has been exceeded and the table is full.
Starting Connectivity Monitor	Starting Connectivity Monitor.
Time initialized by Daytime Server	The router got the time and date from the Daytime server.
Time initialized by Time server	The router got the time and date from the time server.
Time initialized by NTP server	The router got the time and date from the NTP server.
Connect to Daytime server fail	The router was not able to connect to the Daytime server.
Connect to Time server fail	The router was not able to connect to the Time server.
Connect to NTP server fail	The router was not able to connect to the NTP server.
Too large ICMP packet has been dropped	The router dropped an ICMP packet that was too large.
Configuration Change: PC = 0x%x, Task ID = 0x%x	The router is saving configuration changes.
Successful SSH login	Someone has logged on to the router's SSH server.
SSH login failed	Someone has failed to log on to the router's SSH server.

Table 73 System Maintenance Logs (continued)

LOG MESSAGE	DESCRIPTION
Successful HTTPS login	Someone has logged on to the router's web configurator interface using HTTPS protocol.
HTTPS login failed	Someone has failed to log on to the router's web configurator interface using HTTPS protocol.

Table 74 System Error Logs

LOG MESSAGE	DESCRIPTION
%s exceeds the max. number of session per host!	This attempt to create a NAT session exceeds the maximum number of NAT session table entries allowed to be created per host.
setNetBIOSFilter: calloc error	The router failed to allocate memory for the NetBIOS filter settings.
readNetBIOSFilter: calloc error	The router failed to allocate memory for the NetBIOS filter settings.
WAN connection is down.	A WAN connection is down. You cannot access the network through this interface.

Table 75 Access Control Logs

LOG MESSAGE	DESCRIPTION
Firewall default policy: [TCP UDP IGMP ESP GRE OSPF] <Packet Direction>	Attempted TCP/UDP/IGMP/ESP/GRE/OSPF access matched the default policy and was blocked or forwarded according to the default policy's setting.
Firewall rule [NOT] match:[TCP UDP IGMP ESP GRE OSPF] <Packet Direction>, <rule:%d>	Attempted TCP/UDP/IGMP/ESP/GRE/OSPF access matched (or did not match) a configured firewall rule (denoted by its number) and was blocked or forwarded according to the rule.
Triangle route packet forwarded: [TCP UDP IGMP ESP GRE OSPF]	The firewall allowed a triangle route session to pass through.
Packet without a NAT table entry blocked: [TCP UDP IGMP ESP GRE OSPF]	The router blocked a packet that didn't have a corresponding NAT table entry.
Router sent blocked web site message: TCP	The router sent a message to notify a user that the router blocked access to a web site that the user requested.

Table 76 TCP Reset Logs

LOG MESSAGE	DESCRIPTION
Under SYN flood attack, sent TCP RST	The router sent a TCP reset packet when a host was under a SYN flood attack (the TCP incomplete count is per destination host.)
Exceed TCP MAX incomplete, sent TCP RST	The router sent a TCP reset packet when the number of TCP incomplete connections exceeded the user configured threshold. (the TCP incomplete count is per destination host.) Note: Refer to TCP Maximum Incomplete in the Firewall Attack Alerts screen.
Peer TCP state out of order, sent TCP RST	The router sent a TCP reset packet when a TCP connection state was out of order. Note: The firewall refers to RFC793 Figure 6 to check the TCP state.
Firewall session time out, sent TCP RST	The router sent a TCP reset packet when a dynamic firewall session timed out. Default timeout values: ICMP idle timeout (s): 60 UDP idle timeout (s): 60 TCP connection (three way handshaking) timeout (s): 30 TCP FIN-wait timeout (s): 60 TCP idle (established) timeout (s): 3600
Exceed MAX incomplete, sent TCP RST	The router sent a TCP reset packet when the number of incomplete connections (TCP and UDP) exceeded the user-configured threshold. (Incomplete count is for all TCP and UDP connections through the firewall.) Note: When the number of incomplete connections (TCP + UDP) > "Maximum Incomplete High", the router sends TCP RST packets for TCP connections and destroys TOS (firewall dynamic sessions) until incomplete connections < "Maximum Incomplete Low".
Access block, sent TCP RST	The router sends a TCP RST packet and generates this log if you turn on the firewall TCP reset mechanism (via CLI command: "sys firewall tcprst").

Table 77 Packet Filter Logs

LOG MESSAGE	DESCRIPTION
[TCP UDP ICMP IGMP Generic] packet filter matched (set: %d, rule: %d)	Attempted access matched a configured filter rule (denoted by its set and rule number) and was blocked or forwarded according to the rule.

For type and code details, see [Table 86 on page 213](#).

Table 78 ICMP Logs

LOG MESSAGE	DESCRIPTION
Firewall default policy: ICMP <Packet Direction>, <type:%d>, <code:%d>	ICMP access matched the default policy and was blocked or forwarded according to the user's setting.
Firewall rule [NOT] match: ICMP <Packet Direction>, <rule:%d>, <type:%d>, <code:%d>	ICMP access matched (or didn't match) a firewall rule (denoted by its number) and was blocked or forwarded according to the rule.
Triangle route packet forwarded: ICMP	The firewall allowed a triangle route session to pass through.
Packet without a NAT table entry blocked: ICMP	The router blocked a packet that didn't have a corresponding NAT table entry.
Unsupported/out-of-order ICMP: ICMP	The firewall does not support this kind of ICMP packets or the ICMP packets are out of order.
Router reply ICMP packet: ICMP	The router sent an ICMP reply packet to the sender.

Table 79 CDR Logs

LOG MESSAGE	DESCRIPTION
board %d line %d channel %d, call %d, %s C01 Outgoing Call dev=%x ch=%x %s	The router received the setup requirements for a call. "call" is the reference (count) number of the call. "dev" is the device type (3 is for dial-up, 6 is for PPPoE, 10 is for PPTP). "channel" or "ch" is the call channel ID. For example, "board 0 line 0 channel 0, call 3, C01 Outgoing Call dev=6 ch=0" Means the router has dialed to the PPPoE server 3 times.
board %d line %d channel %d, call %d, %s C02 OutCall Connected %d %s	The PPPoE, PPTP or dial-up call is connected.
board %d line %d channel %d, call %d, %s C02 Call Terminated	The PPPoE, PPTP or dial-up call was disconnected.

Table 80 PPP Logs

LOG MESSAGE	DESCRIPTION
ppp:LCP Starting	The PPP connection's Link Control Protocol stage has started.
ppp:LCP Opening	The PPP connection's Link Control Protocol stage is opening.
ppp:CHAP Opening	The PPP connection's Challenge Handshake Authentication Protocol stage is opening.
ppp:IPCP Starting	The PPP connection's Internet Protocol Control Protocol stage is starting.
ppp:IPCP Opening	The PPP connection's Internet Protocol Control Protocol stage is opening.

Table 80 PPP Logs (continued)

LOG MESSAGE	DESCRIPTION
ppp:LCP Closing	The PPP connection's Link Control Protocol stage is closing.
ppp:IPCP Closing	The PPP connection's Internet Protocol Control Protocol stage is closing.

Table 81 UPnP Logs

LOG MESSAGE	DESCRIPTION
UPnP pass through Firewall	UPnP packets can pass through the firewall.

Table 82 Content Filtering Logs

LOG MESSAGE	DESCRIPTION
%s: block keyword	The content of a requested web page matched a user defined keyword.
%s	The system forwarded web content.

For type and code details, see [Table 86 on page 213](#).

Table 83 Attack Logs

LOG MESSAGE	DESCRIPTION
attack [TCP UDP IGMP ESP GRE OSPF]	The firewall detected a TCP/UDP/IGMP/ESP/GRE/OSPF attack.
attack ICMP (type:%d, code:%d)	The firewall detected an ICMP attack.
land [TCP UDP IGMP ESP GRE OSPF]	The firewall detected a TCP/UDP/IGMP/ESP/GRE/OSPF land attack.
land ICMP (type:%d, code:%d)	The firewall detected an ICMP land attack.
ip spoofing - WAN [TCP UDP IGMP ESP GRE OSPF]	The firewall detected an IP spoofing attack on the WAN port.
ip spoofing - WAN ICMP (type:%d, code:%d)	The firewall detected an ICMP IP spoofing attack on the WAN port.
icmp echo : ICMP (type:%d, code:%d)	The firewall detected an ICMP echo attack.
syn flood TCP	The firewall detected a TCP syn flood attack.
ports scan TCP	The firewall detected a TCP port scan attack.
teardrop TCP	The firewall detected a TCP teardrop attack.
teardrop UDP	The firewall detected an UDP teardrop attack.
teardrop ICMP (type:%d, code:%d)	The firewall detected an ICMP teardrop attack.
illegal command TCP	The firewall detected a TCP illegal command attack.

Table 83 Attack Logs (continued)

LOG MESSAGE	DESCRIPTION
NetBIOS TCP	The firewall detected a TCP NetBIOS attack.
ip spoofing - no routing entry [TCP UDP IGMP ESP GRE OSPF]	The firewall classified a packet with no source routing entry as an IP spoofing attack.
ip spoofing - no routing entry ICMP (type:%d, code:%d)	The firewall classified an ICMP packet with no source routing entry as an IP spoofing attack.
vulnerability ICMP (type:%d, code:%d)	The firewall detected an ICMP vulnerability attack.
traceroute ICMP (type:%d, code:%d)	The firewall detected an ICMP traceroute attack.

Table 84 802.1X Logs

LOG MESSAGE	DESCRIPTION
RADIUS accepts user.	A user was authenticated by the RADIUS Server.
RADIUS rejects user. Pls check RADIUS Server.	A user was not authenticated by the RADIUS Server. Please check the RADIUS Server.
User logout because of session timeout expired.	The router logged out a user whose session expired.
User logout because of user deassociation.	The router logged out a user who ended the session.
User logout because of no authentication response from user.	The router logged out a user from which there was no authentication response.
User logout because of idle timeout expired.	The router logged out a user whose idle timeout period expired.
User logout because of user request.	A user logged out.
No response from RADIUS. Pls check RADIUS Server.	There is no response message from the RADIUS server, please check the RADIUS server.
Use RADIUS to authenticate user.	The RADIUS server is operating as the authentication server.
No Server to authenticate user.	There is no authentication server to authenticate a user.

Table 85 ACL Setting Notes

PACKET DIRECTION	DIRECTION	DESCRIPTION
(L to W)	LAN to WAN	ACL set for packets traveling from the LAN to the WAN.
(W to L)	WAN to LAN	ACL set for packets traveling from the WAN to the LAN.

Table 85 ACL Setting Notes (continued)

PACKET DIRECTION	DIRECTION	DESCRIPTION
(L to L/ZyXEL Device)	LAN to LAN/ ZyXEL Device	ACL set for packets traveling from the LAN to the LAN or the ZyXEL Device.
(W to W/ZyXEL Device)	WAN to WAN/ ZyXEL Device	ACL set for packets traveling from the WAN to the WAN or the ZyXEL Device.

Table 86 ICMP Notes

TYPE	CODE	DESCRIPTION
0		Echo Reply
	0	Echo reply message
3		Destination Unreachable
	0	Net unreachable
	1	Host unreachable
	2	Protocol unreachable
	3	Port unreachable
	4	A packet that needed fragmentation was dropped because it was set to Don't Fragment (DF)
	5	Source route failed
4		Source Quench
	0	A gateway may discard internet datagrams if it does not have the buffer space needed to queue the datagrams for output to the next network on the route to the destination network.
5		Redirect
	0	Redirect datagrams for the Network
	1	Redirect datagrams for the Host
	2	Redirect datagrams for the Type of Service and Network
	3	Redirect datagrams for the Type of Service and Host
8		Echo
	0	Echo message
11		Time Exceeded
	0	Time to live exceeded in transit
	1	Fragment reassembly time exceeded
12		Parameter Problem
	0	Pointer indicates the error
13		Timestamp
	0	Timestamp request message
14		Timestamp Reply
	0	Timestamp reply message
15		Information Request

Table 86 ICMP Notes (continued)

TYPE	CODE	DESCRIPTION
	0	Information request message
16		Information Reply
	0	Information reply message

Table 87 Syslog Logs

LOG MESSAGE	DESCRIPTION
<pre><Facility*8 + Severity>Mon dd hr:mm:ss hostname src="<srcIP:srcPort>" dst="<dstIP:dstPort>" msg="<msg>" note="<note>" devID="<mac address last three numbers>" cat="<category></pre>	<p>"This message is sent by the system ("RAS" displays as the system name if you haven't configured one) when the router generates a syslog. The facility is defined in the web MAIN MENU->LOGS->Log Settings page. The severity is the log's syslog class. The definition of messages and notes are defined in the various log charts throughout this appendix. The "devID" is the last three characters of the MAC address of the router's LAN port. The "cat" is the same as the category in the router's logs.</p>

The following table shows RFC-2408 ISAKMP payload types that the log displays. Please refer to RFC 2408 for detailed information on each type.

Table 88 RFC-2408 ISAKMP Payload Types

LOG DISPLAY	PAYLOAD TYPE
SA	Security Association
PROP	Proposal
TRANS	Transform
KE	Key Exchange
ID	Identification
CER	Certificate
CER_REQ	Certificate Request
HASH	Hash
SIG	Signature
NONCE	Nonce
NOTFY	Notification
DEL	Delete
VID	Vendor ID

21.1 Overview

This chapter explains how to upload new firmware, manage configuration files and restart your ZyXEL Device.

Use the instructions in this chapter to change the device's configuration file or upgrade its firmware. After you configure your device, you can backup the configuration file to a computer. That way if you later misconfigure the device, you can upload the backed up configuration file to return to your previous settings. You can alternately upload the factory default configuration file if you want to return the device to the original default settings. The firmware determines the device's available features and functionality. You can download new firmware releases from your nearest ZyXEL FTP site (or www.zyxel.com) to use to upgrade your device's performance.

Only use firmware for your device's specific model. Refer to the label on the bottom of your ZyXEL Device.

21.1.1 What You Can Do in the Tool Screens

- Use the **Firmware Upgrade** screen ([Section 21.2 on page 216](#)) to upload firmware to your device.
- Use the **Configuration** screen ([Section 21.3 on page 218](#)) to backup and restore device configurations. You can also reset your device settings back to the factory default.
- Use the **Restart** screen ([Section 21.4 on page 221](#)) to restart your ZyXEL device.

21.1.2 What You Need To Know

The following terms and concepts may help as you read this chapter.

Filename Conventions

The configuration file (often called the romfile or rom-0) contains the factory default settings in the menus such as password, DHCP Setup, TCP/IP Setup, etc. It arrives from ZyXEL with a "rom" filename extension. Once you have customized the ZyXEL Device's settings, they can be saved back to your computer under a filename of your choosing.

ZyNOS (ZyXEL Network Operating System sometimes referred to as the "ras" file) is the system firmware and has a "bin" filename extension. Find this firmware at www.zyxel.com.

21.1.3 Before You Begin

- Ensure you have either created a firewall rule to allow access from the WAN or turned the firewall off, otherwise the FTP will not function.
- Make sure the FTP service has not been disabled in the Remote Management screen.

21.2 The Firmware Screen

Click **Maintenance > Tools** to open the **Firmware** screen. Follow the instructions in this screen to upload firmware to your ZyXEL Device. The upload process uses HTTP (Hypertext Transfer Protocol) and may take up to two minutes. After a successful upload, the system will reboot.

Do NOT turn off the ZyXEL Device while firmware upload is in progress!

Figure 102 Maintenance > Tools > Firmware

The screenshot shows the 'Firmware Upgrade' screen in a web browser. At the top, there are three tabs: 'Firmware' (selected), 'Configuration', and 'Restart'. Below the tabs is a header 'Firmware Upgrade'. The main content area contains the following text: 'Browse to the location of the binary (.BIN) upgrade file and click UPLOAD.' Below this, it shows 'Current Firmware Version: 340BYH0b2'. There is a 'File Path:' label followed by a text input field and a 'Browse...' button. At the bottom, there is an 'Upload' button.

The following table describes the labels in this screen.

Table 89 Maintenance > Tools > Firmware

LABEL	DESCRIPTION
Current Firmware Version	This is the present Firmware version and the date created.
File Path	Type in the location of the file you want to upload in this field or click Browse ... to find it.
Browse...	Click this to find the .bin file you want to upload. Remember that you must decompress compressed (.zip) files before you can upload them.
Upload	Click this to begin the upload process. This process may take up to two minutes.

After you see the **Firmware Upload in Progress** screen, wait two minutes before logging into the ZyXEL Device again.

Figure 103 Firmware Upload In Progress



The ZyXEL Device automatically restarts in this time causing a temporary network disconnect. In some operating systems, you may see the following icon on your desktop.

Figure 104 Network Temporarily Disconnected

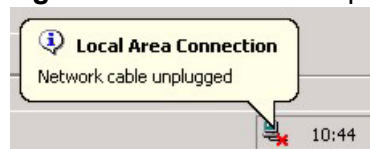

After two minutes, log in again and check your new firmware version in the **Status** screen.

If the upload was not successful, the following screen will appear. Click **Return** to go back to the **Firmware** screen.

Figure 105 Error Message



21.3 The Configuration Screen

Click **Maintenance > Tools > Configuration**. Information related to factory defaults, backup configuration, and restoring configuration appears in this screen, as shown next.

Figure 106 Maintenance > Tools > Configuration

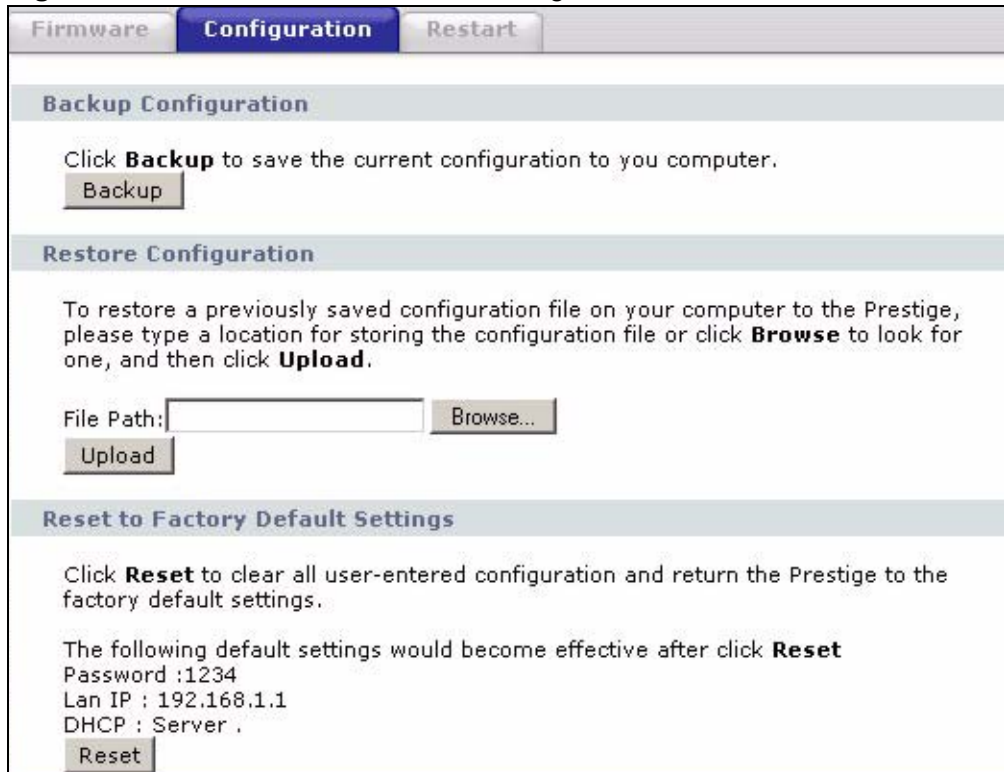

Backup Configuration

Backup Configuration allows you to back up (save) the ZyXEL Device's current configuration to a file on your computer. Once your ZyXEL Device is configured and functioning properly, it is highly recommended that you back up your configuration file before making configuration changes. The backup configuration file will be useful in case you need to return to your previous settings.

Click **Backup** to save the ZyXEL Device's current configuration to your computer.

Restore Configuration

Restore Configuration allows you to upload a new or previously saved configuration file from your computer to your ZyXEL Device.

Table 90 Restore Configuration

LABEL	DESCRIPTION
File Path	Type in the location of the file you want to upload in this field or click Browse ... to find it.
Browse...	Click this to find the file you want to upload. Remember that you must decompress compressed (.ZIP) files before you can upload them.
Upload	Click this to begin the upload process.

Do not turn off the ZyXEL Device while configuration file upload is in progress.

After you see a "restore configuration successful" screen, you must then wait one minute before logging into the ZyXEL Device again.

Figure 107 Configuration Upload Successful

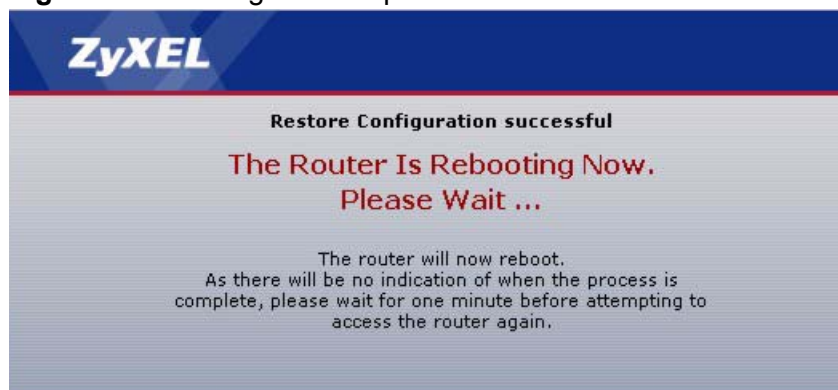

The ZyXEL Device automatically restarts in this time causing a temporary network disconnect. In some operating systems, you may see the following icon on your desktop.

Figure 108 Network Temporarily Disconnected



If you uploaded the default configuration file you may need to change the IP address of your computer to be in the same subnet as that of the default device IP address (192.168.1.1). See [Appendix A on page 241](#) for details on how to set up your computer's IP address.

If the upload was not successful, the following screen will appear. Click **Return** to go back to the **Configuration** screen.

Figure 109 Configuration Upload Error



Reset to Factory Defaults

Click the **Reset** button to clear all user-entered configuration information and return the ZyXEL Device to its factory defaults. The following warning screen appears.

Figure 110 Reset Warning Message



Figure 111 Reset In Process Message



You can also press the **RESET** button on the rear panel to reset the factory defaults of your ZyXEL Device. Refer to [Section 1.6 on page 26](#) for more information on the **RESET** button.

21.4 The Restart Screen

System restart allows you to reboot the ZyXEL Device remotely without turning the power off. You may need to do this if the ZyXEL Device hangs, for example.

Click **Maintenance > Tools > Restart**. Click **Restart** to have the ZyXEL Device reboot. This does not affect the ZyXEL Device's configuration.

Figure 112 Maintenance > Tools > Restart



Diagnostic

22.1 Overview

These read-only screens display information to help you identify problems with the ZyXEL Device.

22.1.1 What You Can Do in the Diagnostic Screens

- Use the **General Diagnostic** screen ([Section 22.2 on page 223](#)) to ping an IP address.
- Use the **DSL Line Diagnostic** screen ([Section 22.3 on page 224](#)) to view the DSL line statistics and reset the ADSL line.

22.2 The General Diagnostic Screen

Use this screen to ping an IP address. Click **Maintenance > Diagnostic** to open the screen shown next.

Figure 113 Maintenance > Diagnostic > General

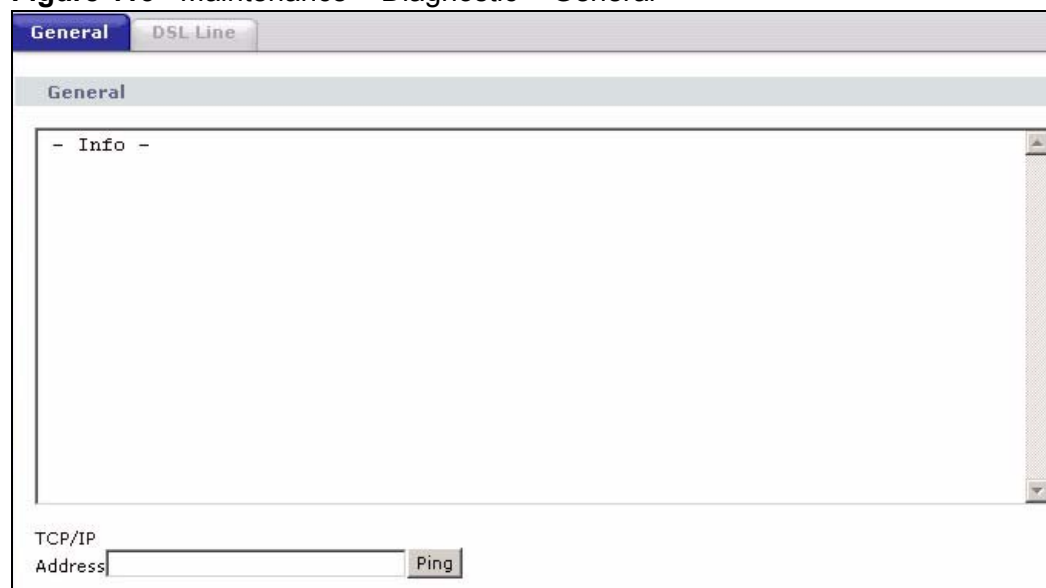

The following table describes the fields in this screen.

Table 91 Maintenance > Diagnostic > General

LABEL	DESCRIPTION
TCP/IP Address	Type the IP address of a computer that you want to ping in order to test a connection.
Ping	Click this to ping the IP address that you entered.

22.3 The DSL Line Diagnostic Screen

Use this screen to view the DSL line statistics and reset the ADSL line. Click **Maintenance > Diagnostic > DSL Line** to open the screen shown next.

Figure 114 Maintenance > Diagnostic > DSL Line

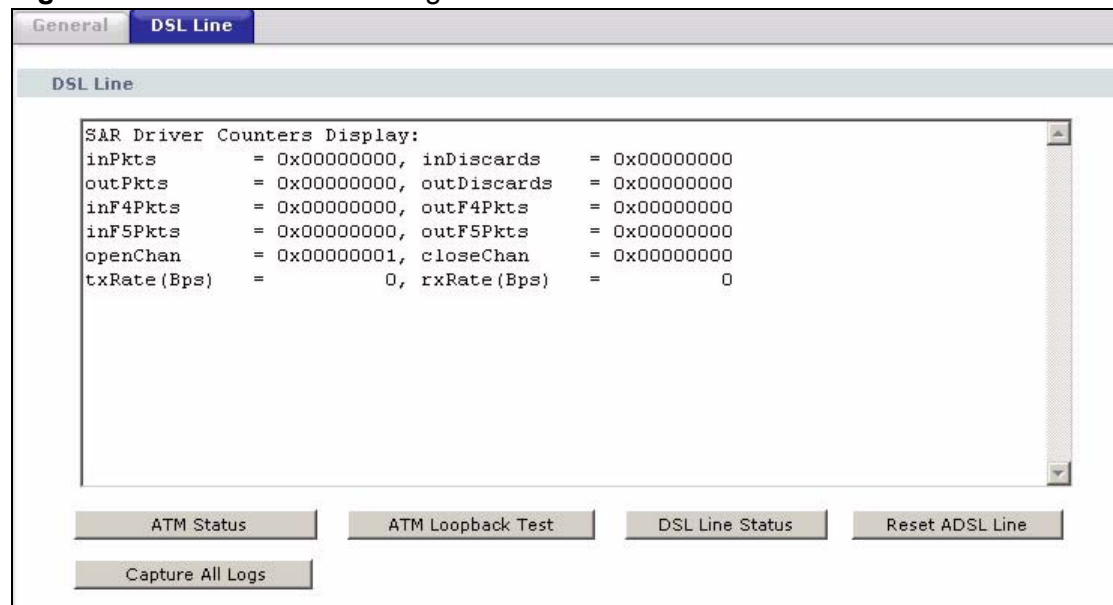

The following table describes the fields in this screen.

Table 92 Maintenance > Diagnostic > DSL Line

LABEL	DESCRIPTION
ATM Status	<p>Click this to view your DSL connection's Asynchronous Transfer Mode (ATM) statistics. ATM is a networking technology that provides high-speed data transfer. ATM uses fixed-size packets of information called cells. With ATM, a high QoS (Quality of Service) can be guaranteed.</p> <p>The (Segmentation and Reassembly) SAR driver translates packets into ATM cells. It also receives ATM cells and reassembles them into packets.</p> <p>These counters are set back to zero whenever the device starts up.</p> <p>inPkts is the number of good ATM cells that have been received.</p> <p>inDiscards is the number of received ATM cells that were rejected.</p> <p>outPkts is the number of ATM cells that have been sent.</p> <p>outDiscards is the number of ATM cells sent that were rejected.</p> <p>inF4Pkts is the number of ATM Operations, Administration, and Management (OAM) F4 cells that have been received. See ITU recommendation I.610 for more on OAM for ATM.</p> <p>outF4Pkts is the number of ATM OAM F4 cells that have been sent.</p> <p>inF5Pkts is the number of ATM OAM F5 cells that have been received.</p> <p>outF5Pkts is the number of ATM OAM F5 cells that have been sent.</p> <p>openChan is the number of times that the ZyXEL Device has opened a logical DSL channel.</p> <p>closeChan is the number of times that the ZyXEL Device has closed a logical DSL channel.</p> <p>txRate is the number of bytes transmitted per second.</p> <p>rxRate is the number of bytes received per second.</p>
ATM Loopback Test	<p>Click this to start the ATM loopback test. Make sure you have configured at least one PVC with proper VPis/VCI before you begin this test. The ZyXEL Device sends an OAM F5 packet to the DSLAM/ATM switch and then returns it (loops it back) to the ZyXEL Device. The ATM loopback test is useful for troubleshooting problems with the DSLAM and ATM network.</p>

Table 92 Maintenance > Diagnostic > DSL Line (continued)

LABEL	DESCRIPTION
DSL Line Status	<p>Click this to view statistics about the DSL connections.</p> <p>noise margin downstream is the signal to noise ratio for the downstream part of the connection (coming into the ZyXEL Device from the ISP). It is measured in decibels. The higher the number the more signal and less noise there is.</p> <p>output power upstream is the amount of power (in decibels) that the ZyXEL Device is using to transmit to the ISP.</p> <p>attenuation downstream is the reduction in amplitude (in decibels) of the DSL signal coming into the ZyXEL Device from the ISP.</p> <p>Discrete Multi-Tone (DMT) modulation divides up a line's bandwidth into sub-carriers (sub-channels) of 4.3125 KHz each called tones. The rest of the display is the line's bit allocation. This is displayed as the number (in hexadecimal format) of bits transmitted for each tone. This can be used to determine the quality of the connection, whether a given sub-carrier loop has sufficient margins to support certain ADSL transmission rates, and possibly to determine whether particular specific types of interference or line attenuation exist. Refer to the ITU-T G.992.1 recommendation for more information on DMT.</p> <p>The better (or shorter) the line, the higher the number of bits transmitted for a DMT tone. The maximum number of bits that can be transmitted per DMT tone is 15. There will be some tones without any bits as there has to be space between the upstream and downstream channels.</p>
Reset ADSL Line	<p>Click this to reinitialize the ADSL line. The large text box above then displays the progress and results of this operation, for example:</p> <pre data-bbox="540 1119 971 1245">"Start to reset ADSL Loading ADSL modem F/W... Reset ADSL Line Successfully!"</pre>
Capture All Logs	<p>Click this to display information and statistics about your ZyXEL Device's ATM statistics, DSL connection statistics, DHCP settings, firmware version, WAN and gateway IP address, VPI/VCI and LAN IP address.</p>

Troubleshooting

This chapter offers some suggestions to solve problems you might encounter. The potential problems are divided into the following categories.

- [Power, Hardware Connections, and LEDs](#)
- [ZyXEL Device Access and Login](#)
- [Internet Access](#)

23.1 Power, Hardware Connections, and LEDs

The ZyXEL Device does not turn on. None of the LEDs turn on.

- 1 Make sure the ZyXEL Device is turned on.
- 2 Make sure you are using the power adaptor or cord included with the ZyXEL Device.
- 3 Make sure the power adaptor or cord is connected to the ZyXEL Device and plugged in to an appropriate power source. Make sure the power source is turned on.
- 4 Turn the ZyXEL Device off and on.
- 5 If the problem continues, contact the vendor.

One of the LEDs does not behave as expected.

- 1 Make sure you understand the normal behavior of the LED. See [Section 1.5 on page 25](#).

- 2 Check the hardware connections.
- 3 Inspect your cables for damage. Contact the vendor to replace any damaged cables.
- 4 Turn the ZyXEL Device off and on.
- 5 If the problem continues, contact the vendor.

23.2 ZyXEL Device Access and Login

I forgot the IP address for the ZyXEL Device.

- 1 The default IP address is **192.168.1.1**.
- 2 If you changed the IP address and have forgotten it, you might get the IP address of the ZyXEL Device by looking up the IP address of the default gateway for your computer. To do this in most Windows computers, click **Start > Run**, enter **cmd**, and then enter **ipconfig**. The IP address of the **Default Gateway** might be the IP address of the ZyXEL Device (it depends on the network), so enter this IP address in your Internet browser.
- 3 If this does not work, you have to reset the device to its factory defaults. See [Section 1.6 on page 26](#).

I forgot the password.

- 1 The default admin password is **1234**.
- 2 If this does not work, you have to reset the device to its factory defaults. See [Section 1.6 on page 26](#).

I cannot see or access the **Login** screen in the web configurator.

- 1 Make sure you are using the correct IP address.
 - The default IP address is [192.168.1.1](#).

- If you changed the IP address ([Section 7.2 on page 87](#)), use the new IP address.
 - If you changed the IP address and have forgotten it, see the troubleshooting suggestions for [I forgot the IP address for the ZyXEL Device](#).
- 2 Check the hardware connections, and make sure the LEDs are behaving as expected. See the Quick Start Guide.
 - 3 Make sure your Internet browser does not block pop-up windows and has JavaScripts and Java enabled. See [Appendix C on page 279](#).
 - 4 Make sure your computer is in the same subnet as the ZyXEL Device. (If there are routers between your computer and the ZyXEL Device, skip this step.)
 - If there is a DHCP server on your network, make sure your computer is using a dynamic IP address. See [Appendix A on page 241](#). Your ZyXEL Device is a DHCP server by default.
 - If there is no DHCP server on your network, make sure your computer's IP address is in the same subnet as the ZyXEL Device. See [Appendix A on page 241](#).
 - 5 Reset the device to its factory defaults, and try to access the ZyXEL Device with the default IP address. See [Section 1.6 on page 26](#).
 - 6 If the problem continues, contact the network administrator or vendor, or try one of the advanced suggestions.

Advanced Suggestions

- Try to access the ZyXEL Device using another service, such as Telnet. If you can access the ZyXEL Device, check the remote management settings and firewall rules to find out why the ZyXEL Device does not respond to HTTP.
- If your computer is connected to the **WAN** port or is connected wirelessly, use a computer that is connected to a **ETHERNET** port.

I can see the **Login** screen, but I cannot log in to the ZyXEL Device.

- 1 Make sure you have entered the password correctly. The default admin password is **1234**. The field is case-sensitive, so make sure [Caps Lock] is not on.
- 2 You cannot log in to the web configurator while someone is using Telnet to access the ZyXEL Device. Log out of the ZyXEL Device in the other session, or ask the person who is logged in to log out.
- 3 Turn the ZyXEL Device off and on.

- 4 If this does not work, you have to reset the device to its factory defaults. See [Section 23.1 on page 227](#).

I cannot Telnet to the ZyXEL Device.

See the troubleshooting suggestions for [I cannot see or access the Login screen in the web configurator](#). Ignore the suggestions about your browser.

I cannot use FTP to upload / download the configuration file. / I cannot use FTP to upload new firmware.

See the troubleshooting suggestions for [I cannot see or access the Login screen in the web configurator](#). Ignore the suggestions about your browser.

23.3 Internet Access

I cannot access the Internet.

- 1 Check the hardware connections, and make sure the LEDs are behaving as expected. See the Quick Start Guide and [Section 1.5 on page 25](#).
- 2 Make sure you entered your ISP account information correctly in the wizard. These fields are case-sensitive, so make sure [Caps Lock] is not on.
- 3 If you are trying to access the Internet wirelessly, make sure the wireless settings in the wireless client are the same as the settings in the AP.
- 4 If you are trying to access the Internet wirelessly, make sure you enabled the wireless LAN and have selected the correct channel in the **Wireless LAN > AP** screen.
- 5 Disconnect all the cables from your device, and follow the directions in the Quick Start Guide again.
- 6 If the problem continues, contact your ISP.

I cannot access the Internet anymore. I had access to the Internet (with the ZyXEL Device), but my Internet connection is not available anymore.

- 1 Check the hardware connections, and make sure the LEDs are behaving as expected. See the Quick Start Guide and [Section 1.5 on page 25](#).
- 2 Turn the ZyXEL Device off and on.
- 3 If the problem continues, contact your ISP.

The Internet connection is slow or intermittent.

- 1 There might be a lot of traffic on the network. Look at the LEDs, and check [Section 1.5 on page 25](#). If the ZyXEL Device is sending or receiving a lot of information, try closing some programs that use the Internet, especially peer-to-peer applications.
- 2 Check the signal strength. If the signal strength is low, try moving your computer closer to the ZyXEL Device if possible, and look around to see if there are any devices that might be interfering with the wireless network (for example, microwaves, other wireless networks, and so on).
- 3 Turn the ZyXEL Device off and on.
- 4 If the problem continues, contact the network administrator or vendor, or try one of the advanced suggestions.

Advanced Suggestions

- Check the settings for QoS. If it is disabled, you might consider activating it. If it is enabled, you might consider raising or lowering the priority for some applications.

Product Specifications

The following tables summarize the ZyXEL Device's hardware and firmware features.

24.1 Hardware Specifications

The following table summarizes the ZyXEL Device's hardware features.

Table 93 Hardware Specifications

Dimensions	133mm (L) x 61mm (W) x 163mm (H)
Weight	200g
Power Specification	12VDC 1A
LAN Ethernet Port	One auto-negotiating, auto MDI/MDI-X 10/100 Mbps RJ-45 Ethernet port
ADSL Port	1 RJ-11 for Annex A
802.11n Wireless LAN Access	On-board WLAN module
RESET Button	Press for 10 seconds to restore factory defaults
Antenna	1 internal antenna, 2dBi
WPS Button	1 second: turn on or off WLAN 5 seconds: enable WPS (Wi-Fi Protected Setup)
Operation Temperature	0° C ~ 40° C
Storage Temperature	-20° ~ 60° C
Operation Humidity	20% ~ 90% RH
Storage Humidity	20% ~ 90% RH

Table 93 Hardware Specifications

Compliance and Certifications	EANSI/UL-60950-1 CSA 60950-1 EN60950-1 (1992+A1+A2+A3+A4+A11) IEC 60950-1 FCC Part 15 Class B EN55022 Class B EN61000-3-2 EN61000-3-3 EN61000-4-2 EN61000-4-3 EN61000-4-4 EN61000-4-5 EN61000-4-6 EN61000-4-8 EN61000-4-11 K.21 4KV
Power Adaptor Safety Approvals	ANSI/UL 60950-1 CSA 60950-1 CE mark GS mark or TUV certificate EN60950-1

24.2 Firmware Specifications

The following table summarizes the ZyXEL Device's firmware features.

Table 94 Firmware Specifications

Basic Features	
Default IP Address	192.168.1.1
Default Subnet Mask	255.255.255.0 (24 bits)
Default Admin Password	1234

Table 94 Firmware Specifications (continued)

ADSL Standard Compliance	<p>Support Multi-Mode standard (ANSI T1.413, Issue 2; G.dmt (G.992.1); G.lite (G992.2)).</p> <p>EOC specified in ITU-T G.992.1</p> <p>ADSL2 G.dmt.bis (G.992.3)</p> <p>ADSL2 G.lite.bis (G.992.4)</p> <p>ADSL2+ (G.992.5)</p> <p>Reach Extended ADSL (RE ADSL)</p> <p>SRA (Seamless Rate Adaptation)</p> <p>Auto-negotiating rate adaptation</p> <p>ADSL physical connection ATM AAL5 (ATM Adaptation Layer type 5)</p> <p>Support multi-protocol over AAL5 (RFC2684/1483)</p> <p>Support PPP over ATM AAL5 (RFC2364)</p> <p>PPP over Ethernet support for DSL connection (RFC 2516)</p> <p>Support VC-based and LLC-based multiplexing</p> <p>Support up to 8 PVCs</p> <p>I.610 F4/F5 OAM</p> <p>TR-067/TR-100 supported</p> <p>Annex A,B,I, J,L,M</p> <p>Bit swapping</p>
--------------------------	---

Table 94 Firmware Specifications (continued)

Wireless LAN Features	WDS(wireless client: TBD) IEEE 802.11n Compliance Frequency Range:2.4 GHz Advanced Orthogonal Frequency Division Multiplexing (OFDM) Data Rates:150Mbps and Auto Fallback Wired Equivalent Privacy (WEP) Data Encryption 64/128 WLAN bridge to LAN 32 MAC Address filter WPA, WPA-PSK, WPA2, WPA2-PSK WPS IEEE 802.1x (EAP-MD5, TLS and TTLS) WMM Multi BSSID (4 BSSIDs) Wireless Scheduling
Firewall	DoS Protocol and Generic Packet Filter Stateful Inspection Access Control List (ACL) between LAN, WAN Real time alert via e-mail Report and logs 20 ACL rules
Content Filtering	URL Keyword Blocking
NAT	Muti-NAT & Port Address Translation (PAT) 2048 NAT session Cone NAT Multimedia applications support (NetMeeting, CuSeeMe, ICQ, ...etc) Microsoft PPTP under NAT/SUA Multiple VPN (IPSec/PPTP/L2TP) pass-through NAT loopback 12 NAT port forwarding

Table 94 Firmware Specifications (continued)

UPnP	UPnP DCP UPnP protocols NAT traversal
Protocol Support	SIP pass-through DNS Proxy Dynamic DNS (www.dyndns.org) IP Alias DHCP client/server/relay RIP I/ RIP II supported Support 16 IP Static routes by Gateway IGMP v1 and v2, v3 IP Policy Routing UPnP support Transparent bridging, VLAN-tagging pass-through bridge mode Static DHCP 802.1Q TR-098 complied QoS
Management	Embedded Web Configurator SNMP v1 & v2 with MIB II TR-064 support(Need to support ZyXEL"easy install utility") TR-111 ADSL mode selectable on GUI Embedded FTP/TFTP Server for f/w upgrade and romfile backup and restore Remote Management Control: Telnet, FTP, and Web. TR-069 HTTPS(with motive certification) MTU adjustable on WebGUI
WAN Backup	Traffic redirect
Other features	rom-t Support IGMP Proxy

24.3 Standards Support

The following list, which is not exhaustive, illustrates the standards supported in the ZyXEL Device.

Table 95 Standards Supported

STANDARD	DESCRIPTION
RFC 867	Daytime Protocol
RFC 868	Time Protocol.
RFC 1058	RIP-1 (Routing Information Protocol)
RFC 1112	IGMP v1
RFC 1305	Network Time Protocol (NTP version 3)
RFC 1483	Multiprotocol Encapsulation over ATM Adaptation Layer 5
RFC 1631	IP Network Address Translator (NAT)
RFC 1661	The Point-to-Point Protocol (PPP)
RFC 1723	RIP-2 (Routing Information Protocol)
RFC 2236	Internet Group Management Protocol, Version 2.
RFC 2364	PPP over AAL5 (PPP over ATM over ADSL)
RFC 2408	Internet Security Association and Key Management Protocol (ISAKMP)
RFC 2516	A Method for Transmitting PPP Over Ethernet (PPPoE)
RFC 2684	Multiprotocol Encapsulation over ATM Adaptation Layer 5.
RFC 2766	Network Address Translation - Protocol
IEEE 802.11	Also known by the brand Wi-Fi, denotes a set of Wireless LAN/WLAN standards developed by working group 11 of the IEEE LAN/MAN Standards Committee (IEEE 802).
IEEE 802.11b	Uses the 2.4 gigahertz (GHz) band
IEEE 802.11g	Uses the 2.4 gigahertz (GHz) band
IEEE 802.11n	Uses the 2.4 gigahertz (GHz) band
IEEE 802.11d	Standard for Local and Metropolitan Area Networks: Media Access Control (MAC) Bridges
IEEE 802.11x	Port Based Network Access Control.
IEEE 802.11e QoS	IEEE 802.11 e Wireless LAN for Quality of Service
ANSI T1.413, Issue 2	Asymmetric Digital Subscriber Line (ADSL) standard.
G dmt(G.992.1)	G.992.1 Asymmetrical Digital Subscriber Line (ADSL) Transceivers
ITU G.992.1 (G.DMT)	ITU standard for ADSL using discrete multitone modulation.
ITU G.992.2 (G. Lite)	ITU standard for ADSL using discrete multitone modulation.
ITU G.992.3 (G.dmt.bis)	ITU standard (also referred to as ADSL2) that extends the capability of basic ADSL in data rates.
ITU G.992.4 (G.lite.bis)	ITU standard (also referred to as ADSL2) that extends the capability of basic ADSL in data rates.

Table 95 Standards Supported (continued)

STANDARD	DESCRIPTION
ITU G.992.5 (ADSL2+)	ITU standard (also referred to as ADSL2+) that extends the capability of basic ADSL by doubling the number of downstream bits.
Microsoft PPTP	MS PPTP (Microsoft's implementation of Point to Point Tunneling Protocol)
MBM v2	Media Bandwidth Management v2
RFC 2383	ST2+ over ATM Protocol Specification - UNI 3.1 Version
TR-069	TR-069 DSL Forum Standard for CPE Wan Management.
1.363.5	Compliant AAL5 SAR (Segmentation And Re-assembly)

Setting Up Your Computer's IP Address

Note: Your specific ZyXEL Device may not support all of the operating systems described in this appendix. See the product specifications for more information about which operating systems are supported.

This appendix shows you how to configure the IP settings on your computer in order for it to be able to communicate with the other devices on your network. Windows Vista/XP/2000, Mac OS 9/OS X, and all versions of UNIX/LINUX include the software components you need to use TCP/IP on your computer.

If you manually assign IP information instead of using a dynamic IP, make sure that your network's computers have IP addresses that place them in the same subnet.

In this appendix, you can set up an IP address for:

- [Windows XP/NT/2000](#) on [page 242](#)
- [Windows Vista](#) on [page 245](#)
- [Windows 7](#) on [page 249](#)
- [Mac OS X: 10.3 and 10.4](#) on [page 253](#)
- [Mac OS X: 10.5 and 10.6](#) on [page 256](#)
- [Linux: Ubuntu 8 \(GNOME\)](#) on [page 259](#)
- [Linux: openSUSE 10.3 \(KDE\)](#) on [page 264](#)

Windows XP/NT/2000

The following example uses the default Windows XP display theme but can also apply to Windows 2000 and Windows NT.

- 1 Click **Start > Control Panel**.

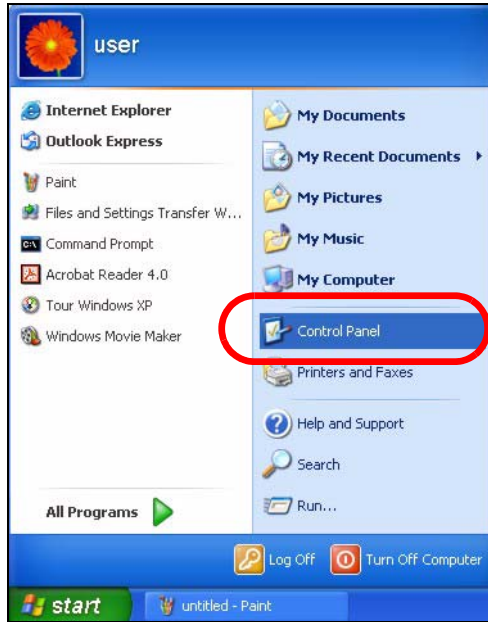

- 2 In the **Control Panel**, click the **Network Connections** icon.

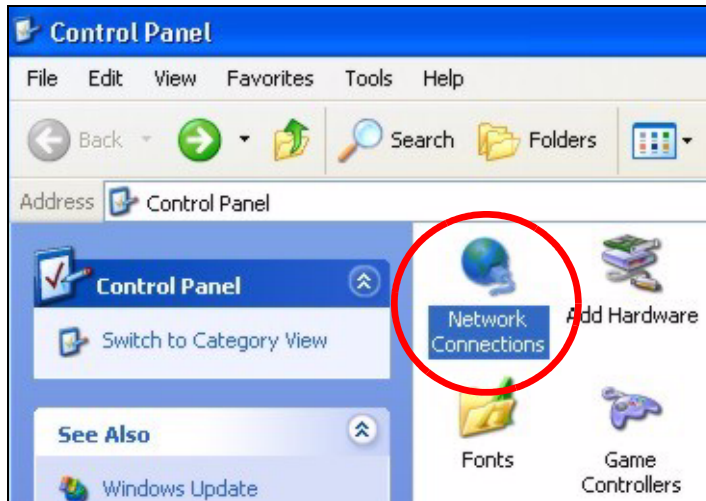

- 3 Right-click **Local Area Connection** and then select **Properties**.

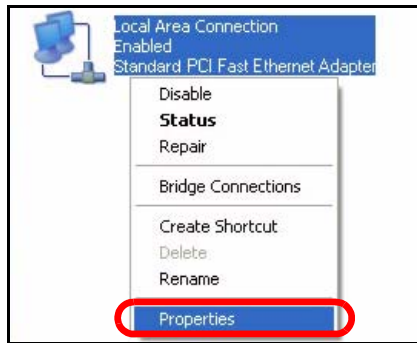

- 4 On the **General** tab, select **Internet Protocol (TCP/IP)** and then click **Properties**.

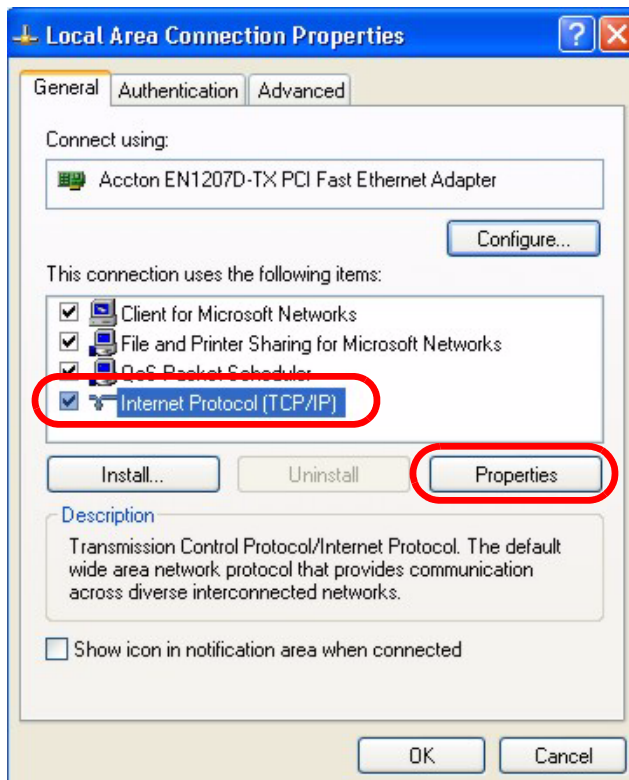

- 5 The **Internet Protocol TCP/IP Properties** window opens.

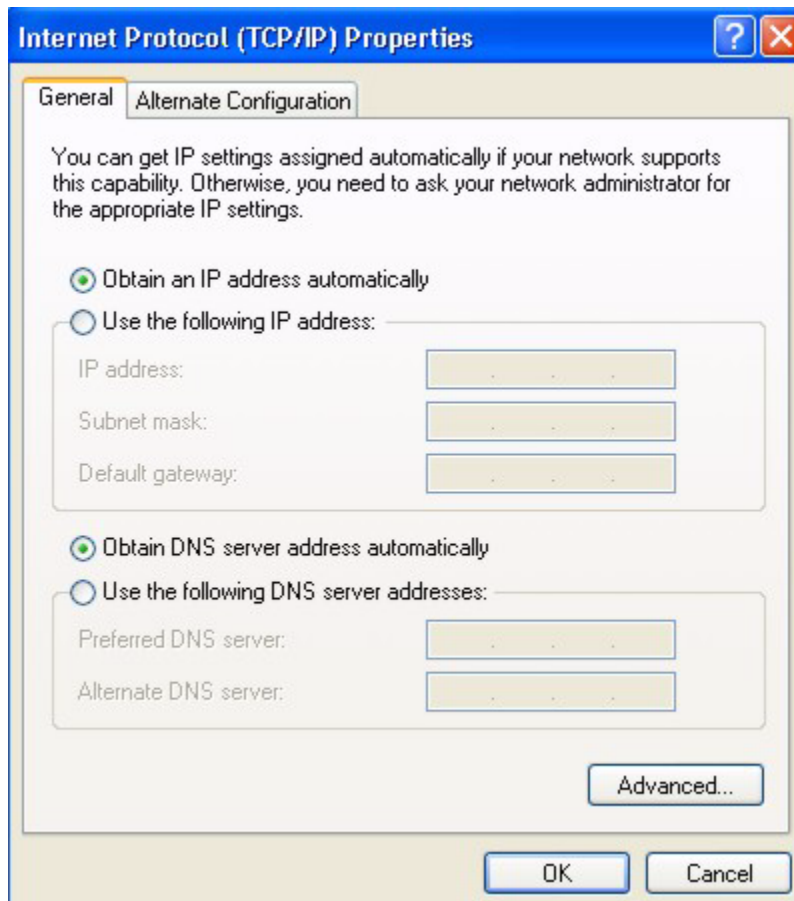

- 6 Select **Obtain an IP address automatically** if your network administrator or ISP assigns your IP address dynamically.

Select **Use the following IP Address** and fill in the **IP address**, **Subnet mask**, and **Default gateway** fields if you have a static IP address that was assigned to you by your network administrator or ISP. You may also have to enter a **Preferred DNS server** and an **Alternate DNS server**, if that information was provided.

- 7 Click **OK** to close the **Internet Protocol (TCP/IP) Properties** window.
- 8 Click **OK** to close the **Local Area Connection Properties** window.

Verifying Settings

- 1 Click **Start > All Programs > Accessories > Command Prompt**.
- 2 In the **Command Prompt** window, type "ipconfig" and then press [ENTER].

You can also go to **Start > Control Panel > Network Connections**, right-click a network connection, click **Status** and then click the **Support** tab to view your IP address and connection information.

Windows Vista

This section shows screens from Windows Vista Professional.

- 1 Click **Start > Control Panel**.

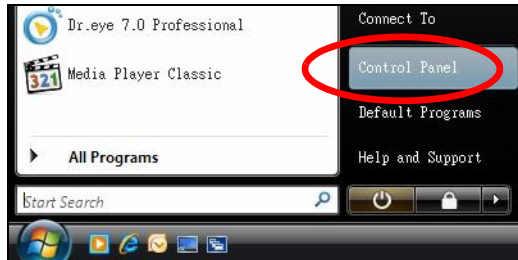

- 2 In the **Control Panel**, click the **Network and Internet** icon.

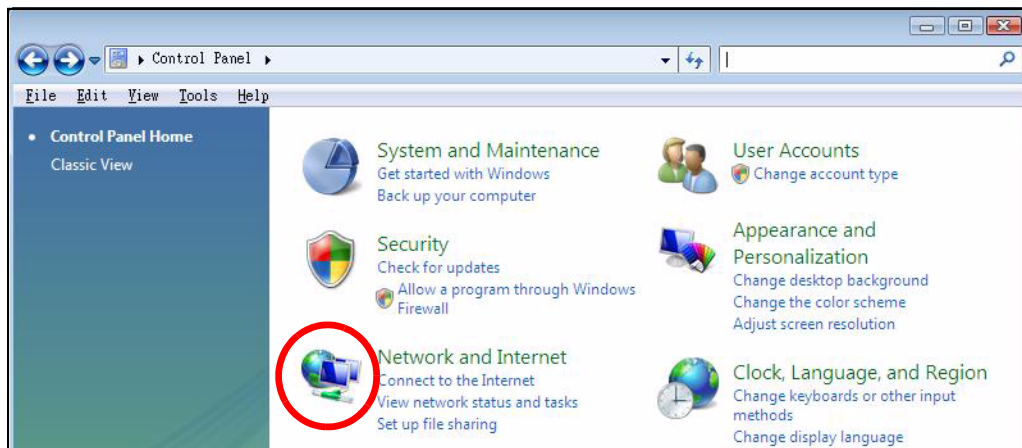

- 3 Click the **Network and Sharing Center** icon.

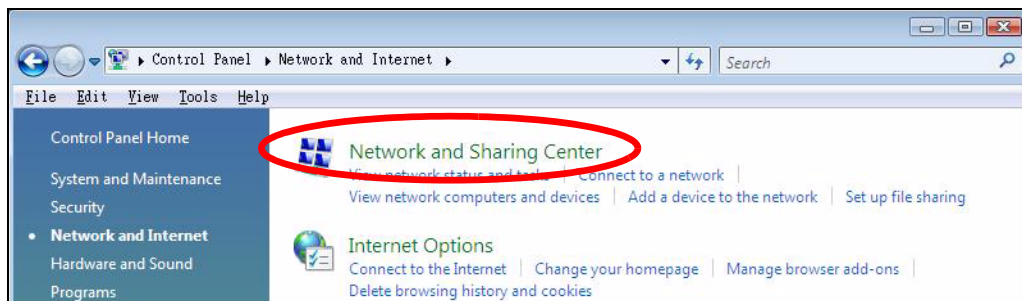

4 Click **Manage network connections**.

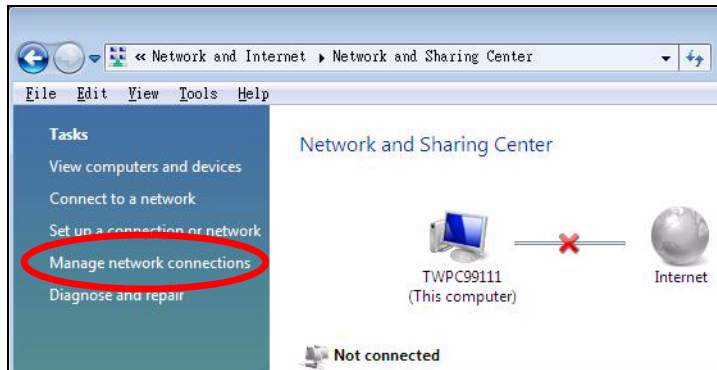

5 Right-click **Local Area Connection** and then select **Properties**.

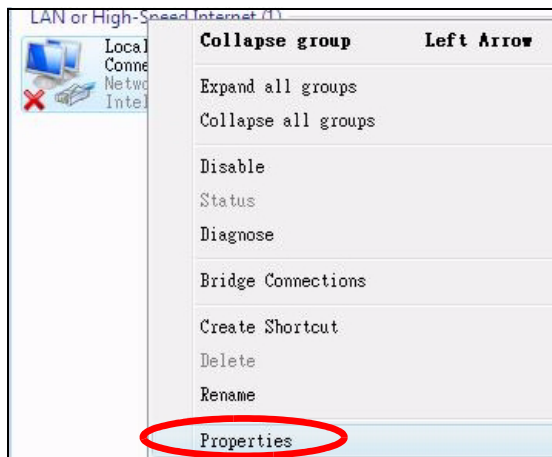

Note: During this procedure, click **Continue** whenever Windows displays a screen saying that it needs your permission to continue.

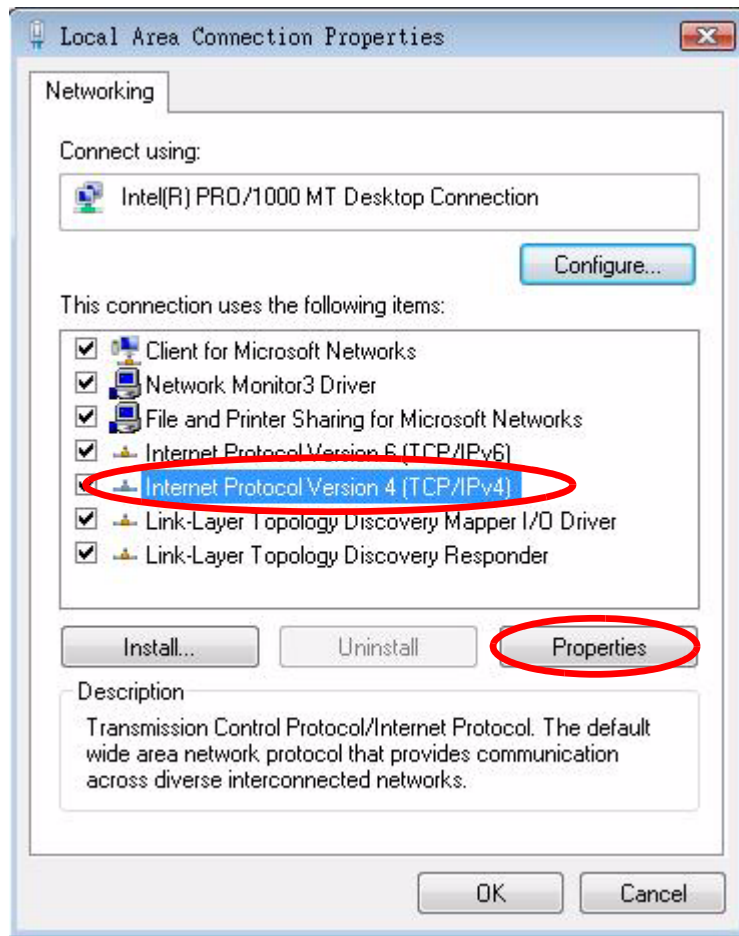
6 Select Internet Protocol Version 4 (TCP/IPv4) and then select Properties.

- 7 The **Internet Protocol Version 4 (TCP/IPv4) Properties** window opens.

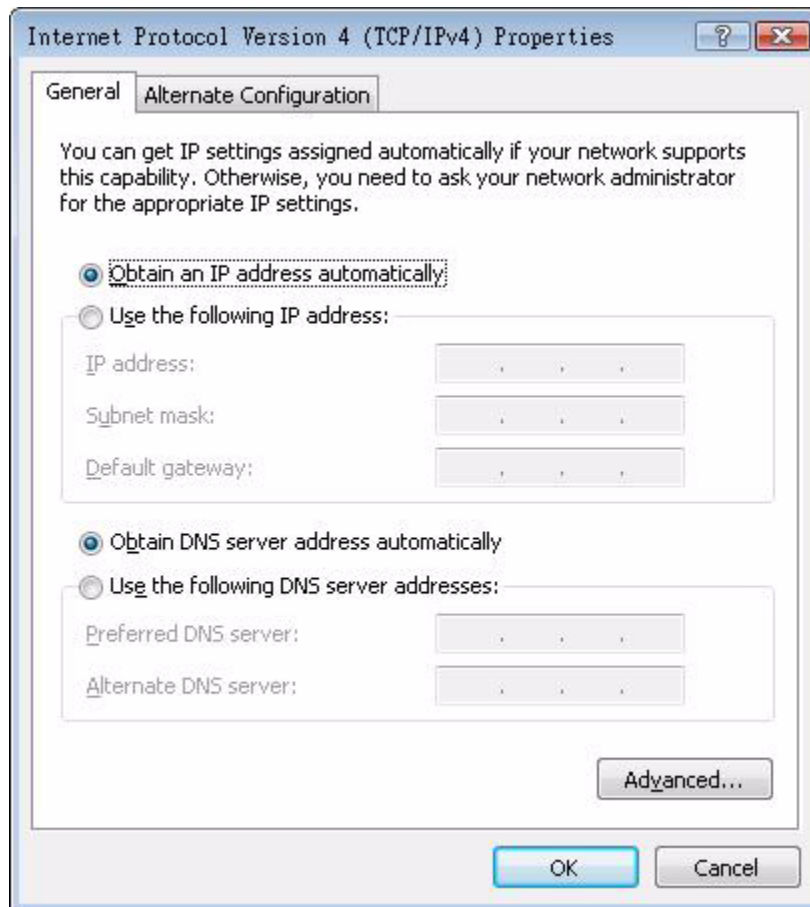

- 8 Select **Obtain an IP address automatically** if your network administrator or ISP assigns your IP address dynamically.

Select **Use the following IP Address** and fill in the **IP address**, **Subnet mask**, and **Default gateway** fields if you have a static IP address that was assigned to you by your network administrator or ISP. You may also have to enter a **Preferred DNS server** and an **Alternate DNS server**, if that information was provided. Click **Advanced**.

- 9 Click **OK** to close the **Internet Protocol (TCP/IP) Properties** window.
- 10 Click **OK** to close the **Local Area Connection Properties** window.

Verifying Settings

- 1 Click **Start > All Programs > Accessories > Command Prompt**.
- 2 In the **Command Prompt** window, type "ipconfig" and then press [ENTER].

You can also go to **Start > Control Panel > Network Connections**, right-click a network connection, click **Status** and then click the **Support** tab to view your IP address and connection information.

Windows 7

This section shows screens from Windows 7 Enterprise.

- 1 Click **Start > Control Panel**.

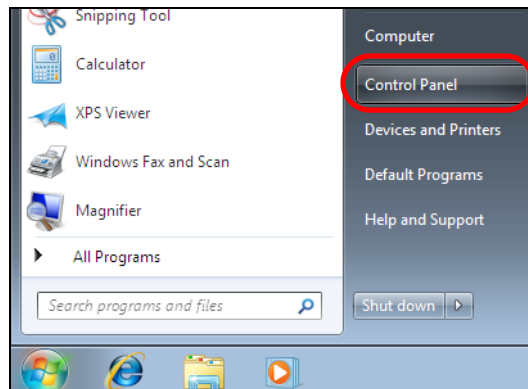

- 2 In the **Control Panel**, click **View network status and tasks** under the **Network and Internet** category.

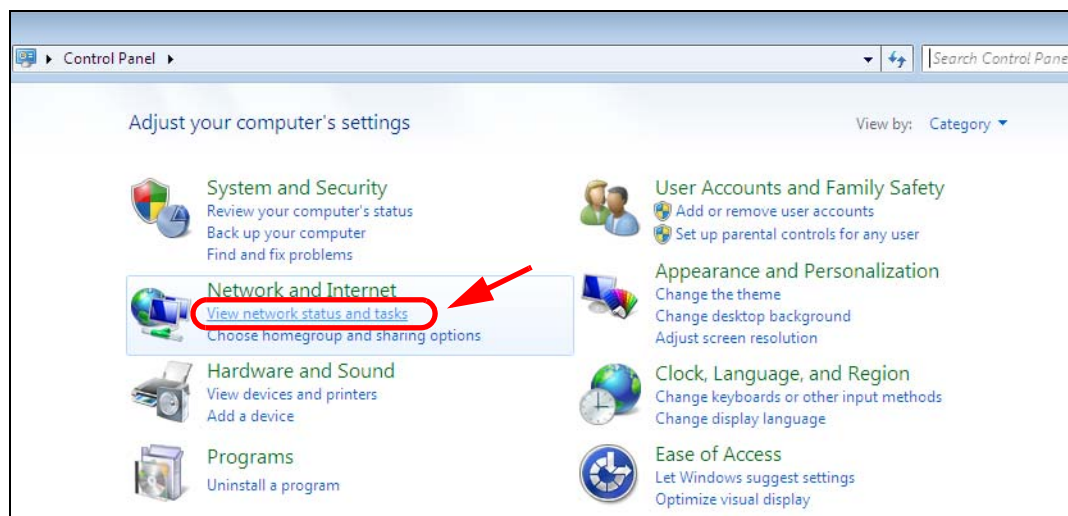

3 Click **Change adapter settings**.

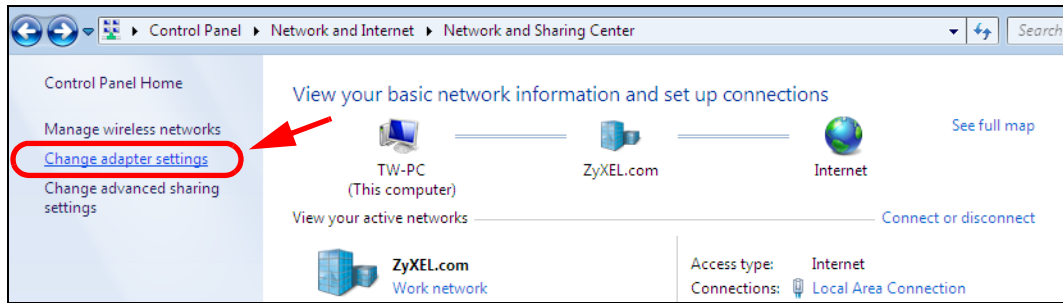

4 Double click **Local Area Connection** and then select **Properties**.

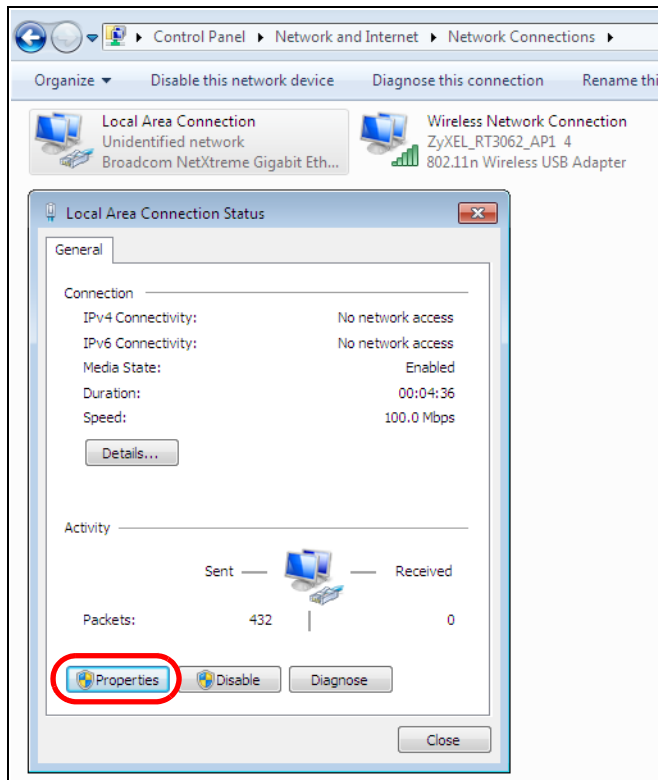

Note: During this procedure, click **Continue** whenever Windows displays a screen saying that it needs your permission to continue.

5 Select **Internet Protocol Version 4 (TCP/IPv4)** and then select **Properties**.

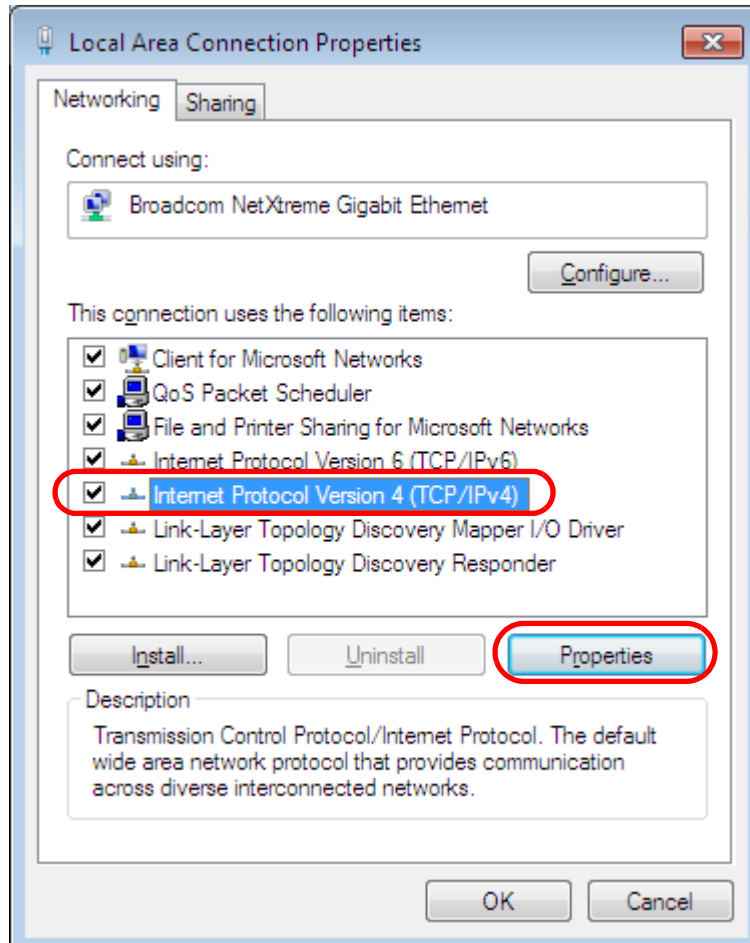

- The **Internet Protocol Version 4 (TCP/IPv4) Properties** window opens.

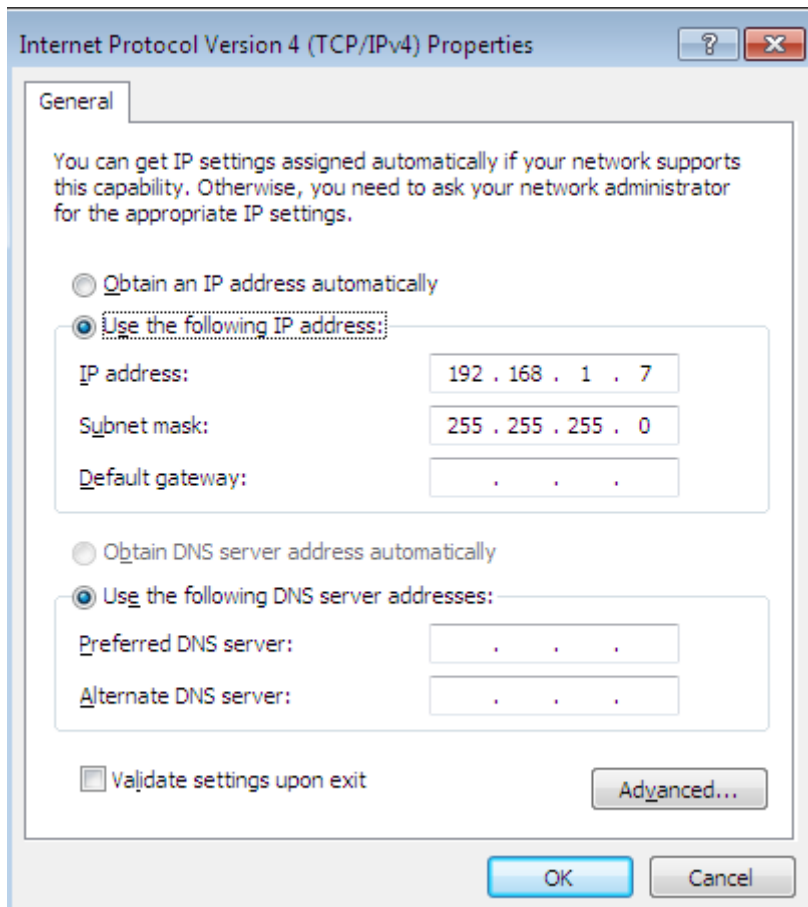

- Select **Obtain an IP address automatically** if your network administrator or ISP assigns your IP address dynamically.

Select **Use the following IP Address** and fill in the **IP address**, **Subnet mask**, and **Default gateway** fields if you have a static IP address that was assigned to you by your network administrator or ISP. You may also have to enter a **Preferred DNS server** and an **Alternate DNS server**, if that information was provided. Click **Advanced** if you want to configure advanced settings for IP, DNS and WINS.

- Click **OK** to close the **Internet Protocol (TCP/IP) Properties** window.
- Click **OK** to close the **Local Area Connection Properties** window.

Verifying Settings

- 1 Click **Start > All Programs > Accessories > Command Prompt**.
- 2 In the **Command Prompt** window, type "ipconfig" and then press [ENTER].
- 3 The IP settings are displayed as follows.

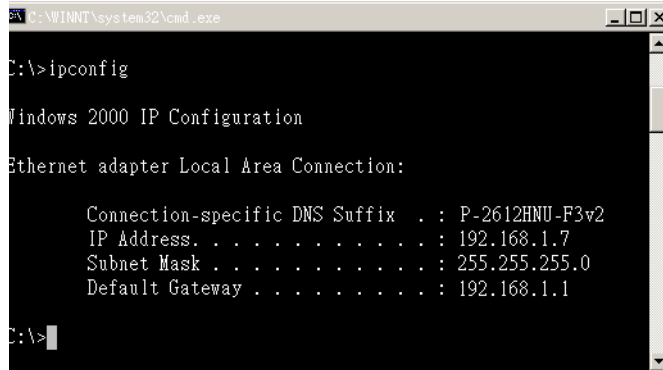

```
C:\WINNT\system32\cmd.exe
C:\>ipconfig

Windows 2000 IP Configuration

Ethernet adapter Local Area Connection:

    Connection-specific DNS Suffix  . : P-2612HNU-F3v2
    IP Address. . . . . : 192.168.1.7
    Subnet Mask . . . . . : 255.255.255.0
    Default Gateway . . . . . : 192.168.1.1

C:\>
```

Mac OS X: 10.3 and 10.4

The screens in this section are from Mac OS X 10.4 but can also apply to 10.3.

- 1 Click **Apple > System Preferences**.

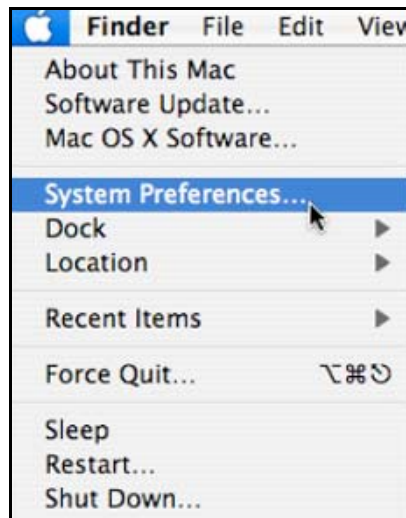

- 2 In the **System Preferences** window, click the **Network** icon.



- 3 When the **Network** preferences pane opens, select **Built-in Ethernet** from the network connection type list, and then click **Configure**.

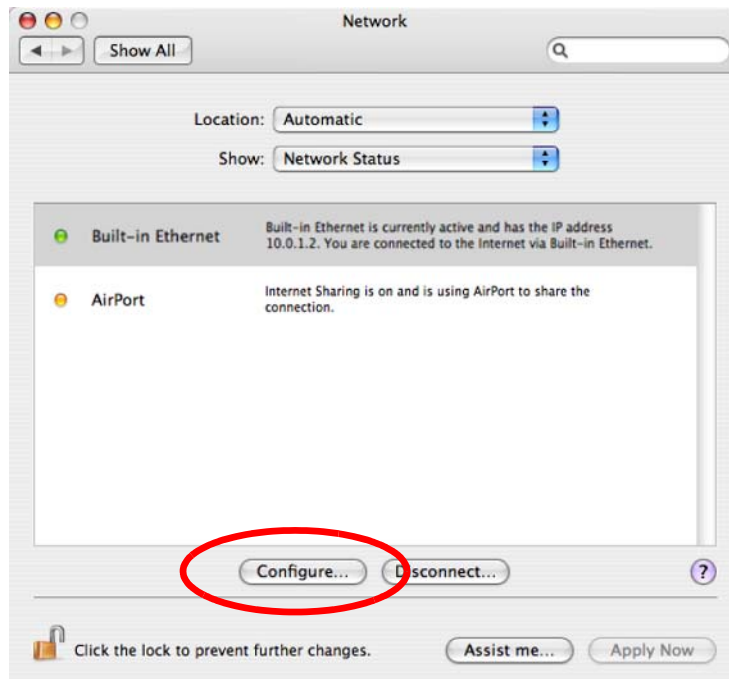

- For dynamically assigned settings, select **Using DHCP** from the **Configure IPv4** list in the **TCP/IP** tab.

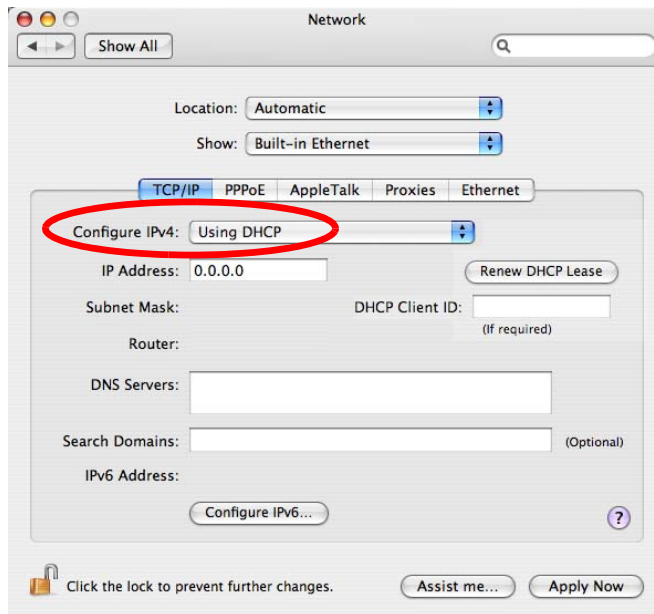

- For statically assigned settings, do the following:
 - From the **Configure IPv4** list, select **Manually**.
 - In the **IP Address** field, type your IP address.
 - In the **Subnet Mask** field, type your subnet mask.
 - In the **Router** field, type the IP address of your device.

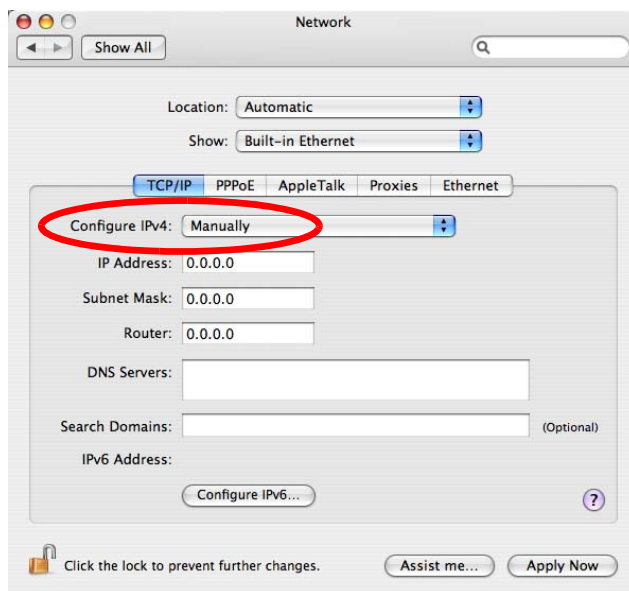

- Click **Apply Now** and close the window.

Verifying Settings

Check your TCP/IP properties by clicking **Applications > Utilities > Network Utilities**, and then selecting the appropriate **Network Interface** from the **Info** tab.

Figure 115 Mac OS X 10.4: Network Utility

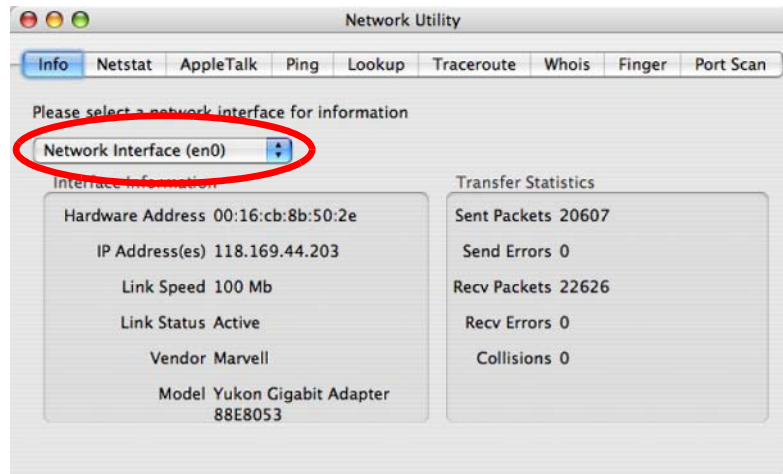

Mac OS X: 10.5 and 10.6

The screens in this section are from Mac OS X 10.5 but can also apply to 10.6.

- 1 Click **Apple > System Preferences**.

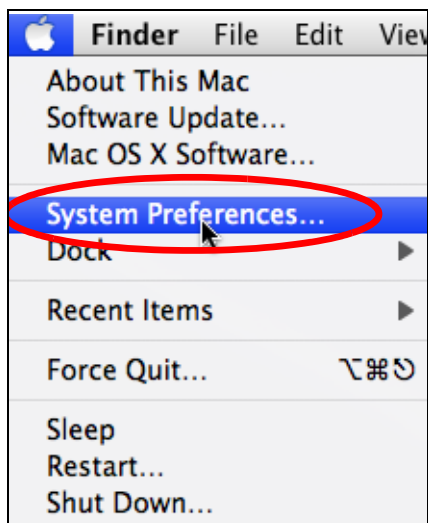

- 2 In **System Preferences**, click the **Network** icon.



- 3 When the **Network** preferences pane opens, select **Ethernet** from the list of available connection types.

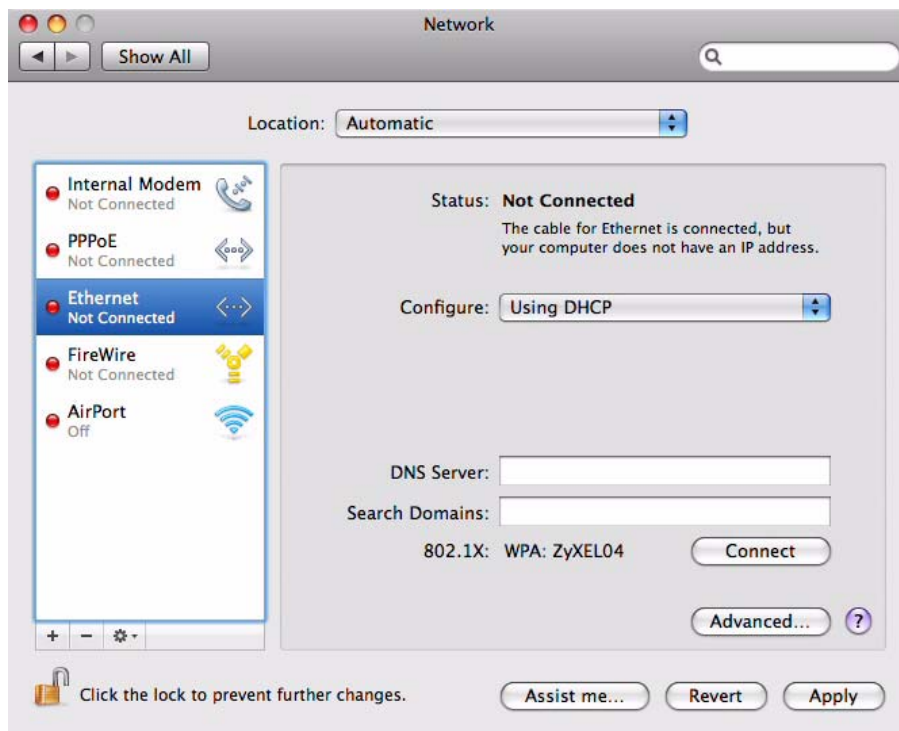

- 4 From the **Configure** list, select **Using DHCP** for dynamically assigned settings.

- 5 For statically assigned settings, do the following:
 - From the **Configure** list, select **Manually**.
 - In the **IP Address** field, enter your IP address.
 - In the **Subnet Mask** field, enter your subnet mask.
 - In the **Router** field, enter the IP address of your ZyXEL Device.

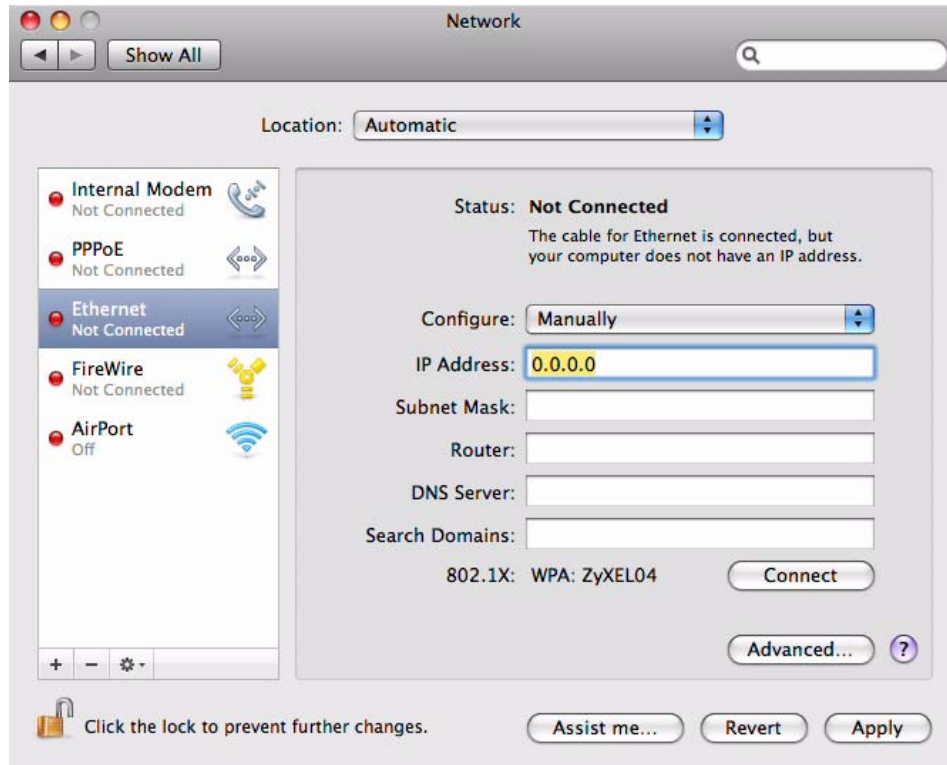

- 6 Click **Apply** and close the window.

Verifying Settings

Check your TCP/IP properties by clicking **Applications > Utilities > Network Utilities**, and then selecting the appropriate **Network interface** from the **Info** tab.

Figure 116 Mac OS X 10.5: Network Utility

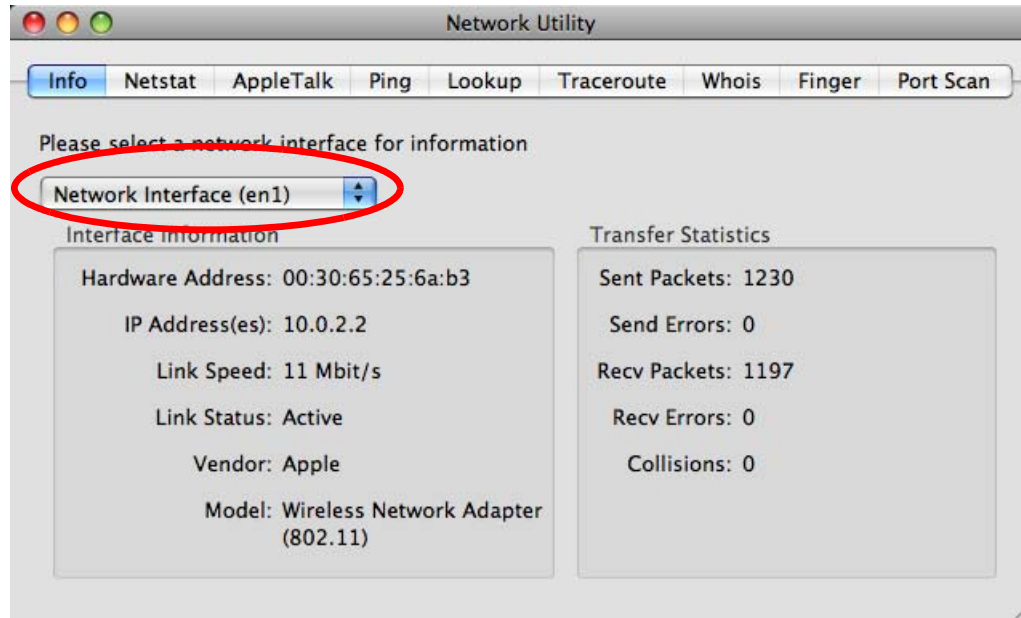

Linux: Ubuntu 8 (GNOME)

This section shows you how to configure your computer's TCP/IP settings in the GNU Object Model Environment (GNOME) using the Ubuntu 8 Linux distribution. The procedure, screens and file locations may vary depending on your specific distribution, release version, and individual configuration. The following screens use the default Ubuntu 8 installation.

Note: Make sure you are logged in as the root administrator.

Follow the steps below to configure your computer IP address in GNOME:

- 1 Click **System > Administration > Network**.

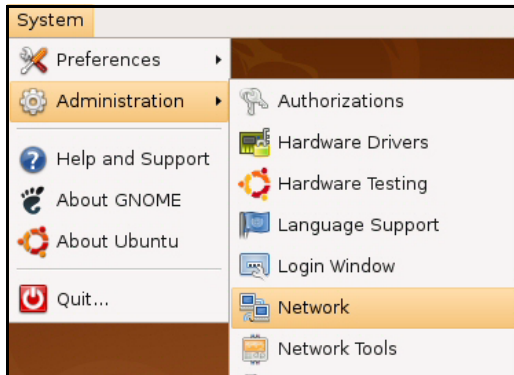

- 2 When the **Network Settings** window opens, click **Unlock** to open the **Authenticate** window. (By default, the **Unlock** button is greyed out until clicked.) You cannot make changes to your configuration unless you first enter your admin password.

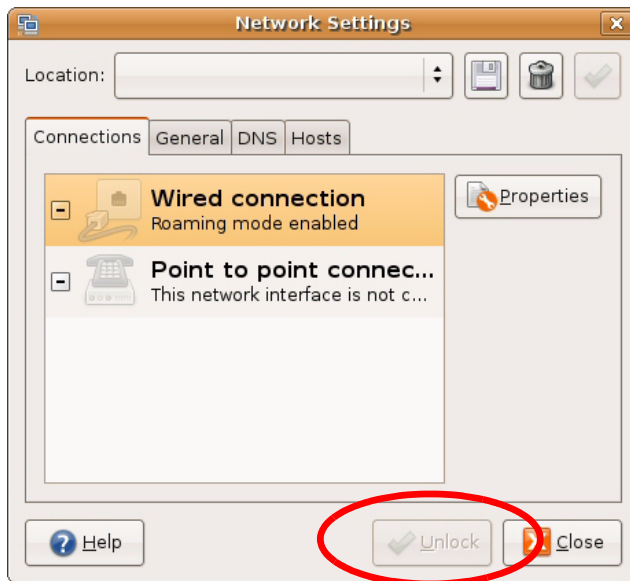

- 3 In the **Authenticate** window, enter your admin account name and password then click the **Authenticate** button.



- 4 In the **Network Settings** window, select the connection that you want to configure, then click **Properties**.

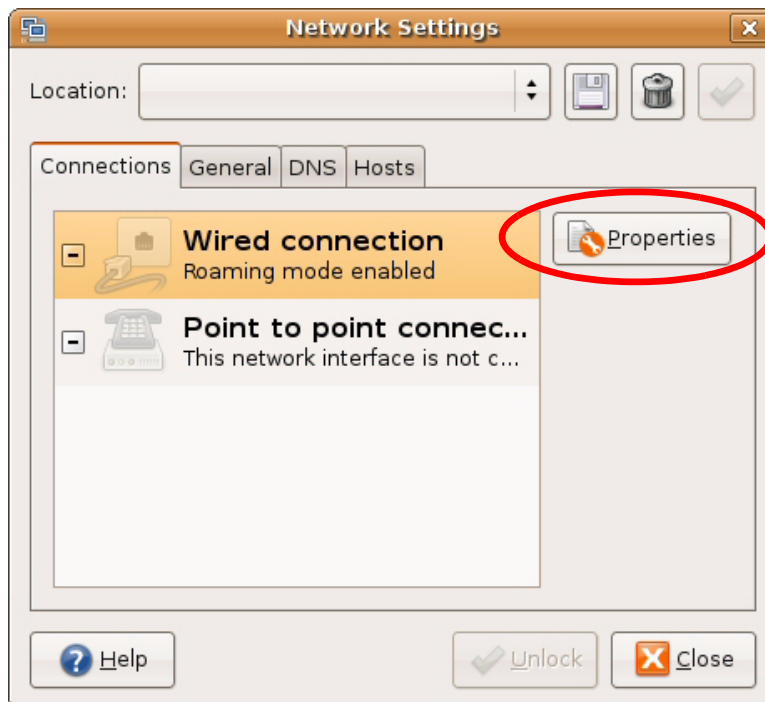

- 5 The **Properties** dialog box opens.



- In the **Configuration** list, select **Automatic Configuration (DHCP)** if you have a dynamic IP address.
 - In the **Configuration** list, select **Static IP address** if you have a static IP address. Fill in the **IP address**, **Subnet mask**, and **Gateway address** fields.
- 6 Click **OK** to save the changes and close the **Properties** dialog box and return to the **Network Settings** screen.
- 7 If you know your DNS server IP address(es), click the **DNS** tab in the **Network Settings** window and then enter the DNS server information in the fields provided.

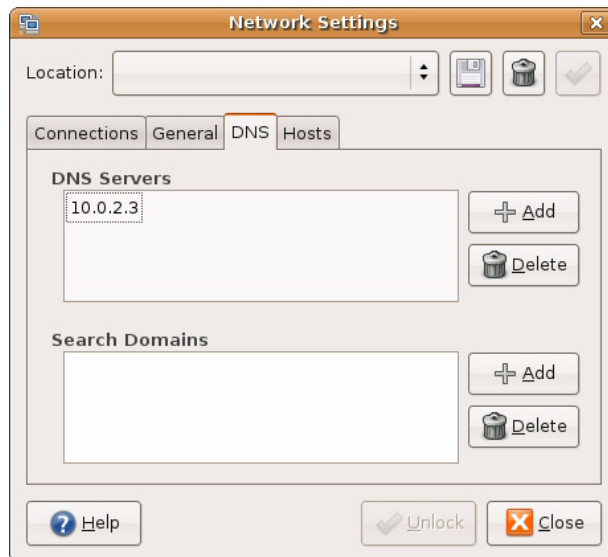

- 8 Click the **Close** button to apply the changes.

Verifying Settings

Check your TCP/IP properties by clicking **System > Administration > Network Tools**, and then selecting the appropriate **Network device** from the **Devices** tab. The **Interface Statistics** column shows data if your connection is working properly.

Figure 117 Ubuntu 8: Network Tools

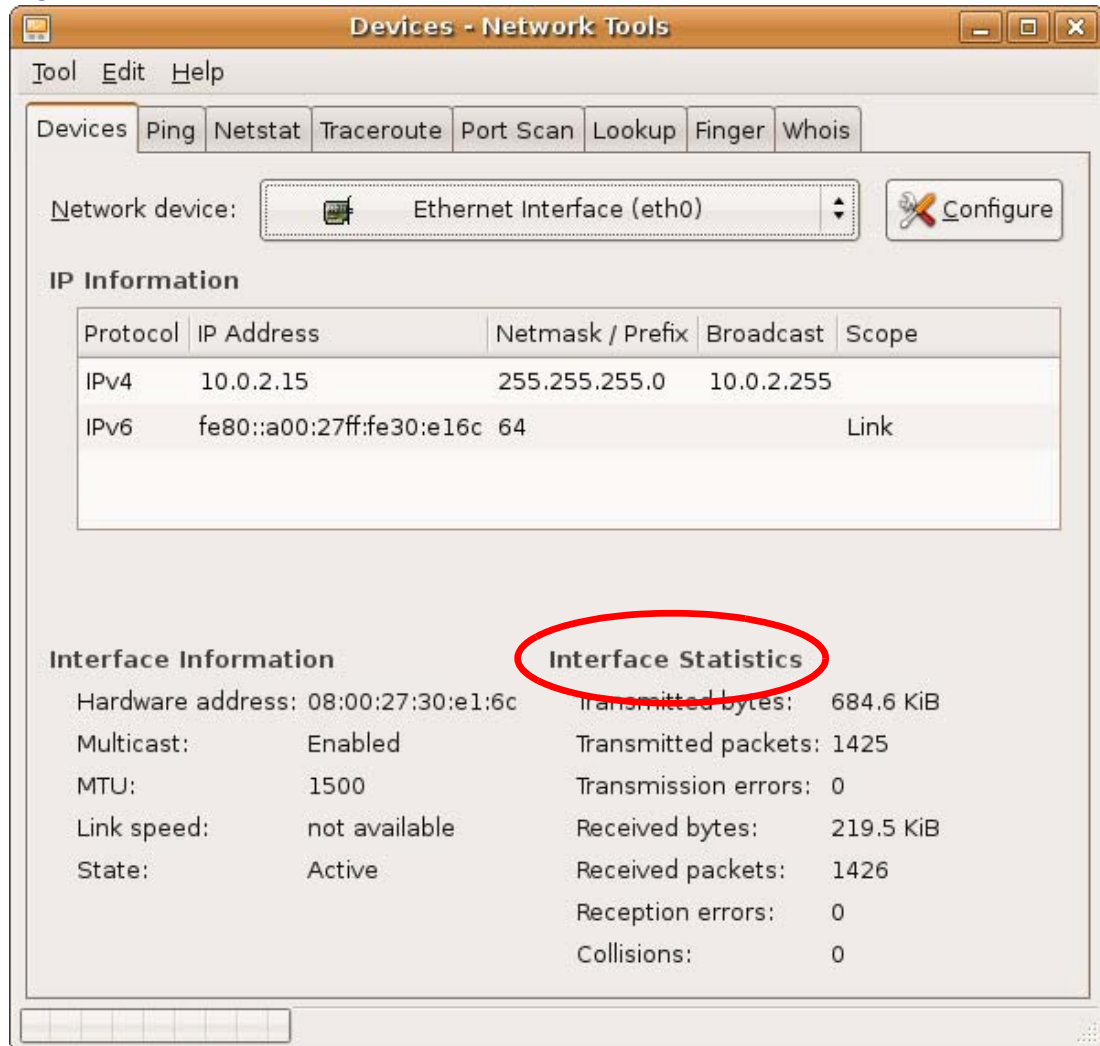

Linux: openSUSE 10.3 (KDE)

This section shows you how to configure your computer's TCP/IP settings in the K Desktop Environment (KDE) using the openSUSE 10.3 Linux distribution. The procedure, screens and file locations may vary depending on your specific distribution, release version, and individual configuration. The following screens use the default openSUSE 10.3 installation.

Note: Make sure you are logged in as the root administrator.

Follow the steps below to configure your computer IP address in the KDE:

- 1 Click **K Menu > Computer > Administrator Settings (YaST)**.

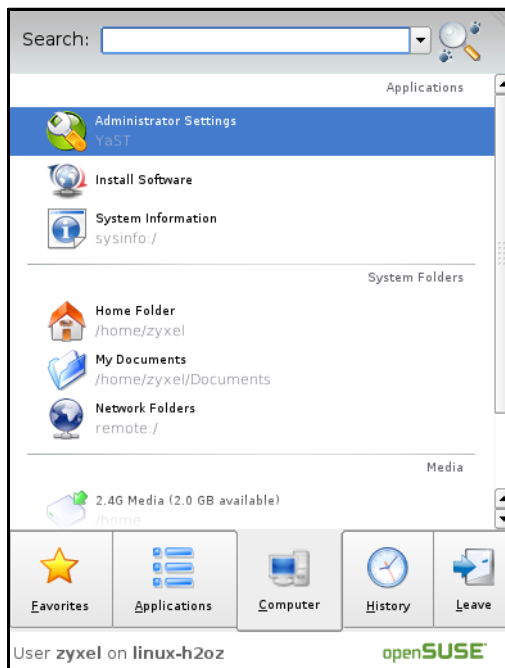

- 2 When the **Run as Root - KDE su** dialog opens, enter the admin password and click **OK**.

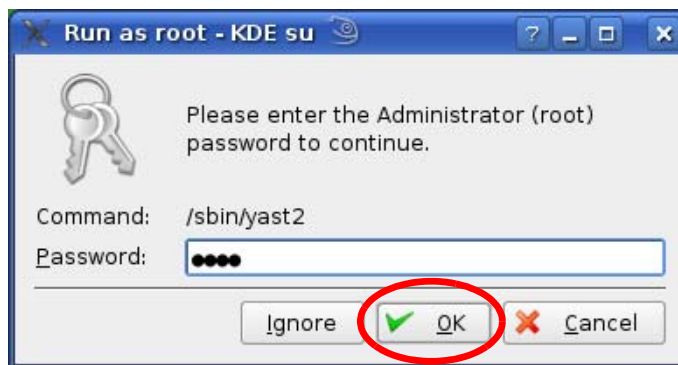

- When the **YaST Control Center** window opens, select **Network Devices** and then click the **Network Card** icon.

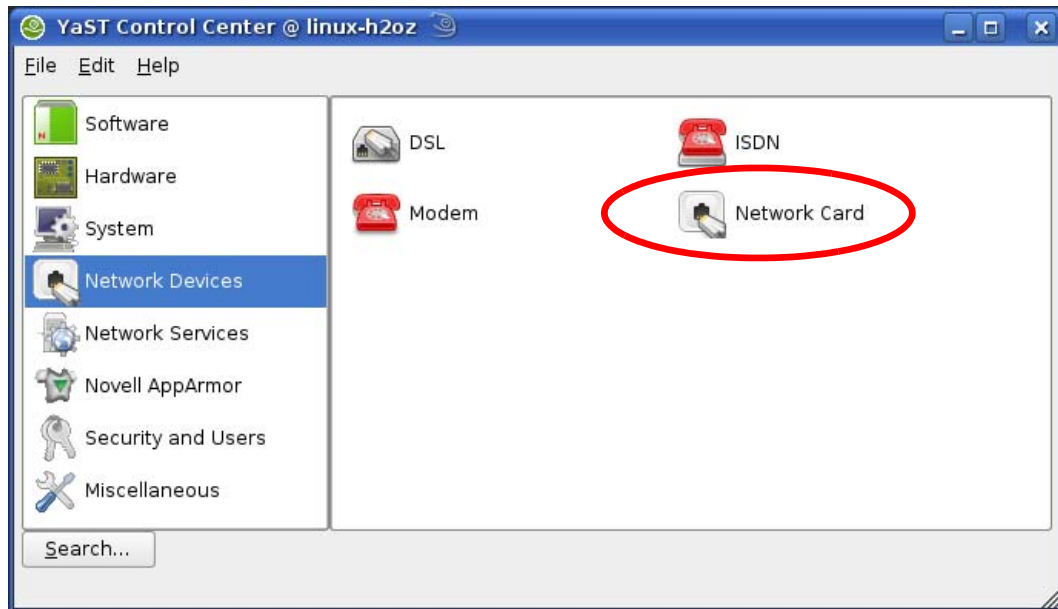

- When the **Network Settings** window opens, click the **Overview** tab, select the appropriate connection **Name** from the list, and then click the **Configure** button.

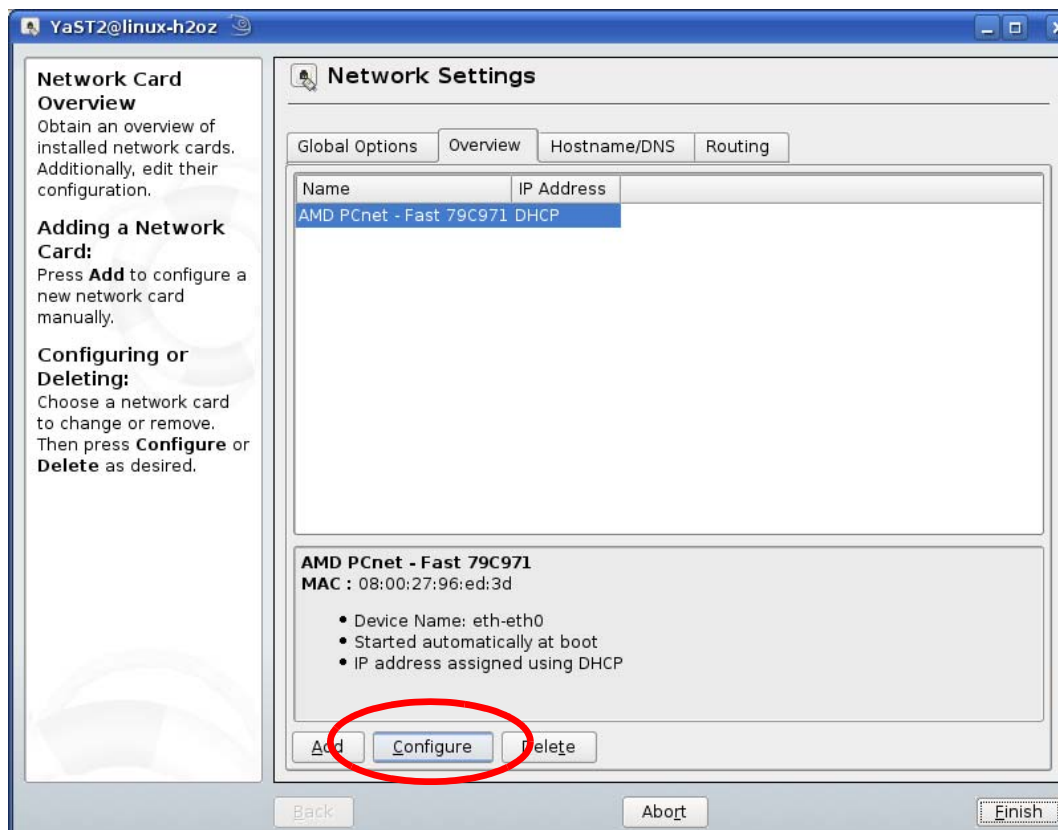

- 5 When the **Network Card Setup** window opens, click the **Address** tab

Figure 118 openSUSE 10.3: Network Card Setup

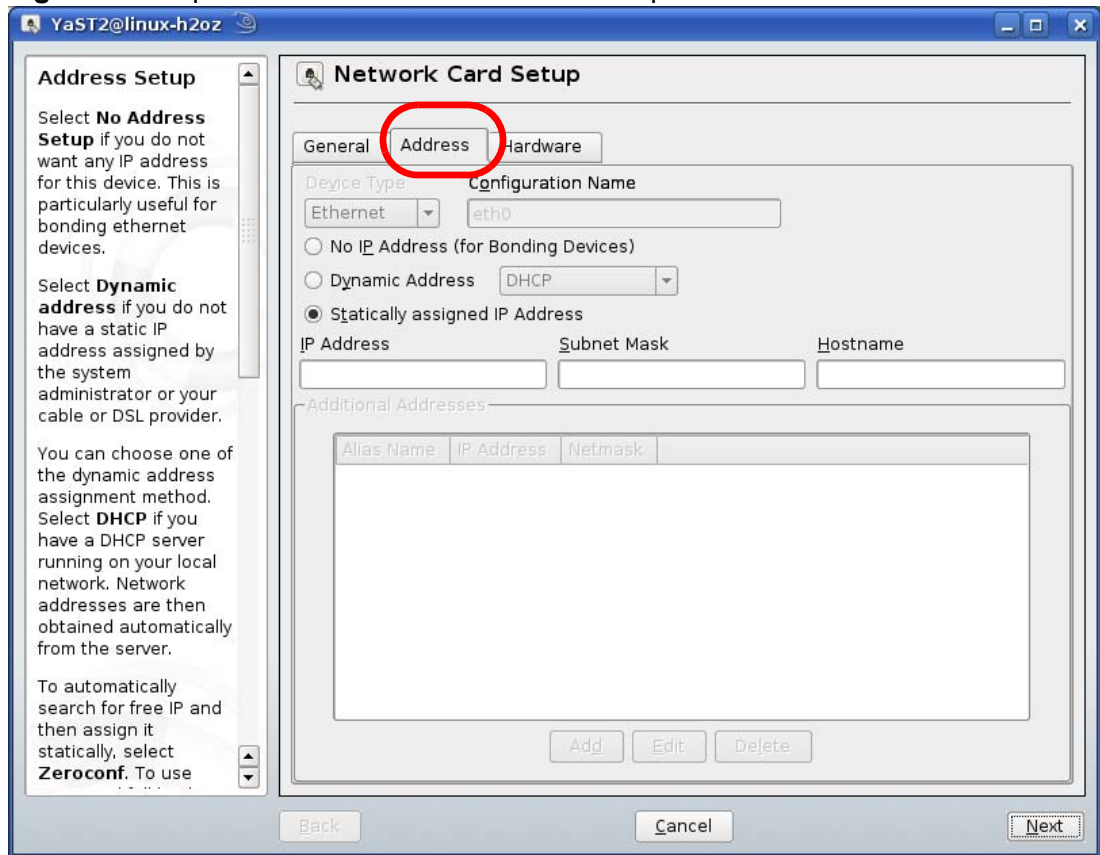

- 6 Select **Dynamic Address (DHCP)** if you have a dynamic IP address.
Select **Statically assigned IP Address** if you have a static IP address. Fill in the **IP address**, **Subnet mask**, and **Hostname** fields.
- 7 Click **Next** to save the changes and close the **Network Card Setup** window.

- 8 If you know your DNS server IP address(es), click the **Hostname/DNS** tab in **Network Settings** and then enter the DNS server information in the fields provided.

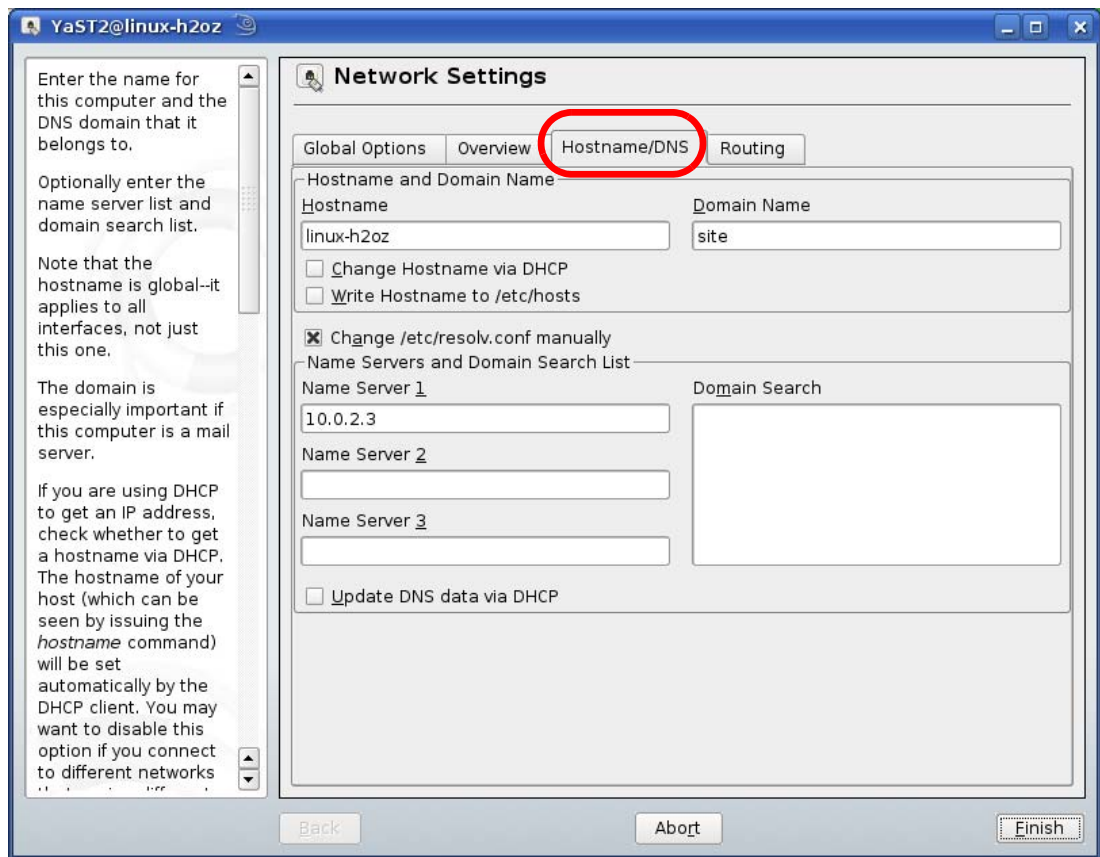

- 9 Click **Finish** to save your settings and close the window.

Verifying Settings

Click the **KNetwork Manager** icon on the **Task bar** to check your TCP/IP properties. From the **Options** sub-menu, select **Show Connection Information**.

Figure 119 openSUSE 10.3: KNetwork Manager

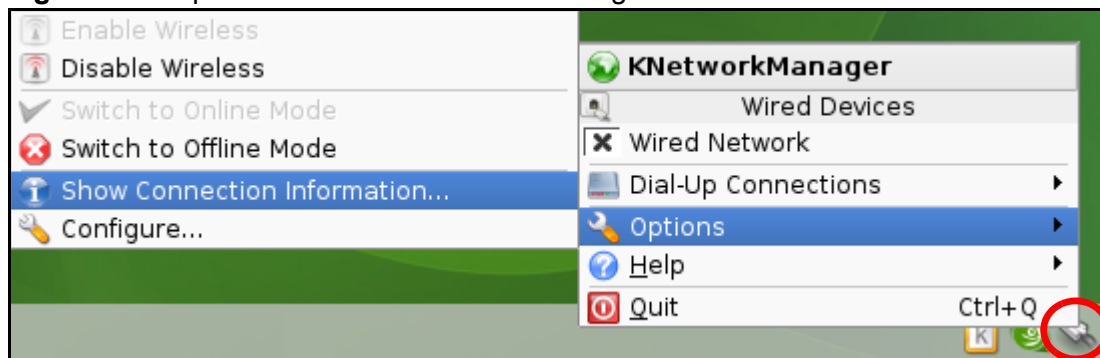

When the **Connection Status - KNetwork Manager** window opens, click the **Statistics tab** to see if your connection is working properly.

Figure 120 openSUSE: Connection Status - KNetwork Manager

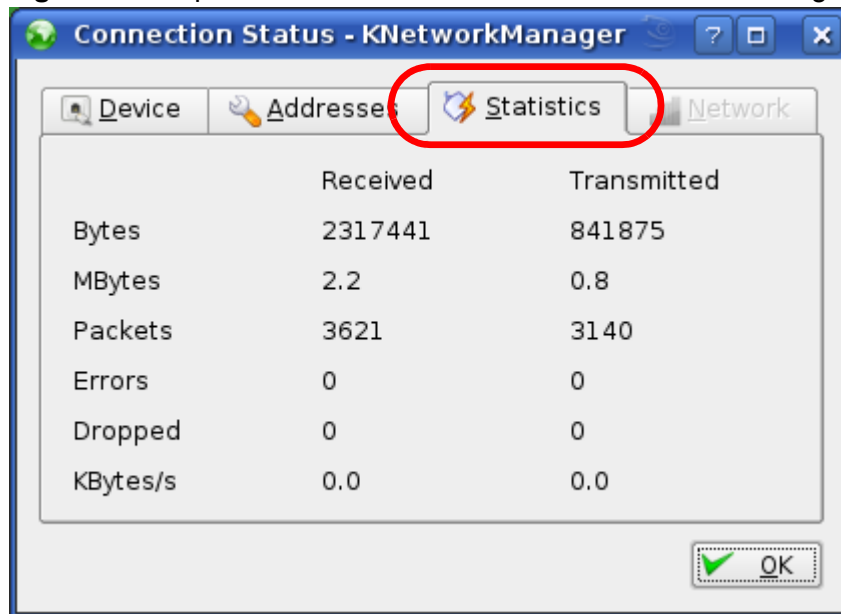

IP Addresses and Subnetting

This appendix introduces IP addresses and subnet masks.

IP addresses identify individual devices on a network. Every networking device (including computers, servers, routers, printers, etc.) needs an IP address to communicate across the network. These networking devices are also known as hosts.

Subnet masks determine the maximum number of possible hosts on a network. You can also use subnet masks to divide one network into multiple sub-networks.

Introduction to IP Addresses

One part of the IP address is the network number, and the other part is the host ID. In the same way that houses on a street share a common street name, the hosts on a network share a common network number. Similarly, as each house has its own house number, each host on the network has its own unique identifying number - the host ID. Routers use the network number to send packets to the correct network, while the host ID determines to which host on the network the packets are delivered.

Structure

An IP address is made up of four parts, written in dotted decimal notation (for example, 192.168.1.1). Each of these four parts is known as an octet. An octet is an eight-digit binary number (for example 11000000, which is 192 in decimal notation).

Therefore, each octet has a possible range of 00000000 to 11111111 in binary, or 0 to 255 in decimal.

The following figure shows an example IP address in which the first three octets (192.168.1) are the network number, and the fourth octet (16) is the host ID.

Figure 121 Network Number and Host ID

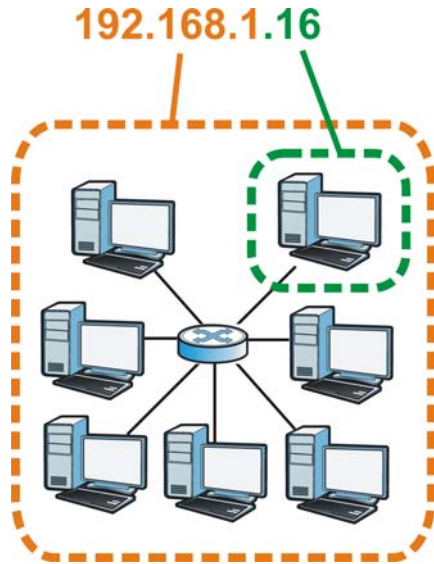

How much of the IP address is the network number and how much is the host ID varies according to the subnet mask.

Subnet Masks

A subnet mask is used to determine which bits are part of the network number, and which bits are part of the host ID (using a logical AND operation). The term “subnet” is short for “sub-network”.

A subnet mask has 32 bits. If a bit in the subnet mask is a “1” then the corresponding bit in the IP address is part of the network number. If a bit in the subnet mask is “0” then the corresponding bit in the IP address is part of the host ID.

The following example shows a subnet mask identifying the network number (in bold text) and host ID of an IP address (192.168.1.2 in decimal).

Table 96 Subnet Masks

	1ST OCTET: (192)	2ND OCTET: (168)	3RD OCTET: (1)	4TH OCTET (2)
IP Address (Binary)	11000000	10101000	00000001	00000010
Subnet Mask (Binary)	11111111	11111111	11111111	00000000
Network Number	11000000	10101000	00000001	
Host ID				00000010

By convention, subnet masks always consist of a continuous sequence of ones beginning from the leftmost bit of the mask, followed by a continuous sequence of zeros, for a total number of 32 bits.

Subnet masks can be referred to by the size of the network number part (the bits with a "1" value). For example, an "8-bit mask" means that the first 8 bits of the mask are ones and the remaining 24 bits are zeroes.

Subnet masks are expressed in dotted decimal notation just like IP addresses. The following examples show the binary and decimal notation for 8-bit, 16-bit, 24-bit and 29-bit subnet masks.

Table 97 Subnet Masks

	BINARY				DECIMAL
	1ST OCTET	2ND OCTET	3RD OCTET	4TH OCTET	
8-bit mask	11111111	00000000	00000000	00000000	255.0.0.0
16-bit mask	11111111	11111111	00000000	00000000	255.255.0.0
24-bit mask	11111111	11111111	11111111	00000000	255.255.255.0
29-bit mask	11111111	11111111	11111111	11111000	255.255.255.248

Network Size

The size of the network number determines the maximum number of possible hosts you can have on your network. The larger the number of network number bits, the smaller the number of remaining host ID bits.

An IP address with host IDs of all zeros is the IP address of the network (192.168.1.0 with a 24-bit subnet mask, for example). An IP address with host IDs of all ones is the broadcast address for that network (192.168.1.255 with a 24-bit subnet mask, for example).

As these two IP addresses cannot be used for individual hosts, calculate the maximum number of possible hosts in a network as follows:

Table 98 Maximum Host Numbers

SUBNET MASK		HOST ID SIZE		MAXIMUM NUMBER OF HOSTS
8 bits	255.0.0.0	24 bits	$2^{24} - 2$	16777214
16 bits	255.255.0.0	16 bits	$2^{16} - 2$	65534
24 bits	255.255.255.0	8 bits	$2^8 - 2$	254
29 bits	255.255.255.248	3 bits	$2^3 - 2$	6

Notation

Since the mask is always a continuous number of ones beginning from the left, followed by a continuous number of zeros for the remainder of the 32 bit mask, you can simply specify the number of ones instead of writing the value of each octet. This is usually specified by writing a "/" followed by the number of bits in the mask after the address.

For example, 192.1.1.0 /25 is equivalent to saying 192.1.1.0 with subnet mask 255.255.255.128.

The following table shows some possible subnet masks using both notations.

Table 99 Alternative Subnet Mask Notation

SUBNET MASK	ALTERNATIVE NOTATION	LAST OCTET (BINARY)	LAST OCTET (DECIMAL)
255.255.255.0	/24	0000 0000	0
255.255.255.128	/25	1000 0000	128
255.255.255.192	/26	1100 0000	192
255.255.255.224	/27	1110 0000	224
255.255.255.240	/28	1111 0000	240
255.255.255.248	/29	1111 1000	248
255.255.255.252	/30	1111 1100	252

Subnetting

You can use subnetting to divide one network into multiple sub-networks. In the following example a network administrator creates two sub-networks to isolate a group of servers from the rest of the company network for security reasons.

In this example, the company network address is 192.168.1.0. The first three octets of the address (192.168.1) are the network number, and the remaining octet is the host ID, allowing a maximum of $2^8 - 2$ or 254 possible hosts.

The following figure shows the company network before subnetting.

Figure 122 Subnetting Example: Before Subnetting

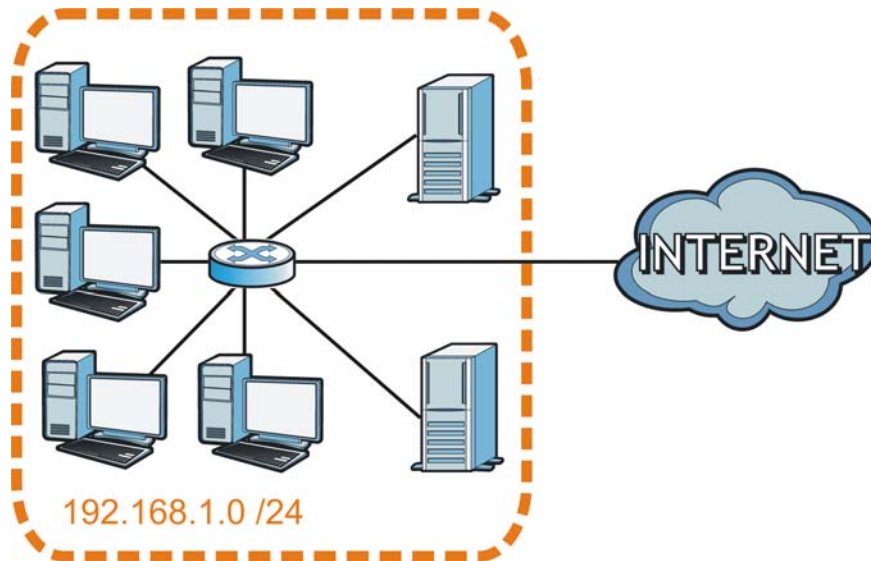

You can “borrow” one of the host ID bits to divide the network 192.168.1.0 into two separate sub-networks. The subnet mask is now 25 bits (255.255.255.128 or /25).

The “borrowed” host ID bit can have a value of either 0 or 1, allowing two subnets; 192.168.1.0 /25 and 192.168.1.128 /25.

The following figure shows the company network after subnetting. There are now two sub-networks, **A** and **B**.

Figure 123 Subnetting Example: After Subnetting

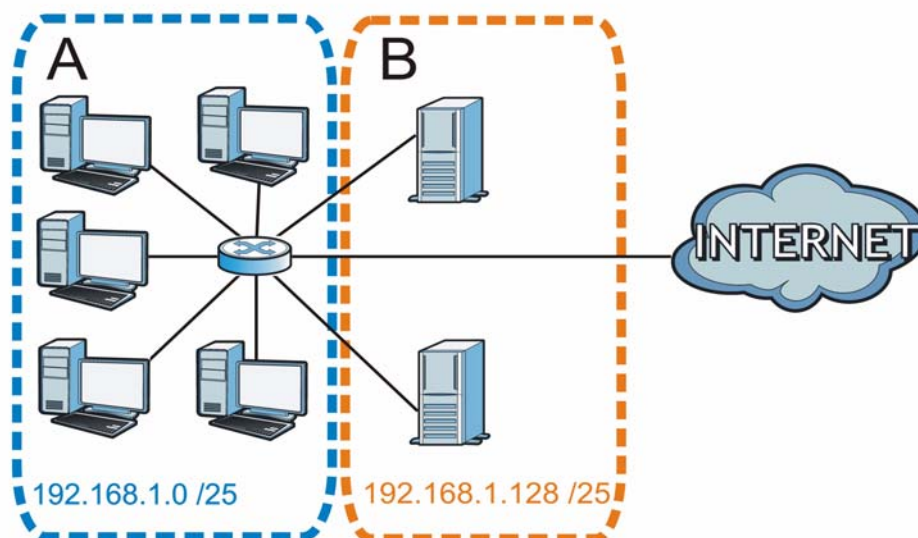

In a 25-bit subnet the host ID has 7 bits, so each sub-network has a maximum of $2^7 - 2$ or 126 possible hosts (a host ID of all zeroes is the subnet's address itself, all ones is the subnet's broadcast address).

192.168.1.0 with mask 255.255.255.128 is subnet **A** itself, and 192.168.1.127 with mask 255.255.255.128 is its broadcast address. Therefore, the lowest IP address that can be assigned to an actual host for subnet **A** is 192.168.1.1 and the highest is 192.168.1.126.

Similarly, the host ID range for subnet **B** is 192.168.1.129 to 192.168.1.254.

Example: Four Subnets

The previous example illustrated using a 25-bit subnet mask to divide a 24-bit address into two subnets. Similarly, to divide a 24-bit address into four subnets, you need to "borrow" two host ID bits to give four possible combinations (00, 01, 10 and 11). The subnet mask is 26 bits

(11111111.11111111.11111111.**11**000000) or 255.255.255.192.

Each subnet contains 6 host ID bits, giving $2^6 - 2$ or 62 hosts for each subnet (a host ID of all zeroes is the subnet itself, all ones is the subnet's broadcast address).

Table 100 Subnet 1

IP/SUBNET MASK	NETWORK NUMBER	LAST OCTET BIT VALUE
IP Address (Decimal)	192.168.1.	0
IP Address (Binary)	11000000.10101000.00000001.	00 000000
Subnet Mask (Binary)	11111111.11111111.11111111.	11 000000
Subnet Address: 192.168.1.0	Lowest Host ID: 192.168.1.1	
Broadcast Address: 192.168.1.63	Highest Host ID: 192.168.1.62	

Table 101 Subnet 2

IP/SUBNET MASK	NETWORK NUMBER	LAST OCTET BIT VALUE
IP Address	192.168.1.	64
IP Address (Binary)	11000000.10101000.00000001.	01 000000
Subnet Mask (Binary)	11111111.11111111.11111111.	11 000000
Subnet Address: 192.168.1.64	Lowest Host ID: 192.168.1.65	
Broadcast Address: 192.168.1.127	Highest Host ID: 192.168.1.126	

Table 102 Subnet 3

IP/SUBNET MASK	NETWORK NUMBER	LAST OCTET BIT VALUE
IP Address	192.168.1.	128
IP Address (Binary)	11000000.10101000.00000001.	10000000
Subnet Mask (Binary)	11111111.11111111.11111111.	11000000
Subnet Address: 192.168.1.128	Lowest Host ID: 192.168.1.129	
Broadcast Address: 192.168.1.191	Highest Host ID: 192.168.1.190	

Table 103 Subnet 4

IP/SUBNET MASK	NETWORK NUMBER	LAST OCTET BIT VALUE
IP Address	192.168.1.	192
IP Address (Binary)	11000000.10101000.00000001.	11000000
Subnet Mask (Binary)	11111111.11111111.11111111.	11000000
Subnet Address: 192.168.1.192	Lowest Host ID: 192.168.1.193	
Broadcast Address: 192.168.1.255	Highest Host ID: 192.168.1.254	

Example: Eight Subnets

Similarly, use a 27-bit mask to create eight subnets (000, 001, 010, 011, 100, 101, 110 and 111).

The following table shows IP address last octet values for each subnet.

Table 104 Eight Subnets

SUBNET	SUBNET ADDRESS	FIRST ADDRESS	LAST ADDRESS	BROADCAST ADDRESS
1	0	1	30	31
2	32	33	62	63
3	64	65	94	95
4	96	97	126	127
5	128	129	158	159
6	160	161	190	191
7	192	193	222	223
8	224	225	254	255

Subnet Planning

The following table is a summary for subnet planning on a network with a 24-bit network number.

Table 105 24-bit Network Number Subnet Planning

NO. "BORROWED" HOST BITS	SUBNET MASK	NO. SUBNETS	NO. HOSTS PER SUBNET
1	255.255.255.128 (/25)	2	126
2	255.255.255.192 (/26)	4	62
3	255.255.255.224 (/27)	8	30
4	255.255.255.240 (/28)	16	14
5	255.255.255.248 (/29)	32	6
6	255.255.255.252 (/30)	64	2
7	255.255.255.254 (/31)	128	1

The following table is a summary for subnet planning on a network with a 16-bit network number.

Table 106 16-bit Network Number Subnet Planning

NO. "BORROWED" HOST BITS	SUBNET MASK	NO. SUBNETS	NO. HOSTS PER SUBNET
1	255.255.128.0 (/17)	2	32766
2	255.255.192.0 (/18)	4	16382
3	255.255.224.0 (/19)	8	8190
4	255.255.240.0 (/20)	16	4094
5	255.255.248.0 (/21)	32	2046
6	255.255.252.0 (/22)	64	1022
7	255.255.254.0 (/23)	128	510
8	255.255.255.0 (/24)	256	254
9	255.255.255.128 (/25)	512	126
10	255.255.255.192 (/26)	1024	62
11	255.255.255.224 (/27)	2048	30
12	255.255.255.240 (/28)	4096	14
13	255.255.255.248 (/29)	8192	6
14	255.255.255.252 (/30)	16384	2
15	255.255.255.254 (/31)	32768	1

Configuring IP Addresses

Where you obtain your network number depends on your particular situation. If the ISP or your network administrator assigns you a block of registered IP

addresses, follow their instructions in selecting the IP addresses and the subnet mask.

If the ISP did not explicitly give you an IP network number, then most likely you have a single user account and the ISP will assign you a dynamic IP address when the connection is established. If this is the case, it is recommended that you select a network number from 192.168.0.0 to 192.168.255.0. The Internet Assigned Number Authority (IANA) reserved this block of addresses specifically for private use; please do not use any other number unless you are told otherwise. You must also enable Network Address Translation (NAT) on the ZyXEL Device.

Once you have decided on the network number, pick an IP address for your ZyXEL Device that is easy to remember (for instance, 192.168.1.1) but make sure that no other device on your network is using that IP address.

The subnet mask specifies the network number portion of an IP address. Your ZyXEL Device will compute the subnet mask automatically based on the IP address that you entered. You don't need to change the subnet mask computed by the ZyXEL Device unless you are instructed to do otherwise.

Private IP Addresses

Every machine on the Internet must have a unique address. If your networks are isolated from the Internet (running only between two branch offices, for example) you can assign IP addresses to the hosts without problems. However, the Internet Assigned Numbers Authority (IANA) has reserved the following three blocks of IP addresses specifically for private networks:

- 10.0.0.0 — 10.255.255.255
- 172.16.0.0 — 172.31.255.255
- 192.168.0.0 — 192.168.255.255

You can obtain your IP address from the IANA, from an ISP, or it can be assigned from a private network. If you belong to a small organization and your Internet access is through an ISP, the ISP can provide you with the Internet addresses for your local networks. On the other hand, if you are part of a much larger organization, you should consult your network administrator for the appropriate IP addresses.

Regardless of your particular situation, do not create an arbitrary IP address; always follow the guidelines above. For more information on address assignment, please refer to RFC 1597, *Address Allocation for Private Internets* and RFC 1466, *Guidelines for Management of IP Address Space*.

Pop-up Windows, JavaScripts and Java Permissions

In order to use the web configurator you need to allow:

- Web browser pop-up windows from your device.
- JavaScripts (enabled by default).
- Java permissions (enabled by default).

Note: Internet Explorer 6 screens are used here. Screens for other Internet Explorer versions may vary.

Internet Explorer Pop-up Blockers

You may have to disable pop-up blocking to log into your device.

Either disable pop-up blocking (enabled by default in Windows XP SP (Service Pack) 2) or allow pop-up blocking and create an exception for your device's IP address.

Disable Pop-up Blockers

- 1 In Internet Explorer, select **Tools, Pop-up Blocker** and then select **Turn Off Pop-up Blocker**.

Figure 124 Pop-up Blocker

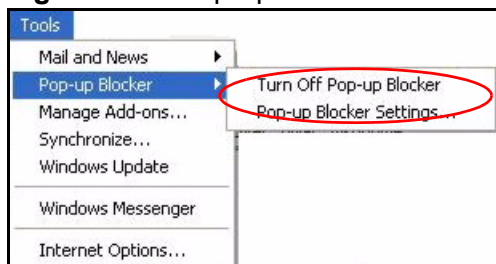

You can also check if pop-up blocking is disabled in the **Pop-up Blocker** section in the **Privacy** tab.

- 1 In Internet Explorer, select **Tools, Internet Options, Privacy**.
- 2 Clear the **Block pop-ups** check box in the **Pop-up Blocker** section of the screen. This disables any web pop-up blockers you may have enabled.

Figure 125 Internet Options: Privacy

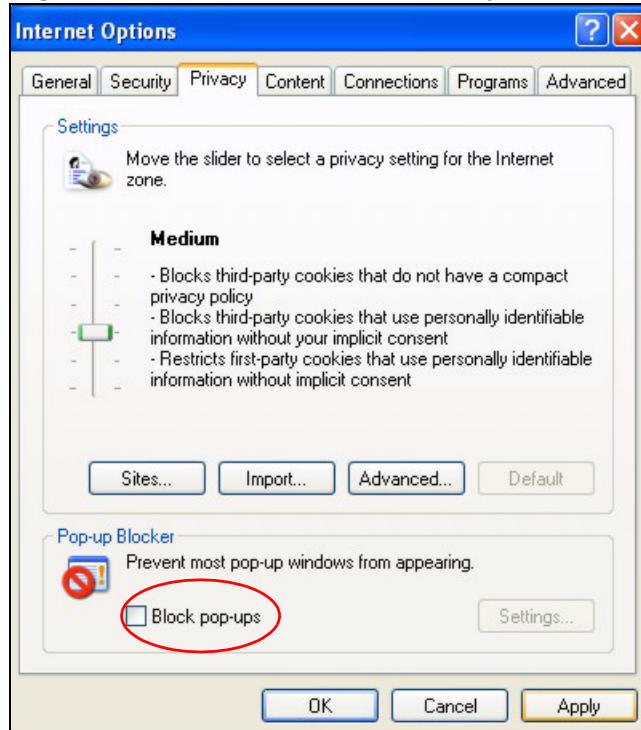

- 3 Click **Apply** to save this setting.

Enable Pop-up Blockers with Exceptions

Alternatively, if you only want to allow pop-up windows from your device, see the following steps.

- 1 In Internet Explorer, select **Tools, Internet Options** and then the **Privacy** tab.

- 2 Select **Settings...** to open the **Pop-up Blocker Settings** screen.

Figure 126 Internet Options: Privacy

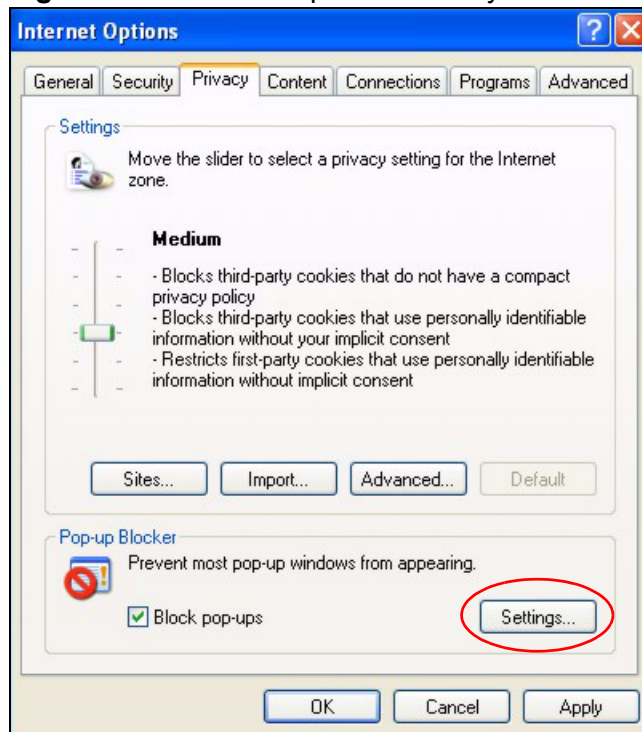

- 3 Type the IP address of your device (the web page that you do not want to have blocked) with the prefix "http://". For example, http://192.168.167.1.

- 4 Click **Add** to move the IP address to the list of **Allowed sites**.

Figure 127 Pop-up Blocker Settings

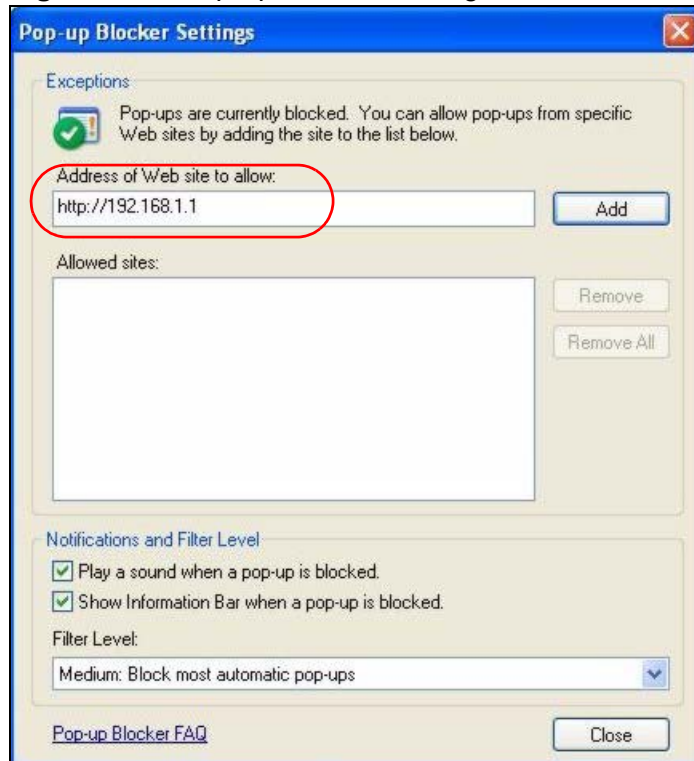

- 5 Click **Close** to return to the **Privacy** screen.
- 6 Click **Apply** to save this setting.

JavaScripts

If pages of the web configurator do not display properly in Internet Explorer, check that JavaScripts are allowed.

- 1 In Internet Explorer, click **Tools, Internet Options** and then the **Security** tab.

Figure 128 Internet Options: Security

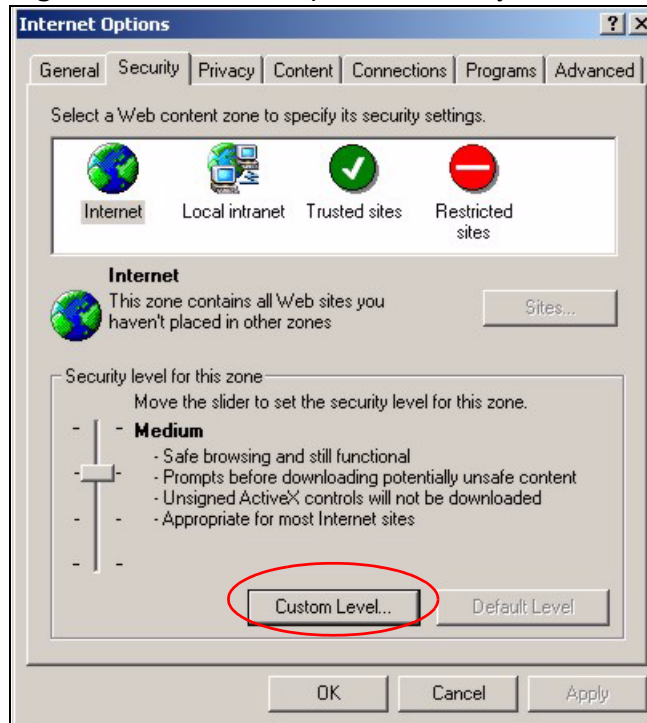

- 2 Click the **Custom Level...** button.
- 3 Scroll down to **Scripting**.
- 4 Under **Active scripting** make sure that **Enable** is selected (the default).
- 5 Under **Scripting of Java applets** make sure that **Enable** is selected (the default).

- 6 Click **OK** to close the window.

Figure 129 Security Settings - Java Scripting

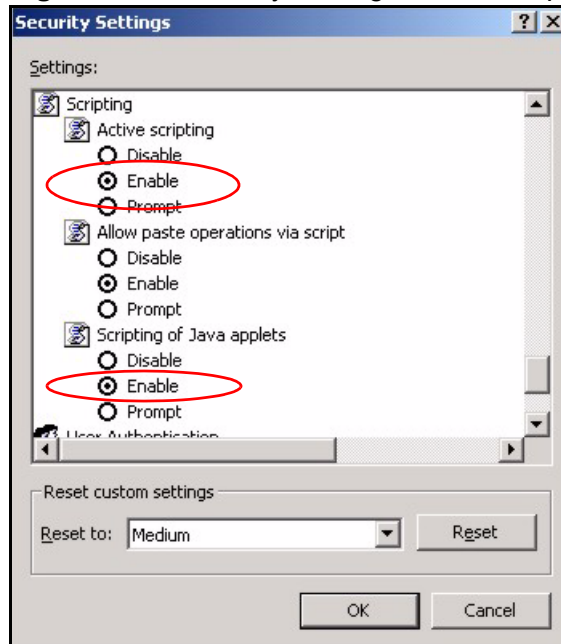

Java Permissions

- 1 From Internet Explorer, click **Tools, Internet Options** and then the **Security** tab.
- 2 Click the **Custom Level...** button.
- 3 Scroll down to **Microsoft VM**.
- 4 Under **Java permissions** make sure that a safety level is selected.

- 5 Click **OK** to close the window.

Figure 130 Security Settings - Java

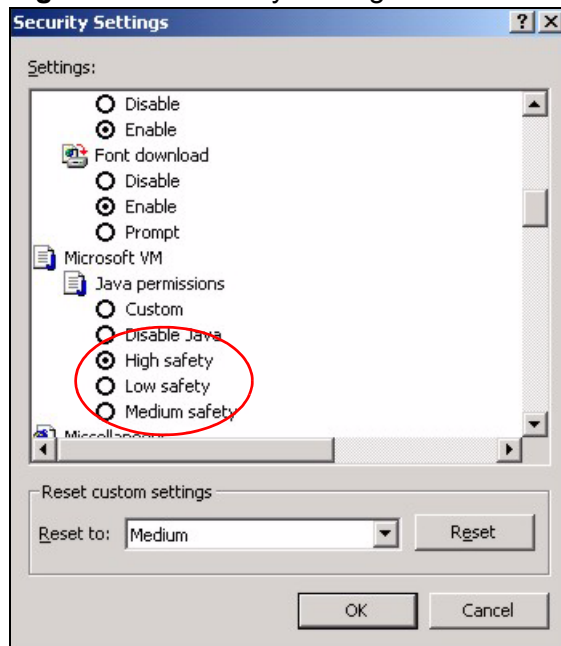

JAVA (Sun)

- 1 From Internet Explorer, click **Tools, Internet Options** and then the **Advanced** tab.
- 2 Make sure that **Use Java 2 for <applet>** under **Java (Sun)** is selected.

- 3 Click **OK** to close the window.

Figure 131 Java (Sun)

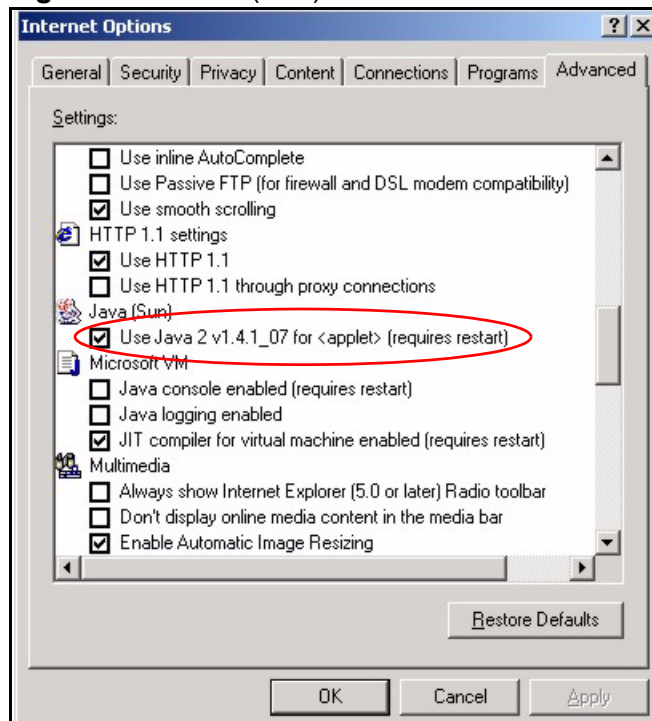

Mozilla Firefox

Mozilla Firefox 2.0 screens are used here. Screens for other versions may vary.

You can enable Java, Javascripts and pop-ups in one screen. Click **Tools**, then click **Options** in the screen that appears.

Figure 132 Mozilla Firefox: Tools > Options

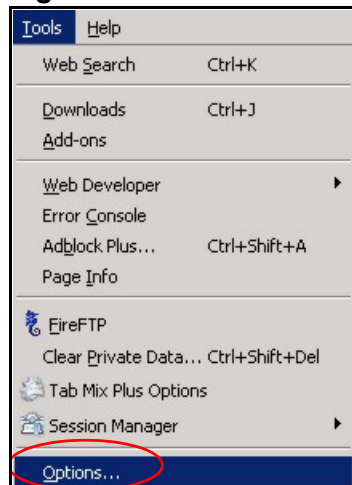

Click **Content** to show the screen below. Select the check boxes as shown in the following screen.

Figure 133 Mozilla Firefox Content Security



Wireless LANs

Wireless LAN Topologies

This section discusses ad-hoc and infrastructure wireless LAN topologies.

Ad-hoc Wireless LAN Configuration

The simplest WLAN configuration is an independent (Ad-hoc) WLAN that connects a set of computers with wireless adapters (A, B, C). Any time two or more wireless adapters are within range of each other, they can set up an independent network, which is commonly referred to as an ad-hoc network or Independent Basic Service Set (IBSS). The following diagram shows an example of notebook computers using wireless adapters to form an ad-hoc wireless LAN.

Figure 134 Peer-to-Peer Communication in an Ad-hoc Network

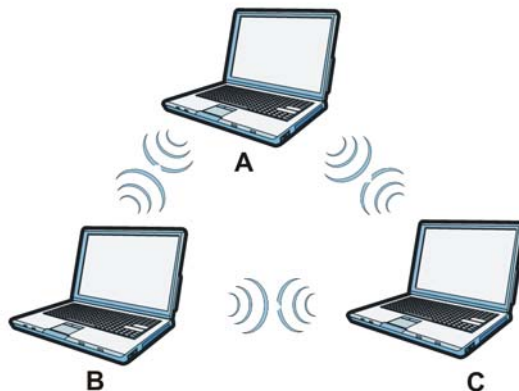

BSS

A Basic Service Set (BSS) exists when all communications between wireless clients or between a wireless client and a wired network client go through one access point (AP).

Intra-BSS traffic is traffic between wireless clients in the BSS. When Intra-BSS is enabled, wireless client **A** and **B** can access the wired network and communicate

with each other. When Intra-BSS is disabled, wireless client **A** and **B** can still access the wired network but cannot communicate with each other.

Figure 135 Basic Service Set

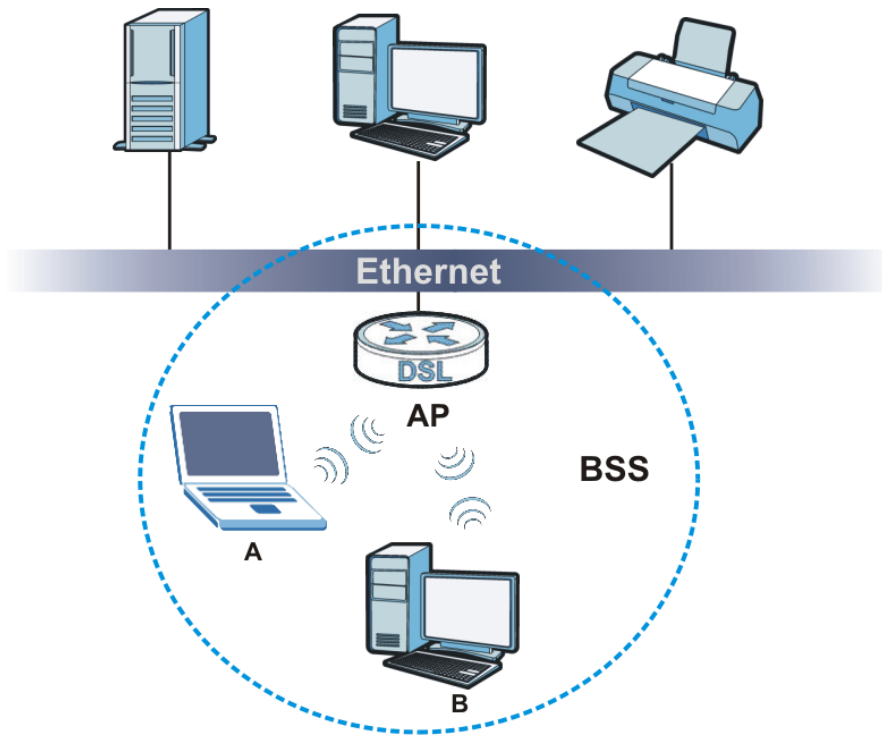

ESS

An Extended Service Set (ESS) consists of a series of overlapping BSSs, each containing an access point, with each access point connected together by a wired network. This wired connection between APs is called a Distribution System (DS).

This type of wireless LAN topology is called an Infrastructure WLAN. The Access Points not only provide communication with the wired network but also mediate wireless network traffic in the immediate neighborhood.

An ESSID (ESS IDentification) uniquely identifies each ESS. All access points and their associated wireless clients within the same ESS must have the same ESSID in order to communicate.

Figure 136 Infrastructure WLAN

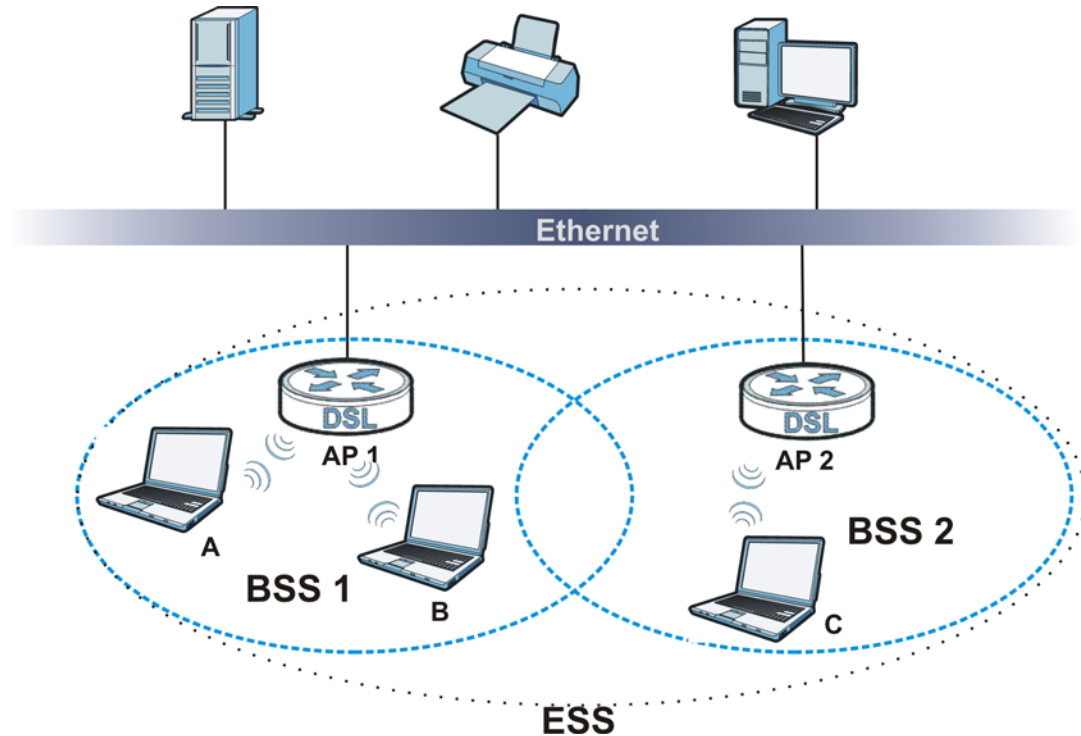

Channel

A channel is the radio frequency(ies) used by wireless devices to transmit and receive data. Channels available depend on your geographical area. You may have a choice of channels (for your region) so you should use a channel different from an adjacent AP (access point) to reduce interference. Interference occurs when radio signals from different access points overlap causing interference and degrading performance.

Adjacent channels partially overlap however. To avoid interference due to overlap, your AP should be on a channel at least five channels away from a channel that an adjacent AP is using. For example, if your region has 11 channels and an adjacent AP is using channel 1, then you need to select a channel between 6 or 11.

RTS/CTS

A hidden node occurs when two stations are within range of the same access point, but are not within range of each other. The following figure illustrates a

hidden node. Both stations (STA) are within range of the access point (AP) or wireless gateway, but out-of-range of each other, so they cannot "hear" each other, that is they do not know if the channel is currently being used. Therefore, they are considered hidden from each other.

Figure 137 RTS/CTS

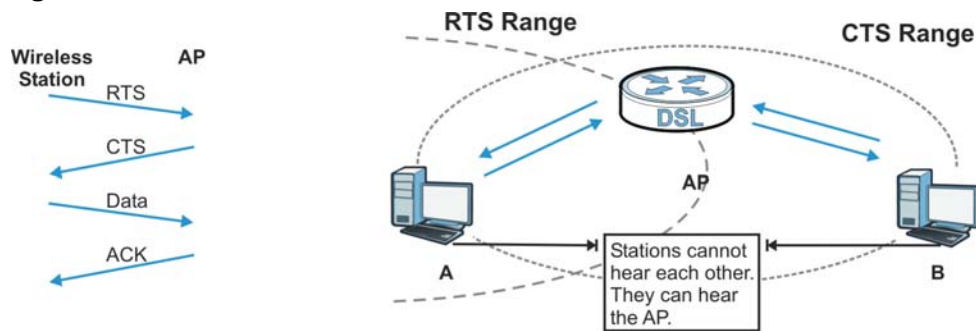

When station **A** sends data to the AP, it might not know that the station **B** is already using the channel. If these two stations send data at the same time, collisions may occur when both sets of data arrive at the AP at the same time, resulting in a loss of messages for both stations.

RTS/CTS is designed to prevent collisions due to hidden nodes. An **RTS/CTS** defines the biggest size data frame you can send before an RTS (Request To Send)/CTS (Clear to Send) handshake is invoked.

When a data frame exceeds the **RTS/CTS** value you set (between 0 to 2432 bytes), the station that wants to transmit this frame must first send an RTS (Request To Send) message to the AP for permission to send it. The AP then responds with a CTS (Clear to Send) message to all other stations within its range to notify them to defer their transmission. It also reserves and confirms with the requesting station the time frame for the requested transmission.

Stations can send frames smaller than the specified **RTS/CTS** directly to the AP without the RTS (Request To Send)/CTS (Clear to Send) handshake.

You should only configure **RTS/CTS** if the possibility of hidden nodes exists on your network and the "cost" of resending large frames is more than the extra network overhead involved in the RTS (Request To Send)/CTS (Clear to Send) handshake.

If the **RTS/CTS** value is greater than the **Fragmentation Threshold** value (see next), then the RTS (Request To Send)/CTS (Clear to Send) handshake will never occur as data frames will be fragmented before they reach **RTS/CTS** size.

Note: Enabling the RTS Threshold causes redundant network overhead that could negatively affect the throughput performance instead of providing a remedy.

Fragmentation Threshold

A **Fragmentation Threshold** is the maximum data fragment size (between 256 and 2432 bytes) that can be sent in the wireless network before the AP will fragment the packet into smaller data frames.

A large **Fragmentation Threshold** is recommended for networks not prone to interference while you should set a smaller threshold for busy networks or networks that are prone to interference.

If the **Fragmentation Threshold** value is smaller than the **RTS/CTS** value (see previously) you set then the RTS (Request To Send)/CTS (Clear to Send) handshake will never occur as data frames will be fragmented before they reach **RTS/CTS** size.

Preamble Type

Preamble is used to signal that data is coming to the receiver. Short and long refer to the length of the synchronization field in a packet.

Short preamble increases performance as less time sending preamble means more time for sending data. All IEEE 802.11 compliant wireless adapters support long preamble, but not all support short preamble.

Use long preamble if you are unsure what preamble mode other wireless devices on the network support, and to provide more reliable communications in busy wireless networks.

Use short preamble if you are sure all wireless devices on the network support it, and to provide more efficient communications.

Use the dynamic setting to automatically use short preamble when all wireless devices on the network support it, otherwise the ZyXEL Device uses long preamble.

Note: The wireless devices **MUST** use the same preamble mode in order to communicate.

IEEE 802.11g Wireless LAN

IEEE 802.11g is fully compatible with the IEEE 802.11b standard. This means an IEEE 802.11b adapter can interface directly with an IEEE 802.11g access point (and vice versa) at 11 Mbps or lower depending on range. IEEE 802.11g has

several intermediate rate steps between the maximum and minimum data rates. The IEEE 802.11g data rate and modulation are as follows:

Table 107 IEEE 802.11g

DATA RATE (MBPS)	MODULATION
1	DBPSK (Differential Binary Phase Shift Keyed)
2	DQPSK (Differential Quadrature Phase Shift Keying)
5.5 / 11	CCK (Complementary Code Keying)
6/9/12/18/24/36/48/54	OFDM (Orthogonal Frequency Division Multiplexing)

Wireless Security Overview

Wireless security is vital to your network to protect wireless communication between wireless clients, access points and the wired network.

Wireless security methods available on the ZyXEL Device are data encryption, wireless client authentication, restricting access by device MAC address and hiding the ZyXEL Device identity.

The following figure shows the relative effectiveness of these wireless security methods available on your ZyXEL Device.

Table 108 Wireless Security Levels

SECURITY LEVEL	SECURITY TYPE
Least Secure	Unique SSID (Default)
	Unique SSID with Hide SSID Enabled
	MAC Address Filtering
	WEP Encryption
	IEEE802.1x EAP with RADIUS Server Authentication
	Wi-Fi Protected Access (WPA)
	WPA2
Most Secure	

Note: You must enable the same wireless security settings on the ZyXEL Device and on all wireless clients that you want to associate with it.

IEEE 802.1x

In June 2001, the IEEE 802.1x standard was designed to extend the features of IEEE 802.11 to support extended authentication as well as providing additional accounting and control features. It is supported by Windows XP and a number of network devices. Some advantages of IEEE 802.1x are:

- User based identification that allows for roaming.
- Support for RADIUS (Remote Authentication Dial In User Service, RFC 2138, 2139) for centralized user profile and accounting management on a network RADIUS server.
- Support for EAP (Extensible Authentication Protocol, RFC 2486) that allows additional authentication methods to be deployed with no changes to the access point or the wireless clients.

RADIUS

RADIUS is based on a client-server model that supports authentication, authorization and accounting. The access point is the client and the server is the RADIUS server. The RADIUS server handles the following tasks:

- Authentication
Determines the identity of the users.
- Authorization
Determines the network services available to authenticated users once they are connected to the network.
- Accounting
Keeps track of the client's network activity.

RADIUS is a simple package exchange in which your AP acts as a message relay between the wireless client and the network RADIUS server.

Types of RADIUS Messages

The following types of RADIUS messages are exchanged between the access point and the RADIUS server for user authentication:

- Access-Request
Sent by an access point requesting authentication.
- Access-Reject
Sent by a RADIUS server rejecting access.
- Access-Accept
Sent by a RADIUS server allowing access.

- Access-Challenge

Sent by a RADIUS server requesting more information in order to allow access. The access point sends a proper response from the user and then sends another Access-Request message.

The following types of RADIUS messages are exchanged between the access point and the RADIUS server for user accounting:

- Accounting-Request

Sent by the access point requesting accounting.

- Accounting-Response

Sent by the RADIUS server to indicate that it has started or stopped accounting.

In order to ensure network security, the access point and the RADIUS server use a shared secret key, which is a password, they both know. The key is not sent over the network. In addition to the shared key, password information exchanged is also encrypted to protect the network from unauthorized access.

Types of EAP Authentication

This section discusses some popular authentication types: EAP-MD5, EAP-TLS, EAP-TTLS, PEAP and LEAP. Your wireless LAN device may not support all authentication types.

EAP (Extensible Authentication Protocol) is an authentication protocol that runs on top of the IEEE 802.1x transport mechanism in order to support multiple types of user authentication. By using EAP to interact with an EAP-compatible RADIUS server, an access point helps a wireless station and a RADIUS server perform authentication.

The type of authentication you use depends on the RADIUS server and an intermediary AP(s) that supports IEEE 802.1x. .

For EAP-TLS authentication type, you must first have a wired connection to the network and obtain the certificate(s) from a certificate authority (CA). A certificate (also called digital IDs) can be used to authenticate users and a CA issues certificates and guarantees the identity of each certificate owner.

EAP-MD5 (Message-Digest Algorithm 5)

MD5 authentication is the simplest one-way authentication method. The authentication server sends a challenge to the wireless client. The wireless client 'proves' that it knows the password by encrypting the password with the challenge and sends back the information. Password is not sent in plain text.

However, MD5 authentication has some weaknesses. Since the authentication server needs to get the plaintext passwords, the passwords must be stored. Thus someone other than the authentication server may access the password file. In addition, it is possible to impersonate an authentication server as MD5 authentication method does not perform mutual authentication. Finally, MD5 authentication method does not support data encryption with dynamic session key. You must configure WEP encryption keys for data encryption.

EAP-TLS (Transport Layer Security)

With EAP-TLS, digital certifications are needed by both the server and the wireless clients for mutual authentication. The server presents a certificate to the client. After validating the identity of the server, the client sends a different certificate to the server. The exchange of certificates is done in the open before a secured tunnel is created. This makes user identity vulnerable to passive attacks. A digital certificate is an electronic ID card that authenticates the sender's identity. However, to implement EAP-TLS, you need a Certificate Authority (CA) to handle certificates, which imposes a management overhead.

EAP-TTLS (Tunneled Transport Layer Service)

EAP-TTLS is an extension of the EAP-TLS authentication that uses certificates for only the server-side authentications to establish a secure connection. Client authentication is then done by sending username and password through the secure connection, thus client identity is protected. For client authentication, EAP-TTLS supports EAP methods and legacy authentication methods such as PAP, CHAP, MS-CHAP and MS-CHAP v2.

PEAP (Protected EAP)

Like EAP-TTLS, server-side certificate authentication is used to establish a secure connection, then use simple username and password methods through the secured connection to authenticate the clients, thus hiding client identity. However, PEAP only supports EAP methods, such as EAP-MD5, EAP-MSCHAPv2 and EAP-GTC (EAP-Generic Token Card), for client authentication. EAP-GTC is implemented only by Cisco.

LEAP

LEAP (Lightweight Extensible Authentication Protocol) is a Cisco implementation of IEEE 802.1x.

Dynamic WEP Key Exchange

The AP maps a unique key that is generated with the RADIUS server. This key expires when the wireless connection times out, disconnects or reauthentication times out. A new WEP key is generated each time reauthentication is performed.

If this feature is enabled, it is not necessary to configure a default encryption key in the wireless security configuration screen. You may still configure and store keys, but they will not be used while dynamic WEP is enabled.

Note: EAP-MD5 cannot be used with Dynamic WEP Key Exchange

For added security, certificate-based authentications (EAP-TLS, EAP-TTLS and PEAP) use dynamic keys for data encryption. They are often deployed in corporate environments, but for public deployment, a simple user name and password pair is more practical. The following table is a comparison of the features of authentication types.

Table 109 Comparison of EAP Authentication Types

	EAP-MD5	EAP-TLS	EAP-TTLS	PEAP	LEAP
Mutual Authentication	No	Yes	Yes	Yes	Yes
Certificate – Client	No	Yes	Optional	Optional	No
Certificate – Server	No	Yes	Yes	Yes	No
Dynamic Key Exchange	No	Yes	Yes	Yes	Yes
Credential Integrity	None	Strong	Strong	Strong	Moderate
Deployment Difficulty	Easy	Hard	Moderate	Moderate	Moderate
Client Identity Protection	No	No	Yes	Yes	No

WPA and WPA2

Wi-Fi Protected Access (WPA) is a subset of the IEEE 802.11i standard. WPA2 (IEEE 802.11i) is a wireless security standard that defines stronger encryption, authentication and key management than WPA.

Key differences between WPA or WPA2 and WEP are improved data encryption and user authentication.

If both an AP and the wireless clients support WPA2 and you have an external RADIUS server, use WPA2 for stronger data encryption. If you don't have an external RADIUS server, you should use WPA2-PSK (WPA2-Pre-Shared Key) that only requires a single (identical) password entered into each access point, wireless gateway and wireless client. As long as the passwords match, a wireless client will be granted access to a WLAN.

If the AP or the wireless clients do not support WPA2, just use WPA or WPA-PSK depending on whether you have an external RADIUS server or not.

Select WEP only when the AP and/or wireless clients do not support WPA or WPA2. WEP is less secure than WPA or WPA2.

Encryption

WPA improves data encryption by using Temporal Key Integrity Protocol (TKIP), Message Integrity Check (MIC) and IEEE 802.1x. WPA2 also uses TKIP when required for compatibility reasons, but offers stronger encryption than TKIP with Advanced Encryption Standard (AES) in the Counter mode with Cipher block chaining Message authentication code Protocol (CCMP).

TKIP uses 128-bit keys that are dynamically generated and distributed by the authentication server. AES (Advanced Encryption Standard) is a block cipher that uses a 256-bit mathematical algorithm called Rijndael. They both include a per-packet key mixing function, a Message Integrity Check (MIC) named Michael, an extended initialization vector (IV) with sequencing rules, and a re-keying mechanism.

WPA and WPA2 regularly change and rotate the encryption keys so that the same encryption key is never used twice.

The RADIUS server distributes a Pairwise Master Key (PMK) key to the AP that then sets up a key hierarchy and management system, using the PMK to dynamically generate unique data encryption keys to encrypt every data packet that is wirelessly communicated between the AP and the wireless clients. This all happens in the background automatically.

The Message Integrity Check (MIC) is designed to prevent an attacker from capturing data packets, altering them and resending them. The MIC provides a strong mathematical function in which the receiver and the transmitter each compute and then compare the MIC. If they do not match, it is assumed that the data has been tampered with and the packet is dropped.

By generating unique data encryption keys for every data packet and by creating an integrity checking mechanism (MIC), with TKIP and AES it is more difficult to decrypt data on a Wi-Fi network than WEP and difficult for an intruder to break into the network.

The encryption mechanisms used for WPA(2) and WPA(2)-PSK are the same. The only difference between the two is that WPA(2)-PSK uses a simple common password, instead of user-specific credentials. The common-password approach makes WPA(2)-PSK susceptible to brute-force password-guessing attacks but it's still an improvement over WEP as it employs a consistent, single, alphanumeric password to derive a PMK which is used to generate unique temporal encryption

keys. This prevent all wireless devices sharing the same encryption keys. (a weakness of WEP)

User Authentication

WPA and WPA2 apply IEEE 802.1x and Extensible Authentication Protocol (EAP) to authenticate wireless clients using an external RADIUS database. WPA2 reduces the number of key exchange messages from six to four (CCMP 4-way handshake) and shortens the time required to connect to a network. Other WPA2 authentication features that are different from WPA include key caching and pre-authentication. These two features are optional and may not be supported in all wireless devices.

Key caching allows a wireless client to store the PMK it derived through a successful authentication with an AP. The wireless client uses the PMK when it tries to connect to the same AP and does not need to go with the authentication process again.

Pre-authentication enables fast roaming by allowing the wireless client (already connecting to an AP) to perform IEEE 802.1x authentication with another AP before connecting to it.

Wireless Client WPA Supplicants

A wireless client supplicant is the software that runs on an operating system instructing the wireless client how to use WPA. At the time of writing, the most widely available supplicant is the WPA patch for Windows XP, Funk Software's Odyssey client.

The Windows XP patch is a free download that adds WPA capability to Windows XP's built-in "Zero Configuration" wireless client. However, you must run Windows XP to use it.

WPA(2) with RADIUS Application Example

To set up WPA(2), you need the IP address of the RADIUS server, its port number (default is 1812), and the RADIUS shared secret. A WPA(2) application example with an external RADIUS server looks as follows. "A" is the RADIUS server. "DS" is the distribution system.

- 1 The AP passes the wireless client's authentication request to the RADIUS server.
- 2 The RADIUS server then checks the user's identification against its database and grants or denies network access accordingly.
- 3 A 256-bit Pairwise Master Key (PMK) is derived from the authentication process by the RADIUS server and the client.

- 4 The RADIUS server distributes the PMK to the AP. The AP then sets up a key hierarchy and management system, using the PMK to dynamically generate unique data encryption keys. The keys are used to encrypt every data packet that is wirelessly communicated between the AP and the wireless clients.

Figure 138 WPA(2) with RADIUS Application Example

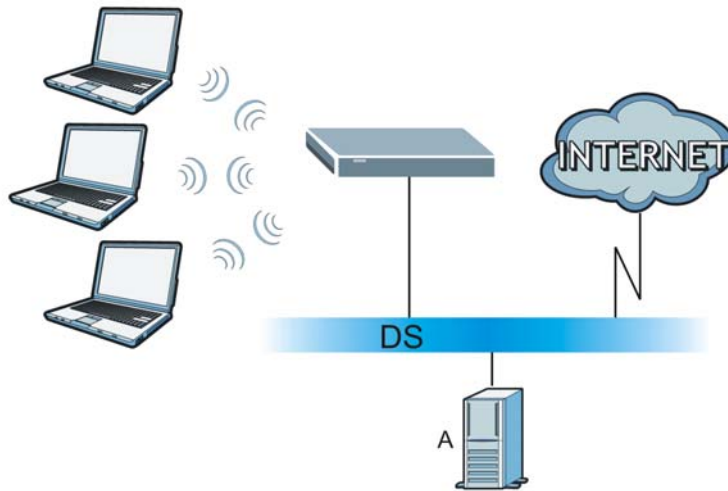

WPA(2)-PSK Application Example

A WPA(2)-PSK application looks as follows.

- 1 First enter identical passwords into the AP and all wireless clients. The Pre-Shared Key (PSK) must consist of between 8 and 63 ASCII characters or 64 hexadecimal characters (including spaces and symbols).
- 2 The AP checks each wireless client's password and allows it to join the network only if the password matches.
- 3 The AP and wireless clients generate a common PMK (Pairwise Master Key). The key itself is not sent over the network, but is derived from the PSK and the SSID.

- 4 The AP and wireless clients use the TKIP or AES encryption process, the PMK and information exchanged in a handshake to create temporal encryption keys. They use these keys to encrypt data exchanged between them.

Figure 139 WPA(2)-PSK Authentication

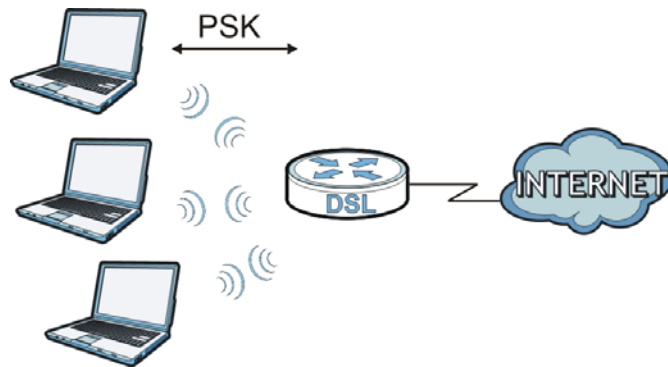

Security Parameters Summary

Refer to this table to see what other security parameters you should configure for each authentication method or key management protocol type. MAC address filters are not dependent on how you configure these security features.

Table 110 Wireless Security Relational Matrix

AUTHENTICATION METHOD/ KEY MANAGEMENT PROTOCOL	ENCRYPTION METHOD	ENTER MANUAL KEY	IEEE 802.1X
Open	None	No	Disable
			Enable without Dynamic WEP Key
Open	WEP	No	Enable with Dynamic WEP Key
		Yes	Enable without Dynamic WEP Key
		Yes	Disable
Shared	WEP	No	Enable with Dynamic WEP Key
		Yes	Enable without Dynamic WEP Key
		Yes	Disable
WPA	TKIP/AES	No	Enable
WPA-PSK	TKIP/AES	Yes	Disable
WPA2	TKIP/AES	No	Enable
WPA2-PSK	TKIP/AES	Yes	Disable

Antenna Overview

An antenna couples RF signals onto air. A transmitter within a wireless device sends an RF signal to the antenna, which propagates the signal through the air. The antenna also operates in reverse by capturing RF signals from the air.

Positioning the antennas properly increases the range and coverage area of a wireless LAN.

Antenna Characteristics

Frequency

An antenna in the frequency of 2.4GHz (IEEE 802.11b and IEEE 802.11g) or 5GHz (IEEE 802.11a) is needed to communicate efficiently in a wireless LAN

Radiation Pattern

A radiation pattern is a diagram that allows you to visualize the shape of the antenna's coverage area.

Antenna Gain

Antenna gain, measured in dB (decibel), is the increase in coverage within the RF beam width. Higher antenna gain improves the range of the signal for better communications.

For an indoor site, each 1 dB increase in antenna gain results in a range increase of approximately 2.5%. For an unobstructed outdoor site, each 1dB increase in gain results in a range increase of approximately 5%. Actual results may vary depending on the network environment.

Antenna gain is sometimes specified in dBi, which is how much the antenna increases the signal power compared to using an isotropic antenna. An isotropic antenna is a theoretical perfect antenna that sends out radio signals equally well in all directions. dBi represents the true gain that the antenna provides.

Types of Antennas for WLAN

There are two types of antennas used for wireless LAN applications.

- Omni-directional antennas send the RF signal out in all directions on a horizontal plane. The coverage area is torus-shaped (like a donut) which makes these antennas ideal for a room environment. With a wide coverage area, it is possible to make circular overlapping coverage areas with multiple access points.
- Directional antennas concentrate the RF signal in a beam, like a flashlight does with the light from its bulb. The angle of the beam determines the width of the coverage pattern. Angles typically range from 20 degrees (very directional) to 120 degrees (less directional). Directional antennas are ideal for hallways and outdoor point-to-point applications.

Positioning Antennas

In general, antennas should be mounted as high as practically possible and free of obstructions. In point-to-point application, position both antennas at the same height and in a direct line of sight to each other to attain the best performance.

For omni-directional antennas mounted on a table, desk, and so on, point the antenna up. For omni-directional antennas mounted on a wall or ceiling, point the antenna down. For a single AP application, place omni-directional antennas as close to the center of the coverage area as possible.

For directional antennas, point the antenna in the direction of the desired coverage area.

Services

The following table lists some commonly-used services and their associated protocols and port numbers.

- **Name:** This is a short, descriptive name for the service. You can use this one or create a different one, if you like.
- **Protocol:** This is the type of IP protocol used by the service. If this is **TCP/UDP**, then the service uses the same port number with TCP and UDP. If this is **USER-DEFINED**, the **Port(s)** is the IP protocol number, not the port number.
- **Port(s):** This value depends on the **Protocol**.
 - If the **Protocol** is **TCP, UDP, or TCP/UDP**, this is the IP port number.
 - If the **Protocol** is **USER**, this is the IP protocol number.
- **Description:** This is a brief explanation of the applications that use this service or the situations in which this service is used.

Table 111 Examples of Services

NAME	PROTOCOL	PORT(S)	DESCRIPTION
AH (IPSEC_TUNNEL)	User-Defined	51	The IPSEC AH (Authentication Header) tunneling protocol uses this service.
AIM	TCP	5190	AOL's Internet Messenger service.
AUTH	TCP	113	Authentication protocol used by some servers.
BGP	TCP	179	Border Gateway Protocol.
BOOTP_CLIENT	UDP	68	DHCP Client.
BOOTP_SERVER	UDP	67	DHCP Server.
CU-SEEME	TCP/UDP TCP/UDP	7648 24032	A popular videoconferencing solution from White Pines Software.
DNS	TCP/UDP	53	Domain Name Server, a service that matches web names (for instance www.zyxel.com) to IP numbers.
ESP (IPSEC_TUNNEL)	User-Defined	50	The IPSEC ESP (Encapsulation Security Protocol) tunneling protocol uses this service.
FINGER	TCP	79	Finger is a UNIX or Internet related command that can be used to find out if a user is logged on.
FTP	TCP TCP	20 21	File Transfer Protocol, a program to enable fast transfer of files, including large files that may not be possible by e-mail.
H.323	TCP	1720	NetMeeting uses this protocol.
HTTP	TCP	80	Hyper Text Transfer Protocol - a client/server protocol for the world wide web.
HTTPS	TCP	443	HTTPS is a secured http session often used in e-commerce.
ICMP	User-Defined	1	Internet Control Message Protocol is often used for diagnostic purposes.
ICQ	UDP	4000	This is a popular Internet chat program.
IGMP (MULTICAST)	User-Defined	2	Internet Group Multicast Protocol is used when sending packets to a specific group of hosts.
IKE	UDP	500	The Internet Key Exchange algorithm is used for key distribution and management.
IMAP4	TCP	143	The Internet Message Access Protocol is used for e-mail.
IMAP4S	TCP	993	This is a more secure version of IMAP4 that runs over SSL.
IRC	TCP/UDP	6667	This is another popular Internet chat program.

Table 111 Examples of Services (continued)

NAME	PROTOCOL	PORT(S)	DESCRIPTION
MSN Messenger	TCP	1863	Microsoft Networks' messenger service uses this protocol.
NetBIOS	TCP/UDP	137	The Network Basic Input/Output System is used for communication between computers in a LAN.
	TCP/UDP	138	
	TCP/UDP	139	
	TCP/UDP	445	
NEW-ICQ	TCP	5190	An Internet chat program.
NEWS	TCP	144	A protocol for news groups.
NFS	UDP	2049	Network File System - NFS is a client/server distributed file service that provides transparent file sharing for network environments.
NNTP	TCP	119	Network News Transport Protocol is the delivery mechanism for the USENET newsgroup service.
PING	User-Defined	1	Packet INternet Groper is a protocol that sends out ICMP echo requests to test whether or not a remote host is reachable.
POP3	TCP	110	Post Office Protocol version 3 lets a client computer get e-mail from a POP3 server through a temporary connection (TCP/IP or other).
POP3S	TCP	995	This is a more secure version of POP3 that runs over SSL.
PPTP	TCP	1723	Point-to-Point Tunneling Protocol enables secure transfer of data over public networks. This is the control channel.
PPTP_TUNNEL (GRE)	User-Defined	47	PPTP (Point-to-Point Tunneling Protocol) enables secure transfer of data over public networks. This is the data channel.
RCMD	TCP	512	Remote Command Service.
REAL_AUDIO	TCP	7070	A streaming audio service that enables real time sound over the web.
REXEC	TCP	514	Remote Execution Daemon.
RLOGIN	TCP	513	Remote Login.
ROADRUNNER	TCP/UDP	1026	This is an ISP that provides services mainly for cable modems.
RTELNET	TCP	107	Remote Telnet.
RTSP	TCP/UDP	554	The Real Time Streaming (media control) Protocol (RTSP) is a remote control for multimedia on the Internet.

Table 111 Examples of Services (continued)

NAME	PROTOCOL	PORT(S)	DESCRIPTION
SFTP	TCP	115	The Simple File Transfer Protocol is an old way of transferring files between computers.
SMTP	TCP	25	Simple Mail Transfer Protocol is the message-exchange standard for the Internet. SMTP enables you to move messages from one e-mail server to another.
SMTPS	TCP	465	This is a more secure version of SMTP that runs over SSL.
SNMP	TCP/UDP	161	Simple Network Management Program.
SNMP-TRAPS	TCP/UDP	162	Traps for use with the SNMP (RFC:1215).
SQL-NET	TCP	1521	Structured Query Language is an interface to access data on many different types of database systems, including mainframes, midrange systems, UNIX systems and network servers.
SSDP	UDP	1900	The Simple Service Discovery Protocol supports Universal Plug-and-Play (UPnP).
SSH	TCP/UDP	22	Secure Shell Remote Login Program.
STRM WORKS	UDP	1558	Stream Works Protocol.
SYSLOG	UDP	514	Syslog allows you to send system logs to a UNIX server.
TACACS	UDP	49	Login Host Protocol used for (Terminal Access Controller Access Control System).
TELNET	TCP	23	Telnet is the login and terminal emulation protocol common on the Internet and in UNIX environments. It operates over TCP/IP networks. Its primary function is to allow users to log into remote host systems.
TFTP	UDP	69	Trivial File Transfer Protocol is an Internet file transfer protocol similar to FTP, but uses the UDP (User Datagram Protocol) rather than TCP (Transmission Control Protocol).
VDOLIVE	TCP UDP	7000 user- defined	A videoconferencing solution. The UDP port number is specified in the application.

Legal Information

Copyright

Copyright © 2010 by ZyXEL Communications Corporation.

The contents of this publication may not be reproduced in any part or as a whole, transcribed, stored in a retrieval system, translated into any language, or transmitted in any form or by any means, electronic, mechanical, magnetic, optical, chemical, photocopying, manual, or otherwise, without the prior written permission of ZyXEL Communications Corporation.

Published by ZyXEL Communications Corporation. All rights reserved.

Disclaimer

ZyXEL does not assume any liability arising out of the application or use of any products, or software described herein. Neither does it convey any license under its patent rights nor the patent rights of others. ZyXEL further reserves the right to make changes in any products described herein without notice. This publication is subject to change without notice.

Trademarks

ZyNOS (ZyXEL Network Operating System) is a registered trademark of ZyXEL Communications, Inc. Other trademarks mentioned in this publication are used for identification purposes only and may be properties of their respective owners.

Certifications

Federal Communications Commission (FCC) Interference Statement

The device complies with Part 15 of FCC rules. Operation is subject to the following two conditions:

- This device may not cause harmful interference.

- This device must accept any interference received, including interference that may cause undesired operations.

This device has been tested and found to comply with the limits for a Class B digital device pursuant to Part 15 of the FCC Rules. These limits are designed to provide reasonable protection against harmful interference in a residential installation. This device generates, uses, and can radiate radio frequency energy, and if not installed and used in accordance with the instructions, may cause harmful interference to radio communications. However, there is no guarantee that interference will not occur in a particular installation.

If this device does cause harmful interference to radio/television reception, which can be determined by turning the device off and on, the user is encouraged to try to correct the interference by one or more of the following measures:

- 1 Reorient or relocate the receiving antenna.
- 2 Increase the separation between the equipment and the receiver.
- 3 Connect the equipment into an outlet on a circuit different from that to which the receiver is connected.
- 4 Consult the dealer or an experienced radio/TV technician for help.



FCC Radiation Exposure Statement

- This transmitter must not be co-located or operating in conjunction with any other antenna or transmitter.
- IEEE 802.11b or 802.11g operation of this product in the U.S.A. is firmware-limited to channels 1 through 11.
- To comply with FCC RF exposure compliance requirements, a separation distance of at least 20 cm must be maintained between the antenna of this device and all persons.

畠筵 !

爰騏 倅烷鏡 珮 憐鞞 畚悞熺 焂

崇脞浹允 烧漏曠 啞躡樞倅烷鏡憐 畚 烧 舛 偓彥P 琫鏢鯽啞鏊
機植併覬鯨諛 躡 鏡P 焂陸烷鏡鯽 躡豨 樞髮鞞鉉烷蛭Q

崇脞嬭允 倅烷鏡憐 畚樞啞鏊併覬董 貝鞞偓鉉愨熺啞焂 拈 烧穫漸
饒愨熺漸 謔 鏊兎蛄苒鏊 協礪竅誦鉉愨熺謔騶覬砒啞鏊Q
稜 啞焂 拈 諱爰 拈 秘偶侶樞鉉現 拈Q 倅烷鏡憐 畚 績
崎啞焂 拈鯽闕侶P 甌鉉鉉 騶鏊 珮 憐鞞 畚 砒樞愨熺Q

鷓奮 振併懃熾啣焞 諧徧併倚餽懃熾掙 九牽愆髑髻楔啞鑿Q
 眞憚 鐳珮董 幙 啞鑿Q

Notices

Changes or modifications not expressly approved by the party responsible for compliance could void the user's authority to operate the equipment.

This device has been designed for the WLAN 2.4 GHz network throughout the EC region and Switzerland, with restrictions in France.

This Class B digital apparatus complies with Canadian ICES-003.

Cet appareil numérique de la classe B est conforme à la norme NMB-003 du Canada.

Viewing Certifications

- 1 Go to <http://www.zyxel.com>.
- 2 Select your product on the ZyXEL home page to go to that product's page.
- 3 Select the certification you wish to view from this page.

ZyXEL Limited Warranty

ZyXEL warrants to the original end user (purchaser) that this product is free from any defects in materials or workmanship for a period of up to two years from the date of purchase. During the warranty period, and upon proof of purchase, should the product have indications of failure due to faulty workmanship and/or materials, ZyXEL will, at its discretion, repair or replace the defective products or components without charge for either parts or labor, and to whatever extent it shall deem necessary to restore the product or components to proper operating condition. Any replacement will consist of a new or re-manufactured functionally equivalent product of equal or higher value, and will be solely at the discretion of ZyXEL. This warranty shall not apply if the product has been modified, misused, tampered with, damaged by an act of God, or subjected to abnormal working conditions.

Note

Repair or replacement, as provided under this warranty, is the exclusive remedy of the purchaser. This warranty is in lieu of all other warranties, express or implied, including any implied warranty of merchantability or fitness for a particular use or

purpose. ZyXEL shall in no event be held liable for indirect or consequential damages of any kind to the purchaser.

To obtain the services of this warranty, contact ZyXEL's Service Center for your Return Material Authorization number (RMA). Products must be returned Postage Prepaid. It is recommended that the unit be insured when shipped. Any returned products without proof of purchase or those with an out-dated warranty will be repaired or replaced (at the discretion of ZyXEL) and the customer will be billed for parts and labor. All repaired or replaced products will be shipped by ZyXEL to the corresponding return address, Postage Paid. This warranty gives you specific legal rights, and you may also have other rights that vary from country to country.

Registration

Register your product online to receive e-mail notices of firmware upgrades and information at www.zyxel.com for global products, or at www.us.zyxel.com for North American products.

Index

Numerics

- 802.1p [171](#), [172](#)
- 802.1Q/1P [161](#)
 - activation [163](#)
 - group settings [164](#)
 - port settings [166](#)
 - priority [161](#)
 - PVC [162](#)
 - PVID [166](#)
 - tagging frames [162](#), [165](#)

A

- activation
 - 802.1Q/1P [163](#)
 - CWMP [198](#)
 - dynamic DNS [176](#)
 - DYNDNS wildcard [176](#)
 - firewalls [149](#)
 - MAC address filter [108](#)
 - NAT [133](#)
 - port forwarding [137](#)
 - QoS [169](#), [170](#)
 - SIP ALG [141](#)
 - SPI [149](#)
 - UPnP [189](#)
 - wireless LAN [102](#)
 - scheduling [115](#)
 - WPS [111](#)
- address mapping [138](#)
 - rules [140](#)
 - types [139](#), [140](#), [144](#)
- administrator password [28](#), [202](#)
- alerts [205](#)
- alternative subnet mask notation [272](#)
- antenna
 - directional [304](#)
 - gain [303](#)
 - omni-directional [304](#)
- AP (access point) [291](#)

- application filter [153](#)
- applications, NAT [144](#)
- Asynchronous Transfer Mode, see ATM
- ATM [225](#)
 - MBS [73](#), [78](#)
 - PCR [73](#), [78](#)
 - QoS [73](#), [78](#), [82](#)
 - SCR [73](#), [78](#)
 - status [225](#)
- authentication [118](#), [120](#)
 - RADIUS server [120](#)
 - WPA [106](#)

B

- backup
 - configuration [219](#)
- Basic Service Set, See BSS [289](#)
- Basic Service Set, see BSS
- broadcast [68](#)
- BSS [121](#), [289](#)
 - example [122](#)

C

- CA [297](#)
- CBR [73](#), [78](#), [82](#)
- Certificate Authority
 - See CA.
- certifications [309](#)
 - notices [311](#)
 - viewing [311](#)
- channel [291](#)
 - interference [291](#)
- channel, wireless LAN [117](#)
- CLI [21](#)
- client list [90](#)
- Command Line Interface, see CLI

- compatibility, WDS [113](#)
- configuration
 - backup [219](#)
 - CWMP [198](#)
 - DHCP [89](#)
 - file [216](#)
 - firewalls [149](#)
 - IP alias [92](#)
 - IP precedence [170](#)
 - IP/MAC filter [155](#)
 - logs [205](#)
 - port forwarding [135](#)
 - reset [221](#)
 - restoring [219](#)
 - static route [159](#)
 - WAN [69](#)
 - wireless LAN [101](#)
 - wizard [56](#)
- connection
 - nailed-up [76, 81](#)
 - on demand [76](#)
- copyright [309](#)
- CPE WAN Management Protocol, see CWMP
- CTS (Clear to Send) [292](#)
- CTS threshold [106, 118](#)
- CWMP [197](#)
 - activation [198](#)
 - configuration [198](#)

D

- data fragment threshold [106, 118](#)
- DDoS [148](#)
- default server, NAT [134, 136](#)
- Denials of Service, see DoS
- DHCP [86, 89, 94](#)
- diagnostic [223](#)
- DiffServ Code Point, see DSCP
- disclaimer [309](#)
- DNS [86, 90, 94, 184](#)
- Domain Name System, see DNS
- DoS [148](#)
- DSCP [170](#)
- DSL connections, status [226](#)
- dynamic DNS [175](#)

- activation [176](#)
- wildcard [175](#)
 - activation [176](#)

Dynamic Host Configuration Protocol, see DHCP

dynamic WEP key exchange [298](#)

DYNDNS wildcard [175](#)

- activation [176](#)

E

- EAP Authentication [296](#)
- encapsulation [67, 70, 76](#)
 - ENET ENCAP [79](#)
 - PPPoA [79](#)
 - PPPoE [79](#)
 - RFC 1483 [79](#)
- encryption [102, 120, 299](#)
 - WEP [103](#)
 - key [104](#)
 - WPA [105](#)
 - authentication [106](#)
 - reauthentication [105](#)
 - WPA-PSK [104](#)
 - pre-shared key [104](#)
- ENET ENCAP [70, 76, 79](#)
- ESS [290](#)
- Extended Service Set, See ESS [290](#)

F

- FCC interference statement [309](#)
- filters [151](#)
 - application [153](#)
 - IP/MAC [154](#)
 - structure [151](#)
 - IP/MAC filter
 - configuration [155](#)
 - MAC address [108, 119](#)
 - activation [108](#)
 - URL [151, 152](#)
- firewalls [147](#)
 - configuration [149](#)
 - DDoS [148](#)
 - DoS [148](#)

LAND attack [148](#)
 Ping of Death [148](#)
 status [37](#)
 SYN attack [147](#)
 firmware [216](#)
 version [36](#)
 forwarding ports [132](#), [134](#)
 activation [137](#)
 configuration [135](#)
 example [135](#)
 rules [137](#)
 fragmentation threshold [106](#), [118](#), [293](#)
 FTP [21](#), [181](#)

H

hidden node [291](#)

I

IANA [277](#)
 Internet Assigned Numbers Authority
 see IANA
 IBSS [289](#)
 ICMP [185](#)
 IEEE 802.11g [293](#)
 IGA [142](#)
 IGMP [68](#), [86](#), [88](#), [97](#)
 ILA [142](#)
 Independent Basic Service Set
 See IBSS [289](#)
 initialization vector (IV) [299](#)
 Inside Global Address, see IGA
 Inside Local Address, see ILA
 Internet Group Multicast Protocol, see IGMP
 IP address [68](#), [71](#), [76](#), [80](#), [86](#), [95](#)
 default server [134](#), [136](#)
 ping [223](#)
 private [96](#)
 IP alias [91](#)
 configuration [92](#)
 NAT applications [144](#)
 IP precedence [171](#), [173](#)

 configuration [170](#)
 IP/MAC filter [154](#)
 configuration [155](#)
 structure [151](#)

L

LAN [85](#)
 client list [90](#)
 DHCP [86](#), [89](#), [94](#)
 DNS [86](#), [90](#), [94](#)
 IGMP [86](#), [97](#)
 IP address [86](#), [87](#), [95](#)
 IP alias [91](#)
 configuration [92](#)
 MAC address [91](#)
 multicast [86](#), [88](#), [97](#)
 RIP [86](#), [88](#), [93](#), [96](#)
 status [36](#)
 subnet mask [86](#), [87](#), [95](#)
 LAND attack [148](#)
 LEDs [25](#)
 limitations
 wireless LAN [121](#)
 WPS [129](#)
 Local Area Network, see LAN
 login [27](#)
 passwords [28](#)
 logs [205](#)
 alerts [205](#)
 settings [205](#)

M

MAC address [91](#), [108](#)
 filter [100](#), [102](#), [108](#), [119](#)
 MAC address filter
 activation [108](#)
 Management Information Base (MIB) [183](#)
 mapping address [138](#)
 rules [140](#)
 types [139](#), [140](#), [144](#)
 Maximum Burst Size, see MBS
 Maximum Transmission Unit, see MTU

MBS [73](#), [78](#), [82](#)
MBSSID [122](#)
MTU [73](#), [78](#)
multicast [68](#), [73](#), [86](#), [88](#), [97](#)
 IGMPInternet Group Multicast Protocol, see
 IGMP
Multiple BSS, see MBSSID
multiplexing [70](#), [76](#), [80](#)
 LLC-based [80](#)
 VC-based [80](#)

N

nailed-up connection [71](#), [76](#), [81](#)
NAT [77](#), [131](#), [132](#), [142](#), [277](#)
 activation [133](#)
 address mapping [138](#)
 rules [140](#)
 types [139](#), [140](#), [144](#)
 applications [144](#)
 IP alias [144](#)
 default server IP address [134](#), [136](#)
 example [143](#)
 global [142](#)
 IGA [142](#)
 ILA [142](#)
 inside [142](#)
 local [142](#)
 outside [142](#)
 P2P [133](#)
 port forwarding [132](#), [134](#)
 activation [137](#)
 configuration [135](#)
 example [135](#)
 rules [137](#)
 remote management [179](#)
 SIP ALG [141](#)
 activation [141](#)
 SUA [132](#), [133](#)
Network Address Translation
 see NAT
Network Address Translation, see NAT

P

P2P [133](#)
Pairwise Master Key (PMK) [299](#), [301](#)
passwords [28](#)
 administrator [202](#)
PBC [124](#)
PCR [73](#), [78](#), [81](#)
Peak Cell Rate, see PCR
PIN, WPS [112](#), [113](#), [124](#)
 example [126](#)
Ping of Death [148](#)
port forwarding [132](#), [134](#)
 activation [137](#)
 configuration [135](#)
 example [135](#)
 rules [137](#)
PPPoA [70](#), [76](#), [79](#)
PPPoE [70](#), [76](#), [79](#)
preamble [107](#), [118](#)
preamble mode [293](#)
pre-shared key [104](#)
private IP address [96](#)
product registration [312](#)
PSK [299](#)
push button [113](#)
Push Button Configuration, see PBC
push button, WPS [124](#)
PVC [162](#)
PVID [166](#)

Q

QoS [167](#)
 802.1p [171](#), [172](#)
 activation [169](#), [170](#)
 DSCP [170](#)
 example [167](#)
 IP precedence [171](#), [173](#)
 priority queue [173](#)
Quality of Service, see QoS

R

RADIUS [295](#)
 message types [295](#)
 messages [295](#)
 shared secret key [296](#)

RADIUS server [120](#)

reauthentication, WPA [105](#)

registration
 product [312](#)

related documentation [3](#)

remote management [177](#)
 DNS [184](#)
 FTP [181](#)
 ICMP [185](#)
 limitations [178](#)
 NAT [179](#)
 Telnet [180](#)
 WWW [179](#)

reset [26](#), [221](#)

restart [221](#)

restoring configuration [219](#)

RFC 1483 [70](#), [76](#), [79](#)

RIP [72](#), [86](#), [88](#), [93](#), [96](#)

Routing Information Protocol, see RIP

RTS (Request To Send) [292](#)
 threshold [291](#), [292](#)

RTS threshold [106](#), [118](#)

rules, port forwarding [137](#)

S

safety warnings [7](#)

schedules
 wireless LAN [115](#)

SCR [73](#), [78](#), [82](#)

security
 wireless LAN [102](#), [118](#)

Security Parameter Index, see SPI

Service Set IDentifier, see SSID

setup
 DHCP [89](#)
 firewalls [149](#)
 IP alias [92](#)
 IP precedenceQoS
 IP precedence [170](#)
 IP/MAC filter [155](#)
 logs [205](#)
 port forwarding [135](#)
 static route [159](#)
 WAN [69](#)
 wireless LAN [101](#)
 wizard [56](#)

shaping traffic [81](#), [82](#)

Simple Network Management Protocol, see SNMP

Single User Account, see SUA

SIP ALG [141](#)
 activation [141](#)

SNMP [182](#)
 agents [183](#)
 Manager [183](#)
 managers [183](#)
 MIB [183](#)
 network components [183](#)
 traps [183](#)
 versions [182](#)

SPI [148](#)
 activation [149](#)

SSID [100](#), [102](#), [110](#), [119](#)
 MBSSID [122](#)

static route [157](#)
 configuration [159](#)
 example [157](#)

status [31](#), [35](#), [38](#)
 ATM [225](#)
 DSL connections [226](#)
 firewalls [37](#)
 firmware version [36](#)
 LAN [36](#)
 WAN [36](#)
 wireless LAN [36](#)
 WPS [112](#)

SUA [132](#), [133](#)

subnet [269](#)

subnet mask [86](#), [95](#), [270](#)

subnetting [272](#)

Sustain Cell Rate, see SCR

SYN attack [147](#)

syntax conventions [5](#)

system [201](#)

- firmware [216](#)
 - version [36](#)
- LED [25](#)
- passwords [28](#)
 - administrator [202](#)
- reset [26](#)
- status [31, 35](#)
 - firewalls [37](#)
 - LAN [36](#)
 - WAN [36](#)
 - wireless LAN [36](#)
- time [202](#)

T

- tagging frames [162, 165](#)
- Telnet [180](#)
- thresholds
 - data fragment [106, 118](#)
 - RTS/CTS [106, 118](#)
- time [202](#)
- TR-069 [21](#)
- trademarks [309](#)
- traffic priority [161](#)
- traffic shaping [81](#)
 - example [82](#)

U

- UBR [73, 78, 83](#)
- unicast [68](#)
- Universal Plug and Play, see UPnP
- upgrading firmware [216](#)
- UPnP [187](#)
 - activation [189](#)
 - cautions [188](#)
 - NAT traversal [187](#)
- URL [151](#)
- URL filter [152](#)
 - URL [151](#)

V

- VBR [82](#)
- VBR-nRT [73, 78, 83](#)
- VBR-RT [73, 78, 83](#)
- VCI [70, 76, 80](#)
- Virtual Channel Identifier, see VCI
- Virtual Local Area Network, see VLAN
- Virtual Path Identifier, see VPI
- VLAN [161](#)
 - 802.1P priority [161](#)
 - activation [163](#)
 - group settings [164](#)
 - port settings [166](#)
 - PVC [162](#)
 - PVID [166](#)
 - tagging frames [162, 165](#)
- VPI [70, 76, 80](#)

W

- WAN [67](#)
 - ATM QoS [73, 78, 82](#)
 - encapsulation [67, 70, 76](#)
 - IGMP [68](#)
 - IP address [68, 71, 76, 80](#)
 - mode [70, 75](#)
 - MTU [73, 78](#)
 - multicast [68, 73](#)
 - multiplexing [70, 76, 80](#)
 - nailed-up connection [71, 76, 81](#)
 - NAT [77](#)
 - RIP [72](#)
 - setup [69](#)
 - status [36](#)
 - traffic shaping [81](#)
 - example [82](#)
 - VCI [70, 76, 80](#)
 - VPI [70, 76, 80](#)
- warranty [311](#)
 - note [311](#)
- WDS [113, 123](#)
 - compatibility [113](#)
 - example [123](#)
- web configurator [21, 27](#)
 - login [27](#)

- passwords **28**
- WEP **103, 121**
 - key **104**
- Wide Area Network, see WAN
- Wi-Fi Protected Access **298**
- WiFi Protected Setup, see WPS
- wireless client WPA supplicants **300**
- Wireless Distribution System, see WDS
- wireless LAN **99, 116**
 - activation **102**
 - authentication **118, 120**
 - BSS **121**
 - example **122**
 - channel **117**
 - configuration **101**
 - encryption **102, 120**
 - example **116**
 - fragmentation threshold **106, 118**
 - limitations **121**
 - MAC address filter **100, 102, 108, 119**
 - MBSSID **122**
 - preamble **107, 118**
 - RADIUS server **120**
 - RTS/CTS threshold **106, 118**
 - scheduling **115**
 - security **118**
 - SSID **100, 102, 110, 119**
 - status **36**
 - WDS **113, 123**
 - compatibility **113**
 - example **123**
 - WEP **103, 121**
 - key **104**
 - wizard **62**
 - WPA **105, 121**
 - authentication **106**
 - reauthentication **105**
 - WPA-PSK **104, 121**
 - pre-shared key **104**
 - WPS **111, 123, 126**
 - activation **111**
 - adding stations **113**
 - example **128**
 - limitations **129**
 - PIN **112, 113, 124**
 - push button **113, 124**
 - status **112**
 - wireless security **294**
 - Wireless tutorial **41**
 - wizard **53**
 - configuration **56**
 - wireless LAN **62**
 - WLAN
 - interference **291**
 - security parameters **302**
 - WPA **105, 121, 298**
 - authentication **106**
 - key caching **300**
 - pre-authentication **300**
 - reauthentication **105**
 - user authentication **300**
 - vs WPA-PSK **299**
 - wireless client supplicant **300**
 - with RADIUS application example **300**
 - WPA2 **298**
 - user authentication **300**
 - vs WPA2-PSK **299**
 - wireless client supplicant **300**
 - with RADIUS application example **300**
 - WPA2-Pre-Shared Key **298**
 - WPA2-PSK **298, 299**
 - application example **301**
 - WPA-PSK **104, 121, 299**
 - application example **301**
 - pre-shared key **104**
 - WPS **111, 123, 126**
 - activation **111**
 - adding stations **113**
 - example **128**
 - limitations **129**
 - PIN **112, 113, 124**
 - example **126**
 - push button **113, 124**
 - status **112**

