

# *P-330W*

*802.11g Secure Wireless Internet Sharing Router*

## *User's Guide*

Version 1.1  
July 2006



# Copyright

Copyright © 2005 by ZyXEL Communications Corporation.

The contents of this publication may not be reproduced in any part or as a whole, transcribed, stored in a retrieval system, translated into any language, or transmitted in any form or by any means, electronic, mechanical, magnetic, optical, chemical, photocopying, manual, or otherwise, without the prior written permission of ZyXEL Communications Corporation.

Published by ZyXEL Communications Corporation. All rights reserved.

## **Disclaimer**

ZyXEL does not assume any liability arising out of the application or use of any products, or software described herein. Neither does it convey any license under its patent rights nor the patent rights of others. ZyXEL further reserves the right to make changes in any products described herein without notice. This publication is subject to change without notice.

## **Trademarks**

ZyNOS (ZyXEL Network Operating System) is a registered trademark of ZyXEL Communications, Inc. Other trademarks mentioned in this publication are used for identification purposes only and may be properties of their respective owners.

# Federal Communications Commission (FCC) Interference Statement

This device complies with Part 15 of FCC rules. Operation is subject to the following two conditions:

- This device may not cause harmful interference.
- This device must accept any interference received, including interference that may cause undesired operations.

This equipment has been tested and found to comply with the limits for a Class B digital device pursuant to Part 15 of the FCC Rules. These limits are designed to provide reasonable protection against harmful interference in a commercial environment. This equipment generates, uses, and can radiate radio frequency energy, and if not installed and used in accordance with the instructions, may cause harmful interference to radio communications.

If this equipment does cause harmful interference to radio/television reception, which can be determined by turning the equipment off and on, the user is encouraged to try to correct the interference by one or more of the following measures:

- Reorient or relocate the receiving antenna.
- Increase the separation between the equipment and the receiver.
- Connect the equipment into an outlet on a circuit different from that to which the receiver is connected.
- Consult the dealer or an experienced radio/TV technician for help.

## Notice 1

Changes or modifications not expressly approved by the party responsible for compliance could void the user's authority to operate the equipment.

## Certifications

Go to [www.us.zyxel.com](http://www.us.zyxel.com)

- 1 Select your product from the drop-down list box on the ZyXEL home page to go to that product's page.
- 2 Select the certification you wish to view from this page

# ZyXEL Limited Warranty

ZyXEL warrants to the original end user (purchaser) that this product is free from any defects in materials or workmanship for a period of up to two years from the date of purchase. During the warranty period, and upon proof of purchase, should the product have indications of failure due to faulty workmanship and/or materials, ZyXEL will, at its discretion, repair or replace the defective products or components without charge for either parts or labor, and to whatever extent it shall deem necessary to restore the product or components to proper operating condition. Any replacement will consist of a new or re-manufactured functionally equivalent product of equal value, and will be solely at the discretion of ZyXEL. This warranty shall not apply if the product is modified, misused, tampered with, damaged by an act of God, or subjected to abnormal working conditions.

## Note

Repair or replacement, as provided under this warranty, is the exclusive remedy of the purchaser. This warranty is in lieu of all other warranties, express or implied, including any implied warranty of merchantability or fitness for a particular use or purpose. ZyXEL shall in no event be held liable for indirect or consequential damages of any kind of character to the purchaser.

To obtain the services of this warranty, contact ZyXEL's Service Center for your Return Material Authorization number (RMA). Products must be returned Postage Prepaid. It is recommended that the unit be insured when shipped. Any returned products without proof of purchase or those with an out-dated warranty will be repaired or replaced (at the discretion of ZyXEL) and the customer will be billed for parts and labor. All repaired or replaced products will be shipped by ZyXEL to the corresponding return address, Postage Paid. This warranty gives you specific legal rights, and you may also have other rights that vary from country to country.

## Safety Warnings

- 1** To reduce the risk of fire, use only No. 26 AWG or larger telephone wire.
- 2** Do not use this product near water, for example, in a wet basement or near a swimming pool.
- 3** Avoid using this product during an electrical storm. There may be a remote risk of electric shock from lightening.

This product has been designed for the WLAN 2.4 GHz network throughout the EC region and Switzerland, with restrictions in France.

# Customer Support

Please have the following information ready when you contact customer support.

- Product model and serial number.
- Warranty Information.
- Date that you received your device.
- Brief description of the problem and the steps you took to solve it.

<b>METHOD</b>	<b>SUPPORT E-MAIL</b>	<b>TELEPHONE</b>	<b>WEB SITE</b>	<b>REGULAR MAIL</b>
<b>LOCATION</b>	<b>SALES E-MAIL</b>	<b>FAX</b>	<b>FTP SITE</b>	
<b>NORTH AMERICA</b>	support@zyxel.com	+1-800-978-7222 +1-714-632-0882	www.us.zyxel.com	ZyXEL Communications Inc. 1130 N. Miller St.
	sales@zyxel.com	+1-714-632-0858	ftp.us.zyxel.com	Anaheim CA 92806-2001 U.S.A.

# Table of Contents

<b>Copyright</b> .....	<b>2</b>
<b>Federal Communications Commission (FCC) Interference Statement</b> .....	<b>3</b>
<b>ZyXEL Limited Warranty</b> .....	<b>4</b>
<b>Customer Support</b> .....	<b>5</b>
<b>Preface</b> .....	<b>18</b>
<b>Chapter 1</b>	
<b>Getting to Know Your P-330W</b> .....	<b>20</b>
1.1 P-330W Internet Security Gateway Overview .....	20
1.2 P-330W Features .....	20
1.2.1 Physical Features .....	20
1.2.1.1 10/100M Auto-negotiating Ethernet/Fast Ethernet Interface(s) .....	20
1.2.1.2 Auto-crossover 10/100 Mbps Ethernet Interface(s) .....	20
1.2.1.3 4-Port Switch .....	20
1.2.1.4 Time and Date .....	21
1.2.1.5 Reset Button .....	21
1.2.2 Removable Antenna .....	21
1.2.3 Non-Physical Features .....	21
1.2.3.1 Firewall .....	21
1.2.3.2 802.11b Wireless LAN Standard .....	21
1.2.3.3 802.11g Wireless LAN Standard .....	22
1.2.3.4 Packet Filtering .....	22
1.2.3.5 Universal Plug and Play (UPnP) .....	22
1.2.3.6 PPPoE .....	22
1.2.3.7 PPTP Encapsulation .....	22
1.2.3.8 Dynamic DNS Support .....	22
1.2.3.9 Network Address Translation (NAT) .....	23
1.2.3.10 Port Forwarding .....	23
1.2.3.11 DHCP (Dynamic Host Configuration Protocol) .....	23
1.2.3.12 Logging and Tracing .....	23
1.2.3.13 Wireless Association List .....	23
1.3 Applications for the P-330W .....	23
1.3.1 Secure Broadband Internet Access via Cable or DSL Modem .....	23

---

1.3.2 Internet Access Application .....	24
<b>Chapter 2</b>	
<b>Introducing the Web Configurator.....</b>	<b>26</b>
2.1 Web Configurator Overview .....	26
2.2 Accessing the P-330W Web Configurator .....	26
2.2.0.1 Resetting the P-330W .....	26
2.2.1 Navigating the P-330W Web Configurator .....	27
2.2.2 Navigation Panel .....	27
<b>Chapter 3</b>	
<b>Wizard Setup .....</b>	<b>30</b>
3.1 Wizard Setup Overview .....	30
3.2 Wizard Setup: Screen 2 .....	30
3.2.1 DHCP Client .....	30
3.2.2 Static IP .....	30
3.2.3 PPPoE Encapsulation .....	31
3.2.4 PPTP Encapsulation .....	32
3.2.5 L2TP Encapsulation .....	33
3.3 Wizard Setup: Screen 3 .....	34
3.4 Wizard Setup: Screen 4 .....	35
3.4.1 No Encryption .....	36
3.4.2 WEP Encryption .....	36
3.4.3 WPA .....	37
3.4.4 WPA2 (AES) .....	37
3.4.5 WPA2 Mixed .....	38
3.5 Basic Setup Complete .....	39
<b>Chapter 4</b>	
<b>System Screens .....</b>	<b>40</b>
4.1 Setup Wizard .....	40
4.2 Operation Mode .....	40
4.3 LAN Overview .....	41
4.3.1 DHCP Setup .....	42
4.3.2 IP Pool Setup .....	42
4.3.3 System DNS Servers .....	42
4.3.4 LAN TCP/IP .....	42
4.3.5 Factory LAN Defaults .....	42
4.3.6 IP Address and Subnet Mask .....	42
4.3.7 Configuring IP .....	42
4.4 Configuring Password .....	44
4.5 Status Screen .....	44

<b>Chapter 5</b>	
<b>Wireless</b> .....	<b>46</b>
5.1 Wireless LAN Overview .....	46
5.1.1 IBSS .....	46
5.1.2 BSS .....	46
5.1.3 ESS .....	47
5.1.4 RTS/CTS .....	48
5.2 Configuring Wireless .....	49
5.3 Basic Settings .....	49
5.4 Wireless Advanced Settings .....	51
5.4.1 Authentication .....	51
5.4.2 Preamble Type .....	52
5.5 Site Survey .....	53
5.6 Wireless Security Overview .....	53
5.7 Security Parameters Summary .....	56
5.7.1 WEP Overview .....	56
5.7.2 Data Encryption .....	56
5.7.3 Configuring WEP Encryption .....	56
5.7.4 Introduction to WPA .....	59
5.7.4.1 User Authentication .....	59
5.7.4.2 Encryption .....	59
5.7.4.3 WPA-PSK Application Example .....	60
5.7.5 Introduction to WPA2 .....	60
5.7.6 Configuring WPA-PSK Authentication .....	60
5.7.7 Introduction to RADIUS .....	62
5.7.7.1 Types of RADIUS Messages .....	62
5.7.7.2 Access-Challenge .....	62
5.7.7.3 Accounting-Request .....	62
5.7.7.4 Accounting-Response .....	62
5.7.7.5 EAP Authentication Overview .....	63
5.7.7.6 WPA with RADIUS Application Example .....	63
5.7.8 Configuring WPA Authentication .....	64
5.8 WDS Settings .....	66
5.9 Wireless Trusted Stations .....	67
<b>Chapter 6</b>	
<b>Advanced Options</b> .....	<b>70</b>
6.1 Access Control .....	70
6.2 Dynamic DNS .....	71
6.3 Configuring Dynamic DNS .....	72
6.4 DMZ .....	73
6.5 Virtual Servers (Port Forwarding) .....	73
6.5.0.1 Configuring Servers Behind SUA (Example) .....	74



6.5.1 Configuring Virtual Servers .....	75
6.6 Special Applications .....	76
6.7 WAN Port .....	77
6.7.1 Static IP Encapsulation .....	77
6.7.2 DHCP IP Encapsulation .....	79
6.7.3 PPPoE Encapsulation .....	80
6.7.4 PPTP Encapsulation .....	82
6.7.5 L2TP Encapsulation .....	84
6.8 Ping .....	86
6.9 DoS Setting .....	87
6.10 Diagnostics .....	88

## **Chapter 7 Administrator Options ..... 90**

7.1 Remote Management .....	90
7.2 Configuration Screen .....	90
7.2.1 Backup Configuration .....	91
7.2.2 Restore Configuration .....	91
7.2.3 Back to Factory Defaults .....	92
7.3 Logs .....	92
7.4 IP Filtering .....	94
7.5 MAC Filtering .....	95
7.6 URL Filtering .....	95
7.7 Statistics .....	96
7.8 Time Zone Setting .....	96
7.9 Upgrade Firmware .....	97

## **Appendix A PPPoE ..... 100**

## **Appendix B PPTP ..... 102**

## **Appendix C Setting up Your Computer's IP Address ..... 106**

## **Appendix D Wireless LAN and IEEE 802.11 ..... 118**

## **Appendix E Wireless LAN With IEEE 802.1x ..... 122**

## **Appendix F Types of EAP Authentication ..... 124**

## **Appendix G**

**Antenna Selection and Positioning Recommendation..... 126**

**Appendix H**

**Open Software Announcements..... 128**



# List of Figures

Figure 1 Secure Internet Access via Cable, DSL or Wireless Modem .....	24
Figure 2 Internet Access Application Example .....	24
Figure 3 The MAIN MENU Screen of the Web Configurator .....	27
Figure 4 Wizard 2: DHCP Client Encapsulation .....	30
Figure 5 Wizard 2: Static IP Encapsulation .....	31
Figure 6 Wizard 2: PPPoE Encapsulation .....	32
Figure 7 Wizard 2: PPTP Encapsulation .....	33
Figure 8 Wizard 2: L2TP Encapsulation .....	34
Figure 9 Wizard 3: Wireless LAN Basic Setup .....	35
Figure 10 Wizard 4: Wireless LAN Setup: WEP Security .....	36
Figure 11 Wizard 4: Wireless LAN Setup: WPA Security .....	37
Figure 12 Wizard 4: Wireless LAN Setup: WPA2 Security .....	38
Figure 13 Wizard 4: Wireless LAN Setup: WPA2 Security .....	39
Figure 14 System Screen Menu Options .....	40
Figure 15 Operation Mode Setup .....	41
Figure 16 LAN IP Setup .....	43
Figure 17 Password .....	44
Figure 18 Status .....	45
Figure 19 IBSS (Ad-hoc) Wireless LAN .....	46
Figure 20 Basic Service set .....	47
Figure 21 Extended Service Set .....	48
Figure 22 RTS/CTS .....	48
Figure 23 The Wireless Options Screen .....	49
Figure 24 Wireless: Basic Settings .....	50
Figure 25 WEP Authentication Steps .....	51
Figure 26 Wireless: Advanced Settings .....	52
Figure 27 Wireless: Site Survey .....	53
Figure 28 P-330W Wireless Security Levels .....	54
Figure 29 Wireless Security Setup: No Security .....	55
Figure 30 Wireless Security Setup: WEP Encryption .....	57
Figure 31 Wireless Security Setup: WEP Encryption .....	58
Figure 32 WPA - PSK Authentication .....	60
Figure 33 Wireless Security Setup: WPA-PSK .....	61
Figure 34 EAP Authentication .....	63
Figure 35 WPA with RADIUS Application Example .....	64
Figure 36 Wireless Security Setup: WPA With RADIUS .....	65

Figure 37 Wireless: WDS Settings .....	66
Figure 38 Wireless: Trusted Stations MAC Address Filter .....	68
Figure 39 The Advanced Menu Options .....	70
Figure 40 Advanced: Access Control .....	71
Figure 41 Advanced: Dynamic DNS .....	72
Figure 42 Advanced: DMZ .....	73
Figure 43 Multiple Servers Behind NAT Example .....	75
Figure 44 Advanced: Virtual Servers .....	75
Figure 45 Advanced: Special Applications .....	77
Figure 46 Advanced: WAN Static IP Encapsulation .....	78
Figure 47 Advanced: WAN DHCP IP Encapsulation .....	79
Figure 48 Advanced: WAN PPPoE Encapsulation .....	81
Figure 49 Advanced: WAN PPTP Encapsulation .....	83
Figure 50 Advanced: WAN L2TP Encapsulation .....	85
Figure 51 Advanced: Ping .....	87
Figure 52 Advanced: DoS .....	88
Figure 53 Advanced: Diagnostic .....	89
Figure 54 Administrator: Remote Management .....	90
Figure 55 Administrator: Configuration File .....	91
Figure 56 Temporarily Disconnected .....	92
Figure 57 Administrator: Logs .....	93
Figure 58 Administrator: IP Filtering .....	94
Figure 59 Administrator: MAC Filtering .....	95
Figure 60 Administrator: URL Filtering .....	96
Figure 61 Administrator: Time Zone Setting .....	97
Figure 62 Administrator: Upgrade Firmware .....	98
Figure 63 Upload Warning .....	98
Figure 64 Network Temporarily Disconnected .....	99
Figure 65 Single-Computer per Router Hardware Configuration .....	101
Figure 66 P-330W as a PPPoE Client .....	101
Figure 67 Transport PPP frames over Ethernet .....	102
Figure 68 PPTP Protocol Overview .....	103
Figure 69 Example Message Exchange between Computer and an ANT .....	104
Figure 70 Windows 95/98/Me: Network: Configuration .....	107
Figure 71 Windows 95/98/Me: TCP/IP Properties: IP Address .....	108
Figure 72 Windows 95/98/Me: TCP/IP Properties: DNS Configuration .....	109
Figure 73 Windows XP: Start Menu .....	110
Figure 74 Windows XP: Control Panel .....	110
Figure 75 Windows XP: Control Panel: Network Connections: Properties .....	111
Figure 76 Windows XP: Local Area Connection Properties .....	111
Figure 77 Windows XP: Advanced TCP/IP Settings .....	112
Figure 78 Windows XP: Internet Protocol (TCP/IP) Properties .....	113
Figure 79 Macintosh OS 8/9: Apple Menu .....	114

Figure 80 Macintosh OS 8/9: TCP/IP .....	115
Figure 81 Macintosh OS X: Apple Menu .....	115
Figure 82 Macintosh OS X: Network .....	116
Figure 83 Peer-to-Peer Communication in an Ad-hoc Network .....	119
Figure 84 ESS Provides Campus-Wide Coverage .....	120
Figure 85 Sequences for EAP MD5–Challenge Authentication .....	123



# List of Tables

Table 1 IEEE 802.11b .....	21
Table 2 IEEE 802.11g .....	22
Table 3 Screens Summary .....	28
Table 4 Wizard 2: Ethernet Encapsulation .....	31
Table 5 Wizard 2: PPPoE Encapsulation .....	32
Table 6 Wizard 2: PPTP Encapsulation .....	33
Table 7 Wizard 2: L2TP Encapsulation .....	34
Table 8 Wizard 3: Wireless LAN Basic Setup .....	35
Table 9 Wizard 4: Wireless LAN Setup: WEP Security .....	36
Table 10 Wizard 4: Wireless LAN Setup: WPA Security .....	37
Table 11 Wizard 4: Wireless LAN Setup: WPA2 Security .....	38
Table 12 Wizard 4: Wireless LAN Setup: WPA2 Security .....	39
Table 13 System General Setup .....	41
Table 14 LAN IP Setup .....	43
Table 15 Password .....	44
Table 16 Status .....	45
Table 17 Wireless: Basic Settings .....	50
Table 18 Wireless: Advanced Settings .....	52
Table 19 Wireless Security Setup: No Security .....	55
Table 20 Wireless Security Relational Matrix .....	56
Table 21 Wireless Security Setup: Static WEP Encryption .....	57
Table 22 Wireless Security Setup: WEP Encryption .....	58
Table 23 Wireless Security Setup: WPA-PSK .....	61
Table 24 Wireless Security Setup: WPA .....	65
Table 25 Wireless: WDS Settings .....	66
Table 26 Wireless: Trusted Stations MAC Address Filter .....	68
Table 27 Advanced: Access Control .....	71
Table 28 Advanced: Dynamic DNS .....	72
Table 29 Advanced: DMZ .....	73
Table 30 Services and Port Numbers .....	74
Table 31 Advanced: Virtual Servers .....	75
Table 32 Advanced: Special Applications .....	77
Table 33 Advanced: WAN Static IP Encapsulation .....	78
Table 34 Advanced: WAN DHCP IP Encapsulation .....	79
Table 35 PPPoE Encapsulation .....	81
Table 36 Advanced: WAN PPTP Encapsulation .....	83



Table 37 Advanced: WAN L2PT Encapsulation .....	85
Table 38 Advanced: Ping .....	87
Table 39 Advanced: DoS .....	88
Table 40 Advanced: Diagnostic .....	89
Table 41 Administrator: Remote Management .....	90
Table 42 Maintenance Restore Configuration .....	91
Table 43 Administrator: Remote Management .....	93
Table 44 Administrator: IP Filtering .....	94
Table 45 Administrator: MAC Filtering .....	95
Table 46 Administrator: URL Filtering .....	96
Table 47 Administrator: Time Zone Setting .....	97
Table 48 Administrator: Upgrade Firmware .....	98
Table 49 Comparison of EAP Authentication Types .....	125

# Preface

Congratulations on your purchase of the P-330W, 802.11g Secure Wireless Internet Sharing Router. This manual is designed to guide you through the configuration of your P-330W for its various applications.

This manual may refer to the P-330W or 802.11g Secure Wireless Internet Sharing Router as the router.



**Note:** Register your product online to receive e-mail notices of firmware upgrades and information at [www.us.zyxel.com](http://www.us.zyxel.com).

## About This User's Guide

This User's Guide is designed to guide you through the configuration of your P-330W using the web configurator(GUI). The web configurator parts of this guide contain background information on features configurable by web configurator.

## Related Documentation

- Support Disk  
Refer to the included CD for support documents.
- Quick Start Guide  
The Quick Start Guide is designed to help you get up and running right away. They contain connection information and instructions on getting started.
- ZyXEL Glossary and Web Site  
Please refer to [www.us.zyxel.com](http://www.us.zyxel.com) for an online glossary of networking terms and additional support documentation.









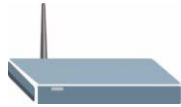

## User Guide Feedback

Help us help you! E-mail all User Guide-related comments, questions or suggestions for improvement to [techwriters@zyxel.com](mailto:techwriters@zyxel.com)

## Syntax Conventions

- “Enter” means for you to type one or more characters. “Select” or “Choose” means for you to use one predefined choices.
- Mouse action sequences are denoted using a comma. For example, “click the Apple icon, **Control Panels** and then **Modem**” means first click the Apple icon, then point your mouse pointer to **Control Panels** and then click **Modem**.
- For brevity's sake, we will use “e.g.,” as a shorthand for “for instance”, and “i.e.,” for “that is” or “in other words” throughout this manual.

## Graphics Icons Key

P-330W 	Computer 	Notebook computer 
Server 	DSLAM 	Firewall 
Modem 	Switch 	Router 
Wireless Signal 		

# CHAPTER 1

## Getting to Know Your P-330W

This chapter introduces the main features and applications of the P-330W.

### 1.1 P-330W Internet Security Gateway Overview

The P-330W is the ideal secure gateway for all data passing between the Internet and LAN's.

By integrating NAT, firewall, wireless access point and 4-port switch, ZyXEL's P-330W is a complete security solution that protects your Intranet and efficiently manages data traffic on your network.

The embedded web configurator is easy to operate.

### 1.2 P-330W Features

The following sections describe P-330W features..

#### 1.2.1 Physical Features

##### 1.2.1.1 10/100M Auto-negotiating Ethernet/Fast Ethernet Interface(s)

This auto-negotiation feature allows the P-330W to detect the speed of incoming transmissions and adjust appropriately without manual intervention. It allows data transfer of either 10 Mbps or 100 Mbps in either half-duplex or full-duplex mode depending on your Ethernet network.

##### 1.2.1.2 Auto-crossover 10/100 Mbps Ethernet Interface(s)

These interfaces automatically adjust to either a crossover or straight-through Ethernet cable.

##### 1.2.1.3 4-Port Switch

A combination of switch and router makes your P-330W a cost-effective and viable network solution. You can add up to four computers to the P-330W without the cost of a hub. Add more than four computers to your LAN by using a hub.

### 1.2.1.4 Time and Date

The P-330W allows you to get the current time and date from an external server when you turn on your P-330W. You can also set the time manually.

### 1.2.1.5 Reset Button

The P-330W reset button is built into the rear panel. You can use this button to either cause the P-330W to reboot, or to reset the P-330W to factory defaults. Use this button to restore the factory default password to 1234; IP address to 192.168.10.1, subnet mask to 255.255.255.0 and DHCP server enabled with a pool of 32 IP addresses starting at 192.168.10.33. For further instructions see Chapter 2.

## 1.2.2 Removable Antenna

The P-330W antenna uses an RP-SMA connection to attach to the P-330W. It is possible to remove the antenna and replace it with another antenna that offers different performance characteristics.

## 1.2.3 Non-Physical Features

### 1.2.3.1 Firewall

The P-330W is a home firewall with DoS (Denial of Service) protection. By default, all incoming traffic from the WAN to the LAN is blocked unless it is initiated from the LAN.

### 1.2.3.2 802.11b Wireless LAN Standard

The P-330W, complies with the 802.11b wireless standard.

The 802.11b data rate and corresponding modulation techniques are as follows. The modulation technique defines how bits are encoded onto radio waves.

**Table 1** IEEE 802.11b

DATA RATE (KBPS)	MODULATION
1	DBPSK (Differential Binary Phase Shift Keyed)
2	DQPSK (Differential Quadrature Phase Shift Keying)
5.5 / 11	CCK (Complementary Code Keying)



**Note:** The P-330W may be prone to RF (Radio Frequency) interference from other 2.4 GHz devices such as microwave ovens, wireless phones, Bluetooth enabled devices, and other wireless LANs

---

### 1.2.3.3 802.11g Wireless LAN Standard

The P-330W, complies with the 802.11g wireless standard and is also fully compatible with the 802.11b standard. This means an 802.11b radio card can interface directly with an 802.11g device (and vice versa) at 11 Mbps or lower depending on range. 802.11g has several intermediate rate steps between the maximum and minimum data rates. The 802.11g data rate and modulation are as follows:

**Table 2** IEEE 802.11g

DATA RATE (MBPS)	MODULATION
6/9/12/18/24/36/48/54	OFDM (Orthogonal Frequency Division Multiplexing)

### 1.2.3.4 Packet Filtering

The packet filtering mechanism blocks unwanted traffic from entering/leaving your network.

### 1.2.3.5 Universal Plug and Play (UPnP)

Using the standard TCP/IP protocol, the P-330W and other UPnP enabled devices can dynamically join a network, obtain an IP address and convey its capabilities to other devices on the network.

### 1.2.3.6 PPPoE

PPPoE facilitates the interaction of a host with an Internet modem to achieve access to high-speed data networks via a familiar "dial-up networking" user interface.

### 1.2.3.7 PPTP Encapsulation

Point-to-Point Tunneling Protocol (PPTP) is a network protocol that enables secure transfer of data from a remote client to a private server, creating a Virtual Private Network (VPN) using a TCP/IP-based network.

PPTP supports on-demand, multi-protocol and virtual private networking over public networks, such as the Internet. The P-330W supports one PPTP server connection at any given time.

### 1.2.3.8 Dynamic DNS Support

With Dynamic DNS (Domain Name System) support, you can have a static hostname alias for a dynamic IP address, allowing the host to be more easily accessible from various locations on the Internet. You must register for this service with a Dynamic DNS service provider.

### **1.2.3.9 Network Address Translation (NAT)**

Network Address Translation (NAT) allows the translation of an Internet protocol address used within one network (for example a private IP address used in a local network) to a different IP address known within another network (for example a public IP address used on the Internet).

### **1.2.3.10 Port Forwarding**

Use this feature to forward incoming service requests to a server on your local network. You may enter a single port number or a range of port numbers to be forwarded, and the local IP address of the desired server.

### **1.2.3.11 DHCP (Dynamic Host Configuration Protocol)**

DHCP (Dynamic Host Configuration Protocol) allows the individual client computers to obtain the TCP/IP configuration at start-up from a centralized DHCP server. The P-330W has built-in DHCP server capability, enabled by default, which means it can assign IP addresses, an IP default gateway and DNS servers to all systems that support the DHCP client.

### **1.2.3.12 Logging and Tracing**

- System Logs
- Wireless Logs
- DoS Logs

### **1.2.3.13 Wireless Association List**

With the Wireless Association List, you can see the list of the wireless stations that are currently using the P-330W to access your wired network.

## **1.3 Applications for the P-330W**

Here are some examples of what you can do with your P-330W.

### **1.3.1 Secure Broadband Internet Access via Cable or DSL Modem**

You can connect a cable modem, DSL or wireless modem to the P-330W for broadband Internet access via an Ethernet or a wireless port on the modem. The P-330W guarantees not only high speed Internet access, but secure internal network protection and traffic management as well.

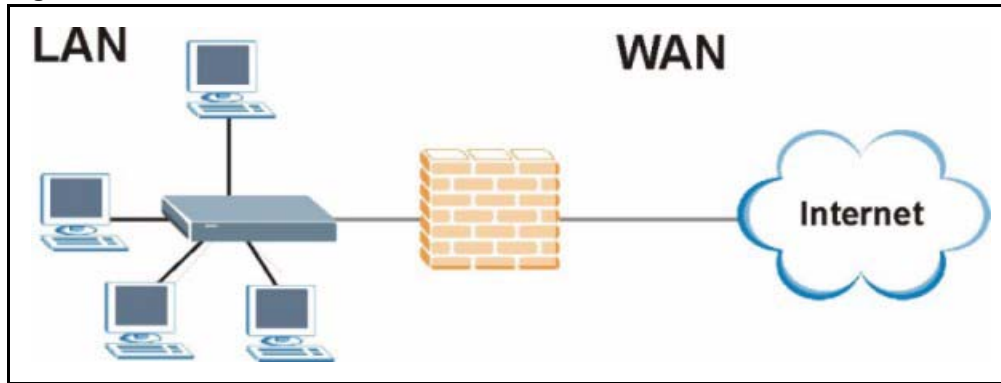
**Figure 1** Secure Internet Access via Cable, DSL or Wireless Modem

### 1.3.2 Internet Access Application

Add a wireless LAN to your existing network without expensive network cables. Wireless stations can move freely anywhere in the coverage area and use resources on the wired network.

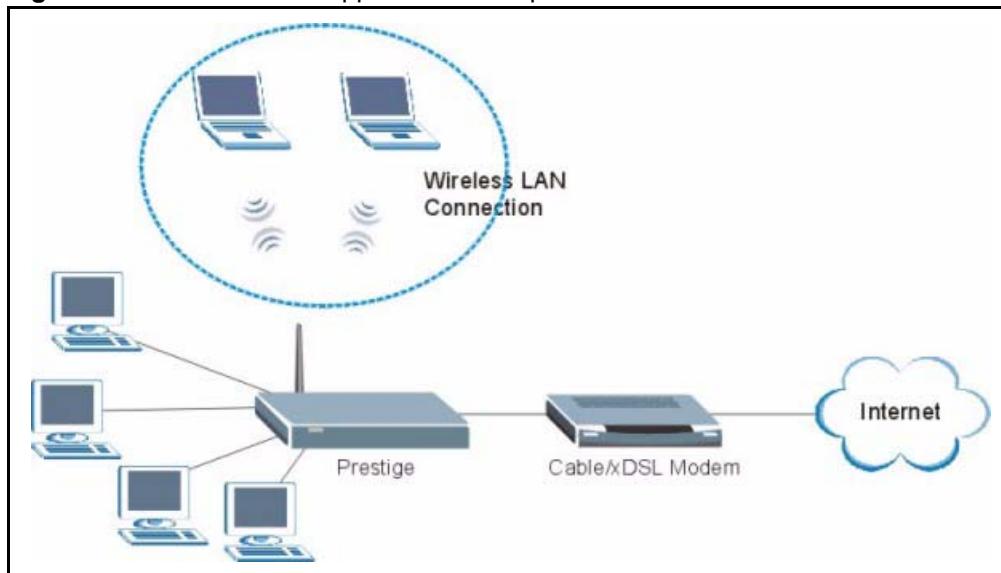
**Figure 2** Internet Access Application Example





# CHAPTER 2

## Introducing the Web Configurator

This chapter describes how to access the P-330W web configurator and provides an overview of its screens.

### 2.1 Web Configurator Overview

The embedded web configurator allows you to manage the P-330W from anywhere through a browser such as Microsoft Internet Explorer or Netscape Navigator. Use Internet Explorer 6.0 and later or Netscape Navigator 7.0 and later versions with JavaScript enabled. It is recommended that you set your screen resolution to 1024 by 768 pixels. The screens you see in the web configurator may vary somewhat from the ones shown in this document due to differences between individual P-330W models or firmware versions.

### 2.2 Accessing the P-330W Web Configurator

- 1 Make sure your P-330W hardware is properly connected and prepare your computer/ computer network to connect to the P-330W (refer to the *Quick Start Guide*).
- 2 Launch your web browser.
- 3 Type "192.168.10.1" as the URL.
- 4 Type "admin" as the User Name
- 5 Type "1234" (default) as the password.
- 6 Click **OK** to login.

You should now see the **MAIN MENU** screen)



**Note:** The management session automatically times out when there has been no activity for several minutes. Simply log back into the P-330W if this happens to you.

#### 2.2.0.1 Resetting the P-330W

If you forget your password or cannot access the web configurator, you will need to use the **RESET** button at the back of the P-330W to reload the factory-default configuration file. This means that you will lose all configurations that you had previously and the password will be reset to "1234".

### 2.2.0.1.1 Procedure To Use The Reset Button

- 1 Make sure the **PWR** LED is on (not blinking).
- 2 Press the **RESET** button for approximately ten seconds or until the **PWR** LED begins to blink and then release it. When the **PWR** LED begins to blink, the defaults have been restored and the P-330W restarts. (If you press the **RESET** button for less than 5 seconds, the P-330W will reboot, but will not reset the configuration).

## 2.2.1 Navigating the P-330W Web Configurator

The following summarizes how to navigate the web configurator from the **SITE MAP** screen.

- Click **SETUP WIZARD** for initial configuration including general setup, **Wireless LAN Setup**, ISP parameters for Internet Access and WAN IP/DNS Server/MAC address assignment.
- Click a link under **WIRELESS** to configure wireless settings.
- Click a link under **ADVANCED** to configure advanced P-330W features.
- Click **LOGOUT** at any time to exit the web configurator.
- Click **ADMINISTRATOR** to view information about your P-330W or upgrade configuration/firmware files. Administrator includes **Statistics**, **Remote Management**, **Upgrade Firmware**, **Config File** (Backup, Restore, Defaults) and **Time Zone Settings**.

**Figure 3** The MAIN MENU Screen of the Web Configurator

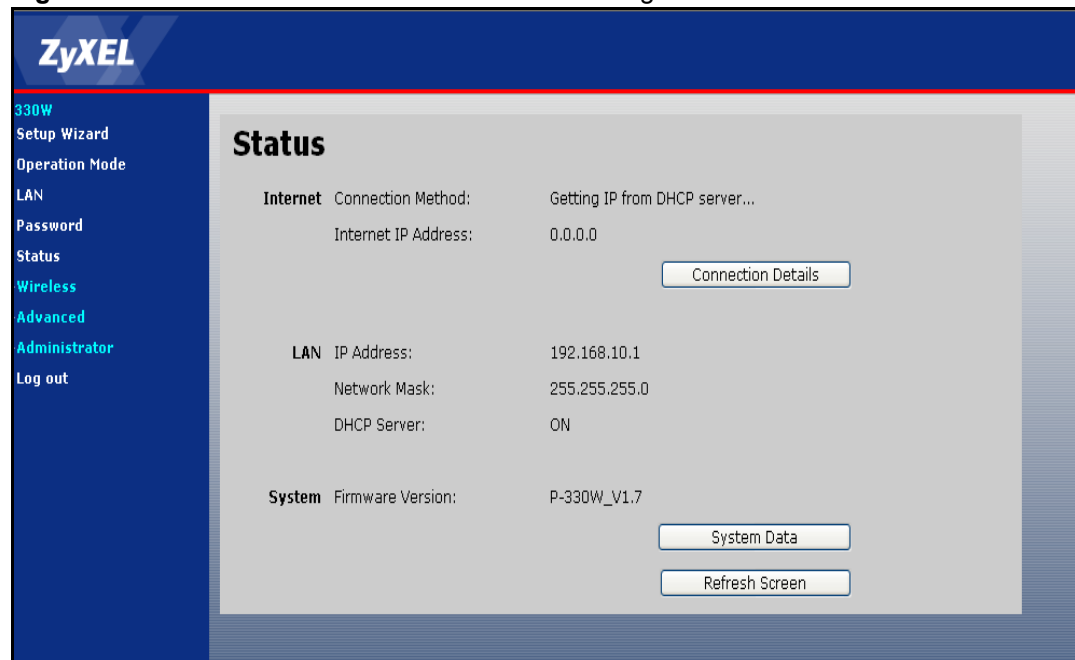

## 2.2.2 Navigation Panel

After you log in, use the sub-menus on the navigation panel to configure P-330W features.

The following table describes the sub-menus.

**Table 3** Screens Summary

LINK	TAB	FUNCTION
SETUP WIZARD		Use these screens for initial configuration including general setup, Wireless LAN setup, ISP parameters for Internet Access and WAN IP/DNS Server/MAC address assignment.
OPERATION MODE		Use this screen to switch the P-330W between gateway, bridge, and wireless client mode.
LAN		Use this screen to configure you LAN, including default IP address of the P-330W, LAN DHCP, and viewing current DHCP clients.
PASSWORD		Use this screen to change your password.
STATUS		This screen contains administrative and system-related information.
WIRELESS	Basic Settings	Use this screen to configure the wireless LAN.
	Advanced Settings	Use this screen to configured advanced wireless system behavior.
	Security	Use this screen to configure wireless encryption and authorization settings.
	Trusted Stations	Use this screen to set up MAC address filtering for WLAN clients.
ADVANCED	Access Control	Use this screen to set up packet filtering policies.
	Dynamic DNS	Use this screen to configure dynamic DNS service settings.
	DMZ	Use this screen to isolate a specific device from the rest of the network.
	Virtual Servers	Use this screen to configure servers behind the P-330W.
	Special Applications	Use this screen to change your P-330W's trigger port settings.
	ALG	Use this screen to selection which applications require special NAT rules.
	WAN Port	Use this screen to change your P-330W's WAN ISP settings.
	Ping	Use this screen to verify network connectivity.
	DoS Settings	Use this screen to configure Denial of Service settings.
	Diagnostics	Use this page to look up DNS information.
Administrator	Remote Management	Use this page to allow remote clients to manage the P-330W.
	Config File	Use this screen to backup and restore the configuration or reset the factory defaults to your P-330W.
	Logs	Use this screen to change your P-330W's log settings and to view the logs for the categories that you selected.
	IP Filtering	Use this page to configure a list of IP addresses that the router will not allow traffic to or from.
	MAC Filtering	Use the MAC filter screen to configure the P-330W to block access to devices or block the devices from accessing the P-330W.
	URL Filtering	This screen allows you to block sites containing certain web sites based on their URL.

**Table 3** Screens Summary

<b>LINK</b>	<b>TAB</b>	<b>FUNCTION</b>
Administrator	Statistics	This screen contains administrative and system-related information.
	Time Zone Setting	Use this screen to change your P-330W's time and date or enable NTP server use.
	Upgrade Firmware	Use this screen to upload firmware to your P-330W.
LOG OUT		Click this label to exit the web configurator.

# CHAPTER 3

## Wizard Setup

This chapter provides information on the Wizard Setup screens in the web configurator.

### 3.1 Wizard Setup Overview

The web configurator's setup wizard helps you configure your device to access the Internet. The second screen has five variations depending on what encapsulation type you use. Refer to your ISP checklist in the *Quick Start Guide* to know what to enter in each field. Leave a field blank if you don't have that information.

The fifth wizard screen varies according to the type of encapsulation that you select in the third wizard screen.

### 3.2 Wizard Setup: Screen 2

The P-330W offers five choices of encapsulation. They are **DHCP Client**, **Static IP**, **PPP over Ethernet**, **L2TP** or **PPTP**.

#### 3.2.1 DHCP Client

Choose **DHCP Client** when the WAN port is used as regular Ethernet and your ISP assigns you an IP address via DHCP.

**Figure 4** Wizard 2: DHCP Client Encapsulation

**Setup Wizard - WAN Interface Setup**

This page is used to configure the parameters for Internet network which connects to the WAN port of your Access Point. Here you may change the access method to static IP, DHCP, PPPoE, PPTP or L2TP by click the item value of WAN Access type.

WAN Access Type:

#### 3.2.2 Static IP

Choose Static IP when the WAN port is used as regular Ethernet and your ISP assigns you a fixed IP address.

**Figure 5** Wizard 2: Static IP Encapsulation

The following table describes the labels in this screen.

**Table 4** Wizard 2: Ethernet Encapsulation

LABEL	DESCRIPTION
ISP Parameters for Internet Access	
IP Address	The fixed IP address should be in the same subnet as your broadband modem or router. This should be provided to you by your ISP
Subnet Mask	Enter a <b>Subnet Mask</b> appropriate to your network.
Default Gateway	Enter the <b>Gateway IP Address</b> of the neighboring device, if you know it. If you do not, leave the Gateway IP Address field blank.
DNS	DNS (Domain Name System) is for mapping a domain name to its corresponding IP address and vice versa. The DNS server is extremely important because without it, you must know the IP address of a computer before you can access it. Enter your <b>DNS Server</b> IP address here.
Cancel	Click <b>Cancel</b> to abort the setup wizard.
Back	Click <b>Back</b> to return to the previous screen.
Next	Click <b>Next</b> to continue.

### 3.2.3 PPPoE Encapsulation

Point-to-Point Protocol over Ethernet (PPPoE) functions as a dial-up connection. PPPoE is an IETF (Internet Engineering Task Force) draft standard specifying how a host personal computer interacts with a broadband modem (for example DSL, cable, wireless, etc.) to achieve access to high-speed data networks.

For the service provider, PPPoE offers an access and authentication method that works with existing access control systems (for instance, Radius). For the user, PPPoE provides a login and authentication method that the existing Microsoft Dial-Up Networking software can activate, and therefore requires no new learning or procedures for Windows users.

One of the benefits of PPPoE is the ability to let end users access one of multiple network services, a function known as dynamic service selection. This enables the service provider to easily create and offer new IP services for specific users.

Operationally, PPPoE saves significant effort for both the subscriber and the ISP/carrier, as it requires no specific configuration of the broadband modem at the subscriber's site.

By implementing PPPoE directly on the P-330W (rather than individual computers), the computers on the LAN do not need PPPoE software installed, since the P-330W does that part of the task. Furthermore, with NAT, all of the LAN's computers will have Internet access.

Refer to the appendix for more information on PPPoE.

**Figure 6** Wizard 2: PPPoE Encapsulation

The following table describes the labels in this screen.

**Table 5** Wizard 2: PPPoE Encapsulation

LABEL	DESCRIPTION
ISP Parameter for Internet Access	
User Name	Type the user name given to you by your ISP.
Password	Type the password associated with the user name above.
Cancel	Click <b>Cancel</b> to abort the setup wizard.
Next	Click <b>Next</b> to continue.
Back	Click <b>Back</b> to return to the previous screen.

### 3.2.4 PPTP Encapsulation

Point-to-Point Tunneling Protocol (PPTP) is a network protocol that enables transfers of data from a remote client to a private server, creating a Virtual Private Network (VPN) using TCP/IP-based networks.

PPTP supports on-demand, multi-protocol, and virtual private networking over public networks, such as the Internet.



Refer to the appendix for more information on PPTP.



**Note:** The P-330W supports one PPTP server connection at any given time.

**Figure 7** Wizard 2: PPTP Encapsulation

**Setup Wizard - WAN Interface Setup**

This page is used to configure the parameters for Internet network which connects to the WAN port of your Access Point. Here you may change the access method to static IP, DHCP, PPPoE, PPTP or L2TP by clicking the item value of WAN Access type.

WAN Access Type:

IP Address:

Subnet Mask:

Default Gateway:

Server IP Address:

User Name:

Password:

The following table describes the fields in this screen

**Table 6** Wizard 2: PPTP Encapsulation

LABEL	DESCRIPTION
ISP Parameters for Internet Access	
IP Address	Type the (static) IP address assigned to you by your ISP.
IP Subnet Mask	Type the subnet mask assigned to you by your ISP.
Default Gateway	Type the default gateway assigned to you by your ISP.
Server IP Address	Type the IP address of the PPTP server.
User Name	Type the user name given to you by your ISP.
Password	Type the password associated with the User Name above.
Cancel	Click <b>Cancel</b> to abort the setup wizard.
Back	Click <b>Back</b> to return to the previous screen.
Next	Click <b>Next</b> to continue.

### 3.2.5 L2TP Encapsulation

Layer Two Tunneling Protocol (L2TP) is a network protocol that enables transfers of data from a remote client to a private server, creating a Virtual Private Network (VPN) using TCP/IP-based networks.

**Figure 8** Wizard 2: L2TP Encapsulation

**Setup Wizard - WAN Interface Setup**

This page is used to configure the parameters for Internet network which connects to the WAN port of your Access Point. Here you may change the access method to static IP, DHCP, PPPoE, PPTP or L2TP by clicking the item value of WAN Access type.

WAN Access Type:

Attain IP Automatically

Set IP Manually

IP Address:

Subnet Mask:

Default Gateway:

Server IP Address:

User Name:

Password:

&nbsp;
&nbsp;

The following table describes the fields in this screen

**Table 7** Wizard 2: L2TP Encapsulation

LABEL	DESCRIPTION
Attain IP Automatically	Select this if your ISP automatically assigns you an IP Address.
Set IP Manually	Select this if your ISP has assigned you a fixed IP address.
IP Address	Type the (static) IP address assigned to you by your ISP.
IP Subnet Mask	Type the subnet mask assigned to you by your ISP.
Default Gateway	Type the default gateway assigned to you by your ISP.
Server IP Address	Type the IP address of the L2TP server.
User Name	Type the user name given to you by your ISP.
Password	Type the password associated with the User Name above.
Cancel	Click <b>Cancel</b> to abort the setup wizard.
Back	Click <b>Back</b> to return to the previous screen.
Next	Click <b>Next</b> to continue.

### 3.3 Wizard Setup: Screen 3

Set up the basics of your wireless LAN using the third wizard screen.

**Figure 9** Wizard 3: Wireless LAN Basic Setup

The following table describes the labels in this screen.

**Table 8** Wizard 3: Wireless LAN Basic Setup

LABEL	DESCRIPTION
Band	Choose the operating mode of your wireless access point. <b>2.4Ghz (B+G)</b> offers the greatest compatibility. <b>2.4 GHz (B)</b> will only allow 802.11b clients to connect to the wireless LAN. <b>2.4 GHz (G)</b> will only allow 802.11g clients to connect to the wireless LAN.
SSID	Enter a descriptive name (up to 32 printable 7-bit ASCII characters) for the wireless LAN. If you change this field on the P-330W, make sure all wireless stations use the same SSID in order to access the network.
Channel Number	To manually set the P-330W to use a channel, select a channel from the drop-down list box.
Disable Access Point	Select this check box to disable the wireless LAN capabilities of your P-330W.
Cancel	Click <b>Cancel</b> to abort the setup wizard.
Back	Click <b>Back</b> to display the previous screen.
Next	Click <b>Next</b> to proceed to the next screen.



**Note:** The wireless stations and P-330W must use the same SSID, channel ID and encryption key (if encryption is enabled) for wireless communication

### 3.4 Wizard Setup: Screen 4

There are 5 different versions of this page depending on what method of encryption you want to enable on your wireless LAN.

### 3.4.1 No Encryption

Choose **None** to allow the WLAN to operate without encryption. Warning: With no encryption enabled anyone will be able to access your network and view any data you send over the wireless LAN.

### 3.4.2 WEP Encryption

Choose **WEP** to setup WEP Encryption parameters.

**Figure 10** Wizard 4: Wireless LAN Setup: WEP Security

**Setup Wizard - Wireless Security Setup**

This page allows you setup the wireless security. Turn on WEP or WPA by using Encryption Keys could prevent any unauthorized access to your wireless network.

Encryption:

Key Length:

Key Format:

Default Tx Key:

Encryption Key 1:

Encryption Key 2:

Encryption Key 3:

Encryption Key 4:

The following table describes the labels in this screen.

**Table 9** Wizard 4: Wireless LAN Setup: WEP Security

LABEL	DESCRIPTION
Key Length	Select <b>64-bit WEP</b> or <b>128-bit WEP</b> data encryption.
Key Format	Select ASCII in order to enter ASCII characters as the WEP keys. Select Hex to enter hexadecimal characters as the WEP keys.
Default Tx Key	This key refers to which key below will be used as the default key.
Key 1 to Key 4	The WEP keys are used to encrypt data. Both the P-330W and the wireless stations must use the same WEP key for data transmission. If you chose <b>64-bit WEP</b> , then enter any 5 ASCII characters or 10 hexadecimal characters ("0-9", "A-F"). If you chose <b>128-bit WEP</b> , then enter 13 ASCII characters or 26 hexadecimal characters ("0-9", "A-F"). You must configure at least one key, only one key can be activated at any one time. The default key is key 1.

**Table 9** Wizard 4: Wireless LAN Setup: WEP Security

LABEL	DESCRIPTION
Cancel	Click <b>Cancel</b> to abort the setup wizard.
Back	Click <b>Back</b> to display the previous screen.
Next	Click <b>Next</b> to proceed to the next screen.

### 3.4.3 WPA

Choose **WPA** security in the Wireless LAN Setup screen to set up a **Pre-Shared Key** using TKIP or AES encryption.

**Figure 11** Wizard 4: Wireless LAN Setup: WPA Security

The following table describes the labels in this screen.

**Table 10** Wizard 4: Wireless LAN Setup: WPA Security

LABEL	DESCRIPTION
WPA Format	You can choose to enter the pre-shared key manually in HEX format or use a passphrase. Note, many client devices only allow entry via passphrase.
Pre-Shared Key	For Passphrase: Type from 8 to 63 case-sensitive ASCII characters. For HEX: Type a 64 character hex key.
Cancel	Click <b>Cancel</b> to abort the setup wizard.
Back	Click <b>Back</b> to display the previous screen.
Next	Click <b>Next</b> to proceed to the next screen.

### 3.4.4 WPA2 (AES)

Choose **WPA2 (AES)** security in the Wireless LAN Setup screen to set up a **Pre-Shared Key** using AES encryption.

**Figure 12** Wizard 4: Wireless LAN Setup: WPA2 Security

**Setup Wizard - Wireless Security Setup**

This page allows you setup the wireless security. Turn on WEP or WPA by using Encryption Keys could prevent any unauthorized access to your wireless network.

Encryption:

WPA(Pre-Shared Key)Format:

WPA Pre-Shared Key(TKIP):

The following table describes the labels in this screen.

**Table 11** Wizard 4: Wireless LAN Setup: WPA2 Security

LABEL	DESCRIPTION
WPA Format	You can choose to enter the pre-shared key manually in HEX format or use a passphrase. Note, many client devices only allow entry via passphrase.
Pre-Shared Key	For Passphrase: Type from 8 to 63 case-sensitive ASCII characters. For HEX: Type a 64 character hex key.
Cancel	Click <b>Cancel</b> to abort the setup wizard.
Back	Click <b>Back</b> to display the previous screen.
Next	Click <b>Next</b> to proceed to the next screen.

### 3.4.5 WPA2 Mixed

Choose **WPA2 Mixed** security in the Wireless LAN Setup screen to set up a **Pre-Shared Key** using both TKIP and AES encryption. This allows both WPA and WPA2 clients to connect.

**Figure 13** Wizard 4: Wireless LAN Setup: WPA2 Security

The following table describes the labels in this screen.

**Table 12** Wizard 4: Wireless LAN Setup: WPA2 Security

LABEL	DESCRIPTION
WPA Format	You can choose to enter the pre-shared key manually in HEX format or use a passphrase. Note, many client devices only allow entry via passphrase.
Pre-Shared Key	For Passphrase: Type from 8 to 63 case-sensitive ASCII characters. For HEX: Type a 64 character hex key.
Cancel	Click <b>Cancel</b> to abort the setup wizard.
Back	Click <b>Back</b> to display the previous screen.
Next	Click <b>Next</b> to proceed to the next screen.

### 3.5 Basic Setup Complete

Click **Finish** to complete the wizard setup and save your configuration.

Well done! You have successfully set up your P-330W to operate on your network and access the Internet

# CHAPTER 4

## System Screens

This chapter provides information on the options configurable from the main System screens.

**Figure 14** System Screen Menu Options

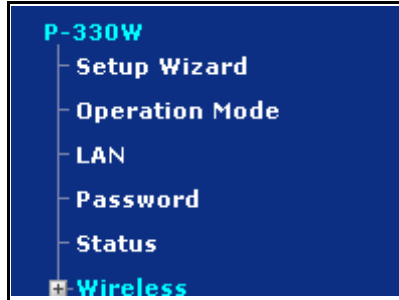

### 4.1 Setup Wizard

See the *Setup Wizard* chapter for more information on this selection.

### 4.2 Operation Mode

Click **Operation Mode** to open the **Operation Mode** screen.



**Figure 15** Operation Mode Setup

## Operation Mode

You can setup different modes to LAN and WLAN interface for NAT and bridging function.

Gateway: In this mode, the device is supposed to connect to internet via ADSL/Cable Modem. The NAT is enabled and PCs in LAN ports share the same IP to ISP through WAN port. The connection type can be setup in WAN page by using PPPOE, DHCP client, PPTP client or static IP.

Bridge: In this mode, all ethernet ports and wireless interface are bridged together and NAT function is disabled. All the WAN related function and firewall are not supported.

Wireless ISP: In this mode, all ethernet ports are bridged together and the wireless client will connect to ISP access point. The NAT is enabled and PCs in ethernet ports share the same IP to ISP through wireless LAN. You must set the wireless to client mode first and connect to the ISP AP in Site-Survey page. The connection type can be setup in WAN page by using PPPOE, DHCP client, PPTP client or static IP.

The following table describes the labels in this screen.

**Table 13** System General Setup

LABEL	DESCRIPTION
Gateway	This is the standard operating mode. The P-330W takes on all the usual roles of a home router, including NAT, DHCP Server, and Firewall.
Bridge	Select this to turn your P-330W into a pure bridge, directly linking all computers on your network to the WAN. In this mode, you have no protection from Internet based threats.
Wireless ISP	In this mode, the wireless LAN is disabled and instead the wireless module is acts as a client to connect to a Wireless ISP. All the normal router functions are enabled.
Save	Click <b>Save</b> to save your changes back to the P-330W.
Reset	Click <b>Reset</b> to begin configuring this screen afresh.

## 4.3 LAN Overview

Local Area Network (LAN) is a shared communication system to which many computers are attached. The LAN screens can help you configure a LAN DHCP server, manage IP addresses, and partition your physical network into logical networks.

### 4.3.1 DHCP Setup

DHCP (Dynamic Host Configuration Protocol, RFC 2131 and RFC 2132) allows individual clients to obtain TCP/IP configuration at start-up from a server. You can configure the P-330W as a DHCP server or disable it. When configured as a server, the P-330W provides the TCP/IP configuration for the clients. If DHCP service is disabled, you must have another DHCP server on your LAN, or else the computer must be manually configured.

### 4.3.2 IP Pool Setup

The P-330W is pre-configured with a pool of 33 IP addresses starting from 192.168.10.33 to 192.168.10.65. This configuration leaves 32 IP addresses (excluding the P-330W itself) in the lower range for other server computers, for instance, servers for mail, FTP, TFTP, web, etc., that you may have.

### 4.3.3 System DNS Servers

Refer to the *IP Address and Subnet Mask* section in the **Setup Wizard** chapter.

### 4.3.4 LAN TCP/IP

The P-330W has built-in DHCP server capability that assigns IP addresses and DNS servers to systems that support DHCP client capability.

### 4.3.5 Factory LAN Defaults

The LAN parameters of the P-330W are preset in the factory with the following values:

- IP address of 192.168.10.1 with subnet mask of 255.255.255.0 (24 bits)
- DHCP server enabled with 33 client IP addresses starting from 192.168.10.33.

These parameters should work for the majority of installations. If your ISP gives you explicit DNS server address(es), read the embedded web configurator help regarding what fields need to be configured.

### 4.3.6 IP Address and Subnet Mask

Refer to the *IP Address and Subnet Mask* section in the **Wizard Setup** chapter for this information.

### 4.3.7 Configuring IP

Click **LAN** to open the **IP** screen.

**Figure 16** LAN IP Setup

The following table describes the labels in this screen.

**Table 14** LAN IP Setup

LABEL	DESCRIPTION
IP Address	Type the IP address of your P-330W in dotted decimal notation 192.168.10.1 (factory default).
IP Subnet Mask	The subnet mask specifies the network number portion of an IP address. Your P-330W will automatically calculate the subnet mask based on the IP address that you assign. Unless you are implementing subnetting, use the subnet mask computed by the P-330W 255.255.255.0.
DHCP	DHCP (Dynamic Host Configuration Protocol, RFC 2131 and RFC 2132) allows individual clients (computers) to obtain TCP/IP configuration at startup from a server. Choose <b>Server</b> box selected unless your ISP instructs you to do otherwise. Choose <b>Disabled</b> the P-330W acting as a DHCP server. When configured as a server, the P-330W provides TCP/IP configuration for the clients. If not, DHCP service is disabled and you must have another DHCP server on your LAN, or else the computers must be manually configured. When set as a server, fill in the following four fields.
DHCP Client Range	This field specifies the contiguous addresses in the IP address pool.
Show DHCP Client	Push this button opens a new window which will show you a list of the clients that have recieved an IP address from the internal DHCP server.
MAC Address	Type the MAC address of computer which you want to assign specific IP on you LAN.
Lease IP Address	Type the IP address that you want to assign the computer on your LAN.
Save	Click <b>Apply</b> to save your changes back to the P-330W.
Reset	Click <b>Reset</b> to begin configuring this screen afresh.

## 4.4 Configuring Password

To change your P-330W's password (recommended), click the **Password** tab. The screen appears as shown. This screen allows you to change the P-330W's password.

**Figure 17** Password

**Password Setup**

This page is used to set the account to access the web server of Access Point. Empty user name and password will disable the protection.

New Password:

Confirmed Password:

Save Reset

The following table describes the labels in this screen.

**Table 15** Password

LABEL	DESCRIPTION
New Password	Type the new password in this field. The password is case sensitive and may be up to 36 characters long.
Confirmed Password	Type the new password again in this field.
Save	Click <b>Save</b> to save your changes back to the P-330W.
Reset	Click <b>Reset</b> to begin configuring this screen afresh.

## 4.5 Status Screen

Click **STATUS** to open the **Status** screen, which you can use to monitor your P-330W. Note that these fields are READ-ONLY and only for diagnostic purposes.

Figure 18 Status

**Status**

**Internet** Connection Method: Getting IP from DHCP server...  
Internet IP Address: 0.0.0.0  
Connection Details

**LAN** IP Address: 192.168.10.1  
Network Mask: 255.255.255.0  
DHCP Server: ON

**System** Firmware Version: P-330W\_V1.7  
System Data  
Refresh Screen

The following table describes the labels in this screen.

Table 16 Status

LABEL	DESCRIPTION
Connection Method	This is the method you have selected for connection to the Internet. You can change it using the <b>Setup Wizard</b> .
Internet IP Address	This is the WAN port IP address.
Connection Details	This button opens a new window that provides you with more detail on the WAN connection.
LAN	
IP Address	This is the LAN port IP address.
IP Subnet Mask	This is the LAN port subnet mask.
DHCP Server	This is the LAN port DHCP role - <b>Server (ON)</b> or <b>Disabled</b> .
System	
Firmware Version	Displays the current version number of the firmware on the P-330W.
System Data	Provides a greater level of detail on your current system configuration.
Refresh Screen	Causes the P-330W to refresh the screen with the latest information.

# CHAPTER 5

## Wireless

This chapter discusses how to configure the Wireless screens on the P-330W.

### 5.1 Wireless LAN Overview

This section introduces the wireless LAN(WLAN) and some basic scenarios.

#### 5.1.1 IBSS

An Independent Basic Service Set (IBSS), also called an Ad-hoc network, is the simplest WLAN configuration. An IBSS is defined as two or more computers with wireless adapters within range of each other that form an independent (wireless) network without the need of an access point (AP).

**Figure 19** IBSS (Ad-hoc) Wireless LAN

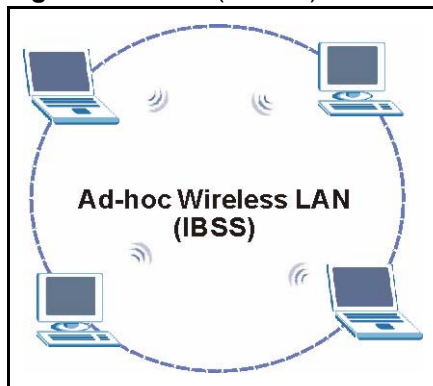

#### 5.1.2 BSS

A Basic Service Set (BSS) exists when all communications between wireless stations or between a wireless station and a wired network client go through one access point (AP).

Intra-BSS traffic is traffic between wireless stations in the BSS. When Intra-BSS is enabled, wireless station A and B can access the wired network and communicate with each other. When Intra-BSS is disabled, wireless station A and B can still access the wired network but cannot communicate with each other.

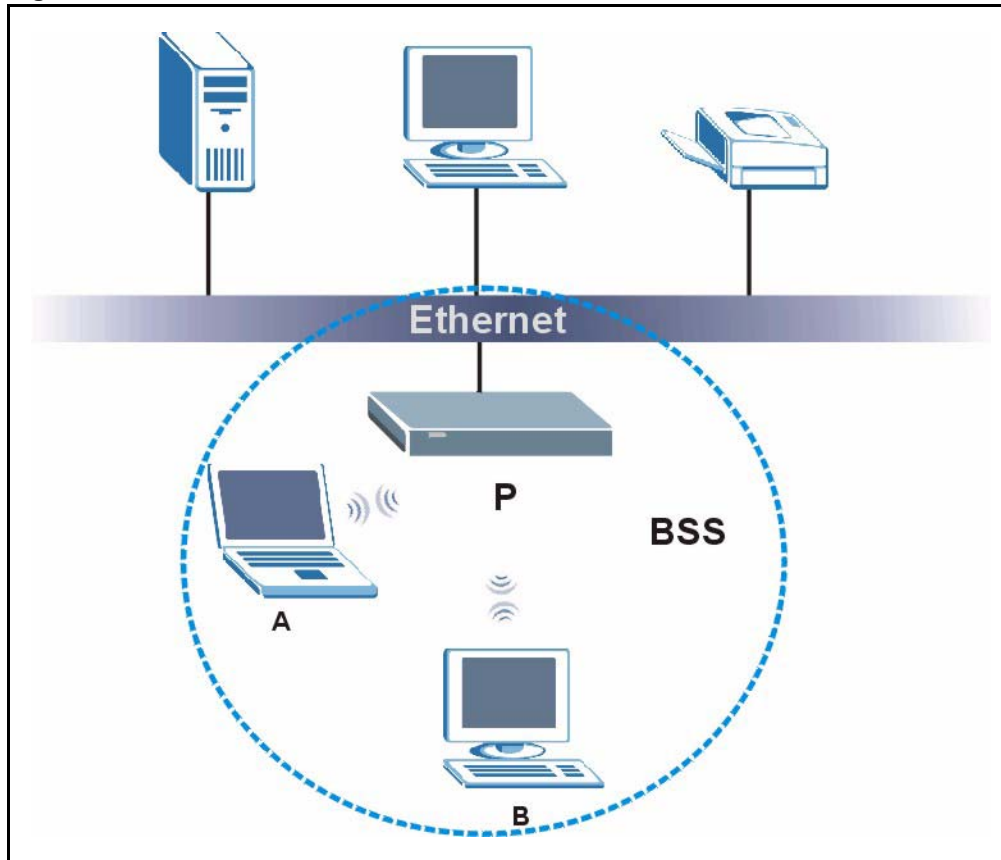
**Figure 20** Basic Service set

### 5.1.3 ESS

An Extended Service Set (ESS) consists of a series of overlapping BSSs, each containing an access point, with each access point connected together by a wired network. This wired connection between APs is called a Distribution System (DS). An ESSID (ESS Identification) uniquely identifies each ESS. All access points and their associated wireless stations within the same ESS must have the same ESSID in order to communicate.

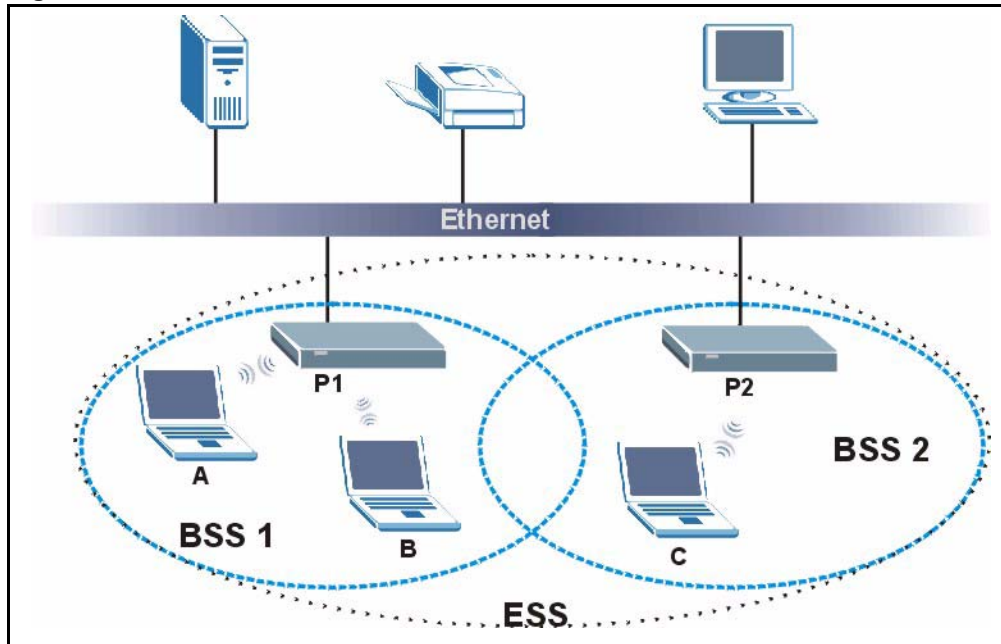
**Figure 21** Extended Service Set

### 5.1.4 RTS/CTS

A hidden node occurs when two stations are within range of the same access point, but are not within range of each other. The following figure illustrates a hidden node. Both stations (STA) are within range of the access point (AP) or wireless gateway, but out-of-range of each other, so they cannot “hear” each other, that is they do not know if the channel is currently being used. Therefore, they are considered hidden from each other.

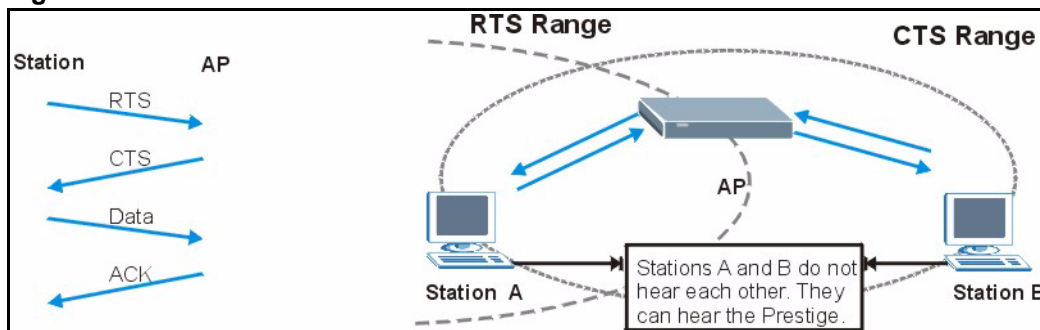
**Figure 22** RTS/CTS

When station A sends data to the P-330W, it might not know that station B is already using the channel. If these two stations send data at the same time, collisions may occur when both sets of data arrive at the AP at the same time, resulting in a loss of messages for both stations.



## 5.2 Configuring Wireless



**Note:** If you are configuring the P-330W from a computer connected to the wireless LAN and you change the P-330W's SSID or WEP settings, you will lose your wireless connection when you press Save. You must then change the wireless settings of your computer to match the P-330W's new settings.

---

Click the **WIRELESS** link to open the **Wireless Options** screen.

**Figure 23** The Wireless Options Screen

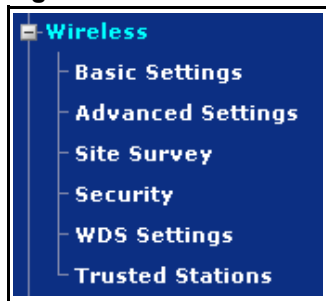

## 5.3 Basic Settings

Click **BASIC SETTINGS** to configure the basic settings of your wireless LAN.

**Figure 24** Wireless: Basic Settings

## Wireless Basic Settings

This page is used to configure the parameters for wireless LAN clients which may connect to your Access Point. Here you may change wireless encryption settings as well as wireless network parameters.

Disable Access Point

Band: 2.4 GHz (B+G)

Mode: AP

Network Type: Infrastructure

SSID: ZyXEL

Channel Number: 11

Associated Clients: Show Active Clients

Save
Reset

The following table describes the basic wireless LAN labels in this screen.

**Table 17** Wireless: Basic Settings

LABEL	DESCRIPTION
Disable Access Point	Select this check box to disable the wireless LAN capabilities of your P-330W.
Band	Choose the operating mode of your wireless access point. <b>2.4Ghz (B+G)</b> offers the greatest compatibility. <b>2.4 GHz (B)</b> will only allow 802.11b clients to connect to the wireless LAN. <b>2.4 GHz (G)</b> will only allow 802.11g clients to connect to the wireless LAN.
Mode	Mode allows you to change the wireless behavior of the P-330W. <b>AP</b> allows wireless clients to connect to the P-330W. <b>Client</b> mode activates the Wireless ISP mode of the router. Use this mode to connect to a WISP or metro-area wireless network.
Network Type	Used when operating in Client mode. This allows you to switch between <b>Infrastructure</b> and <b>Ad Hoc</b> networking modes.
SSID	(Service Set IDentity) The SSID identifies the Service Set with which a wireless station is associated. Wireless stations associating to the access point (AP) must have the same SSID. Enter a descriptive name (up to 32 printable 7-bit ASCII characters) for the wireless LAN.  <b>Note:</b> If you are configuring the P-330W from a computer connected to the wireless LAN and you change the P-330W's SSID or WEP settings, you will lose your wireless connection when you press Apply to confirm. You must then change the wireless settings of your computer to match the P-330W's new settings.
Channel Number	To manually set the P-330W to use a channel, select a channel from the drop-down list box.
Associated Clients	Click <b>Show Active Clients</b> to be shown a list of wireless clients currently connected to the Wireless LAN
Save	Click <b>Save</b> to save your changes back to the P-330W.
Reset	Click <b>Reset</b> to reload the previous configuration for this screen.

## 5.4 Wireless Advanced Settings

Click **ADVANCED SETTINGS** to configure the advanced settings of your wireless LAN.

### 5.4.1 Authentication

Three different methods can be used to authenticate wireless stations to the network: **Open System**, **Shared Key**, and **Auto**. The following figure illustrates the steps involved.

**Figure 25** WEP Authentication Steps

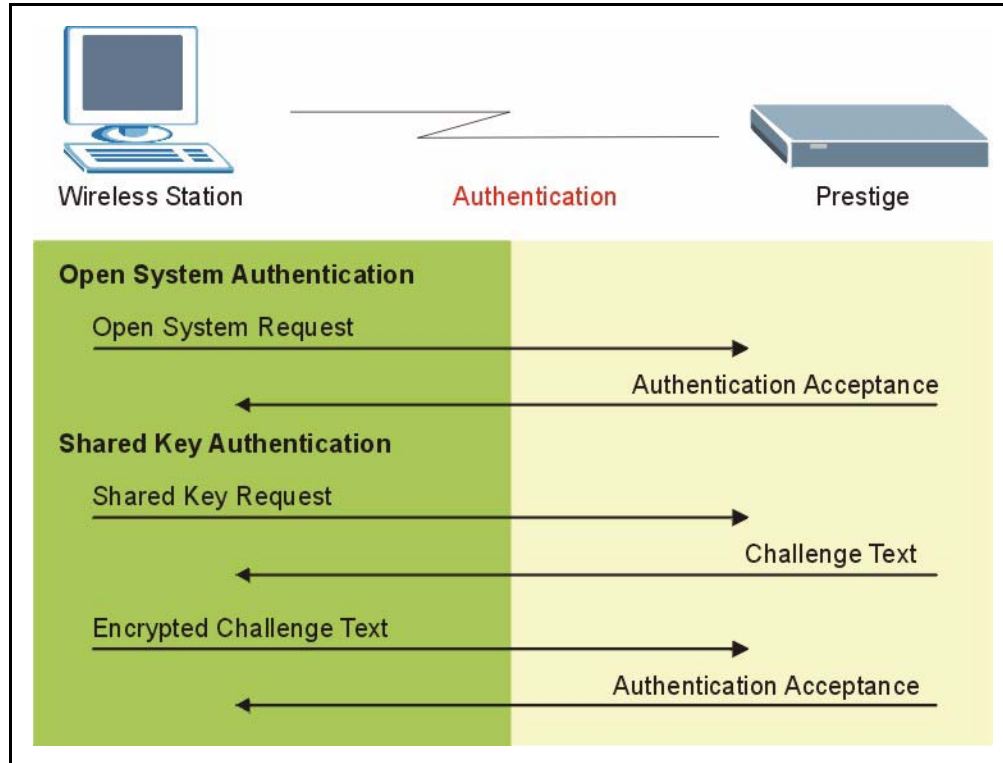

Open system authentication involves an unencrypted two-message procedure. A wireless station sends an open system authentication request to the AP, which will then automatically accept and connect the wireless station to the network. In effect, open system is not authentication at all as any station can gain access to the network.

Shared key authentication involves a four-message procedure. A wireless station sends a shared key authentication request to the AP, which will then reply with a challenge text message. The wireless station must then use the AP's default WEP key to encrypt the challenge text and return it to the AP, which attempts to decrypt the message using the AP's default WEP key. If the decrypted message matches the challenge text, the wireless station is authenticated.

When your P-330W's authentication method is set to open system, it will only accept open system authentication requests. The same is true for shared key authentication. However, when it is set to auto authentication, the P-330W will accept either type of authentication request and the P-330W will fall back to use open authentication if the shared key does not match.

## 5.4.2 Preamble Type

A preamble is used to synchronize the transmission timing in your wireless network. There are two preamble modes: **Long** and **Short**.

Short preamble takes less time to process and minimizes overhead, so it should be used in a good wireless network environment when all wireless clients support it.

Select **Long** if you have a 'noisy' network or are unsure of what preamble mode your wireless clients support as all IEEE 802.11b compliant wireless adapters must support long preamble. However, not all wireless adapters support short preamble. Use long preamble if you are unsure what preamble mode the wireless adapters support, to ensure interpretability between the P-330W and the wireless stations and to provide more reliable communication in 'noisy' networks..



**Note:** The P-330W and the wireless stations **MUST** use the same preamble mode in order to communicate.

**Figure 26** Wireless: Advanced Settings

### Wireless Advanced Settings

These settings are only for more technically advanced users who have a sufficient knowledge about wireless LAN. These settings should not be changed unless you know what effect the changes will have on your Access Point.

**Authentication Type:**  Open System  Shared Key  Auto

**Preamble Type:**  Long Preamble  Short Preamble

**Broadcast SSID:**  Enabled  Disabled

**IAPP:**  Enabled  Disabled

The following table describes the advanced wireless LAN labels in this screen.

**Table 18** Wireless: Advanced Settings

LABEL	DESCRIPTION
Authentication Type	Select Auto, Open System or Shared Key from the menu..
Preamble Type	Select a preamble type from the drop-down list menu. Choices are Long or Short. The default setting is Long.

**Table 18** Wireless: Advanced Settings

LABEL	DESCRIPTION
Broadcast SSID	Select this to hide the SSID in the outgoing beacon frame so a station cannot obtain the SSID through passive scanning using a site survey tool.
IAPP	Used in a multiple AP environment where 802.1x is used for authentication.
Save	Click <b>Save</b> to save your changes back to the P-330W.
Reset	Click <b>Reset</b> to reload the previous configuration for this screen.

## 5.5 Site Survey

Click **Site Survey** to scan the wireless network. If any Access Point or IBSS is found, you could choose to connect it when P330's wireless mode is set to Client mode.

**Figure 27** Wireless: Site Survey

### Wireless Site Survey

This page provides tool to scan the wireless network. If any Access Point or IBSS is found, you could choose to connect it manually when client mode is enabled.

SSID	BSSID	Channel	Type	Encrypt	Signal
TPO-330W	00:13:49:22:f9:da	11 (B+G)	AP	WPA-PSK	93
ZyXEL_MIS	00:13:49:26:c7:99	6 (B+G)	AP	WEP	72
ZYS	00:13:49:84:82:1a	11 (B+G)	AP	WEP	64
ZyXEL_YZU	00:0d:0b:ae:b2:57	10 (B+G)	AP	WPA-PSK	50
Wireless	00:00:aa:99:83:45	6 (B)	AP	no	30
ZyXEL	00:13:49:ae:fa:e6	6 (B+G)	AP	WPA-PSK	29
PQA-3286-P320W1	00:13:49:3d:4a:f7	4 (B+G)	AP	WPA-PSK	18

## 5.6 Wireless Security Overview

Wireless security is vital to your network to protect wireless communication between wireless stations, access points and the wired network.

The figure below shows the possible wireless security levels. EAP (Extensible Authentication Protocol) is used for authentication and utilizes dynamic WEP key exchange. It requires interaction with a RADIUS (Remote Authentication Dial-In User Service) server either on the WAN or your LAN to provide authentication service for wireless stations.

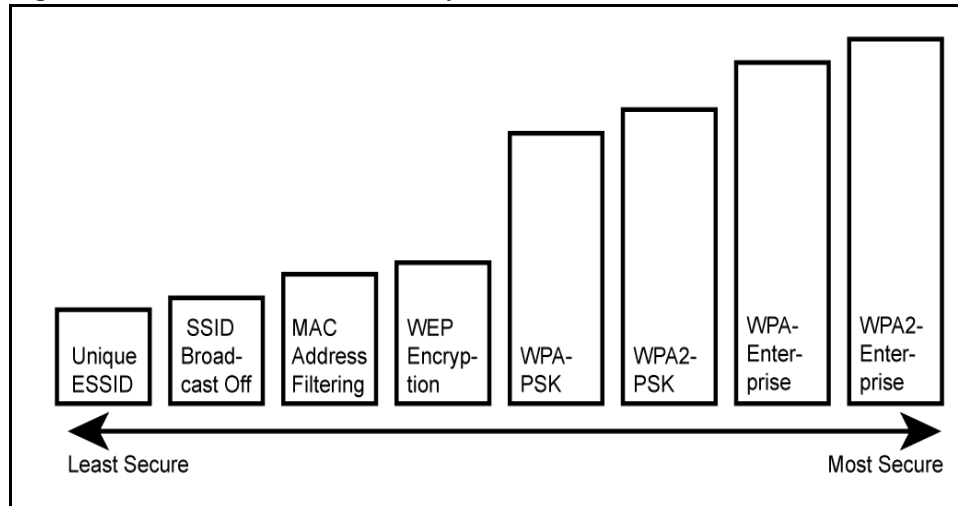
**Figure 28** P-330W Wireless Security Levels

If you do not enable any wireless security on your P-330W, your network is accessible to any wireless networking device that is within range.

Select **NONE** for **Encryption** to allow wireless stations to communicate with the access points without any data encryption.

**Figure 29** Wireless Security Setup: No Security

## Wireless Security Setup

This page allows you setup the wireless security. Turn on WEP or WPA by using Encryption Keys could prevent any unauthorized access to your wireless network.

**Encryption:** None Set WEP Key

*Note: When encryption WEP is selected, you must set WEP key value.*

Use 802.1x Authentication  
 WEP 64bits    WEP 128bits

**WPA Authentication Mode:**    Enterprise (RADIUS)    Personal (Pre-Shared Key)

**WPA(Pre-Shared Key) Format:** Passphrase

**WPA Pre-Shared Key(TKIP):** \*\*

**Group Key Life Time:** 86400 sec

Enable Pre-Authentication

**Authentication RADIUS Server:**   Port 1812   IP address    Password

Save   Reset

The following table describes the labels in this screen.

**Table 19** Wireless Security Setup: No Security

LABEL	DESCRIPTION
Encryption	Choose <b>None</b> from the drop-down list box.
Use 802.1x Authentication	Mark this check box to enable 802.1x security using an external RADIUS server. Data will not be encrypted, however wireless clients will be required to authenticate before they are allowed to pass traffic to the network. Both the client and the RADIUS server will need to support the same EAP protocols.
Save	Click <b>Save</b> to save your changes back to the P-330W.
Reset	Click <b>Reset</b> to reload the previous configuration for this screen.

## 5.7 Security Parameters Summary

Refer to this table to see what other security parameters you should configure for each Authentication Method/ key management protocol type. You enter manual keys by first selecting **64-bit WEP** or **128-bit WEP** from the **WEP Encryption** field and then typing the keys (in ASCII or hexadecimal format) in the key text boxes. MAC address filters are not dependent on how you configure these security features.

**Table 20** Wireless Security Relational Matrix

AUTHENTICATION METHOD/ KEY MANAGEMENT PROTOCOL	ENCRYPTION METHOD	ENTER MANUAL KEY	IEEE 802.1X
Open	None	No	Disabled
Open	WEP	No	Enable with 802.1x
		Yes	Disabled
Shared	WEP	No	Enable with 802.1x
		Yes	Disable
WPA	TKIP	No	Enable
WPA-PSK	TKIP	Yes	Disabled
WPA2	AES	No	Enable
WPA2-PSK	AES	Yes	Disabled
WPA2-Mixed	AES & TKIP	No	Enable
WPA2-Mixed PSK	AES & TKIP	Yes	Disabled

### 5.7.1 WEP Overview

WEP (Wired Equivalent Privacy) as specified in the IEEE 802.11 standard provides methods for both data encryption and wireless station authentication.

### 5.7.2 Data Encryption

WEP provides a mechanism for encrypting data using encryption keys. Both the AP and the wireless stations must use the same WEP key to encrypt and decrypt data. Your P-330W allows you to configure up to four 64-bit or 128-bit WEP keys, but only one key can be enabled at any one time.

### 5.7.3 Configuring WEP Encryption

In order to configure and enable WEP encryption; click the **SECURITY** link under **WIRELESS** to display the **Wireless Security** screen. Select **Static WEP** from the **Encryption** list.



**Figure 30** Wireless Security Setup: WEP Encryption

## Wireless Security Setup

This page allows you setup the wireless security. Turn on WEP or WPA by using Encryption Keys could prevent any unauthorized access to your wireless network.

**Encryption:** WEP Set WEP Key

*Note: When encryption WEP is selected, you must set WEP key value.*

Use 802.1x Authentication

WEP 64bits  WEP 128bits

**WPA Authentication Mode:**  Enterprise (RADIUS)  Personal (Pre-Shared Key)

**WPA(Pre-Shared Key) Format:** Passphrase

**WPA Pre-Shared Key(TKIP):** \*\*\*

**Group Key Life Time:** 86400 sec

Enable Pre-Authentication

**Authentication RADIUS Server:** Port 1812 IP address  Password

Save Reset

The following table describes the wireless LAN security labels in this screen

**Table 21** Wireless Security Setup: Static WEP Encryption

LABEL	DESCRIPTION
Encryption	Choose <b>WEP</b> from the drop-down list box.
Set WEP Key	Click this to configure WEP without 802.1x.
Use 802.1x Authentication	Mark the check box here to use 802.1x authentication.
WEP Encryption	Select <b>64-bit WEP</b> or <b>128-bit WEP</b> . Used only when using 802.1x authentication.
Authentication RADIUS Server	
Port	The port number on the RADIUS server.
IP Address	Enter the IP address of the RADIUS server.
Password	Enter the password (shared secret) for the RADIUS server.
Save	Click <b>Save</b> to save your changes back to the P-330W.
Reset	Click <b>Reset</b> to reload the previous configuration for this screen.

Click SET WEP KEY to configure WEP encryption.

**Figure 31** Wireless Security Setup: WEP Encryption

## Wireless WEP Key Setup

This page allows you setup the WEP key value. You could choose use 64-bit or 128-bit as the encryption key, or input Passphrase value(ASCII or Hex format) and press the button "Generate WEP key" generate WEP key automatically.

**Key Length:**

**Key Format:**

**Default Tx Key:**

**Encryption Key 1:**

**Encryption Key 2:**

**Encryption Key 3:**

**Encryption Key 4:**

**Passphrase**

The following table describes the wireless LAN security labels in this screen

**Table 22** Wireless Security Setup: WEP Encryption

LABEL	DESCRIPTION
Key Length	Select <b>64-bit WEP</b> or <b>128-bit WEP</b> .
Key Format	ASCII: Select this option in order to enter ASCII characters as WEP key. Hex: Select this option in order to enter hexadecimal characters as a WEP key.
Default Tx Key	You must configure at least one key, only one key can be activated at any one time. The default key is key 1.
Encryption Key 1 to 4	The WEP keys are used to encrypt data. Both the P-330W and the wireless stations must use the same WEP key for data transmission. If you chose <b>64-bit WEP</b> , then enter any 5 ASCII characters or 10 hexadecimal characters ("0-9", "A-F"). If you chose <b>128-bit WEP</b> , then enter 13 ASCII characters or 26 hexadecimal characters ("0-9", "A-F").
Passphrase	Enter a Passphrase (up to 32 printable characters) and clicking <b>Generate WEP KEY</b> . The P-330W automatically generates a WEP key.
Save	Click <b>Save</b> to save your changes back to the P-330W.
Close	Click <b>Close</b> to close this window.
Reset	Click <b>Reset</b> to reload the previous configuration for this screen.

## 5.7.4 Introduction to WPA

Wi-Fi Protected Access (WPA) is a subset of the IEEE 802.11i security specification draft. Key differences between WPA and WEP are user authentication and improved data encryption.

### 5.7.4.1 User Authentication

WPA applies IEEE 802.1x and Extensible Authentication Protocol (EAP) to authenticate wireless clients using an external RADIUS database. See later in this chapter and the appendices for more information on IEEE 802.1x, RADIUS and EAP. Your wireless client will need to be able to support 802.1x authentication to use RADIUS authentication.

Therefore, if you don't have an external RADIUS server you should use WPA-PSK (WPA - Pre-Shared Key) that only requires a single (identical) password entered into each access point, wireless gateway and wireless client. As long as the passwords match, a client will be granted access to a WLAN.

### 5.7.4.2 Encryption

WPA improves data encryption by using Temporal Key Integrity Protocol (TKIP), Message Integrity Check (MIC) and IEEE 802.1x.

Temporal Key Integrity Protocol (TKIP) uses 128-bit keys that are dynamically generated and distributed by the authentication server. It includes a per-packet key mixing function, a Message Integrity Check (MIC) named Michael, an extended initialization vector (IV) with sequencing rules, and a re-keying mechanism.

TKIP regularly changes and rotates the encryption keys so that the same encryption key is never used twice. The RADIUS server distributes a Pairwise Master Key (PMK) key to the AP that then sets up a key hierarchy and management system, using the pair-wise key to dynamically generate unique data encryption keys to encrypt every data packet that is wirelessly communicated between the AP and the wireless clients. This all happens in the background automatically.

The Message Integrity Check (MIC) is designed to prevent an attacker from capturing data packets, altering them and resending them. The MIC provides a strong mathematical function in which the receiver and the transmitter each compute and then compare the MIC. If they do not match, it is assumed that the data has been tampered with and the packet is dropped.

By generating unique data encryption keys for every data packet and by creating an integrity checking mechanism (MIC), TKIP makes it much more difficult to decode data on a Wi-Fi network than WEP, making it difficult for an intruder to break into the network.

The encryption mechanisms used for WPA and WPA-PSK are the same. The only difference between the two is that WPA-PSK uses a simple common password, instead of user-specific credentials. The common-password approach makes WPA-PSK susceptible to brute-force password-guessing attacks but it's still an improvement over WEP as it employs an easier-to-use, consistent, single, alphanumeric password.

### 5.7.4.3 WPA-PSK Application Example

A WPA-PSK application looks as follows.

- 1 First enter identical passwords into the AP and all wireless clients. The Pre-Shared Key (PSK) must consist of between 8 and 63 ASCII characters (including spaces and symbols).
- 2 The AP checks each client's password and (only) allows it to join the network if it matches its password.
- 3 The AP derives and distributes keys to the wireless clients.
- 4 The AP and wireless clients use the TKIP encryption process to encrypt data exchanged between them.

**Figure 32** WPA - PSK Authentication

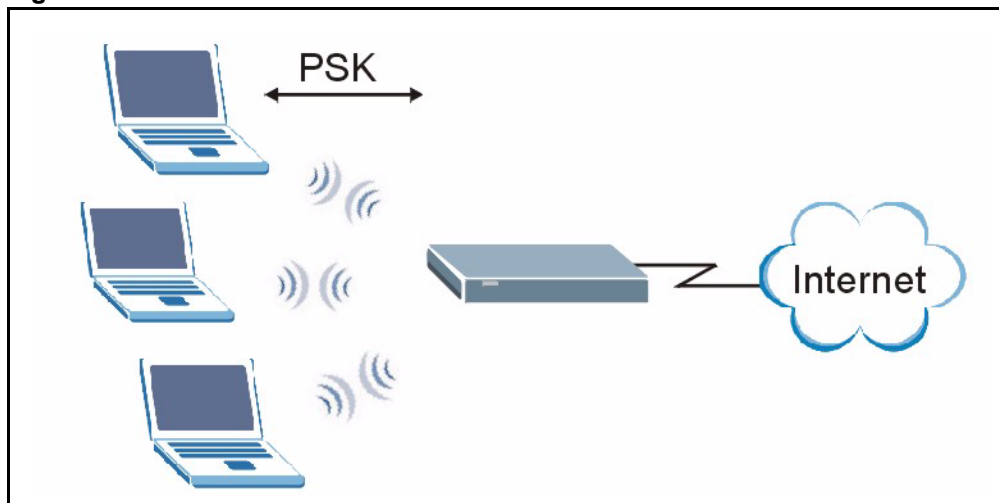

### 5.7.5 Introduction to WPA2

WPA2 is based on the same 802.11i spec as WPA. The primary difference between WPA and WPA2 is that WPA2 uses AES encryption in places of TKIP. Like WPA, WPA2 can function either using a pre-shared key or by using a RADIUS server to perform authentication. WPA2 also offers a mixed mode which allows WPA clients to authenticate and use TKIP encryption while still allowing WPA2 clients to use AES. Configuration of WPA2 is the same as WPA.

### 5.7.6 Configuring WPA-PSK Authentication

In order to configure and enable WPA-PSK encryption; click the **SECURITY** link under **WIRELESS** to display the **Wireless Security** screen. Select **WPA (TKIP)** from the **Encryption** list. Select **PERSONAL** under **WPA Encryption Mode**.

**Figure 33** Wireless Security Setup: WPA-PSK

## Wireless Security Setup

This page allows you to setup the wireless security. Turn on WEP or WPA by using Encryption Keys could prevent any unauthorized access to your wireless network.

**Encryption:** WPA Set WEP Key

*Note: When encryption WEP is selected, you must set WEP key value.*

Use 802.1x Authentication

WEP 64bits  WEP 128bits

**WPA Authentication Mode:**  Enterprise (RADIUS)  Personal (Pre-Shared Key)

**WPA Cipher Suite:**  TKIP  AES

**WPA(Pre-Shared Key) Format:** Passphrase

**WPA Pre-Shared Key:** \*\*\*\*\*

**Group Key Life Time:** 86400 sec

Enable Pre-Authentication

**Authentication RADIUS Server:** Port 1812 IP address  Password

Save Reset

The following table describes the labels in this screen.

**Table 23** Wireless Security Setup: WPA-PSK

LABEL	DESCRIPTION
Encryption	Choose <b>WPA</b> from the drop-down list box for TKIP encryption. Choose <b>WPA2 (AES)</b> from the drop-down list box to use WPA2's AES encryption. Choose <b>WPA2 Mixed</b> from the drop-down list box to allow both TKIP or AES encryption.
WPA Authentication Mode	Choose <b>Personal</b> to enable PSK mode.
WPA Format	Choose whether to enter the PSK by either <b>Passphrase</b> or <b>Hex</b> key.
Pre-Shared Key	The encryption mechanisms used for <b>WPA</b> and <b>WPA-PSK</b> are the same. The only difference between the two is that <b>WPA-PSK</b> uses a simple common password, instead of user-specific credentials. Type a pre-shared key from 8 to 63 case-sensitive ASCII characters (including spaces and symbols) or 64 hex characters.
Group Key Life Time	The <b>Group Key Life Time</b> is the rate at which the AP sends a new group key out to all clients. The re-keying process is the WPA equivalent of automatically changing the WEP key for an AP and all stations in a WLAN on a periodic basis.
Save	Click <b>Save</b> to save your changes back to the P-330W.
Reset	Click <b>Reset</b> to reload the previous configuration for this screen.

## 5.7.7 Introduction to RADIUS

RADIUS is based on a client-server model that supports authentication and accounting, where access point is the client and the server is the RADIUS server. The RADIUS server handles the following tasks among others:

- Authentication  
Determines the identity of the users.
- Accounting  
Keeps track of the client's network activity.

RADIUS user is a simple package exchange in which your P-330W acts as a message relay between the wireless station and the network RADIUS server.

### 5.7.7.1 Types of RADIUS Messages

The following types of RADIUS messages are exchanged between the access point and the RADIUS server for user authentication:

- Access-Request  
Sent by an access point requesting authentication.
- Access-Reject  
Sent by a RADIUS server rejecting access.
- Access-Accept  
Sent by a RADIUS server allowing access.

### 5.7.7.2 Access-Challenge

Sent by a RADIUS server requesting more information in order to allow access. The access point sends a proper response from the user and then sends another Access-Request message.

The following types of RADIUS messages are exchanged between the access point and the RADIUS server for user accounting:

### 5.7.7.3 Accounting-Request

Sent by the access point requesting accounting.

### 5.7.7.4 Accounting-Response

Sent by the RADIUS server to indicate that it has started or stopped accounting.

In order to ensure network security, the access point and the RADIUS server use a shared secret key, which is a password, they both know. The key is not sent over the network. In addition to the shared key, password information exchanged is also encrypted to protect the wired network from unauthorized access.

### 5.7.7.5 EAP Authentication Overview

EAP (Extensible Authentication Protocol) is an authentication protocol that runs on top of the IEEE802.1x transport mechanism in order to support multiple types of user authentication. By using EAP to interact with an EAP-compatible RADIUS server, the access point helps a wireless station and a RADIUS server perform authentication.

The type of authentication you use depends on the RADIUS server or the AP. The P-330W supports EAP-TLS, EAP-TTLS and PEAP with RADIUS. Refer to the *Types of EAP Authentication* appendix for descriptions on the four common types.

Your P-330W supports EAP-MD5 (Message-Digest Algorithm 5) with RADIUS.

The following figure shows an overview of authentication when you specify a RADIUS server on your access point.

**Figure 34** EAP Authentication

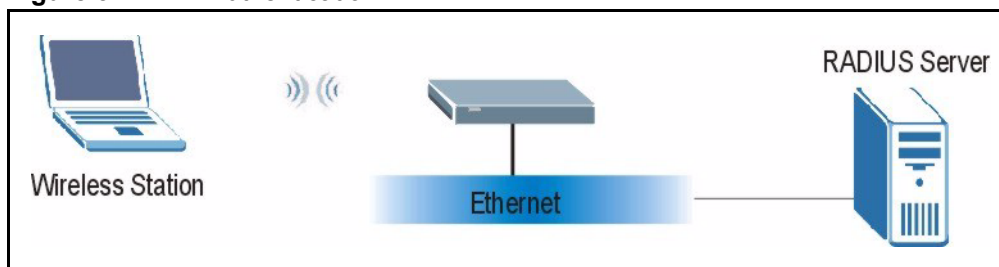

The details below provide a general description of how IEEE 802.1x EAP authentication works. For an example list of EAP-MD5 authentication steps, see the IEEE 802.1x appendix.

- 1 The wireless station sends a “start” message to the P-330W.
- 2 The P-330W sends a “request identity” message to the wireless station for identity information.
- 3 The wireless station replies with identity information, including username and password.
- 4 The RADIUS server checks the user information against its user profile database and determines whether or not to authenticate the wireless station.

### 5.7.7.6 WPA with RADIUS Application Example

You need the IP address of the RADIUS server, its port number (default is 1812), and the RADIUS shared secret. A WPA application example with an external RADIUS server looks as follows. “A” is the RADIUS server. “DS” is the distribution system.

- 1 The AP passes the wireless client’s authentication request to the RADIUS server.

- 2 The RADIUS server then checks the user's identification against its database and grants or denies network access accordingly.
- 3 The RADIUS server distributes a Pairwise Master Key (PMK) key to the AP that then sets up a key hierarchy and management system, using the pair-wise key to dynamically generate unique data encryption keys to encrypt every data packet that is wirelessly communicated between the AP and the wireless clients.

**Figure 35** WPA with RADIUS Application Example

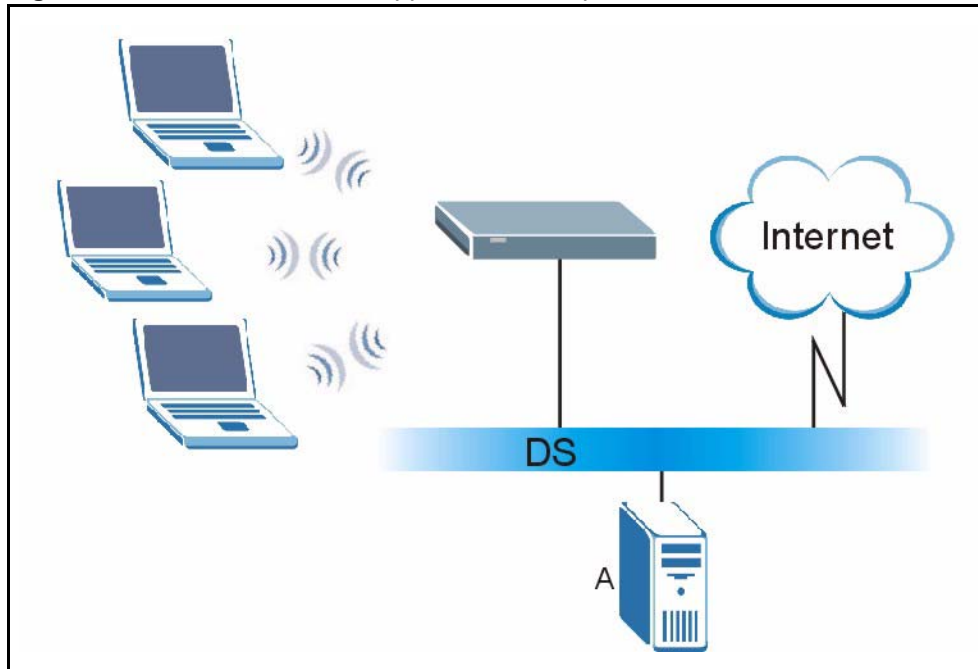

### 5.7.8 Configuring WPA Authentication

In order to configure and enable WPA encryption; click the **SECURITY** link under **WIRELESS** to display the **Wireless Security** screen. Select the mode (**WPA**, **WPA2**, **WPA2 Mixed**) from the **Encryption** list. Select **ENTERPRISE** under **WPA Encryption Mode**.



**Figure 36** Wireless Security Setup: WPA With RADIUS

## Wireless Security Setup

This page allows you to setup the wireless security. Turn on WEP or WPA by using Encryption Keys could prevent any unauthorized access to your wireless network.

**Encryption:** WPA Set WEP Key

*Note: When encryption WEP is selected, you must set WEP key value.*

Use 802.1x Authentication

WEP 64bits     WEP 128bits

**WPA Authentication Mode:**  Enterprise (RADIUS)     Personal (Pre-Shared Key)

**WPA Cipher Suite:**  TKIP     AES

**WPA(Pre-Shared Key) Format:** Passphrase

**WPA Pre-Shared Key:** \*\*\*\*\*

**Group Key Life Time:** 86400 sec

Enable Pre-Authentication

**Authentication RADIUS Server:** Port 1812 IP address  Password

Save Reset

The following table describes the labels in this screen.

**Table 24** Wireless Security Setup: WPA

LABEL	DESCRIPTION
Encryption	Choose <b>WPA</b> from the drop-down list box for TKIP encryption. Choose <b>WPA2 (AES)</b> from the drop-down list box to use WPA2's AES encryption. Choose <b>WPA2 Mixed</b> from the drop-down list box to allow both TKIP or AES encryption.
WPA Group Key Update Timer	The <b>WPA Group Key Update Timer</b> is the rate at which the AP (if using <b>WPA-PSK</b> key management) or <b>RADIUS</b> server (if using WPA key management) sends a new group key out to all clients. The re-keying process is the WPA equivalent of automatically changing the WEP key for an AP and all stations in a WLAN on a periodic basis. Setting of the <b>WPA Group Key Update Timer</b> is also supported in <b>WPA-PSK</b> mode. The P-330W default is <b>1800</b> seconds (30 minutes).
Authentication Server	
IP Address	Enter the IP address of the external authentication server in dotted decimal notation.
Port	Enter the port number of the external authentication server. The default port number is <b>1812</b> . You need not change this value unless your network administrator instructs you to do so with additional information.

**Table 24** Wireless Security Setup: WPA

LABEL	DESCRIPTION
Password	Enter a password (up to 31 alphanumeric characters) as the key to be shared between the external authentication server and the P-330W. The key must be the same on the external authentication server and your P-330W. The key is not sent over the network.
Save	Click <b>Save</b> to save your changes back to the P-330W.
Reset	Click <b>Reset</b> to reload the previous configuration for this screen.

## 5.8 WDS Settings

The WDS (Wireless Distribution System) allows you to configure the P-330W to connect two or more APs via wireless when P330's wireless mode is set to WDS or AP+WDS mode. An AP using WDS can function as a wireless network bridge allowing you to wirelessly connect two wired network segments.

**Figure 37** Wireless: WDS Settings

The following table describes the labels in this screen.

**Table 25** Wireless: WDS Settings

LABEL	DESCRIPTION
Enable WDS	Select this check box to enable the WDS.
MAC Address	Enter the MAC addresses of the neighboring AP(s) that participates in the WDS. Enter the MAC addresses in a valid MAC address format, that is, six hexadecimal character pairs, for example, 001349556677.
Comment	Enter in a descriptive name so you know which device the MAC address is associated with.

**Table 25** Wireless: WDS Settings

LABEL	DESCRIPTION
Set Security	Click <b>Set Security</b> to set up the wireless security for WDS. When enabled, please make sure each WDS device has adopted the same encryption algorithm and key.
Show Statistics	Click <b>Show Statistics</b> to show the WDS connection status.
Save	Click <b>Save</b> to save your changes back to the P-330W.
Reset	Click <b>Reset</b> to reload the previous configuration for this screen.
Current WDS AP List	
Delete Selected	Click this button to delete selected WDS AP from the WDS AP list.
Delete All	Click this button to delete all WDS AP from the WDS AP list.

## 5.9 Wireless Trusted Stations

The Trusted Stations screen allows you to configure the P-330W to give exclusive access to up to 20 devices. Every Ethernet device has a unique MAC (Media Access Control) address. The MAC address is assigned at the factory and consists of six pairs of hexadecimal characters, for example, 00:A0:C5:00:00:02. You need to know the MAC address of the devices to configure this screen.

To change your P-330W's Trusted Stations settings, click the **WIRELESS** link, then the **Trusted Stations** link. The screen appears as shown.

**Figure 38** Wireless: Trusted Stations MAC Address Filter

## Wireless Trusted Stations

If you choose 'Allow Listed', only those clients whose wireless MAC addresses are in the access control list will be able to connect to your Access Point.

Wireless Access Control Mode:

MAC Address:

Description:

Current Access Control List:

	MAC Address	Description	Select
<input type="button" value="Delete Selected"/> <input type="button" value="Delete All"/> <input type="button" value="Reset"/>			

The following table describes the labels in this menu.

**Table 26** Wireless: Trusted Stations MAC Address Filter

LABEL	DESCRIPTION
Wireless Access Control Mode	Select <b>Allow Listed</b> from the drop down list box to enable MAC address filtering.
MAC Address	Enter the MAC addresses of the wireless station that are allowed or denied access to the P-330W in these address fields. Enter the MAC addresses in a valid MAC address format, that is, six hexadecimal character pairs, for example, 123456789abc.
Description	Enter in a descriptive name so you know which device the MAC address is associated with.
Save	Click <b>Save</b> to save your changes back to the P-330W.
Reset	Click <b>Reset</b> to reload the previous configuration for this screen.
Current Access Control List	
Delete Selected	Click this button to delete selected clients from the trusted station list.
Delete All	Click this button to delete all clients from the trusted station list.



# CHAPTER 6

## Advanced Options

This chapter covers the options available under the **ADVANCED** section of the menu.

**Figure 39** The Advanced Menu Options



### 6.1 Access Control

This screen allows you to block access to specified Internet services based on port number used. This can be used restrict Internet access to only certain applications or to block applications you feel may be harmful.

To change your P-330W's Access Controls, click **ADVANCED**, then the **Access Control** link. The screen appears as shown.

**Figure 40** Advanced: Access Control

## Access Control

Entries in this table are used to restrict certain types of data packets from your local network to Internet through the Router. Here you can restrict local LAN clients to access Internet application/services which use certain port to work. Use of such filters can be helpful in securing or restricting your local network.

Enable Access Control

Select Services to Block:

Port Range:  -

Protocol:

Description:

**Current Blocked Table:**

Port Range	Protocol	Description	Select
<input type="button" value="Delete Selected"/> <input type="button" value="Delete All"/> <input type="button" value="Reset"/>			

The following table describes the labels in this screen.

**Table 27** Advanced: Access Control

LABEL	DESCRIPTION
Enable Access Control	Check this box to enable Access Controls.
Select Services to Block	The P-330W comes preconfigured with settings for many common services. You can choose one to activate from the pull down menu.
Port Range	Enter in a range of ports to block.
Protocol	Choose to block either TCP, UDP, or Both.
Description	Give the rule you have created an easy to identify name.
Save	Click <b>Save</b> to save your changes back to the P-330W.
Reset	Click <b>Reset</b> to begin configuring this screen afresh.

## 6.2 Dynamic DNS

Dynamic DNS allows you to update your current dynamic IP address with one or many dynamic DNS services so that anyone can contact you (in NetMeeting, CU-SeeMe, etc.). You can also access your FTP server or Web site on your own computer using a domain name (for instance myhost.dns.org, where myhost is a name of your choice) that will never change instead of using an IP address that changes each time you reconnect. Your friends or relatives will always be able to call you even if they don't know your IP address.

First of all, you need to have registered a dynamic DNS account with either [www.dyndns.org](http://www.dyndns.org) or [www.tzo.com](http://www.tzo.com). This is for people with a dynamic IP from their ISP or DHCP server that would still like to have a domain name. The Dynamic DNS service provider will give you a password or key.



**Note:** If you have a private WAN IP address, then you cannot use Dynamic DNS.

## 6.3 Configuring Dynamic DNS

To change your P-330W's DDNS, click **ADVANCED** then the **Dynamic DNS** link. The screen appears as shown.

**Figure 41** Advanced: Dynamic DNS

### Dynamic DNS Setting

Dynamic DNS is a service that provides you with a valid, unchanging, internet domain name (an URL) to go with that (possibly everchanging) IP-address.

Enable DDNS

**Service Provider:** DynDNS ▾

**Domain Name:**

**User Name/Email:**

**Password/Key:**

**Result:**

*Note:*  
 For TZO, you can have a 30 days free trial [here](#) or manage your TZO account in [control panel](#).  
 For DynDNS, you can create your DynDNS account [here](#).

The following table describes the labels in this screen.

**Table 28** Advanced: Dynamic DNS

LABEL	DESCRIPTION
Enable DDNS	Select this check box to use dynamic DNS.
Service Provider	Select the name of your Dynamic DNS service provider.
Domain Name	Enter the host names in the field provided.
User Name	Enter your user name.
Password	Enter the password assigned to you.
Result	Tells you the current result from trying to register your IP address with the DDNS provider.



**Table 28** Advanced: Dynamic DNS

LABEL	DESCRIPTION
Save	Click <b>Save</b> to save your changes back to the P-330W.
Reset	Click <b>Reset</b> to begin configuring this screen afresh.

## 6.4 DMZ

If the DMZ Host Function is enabled, it means that you set up DMZ host at a particular computer to be exposed to the Internet so that some applications/software, especially Internet / online game can have two-way connections. A device acting as DMZ is not protected by the P-330W's firewall.

To enable DMZ, click **ADVANCED** then the **DMZ** link. The screen appears as shown.

**Figure 42** Advanced: DMZ

The following table describes the labels in this screen.

**Table 29** Advanced: DMZ

LABEL	DESCRIPTION
Enable DMZ	Select this check box to enable DMZ.
Host IP Address	Enter the IP address of the device you which to be accessible from the Internet.
Save	Click <b>Save</b> to save your changes back to the P-330W.
Reset	Click <b>Reset</b> to begin configuring this screen afresh.

## 6.5 Virtual Servers (Port Forwarding)

The Virtual Server function is a list of inside (behind NAT on the LAN) servers, for example, web or FTP, that you can make visible to the outside world even though NAT makes your whole inside network appear as a single computer to the outside world.

You may enter a single port number or a range of port numbers to be forwarded, and the local IP address of the desired server. The port number identifies a service; for example, web service is on port 80 and FTP on port 21. In some cases, such as for unknown services or where one server can support more than one service (for example both FTP and web service), it might be better to specify a range of port numbers. You can allocate a server IP address that corresponds to a port or a range of ports.

Many residential broadband ISP accounts do not allow you to run any server processes (such as a Web or FTP server) from your location. Your ISP may periodically check for servers and may suspend your account if it discovers any active services at your location. If you are unsure, refer to your ISP.

The most often used port numbers are shown in the following table. Please refer to RFC 1700 for further information about port numbers. .

**Table 30** Services and Port Numbers

SERVICES	PORT NUMBER
ECHO	7
FTP (File Transfer Protocol)	21
SMTP (Simple Mail Transfer Protocol)	25
DNS (Domain Name System)	53
Finger	79
HTTP (Hyper Text Transfer protocol or WWW, Web)	80
POP3 (Post Office Protocol)	110
NNTP (Network News Transport Protocol)	119
SNMP (Simple Network Management Protocol)	161
SNMP trap	162
PPTP (Point-to-Point Tunneling Protocol)	1723

### 6.5.0.1 Configuring Servers Behind SUA (Example)

Let's say you want to assign ports 21-25 to one FTP, Telnet and SMTP server (A in the example), port 80 to another (B in the example) and assign a default server IP address of 192.168.10.35 to a third (C in the example). You assign the LAN IP addresses and the ISP assigns the WAN IP address. The NAT network appears as a single host on the Internet

**Figure 43** Multiple Servers Behind NAT Example

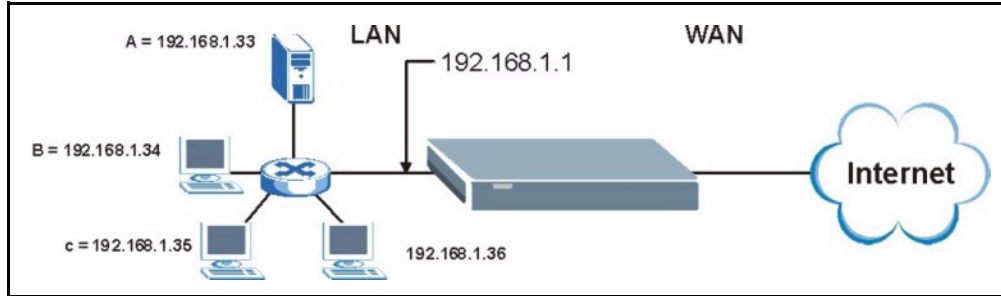

## 6.5.1 Configuring Virtual Servers

To configure Virtual Server, click **ADVANCED** then the **VIRTUAL SERVERS** link. The screen appears as shown.

**Figure 44** Advanced: Virtual Servers

### Virtual Servers

Entries in this table allow you to automatically redirect common network services to a specific machine behind the NAT firewall. These settings are only necessary if you wish to host some sort of server like a web server or mail server on the private local network behind your Gateway's NAT firewall.

Enable Virtual Servers

Servers: Web

Local IP Address:

Protocol: Both

Port Range:  -

Description:

Current Virtual Servers Table:

Local IP Address	Protocol	Port Range	Description	Select

The following table describes the labels in this screen.

**Table 31** Advanced: Virtual Servers

LABEL	DESCRIPTION
Enable Virtual Servers	Put a check in the box to enable Virtual Servers
Servers	By selection an option in the pull down menu, the P-330W will automatically populate the settings for the corresponding service.

**Table 31** Advanced: Virtual Servers

LABEL	DESCRIPTION
Local IP Address	Enter the inside IP address of the server here.
Protocol	You can select to forward TCP, UDP, or both type of traffic.
Name	Enter a name to identify this port-forwarding rule.
Port Range	Enter a port number here. To forward only one port, enter it again in the <b>End Port</b> field. To specify a range of ports, enter the last port to be forwarded in the <b>End Port</b> field.
Description	Enter in a description for this Virtual Server.
Save	Click <b>Save</b> to save your changes back to the P-330W.
Reset	Click <b>Reset</b> to begin configuring this screen afresh.

## 6.6 Special Applications

Some Internet applications (such as video conferencing and Internet games) require multiple connections between the clients and the server. These applications do not work through NAT-enabled networks. Your P-330W is a NAT-enabled device. In order to allow these applications to work in your network, you have to configure the P-330W to forward these applications to ports on a computer hosting that service.

To set the P-330W to forward applications to allowed ports, click **ADVANCED** and the **Special Applications** link. The screen appears as shown.

**Figure 45** Advanced: Special Applications

### Special Applications

Some applications require multiple connections, such as Internet gaming, video conferencing, Internet telephony and others. These applications cannot work when Network Address Translation (NAT) is enabled. If you need to run applications that require multiple connections, specify the port normally associated with an application in the "Trigger Port" field, select the protocol type as TCP or UDP, then enter the public ports associated with the trigger port to open them for inbound traffic.

Name	Incoming Type	Incoming Start Port	Incoming Finish Port	Trigger Type	Trigger Start Port	Trigger Finish Port	Enable
Quick Time 4	BOTH	6970	6999	BOTH	554	554	<input type="checkbox"/>
Dialpad	BOTH	51200	51201	BOTH	7175	7175	<input type="checkbox"/>
Paltalk	BOTH	2090	2091	BOTH	8200	8700	<input type="checkbox"/>
Battle.net	UDP	6112	6119	TCP	6112	6112	<input type="checkbox"/>
	TCP	0	0	TCP	0	0	<input type="checkbox"/>
	TCP	0	0	TCP	0	0	<input type="checkbox"/>
	TCP	0	0	TCP	0	0	<input type="checkbox"/>
	TCP	0	0	TCP	0	0	<input type="checkbox"/>

The following table describes the labels in this screen.

**Table 32** Advanced: Special Applications

LABEL	DESCRIPTION
Enable	Put a check in this box next to the ALG rule you want to activate.
Save	Click <b>Save</b> to save your changes back to the P-330W.
Reset	Click <b>Reset</b> to begin configuring this screen afresh.

## 6.7 WAN Port

To change your P-330W's WAN ISP settings, click **ADVANCED**, then the **WAN** link. The screen differs by the encapsulation.

### 6.7.1 Static IP Encapsulation

The screen shown next is for **Static IP** encapsulation.

**Figure 46** Advanced: WAN Static IP Encapsulation

### WAN Port Configuration

This page is used to configure the parameters for Internet network which connects to the WAN port of your router. Here you may change the access method to static IP, DHCP, PPPoE or PPTP by click the item value of WAN Access type.

**WAN Access Type:**

**IP Address:**

**Subnet Mask:**

**Default Gateway:**

**DNS 1:**

**DNS 2:**

**DNS 3:**

**Clone MAC Address:**

Respond to WAN Ping

Enable UPnP

Enable IPsec pass through on VPN connection

Enable PPTP pass through on VPN connection

Enable L2TP pass through on VPN connection

The following table describes the labels in this screen.

**Table 33** Advanced: WAN Static IP Encapsulation

LABEL	DESCRIPTION
WAN Access Type	You must choose the Static IP option when the WAN port is used as a regular Ethernet with a fixed IP address.
IP Address	Enter your WAN IP address in this field.
My WAN IP Subnet Mask	Type your network's IP subnet Mask.
DNS 1 - 3	Enter in your ISP's DNS server IP address here. You must enter in 1.
Clone MAC Address	Your ISP may require a particular MAC address in order for you to connect to the Internet. This MAC address is the PC's MAC address that your ISP had originally connected your Internet connection to. Type in this Clone MAC address in this section to replace the WAN MAC address with the MAC address of that PC.
Respond to WAN Ping	Put a check in this box to reply to ping packets.
Enable UPnP	UPnP (Universal Plug and Play) allows automatic discovery and configuration of the Wireless Router. UPnP is by supported by Windows ME, XP, or later. Put a check in this box to allow the router configuration to be changed by UPnP devices.
IPSec Passthrough	Put a check in this box to enable computers on your LAN to make IPSec VPN connections to servers on the Internet.
PPTP Passthrough	Put a check in this box to enable computers on your LAN to make PPTP VPN connections to servers on the Internet.
L2TP Passthrough	Put a check in this box to enable computers on your LAN to make L2TP VPN connections to servers on the Internet.

**Table 33** Advanced: WAN Static IP Encapsulation

LABEL	DESCRIPTION
Save	Click <b>Save</b> to save your changes back to the P-330W.
Reset	Click <b>Reset</b> to begin configuring this screen afresh.

## 6.7.2 DHCP IP Encapsulation

The screen shown next is for **DHCP IP** encapsulation.

**Figure 47** Advanced: WAN DHCP IP Encapsulation

The following table describes the labels in this screen.

**Table 34** Advanced: WAN DHCP IP Encapsulation

LABEL	DESCRIPTION
WAN Access Type	You must choose the DHCP Client option when the WAN port is used as a regular Ethernet using DHCP to be assigned an IP address.
Attain DNS Automatically	Select this if your ISP assigns you a DNS server at the same time it assigns you an IP Address.
Set DNS Manually	Use this if your ISP does not assign a DNSP server when it assigns you an IP address.
DNS 1 - 3	Enter in your ISP's DNS server IP address here. You must enter in 1.
Clone MAC Address	Your ISP may require a particular MAC address in order for you to connect to the Internet. This MAC address is the PC's MAC address that your ISP had originally connected your Internet connection to. Type in this Clone MAC address in this section to replace the WAN MAC address with the MAC address of that PC.
Respond to WAN Ping	Put a check in this box to reply to ping packets.

**Table 34** Advanced: WAN DHCP IP Encapsulation

LABEL	DESCRIPTION
Enable UPnP	UPnP (Universal Plug and Play) allows automatic discovery and configuration of the Wireless Router. UPnP is by supported by Windows ME, XP, or later. Put a check in this box to allow the router configuration to be changed by UPnP devices.
IPSec Passthrough	Put a check in this box to enable computers on your LAN to make IPSec VPN connections to servers on the Internet.
PPTP Passthrough	Put a check in this box to enable computers on your LAN to make PPTP VPN connections to servers on the Internet.
L2TP Passthrough	Put a check in this box to enable computers on your LAN to make L2TP VPN connections to servers on the Internet.
Save	Click <b>Save</b> to save your changes back to the P-330W.
Reset	Click <b>Reset</b> to begin configuring this screen afresh.

### 6.7.3 PPPoE Encapsulation

The P-330W supports PPPoE (Point-to-Point Protocol over Ethernet). PPPoE is an IETF Draft standard (RFC 2516) specifying how a personal computer (PC) interacts with a broadband modem (DSL, cable, wireless, etc.) connection. The **PPP over Ethernet** option is for a dial-up connection using PPPoE.

For the service provider, PPPoE offers an access and authentication method that works with existing access control systems (for example Radius). PPPoE provides a login and authentication method that the existing Microsoft Dial-Up Networking software can activate, and therefore requires no new learning or procedures for Windows users.

One of the benefits of PPPoE is the ability to let you access one of multiple network services, a function known as dynamic service selection. This enables the service provider to easily create and offer new IP services for individuals.

Operationally, PPPoE saves significant effort for both you and the ISP or carrier, as it requires no specific configuration of the broadband modem at the customer site.

By implementing PPPoE directly on the P-330W (rather than individual computers), the computers on the LAN do not need PPPoE software installed, since the P-330W does that part of the task. Furthermore, with NAT, all of the LANs' computers will have access.

The screen shown next is for **PPPoE** encapsulation.



**Figure 48** Advanced: WAN PPPoE Encapsulation

### WAN Port Configuration

This page is used to configure the parameters for Internet network which connects to the WAN port of your router. Here you may change the access method to static IP, DHCP, PPPoE or PPTP by click the item value of WAN Access type.

**WAN Access Type:** PPPoE ▼

**User Name:**

**Password:**

**Service Name:**  (optional)

**Connection Type:** Continuous ▼

Connect Disconnect

**Idle Time:**  (1-1000 minutes)

**MTU Size:**  (1400-1492 bytes)

Attain DNS Automatically

Set DNS Manually

**DNS 1:**

**DNS 2:**

**DNS 3:**

**Clone MAC Address:**

Respond to WAN Ping

Enable UPnP

Enable IPsec pass through on VPN connection

Enable PPTP pass through on VPN connection

Enable L2TP pass through on VPN connection

Save Reset

The following table describes the labels in this screen.

**Table 35** PPPoE Encapsulation

LABEL	DESCRIPTION
WAN Access Type	You must choose the PPPoE option when the WAN port is used with PPPoE.
User Name	Type the User Name given to you by your ISP.
Password	Type the password associated with the User Name above.
Service Name	Type the PPPoE service name provided to you. PPPoE uses a service name to identify and reach the PPPOE server.
Connection Type	Select <b>Continuous</b> if you do not want the connection to time out. Select <b>Connect On Demand</b> if you want to only connect when you are sending data. Select <b>Manual</b> if you do not want manually log the P-330W in via the GUI.
Idle Time	The amount of time before the PPPoE session times out and drops connection.
MTU Size	Enter in the maximum MTU (packet size) here.
Attain DNS Automatically	Select this if your ISP assigns you a DNS server at the same time it assigns you an IP Address.

**Table 35** PPPoE Encapsulation

LABEL	DESCRIPTION
Set DNS Manually	Use this if your ISP does not assign a DNS server when it assigns you an IP address.
DNS 1 - 3	Enter in your ISP's DNS server IP address here. You must enter in 1.
Clone MAC Address	Your ISP may require a particular MAC address in order for you to connect to the Internet. This MAC address is the PC's MAC address that your ISP had originally connected your Internet connection to. Type in this Clone MAC address in this section to replace the WAN MAC address with the MAC address of that PC.
Respond to WAN Ping	Put a check in this box to reply to ping packets.
Enable UPnP	UPnP (Universal Plug and Play) allows automatic discovery and configuration of the Wireless Router. UPnP is supported by Windows ME, XP, or later. Put a check in this box to allow the router configuration to be changed by UPnP devices.
IPSec Passthrough	Put a check in this box to enable computers on your LAN to make IPSec VPN connections to servers on the Internet.
PPTP Passthrough	Put a check in this box to enable computers on your LAN to make PPTP VPN connections to servers on the Internet.
L2TP Passthrough	Put a check in this box to enable computers on your LAN to make L2TP VPN connections to servers on the Internet.
Save	Click <b>Save</b> to save your changes back to the P-330W.
Reset	Click <b>Reset</b> to begin configuring this screen afresh.

## 6.7.4 PPTP Encapsulation

Point-to-Point Tunneling Protocol (PPTP) is a network protocol that enables secure transfer of data from a remote client to a private server, creating a Virtual Private Network (VPN) using TCP/IP-based networks.

PPTP supports on-demand, multi-protocol and virtual private networking over public networks, such as the Internet.

The screen shown next is for **PPTP** encapsulation.

**Figure 49** Advanced: WAN PPTP Encapsulation

### WAN Port Configuration

This page is used to configure the parameters for Internet network which connects to the WAN port of your router. Here you may change the access method to static IP, DHCP, PPPoE or PPTP by click the item value of WAN Access type.

**WAN Access Type:** PPTP

**IP Address:** 172.1.1.2

**Subnet Mask:** 255.255.255.0

**Default Gateway:** 172.1.1.254

**Server IP Address:** 172.1.1.1

**User Name:**  

**Password:**  

**Authentication Type:** PAP

**MPPE Encryption Level:** None

**MTU Size:** 1452 (1400-1492 bytes)

Attain DNS Automatically  
 Set DNS Manually

**DNS 1:**  

**DNS 2:**  

**DNS 3:**  

**Clone MAC Address:** 000000000000

Respond to WAN Ping  
 Enable UPnP  
 Enable IPsec pass through on VPN connection  
 Enable PPTP pass through on VPN connection  
 Enable L2TP pass through on VPN connection

Save
Reset

The following table describes the labels in this screen.

**Table 36** Advanced: WAN PPTP Encapsulation

LABEL	DESCRIPTION
WAN Access Type	You must choose the PPTP option when the WAN port is used with PPTP.
IP Address	Type the (static) IP address assigned to you by your ISP.
IP Subnet Mask	Type the subnet mask assigned to you by your ISP.
Default Gateway	Type the default gateway assigned to you by your ISP.
Server IP Address	Type the IP address of the PPTP server.
User Name	Type the user name given to you by your ISP.
Password	Type the password associated with the User Name above.
MTU Size	Enter in the maximum MTU (packet size) here.
Attain DNS Automatically	Select this if your ISP assigns you a DNS server at the same time it assigns you an IP Address.
Set DNS Manually	Use this if your ISP does not assign a DNSP server when it assigns you an IP address.
DNS 1 - 3	Enter in your ISP's DNS server IP address here. You must enter in 1.

**Table 36** Advanced: WAN PPTP Encapsulation

LABEL	DESCRIPTION
Clone MAC Address	Your ISP may require a particular MAC address in order for you to connect to the Internet. This MAC address is the PC's MAC address that your ISP had originally connected your Internet connection to. Type in this Clone MAC address in this section to replace the WAN MAC address with the MAC address of that PC.
Respond to WAN Ping	Put a check in this box to reply to ping packets.
Enable UPnP	UPnP (Universal Plug and Play) allows automatic discovery and configuration of the Wireless Router. UPnP is by supported by Windows ME, XP, or later. Put a check in this box to allow the router configuration to be changed by UPnP devices.
IPSec Passthrough	Put a check in this box to enable computers on your LAN to make IPSec VPN connections to servers on the Internet.
PPTP Passthrough	Put a check in this box to enable computers on your LAN to make PPTP VPN connections to servers on the Internet.
L2TP Passthrough	Put a check in this box to enable computers on your LAN to make L2TP VPN connections to servers on the Internet.
Save	Click <b>Save</b> to save your changes back to the P-330W.
Reset	Click <b>Reset</b> to begin configuring this screen afresh.

## 6.7.5 L2TP Encapsulation

Layer Two Tunneling Protocol (L2TP) is a network protocol that enables secure transfer of data from a remote client to a private server, creating a Virtual Private Network (VPN) using TCP/IP-based networks.

The screen shown next is for **L2TP** encapsulation.

**Figure 50** Advanced: WAN L2TP Encapsulation

### WAN Port Configuration

This page is used to configure the parameters for Internet network which connects to the WAN port of your router. Here you may change the access method to static IP, DHCP, PPPoE or PPTP by click the item value of WAN Access type.

**WAN Access Type:** L2TP

Attain IP Automatically  
 Set IP Manually

**IP Address:** 172.1.1.2

**Subnet Mask:** 255.255.255.0

**Default Gateway:** 172.1.1.254

**Server IP Address:** 172.1.1.1

**User Name:**  

**Password:**  

Connect Disconnect

**Idle Time:** 0 (1-1000 minutes, 0 means Continuous Connectivity)

**MTU Size:** 1452 (1400-1492 bytes)

Attain DNS Automatically  
 Set DNS Manually

**DNS 1:**  

**DNS 2:**  

**DNS 3:**  

**Clone MAC Address:** 000000000000

Respond to WAN Ping

Enable UPnP

Enable IPsec pass through on VPN connection

Enable PPTP pass through on VPN connection

Enable L2TP pass through on VPN connection

Save Reset

The following table describes the labels in this screen.

**Table 37** Advanced: WAN L2PT Encapsulation

LABEL	DESCRIPTION
WAN Access Type	You must choose the L2TP option when the WAN port is used with L2TP.
Attain IP Automatically	Select this if your ISP dynamically assigns you an IP Address
Set IP Manually	Select this if your IP has assigned you a static IP address
IP Address	Type the (static) IP address assigned to you by your ISP.
IP Subnet Mask	Type the subnet mask assigned to you by your ISP.
Default Gateway	Type the default gateway assigned to you by your ISP.
Server IP Address	Type the IP address of the L2TP server.

**Table 37** Advanced: WAN L2PT Encapsulation

LABEL	DESCRIPTION
User Name	Type the user name given to you by your ISP.
Password	Type the password associated with the User Name above.
Idle Time	The amount of time before the L2TP session times out and drops connection.
MTU Size	Enter in the maximum MTU (packet size) here.
Attain DNS Automatically	Select this if your ISP assigns you a DNS server at the same time it assigns you an IP Address.
Set DNS Manually	Use this if your ISP does not assign a DNS server when it assigns you an IP address.
DNS 1 - 3	Enter in your ISP's DNS server IP address here. You must enter in 1.
Clone MAC Address	Your ISP may require a particular MAC address in order for you to connect to the Internet. This MAC address is the PC's MAC address that your ISP had originally connected your Internet connection to. Type in this Clone MAC address in this section to replace the WAN MAC address with the MAC address of that PC.
Respond to WAN Ping	Put a check in this box to reply to ping packets.
Enable UPnP	UPnP (Universal Plug and Play) allows automatic discovery and configuration of the Wireless Router. UPnP is supported by Windows ME, XP, or later. Put a check in this box to allow the router configuration to be changed by UPnP devices.
IPSec Passthrough	Put a check in this box to enable computers on your LAN to make IPSec VPN connections to servers on the Internet.
PPTP Passthrough	Put a check in this box to enable computers on your LAN to make PPTP VPN connections to servers on the Internet.
L2TP Passthrough	Put a check in this box to enable computers on your LAN to make L2TP VPN connections to servers on the Internet.
Save	Click <b>Save</b> to save your changes back to the P-330W.
Reset	Click <b>Reset</b> to begin configuring this screen afresh.

## 6.8 Ping

The Ping screen allows you to send out PING requests from your P-330W to a network address you specify and then reports back the test result. You can use this command to help diagnose network problems.

To access the Ping command, click **ADVANCED** then the **Ping** link. The screen appears as shown.

**Figure 51** Advanced: Ping

**Ping Toolkit**

This page can be used to run ping command.

IP Address / Host Name  Run Reset

Response <Empty>

The following table describes the labels in this screen.

**Table 38** Advanced: Ping

LABEL	DESCRIPTION
IP Address / Host Name	Enter in a host name or IP address that you would like to ping.
Run	Performs the Ping command.
Reset	Click <b>Reset</b> to begin configuring this screen afresh.
Response	The results of your ping request will show up here.

## 6.9 DoS Setting

DoS (Denial of Service) attacks can flood your Internet connection with invalid packets and connection requests, using so much bandwidth and so many resources that Internet access becomes unavailable. The Wireless Router incorporates protection against DoS attacks. This screen allows you to configure DoS protection.

To access the DoS settings, click **ADVANCED** then the **DoS** link. The screen appears as shown.

**Figure 52** Advanced: DoS

### Denial of Service

A "denial-of-service" (DoS) attack is characterized by an explicit attempt by hackers to prevent legitimate users of a service from using that service.

Enable DoS Prevention

- Whole System Flood: SYN  Packets/Second
- Whole System Flood: FIN  Packets/Second
- Whole System Flood: UDP  Packets/Second
- Whole System Flood: ICMP  Packets/Second
- Per-Source IP Flood: SYN  Packets/Second
- Per-Source IP Flood: FIN  Packets/Second
- Per-Source IP Flood: UDP  Packets/Second
- Per-Source IP Flood: ICMP  Packets/Second
- TCP/UDP PortScan  Sensitivity
- ICMP Smurf
- IP Land
- IP Spoof
- IP TearDrop
- PingOfDeath
- TCP Scan
- TCP SynWithData
- UDP Bomb
- UDP EchoChargen

Enable Source IP Blocking  Block time (sec)

The following table describes the labels in this screen.

**Table 39** Advanced: DoS

LABEL	DESCRIPTION
Enable DoS Protection	Put a check in this box to enable DoS protection.
Select All	Puts a check next to all DoS protection services.
Clear All	Resets all check boxes to blank.
Apply Changes	Applies DoS protections.

## 6.10 Diagnostics

This screen allows you to perform a DNS lookup on any host name you enter. This can be used to help diagnose network problems.



To access the Diagnostic service, click **ADVANCED** then the **DIAGNOSTIC** link. The screen appears as shown.

**Figure 53** Advanced: Diagnostic

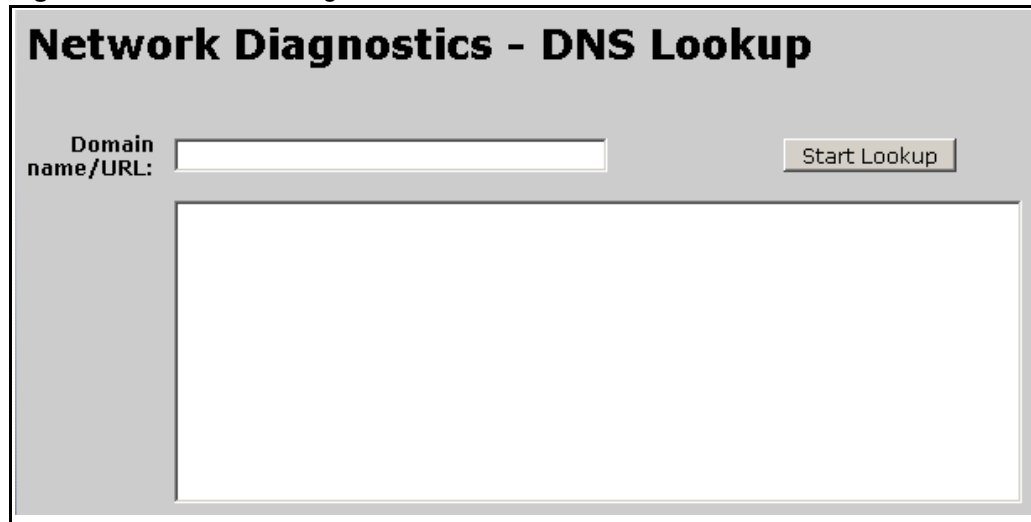

**Network Diagnostics - DNS Lookup**

Domain name/URL:

The following table describes the labels in this screen.

**Table 40** Advanced: Diagnostic

LABEL	DESCRIPTION
Domain Name/URL	Enter the domain name you want to lookup.
Start Lookup	Click this button to activate the DNS lookup.

# CHAPTER 7

## Administrator Options

### 7.1 Remote Management

Remote management allows you to remotely configure your P-330W over your Internet connection. Since this is a potential security risk, this feature is turned off by default.

To access the **Remote Management** configuration screen, click **ADMINISTRATOR** then the **REMOTE MANAGEMENT** link. The screen appears as shown.

**Figure 54** Administrator: Remote Management

The following table describes the labels in this screen.

**Table 41** Administrator: Remote Management

LABEL	DESCRIPTION
Enable Web Server Access via WAN	Put a check in this box to allow your P-330W to be accessed over the Internet.
Port Number	Enter in the port number you want the P-330W to respond on when accessed from the Internet.
Save	Click <b>Save</b> to save your changes back to the P-330W.
Reset	Click <b>Reset</b> to begin configuring this screen afresh.

### 7.2 Configuration Screen

Click **Administrator**, and then the **Config File** link. The screen you are presented with is next.

**Figure 55** Administrator: Configuration File

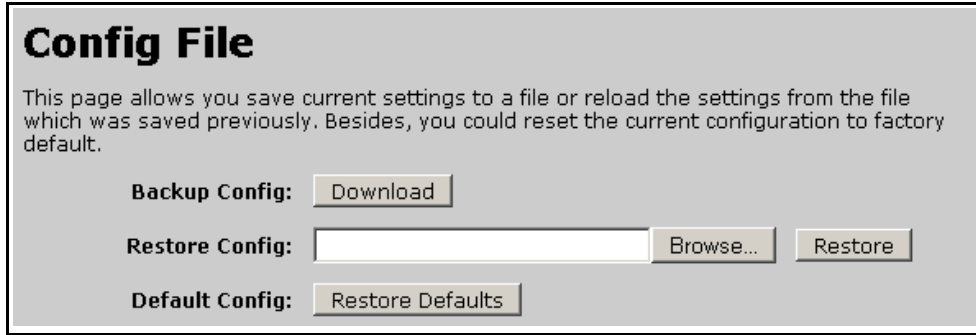

## 7.2.1 Backup Configuration

Backup configuration allows you to back up (save) the P-330W's current configuration to a file on your computer. Once your P-330W is configured and functioning properly, it is highly recommended that you back up your configuration file before making configuration changes. The backup configuration file will be useful in case you need to return to your previous settings.

Click **Download** to save the P-330W's current configuration to your computer.

## 7.2.2 Restore Configuration

Restore configuration allows you to upload a new or previously saved configuration file from your computer to your P-330W.

**Table 42** Maintenance Restore Configuration

LABEL	DESCRIPTION
File Path	Type in the location of the file you want to upload in this field or click <b>Browse ...</b> to find it.
Browse...	Click <b>Browse...</b> to find the file you want to upload. Remember that you must decompress compressed (.ZIP) files before you can upload them.
Restore	Click <b>Restore</b> to begin the upload process.



**Note:** Do not turn off the P-330W while configuration file upload is in progress

The P-330W automatically restarts in this time causing a temporary network disconnect. In some operating systems, you may see the following icon on your desktop.

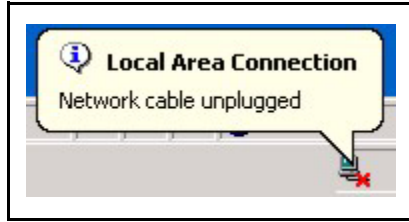
**Figure 56** Temporarily Disconnected

### 7.2.3 Back to Factory Defaults

Pressing the **Restore Defaults** button in this section clears all user-entered configuration information and returns the P-330W to its factory defaults.

You can also press the **RESET** button on the rear panel to reset the factory defaults of your P-330W. Refer to the *Introducing the Web Configurator* chapter for more information on the **RESET** button.

## 7.3 Logs

The Logs record various types of activity on the Wireless Router. This data is useful for troubleshooting, but enabling all logs will generate a large amount of data and adversely affect performance.

To access the **Logs** configuration screen, click **ADMINISTRATOR** then the **LOGS** link. The screen appears as shown.

**Figure 57** Administrator: Logs

The following table describes the labels in this screen.

**Table 43** Administrator: Remote Management

LABEL	DESCRIPTION
Enable Log	Activates the logging function.
System All	Activates all logging functions.
Wireless Only	Only logs related to the wireless LAN will be recorded.
DoS Only	Only logs related to the DoS protection will be recorded.
WAN Only	Only logs related to the WAN will be recorded.
DHCP Server Only	Only logs related to the DHCP Server will be recorded.
URL Filter Only	Only logs related to the URL Filter will be recorded.
Apply Changes	Activate the logging feature.
Refresh	Refreshes the current display to show the latest log activity.
Clear	Deletes the logs.

## 7.4 IP Filtering

Entries in this table are used to restrict certain types of data packets from your local network to Internet through the Router. Here you can restrict local LAN clients to access Internet application/services by IP Address. Use of such filters can be helpful in securing or restricting your local network.

To access the **IP Filtering** configuration screen, click **ADMINISTRATOR** then the **IP FILTERING** link. The screen appears as shown.

**Figure 58** Administrator: IP Filtering

**IP Filtering**

Entries in this table are used to restrict certain types of data packets from your local network to Internet through the Router. Here you can restrict local LAN clients to access Internet application/services by IP Address. Use of such filters can be helpful in securing or restricting your local network.

Enable IP Filtering

Local IP Address:

Protocol:

Description:

Save Reset

Current Filter Table:

Local IP Address	Protocol	Description	Select

Delete Selected Delete All Reset

The following table describes the labels in this screen.

**Table 44** Administrator: IP Filtering

LABEL	DESCRIPTION
Enable IP Filtering	Enables IP Filtering.
Local IP Address	Enter the IP address of the local device whose access you want to restrict.
Description	Enter in a descriptive description for this rule.
Save	Click <b>Save</b> to save your changes back to the P-330W.
Reset	Click <b>Reset</b> to begin configuring this screen afresh.

## 7.5 MAC Filtering

This screen is used to restrict devices on your local network from being able to access the Internet. You do this by entering the MAC address of any device you want to restrict.

To access the **MAC Filtering** configuration screen, click **ADMINISTRATOR** then the **MAC FILTERING** link. The screen appears as shown.

**Figure 59** Administrator: MAC Filtering

**MAC Filtering**

Entries in this table are used to restrict certain types of data packets from your local network to Internet through the Router. Here you can restrict local LAN clients to access Internet application/services by MAC Address. Use of such filters can be helpful in securing or restricting your local network.

Enable MAC Filtering

MAC Address:

Description:

Save Reset

Current Filter Table:

MAC Address	Description	Select
Delete Selected Delete All Reset		

The following table describes the labels in this screen.

**Table 45** Administrator: MAC Filtering

LABEL	DESCRIPTION
Enable MAC Filtering	Enables MAC Filtering.
MAC Address	Enter the MAC address of the local device whose access you want to restrict.
Description	Enter in a descriptive description for this rule.
Save	Click <b>Save</b> to save your changes back to the P-330W.
Reset	Click <b>Reset</b> to begin configuring this screen afresh.

## 7.6 URL Filtering

This screen is used to restrict devices on your local network from being able to access the Internet. You can enter in a list of Internet URL's that you wish to restrict access to.

To access the **URL Filtering** configuration screen, click **ADMINISTRATOR** then the **URL FILTERING** link. The screen appears as shown.

**Figure 60** Administrator: URL Filtering

**URL Filtering**

URL filter is used to deny LAN users from accessing the internet. Block those URLs which contain keywords listed below.  
Exempt IP means the specific LAN users which can access the blocked URLs.

Enable URL Filtering

URL Address:

Exempt IP Pool Start:  Pool Size:

Current Filter Table:

URL Address	Select

The following table describes the labels in this screen.

**Table 46** Administrator: URL Filtering

LABEL	DESCRIPTION
Enable URL Filtering	Enables URL Filtering.
URL Address	Enter the URL address of the Internet site you want to restrict.
Exempt IP Pool Start	Enter the initial IP address you want to allow to access the blocked URLs.
Pool Size	Enter the size of exempt IP Pool.
Apply Changes	Click <b>Apply Changes</b> to save your changes back to the P-330W.
Reset	Click <b>Reset</b> to begin configuring this screen afresh.

## 7.7 Statistics

The statistics screen provides you with information on each interface on your P-330W. This includes the WAN, LAN, and wireless network connections. This page will show you how many packets of data have been sent and received.

## 7.8 Time Zone Setting

To change your P-330W's time and date, click **ADMINISTRATOR**, then the **Time Zone Setting** link. The screen appears as shown. Use this screen to configure the P-330W's time based on your local time zone.



**Figure 61** Administrator: Time Zone Setting

The following table describes the labels in this screen.

**Table 47** Administrator: Time Zone Setting

LABEL	DESCRIPTION
Current Time	This field displays the time of your P-330W. If you are not using an NTP server, you can make changes here and they will be applied when you click <b>Save</b> .
Enable NTP client update	Put a check in this box to enable the use of an external NTP server.
Time Zone Select	Choose the Time Zone of your location. This will set the time difference between your time zone and Greenwich Mean Time (GMT).
NTP Server	Select Auto or Enter the IP address manually. Check with your ISP/network administrator if you are unsure of this information.
Daylight Saving Time	Put a check in this box to enable the use of Daylight Saving Time.
Save	Click <b>Save</b> to save your changes back to the P-330W.
Reset	Click <b>Reset</b> to begin configuring this screen afresh.
Refresh	Click <b>Refresh</b> to display the current time.

## 7.9 Upgrade Firmware

Find firmware at [www.us.zyxel.com](http://www.us.zyxel.com) in a file that (usually) uses the system model name with a "\*.bin" extension, e.g., "P-330W.bin". The upload process uses HTTP (Hypertext Transfer Protocol) and may take up to two minutes. After a successful upload, the system will reboot.

Click **Administrator**, and then the **Upgrade Firmware** link. Follow the instructions in this screen to upload firmware to your P-330W.

**Figure 62** Administrator: Upgrade Firmware



The following table describes the labels in this screen.

**Table 48** Administrator: Upgrade Firmware

LABEL	DESCRIPTION
Select File	Type in the location of the file you want to upload in this field or click <b>Browse ...</b> to find it.
Browse...	Click <b>Browse...</b> to find the .bin file you want to upload. Remember that you must decompress compressed (.zip) files before you can upload them.
Start Upgrade	Click <b>Start Upgrade</b> to begin the upload process. This process may take up to two minutes.



**Note:** Do not turn off the P-330W while firmware upload is in progress!

After you see the **Firmware Upload in Process** screen, wait two minutes before logging into the P-330W again.

**Figure 63** Upload Warning

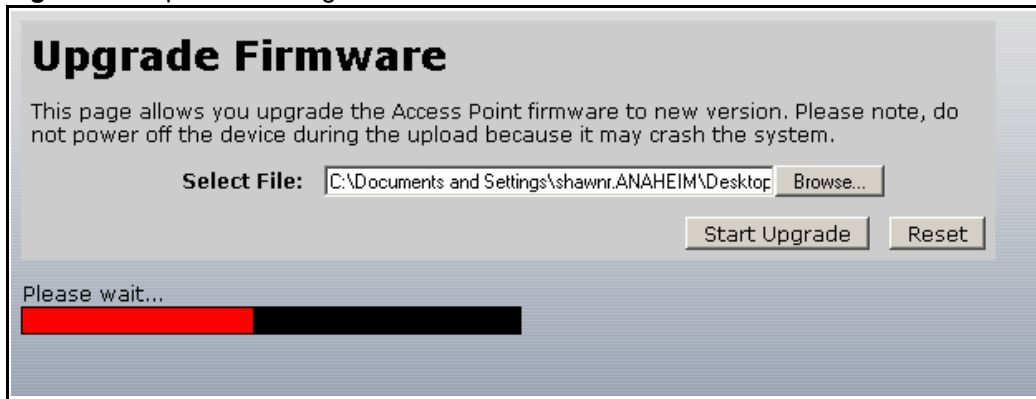

The P-330W automatically restarts in this time causing a temporary network disconnect. In some operating systems, you may see the following icon on your desktop.

**Figure 64** Network Temporarily Disconnected

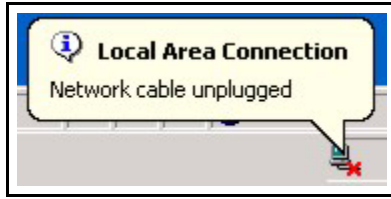

After two minutes, log in again and check your new firmware version in the **System Status** screen.

If the upload was not successful, a warning screen will appear. Click **Return** to go back to the **F/W Upload** screen.

# Appendix A

## PPPoE

### PPPoE in Action

An ADSL modem bridges a PPP session over Ethernet (PPP over Ethernet, RFC 2516) from your computer to an ATM PVC (Permanent Virtual Circuit) which connects to a DSL Access Concentrator where the PPP session terminates (see the next figure). One PVC can support any number of PPP sessions from your LAN. PPPoE provides access control and billing functionality in a manner similar to dial-up services using PPP.

### Benefits of PPPoE

PPPoE offers the following benefits:

- It provides you with a familiar dial-up networking (DUN) user interface.
- It lessens the burden on the carriers of provisioning virtual circuits all the way to the ISP on multiple switches for thousands of users. For GSTN (PSTN and ISDN), the switching fabric is already in place.
- It allows the ISP to use the existing dial-up model to authenticate and (optionally) to provide differentiated services.

### Traditional Dial-up Scenario

The following diagram depicts a typical hardware configuration where the computers use traditional dial-up networking.

**Figure 65** Single-Computer per Router Hardware Configuration

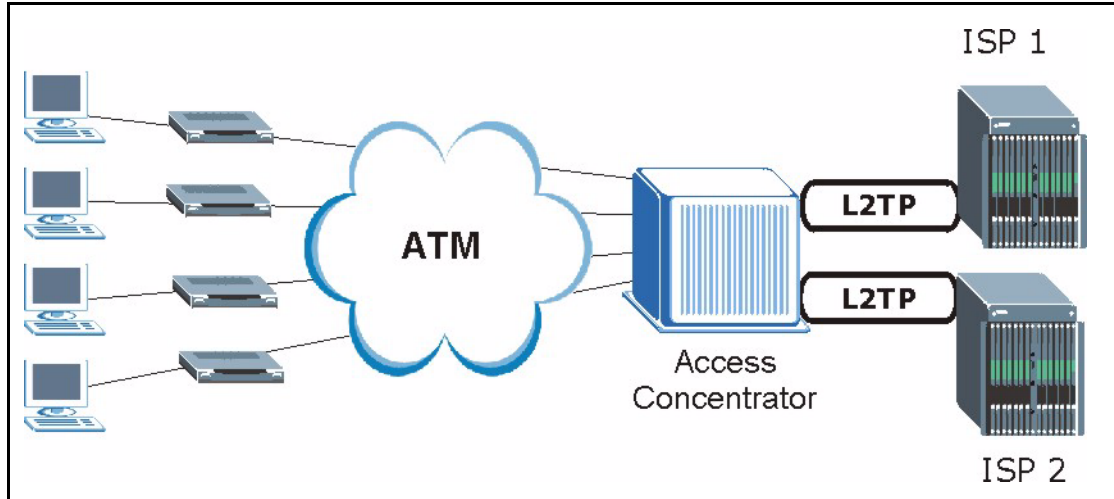

## How PPPoE Works

The PPPoE driver makes the Ethernet appear as a serial link to the computer and the computer runs PPP over it, while the modem bridges the Ethernet frames to the Access Concentrator (AC). Between the AC and an ISP, the AC is acting as a L2TP (Layer 2 Tunneling Protocol) LAC (L2TP Access Concentrator) and tunnels the PPP frames to the ISP. The L2TP tunnel is capable of carrying multiple PPP sessions.

With PPPoE, the VC (Virtual Circuit) is equivalent to the dial-up connection and is between the modem and the AC, as opposed to all the way to the ISP. However, the PPP negotiation is between the computer and the ISP.

## P-330W as a PPPoE Client

When using the P-330W as a PPPoE client, the computers on the LAN see only Ethernet and are not aware of PPPoE. This alleviates the administrator from having to manage the PPPoE clients on the individual computers.

**Figure 66** P-330W as a PPPoE Client

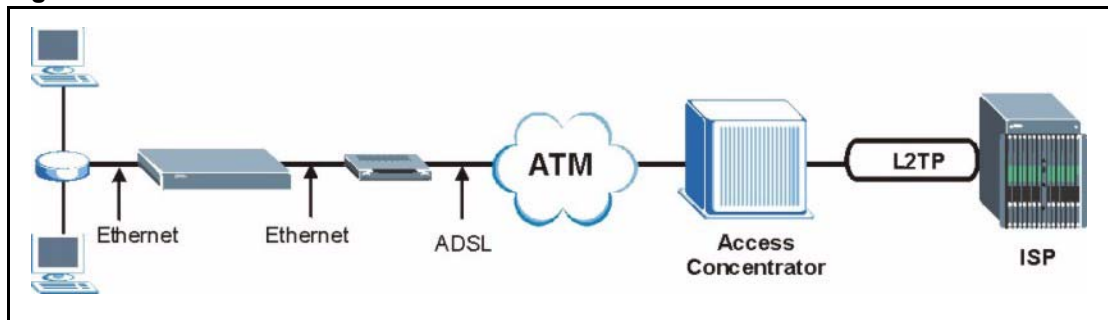

# Appendix B

## PPTP

### What is PPTP?

PPTP (Point-to-Point Tunneling Protocol) is a Microsoft proprietary protocol (RFC 2637 for PPTP is informational only) to tunnel PPP frames.

### How can we transport PPP frames from a computer to a broadband modem over Ethernet?

A solution is to build PPTP into the ANT (ADSL Network Termination) where PPTP is used only over the short haul between the computer and the modem over Ethernet. For the rest of the connection, the PPP frames are transported with PPP over AAL5 (RFC 2364). The PPP connection, however, is still between the computer and the ISP. The various connections in this setup are depicted in the following diagram. The drawback of this solution is that it requires one separate ATM VC per destination.

**Figure 67** Transport PPP frames over Ethernet

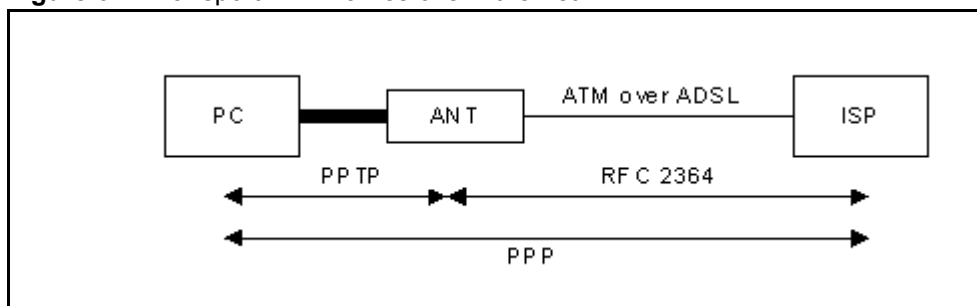

### PPTP and the P-330W

When the P-330W is deployed in such a setup, it appears as a computer to the ANT.

In Windows VPN or PPTP Pass-Through feature, the PPTP tunneling is created from Windows 95, 98 and NT clients to an NT server in a remote location. The pass-through feature allows users on the network to access a different remote server using the P-330W's Internet connection. In SUA/NAT mode, the P-330W is able to pass the PPTP packets to the internal PPTP server (i.e. NT server) behind the NAT. You need to configure port forwarding for port 1723 to have the P-330W forward PPTP packets to the server. In the case above as the remote PPTP Client initializes the PPTP connection, the user must configure the PPTP clients. The P-330W initializes the PPTP connection hence; there is no need to configure the remote PPTP clients.

## PPTP Protocol Overview

PPTP is very similar to L2TP, since L2TP is based on both PPTP and L2F (Cisco's Layer 2 Forwarding). Conceptually, there are three parties in PPTP, namely the PNS (PPTP Network Server), the PAC (PPTP Access Concentrator) and the PPTP user. The PNS is the box that hosts both the PPP and the PPTP stacks and forms one end of the PPTP tunnel. The PAC is the box that dials/answers the phone calls and relays the PPP frames to the PNS. The PPTP user is not necessarily a PPP client (can be a PPP server too). Both the PNS and the PAC must have IP connectivity; however, the PAC must in addition have dial-up capability. The phone call is between the user and the PAC and the PAC tunnels the PPP frames to the PNS. The PPTP user is unaware of the tunnel between the PAC and the PNS.

**Figure 68** PPTP Protocol Overview



Microsoft includes PPTP as a part of the Windows OS. In Microsoft's implementation, the computer, and hence the P-330W, is the PNS that requests the PAC (the ANT) to place an outgoing call over AAL5 to an RFC 2364 server.

## Control & PPP Connections

Each PPTP session has distinct control connection and PPP data connection.

### Call Connection

The control connection runs over TCP. Similar to L2TP, a tunnel control connection is first established before call control messages can be exchanged. Please note that a tunnel control connection supports multiple call sessions.

The following diagram depicts the message exchange of a successful call setup between a computer and an ANT.

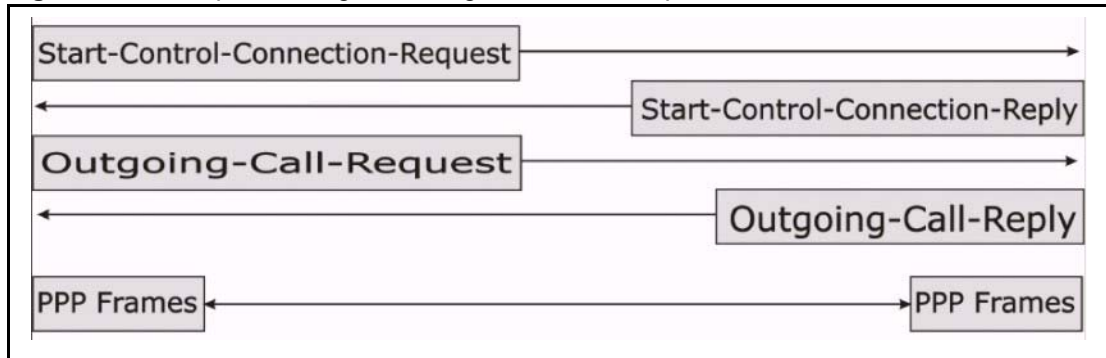
**Figure 69** Example Message Exchange between Computer and an ANT

## PPP Data Connection

The PPP frames are tunneled between the PNS and PAC over GRE (General Routing Encapsulation, RFC 1701, 1702). The individual calls within a tunnel are distinguished using the Call ID field in the GRE header.





# Appendix C

## Setting up Your Computer's IP Address

All computers must have a 10M or 100M Ethernet adapter card and TCP/IP installed.

Windows 95/98/Me/NT/2000/XP, Macintosh OS 7 and later operating systems and all versions of UNIX/LINUX include the software components you need to install and use TCP/IP on your computer. Windows 3.1 requires the purchase of a third-party TCP/IP application package.

TCP/IP should already be installed on computers using Windows NT/2000/XP, Macintosh OS 7 and later operating systems.

After the appropriate TCP/IP components are installed, configure the TCP/IP settings in order to "communicate" with your network.

If you manually assign IP information instead of using dynamic assignment, make sure that your computers have IP addresses that place them in the same subnet as the P-330W's LAN port.

### Windows 95/98/Me

Click **Start**, **Settings**, **Control Panel** and double-click the **Network** icon to open the **Network** window

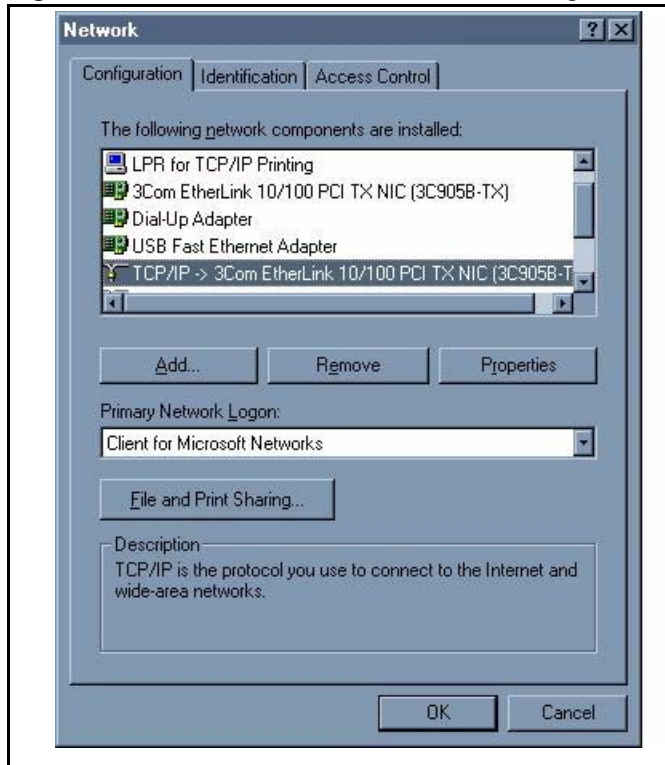
**Figure 70** Windows 95/98/Me: Network: Configuration

## Installing Components

The **Network** window **Configuration** tab displays a list of installed components. You need a network adapter, the TCP/IP protocol and Client for Microsoft Networks.

If you need the adapter:

- 1 In the **Network** window, click **Add**.
- 2 Select **Adapter** and then click **Add**.
- 3 Select the manufacturer and model of your network adapter and then click **OK**.

If you need TCP/IP:

- 1 In the **Network** window, click **Add**.
- 2 Select **Protocol** and then click **Add**.
- 3 Select **Microsoft** from the list of **manufacturers**.
- 4 Select **TCP/IP** from the list of network protocols and then click **OK**.

If you need Client for Microsoft Networks:

- 1 Click **Add**.
- 2 Select **Client** and then click **Add**.

- 3 Select **Microsoft** from the list of manufacturers.
- 4 Select **Client for Microsoft Networks** from the list of network clients and then click **OK**.
- 5 Restart your computer so the changes you made take effect.

## Configuring

- 1 In the **Network** window **Configuration** tab, select your network adapter's TCP/IP entry and click **Properties**
- 2 Click the **IP Address** tab.
  - If your IP address is dynamic, select **Obtain an IP address automatically**.
  - If you have a static IP address, select **Specify an IP address** and type your information into the **IP Address** and **Subnet Mask** fields.

**Figure 71** Windows 95/98/Me: TCP/IP Properties: IP Address

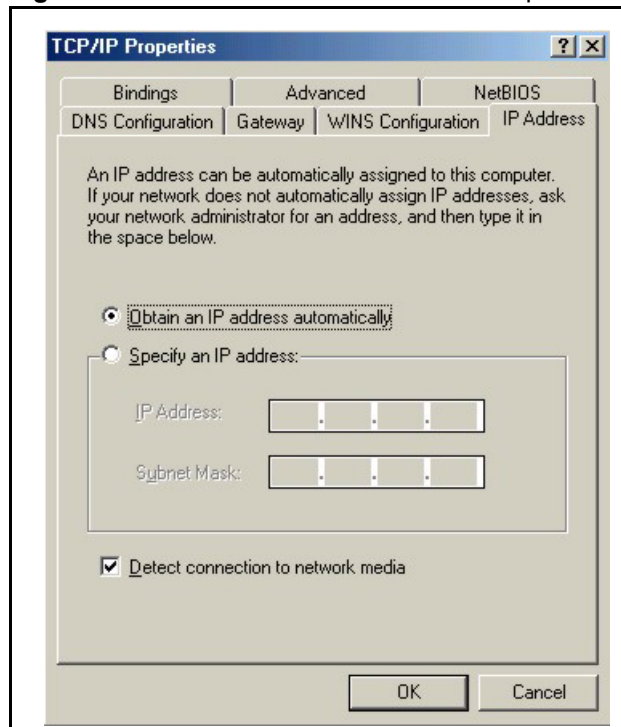

- 3 Click the **DNS Configuration** tab.
  - If you do not know your DNS information, select **Disable DNS**.
  - If you know your DNS information, select **Enable DNS** and type the information in the fields below (you may not need to fill them all in).

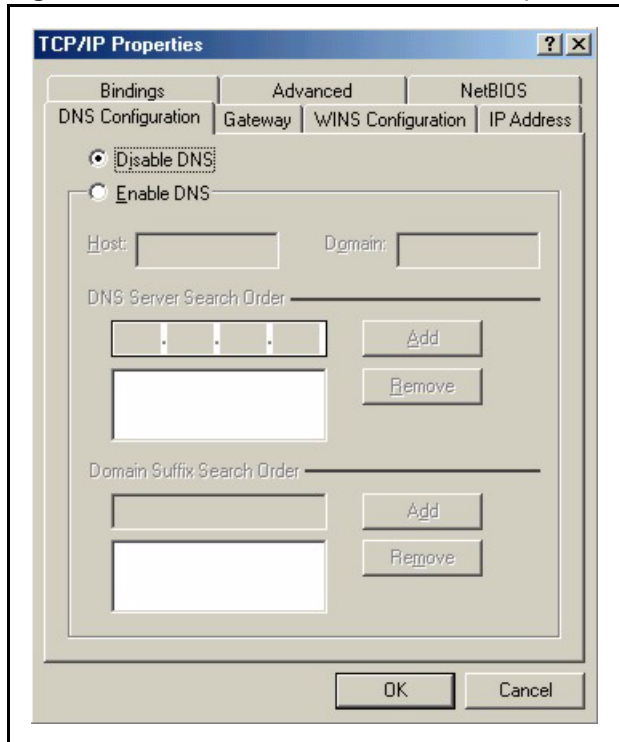
**Figure 72** Windows 95/98/Me: TCP/IP Properties: DNS Configuration**4** Click the **Gateway** tab.

- If you do not know your gateway's IP address, remove previously installed gateways.
- If you have a gateway IP address, type it in the **New gateway field** and click **Add**.

**5** Click **OK** to save and close the **TCP/IP Properties** window.**6** Click **OK** to close the **Network** window. Insert the Windows CD if prompted.**7** Turn on your P-330W and restart your computer when prompted.

## Verifying Settings

**1** Click **Start** and then **Run**.**2** In the **Run** window, type "winipcfg" and then click **OK** to open the **IP Configuration** window.**3** Select your network adapter. You should see your computer's IP address, subnet mask and default gateway.

## Windows 2000/NT/XP

**1** For Windows XP, click **start**, **Control Panel**. In Windows 2000/NT, click **Start**, **Settings**, **Control Panel**.

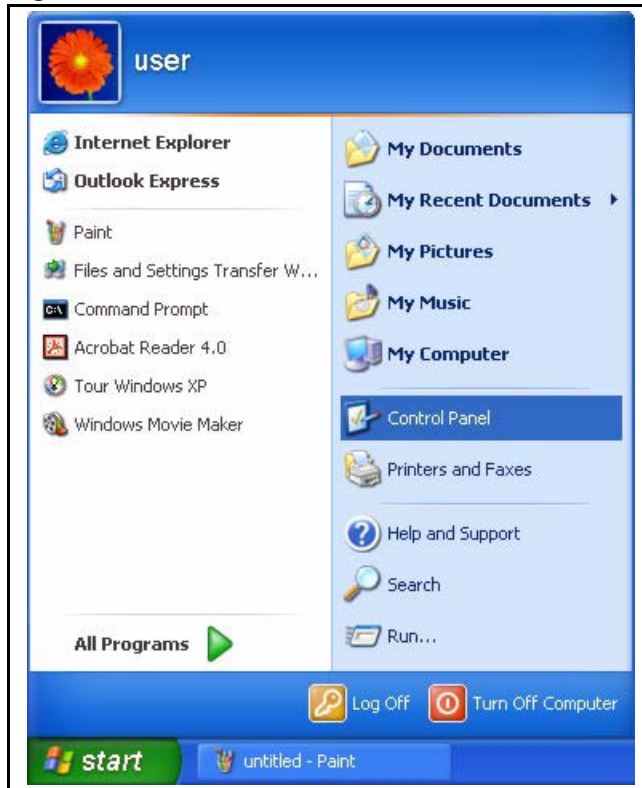
**Figure 73** Windows XP: Start Menu

**2** For Windows XP, click **Network Connections**. For Windows 2000/NT, click **Network and Dial-up Connections**.

**Figure 74** Windows XP: Control Panel

**3** Right-click **Local Area Connection** and then click **Properties**.

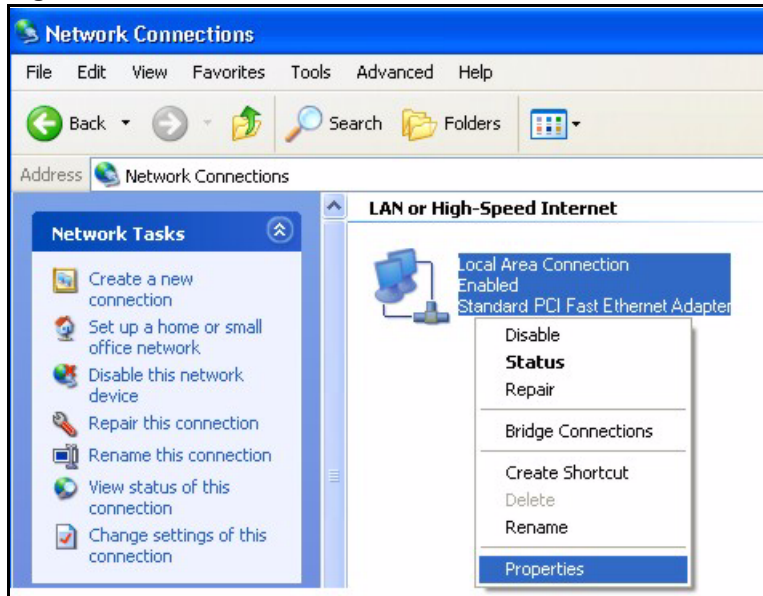
**Figure 75** Windows XP: Control Panel: Network Connections: Properties

- 4 Select **Internet Protocol (TCP/IP)** (under the **General** tab in Win XP) and click **Properties**.

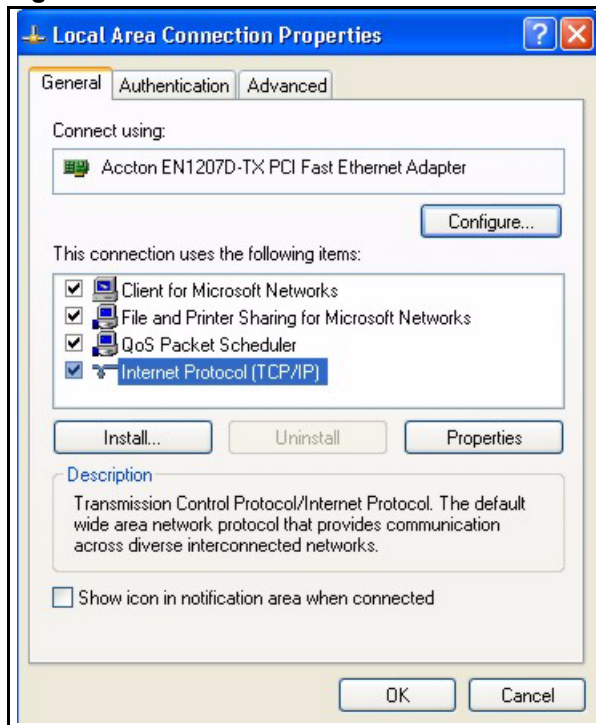
**Figure 76** Windows XP: Local Area Connection Properties

- 5 The **Internet Protocol TCP/IP Properties** window opens (the **General** tab in Windows XP).

- If you have a dynamic IP address click **Obtain an IP address automatically**.

- If you have a static IP address click **Use the following IP Address** and fill in the **IP address**, **Subnet mask**, and **Default gateway** fields. Click **Advanced**.

**Figure 77** Windows XP: Advanced TCP/IP Settings

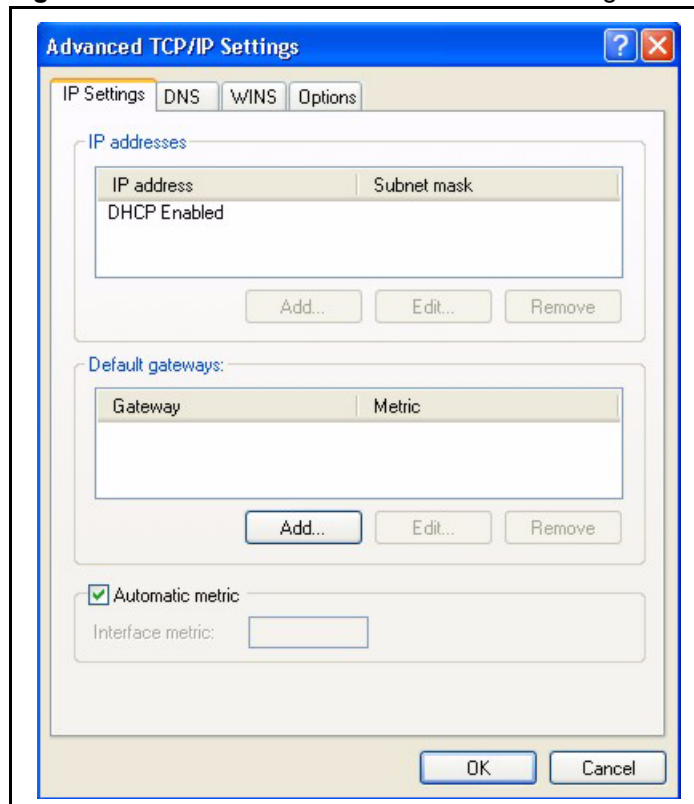

- 6** If you do not know your gateway's IP address, remove any previously installed gateways in the **IP Settings** tab and click **OK**.

Do one or more of the following if you want to configure additional IP addresses:

- In the **IP Settings** tab, in IP addresses, click **Add**.
- In **TCP/IP Address**, type an IP address in **IP address** and a subnet mask in **Subnet mask**, and then click **Add**.
- Repeat the above two steps for each IP address you want to add.
- Configure additional default gateways in the **IP Settings** tab by clicking **Add** in **Default gateways**.
- In **TCP/IP Gateway Address**, type the IP address of the default gateway in **Gateway**. To manually configure a default metric (the number of transmission hops), clear the **Automatic metric** check box and type a metric in **Metric**.
- Click **Add**.
- Repeat the previous three steps for each default gateway you want to add.
- Click **OK** when finished.



**7** In the **Internet Protocol TCP/IP Properties** window (the **General** tab in Windows XP):

- Click **Obtain DNS server address automatically** if you do not know your DNS server IP address(es).
- If you know your DNS server IP address(es), click **Use the following DNS server addresses**, and type them in the **Preferred DNS server** and **Alternate DNS server** fields.

If you have previously configured DNS servers, click **Advanced** and then the **DNS** tab to order them.

**Figure 78** Windows XP: Internet Protocol (TCP/IP) Properties

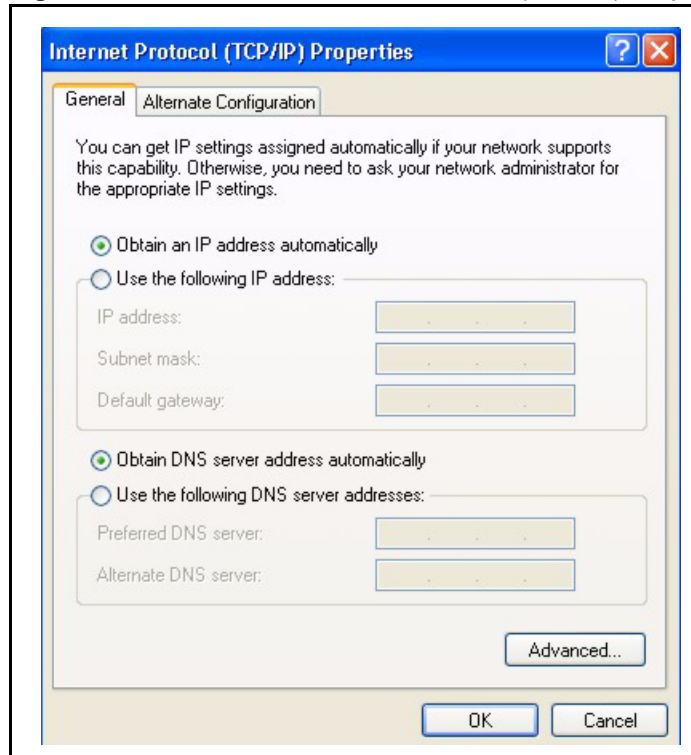

**8** Click **OK** to close the **Internet Protocol (TCP/IP) Properties** window.

**9** Click **OK** to close the **Local Area Connection Properties** window.

**10** Turn on your P-330W and restart your computer (if prompted).

## Verifying Settings

**1** Click **Start**, **All Programs**, **Accessories** and then **Command Prompt**.

**2** In the **Command Prompt** window, type "ipconfig" and then press [ENTER]. You can also open **Network Connections**, right-click a network connection, click **Status** and then click the **Support** tab.

## Macintosh OS 8/9

- 1 Click the **Apple** menu, **Control Panel** and double-click **TCP/IP** to open the **TCP/IP Control Panel**.

**Figure 79** Macintosh OS 8/9: Apple Menu

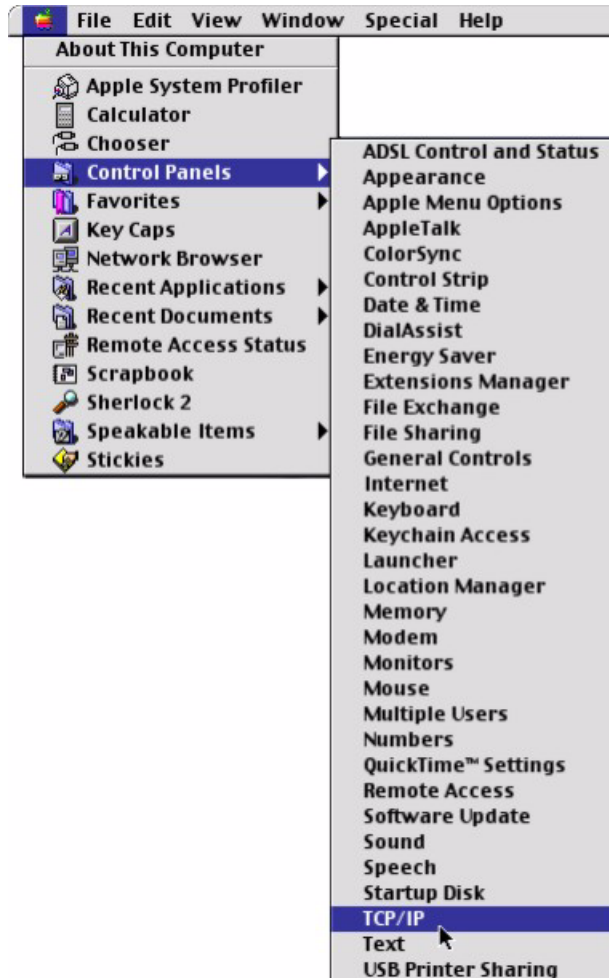

- 2 Select **Ethernet built-in** from the **Connect via** list.

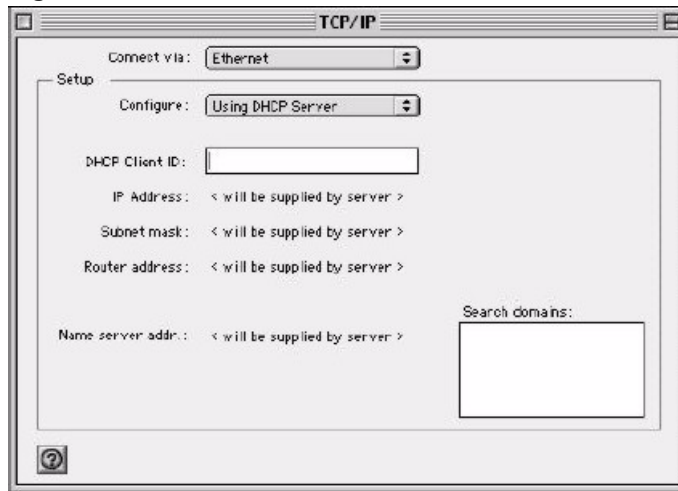
**Figure 80** Macintosh OS 8/9: TCP/IP

- 3** For dynamically assigned settings, select **Using DHCP Server** from the **Configure:** list.
- 4** For statically assigned settings, do the following:
  - From the **Configure** box, select **Manually**.
  - Type your IP address in the **IP Address** box.
  - Type your subnet mask in the **Subnet mask** box.
  - Type the IP address of your P-330W in the **Router address** box.
- 5** Close the **TCP/IP Control Panel**.
- 6** Click **Save** if prompted, to save changes to your configuration.
- 7** Turn on your P-330W and restart your computer (if prompted).

## Verifying Settings

Check your TCP/IP properties in the **TCP/IP Control Panel** window.

## Macintosh OS X

- 1** Click the **Apple** menu, and click **System Preferences** to open the **System Preferences** window.

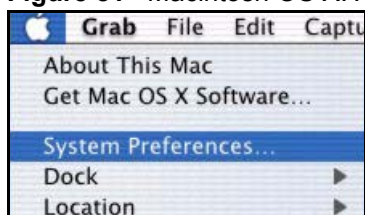
**Figure 81** Macintosh OS X: Apple Menu

- 2** Click **Network** in the icon bar.
  - Select **Automatic** from the **Location** list.

- Select **Built-in Ethernet** from the **Show** list.
- Click the **TCP/IP** tab.

3 For dynamically assigned settings, select **Using DHCP** from the **Configure** list.

**Figure 82** Macintosh OS X: Network

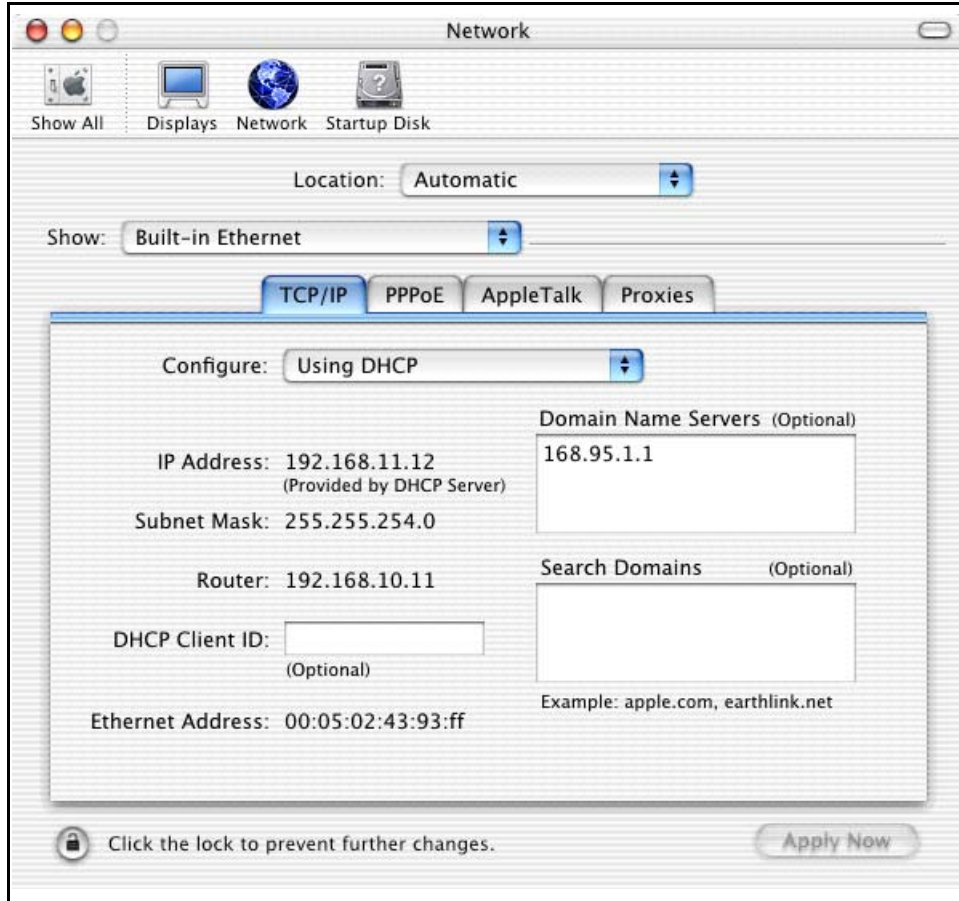

4 For statically assigned settings, do the following:

- From the **Configure** box, select **Manually**.
- Type your IP address in the **IP Address** box.
- Type your subnet mask in the **Subnet mask** box.
- Type the IP address of your P-330W in the **Router address** box.

5 Click **Apply Now** and close the window.

6 Turn on your P-330W and restart your computer (if prompted).

## Verifying Settings

Check your TCP/IP properties in the **Network** window.



# Appendix D

## Wireless LAN and IEEE 802.11

A wireless LAN (WLAN) provides a flexible data communications system that you can use to access various services (navigating the Internet, email, printer services, etc.) without the use of a cabled connection. In effect a wireless LAN environment provides you the freedom to stay connected to the network while roaming around in the coverage area.

### Benefits of a Wireless LAN

Wireless LAN offers the following benefits:

- It provides you with access to network services in areas otherwise hard or expensive to wire, such as historical buildings, buildings with asbestos materials and classrooms.
- It provides healthcare workers like doctors and nurses access to a complete patient's profile on a handheld or notebook computer upon entering a patient's room.
- It allows flexible workgroups a lower total cost of ownership for workspaces that are frequently reconfigured.
- It allows conference room users access to the network as they move from meeting to meeting, getting up-to-date access to information and the ability to communicate decisions while "on the go".
- It provides campus-wide networking mobility, allowing enterprises the roaming capability to set up easy-to-use wireless networks that cover the entire campus transparently.

### IEEE 802.11

The 1997 completion of the IEEE 802.11 standard for wireless LANs (WLANs) was a first important step in the evolutionary development of wireless networking technologies. The standard was developed to maximize interoperability between differing brands of wireless LANs as well as to introduce a variety of performance improvements and benefits.

The IEEE 802.11 specifies three different transmission methods for the PHY, the layer responsible for transferring data between nodes. Two of the methods use spread spectrum RF signals, Direct Sequence Spread Spectrum (DSSS) and Frequency-Hopping Spread Spectrum (FHSS), in the 2.4 to 2.4825 GHz unlicensed ISM (Industrial, Scientific and Medical) band. The third method is infrared technology, using very high frequencies, just below visible light in the electromagnetic spectrum to carry data.

## Ad-hoc Wireless LAN Configuration

The simplest WLAN configuration is an independent (Ad-hoc) WLAN that connects a set of computers with wireless nodes or stations (STA), which is called a Basic Service Set (BSS). In the most basic form, a wireless LAN connects a set of computers with wireless adapters. Any time two or more wireless adapters are within range of each other, they can set up an independent network, which is commonly referred to as an Ad-hoc network or Independent Basic Service Set (IBSS). The following diagram shows an example of notebook computers using wireless adapters to form an Ad-hoc wireless LAN.

**Figure 83** Peer-to-Peer Communication in an Ad-hoc Network

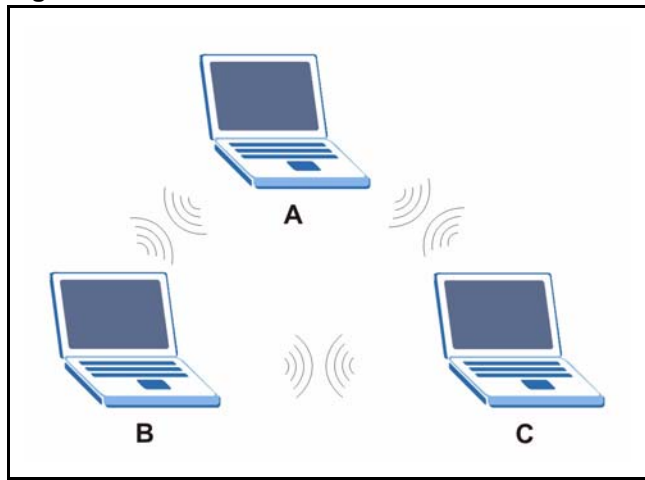

## Infrastructure Wireless LAN Configuration

For Infrastructure WLANs, multiple Access Points (APs) link the WLAN to the wired network and allow users to efficiently share network resources. The Access Points not only provide communication with the wired network but also mediate wireless network traffic in the immediate neighborhood. Multiple Access Points can provide wireless coverage for an entire building or campus. All communications between stations or between a station and a wired network client go through the Access Point.

The Extended Service Set (ESS) shown in the next figure consists of a series of overlapping BSSs (each containing an Access Point) connected together by means of a Distribution System (DS). Although the DS could be any type of network, it is almost invariably an Ethernet LAN. Mobile nodes can roam between Access Points and seamless campus-wide coverage is possible.

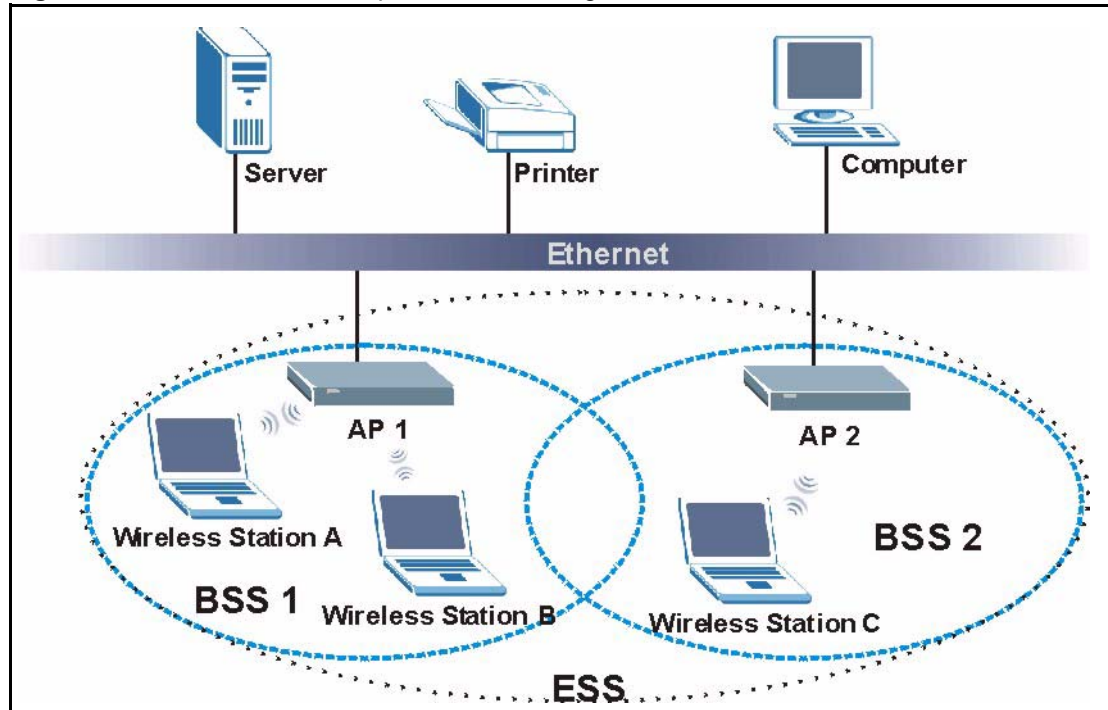
**Figure 84** ESS Provides Campus-Wide Coverage





# Appendix E

## Wireless LAN With IEEE 802.1x

As wireless networks become popular for both portable computing and corporate networks, security is now a priority.

### Security Flaws with IEEE 802.11

Wireless networks based on the original IEEE 802.11 have a poor reputation for safety. The IEEE 802.11b wireless access standard, first published in 1999, was based on the MAC address. As the MAC address is sent across the wireless link in clear text, it is easy to spoof and fake. Even the WEP (Wire Equivalent Privacy) data encryption is unreliable as it can be easily decrypted with current computer speed

### Deployment Issues with IEEE 802.11

User account management has become a network administrator's nightmare in a corporate environment, as the IEEE 802.11b standard does not provide any central user account management. User access control is done through manual modification of the MAC address table on the access point. Although WEP data encryption offers a form of data security, you have to reset the WEP key on the clients each time you change your WEP key on the access point.

### IEEE 802.1x

In June 2001, the IEEE 802.1x standard was designed to extend the features of IEEE 802.11 to support extended authentication as well as providing additional accounting and control features. It is supported by Windows XP and a number of network devices.

### Advantages of the IEEE 802.1x

- User based identification that allows for roaming.
- Support for RADIUS (Remote Authentication Dial In User Service, RFC 2138, 2139) for centralized user profile and accounting management on a network RADIUS server.
- Support for EAP (Extensible Authentication Protocol, RFC 2486) that allows additional authentication methods to be deployed with no changes to the access point or the wireless clients.

## RADIUS Server Authentication Sequence

The following figure depicts a typical wireless network with a remote RADIUS server for user authentication using EAPOL (EAP Over LAN).

**Figure 85** Sequences for EAP MD5–Challenge Authentication

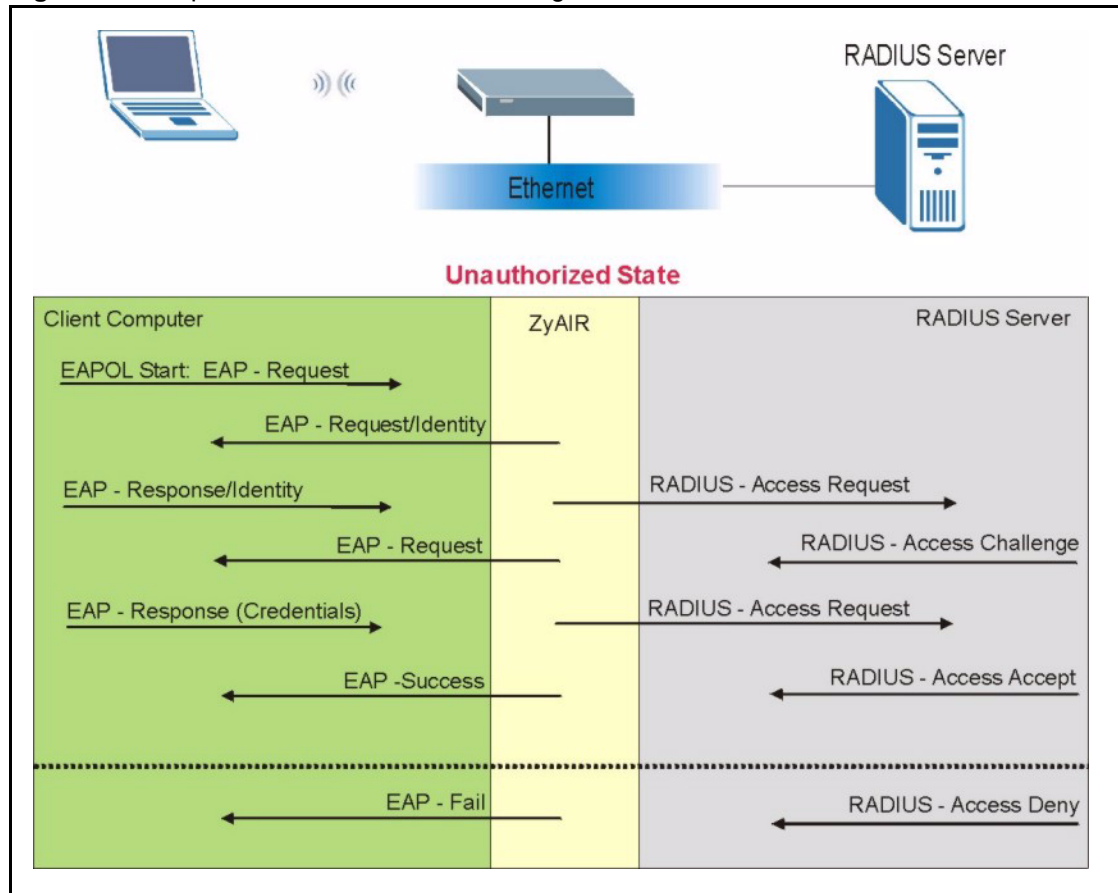

# Appendix F

## Types of EAP Authentication

This appendix discusses the five popular EAP authentication types: **EAP-MD5**, **EAP-TLS**, **EAP-TTLS**, **PEAP** and **LEAP**.

The type of authentication you use depends on the RADIUS server or the AP. Consult your network administrator for more information.

### EAP-MD5 (Message-Digest Algorithm 5)

MD5 authentication is the simplest one-way authentication method. The authentication server sends a challenge to the wireless station. The wireless station 'proves' that it knows the password by encrypting the password with the challenge and sends back the information. Password is not sent in plain text.

However, MD5 authentication has some weaknesses. Since the authentication server needs to get the plaintext passwords, the passwords must be stored. Thus someone other than the authentication server may access the password file. In addition, it is possible to impersonate an authentication server as MD5 authentication method does not perform mutual authentication. Finally, MD5 authentication method does not support data encryption with dynamic session key. You must configure WEP encryption keys for data encryption.

### EAP-TLS (Transport Layer Security)

With EAP-TLS, digital certifications are needed by both the server and the wireless stations for mutual authentication. The server presents a certificate to the client. After validating the identity of the server, the client sends a different certificate to the server. The exchange of certificates is done in the open before a secured tunnel is created. This makes user identity vulnerable to passive attacks. A digital certificate is an electronic ID card that authenticates the sender's identity. However, to implement EAP-TLS, you need a Certificate Authority (CA) to handle certificates, which imposes a management overhead.

### EAP-TTLS (Tunneled Transport Layer Service)

EAP-TTLS is an extension of the EAP-TLS authentication that uses certificates for only the server-side authentications to establish a secure connection. Client authentication is then done by sending username and password through the secure connection, thus client identity is protected. For client authentication, EAP-TTLS supports EAP methods and legacy authentication methods such as PAP, CHAP, MS-CHAP and MS-CHAP v2.

## PEAP (Protected EAP)

Like EAP-TTLS, server-side certificate authentication is used to establish a secure connection, then use simple username and password methods through the secured connection to authenticate the clients, thus hiding client identity. However, PEAP only supports EAP methods, such as EAP-MD5, EAP-MSCHAPv2 and EAP-GTC (EAP-Generic Token Card), for client authentication. EAP-GTC is implemented only by Cisco.

**Table 49** Comparison of EAP Authentication Types

	<b>EAP-MD5</b>	<b>EAP-TLS</b>	<b>EAP-TTLS</b>	<b>PEAP</b>
Mutual Authentication	No	Yes	Yes	Yes
Certificate – Client	No	Yes	Optional	Optional
Certificate – Server	No	Yes	Yes	Yes
Dynamic Key Exchange	No	Yes	Yes	Yes
Credential Integrity	None	Strong	Strong	Strong
Deployment Difficulty	Easy	Hard	Moderate	Moderate
Client Identity Protection	No	No	Yes	Yes

# Appendix G

## Antenna Selection and Positioning Recommendation

An antenna couples RF signals onto air. A transmitter within a wireless device sends an RF signal to the antenna, which propagates the signal through the air. The antenna also operates in reverse by capturing RF signals from the air.

Choosing the right antennas and positioning them properly increases the range and coverage area of a wireless LAN.

### Antenna Characteristics

#### Frequency

An antenna in the frequency of 2.4GHz (IEEE 802.11b) or 5GHz(IEEE 802.11a) is needed to communicate efficiently in a wireless LAN.

#### Radiation Pattern

A radiation pattern is a diagram that allows you to visualize the shape of the antenna's coverage area.

#### Antenna Gain

Antenna gain, measured in dB (decibel), is the increase in coverage within the RF beam width. Higher antenna gain improves the range of the signal for better communications.

For an indoor site, each 1 dB increase in antenna gain results in a range increase of approximately 2.5%. For an unobstructed outdoor site, each 1dB increase in gain results in a range increase of approximately 5%. Actual results may vary depending on the network environment.

Antenna gain is sometimes specified in dBi, which is how much the antenna increases the signal power compared to using an isotropic antenna. An isotropic antenna is a theoretical perfect antenna that sends out radio signals equally well in all directions. dBi represents the true gain that the antenna provides.

### Types of Antennas For WLAN

There are two types of antennas used for wireless LAN applications.

- Omni-directional antennas send the RF signal out in all directions on a horizontal plane. The coverage area is torus-shaped (like a donut) which makes these antennas ideal for a room environment. With a wide coverage area, it is possible to make circular overlapping coverage areas with multiple access points.
- Directional antennas concentrate the RF signal in a beam, like a flashlight. The angle of the beam width determines the direction of the coverage pattern; typically ranges from 20 degrees (less directional) to 90 degrees (very directional). The directional antennas are ideal for hallways and outdoor point-to-point applications.

## Positioning Antennas

In general, antennas should be mounted as high as practically possible and free of obstructions. In point-to-point application, position both transmitting and receiving antenna at the same height and in a direct line of sight to each other to attend the best performance.

For omni-directional antennas mounted on a table, desk, and so on, point the antenna up. For omni-directional antennas mounted on a wall or ceiling, point the antenna down. For a single AP application, place omni-directional antennas as close to the center of the coverage area as possible.

For directional antennas, point the antenna in the direction of the desired coverage area.

# Appendix H

## Open Software Announcements

Information herein is subject to change without notice. Companies, names, and data used in examples herein are fictitious unless otherwise noted. No part may be reproduced or transmitted in any form or by any means, electronic or mechanical, for any purpose, except the express written permission of ZyXEL Communications Corporation.

### This Product includes Zlib under Zlib License

#### Zlib License

```
/* zlib.h -- interface of the 'zlib' general purpose compression library version 1.2.2, October 3rd, 2004
Copyright (C) 1995-2004 Jean-loup Gailly and Mark Adler
This software is provided 'as-is', without any express or implied warranty. In no event will the authors
be held liable for any damages arising from the use of this software.
Permission is granted to anyone to use this software for any purpose, including commercial
applications, and to alter it and redistribute it freely, subject to the following restrictions:
```

1. The origin of this software must not be misrepresented; you must not claim that you wrote the original software. If you use this software in a product, an acknowledgment in the product documentation would be appreciated but is not required.
2. Altered source versions must be plainly marked as such, and must not be misrepresented as being the original software.
3. This notice may not be removed or altered from any source distribution.

Jean-loup Gailly [jloup@gzip.org](mailto:jloup@gzip.org)

Mark Adler [madler@alumni.caltech.edu](mailto:madler@alumni.caltech.edu)

### ZLIB is third party library and has its own license.

```
files under src/acdk/vfile/zlib are published under following Copyright and license:
zlib.h -- interface of the 'zlib' general purpose compression library version 1.1.3, July 9th, 1998
Copyright (C) 1995-1998 Jean-loup Gailly and Mark Adler
This software is provided 'as-is', without any express or implied warranty. In no event will the authors
be held liable for any damages arising from the use of this software.
Permission is granted to anyone to use this software for any purpose, including commercial
applications, and to alter it and redistribute it freely, subject to the following restrictions:
```

1. The origin of this software must not be misrepresented; you must not claim that you wrote the original software. If you use this software in a product, an acknowledgment in the product documentation would be appreciated but is not required.
2. Altered source versions must be plainly marked as such, and must not be misrepresented as being the original software.
3. This notice may not be removed or altered from any source distribution.

Jean-loup Gailly

Mark Adler

[jloup@gzip.org](mailto:jloup@gzip.org)

[madler@alumni.caltech.edu](mailto:madler@alumni.caltech.edu)



The data format used by the zlib library is described by RFCs (Request for Comments) 1950 to 1952 in the files [ftp://ds.internic.net/rfc/rfc1950.txt](http://ds.internic.net/rfc/rfc1950.txt) (zlib format), rfc1951.txt (deflate format) and rfc1952.txt (gzip format).

## **This product includes pppd(includes radius) under BSD License, RSA Data Security, Inc. License and Roaring Penguin Software under GPL License**

### **BSD**

Copyright (c) [dates as appropriate to package]

The Regents of the University of California. All rights reserved. Redistribution and use in source and binary forms, with or without modification, are permitted provided that the following conditions are met:

Redistributions of source code must retain the above copyright notice, this list of conditions and the following disclaimer.

Redistributions in binary form must reproduce the above copyright notice, this list of conditions and the following disclaimer in the documentation and/or other materials provided with the distribution.

All advertising materials mentioning features or use of this software must display the following acknowledgement:

This product includes software developed by the Computer Systems Engineering Group at Lawrence Berkeley Laboratory.

Neither the name of the University nor of the Laboratory may be used to endorse or promote products derived from this software without specific prior written permission.

THIS SOFTWARE IS PROVIDED BY THE REGENTS AND CONTRIBUTORS "AS IS" AND ANY EXPRESS OR IMPLIED WARRANTIES, INCLUDING, BUT NOT LIMITED TO, THE IMPLIED WARRANTIES OF MERCHANTABILITY AND FITNESS FOR A PARTICULAR PURPOSE ARE DISCLAIMED. IN NO EVENT SHALL THE REGENTS OR CONTRIBUTORS BE LIABLE FOR ANY DIRECT, INDIRECT, INCIDENTAL, SPECIAL, EXEMPLARY, OR CONSEQUENTIAL DAMAGES (INCLUDING, BUT NOT LIMITED TO, PROCUREMENT OF SUBSTITUTE GOODS OR SERVICES; LOSS OF USE, DATA, OR PROFITS; OR BUSINESS INTERRUPTION) HOWEVER CAUSED AND ON ANY THEORY OF LIABILITY, WHETHER IN CONTRACT, STRICT LIABILITY, OR TORT (INCLUDING NEGLIGENCE OR OTHERWISE) ARISING IN ANY WAY OUT OF THE USE OF THIS SOFTWARE, EVEN IF ADVISED OF THE POSSIBILITY OF SUCH DAMAGE.

## RSA Data Security, Inc License

NOTE: Numerous changes have been made; the following notice is included to satisfy legal requirements.

Copyright (C) 1991-2, RSA Data Security, Inc. Created 1991. All rights reserved.

License to copy and use this software is granted provided that it is identified as the "RSA Data Security, Inc. MD5 Message-Digest Algorithm" in all material mentioning or referencing this software or this function. License is also granted to make and use derivative works provided that such works are identified as "derived from the RSA Data Security, Inc. MD5 Message-Digest Algorithm" in all material mentioning or referencing the derived work.

RSA Data Security, Inc. makes no representations concerning either the merchantability of this software or the suitability of this software for any particular purpose. It is provided "as is" without express or implied warranty of any kind.

These notices must be retained in any copies of any part of this documentation and/or software.

**This product include brctl, shell commands, hwclock, dnrd, gmp, iptables, Awk, MTD, ntpclient, pppd , pptp, udhcpd/ udhcpc, updated, libupnp/pseudo ICS, iwpriv, gcc, linux(kernal) and tiny under GPL License.**

## GNU GENERAL PUBLIC LICENSE

Version 2, June 1991

Copyright (C) 1989, 1991 Free Software Foundation, Inc.

59 Temple Place - Suite 330, Boston, MA 02111-1307, USA

Everyone is permitted to copy and distribute verbatim copies of this license document, but changing it is not allowed.

Preamble

The licenses for most software are designed to take away your freedom to share and change it. By contrast, the GNU General Public License is intended to guarantee your freedom to share and change free software--to make sure the software is free for all its users. This General Public License applies to most of the Free Software Foundation's software and to any other program whose authors commit to using it. (Some other Free Software Foundation software is covered by the GNU Library General Public License instead.) You can apply it to your programs, too.

When we speak of free software, we are referring to freedom, not price. Our General Public Licenses are designed to make sure that you have the freedom to distribute copies of free software (and charge for this service if you wish), that you receive source code or can get it if you want it, that you can change the software or use pieces of it in new free programs; and that you know you can do these things.

To protect your rights, we need to make restrictions that forbid anyone to deny you these rights or to ask you to surrender the rights. These restrictions translate to certain responsibilities for you if you distribute copies of the software, or if you modify it. For example, if you distribute copies of such a program, whether gratis or for a fee, you must give the recipients all the rights that you have. You must make sure that they, too, receive or can get the source code. And you must show them these terms so they know their rights.

We protect your rights with two steps: (1) copyright the software, and (2) offer you this license which gives you legal permission to copy, distribute and/or modify the software. Also, for each author's protection and ours, we want to make certain that everyone understands that there is no warranty for this free software. If the software is modified by someone else and passed on, we want its recipients to know that what they have is not the original, so that any problems introduced by others will not reflect on the original authors' reputations.

Finally, any free program is threatened constantly by software patents. We wish to avoid the danger that redistributors of a free program will individually obtain patent licenses, in effect making the program proprietary. To prevent this, we have made it clear that any patent must be licensed for everyone's free use or not licensed at all.

The precise terms and conditions for copying, distribution and modification follow.

#### TERMS AND CONDITIONS FOR COPYING, DISTRIBUTION AND MODIFICATION

0. This License applies to any program or other work which contains a notice placed by the copyright holder saying it may be distributed under the terms of this General Public License. The "Program", below, refers to any such program or work, and a "work based on the Program" means either the Program or any derivative work under copyright law: that is to say, a work containing the Program or a portion of it, either verbatim or with modifications and/or translated into another language. (Hereinafter, translation is included without limitation in the term "modification".) Each licensee is addressed as "you". Activities other than copying, distribution and modification are not covered by this License; they are outside its scope. The act of running the Program is not restricted, and the output from the Program is covered only if its contents constitute a work based on the Program (independent of having been made by running the Program). Whether that is true depends on what the Program does.

1. You may copy and distribute verbatim copies of the Program's source code as you receive it, in any medium, provided that you conspicuously and appropriately publish on each copy an appropriate copyright notice and disclaimer of warranty; keep intact all the notices that refer to this License and to the absence of any warranty; and give any other recipients of the Program a copy of this License along with the Program. You may charge a fee for the physical act of transferring a copy, and you may at your option offer warranty protection in exchange for a fee.

2. You may modify your copy or copies of the Program or any portion of it, thus forming a work based on the Program, and copy and distribute such modifications or work under the terms of Section 1 above, provided that you also meet all of these conditions:

a.) You must cause the modified files to carry prominent notices stating that you changed the files and the date of any change.

b.) You must cause any work that you distribute or publish, that in whole or in part contains or is derived from the Program or any part thereof, to be licensed as a whole at no charge to all third parties under the terms of this License.

c.) If the modified program normally reads commands interactively when run, you must cause it, when started running for such interactive use in the most ordinary way, to print or display an announcement including an appropriate copyright notice and a notice that there is no warranty (or else, saying that you provide a warranty) and that users may redistribute the program under these conditions, and telling the user how to view a copy of this License. (Exception: if the Program itself is interactive but does not normally print such an announcement, your work based on the Program is not required to print an announcement.)

These requirements apply to the modified work as a whole. If identifiable sections of that work are not derived from the Program, and can be reasonably considered independent and separate works in themselves, then this License, and its terms, do not apply to those sections when you distribute them as separate works. But when you distribute the same sections as part of a whole which is a work based on the Program, the distribution of the whole must be on the terms of this License, whose permissions for other licensees extend to the entire whole, and thus to each and every part regardless of who wrote it. Thus, it is not the intent of this section to claim rights or contest your rights to work written entirely by you; rather, the intent is to exercise the right to control the distribution of derivative or collective works based on the Program. In addition, mere aggregation of another work not based on the Program with the Program (or with a work based on the Program) on a volume of a storage or distribution medium does not bring the other work under the scope of this License.

3. You may copy and distribute the Program (or a work based on it, under Section 2) in object code or executable form under the terms of Sections 1 and 2 above provided that you also do one of the following:

a.) Accompany it with the complete corresponding machine-readable source code, which must be distributed under the terms of Sections 1 and 2 above on a medium customarily used for software interchange; or,

b.) Accompany it with a written offer, valid for at least three years, to give any third party, for a charge no more than your cost of physically performing source distribution, a complete machine-readable copy of the corresponding source code, to be distributed under the terms of Sections 1 and 2 above on a medium customarily used for software interchange; or, c) Accompany it with the information you received as to the offer to distribute corresponding source code. (This alternative is allowed only for noncommercial distribution and only if you received the program in object code or executable form with such an offer, in accord with Subsection b above.) The source code for a work means the preferred form of the work for making modifications to it. For an executable work, complete source code means all the source code for all modules it contains, plus any associated interface definition files, plus the

scripts used to control compilation and installation of the executable. However, as a special exception, the source code distributed need not include anything that is normally distributed (in either source or binary form) with the major components (compiler, kernel, and so on) of the operating system on which the executable runs, unless that component itself accompanies the executable. If distribution of executable or object code is made by offering access to copy from a designated place, then offering equivalent access to copy the source code from the same place counts as distribution of the source code, even though third parties are not compelled to copy the source along with the object code.

4. You may not copy, modify, sublicense, or distribute the Program except as expressly provided under this License. Any attempt otherwise to copy, modify, sublicense or distribute the Program is void, and will automatically terminate your rights under this License. However, parties who have received copies, or rights, from you under this License will not have their licenses terminated so long as such parties remain in full compliance.

5. You are not required to accept this License, since you have not signed it. However, nothing else grants you permission to modify or distribute the Program or its derivative works. These actions are prohibited by law if you do not accept this License. Therefore, by modifying or distributing the Program (or any work based on the Program), you indicate your acceptance of this License to do so, and all its terms and conditions for copying, distributing or modifying the Program or works based on it.

6. Each time you redistribute the Program (or any work based on the Program), the recipient automatically receives a license from the original licensor to copy, distribute or modify the Program subject to these terms and conditions. You may not impose any further restrictions on the recipients' exercise of the rights granted herein. You are not responsible for enforcing compliance by third parties to this License.

7. If, as a consequence of a court judgment or allegation of patent infringement or for any other reason (not limited to patent issues), conditions are imposed on you (whether by court order, agreement or otherwise) that contradict the conditions of this License, they do not excuse you from the conditions of this License. If you cannot distribute so as to satisfy simultaneously your obligations under this License and any other pertinent obligations, then as a consequence you may not distribute the Program at all. For example, if a patent license would not permit royalty-free redistribution of the Program by all those who receive copies directly or indirectly through you, then the only way you could satisfy both it and this License would be to refrain entirely from distribution of the Program. If any portion of this section is held invalid or unenforceable under any particular circumstance, the balance of the section is intended to apply and the section as a whole is intended to apply in other circumstances. It is not the purpose of this section to induce you to infringe any patents or other property right claims or to contest validity of any such claims; this section has the sole purpose of protecting the integrity of the free software distribution system, which is implemented by public license practices. Many people have made generous contributions to the wide range of software distributed through that system in reliance on consistent application of that system; it is up to the author/donor to decide if he or she is willing to distribute software through any other system and a licensee cannot impose that choice. This section is intended to make thoroughly clear what is believed to be a consequence of the rest of this License.

8. If the distribution and/or use of the Program is restricted in certain countries either by patents or by copyrighted interfaces, the original copyright holder who places the Program under this License may add an explicit geographical distribution limitation excluding those countries, so that distribution is permitted only in or among countries not thus excluded. In such case, this License incorporates the limitation as if written in the body of this License.

9. The Free Software Foundation may publish revised and/or new versions of the General Public License from time to time. Such new versions will be similar in spirit to the present version, but may differ in detail to address new problems or concerns. Each version is given a distinguishing version number. If the Program specifies a version number of this License which applies to it and "any later version", you have the option of following the terms and conditions either of that version or of any later version published by the Free Software Foundation. If the Program does not specify a version number of this License, you may choose any version ever published by the Free Software Foundation.

10. If you wish to incorporate parts of the Program into other free programs whose distribution conditions are different, write to the author to ask for permission. For software which is copyrighted by the Free Software Foundation, write to the Free Software Foundation; we sometimes make exceptions for this. Our decision will be guided by the two goals of preserving the free status of all derivatives of our free software and of promoting the sharing and reuse of software generally.

#### NO WARRANTY

11. BECAUSE THE PROGRAM IS LICENSED FREE OF CHARGE, THERE IS NO WARRANTY FOR THE PROGRAM, TO THE EXTENT PERMITTED BY APPLICABLE LAW. EXCEPT WHEN OTHERWISE STATED IN WRITING THE COPYRIGHT HOLDERS AND/OR OTHER PARTIES PROVIDE THE PROGRAM "AS IS" WITHOUT WARRANTY OF ANY KIND, EITHER EXPRESSED OR IMPLIED, INCLUDING, BUT NOT LIMITED TO, THE IMPLIED WARRANTIES OF MERCHANTABILITY AND FITNESS FOR A PARTICULAR PURPOSE. THE ENTIRE RISK AS TO THE QUALITY AND PERFORMANCE OF THE PROGRAM IS WITH YOU. SHOULD THE PROGRAM PROVE DEFECTIVE, YOU ASSUME THE COST OF ALL NECESSARY SERVICING, REPAIR OR CORRECTION.

12. IN NO EVENT UNLESS REQUIRED BY APPLICABLE LAW OR AGREED TO IN WRITING WILL ANY COPYRIGHT HOLDER, OR ANY OTHER PARTY WHO MAY MODIFY AND/OR REDISTRIBUTE THE PROGRAM AS PERMITTED ABOVE, BE LIABLE TO YOU FOR DAMAGES, INCLUDING ANY GENERAL, SPECIAL, INCIDENTAL OR CONSEQUENTIAL DAMAGES ARISING OUT OF THE USE OR INABILITY TO USE THE PROGRAM (INCLUDING BUT NOT LIMITED TO LOSS OF DATA OR DATA BEING RENDERED INACCURATE OR LOSSES SUSTAINED BY YOU OR THIRD PARTIES OR A FAILURE OF THE PROGRAM TO OPERATE WITH ANY OTHER PROGRAMS), EVEN IF SUCH HOLDER OR OTHER PARTY HAS BEEN ADVISED OF THE POSSIBILITY OF SUCH DAMAGES. END OF TERMS AND CONDITIONS. All other trademarks or trade names mentioned herein, if any, are the property of their respective owners.

**NOTE:** Some components of the "P-330" software incorporate source code covered under the Zlib License; Roaring Penguin Software Inc. License; BSD License; RSA Data Security Inc. License and GPL License. To obtain the source code covered under those Licenses, please contact ZyXEL Communications Corporation at: [support@zyxel.com.tw](mailto:support@zyxel.com.tw)

## End-User License Agreement for “P-330W “

**WARNING:** ZyXEL Communications Corp. IS WILLING TO LICENSE THE ENCLOSED SOFTWARE TO YOU ONLY UPON THE CONDITION THAT YOU ACCEPT ALL OF THE TERMS CONTAINED IN THIS LICENSE AGREEMENT. PLEASE READ THE TERMS CAREFULLY BEFORE COMPLETING THE INSTALLATION PROCESS AS INSTALLING THE SOFTWARE WILL INDICATE YOUR ASSENT TO THEM. IF YOU DO NOT AGREE TO THESE TERMS, THEN ZyXEL, INC. IS UNWILLING TO LICENSE THE SOFTWARE TO YOU, IN WHICH EVENT YOU SHOULD RETURN THE UNINSTALLED SOFTWARE AND PACKAGING TO THE PLACE FROM WHICH IT WAS ACQUIRED, AND YOUR MONEY WILL BE REFUNDED.

### 1. Grant of License for Personal Use

ZyXEL Communications Corp. ("ZyXEL") grants you a non-exclusive, non-sublicense, non-transferable license to use the program with which this license is distributed (the "Software"), including any documentation files accompanying the Software ("Documentation"), for internal business use only, for up to the number of users specified in sales order and invoice. You have the right to make one backup copy of the Software and Documentation solely for archival, back-up or disaster recovery purposes. You shall not exceed the scope of the license granted hereunder. Any rights not expressly granted by ZyXEL to you are reserved by ZyXEL, and all implied licenses are disclaimed.

### 2. Ownership

You have no ownership rights in the Software. Rather, you have a license to use the Software as long as this License Agreement remains in full force and effect. Ownership of the Software, Documentation and all intellectual property rights therein shall remain at all times with ZyXEL. Any other use of the Software by any other entity is strictly forbidden and is a violation of this License Agreement.

### 3. Copyright

The Software and Documentation contain material that is protected by United States Copyright Law and trade secret law, and by international treaty provisions. All rights not granted to you herein are expressly reserved by ZyXEL. You may not remove any proprietary notice of ZyXEL or any of its licensors from any copy of the Software or Documentation.

### 4. Restrictions

You may not publish, display, disclose, sell, rent, lease, modify, store, loan, distribute, or create derivative works of the Software, or any part thereof. You may not assign, sublicense, convey or otherwise transfer, pledge as security or otherwise encumber the rights and licenses granted hereunder with respect to the Software. You may not copy, reverse engineer, decompile, reverse compile, translate, adapt, or disassemble the Software, or any part thereof, nor shall you attempt to create the source code from the object code for the Software. You

may not market, co-brand, private label or otherwise permit third parties to link to the Software, or any part thereof. You may not use the Software, or any part thereof, in the operation of a service bureau or for the benefit of any other person or entity. You may not cause, assist or permit any third party to do any of the foregoing.

#### 5. Confidentiality

You acknowledge that the Software contains proprietary trade secrets of ZyXEL and you hereby agree to maintain the confidentiality of the Software using at least as great a degree of care as you use to maintain the confidentiality of your own most confidential information. You agree to reasonably communicate the terms and conditions of this License Agreement to those persons employed by you who come into contact with the Software, and to use reasonable best efforts to ensure their compliance with such terms and conditions, including, without limitation, not knowingly permitting such persons to use any portion of the Software for the purpose of deriving the source code of the Software.

#### 6. No Warranty

THE SOFTWARE IS PROVIDED "AS IS." TO THE MAXIMUM EXTENT PERMITTED BY LAW, ZyXEL DISCLAIMS ALL WARRANTIES OF ANY KIND, EITHER EXPRESSED OR IMPLIED, INCLUDING, WITHOUT LIMITATION, IMPLIED WARRANTIES OF MERCHANTABILITY AND FITNESS FOR A PARTICULAR PURPOSE. ZyXEL DOES NOT WARRANT THAT THE FUNCTIONS CONTAINED IN THE SOFTWARE WILL MEET ANY REQUIREMENTS OR NEEDS YOU MAY HAVE, OR THAT THE SOFTWARE WILL OPERATE ERROR FREE, OR IN AN UNINTERRUPTED FASHION, OR THAT ANY DEFECTS OR ERRORS IN THE SOFTWARE WILL BE CORRECTED, OR THAT THE SOFTWARE IS COMPATIBLE WITH ANY PARTICULAR PLATFORM. SOME JURISDICTIONS DO NOT ALLOW THE WAIVER OR EXCLUSION OF IMPLIED WARRANTIES SO THEY MAY NOT APPLY TO YOU. IF THIS EXCLUSION IS HELD TO BE UNENFORCEABLE BY A COURT OF COMPETENT JURISDICTION, THEN ALL EXPRESS AND IMPLIED WARRANTIES SHALL BE LIMITED IN DURATION TO A PERIOD OF THIRTY (30) DAYS FROM THE DATE OF PURCHASE OF THE SOFTWARE, AND NO WARRANTIES SHALL APPLY AFTER THAT PERIOD.

#### 7. Limitation of Liability

IN NO EVENT WILL ZyXEL BE LIABLE TO YOU OR ANY THIRD PARTY FOR ANY INCIDENTAL OR CONSEQUENTIAL DAMAGES (INCLUDING, WITHOUT LIMITATION, INDIRECT, SPECIAL, PUNITIVE, OR EXEMPLARY DAMAGES FOR LOSS OF BUSINESS, LOSS OF PROFITS, BUSINESS INTERRUPTION, OR LOSS OF BUSINESS INFORMATION) ARISING OUT OF THE USE OF OR INABILITY TO USE THE PROGRAM, OR FOR ANY CLAIM BY ANY OTHER PARTY, EVEN IF ZyXEL HAS BEEN ADVISED OF THE POSSIBILITY OF SUCH DAMAGES. ZyXEL'S AGGREGATE LIABILITY WITH RESPECT TO ITS OBLIGATIONS UNDER THIS AGREEMENT OR OTHERWISE WITH RESPECT TO THE SOFTWARE AND DOCUMENTATION OR OTHERWISE SHALL BE EQUAL TO THE PURCHASE PRICE,



BUT SHALL IN NO EVENT EXCEED \$1,000. BECAUSE SOME STATES/COUNTRIES DO NOT ALLOW THE EXCLUSION OR LIMITATION OF LIABILITY FOR CONSEQUENTIAL OR INCIDENTAL DAMAGES, THE ABOVE LIMITATION MAY NOT APPLY TO YOU.

#### 8. Export Restrictions

THIS LICENSE AGREEMENT IS EXPRESSLY MADE SUBJECT TO ANY APPLICABLE LAWS, REGULATIONS, ORDERS, OR OTHER RESTRICTIONS ON THE EXPORT OF THE SOFTWARE OR INFORMATION ABOUT SUCH SOFTWARE WHICH MAY BE IMPOSED FROM TIME TO TIME. YOU SHALL NOT EXPORT THE SOFTWARE, DOCUMENTATION OR INFORMATION ABOUT THE SOFTWARE AND DOCUMENTATION WITHOUT COMPLYING WITH SUCH LAWS, REGULATIONS, ORDERS, OR OTHER RESTRICTIONS. YOU AGREE TO INDEMNIFY ZyXEL AGAINST ALL CLAIMS, LOSSES, DAMAGES, LIABILITIES, COSTS AND EXPENSES, INCLUDING REASONABLE ATTORNEYS' FEES, TO THE EXTENT SUCH CLAIMS ARISE OUT OF ANY BREACH OF THIS SECTION 8.

#### 9. Audit Rights

ZyXEL SHALL HAVE THE RIGHT, AT ITS OWN EXPENSE, UPON REASONABLE PRIOR NOTICE, TO PERIODICALLY INSPECT AND AUDIT YOUR RECORDS TO ENSURE YOUR COMPLIANCE WITH THE TERMS AND CONDITIONS OF THIS LICENSE AGREEMENT.

#### 10. Termination

This License Agreement is effective until it is terminated. You may terminate this License Agreement at any time by destroying or returning to ZyXEL all copies of the Software and Documentation in your possession or under your control. ZyXEL may terminate this License Agreement for any reason, including, but not limited to, if ZyXEL finds that you have violated any of the terms of this License Agreement. Upon notification of termination, you agree to destroy or return to ZyXEL all copies of the Software and Documentation and to certify in writing that all known copies, including backup copies, have been destroyed. All provisions relating to confidentiality, proprietary rights, and non-disclosure shall survive the termination of this Software License Agreement.

#### 11. General

This License Agreement shall be construed, interpreted and governed by the laws of Republic of China without regard to conflicts of laws provisions thereof. The exclusive forum for any disputes arising out of or relating to this License Agreement shall be an appropriate court or Commercial Arbitration Association sitting in ROC, Taiwan. This License Agreement shall constitute the entire Agreement between the parties hereto. This License Agreement, the rights granted hereunder, the Software and Documentation shall not be assigned by you without the prior written consent of ZyXEL. Any waiver or modification of this License

Agreement shall only be effective if it is in writing and signed by both parties hereto. If any part of this License Agreement is found invalid or unenforceable by a court of competent jurisdiction, the remainder of this License Agreement shall be interpreted so as to reasonably effect the intention of the parties.



# Index

## A

Antenna  
  Directional [127](#)  
  Omni-directional [127](#)  
Antenna gain [126](#)  
Authentication [51](#)

## B

Backup [91](#)  
Basic Service Set [119](#)  
BSS [46, 119](#)

## C

CA [124](#)  
Certificate Authority [124](#)  
Configuration [42](#)

## D

Data Encryption [56](#)  
Default [92](#)  
DHCP [42, 72](#)  
Direct Sequence Spread Spectrum [118](#)  
Distribution System [119](#)  
DMZ [73](#)  
Domain Name [74](#)  
DS [119](#)  
DSSS [118](#)  
Dynamic DNS [71, 72](#)

## E

EAP Authentication [63, 124](#)  
ECHO [74](#)  
Encryption [59](#)  
ESS [47, 119](#)  
Extended Service Set [47, 119](#)  
Extended Service Set IDentification [50](#)

## F

Factory LAN Defaults [42](#)  
FHSS [118](#)  
Finger [74](#)  
Firewall [21](#)  
Frequency-Hopping Spread Spectrum [118](#)  
FTP [42, 71, 73, 74](#)

## G

General Setup [40](#)

## H

Host [44](#)  
HTTP [74](#)

## I

IAPP [53](#)  
IBSS [46, 119](#)  
Independent Basic Service Set [46, 119](#)  
IP Address [42, 43](#)  
IP Pool Setup [42](#)

## L

L2TP Encapsulation [84](#)  
LAN TCP/IP [42](#)

## M

MAC Address Filtering [67](#)  
MAC Filter [67](#)

## N

NAT [74](#)  
Network Management [74](#)  
NNTP [74](#)

## P

Password [44](#)  
Point-to-Point Tunneling Protocol [74, 82](#)  
POP3 [74](#)  
Port Forwarding [73](#)  
Port Numbers [74](#)  
PPPoE [100](#)  
PPTP [74](#)  
Preamble Mode [52](#)

## R

RADIUS [62](#)  
Related Documentation [18](#)  
Restore [91](#)  
RF signals [118](#)  
RTS Threshold [48](#)

## S

Security Parameters [56](#)  
Service Set [50](#)  
Services [74](#)

SMTP [74](#)  
SNMP [74](#)  
SUA [74](#)  
Subnet Mask [42, 43](#)  
Syntax Conventions [18](#)

## U

User Authentication [59](#)  
User Name [72](#)

## V

Virtual Servers [73](#)  
VPN [82, 84](#)

## W

WEP [56](#)  
WEP Encryption [57, 58, 61](#)  
Wireless LAN [118](#)  
Wireless Security [53](#)  
WLAN [118](#)  
WPA [59](#)  
WPA with RADIUS Application [63](#)  
WPA2 [60](#)  
WPA-PSK Application [60](#)