

NETGEAR®

WiFi DSL Modem Router

Model D6200

User Manual



September 2014
202-11171-05

350 East Plumeria Drive
San Jose, CA 95134
USA

Support

Thank you for selecting NETGEAR products.

After installing your device, locate the serial number on the label of your product and use it to register your product at <https://my.netgear.com>. You must register your product before you can use NETGEAR telephone support. NETGEAR recommends registering your product through the NETGEAR website. For product updates and web support, visit <http://support.netgear.com>.

Phone (US & Canada only): 1-888-NETGEAR.

Phone (Other Countries): Check the list of phone numbers at <http://support.netgear.com/general/contact/default.aspx>.

Compliance

For regulatory compliance information, visit <http://www.netgear.com/about/regulatory>.

See the regulatory compliance document before connecting the power supply.

Trademarks

NETGEAR, the NETGEAR logo, and Connect with Innovation are trademarks and/or registered trademarks of NETGEAR, Inc. and/or its subsidiaries in the United States and/or other countries. Information is subject to change without notice.

© NETGEAR All rights reserved.

Contents

Chapter 1 Hardware Setup

Product Highlights	8
Product Specifications	9
Unpack Your New Router	11
Hardware Features	12
Label	12
Back Panel	13
Front Panel	14
Side Panel	16
Position Your Wireless Router	17
ADSL Microfilters	18
One-Line ADSL Microfilter (Not Included)	18
Two-Line ADSL Microfilter (Included)	18
Summary	19
Cable Your D6200 WiFi DSL Modem Router	19
Verify the Cabling	20

Chapter 2 Get Started with NETGEAR genie

Prepare to Set Up the WiFi DSL Modem Router	22
Use Standard TCP/IP Properties for DHCP	22
Gather ISP Information	22
Wireless Devices and Security Settings	22
Types of Logins and Access	22
NETGEAR genie Setup	23
Use NETGEAR genie after Installation	24
Upgrade WiFi DSL Modem Router Firmware	24
WiFi DSL Modem Router Dashboard (BASIC Home Screen)	25
Add Wireless Devices or Computers to Your Network	26
Manual Method	26
Wi-Fi Protected Setup (WPS) Method	26

Chapter 3 NETGEAR genie BASIC Settings

Internet Basic Settings	29
Internet Setup Screen Fields	29
Attached Devices	31
Parental Controls	32
Basic Wireless Settings	32
Wireless Settings Screen Fields	33
Wireless Security Options	35

Change WPA Security Option and Passphrase	35
Guest Networks	36
NETGEAR genie App	37

Chapter 4 NETGEAR genie ADVANCED Home

Setup Wizard	40
WPS Wizard	42
VPN Wizard	43
Setup Menu	45
ADSL Setup	46
WAN Setup	47
Default DMZ Server	48
Change the MTU Size	48
LAN Setup	50
LAN Setup Screen Settings	51
Use the WiFi DSL Modem Router as a DHCP Server	52
Address Reservation	53
Quality of Service Setup	54
Add a Priority Rule	55
Priority Policies for Applications and Online Games	56
Priority Policies for Ethernet LAN Ports	57
Priority Policies for MAC Addresses	57

Chapter 5 USB Storage

USB Drive Requirements	59
ReadySHARE Access	59
File-Sharing Scenarios	60
USB Storage Basic Settings	62
Add or Edit a Network Folder	63
USB Storage Advanced Settings	64
Media Server Settings	66
Specify Approved USB Devices	67
Connect to the USB Drive from a Remote Computer	68
Access the WiFi DSL Modem Router USB Drive Remotely Using FTP	68
Safely Remove a USB Drive	68

Chapter 6 ReadySHARE Printer

Download the ReadySHARE Printer Utility	71
Install the NETGEAR USB Control Center	72
Set Up the NETGEAR USB Control Center	73
Configure the NETGEAR USB Control Center	75
Manage USB Print and Scan Jobs	77
The NETGEAR USB Control Center	77
Use the Scan Feature of a Multifunction USB Printer	78

Chapter 7 Security

Keyword Blocking of HTTP Traffic	81
Firewall Rules	82
Add Custom Services to Allow or Block	85
Schedule for Firewall Rules	86
Security Event Email Notifications	87

Chapter 8 Administration

Upgrade the WiFi DSL Modem Router Firmware	90
View WiFi DSL Modem Router Status	91
Reboot the Router	93
Connection Statistics	93
Connection Status	94
View VPN Status	95
View Logs of Web Access or Attempted Web Access	96
Manage the Configuration File	97
Back Up Settings	97
Restore Configuration Settings	98
Erase	98
Set Password	98
Diagnostics	100

Chapter 9 Advanced Settings

Advanced Wireless Settings	103
Turn Off Radio By Schedule	104
WPS Settings	104
Wireless Access List	105
Wireless Repeating Function (WDS)	107
Wireless Repeating Function	108
Set Up the Base Station	109
Set Up a Repeater Unit	110
Port Forwarding and Port Triggering	110
Remote Computer Access Basics	111
Port Triggering to Open Incoming Ports	112
Port Forwarding to Permit External Host Communications	113
How Port Forwarding Differs from Port Triggering	114
Set Up Port Forwarding to Local Servers	114
Add a Custom Service	116
Edit or Delete a Port Forwarding Entry	117
Application Example: Making a Local Web Server Public	117
Set Up Port Triggering	118
Dynamic DNS	120
Static Routes	121
Remote Management	124
Universal Plug and Play	126
IPv6	127

Traffic Meter	128
Device Mode	130
VPN Policies	130
Add or Edit an Auto VPN Policy	132
Add or Edit a Manual VPN Policy	135

Chapter 10 Troubleshooting

Quick Tips	139
Sequence to Restart Your Network	139
Check Ethernet Cable Connections	139
Wireless Settings	139
Network Settings	139
Troubleshoot with the LEDs	140
Power LED Is Off or Blinking	140
Power LED Stays Red	140
LEDs Never Turn Off	141
Internet or Ethernet Port LEDs Are Off	141
Wireless LED Is Off	141
The Push 'N' Connect (WPS) Button Does Not Work	141
Cannot Log In to the Router	142
Cannot Access the Internet	142
Troubleshoot PPPoE	144
Troubleshoot Internet Browsing	144
Changes Not Saved	145
Incorrect Date or Time	145
Wireless Connectivity	145
Restore the Factory Settings and Password	146
Troubleshoot Your Network Using the Ping Utility	146
Test the LAN Path to Your Router	146
Test the Path from Your Computer to a Remote Device	147

Appendix A Supplemental Information

Factory Settings	150
Technical Specifications	151

Index

Hardware Setup

1

Get to know your wireless router

The NETGEAR D6200 WiFi DSL Modem Router offers next generation 802.11ac WiFi with wireless speeds of up to 300+867 Mbps¹ needed for demanding applications, such as large file transfers, streaming HD video, and multiplayer gaming. Complete with a built-in DSL modem, it is compatible with all major DSL Internet service providers. Simultaneous dual-band technology runs both 2.4 GHz and 5 GHz bands at the same time, ensuring top speeds and the greatest range, while Gigabit offers ultrafast wired connections. The unit supports a wide range of premium features and applications such as, ReadySHARE Printer, and NETGEAR genie.

The WiFi DSL modem router automatically uses NETGEAR Beamforming+ technology to enhance WiFi performance. Because it's automatic, you don't have to turn on Beamforming+ or configure it. When you connect to the WiFi network, Beamforming+ focuses on your location for even better WiFi performance and speed. Beamforming+ locks onto your laptop, tablet, or smartphone, and follows as you move from place to place, so you keep your optimal WiFi connection.

This chapter contains the following sections:

- *Product Highlights*
- *Product Specifications*
- *Unpack Your New Router*
- *Hardware Features*
- *Position Your Wireless Router*
- *ADSL Microfilters*
- *Cable Your D6200 WiFi DSL Modem Router*
- *Verify the Cabling*

For more information about the topics covered in this manual, visit the support website at <http://support.netgear.com/general/contact/default.aspx>.

1. Maximum wireless signal rate derived from draft IEEE 802.11ac specifications, and final IEEE 802.11ac specifications may be different. Actual data throughput will likely be lower, and depends on network and environmental conditions, including volume of network traffic and building construction. 802.11ac 867 Mbps is approximately 3x faster than 802.11n 300 Mbps.

Product Highlights

The modem router has the following capabilities:

- **Next Generation 802.11ac WiFi.** Speeds up to 300+867 Mbps for whole home HD coverage. Backward compatible with 802.11a/b/g/n WiFi devices.
- **All-in-one.** Built-in ADSL2+ modem and WAN Gigabit Ethernet port for cable or fiber combined with a wireless router create an integrated home gateway.
- **ReadySHARE Printer.** Wirelessly print from your Mac or Windows computer to a connected USB printer. Also make any printer Aiprint compatible to print from iPad or iPhone.
- **ReadySHARE USB.** Wirelessly share a USB hard drive with Mac and Windows computers.
- **Faster multimedia streaming.** Provides up to 450 Mbps wireless speed for streaming HD videos, simultaneous downloads, and online gaming in addition to basic Internet applications.
- **Advanced QoS.** Helps prioritize media streaming and gaming applications for best entertainment experience.
- **Simultaneous dual band.** Runs both 2.4 GHz and 5 GHz bands concurrently, ensuring top speeds and the greatest range while minimizing interference.
- **NETGEAR genie.** Easy setup and dashboard control to manage, monitor, and repair home networks.
- **Ultrafast wired.** Four Gigabit Ethernet ports deliver ultrafast wired connections for gaming and video.
- **Live Parental Controls.** Keeps your Internet experience safe using flexible and customizable filter settings.
- **Guest network access.** Provides separate security and access restrictions for guests using the network.
- **Broadband usage meter.** Monitors Internet traffic and sends customized reports to help keep costs under control.
- **Secured connection.** Push 'N' Connect ensures a quick and secure network connection.
- **NETGEAR green features.** Use Power and WiFi On/Off buttons, and schedule WiFi to turn on and off to save energy when not in use.
- **Compatibility.** Works with all major ADSL Internet service providers (ISPs).

Product Specifications

Package Contents

- D6200 WiFi DSL Modem Router.
- Ethernet cable.
- Phone cable.
- ADSL2+ filter.
- Quick install guide.
- Power adapter.

Technical Specifications

- WiFi Boost with high-powered radio amplifiers.
- Memory: 128 MB flash and 128 MB RAM.
- Advanced Quality of Service (QoS).
- IPv6 Support (Internet Protocol Version 6).

Security

- Wi-Fi Protected Access (WPA/WPA2-PSK).
- Double firewall protection (SPI and NAT firewall).
- Denial-of-service (DoS) attack prevention.

Standards

- One (1) USB 2.0 port.
- One (1) ADSL2+ port.
- IEEE 802.11 b/g/n 2.4 GHz.
- IEEE 802.11 a/n/ac 5.0 GHz.
- Five (5) 10/100/1000 (1 WAN and 4 LAN) Gigabit Ethernet ports with auto-sensing technology.

System Requirements

- Broadband Internet service.
 - ADSL2+ Broadband Internet Service.
 - Cable or Fiber. Connects to cable modem via Gigabit Ethernet WAN port.
- Microsoft Windows 7, 8, Vista, XP, 2000, Mac OS, UNIX, or Linux.
- Microsoft Internet Explorer 5.0, Firefox 2.0, Safari 1.4, or Google Chrome 11.0 browsers or higher.
- Use laptop with 2x2 300 Mbps adapter like Centrino 6205/6235, or 2x2 802.11ac adapter for maximum performance.

Physical Specifications

- Dimensions. 205 x 255 x 77 mm (8.07 x 10.04 x 3.03 in.).

- Weight. 654g (1.44 lb.).

Ease Of Use

- NETGEAR genie App. Personal dashboard to monitor, control, and repair your home network.
- Push 'N' Connect using Wi-Fi Protected Setup (WPS).

Warranty

- Warranty localized to country of sale.

NETGEAR Green Features

- Power On/Off button
- Wireless On/Off button
- 80% recycled packaging
- CEC (California Efficiency)
- RoHS
- WEEE

If you did not set up your new modem router already using the installation guide that comes in the box, this chapter walks you through the hardware setup. [Chapter 3, NETGEAR genie BASIC Settings](#), explains how to set up your Internet connection.

Unpack Your New Router

Your box contains the following items:

- D6200 WiFi DSL Modem Router
- AC power adapter (plug varies by region)
- Category 5 (Cat 5) Ethernet cable
- Telephone cable with RJ-11 connector
- Microfilters and splitters (quantity and type vary by region)
- Installation guide with cabling and router setup instructions

If any of the parts are incorrect, missing, or damaged, contact your NETGEAR dealer. Keep the carton, including the original packing materials, in case you need to return the product for repair. For information about where to place and how to position your router, see [Position Your Wireless Router](#) on page 17.

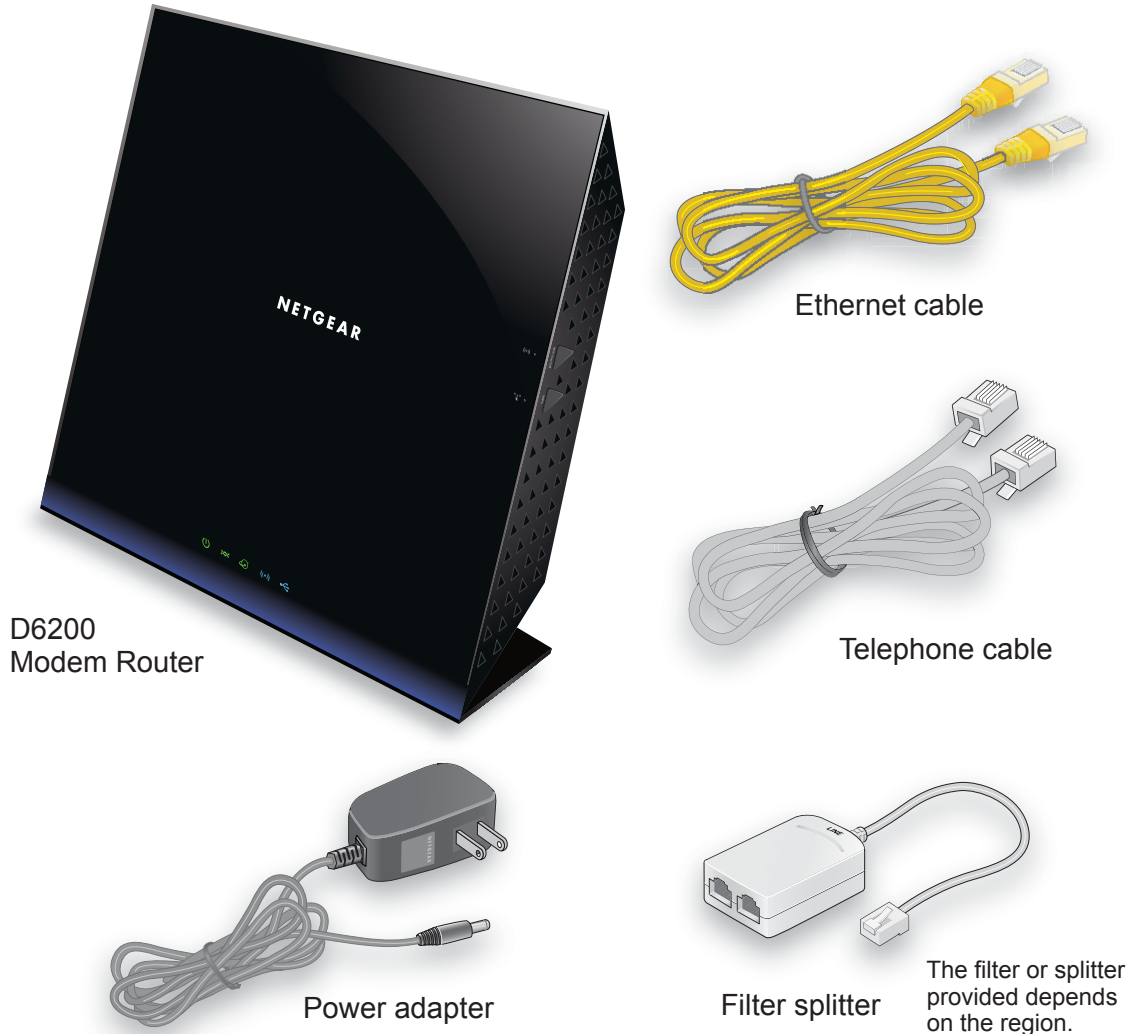

Figure 1. Box contents

Hardware Features

Before you cable your router, take a moment to become familiar with the label and the front and back panels. Pay particular attention to the LEDs on the front panel.

Label

The label on the bottom of the WiFi DSL modem router shows the router login information.

Router login information: URL, user name, and password

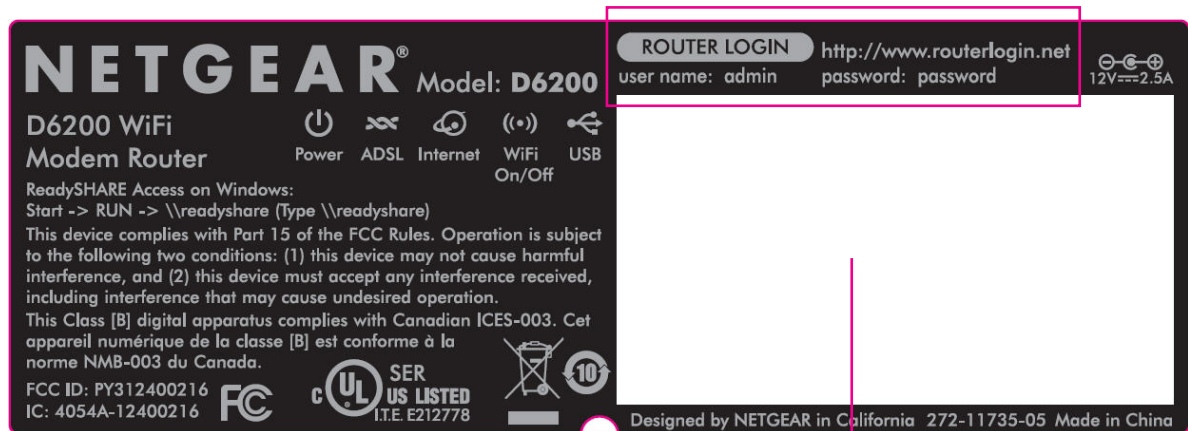

WiFi login information: network name (SSID) and network key (password)

Figure 2. Label on router bottom

The login information that is provided on the label consists of the following two types:

- Router login information: URL, user name, and password.
- WiFi login information: network name (SSID) and network key (password).

For information about logging in, see [Types of Logins and Access](#) on page 22.

Back Panel

The back panel has the Power On/Off button and port connections shown in the figure:

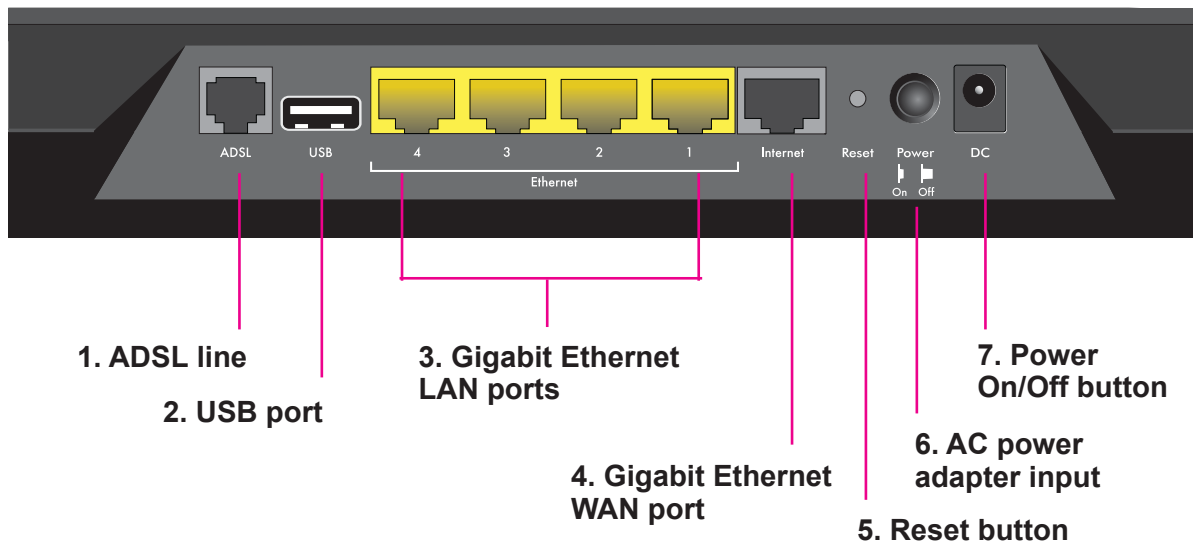

Figure 3. Back panel port connections

Viewed from left to right, the back panel contains the following elements:

1. RJ-11 asynchronous DSL (ADSL) port for connecting the WiFi DSL modem router to an ADSL line

Note: An ADSL port can send data over an ADSL line at one speed and receive it at another speed.

2. USB port for connecting USB storage devices like flash drives, hard drives, or USB printers
3. Four Gigabit Ethernet RJ-45 LAN ports for cabling the WiFi DSL modem router to the local computers
4. One Gigabit Ethernet WAN port for connecting the WiFi DSL modem router to a fiber or cable modem

Note: You can use either the ADSL or Gigabit Ethernet port for WAN connectivity.

5. Reset button

For information about the Reset button and the factory setting values, see [Factory Settings](#) on page 150.

6. Power On/Off button

7. AC power adapter input

Front Panel

The WiFi DSL modem router front panel has the 5 status LEDs, icons, and ports shown in the figure.

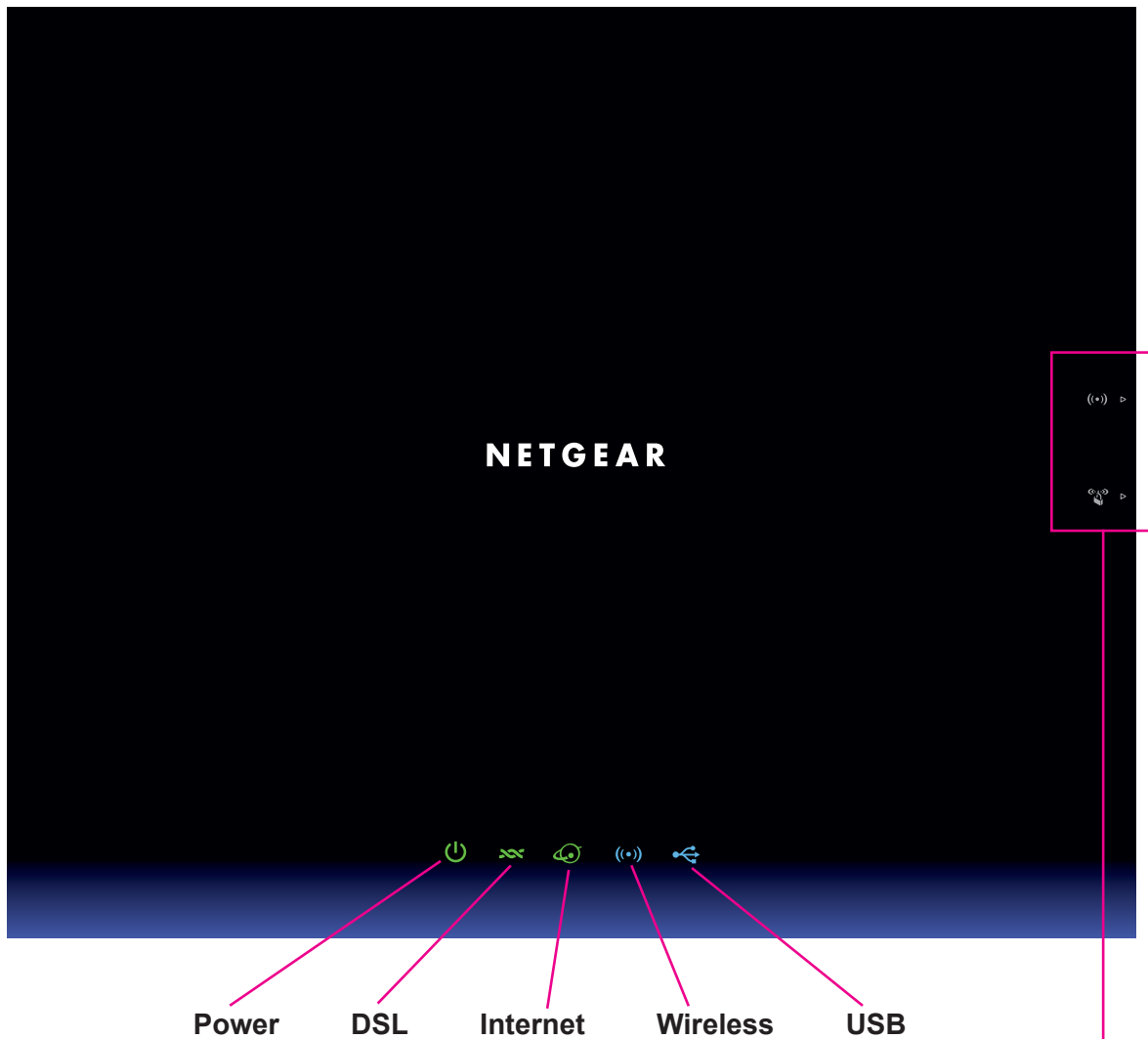

For information about these items, see [Side Panel](#) on page 16.

Figure 4. Front panel LEDs

The following tables describe the LEDs and icons on the front panel from left to right.

Table 1. Power On/Off LED

Icon	LED Activity	Description
	Solid green	The WiFi DSL modem router is ready.
	Solid amber	The WiFi DSL modem router is booting, a POST (power-on self-test) failure occurred, or the WiFi DSL modem router malfunctioned.
	Blinking red	LED blinks momentarily when the Reset button on the back of the WiFi DSL modem router is pressed for 6 seconds. The Power LED then blinks red three times when the Reset button is released and then turns green as the gateway resets to the factory defaults.
	Off	Power is not supplied to the router.

Table 2. DSL LED

Icon	LED Activity	Description
	Solid green	You have an DSL connection. In technical terms, the DSL port is synchronized with an ISP network-access device.
	Blinking green	Indicates that the WiFi DSL modem router is negotiating the best possible speed on the DSL line.
	Off	The WiFi DSL modem router is off or has no DSL connection.

Table 3. Internet LED

Icon	LED Activity	Description
	Solid green	You have an Internet connection. If this connection is dropped due to an idle time-out but the connection is still present, the LED stays green. If the Internet connection is dropped for any other reason, the LED turns off.
	Solid amber	The Internet (IP) connection failed. For troubleshooting information, see Cannot Access the Internet on page 142.
	Off	No Internet connection is detected or the WiFi DSL modem router is in bridge mode (an external device handles the ISP connection).

Table 4. Wireless LED



Icon	LED Activity	Description
	Solid blue	There is wireless connectivity.
	Blinking blue	A WPS-capable device is connecting to the WiFi DSL modem router.
	Off	There is no wireless connectivity. You can still plug an Ethernet cable into one of the LAN ports to get wired connectivity.

Table 5. USB LED

Icon	LED Activity	Description
	Solid blue	A USB port detected a USB device.
	Blinking blue	A USB device is plugged in and is trying to connect.
	Off	No link is detected on these ports.

Side Panel

The WiFi DSL modem router side panel has the buttons shown in the figure.

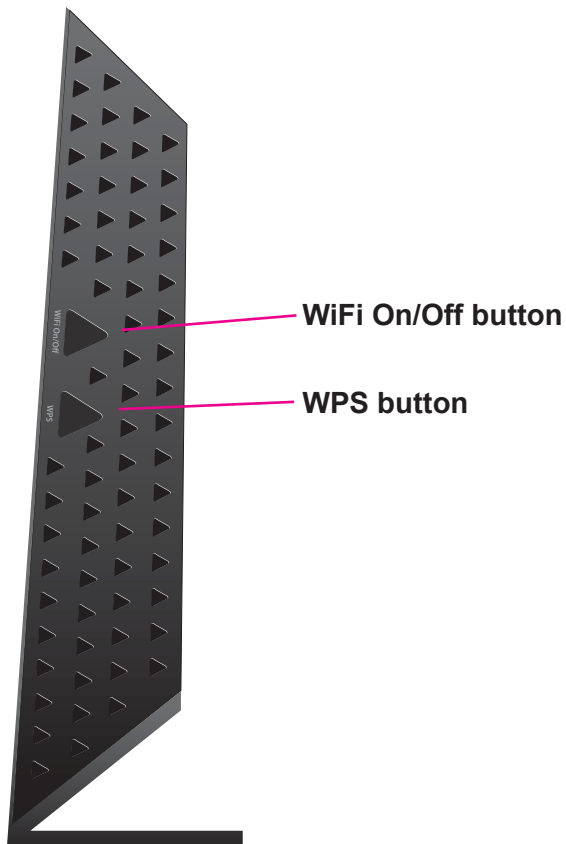

Figure 5. Side panel button

The following tables list the buttons on the side panel from top to bottom.

Table 6. WiFi On/Off button



Icon	Description
	For information about the use of this button, see Wireless Connectivity on page 145.

Table 7. WPS button

Icon	Description
	For information about the use of this button, see Wi-Fi Protected Setup (WPS) Method on page 26.

Position Your Wireless Router

The WiFi DSL modem router lets you access your network from anywhere within the operating range of your wireless network. However, the operating distance or range of your wireless connection can vary significantly depending on the physical placement of your router. For example, the thickness and number of walls the wireless signal passes through can limit the range. For best results, place your router:

- Near the center of the area where your computers and other devices operate and preferably within line of sight to your wireless devices.
- So it is accessible to an AC power outlet and near Ethernet cables for wired computers.
- In an elevated location such as a high shelf, keeping the number of walls and ceilings between the WiFi DSL modem router and your other devices to a minimum.
- Away from electrical devices that are potential sources of interference, such as ceiling fans, home security systems, microwaves, computers, or the base of a cordless phone or 2.4 GHz cordless phone.
- Away from any large metal surfaces, such as a solid metal door or aluminum studs. Large expanses of other materials such as glass, insulated walls, fish tanks, mirrors, brick, and concrete can also affect your wireless signal.

Note: The D6200 should be put in a vertical position only.

Also be aware that when you use multiple access points, it is better if adjacent access points use different radio frequency channels to reduce interference. The recommended channel spacing between adjacent access points is five channels (for example, use Channels 1 and 6, or 6 and 11).

ADSL Microfilters

If this installation is the first time you have cabled a wireless router between an ADSL phone line and your computer or laptop, you might not be familiar with ADSL microfilters. If you are, you can skip this section and proceed to [Cable Your D6200 WiFi DSL Modem Router](#) on page 19.

An ADSL microfilter is a small inline device that filters ADSL interference out of standard phone equipment that shares a line with your ADSL service. Every telephone device that connects to a telephone line that provides ADSL service needs an ADSL microfilter to filter out the ADSL interference. Examples of devices are telephones, fax machines, answering machines, and caller ID displays. Not every phone line in your home necessarily carries ADSL service. That depends on the ADSL service setup in your home.

Note: Often the ADSL microfilter is included in the box with the wireless modem router. If you purchased the WiFi DSL modem router in a country where a microfilter is not included, you have to acquire the ADSL microfilter separately.

One-Line ADSL Microfilter (Not Included)

Plug the ADSL microfilter into the wall outlet and plug your phone equipment into the jack labeled Phone. The wireless modem router plugs directly into a separate ADSL line. Plugging the wireless modem router into the phone jack blocks the Internet connection. If you do not have a separate ADSL line for the router, the best thing to do is to use an ADSL microfilter with a built-in splitter.

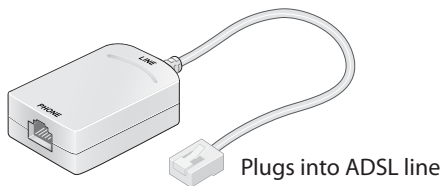

Figure 6. One-line ADSL microfilter

Second best when you do not have a separate ADSL line for the router is to get a separate splitter. To use a one-line filter with a separate splitter, insert the splitter into the phone outlet, connect the one-line filter to the splitter, and connect the phone to the filter.

Two-Line ADSL Microfilter (Included)

Use an ADSL microfilter with a built-in splitter when there is a single wall outlet that provides connectivity for both the WiFi DSL modem router and your telephone equipment. Plug the

ADSL microfilter into the wall outlet, plug your phone equipment into the jack labeled Phone, and plug the wireless modem router into the jack labeled ADSL.

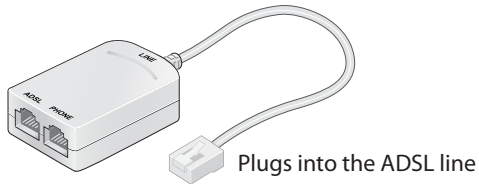

Figure 7. Two-line ADSL microfilter with built-in splitter

Summary

- One-line ADSL microfilter (not included). Use with a phone or fax machine.
- Splitter (not included). Use with a one-line ADSL microfilter to share an outlet with a phone and the WiFi DSL modem router.
- Two-line ADSL microfilter with built-in splitter (included). Use to share an outlet with a phone and the WiFi DSL modem router.

Cable Your D6200 WiFi DSL Modem Router



WARNING:

Do not stack equipment or place equipment in tight spaces, in drawers, or on carpets. Be sure that your equipment is surrounded by at least 2 inches of air space. The unit should not be wall mounted.

The installation guide that came in the box has a cabling diagram on the second page.

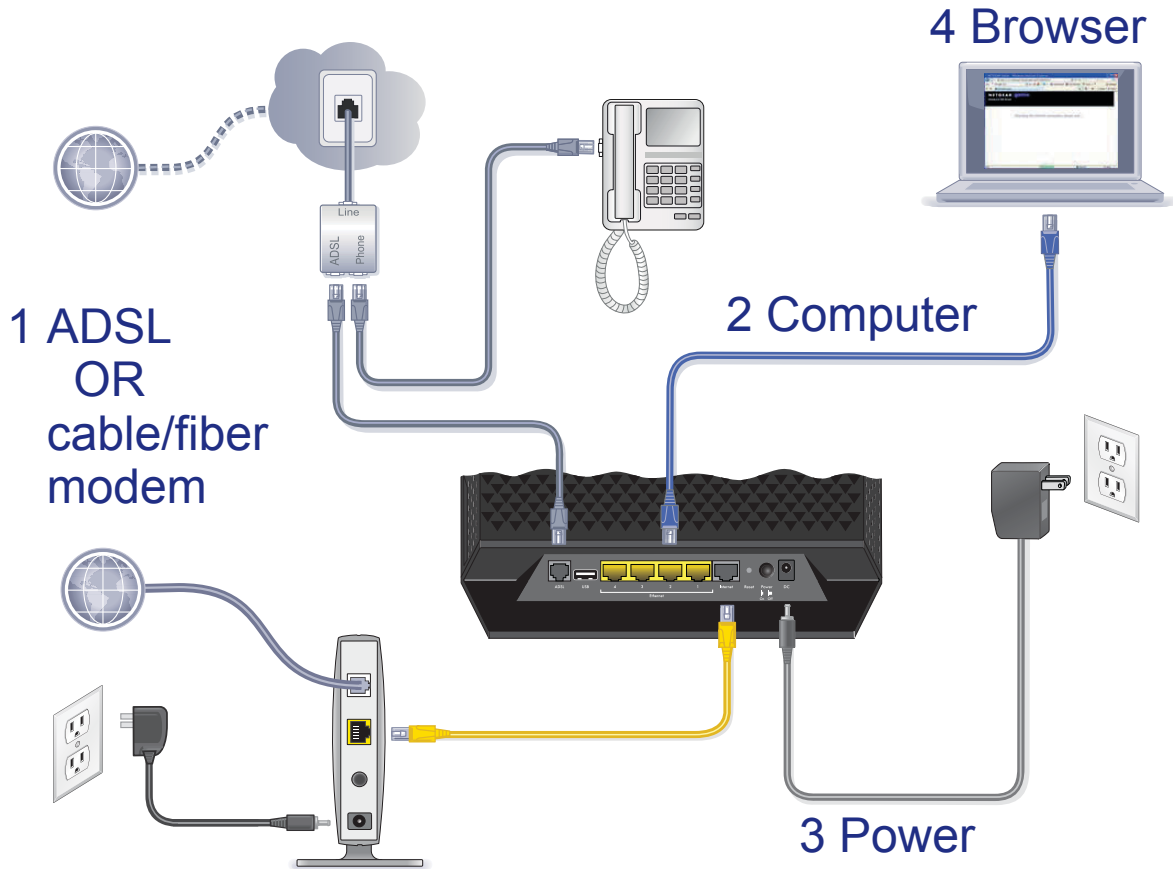

Figure 8. Cabling diagram







CAUTION:

Incorrectly connecting a filter to your WiFi DSL modem router blocks your ADSL connection.

Verify the Cabling

Verify that your router is cabled correctly by checking the WiFi DSL modem router LEDs. Turn on the wireless router by pressing the **Power On/Off** button on the back.

-  The Power LED is green when the modem router is turned on.
-  The Wireless LED is lit when the modem router is turned on.
-  The DSL LED is green when you have an ADSL connection.
-  The Internet LED is green when an Internet connection exists.

Turn on your computer. If software usually logs you in to your Internet connection, do not run that software. Cancel it if it starts automatically.

2 Get Started with NETGEAR genie

2

Connect to the WiFi DSL modem router

This chapter explains how to use NETGEAR genie to set up your WiFi DSL modem router after you complete cabling as described in the installation guide and in the previous chapter in this book.

This chapter contains the following sections:

- *Prepare to Set Up the WiFi DSL Modem Router*
- *Types of Logins and Access*
- *NETGEAR genie Setup*
- *Use NETGEAR genie after Installation*
- *Upgrade WiFi DSL Modem Router Firmware*
- *WiFi DSL Modem Router Dashboard (BASIC Home Screen)*
- *Add Wireless Devices or Computers to Your Network*

Prepare to Set Up the WiFi DSL Modem Router

You can set up your WiFi DSL modem router with the NETGEAR genie automatically, or you can use the genie menus and screens to set up your WiFi DSL modem router manually. However, before you start the setup process, you need to have your ISP information on hand and make sure the laptops, computers, and other devices in the network have the settings described here.

Use Standard TCP/IP Properties for DHCP

If you set up your computer to use a static IP address, you need to change the settings so that it uses Dynamic Host Configuration Protocol (DHCP).

Gather ISP Information

If you have DSL broadband service, you might need the following information to set up your WiFi DSL modem router and to check that your Internet configuration is correct. Your Internet service provider (ISP) should have provided you with all of the information needed to connect to the Internet. If you cannot locate this information, ask your ISP to provide it. When your Internet connection is working, you no longer need to launch the ISP login program on your computer to access the Internet. When you start an Internet application, your WiFi DSL modem router automatically logs you in.

- The ISP configuration information for your DSL account
- ISP login name and password
- Fixed or static IP address settings (special deployment by ISP; this situation is rare)

Wireless Devices and Security Settings

Make sure that the wireless device or computer that you are using supports WPA or WPA2 wireless security, which is the wireless security supported by the WiFi DSL modem router. For information about the WiFi DSL modem router's preconfigured security settings, see [Basic Wireless Settings](#) on page 32.

Types of Logins and Access

Different types of logins have different purposes. It is important that you understand the difference so that you know which login to use when.

- **Wireless modem router login** logs you in to the WiFi DSL modem router interface from NETGEAR genie. For more information about this login, see [Use NETGEAR genie after Installation](#) on page 24.
- **Wireless network key or password.** Your WiFi DSL modem router is preset with a unique wireless network name (SSID) and password for wireless access. This information

is on the label on the bottom of your WiFi DSL modem router. For more information about this login, see *Basic Wireless Settings* on page 32.

- **ISP login** logs you in to your Internet service. Your service provider provided you with this login information in a letter or some other way. If you cannot find this login information, contact your service provider. For more information about this login, see *Internet Basic Settings* on page 29.

NETGEAR genie Setup

NETGEAR genie runs on any device with a web browser. It is the easiest way to set up the WiFi DSL modem router because it automates many of the steps and verifies that those steps have been successfully completed. It takes about 15 minutes to complete.

➤ To use NETGEAR genie to set up your WiFi DSL modem router:

1. Turn the WiFi DSL modem router on by pressing the **Power On/Off** button, if not done yet.
2. Make sure that your device is connected with an Ethernet cable to your WiFi DSL modem router.
3. Launch your Internet browser.
 - If this installation is the first time you are setting up the Internet connection for your WiFi DSL modem router, the browser automatically goes to <http://www.routerlogin.net>, and the NETGEAR genie screen displays.
 - If you already used the NETGEAR genie, type **<http://www.routerlogin.net>** in the address field for your browser to display the NETGEAR genie screen. See *Use NETGEAR genie after Installation* on page 24.
4. Follow the onscreen instructions to complete NETGEAR genie setup. NETGEAR genie guides you through connecting the WiFi DSL modem router to the Internet.

If the browser cannot display the web page:

- Make sure that the computer is connected to one of the four Gigabit Ethernet LAN ports, or wirelessly to the WiFi DSL modem router.
- Make sure that the WiFi DSL modem router is ready. Its Wireless LED should light.
- Close and reopen the browser to make sure that the browser does not cache the previous page.
- Browse to **<http://routerlogin.net>**.
- If your computer is set to a static or fixed IP address (this situation is uncommon), change the setting to obtain an IP address automatically from the WiFi DSL modem router.

If the WiFi DSL modem router does not connect to the Internet:

- Review your settings to be sure that you selected the correct options and typed everything correctly.
- Contact your ISP to verify that you have the correct configuration information.

- Read [Chapter 10, Troubleshooting](#). If problems persist, register your NETGEAR product and contact NETGEAR technical support.

Use NETGEAR genie after Installation

When you first set up your WiFi DSL modem router, NETGEAR genie automatically starts when you launch an Internet browser on a computer that is connected to the WiFi DSL modem router. You can use NETGEAR genie again if you want to view or change settings for the WiFi DSL modem router.

1. Launch your browser from a computer or wireless device that is connected to the WiFi DSL modem router.
2. Enter **http://www.routerlogin.net** in the web browser address bar.

A login window displays.



The screenshot shows a login dialog box with a light beige background. It has two text input fields: 'User name:' with 'admin' and a dropdown arrow, and 'Password:' with '*****'. Below the password field is a checkbox labeled 'Remember my password' which is not checked. At the bottom of the dialog are two buttons: 'OK' and 'Cancel'.

3. Enter **admin** for the WiFi DSL modem router user name and **password** for the WiFi DSL modem router password, both in lowercase letters.

Note: The WiFi DSL modem router user name and password are different from the user name and password for logging in to your Internet connection. For more information, see [Types of Logins and Access](#) on page 22.

Upgrade WiFi DSL Modem Router Firmware

When you set up your WiFi DSL modem router and are connected to the Internet, the WiFi DSL modem router automatically checks for you to see if newer firmware is available. If it is, a message is displayed on the top of the screen. For more information about upgrading firmware, see [Upgrade the WiFi DSL Modem Router Firmware](#) on page 90.

Click the message when it shows up, and click **Yes** to upgrade the WiFi DSL modem router with the latest firmware. After the upgrade, the WiFi DSL modem router restarts.

**CAUTION:**

Do not try to go online, turn off the WiFi DSL modem router, shut down the computer, or do anything else to the WiFi DSL modem router until the WiFi DSL modem router finishes restarting and the Power LED has stopped blinking for several seconds.

WiFi DSL Modem Router Dashboard (BASIC Home Screen)

The WiFi DSL modem router BASIC Home screen has a dashboard that lets you see the status of your Internet connection and network at a glance. You can click any of the six sections of the dashboard to view more detailed information. Menus are on the left, and the Advanced tab that is used to access additional menus and screens is at the top.

Menus (Click the Advanced tab to view more) Language

Dashboard (Click to view details) Help

Figure 9. Wireless modem router BASIC Home screen with dashboard, language, and online help

- **Home.** This dashboard screen displays when you log in to the WiFi DSL modem router.
- **Internet.** Set, update, and check the ISP settings of your WiFi DSL modem router.
- **Wireless.** View or change the wireless settings for your WiFi DSL modem router.
- **Attached Devices.** View the devices connected to your network.

- **Parental Controls.** Download and set up parental controls to prevent objectionable content from reaching your computers.
- **ReadySHARE.** If you connected a USB storage device to the WiFi DSL modem router, then it is displayed here.
- **Guest Network.** Set up a guest network to allow visitors to use your WiFi DSL modem router's Internet connection.
- **Advanced tab.** Set the WiFi DSL modem router up for unique situations such as when remote access by IP address or by domain name from the Internet is needed. See [Chapter 9, Advanced Settings](#). Using this tab requires a solid understanding of networking concepts.
- **Help & Support.** Go to the NETGEAR support site to get information, help, and product documentation. These links work after you have an Internet connection.

Add Wireless Devices or Computers to Your Network

Choose either the manual or the WPS method to add wireless devices and other equipment to your wireless network. For instructions for how to set up a guest network, see [Guest Networks](#) on page 36.

Manual Method

You can connect to the WiFi DSL modem router manually.

➤ To connect manually:

1. Open the software that manages your wireless connections on the wireless device (laptop computer, gaming device, iPhone) that you want to connect to your WiFi DSL modem router.

The wireless software scans for all wireless networks in your area.

2. Look for your network and select it. If you did not change the name of your network during the setup process, look for the default WiFi network name (SSID) and select it.

The default SSID is on the product label on the bottom of the WiFi DSL modem router.

3. Enter the WiFi DSL modem router password and click **Connect**.

The default WiFi DSL modem router passphrase is on the product label on the bottom of the WiFi DSL modem router.

4. Repeat steps 1–3 to add other wireless devices.

Wi-Fi Protected Setup (WPS) Method

Wi-Fi Protected Setup (WPS) is a standard for easily adding computers and other devices to a home network while maintaining security. To use WPS, make sure that all wireless devices to be connected to the network are Wi-Fi certified and support WPS. During the connection

process, the client gets the security settings from the WiFi DSL modem router so that every device in the network has the same security settings.

If your wireless device supports WPS (Push 'N' Connect), use the following procedure.

➤ **To use WPS to join the wireless network:**

1. Press the **WPS** button on the WiFi DSL modem router side panel.
2. Within 2 minutes, press the **WPS** button on your wireless device or follow the WPS instructions that came with the device.

The device is now connected to your WiFi DSL modem router.

3. Repeat steps 1–2 to add other WPS wireless devices.

NETGEAR genie BASIC Settings

3

Your Internet connection and network

This chapter explains the features available from the NETGEAR genie BASIC Home screen, shown in the following figure:

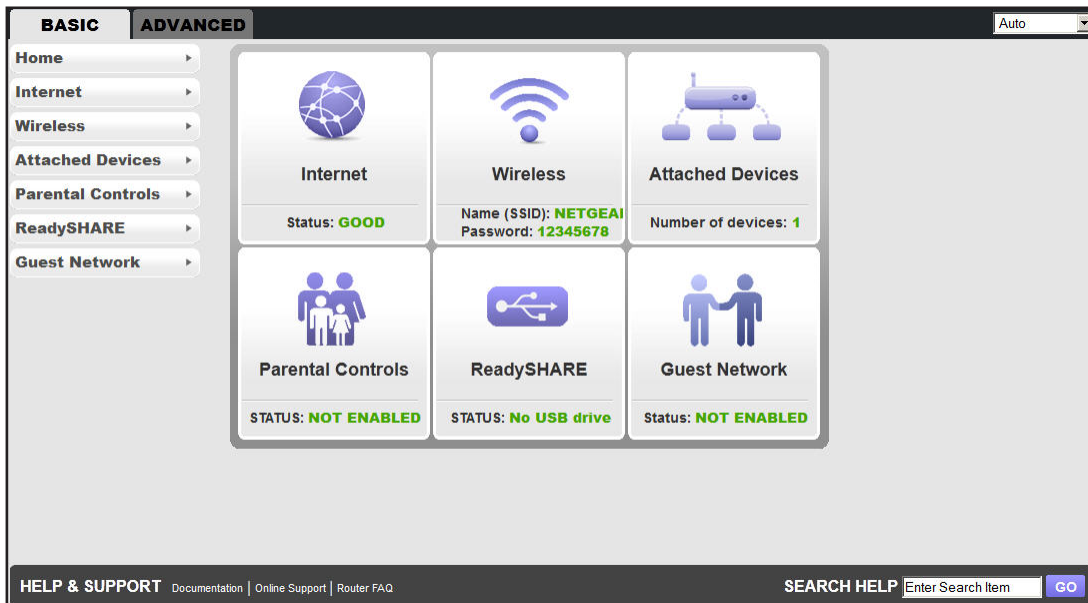

This chapter contains the following sections:

- [Internet Basic Settings](#)
- [Attached Devices](#)
- [Parental Controls](#)
- [Basic Wireless Settings](#)
- [Guest Networks](#)
- [NETGEAR genie App](#)

For information about ReadySHARE, see [Chapter 5, USB Storage](#) and [Chapter 6, ReadySHARE Printer](#).

Internet Basic Settings

The Internet Setup screen is where you view or change ISP information.

➤ **To view or change ISP information:**

1. From the BASIC Home screen, select **Internet**.

Scroll to view more settings

The fields that display in the Internet Setup screen depend on whether your Internet connection requires a login.

2. Select the appropriate radio button:
 - **Yes.** Select the encapsulation method and enter the login name.
 - **No.** Enter the account and domain names, only if needed.
3. Enter the settings for the IP address and DNS server.

The default settings usually work fine. If you have problems with your connection, check the ISP settings.

4. Click **Apply**.
5. Click **Test**.

If the NETGEAR website does not display within 1 minute, see [Chapter 10, Troubleshooting](#).

Internet Setup Screen Fields

The following descriptions explain all of the possible fields in the Internet Setup screen. Which fields display in this screen depends on whether an ISP login is required.

Does Your ISP Require a Login? Answer either yes or no.

These fields display when no login is required:

- **Account Name (If Required).** Enter the account name provided by your ISP. This name might also be called the host name.
- **Domain Name (If required).** Enter the domain name provided by your ISP.

These fields display when your ISP requires a login:

- **Internet Service Provider Encapsulation.** ISP types. The choices are PPPoE or PPPoA.
- **Login.** The login name provided by your ISP. This name is often an email address.
- **Password.** The password that you use to log in to your ISP.
- **Idle Timeout (In minutes).** If you want to change the login time-out, enter a new value in minutes. This setting determines how long the WiFi DSL modem router keeps the Internet connection active after no Internet activity from the LAN. Entering a value of 0 (zero) means never log out.

Internet IP Address.

- **Get Dynamically from ISP.** Your ISP uses DHCP to assign your IP address. Your ISP automatically assigns these addresses.
- **Use Static IP Address.** Enter the IP address, IP subnet mask, and the gateway IP address that your ISP assigned. The gateway is the ISP WiFi DSL modem router to which your WiFi DSL modem router connects.

Domain Name Server (DNS) Address. The DNS server is used to look up site addresses based on their names.

- **Get Automatically from ISP.** Your ISP uses DHCP to assign your DNS servers. Your ISP automatically assigns this address.
- **Use These DNS Servers.** If you know that your ISP does not automatically transmit DNS addresses to the WiFi DSL modem router during login, select this option, and enter the IP address of your ISP primary DNS server. If a secondary DNS server address is available, enter it also.

WiFi DSL Modem Router MAC Address. The Ethernet MAC address used by the WiFi DSL modem router on the Internet port. Some ISPs register the MAC address of the network interface card in your computer when your account is first opened. They then accept traffic only from the MAC address of that computer. This feature allows your WiFi DSL modem router to use your computer's MAC address (this procedure is also called cloning).

- **Use Default Address.** Use the default MAC address.
- **Use Computer MAC Address.** The WiFi DSL modem router captures and use the MAC address of the computer that you are now using. You have to use the one computer that the ISP allows.
- **Use This MAC Address.** Enter the MAC address that you want to use.

Attached Devices

You can view all computers or devices that are currently connected to your network here.

➤ **To view the computers and devices connected to your network:**

1. From the Basic Home screen, select **Attached Devices**.

The screenshot shows the 'Attached Devices' page in the NETGEAR genie BASIC Settings interface. The page is divided into two sections: 'Wired Devices' and 'Wireless Devices (Wireless intruders also show up here)'. A 'Refresh' button is located at the top right of the page. The 'Wired Devices' section is currently empty. The 'Wireless Devices' section contains one entry:

#	IP Address	Device Name	MAC Address
1	10.0.0.2	USER.HP	70:F3:95:B1:E0:5A

The interface also includes a navigation menu on the left with options like Home, Internet, Wireless, Attached Devices, Parental Controls, ReadySHARE, and Guest Network. At the bottom, there is a 'HELP & SUPPORT' section with links to Documentation, Online Support, and Router FAQ, and a search bar for help items.

Wired devices are connected to the WiFi DSL modem router with Ethernet cables. Wireless devices have joined the wireless network.

- **#** (number). The order in which the device joined the network.
- **IP Address**. The IP address that the WiFi DSL modem router assigned to this device when it joined the network. This number can change when a device is disconnected and rejoins the network.
- **Device Name**. If the device name is known, it is shown here.
- **MAC Address**. The unique MAC address for each device does not change. The MAC address is typically shown on the product label.

2. Click **Refresh**.

The screen updates.

Parental Controls

The first time you select Parental Controls from the BASIC Home screen, you are automatically directed to the Internet, where you can learn more about Live Parental Controls or download the application. The following screen displays:

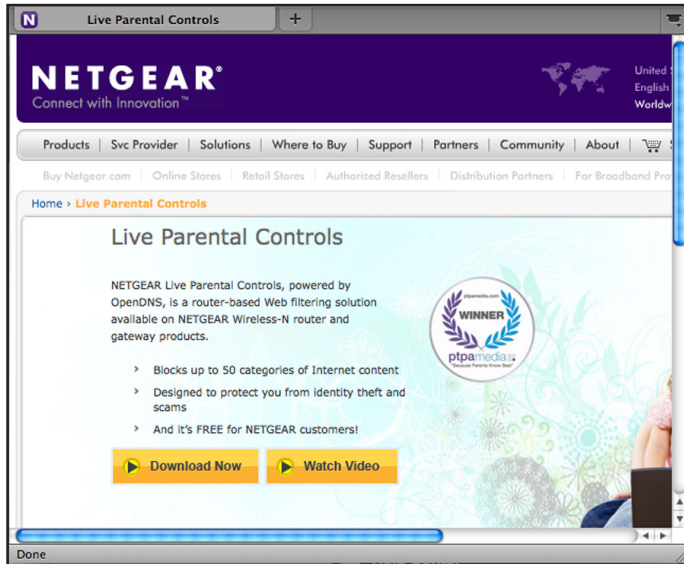

Basic Wireless Settings

The Wireless Settings screen lets you view or configure the wireless network setup.

The WiFi DSL modem router comes with preset security. This means that the WiFi network name (SSID), network key (password), and security option (encryption protocol) are preset in the factory. You can find the preset SSID and password on the bottom of the unit.

Note: The preset SSID and password are uniquely generated for every device to protect and maximize your wireless security.

NETGEAR recommends that you do not change your preset security settings. If you do decide to change your preset security settings, make a note of the new settings and store it in a safe place where you can easily find it.

If you use a wireless computer to change the wireless network name (SSID) or other wireless security settings, you are disconnected when you click Apply. To avoid this problem, use a computer with a wired connection to access the WiFi DSL modem router.

➤ **To view or change basic wireless settings:**

1. On the BASIC Home screen, select **Wireless**.

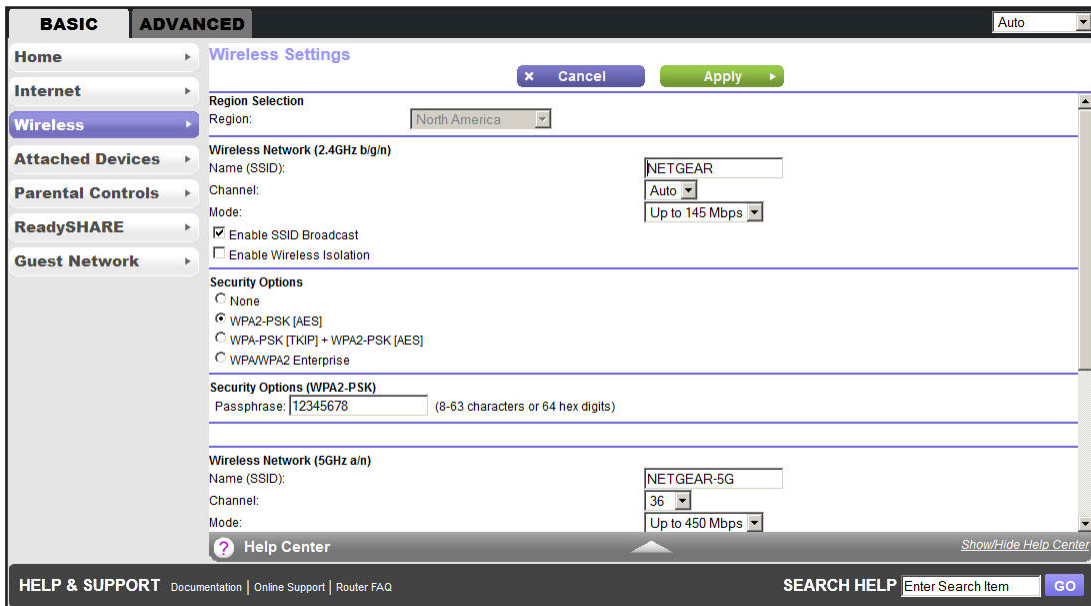

The screen sections, settings, and procedures are explained in the following sections.

2. Make any changes that are needed.
3. Click **Apply**.
4. Set up and test your wireless devices and computers to make sure that they can connect wirelessly.

If they do not, check the following:

- Is your wireless device or computer connected to your network or another wireless network in your area? Some wireless devices automatically connect to the first open network (without wireless security) that they discover.
- Does your wireless device or computer appear on the Attached Devices screen? If it does, it is connected to the network.
- If you are not sure what the network name (SSID) or password is, look on the label on the bottom of your WiFi DSL modem router.

Wireless Settings Screen Fields

The following settings are available.

Region. The location where the WiFi DSL modem router is used. Select from the countries in the list. In the United States, the region is fixed to United States and is not changeable.

Wireless Network

Note: These settings display in separate sections of the screen to the 2.4 GHz b/g/n and 5 GHz a/n bands.

Name (SSID). The SSID is also known as the wireless network name. Enter a 32-character (maximum) name in this field. This field is case-sensitive. The default SSID is randomly generated, and **NETGEAR strongly recommends that you do not change this setting.**

Channel. This setting is the wireless channel used by the gateway. The default channel is Auto. When Auto is selected, the WiFi DSL modem router finds the best operating channel available.

Do not change the channel unless you experience interference (when indicated by lost connections or slow data transfers). If this interference happens, experiment with different channels to see which is the best.

If you notice interference from nearby devices, you can select a different channel. Channels 1, 6, and 11 do not interfere with each other. Enter a value from 1 through 13. For products in the North America market, only Channels 1 through 11 can be operated.

Mode. Up to 130 Mbps is the default and allows 802.11n and 802.11g wireless devices to join the network. g & b supports up to 54 Mbps. The 300 Mbps setting allows 802.11n devices to connect at this speed.

Enable SSID Broadcast. This feature allows the WiFi DSL modem router to broadcast its SSID so wireless stations can see this wireless name (SSID) in their scanned network lists. This check box is selected by default. To turn off the SSID broadcast, clear the **Enable SSID Broadcast** check box and click **Apply**.

Enable Wireless Isolation. If this check box is selected, wireless clients (computers or wireless devices) that join the network can use the Internet, but cannot access each other or access Ethernet devices on the network.

Security Options Settings

Note: These settings display in separate sections of the screen to the 2.4 GHz b/g/n and 5 GHz a/n bands.

The Security Options section of the Wireless Setup screen lets you change the security option and password. **NETGEAR recommends that you do not change the security option or passphrase**, but if you want to change these settings, the following section explains how. **Do not disable security.**

Wireless Security Options

A security option is the type of security protocol applied to your wireless network. The security protocol in force encrypts data transmissions and ensures that only trusted devices receive authorization to connect to your network.

This section presents an overview of the security options and provides guidance on when to use which option. It is also possible to set up a guest network without wireless security. NETGEAR does *not* recommend using no security on a wireless network.

Wi-Fi Protected Access (WPA) encryption is built into all hardware that has the Wi-Fi-certified seal. This seal means that the product is authorized by the Wi-Fi Alliance (<http://www.wi-fi.org/>) because it complies with the worldwide single standard for high-speed wireless local area networking.

WPA-PSK uses a passphrase to authenticate and generate the initial data encryption keys. Then it dynamically varies the encryption key. WPA-PSK uses Temporal Key Integrity Protocol (TKIP) data encryption, implements most of the IEEE 802.11i standard, and is designed to work with all wireless network interface cards, but not all wireless access points. It is superseded by WPA2-PSK.

WPA2-PSK is stronger than WPA. It is advertised to be indecipherable due to the greater degree of randomness in encryption keys that it generates. WPA2-PSK gets higher speed because it is implemented through hardware, while WPA-PSK is implemented through software. WPA2-PSK uses a passphrase to authenticate and generate the initial data encryption keys. Then it dynamically varies the encryption key.

WPS-PSK + WPA2-PSK Mixed Mode can provide broader support for all wireless clients. WPA2-PSK clients get higher speed and security, and WPA-PSK clients get decent speed and security. The product documentation for your wireless adapter and WPA client software should have instructions about configuring their WPA settings.

Change WPA Security Option and Passphrase

Note: These settings display in separate sections of the screen to the 2.4 GHz b/g/n and 5 GHz a/n bands.

1. On the BASIC Home screen, select **Wireless**.
2. Under Security Options, select the WPA option you want.
3. In the Passphrase field that displays when you select a WPA security option, enter the network key (passphrase) that you want to use.

The passphrase is a text string from 8 to 63 characters.

Guest Networks

Adding a guest network allows visitors at your home to use the Internet without using your wireless security key. You can add a guest network to each wireless network: 2.4 GHz b/g/n and 5.0 GHz a/n.

➤ **To set up a guest network:**

1. From the BASIC Home screen, select **Guest Network**.

The screenshot shows the 'Guest Network' configuration page in the NETGEAR genie interface. The 'BASIC' tab is selected, and the 'Guest Network' menu item is highlighted in the left sidebar. The main content area is titled 'Guest Network' and includes a 'Cancel' button and an 'Apply' button. Below this is a table for selecting a wireless network to configure (2.4GHz b/g/n). The table has columns for Profile, SSID, Guest Network, Security, Enable, and Broadcast SSID. Three profiles are listed: 1 (NETGEAR_Guest1), 2 (NETGEAR_Guest2), and 3 (NETGEAR_Guest3). Below the table, the 'Wireless Network (2.4GHz b/g/n)' section is expanded, showing fields for Name (SSID) set to 'NETGEAR_Guest1', Channel set to 'Auto', and Mode set to 'Up to 145 Mbps'. There are four checkboxes: 'Enable Guest Network' (unchecked), 'Enable SSID Broadcast' (checked), 'Allow guest to access My Local Network' (unchecked), and 'Enable Wireless Isolation' (unchecked). The 'Security Options' section shows 'None' selected. At the bottom, there is another table for selecting a wireless network to configure (5GHz a/n) and a 'Help Center' link.

Profile	SSID	Guest Network	Security	Enable	Broadcast SSID
1	NETGEAR_Guest1	Yes	None	No	Yes
2	NETGEAR_Guest2	Yes	None	No	Yes
3	NETGEAR_Guest3	Yes	None	No	Yes

2. Configure the following settings:

Note: These settings display in separate sections of the screen to the 2.4 GHz b/g/n and 5 GHz a/n bands.

- **Enable Guest Network.** When this check box is selected, the guest network is enabled, and guests can connect to your network using the SSID of this profile.
- **Enable SSID Broadcast.** If this check box is selected, the wireless access point broadcasts its name (SSID) to all wireless stations. Stations with no SSID can adopt the correct SSID for connections to this access point.
- **Allow guest to access My Local Network.** If this check box is selected, any user who connects to the network with this SSID has access to your local network, not just Internet access.
- **Enable Wireless Isolation.** If this check box is selected, wireless clients (computers or wireless devices) that join the network can use the Internet, but cannot access each other or access Ethernet devices on the network.

3. Give the guest network a name.

The guest network name is case-sensitive and can be up to 32 characters. You then manually configure the wireless devices in your network to use the guest network name in addition to the main nonguest SSID.

4. Select a security option from the list.

The security options are described in *Wireless Security Options* on page 35.

5. Click **Apply**.

NETGEAR genie App

The genie app is your home network dashboard. It lets you easily view, manage, and control your entire home network, and helps you fix common network problems. You can use the genie app or the genie mobile app.



genie app

Visit the NETGEAR genie web page at www.netgear.com/genie.

From the genie app, you can select the following:

- **Internet.** Monitor and repair Internet connectivity issues, for both wired and wireless connections.
- **WiFi Connection.** View or change your router wireless settings.
- **Router Settings.** Log in to your router to view or change its settings.
- **Network Map.** View the devices connected to your network.
- **Parental Controls.** Manage parental controls to protect devices in your network from inappropriate contents.
- **ReadySHARE.** If you connected a USB storage device or printer to the USB port on the router, then you can access its contents.
- **Support.** Support FAQs are available on your computer without an Internet connection. You can get answers to common router issues here. Some simple network tools are available to help you debug the network as well.

To use this app, you need a WiFi connection from your phone or iPad to your NETGEAR home network.

➤ To install the genie mobile app:

1. Using your mobile device, navigate to the Apple AppStore or Google Play for Android, and search for NETGEAR genie.

You can use the following QR codes to speed up this process:



iPad app



iPhone app



Android app

2. Install the app on your iPad or phone.
3. Launch the app.

The dashboard screen displays.

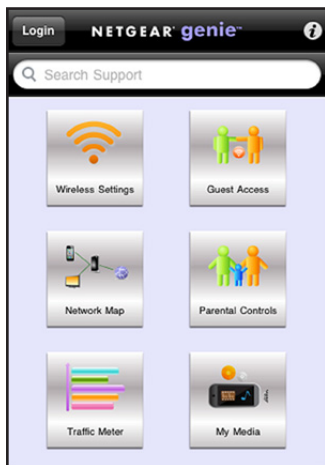

To use this app, you need a WiFi connection from your phone or iPad to your NETGEAR home network.

- Manage Wi-Fi settings and guest access for your home network.
- View a map of your network.
- Set up or manage Parental Controls.
- Use the traffic meter to check your Internet usage.
- With My Media, play media on devices on your network.

NETGEAR genie ADVANCED Home

4

Specify custom settings

The ADVANCED screens are for advanced users who want to specify custom settings.

This chapter explains the features available from the NETGEAR genie ADVANCED Home screen, shown in the following figure:

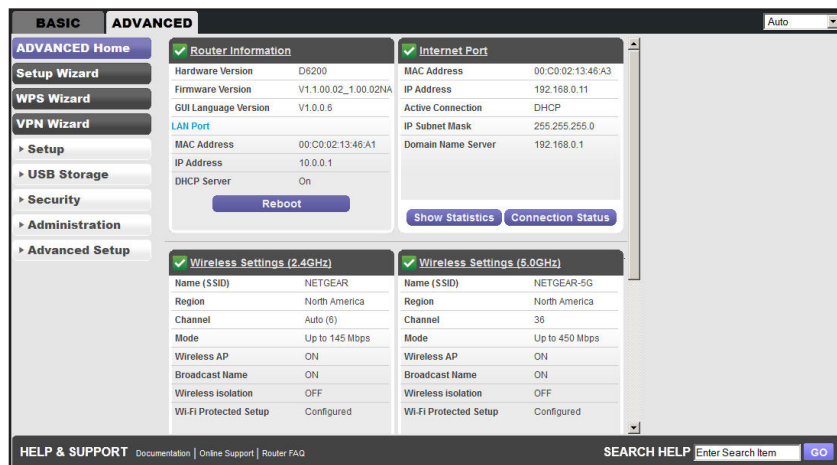

This chapter contains the following sections:

- [Setup Wizard](#)
- [WPS Wizard](#)
- [VPN Wizard](#)
- [Setup Menu](#)
- [ADSL Setup](#)
- [WAN Setup](#)
- [LAN Setup](#)
- [Quality of Service Setup](#)

Some selections on the Advanced Home screen are described in separate chapters:

- **USB Storage.** See [Chapter 5, USB Storage](#).
- **Security.** See [Chapter 7, Security](#).
- **Administration.** See [Chapter 8, Administration](#).
- **Advanced Setup.** See [Chapter 9, Advanced Settings](#).

Setup Wizard

The NETGEAR genie installation process is launched the first time you set up the WiFi DSL modem router. After setting up the WiFi DSL modem router the first time, if you want to perform this task again, you can run Setup Wizard from the Advanced tab of genie.

➤ **To run the Setup Wizard:**

1. Select **ADVANCED > Setup Wizard**.

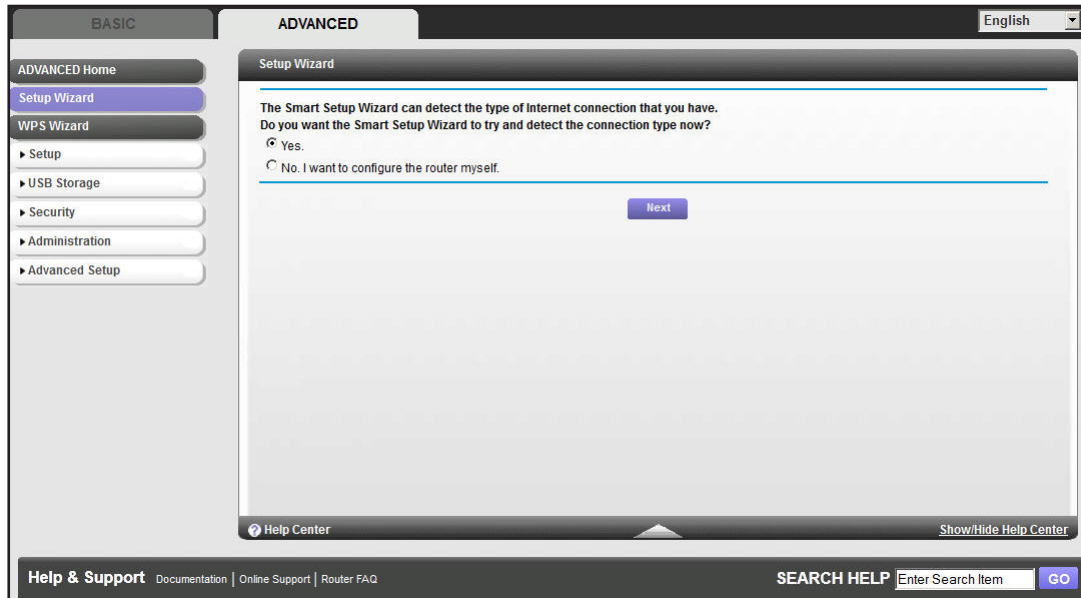

2. Select either **Yes** or **No, I want to configure the router myself**.

If you select No, you are taken to the Internet Setup screen (see [Internet Basic Settings](#) on page 29).

3. If you selected Yes, click **Next**.

A series of screens are displayed as the router discovers and processes your Internet connection.

4. Click **Next** when prompted.

You advance to the next screen.

The Setup Wizard searches your Internet connection for servers and protocols to determine your ISP configuration.

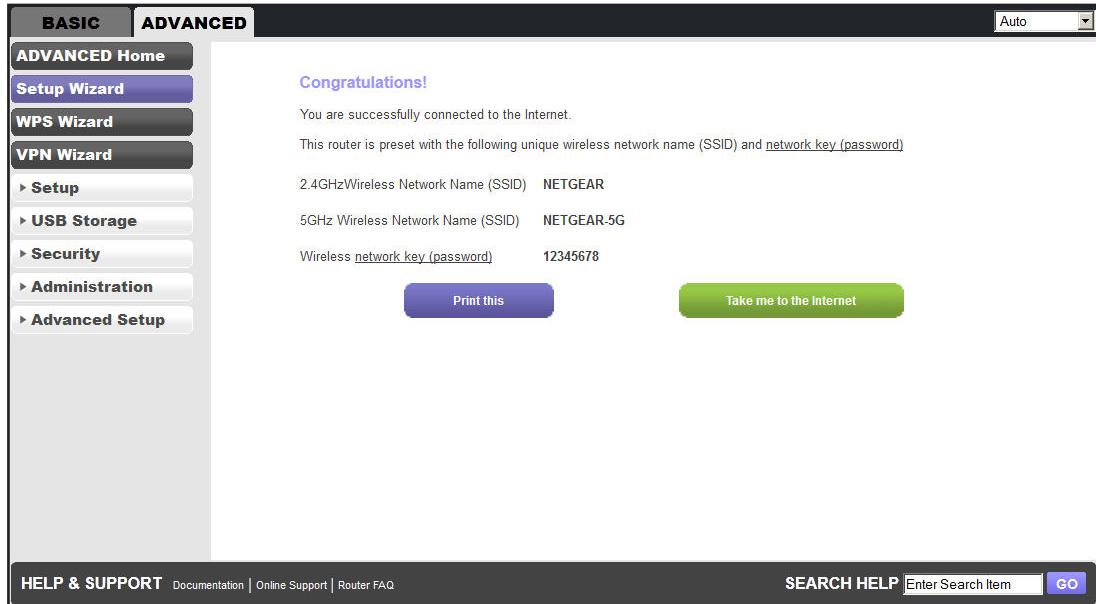

5. To transfer to the Internet, click **Take me to the Internet**.
To print a copy of your Internet configuration, click **Print this**.

WPS Wizard

The WPS Wizard helps you add a WPS-capable client device (a wireless device or computer) to your network. On the client device, you have to either press its WPS button or locate its WPS PIN.

➤ **To use the WPS Wizard:**

1. Select **ADVANCED > WPS Wizard**.

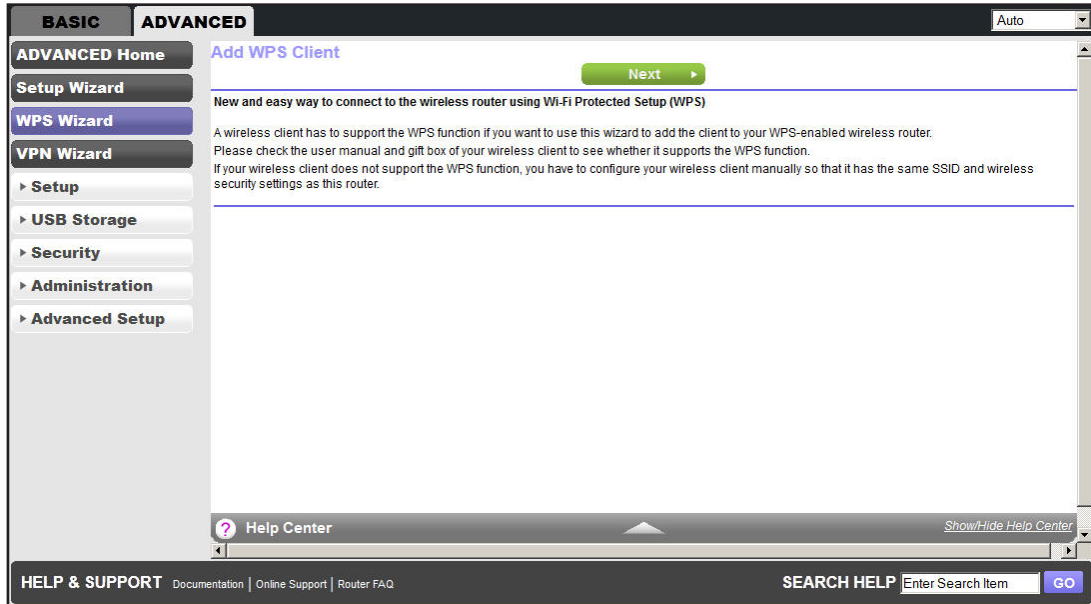

2. Click **Next**.

The following screen lets you select the method for adding the WPS client (a wireless device or computer).

The screenshot shows the 'Add WPS Client' screen. It has a title 'Add WPS Client' and a subtitle 'Select a setup method:'. There are two radio button options: 'Push Button (recommended)' and 'PIN Number'. The 'Push Button' option is selected. Below the 'Push Button' option, there is a small icon of a green button with a white 'W' and a signal icon. Below the 'PIN Number' option, there is a small icon of a green button with a white 'W' and a signal icon. The text for the 'Push Button' option says: 'You can either press the physical push button on the router or click the button (soft push button) in this screen.' The text for the 'PIN Number' option says: 'This is the security PIN of the WPS client. While connecting, WPS-enabled adapters provide a randomly-generated security PIN.'

You can use either the push button or PIN method.

3. Select either **Push Button** or **PIN Number**.
 - To use the push button method, either click the **WPS** button on this screen, or press the **WPS** button on the side of the WiFi DSL modem router. Within 2 minutes, go to the wireless client and press its **WPS** button to join the network without entering a password.

- To use the PIN method, select the **PIN Number** radio button, enter the client security PIN, and click **Next**.



Within 2 minutes, go to the client device and use its WPS software to join the network without entering a password.

The WiFi DSL modem router attempts to add the WPS-capable device. The WPS LED on the side of the WiFi DSL modem router blinks green. When the WiFi DSL modem router establishes a WPS connection, the LED is solid green, and the WiFi DSL modem router WPS screen displays a confirmation message.

- Repeat Step 2 and Step 3 to add another WPS client to your network.

VPN Wizard

The Wizard asks you series of questions that determine the IPSec keys and VPN policies it sets up. The VPN Wizard sets the parameters for the network connection, security association, traffic selectors, authentication algorithm, and encryption. These parameters are based on the VPNC recommendations. More information about the VPNC recommendations is presented in the VPN Wizard summary page.

➤ To use the VPN Wizard:

- Select **ADVANCED > VPN Wizard**.

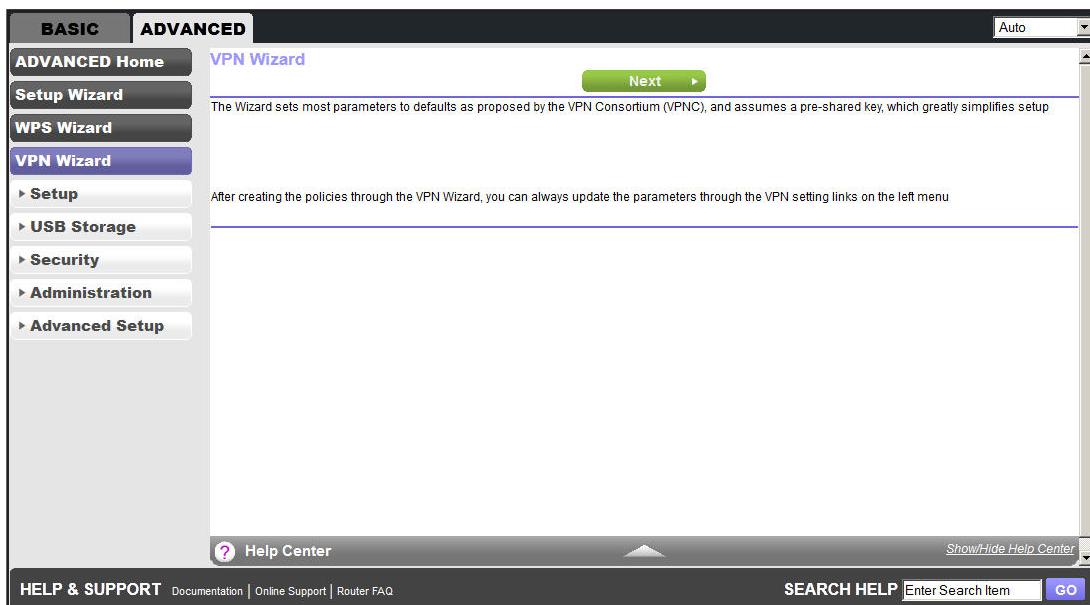

2. Click **Next**.

VPN Wizard

Back Cancel Next

Step 1 of 3: Connection Name and Remote IP Type

What is the new Connection Name?

What is the pre-shared key?

This VPN tunnel will connect to:

A remote VPN Gateway

A remote VPN client (single PC)

Enter the requested information:

- **Connection name.** Enter an appropriate name for the connection. This name is not supplied to the remote VPN endpoint. Rather, it is used to help you manage the VPN settings.
- **Pre-shared key.** The key has to be entered both here and on the remote VPN gateway or the remote VPN client. This method does not require using a CA (certificate authority).
- **VPN tunnel connection.** The wizard has to know if you are planning to connect to a remote gateway or setting up the connection for a remote client or computer to establish a secure connection to this device.

3. Click **Next**.

VPN Wizard

Back Cancel Next

Step 2 of 3: Remote IP address or the Internet name

What is the remote WAN's IP address or Internet name?

Enter the remote IP address of the gateway you want to connect to, or provide the Internet name of the gateway. The Internet name is the fully qualified domain name, as set up in a Dynamic DNS service.

4. Click **Next**.

VPN Wizard

Back Cancel Next

Step 3 of 3: Secure Connection Remote Accessibility

What is the remote LAN IP address and Subnet Mask?

IP Address: . . .

Subnet Mask: . . .

Enter the remote LAN IP address and subnet mask of the remote gateway.

- If this information does not match the LAN IP address and subnet mask in the remote gateway, the secure tunnel fails to connect.
- The IP address range used on the remote LAN has to be different from the IP address range used on the local LAN.

5. Click **Next**.

VPN Wizard

Summary

Please verify your inputs:

Connection Name: test

Remote Endpoint:

Remote Client Access:

Remote IP:

Remote ID:

Local Client Access: By subnet

Local IP: 10.0.0.1 / 255.255.255.0

Local ID:

You can click [here](#) to view the VPNC-recommended parameters

Please click "Done" to apply the changes

This screen shows the summary of the Wizard configuration with a link to view the VPNC recommended parameters (click the **here** link to view the VPNC-recommended parameters).

6. Click **Done**.

VPN Policies

#	Enable	Name	Type	Local	Remote	ESP
1	<input checked="" type="checkbox"/>	test	Auto	10.0.0.1 / 255.255.255.0	192.168.0.1 / 255.255.255.255	3DES

Buttons: Edit, Delete, Add Auto Policy, Add Manual Policy

For information about how to add or modify VPN policies, see [VPN Policies](#) on page 130.

Setup Menu

Select **ADVANCED > Setup** to display the Setup menu.

The following selections are available:

- **Internet Setup.** This selection is a shortcut to the same Internet Setup screen that you can access from the dashboard on the BASIC Home screen. See [Internet Basic Settings](#) on page 29.
- **ADSL Setup.** Internet (ADSL) setup. See [ADSL Setup](#) on page 46.
- **Wireless Setup.** This selection is a shortcut to the same Wireless Settings screen that you can access from the dashboard on the BASIC Home screen. See [Basic Wireless Settings](#) on page 32.
- **WAN Setup.** Internet (WAN) setup. See [WAN Setup](#) on page 47.
- **LAN Setup.** Local area network (LAN) setup. See [LAN Setup](#) on page 50.
- **QoS Setup.** Quality of Service (QoS) setup. See [Quality of Service Setup](#) on page 54.

- **Guest Network.** This selection is a shortcut to the same Wireless Settings (for guest networks) screen that you can access from the dashboard on the BASIC Home screen. See *Guest Networks* on page 36.

ADSL Setup

The ADSL Settings screen lets you configure the multiplexing method and virtual circuit of your ADSL connection. The default parameters should match those on the system used by your ISP.

➤ To configure ADSL:

1. Select **ADVANCED > Setup > ADSL Settings**.

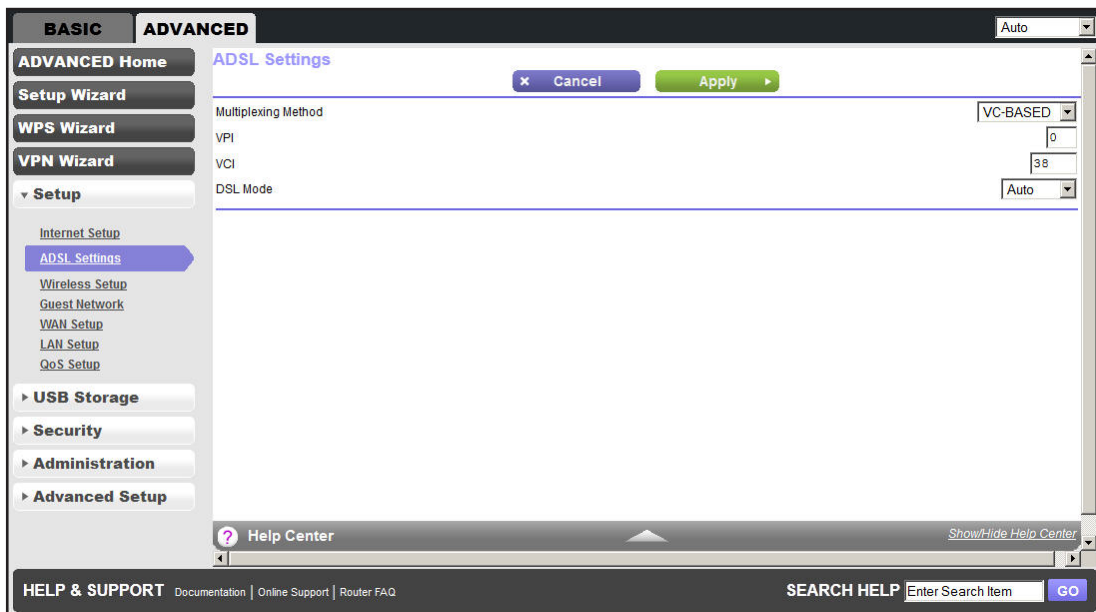

2. Configure the following settings:
 - **Multiplexing Method.** Your ISP indicates whether your multiplexing method is VC-BASED or LLC-BASED.
 - **VPI, VCI.** Your ISP indicates which VPI and VCI combination is used for your service.
 - **DSL Mode.** Your ISP indicates that the best setting is used for your DSL connection.
3. Click **Apply**.

WAN Setup

The WAN Setup screen lets you configure the WAN (Internet) port.

➤ **To configure the WAN:**

1. Select **ADVANCED > Setup > WAN Setup**.

The screenshot displays the 'WAN Setup' configuration page in the NETGEAR genie interface. The page is divided into a left sidebar and a main content area. The sidebar includes navigation options such as 'ADVANCED Home', 'Setup Wizard', 'WPS Wizard', 'VPN Wizard', and a 'Setup' menu with sub-items like 'Internet Setup', 'ADSL Settings', 'Wireless Setup', 'Guest Network', 'WAN Setup' (highlighted), 'LAN Setup', and 'QoS Setup'. Below these are sections for 'USB Storage', 'Security', 'Administration', and 'Advanced Setup'. The main content area is titled 'WAN Setup' and contains several settings: 'WAN Preference' set to 'Auto-Detect', a checkbox for 'Disable Port Scan and DoS Protection', 'Default DMZ Server' set to '10.0.0.2', a checkbox for 'Respond to Ping on Internet Port', 'MTU Size (in bytes)' set to '1500', 'NAT Filtering' set to 'Secured', and a checkbox for 'Disable SIP ALG'. At the bottom, there is a 'Help Center' link and a search bar.

2. Configure the following settings:

- **WAN Preference.** Select your WAN preference: Auto Detect, Must use DSL WAN, or Must use Ethernet WAN.
- **Disable Port Scan and DoS Protection.** DoS protection protects your LAN against denial of service attacks such as Syn flood, Smurf Attack, Ping of Death, Teardrop Attack, UDP Flood, ARP Attack, Spoofing ICMP, Null Scan, and many others. This feature should be disabled only in special circumstances.
- **Default DMZ Server.** This feature is sometimes helpful when you are playing online games or videoconferencing. Be careful when using this feature because it makes the firewall security less effective. For more information, see [Default DMZ Server](#) on page 48.
- **Respond to Ping on Internet Port.** If you want the WiFi DSL modem router to respond to a ping from the Internet, select this check box. Use this feature only as a diagnostic tool because it allows your WiFi DSL modem router to be discovered. Do not select this check box unless you have a specific reason.
- **MTU Size (in bytes).** The normal MTU (maximum transmit unit) value for most Ethernet networks is 1500 bytes, or 1492 bytes for PPPoE connections. For some ISPs, you might need to reduce the MTU. This change is rarely required, and should not be done unless you are sure that it is necessary for your ISP connection. See [Change the MTU Size](#) on page 48.

- **NAT Filtering.** Network Address Translation (NAT) determines how the WiFi DSL modem router processes inbound traffic. Secured NAT provides a secured firewall to protect the computers on the LAN from attacks from the Internet, but might prevent some Internet games, point-to-point applications, or multimedia applications from functioning. Open NAT provides a much less secured firewall, but allows almost all Internet applications to function.
- **Disable SIP ALG.** Some VoIP applications do not work well with the SIP ALG. Selecting this check box to turn off the SIP ALG might help your VoIP devices to create or accept a call through the router.

3. Click **Apply**.

Default DMZ Server

The default DMZ server feature is helpful when you are using some online games and videoconferencing applications that are incompatible with Network Address Translation (NAT). The WiFi DSL modem router is programmed to recognize some of these applications and to work correctly with them, but other applications might not function well. In some cases, one local computer can run the application correctly if that computer's IP address is entered as the default DMZ server.



WARNING:

DMZ servers pose a security risk. A computer designated as the default DMZ server loses much of the protection of the firewall and is exposed to exploits from the Internet. If compromised, the DMZ server computer can be used to attack other computers on your network.

Incoming traffic from the Internet is discarded by the WiFi DSL modem router unless the traffic is a response to one of your local computers or a service that you have configured in the Port Forwarding/Port Triggering screen. Instead of discarding this traffic, you can forward it to one computer on your network. This computer is called the default DMZ server.

➤ **To set up a default DMZ server:**

1. Select **ADVANCED > Setup > WAN Setup**.
2. Select the **Default DMZ Server** check box.
3. Type the IP address.
4. Click **Apply**.

Change the MTU Size

The maximum transmission unit (MTU) is the largest data packet a network device transmits. When one network device communicates across the Internet with another, the data packets travel through many devices along the way. If any device in the data path has a lower MTU

setting than the other devices, the data packets have to be split or “fragmented” to accommodate the device with the smallest MTU.

The best MTU setting for NETGEAR equipment is often just the default value, and changing the value might fix one problem but cause another. Leave the MTU unchanged unless one of these situations occurs:

- You have problems connecting to your ISP or other Internet service, and the technical support of either the ISP or NETGEAR recommends changing the MTU setting. These web-based applications might require an MTU change:
 - A secure website that does not open, or displays only part of a web page
 - Yahoo email
 - MSN portal
 - America Online’s DSL service
- You use VPN and have severe performance problems.
- You used a program to optimize MTU for performance reasons, and now you have connectivity or performance problems.

Note: An incorrect MTU setting can cause Internet communication problems such as the inability to access certain websites, frames within websites, secure login pages, or FTP or POP servers.

If you suspect an MTU problem, a common solution is to change the MTU to 1400. If you are willing to experiment, you can gradually reduce the MTU from the maximum value of 1500 until the problem goes away. The following table describes common MTU sizes and applications.

Table 8. Common MTU sizes

MTU	Application
1500	The largest Ethernet packet size. This is the typical setting for non-PPPoE, non-VPN connections, and is the default value for NETGEAR WiFi DSL modem routers, adapters, and switches.
1492	Used in PPPoE environments.
1472	Maximum size to use for pinging. (Larger packets are fragmented.)
1468	Used in some DHCP environments.
1460	Usable by AOL if you do not have large email attachments, for example.
1436	Used in PPTP environments or with VPN.
1400	Maximum size for AOL DSL.
576	Typical value to connect to dial-up ISPs.

➤ **To change the MTU size:**

1. Select **ADVANCED > Setup > WAN Setup**.
2. In the MTU Size field, enter a new size from 64 through 1500.
3. Click **Apply**.

LAN Setup

The LAN Setup screen allows configuration of LAN IP services such as Dynamic Host Configuration Protocol (DHCP) and Routing Information Protocol (RIP).

The WiFi DSL modem router is shipped preconfigured to use private IP addresses on the LAN side and to act as a DHCP server. The WiFi DSL modem router's default LAN IP configuration is:

- LAN IP address. **192.168.0.1**
- Subnet mask. **255.255.255.0**

These addresses are part of the designated private address range for use in private networks and should be suitable for most applications. If your network requires a different IP addressing scheme, make changes in the LAN Setup screen.

Note: If you change the LAN IP address of the WiFi DSL modem router while connected through the browser, you are disconnected. You have to open a new connection to the new IP address and log in again.

➤ To change the LAN settings:

1. Select **ADVANCED > Setup > LAN Setup**.

2. Enter the settings that you want to customize.

These settings are described in the following section, [LAN Setup Screen Settings](#).

3. Click **Apply**.

LAN Setup Screen Settings

You can configure the settings described in the following sections:

LAN TCP/IP Setup

- **IP Address.** The LAN IP address of the WiFi DSL modem router.
- **IP Subnet Mask.** The LAN subnet mask of the WiFi DSL modem router. Combined with the IP address, the IP subnet mask allows a device to know which other addresses are local to it, and which have to be reached through a gateway or WiFi DSL modem router.
- **RIP Direction.** Router Information Protocol (RIP) allows a router to exchange routing information with other routers. This setting controls how the router sends and receives RIP packets. Both is the default setting. With the Both or Out Only setting, the router broadcasts its routing table periodically. With the Both or In Only setting, the router incorporates the RIP information that it receives.
- **RIP Version.** This setting controls the format and the broadcasting method of the RIP packets that the WiFi DSL modem router sends. It recognizes both formats when receiving. By default, the RIP function is disabled.
 - **RIP-1** is universally supported. It is adequate for most networks, unless you have an unusual network setup.

- **RIP-2** carries more information. Both RIP-2B and RIP-2M send the routing data in RIP-2 format. RIP-2B uses subnet broadcasting. RIP-2M uses multicasting.

Use Router as DHCP Server

This check box is selected so that the WiFi DSL modem router functions as a Dynamic Host Configuration Protocol (DHCP) server.

- **Starting IP Address.** Specify the start of the range for the pool of IP addresses in the same subnet as the WiFi DSL modem router.
- **Ending IP Address.** Specify the end of the range for the pool of IP addresses in the same subnet as the WiFi DSL modem router.

For more information, see *Use the WiFi DSL Modem Router as a DHCP Server* on page 52.

Address Reservation

When you specify a reserved IP address for a computer on the LAN, that computer receives the same IP address each time it accesses the WiFi DSL modem router's DHCP server. Assign reserved IP addresses to servers that require permanent IP settings. For more information, see *Address Reservation* on page 53.

Use the WiFi DSL Modem Router as a DHCP Server

By default, the WiFi DSL modem router functions as a DHCP server, allowing it to assign IP, DNS server, and default gateway addresses to all computers connected to the WiFi DSL modem router's LAN. The assigned default gateway address is the LAN address of the WiFi DSL modem router. The WiFi DSL modem router assigns IP addresses to the attached computers from a pool of addresses specified in this screen. Each pool address is tested before it is assigned to avoid duplicate addresses on the LAN. For most applications, the default DHCP and TCP/IP settings of the WiFi DSL modem router are satisfactory.

You can specify the pool of IP addresses that are assigned by setting the starting IP address and ending IP address. These addresses should be part of the same IP address subnet as the WiFi DSL modem router's LAN IP address. Using the default addressing scheme, you should define a range between 192.168.0.2 and 192.168.0.254, although you might want to save part of the range for devices with fixed addresses.

The WiFi DSL modem router delivers the following parameters to any LAN device that requests DHCP:

- An IP address from the range that you have defined
- Subnet mask
- Gateway IP address (the WiFi DSL modem router's LAN IP address)
- DNS server IP address (the WiFi DSL modem router's LAN IP address)

To use another device on your network as the DHCP server, or to manually configure the network settings of all of your computers, clear the **Use Router as DHCP Server** check box and click **Apply**. Otherwise, leave this check box selected. If this service is not enabled and

no other DHCP server is available on your network, you need to set your computers' IP addresses manually or they are not able to access the WiFi DSL modem router.

Address Reservation

When you specify a reserved IP address for a computer on the LAN, that computer always receives the same IP address each time it accesses the WiFi DSL modem router's DHCP server. Reserved IP addresses should be assigned to computers or servers that require permanent IP settings.

➤ To reserve an IP address:

1. Select **ADVANCED > Setup > LAN Setup**.
2. In the Address Reservation section of the screen, click the **Add** button.

Address Reservation Table				
	#	IP Address	Device Name	MAC Address
<input type="radio"/>	0	10.0.0.2	USER-HP	70:F3:95:B1:E0:5A

IP Address: . . .

MAC Address:

Device Name:

3. In the IP Address field, type the IP address to assign to the computer or server. (Choose an IP address from the WiFi DSL modem router's LAN subnet, such as 192.168.0.x.)
4. Type the MAC address of the computer or server.

Tip: If the computer is already on your network, you can copy its MAC address from the Attached Devices screen and paste it here.

5. Click **Apply**.

The reserved address is not assigned until the next time the computer contacts the WiFi DSL modem router's DHCP server. Reboot the computer, or access its IP configuration and force a DHCP release and renew.

➤ To edit or delete a reserved address entry:

1. Select the radio button next to the reserved address you want to edit or delete.
2. Click one of the following buttons: **Edit** or **Delete**.

Quality of Service Setup

Quality of Service (QoS) is an advanced feature that can be used to prioritize some types of traffic ahead of others. The WiFi DSL modem router can provide QoS prioritization over the wireless link and on the Internet connection.

WMM (Wireless Multimedia) is a subset of the 802.11e standard. WMM allows wireless traffic to have a range of priorities depending on the type of data. Time-dependent information, such as video and audio, has a higher priority than normal traffic. For WMM to function correctly, wireless clients have to support WMM also.

For an application to receive the benefits of WMM QoS, both the application and the client running that application must have WMM enabled. Legacy applications that do not support WMM and applications that do not require QoS are assigned to the best effort category, which receives a lower priority than voice and video.

➤ To configure QoS:

1. Select **ADVANCED > Setup > QoS Setup**.

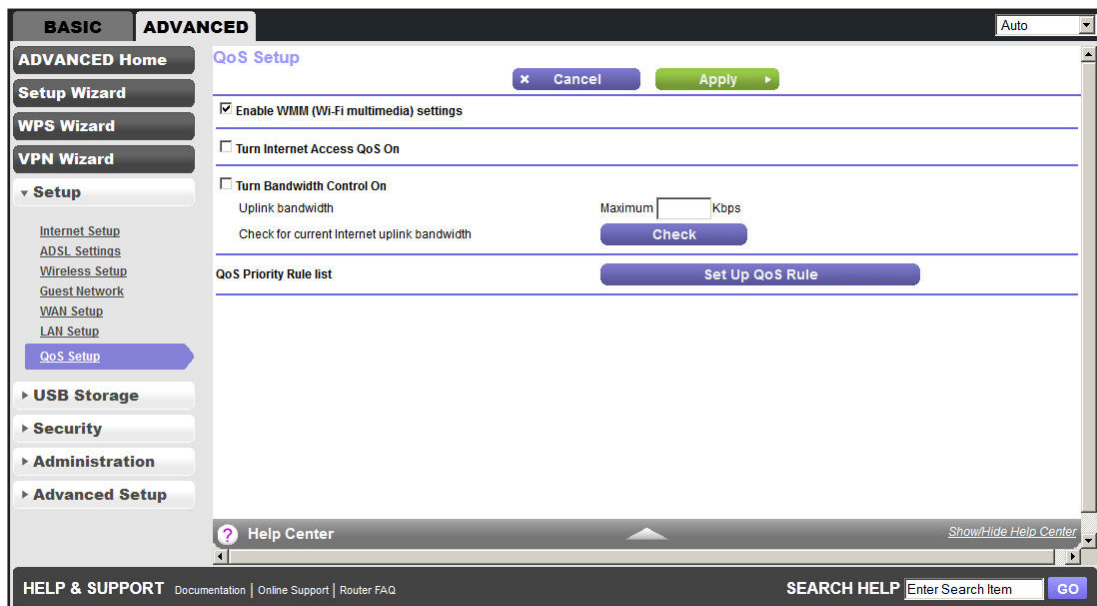

2. (Optional) Clear the **Enable WMM (Wi-Fi multimedia) settings** check box.
WMM QoS is disabled.
3. Select the **Turn Internet Access QoS On** check box.
Internet traffic is prioritized.
4. Select the **Turn Bandwidth Control On** check box.
You can specify the maximum uplink bandwidth.

5. Click **Set Up QoS Rule**.

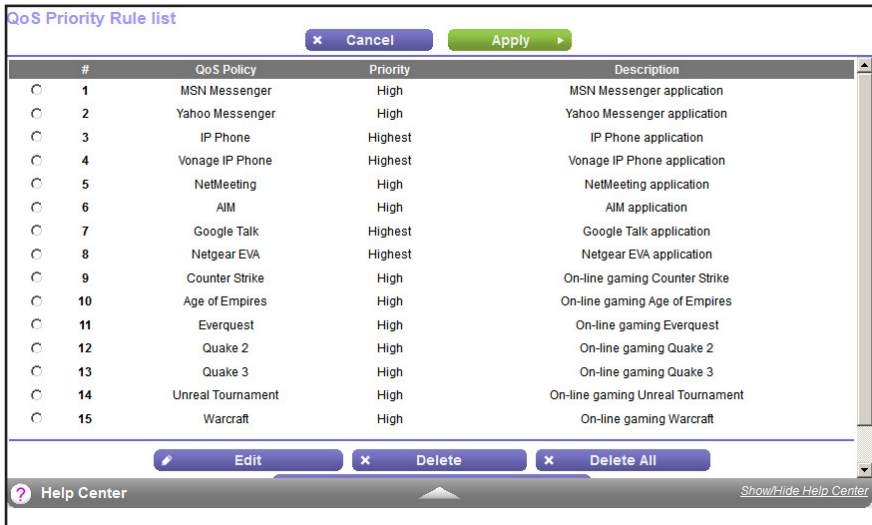

6. Select the radio button next to the QoS policy to edit or delete, and do one of the following:
- To remove the QoS policy, click **Delete**.
 - To edit the QoS policy, click **Edit**.
 - To add a priority rule, click **Add Priority Rule**. For more information, see [Add a Priority Rule](#) on page 55.

Follow the instructions in the succeeding sections to change the policy settings.

7. Click **Apply**.

Add a Priority Rule

➤ **To add a priority rule:**

1. Select **ADVANCED > Setup > QoS Setup**, and then click **Set Up QoS Rule**.
2. Click **Add Priority Rule**.

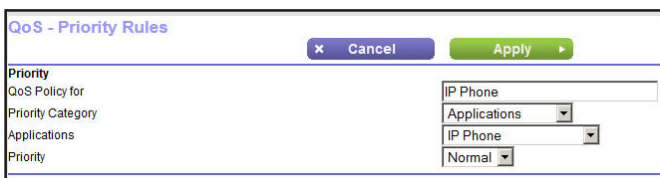

You can define the priority policy for each online game, application, LAN port, or the computer's MAC address.

For more information, see [Priority Policies for Applications and Online Games](#) on page 56, [Priority Policies for Ethernet LAN Ports](#) on page 57, and [Priority Policies for MAC Addresses](#) on page 57.

3. Click **Apply**.

Priority Policies for Applications and Online Games

➤ To add priority policies for applications and online games:

1. Select **ADVANCED > Setup > QoS Setup**, click **Set Up QoS Rule**, and then click **Add Priority Rule**.
2. From the Priority Category list, select **Applications** or **Online Gaming**.

QoS - Priority Rules

Cancel Apply

Priority

QoS Policy for

Priority Category

Applications

Priority

QoS - Priority Rules

Cancel Apply

Priority

QoS Policy for

Priority Category

Applications

Priority

3. Select the Internet application or game from the list that displays.
4. (Optional) In the Applications list, you can select an existing item, or you can scroll and select **Add a New Application** or **Add a New Game**, as applicable.

When you add an entry, the QoS - Priority Rules screen expands.

QoS - Priority Rules

Cancel Apply

Priority

QoS Policy for

Priority Category

Applications

Priority

Specified Port Range

Connection Type

Starting Port

Ending Port

QoS - Priority Rules

Cancel Apply

Priority

QoS Policy for

Priority Category

Applications

Priority

Specified Port Range

Connection Type

Starting Port

Ending Port

5. In the QoS Policy for field, enter a descriptive name for the new application or game.
6. In the Connection Type list, select either **TCP**, **UDP**, or both (**TCP/UDP**), and specify the port number or range of port numbers used by the application or game.
7. Select the priority level: **Highest**, **High**, **Normal**, or **Low**.
8. In the QoS Policy for field, type the name for this rule.
9. Click **Apply**.

Priority Policies for Ethernet LAN Ports

➤ To add priority policies for Ethernet LAN ports:

1. Select **ADVANCED > Setup > QoS Setup**, click **Set Up QoS Rule**, and then click **Add Priority Rule**.
2. From the Priority Category list, select **Ethernet LAN Port**.

The screenshot shows the 'QoS - Priority Rules' configuration window. It has a 'Cancel' button and an 'Apply' button. The form contains the following fields:

- QoS Policy for:** LAN Port 1
- Priority Category:** Ethernet LAN Port
- LAN Port:** 1
- Priority:** Normal

3. Select the number of the LAN port for which you want to specify the priority level.
4. Select the priority level: **Highest**, **High**, **Normal**, or **Low**.
5. You can also type the name for this rule in the QoS Policy for field.
6. Click **Apply**.

Priority Policies for MAC Addresses

➤ To add priority policies for MAC addresses:

1. Select **ADVANCED > Setup > QoS Setup**, click **Set Up QoS Rule**, and then click **Add Priority Rule**.
2. From the Priority Category list, select **MAC Address**.

The screenshot shows the 'QoS - Priority Rules' configuration window. It has a 'Cancel' button and an 'Apply' button. The form contains the following fields:

- QoS Policy for:** LAN Port 1
- Priority Category:** MAC Address
- LAN Port:** 1
- Priority:** Normal

3. Click **Refresh** to update the list of those computers already connected to the router.
4. Select the entry's radio button in the table.
5. Modify the information in the MAC Address and Device Name fields.
6. Select the priority level: **Highest**, **High**, **Normal**, or **Low**.
7. You can also type the name for this rule in the QoS Policy for field.
8. Click **Apply**.

USB Storage

5

Access and configure a USB storage drive

This chapter describes how to access and configure a USB storage drive attached to your WiFi DSL modem router. The USB port on the WiFi DSL modem router can connect only to USB devices like flash drives, hard drives, and printers. Do not connect computers, USB modems, CD drives, or DVD drives to the WiFi DSL modem router USB port.

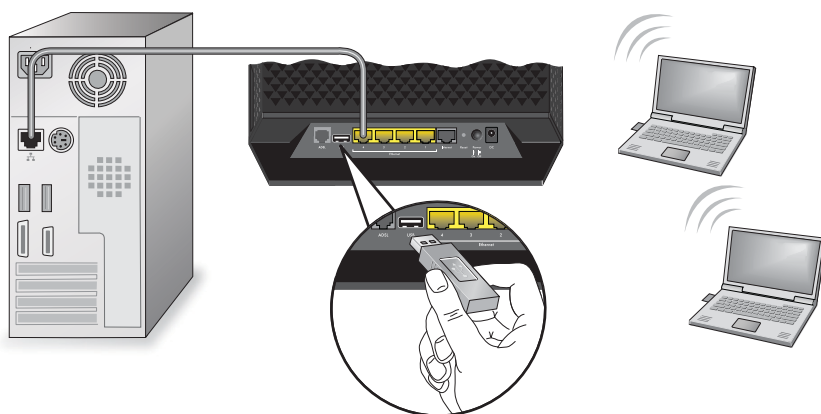

This chapter contains the following sections:

- *USB Drive Requirements*
- *ReadySHARE Access*
- *File-Sharing Scenarios*
- *USB Storage Basic Settings*
- *USB Storage Advanced Settings*
- *Media Server Settings*
- *Specify Approved USB Devices*
- *Connect to the USB Drive from a Remote Computer*
- *Safely Remove a USB Drive*

USB Drive Requirements

The WiFi DSL modem router works with 1.0 and 1.1 (USB Full Speed) and 2.0 (USB High Speed) standards. The approximate USB bus speeds are shown in the following table. Actual bus speeds can vary, depending on the CPU speed, memory, speed of the network, and other variables.

Table 9. USB drive speeds

Bus	Speed/Sec
USB 1.1	12 Mbits
USB 2.0	480 Mbits

The WiFi DSL modem router should work with most USB-compliant external flash and hard drives. For the most up-to-date list of USB drives supported by the WiFi DSL modem router, visit:

<http://kbserver.netgear.com/readystatechange>

The WiFi DSL modem router supports both read and write access for FAT16, FAT32, and NTFS.

Note: Some USB external hard drives and flash drives require drivers to be loaded into the computer before the computer can access the USB device. Such USB devices do not work with the WiFi DSL modem router.

ReadySHARE Access

Once you have set up your WiFi DSL modem router, you can connect any USB storage device and share the contents with other users on your network.

You can access your USB device in any of the following ways:

- On Windows 7, Windows XP, Windows Vista, and Windows 2000 systems, select **Start > Run** and enter **\\readyshare** in the dialog box. Click **OK**.
- On Windows 7, Windows XP, Windows Vista, and Windows 2000 systems, open either Internet Explorer or Safari, and enter **\\readyshare** in the address bar.
- On Mac OS X (version 10.2 or later), enter **smb://readyshare** in the address bar.
- In My Network Places, enter **\\readyshare** in the address bar.

File-Sharing Scenarios

You can share files on the USB drive for a wide variety of business and recreational purposes. The files can be any Windows, Mac, or Linux file type including text, Word, PowerPoint, Excel, and MP3 files, pictures, and multimedia. USB drive applications include:

- Sharing multimedia such as MP3 files, pictures, and other multimedia with local and remote users.
- Sharing resources on your network. You might want to store files in a central location so that you do not need to power up a computer to perform local sharing. In addition, you can share files between Macintosh, Linux, and Windows computers by using the USB drive as a go-between across the systems.
- Sharing files such as Word documents, PowerPoint presentations, and text files with remote users.

A few common uses are described in the following sections.

Share Photos

You can create your own central storage location for photos and multimedia. This approach eliminates the need to log in to (and pay for) an external photo-sharing site.

➤ To share files with your friends and family:

1. Insert your USB drive into the USB port on the WiFi DSL modem router either directly or with a USB cable.

Computers on your local area network (LAN) can automatically access this USB drive using a web browser or Microsoft Networking.

2. If you want to specify read-only access or to allow access from the Internet, see *USB Storage Advanced Settings* on page 64.

Store Files in a Central Location for Printing

This scenario is for a family that has one high-quality color printer directly attached to a computer, but not shared on the local area network (LAN). This family does not have a print server.

- One family member has photos on a Macintosh computer that she wants to print.
- The photo-capable color printer is directly attached to a computer, but not shared on the network.
- The Mac and Windows computer are not visible to each other on the network.

➤ To print photos from a Mac on the printer attached to a Windows computer:

1. On the Mac, access the USB drive by typing `\\readysare` in the address field of a web browser. Then copy the photos to the USB drive.
2. On the Windows computer, use a web browser or Microsoft Networking to copy the files from the USB drive to the Windows computer. Then print the files.

Share Large Files over the Internet

Sending files that are larger than 5 MB can pose a problem for many email systems. The WiFi DSL modem router allows you to share large files such as PowerPoint presentations or .zip files over the Internet. FTP can be used to easily download shared files from the WiFi DSL modem router.

Sharing files with a remote colleague involves the following considerations:

- There are two user accounts: admin and guest. The password for admin is the same one that you use to access the WiFi DSL modem router. By default, it is **password**. The guest user account has no password.
- On the FTP site, the person receiving the files should use the guest user account and enter any password (FTP requires that you type something in the password field).
- Be sure to select the **FTP (via Internet)** check box in the USB Storage (Advanced Settings) screen. This option supports both downloading and uploading of files.

Note: You can enable the HTTP (via Internet) option on the USB Storage (Advanced Settings) screen to share large files. This option supports downloading files only.

USB Storage Basic Settings

You can view or edit basic settings for the USB storage device attached to your WiFi DSL modem router.

➤ To access your USB device:

1. Select **ADVANCED > USB Storage > ReadySHARE**.

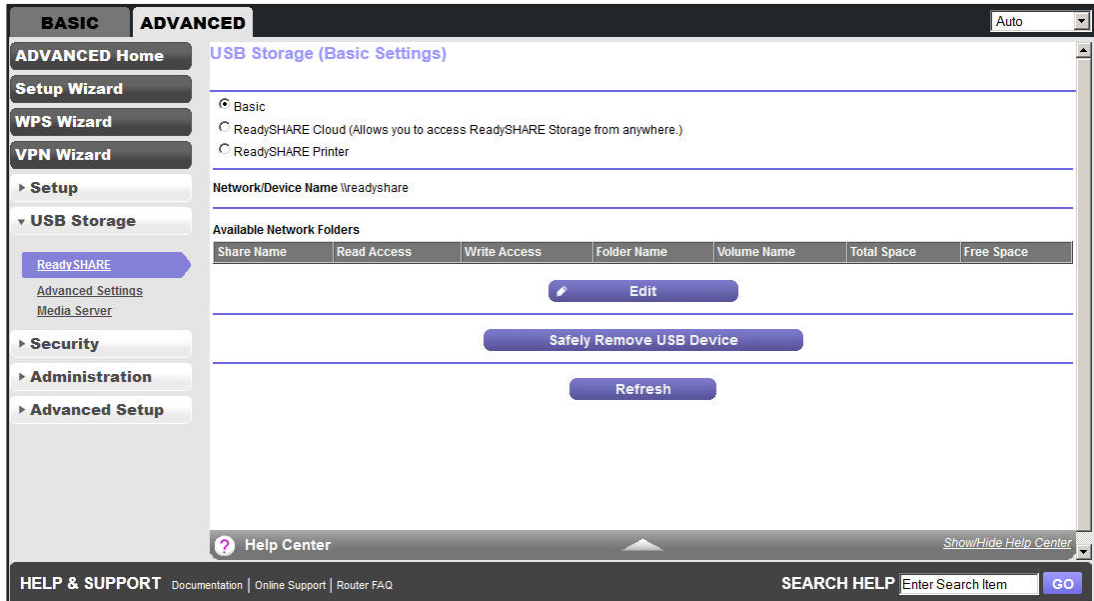

You can also access this screen by selecting **BASIC > ReadySHARE**.

By default, the USB storage device is available to all computers on your local area network (LAN).

2. Click the network device name or the share name in your computer's network folders list.
3. For SMB://readysshare, click **Edit**.

Note: If you logged in to the WiFi DSL modem router before you connected your USB device, you might not see your USB device in the WiFi DSL modem router screens until you log out and then log back in again.

Add or Edit a Network Folder

➤ To add or edit a network folder:

1. Select **ADVANCED > USB Storage > Advanced Settings**.

The screenshot shows the 'USB Storage (Advanced Settings)' page. The left sidebar has 'ADVANCED' selected, and 'USB Storage' is expanded to 'Advanced Settings'. The main content area includes:

- Buttons for 'Refresh' and 'Apply'.
- Input fields for 'Network/Device Name' (readystatechange) and 'Workgroup' (Workgroup).
- A table with columns: Enable, Access Method, Link, and Port.

Enable	Access Method	Link	Port
<input checked="" type="checkbox"/>	Network Connection	\\readystatechange	-
<input checked="" type="checkbox"/>	HTTP	http://readystatechange.routerlogin.net/shares	80
<input type="checkbox"/>	HTTPS (via internet)	https://192.168.0.11:443/shares	443
<input type="checkbox"/>	FTP	ftp://readystatechange.routerlogin.net/shares	21
<input type="checkbox"/>	FTP (via internet)	ftp://192.168.0.11:21/shares	21
- 'Available Network Folders' section with a table:

Share Name	Read Access	Write Access	Folder Name	Volume Name	Total Space	Free Space
- Buttons: 'Edit', 'Create Network Folder', 'Delete', and 'Safely Remove USB Device'.
- 'Help Center' link and 'Show/Hide Help Center' button.
- 'HELP & SUPPORT' section with links for 'Documentation', 'Online Support', and 'Router FAQ', and a 'SEARCH HELP' field.

You can also access this screen by selecting **BASIC > ReadyShare > Edit**.

2. Specify the changes that you want to make:
 - To add a folder, click **Create Network Folder**.
 - To edit a folder, select its radio button and click **Edit**.
3. Make any of the following changes: Select a folder, change the share name, or change the read access or write access from All - no password to **admin**.

The user name (account name) for All - no password is guest. The password for admin is the same one that is used to log in to the WiFi DSL modem router. By default, it is password.

4. Click **Apply**.

USB Storage Advanced Settings

You can set up the device name, workgroups, and network folders for your USB device.

➤ **To configure the advanced USB storage settings:**

1. Select **Advanced > USB Storage > Advanced Settings**.

The screenshot shows the 'USB Storage (Advanced Settings)' page. The 'Network/Device Name' is set to 'readyshare' and the 'Workgroup' is 'Workgroup'. The 'Enable' section has a table with the following data:

Enable	Access Method	Link	Port
<input checked="" type="checkbox"/>	Network Connection	\\readyshare	-
<input checked="" type="checkbox"/>	HTTP	http://readyshare.routerlogin.net/shares	80
<input type="checkbox"/>	HTTPS (via internet)	https://192.168.0.11:443/shares	443
<input type="checkbox"/>	FTP	ftp://readyshare.routerlogin.net/shares	21
<input type="checkbox"/>	FTP (via internet)	ftp://192.168.0.11:21/shares	21

The 'Available Network Folders' section has a table with columns: Share Name, Read Access, Write Access, Folder Name, Volume Name, Total Space, Free Space. Below the table are buttons for 'Edit', 'Create Network Folder', and 'Delete'. At the bottom, there is a 'Safely Remove USB Device' button.

2. Configure the following settings:

- **Network Device Name.** The default is ReadySHARE. This name is used to access the USB device connected to the WiFi DSL modem router.
- **Workgroup.** If you are using a Windows workgroup rather than a domain, the workgroup name is displayed here. The name works only in an operating system that supports NetBIOS, such as Microsoft Windows.
- **Access Method.** Select any of the following check boxes to enable the access methods.
 - **Network Connection.** Enabled by default, this connection allows all users on the LAN to have access to the USB drive.
 - **HTTP.** Enabled by default. You can type **http://readyshare.routerlogin.net/shares** to access the USB drive.
 - **HTTP (via internet).** Disabled by default. If you select this check box, remote users can type **http://<public IP address>/shares** (for example, **http://1.1.10.102/shares**) or a URL domain name to access the USB drive over the Internet. This feature supports file uploading only.
 - **FTP.** Disabled by default.
 - **FTP (via internet).** Disabled by default. If you select this check box, remote users can access the USB drive through FTP over the Internet. This feature supports both downloading and uploading of files.

3. Click **Apply**.

Available Network Folders. You might need to scroll down to view this section of the screen:

- **Share Name.** If only one device is connected, the default share name is USB_Storage. You can click the name shown, or you can type it in the address field of your web browser. If Not Shared is shown, the default share was deleted and no other share for the root folder exists. Click the link to change this setting.
- **Read Access and Write Access.** Show the permissions and access controls on the network folder: All - no password (the default) allows all users to access the network folder. The password for admin is the same one that you use to log in to the WiFi DSL modem router.
- **Folder Name.** Full path used by the network folder.
- **Volume Name.** Volume name from the storage device (either USB drive or HDD).
- **Total Space and Free Space.** Show the current utilization of the storage device.

For information about how to create or edit a network folder, see [Add or Edit a Network Folder](#) on page 63.

For information about how to remove a USB drive, see [Safely Remove a USB Drive](#) on page 68.

To refresh the screen, click **Refresh**.

Media Server Settings

By default, the WiFi DSL modem router is set up to act as a ReadyDLNA media server, which lets you view movies and photos on DLNA/UPnP AV-compliant media players, such as Xbox360, Playstation, and NETGEAR's Digital Entertainer Live.

➤ To view the media server settings:

1. Select **ADVANCED > USB Storage > Media Server**.

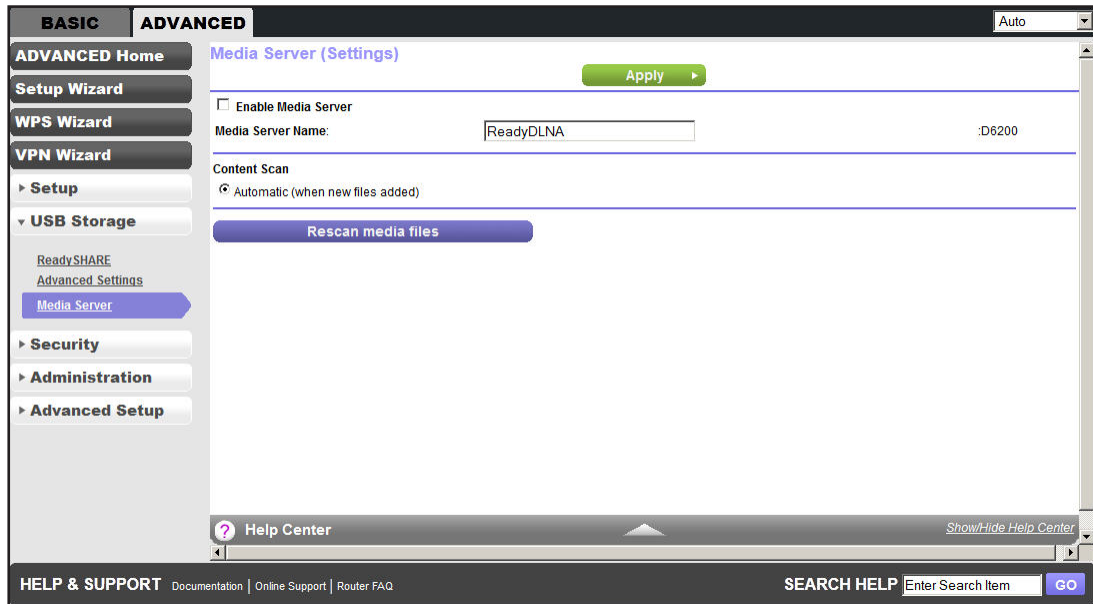

2. Click **Rescan media files**.

By default the Enable Media Server check box and the Automatic (when new files are added) radio button are selected. When these options are selected, the WiFi DSL modem router scans for media files whenever new files are added to the ReadySHARE USB hard drive.

3. Click **Apply**.

Specify Approved USB Devices

For more security, you can set up the WiFi DSL modem router to share approved USB devices only. You can access this feature from the Advanced Setup menu on the Advanced tab.

➤ To add approved USB devices:

1. Select **ADVANCED > Advanced Setup > USB Settings**.



2. Click the **Approved Devices** button.

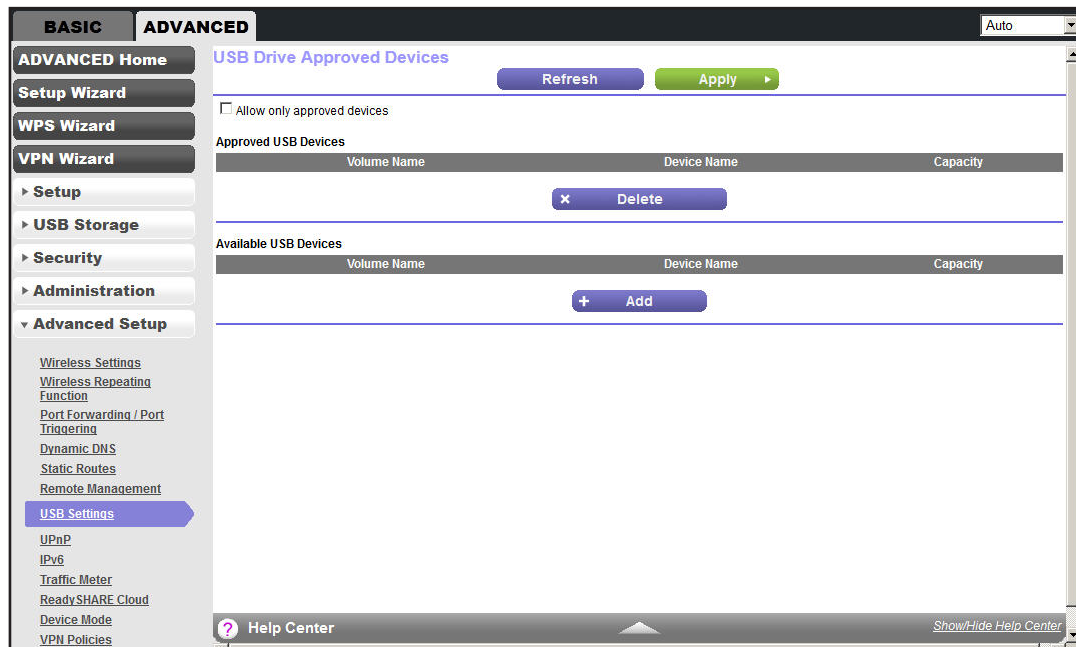

This screen shows the approved USB devices and the available USB devices. You can remove or add approved USB devices.

3. Select the device you want to add from the Available USB Devices list.
4. Click **Add**.
5. Select the **Allow only approved devices** check box.
6. Click **Apply**.

If you want to work with another USB device, you have to click the **Safely Remove USB Device** button for the currently connected USB device. For more information, see [Safely Remove a USB Drive](#) on page 68.

7. Connect the other USB device and repeat this process.

Connect to the USB Drive from a Remote Computer

To connect to the USB drive from remote computers with a web browser, you have to use the WiFi DSL modem router's Internet port IP address. If you are using Dynamic DNS, you can type the DNS name rather than the IP address. You can view the WiFi DSL modem router's Internet IP address from the dashboard on the BASIC Home screen or the ADVANCED Home screen.

Access the WiFi DSL Modem Router USB Drive Remotely Using FTP

- **To connect to the WiFi DSL modem router's USB drive using a web browser:**

1. Connect to the WiFi DSL modem router by typing **ftp://** and the Internet port IP address in the address field of Internet Explorer or Netscape Navigator, for example:

ftp://10.1.65.4

If you are using Dynamic DNS, you can type the DNS name rather than the IP address.

2. Type the account name and password for the account that has access rights to the USB drive.

The user name (account name) for All - no password is **guest**.

The directories of the USB drive that your account can access are displayed, for example, share/partition1/directory1. You can now read and copy files from the USB directory.

Safely Remove a USB Drive

- **To safely remove a USB disk drive so that no users can access it:**

1. Select **ADVANCED > USB Storage > Advanced Settings**.

You can also select **USB Storage > Basic Settings**.

2. Click the **Safely Remove USB Device** button.

This procedure takes the drive offline.

ReadySHARE Printer

6

Access and configure a USB printer

This chapter describes how to access and configure a USB printer attached to your WiFi DSL modem router. If your USB printer supports scanning, you can also use the USB printer for scanning.

The ReadySHARE Printer utility allows you to control from your computer a shared USB printer that is connected to the USB port on your WiFi DSL modem router. You can share this USB printer among the Windows and Mac computers on your network.

You *have to* install this utility before you can use the ReadySHARE Printer feature. Once installed, the ReadySHARE Printer utility displays on your computer as the NETGEAR USB Control Center.

This chapter contains the following sections:

- [Download the ReadySHARE Printer Utility](#)
- [Install the NETGEAR USB Control Center](#)
- [Manage USB Print and Scan Jobs](#)

Note: The USB port on the WiFi DSL modem router can connect only to USB devices like flash drives, hard drives, and printers. Do not connect computers, USB modems, CD drives, or DVD drives to the WiFi DSL modem router USB port.

Download the ReadySHARE Printer Utility

You have to connect the USB printer to your WiFi DSL modem router and install the utility on each computer in your network from which you want to control the USB printer.

➤ To download ReadySHARE Printer:

1. Connect the USB printer to the USB port of the WiFi DSL modem router with a USB printer cable.

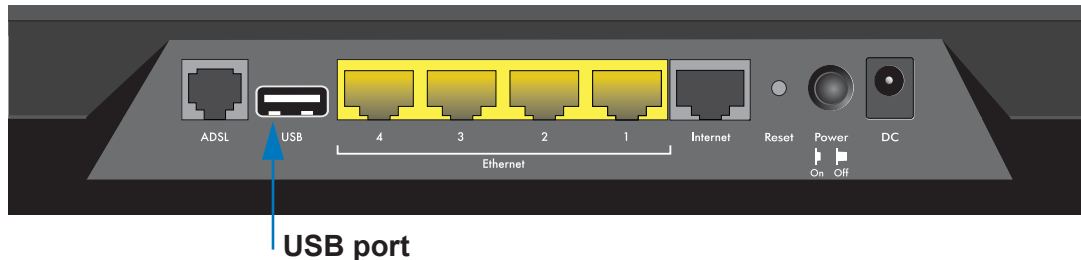

The USB port is on the back of the WiFi DSL modem router.

Note: Some USB printers (for example, the HP and Lexmark printers) request that you do not connect the USB cable until the installation software prompts you.

2. On each computer on your network that shares the USB printer, install the driver software for the USB printer.

If you do not have the printer driver, contact the printer manufacturer to find and download the most recent printer driver software.

3. On each computer on your network that shares the USB printer, download the ReadySHARE Printer utility setup file and instructions.

The ReadySHARE Printer utility has a Mac version and a Windows version. You can access the setup file and instructions through this URL: www.netgear.com/readyspace



You can also access this URL from the ReadySHARE tab of the NETGEAR genie app. For more information, see *NETGEAR genie App* on page 37.

4. On each computer on your network that shares the USB printer, install the ReadySHARE Printer utility.

Once installed, the ReadySHARE Printer utility displays on your computer as the NETGEAR USB Control Center. For more information, see *Install the NETGEAR USB Control Center* on page 72.

Install the NETGEAR USB Control Center

For the ReadySHARE Print feature to work, this utility has to be installed and running in the background on each computer in the network from which you want to control this USB printer.

Once installed, the ReadySHARE Printer utility displays on your computers as the NETGEAR USB Control Center.

➤ **To install the NETGEAR USB Control Center:**

1. On each computer on your network that shares the USB printer, double-click the ReadySHARE Printer utility setup file that you downloaded.

The ReadySHARE Printer utility setup file and instructions can be downloaded through this URL: www.netgear.com/readysare

2. Follow the instructions to install the NETGEAR USB Control Center utility.

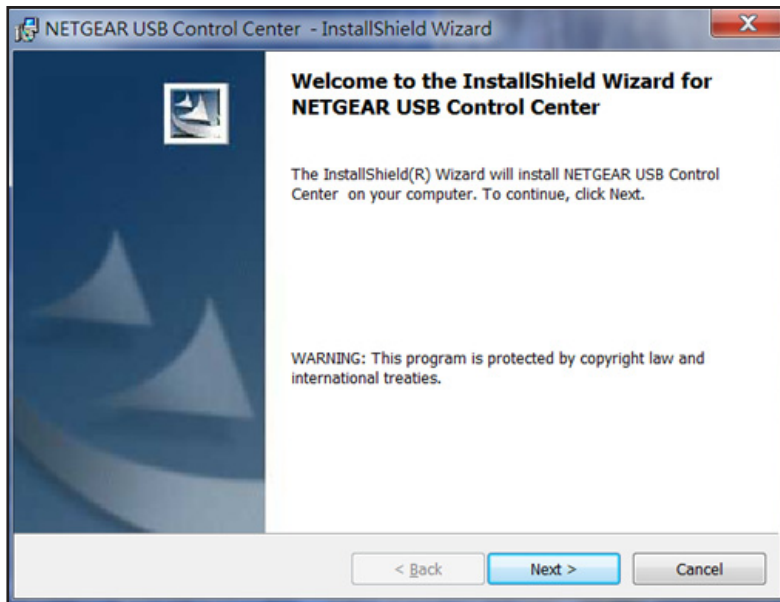

3. Select the language and click **OK**.



This procedure installs the utility.

4. On each computer on your network that shares the USB printer, perform the initial setup of the NETGEAR USB Control Center.

The first time you use the USB printer that is connected to your WiFi DSL modem router, you are asked to select the USB printer. For more information, see [Set Up the NETGEAR USB Control Center](#) on page 73.

5. (Optional) Change the default settings.

For more information, see [Configure the NETGEAR USB Control Center](#) on page 75.

Set Up the NETGEAR USB Control Center

The first time you use the USB printer that is connected to your WiFi DSL modem router, you are asked to select the USB printer.

- When a USB printer is detected and connected automatically during the initial setup, you have to disconnect the printer and wait for the prompt asking you to click Connect.
- You might be asked to install the driver for this printer. After the driver is installed, the printer status changes to Available.

Some firewall software, such as Comodo, blocks the NETGEAR USB Control Center utility from accessing the USB printer. If you do not see the USB printer in the utility, you can disable the firewall temporarily to allow the utility to work.

➤ To perform the initial set up the **NETGEAR USB Control Center**:

1. On each computer on your network that shares the USB printer, launch the NETGEAR USB Control Center the same way you launch any application program on your Windows or MAC computer.

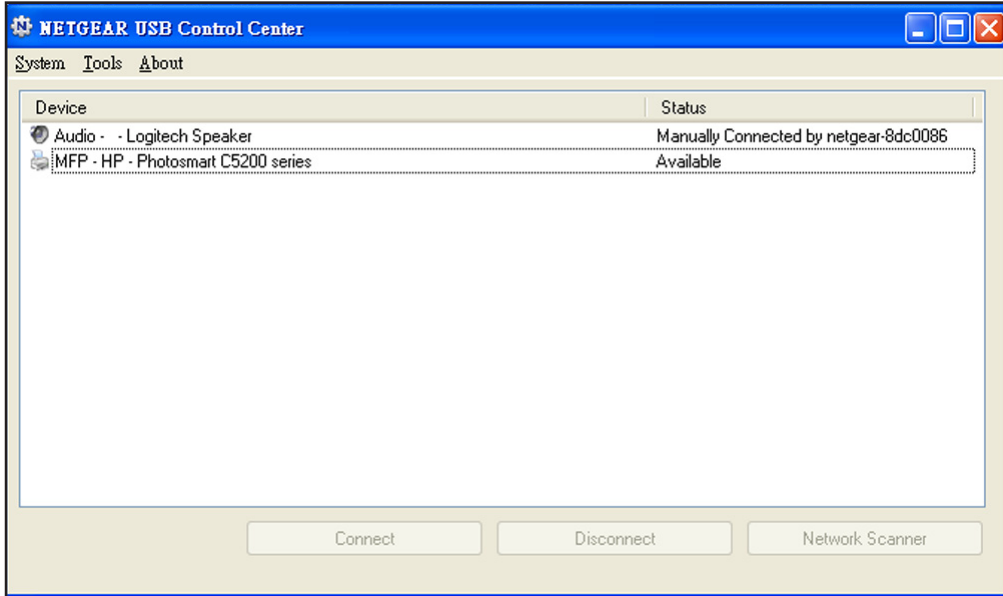

2. Select the printer and click the **Connect** button.

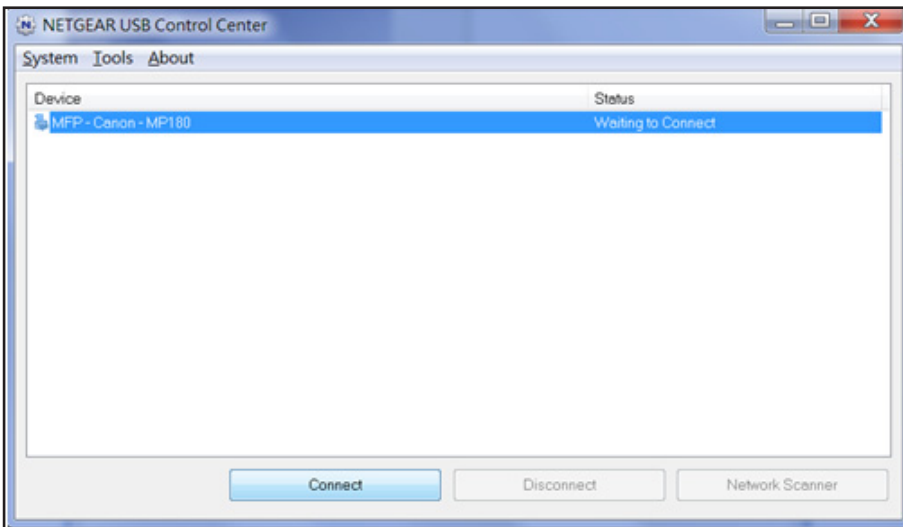

Once the connection is established, the status changes to Manually connected by xxx.

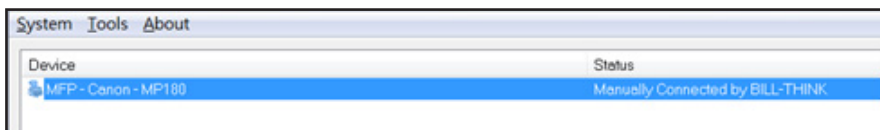

3. Click the **Disconnect** button.

The status then changes to Available.

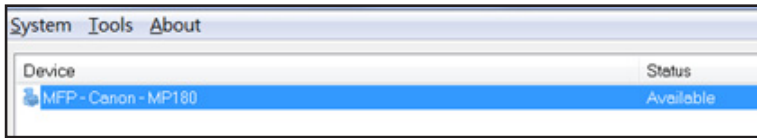

Once the Connect and Disconnect buttons have been clicked once on each of the computers in the network from which you want to control the USB printer, the utility on each of the computers automatically handles the printing queue and handling. The status of the printer appears as Available on all of the computers.

The utility does not always need to hold the connection of a USB printer. For some USB printers after a print job is created, the NETGEAR USB Control Center connects to this USB printer automatically and prints. After the print job is done, the printer status might return to a Paused state.

For example, this USB printer displayed in the Windows Printers and Faxes window is ready for print jobs.

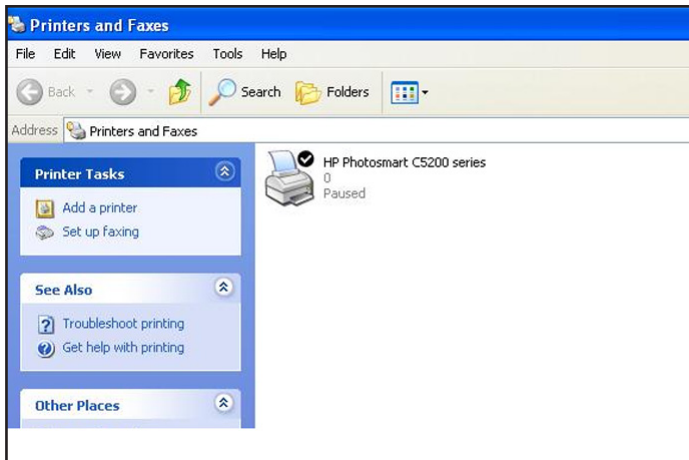

Configure the NETGEAR USB Control Center

You can set the value for the default time-out time and other settings from the Configuration screen.

➤ **To configure the NETGEAR USB Control Center:**

1. Launch the NETGEAR USB Control Center the same way you launch any application program on your Windows or MAC computer.

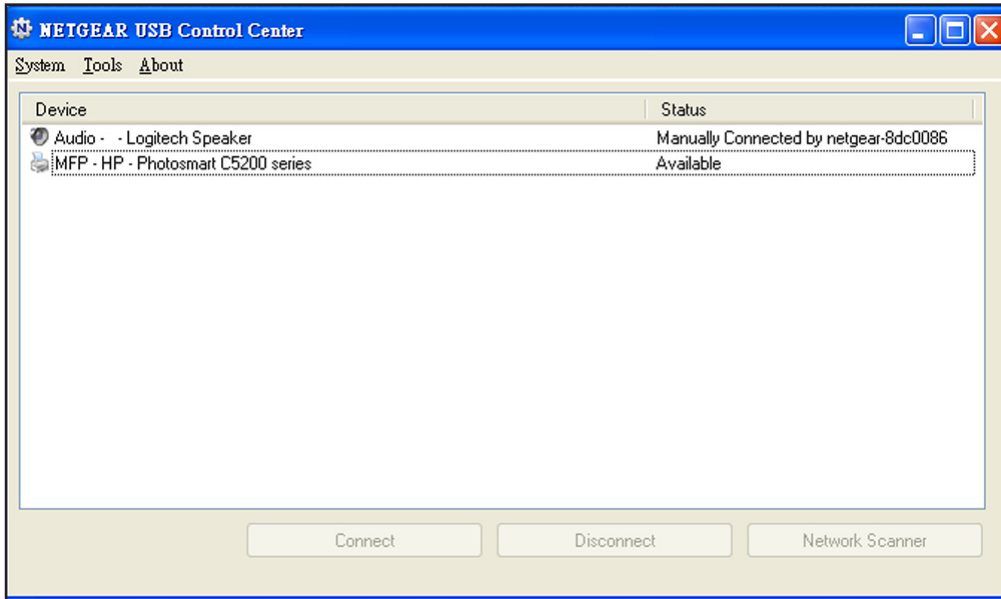

2. Select **Tools > Configuration**.



3. Specify the following settings:
 - **Automatically execute when logging on Windows.** Enable this utility to start automatically when you are logged in to Windows.
 - **Timeout.** Specify the time-out value for holding the USB resource when it is not in use.
 - **Language.** Select the display language for this utility.

4. Click **Apply.**

Your changes are saved.

Manage USB Print and Scan Jobs

The NETGEAR USB Control Center utility runs in the background on each computer in your network. This utility manages the printing queue and handling for the USB printer connected to your WiFi DSL modem router.

After you activate the utility on each computer in the network, the status of the USB printer is Available for all of the computers.

- When the status is Available, you can use the USB printer from any computer in the network. The utility on each computer automatically manages the printing queue and handling. The status of the USB printer appears as Available on all of the computers when no print jobs are in process.
- When the status is Manually connected by xxx, only the xxx computer can use the printer. Other network devices must wait until the xxx computer has released the connection, or until the connection times out (the default time-out value is 30 seconds).

You can click the Disconnect button at any time to release the connection.

You can set the value for the default time-out time from the Configuration screen. For more information, see [Configure the NETGEAR USB Control Center](#) on page 75.

Some firewall software, such as Comodo, blocks the NETGEAR USB Control Center utility from accessing the USB printer. If you do not see the USB printer in the utility, you can disable the firewall temporarily to allow the utility to work.

If your USB printer supports scanning, you can also use the USB printer for scanning. For more information, see [Use the Scan Feature of a Multifunction USB Printer](#) on page 78.

The NETGEAR USB Control Center

The NETGEAR USB Control Center shows the availability status of the USB devices.

The NETGEAR USB Control Center utility must be running for the computer to be able to print to the USB printer attached to the router. If you exit the utility, printing does not work.

➤ **To launch the NETGEAR USB Control Center:**

Launch the NETGEAR USB Control Center the same way you launch any application program on your Windows or MAC computer.

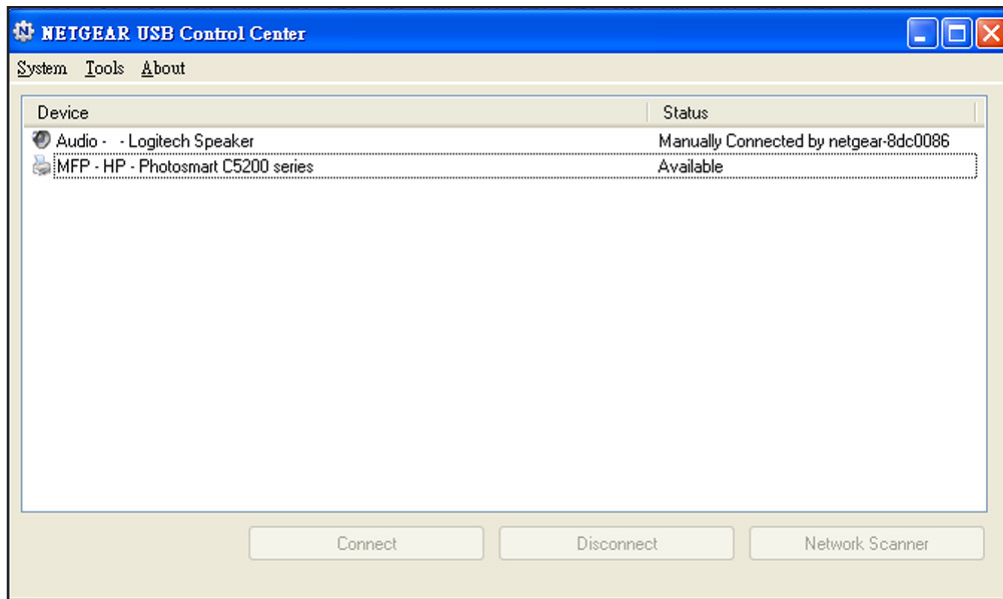

The main screen shows a device icon, the description for this USB device, and its status.

- **Available.** The device is available from the computer that you are using.
- **Waiting to Connect.** You need to connect to this device from the computer that you are using. If this is the first time you are connecting, you might be prompted to install the device driver.

The following menu selections display:

- **System.** Exit the utility.
- **Tools.** Access the Control Center - Configuration screen to set up your shared USB device. For more information, see [Configure the NETGEAR USB Control Center](#) on page 75.
- **About.** View details about the USB Control Center software.

The following control buttons are available:

- **Connect.** If this is the first time you are accessing the utility, you are asked to select the printer and click the Connect button.
- **Disconnect.** Click the Disconnect button at any time to release the connection.
- **Network Scanner.** This button activates the Scanner window so that you can use the printer for scanning. Your printer must support scanning and be in the Available state.

Use the Scan Feature of a Multifunction USB Printer

If your USB printer supports scanning, you can also use the USB printer for scanning.

➤ **To use the scan feature of a multifunction USB printer:**

1. Launch the NETGEAR USB Control Center the same way you launch any application program on your Windows or MAC computer.

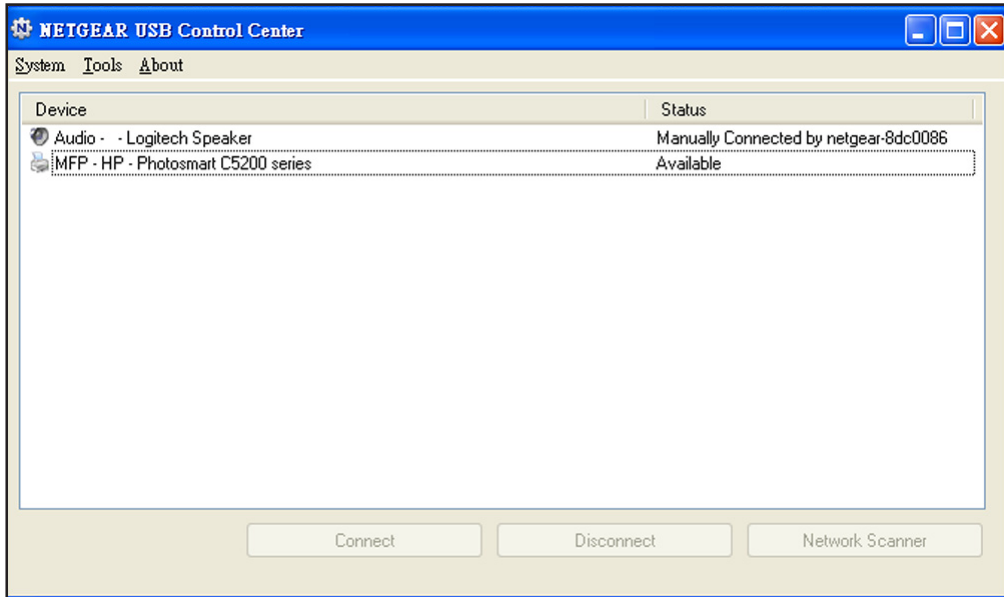

2. Make sure that the printer's status shows as Available.
3. Click the **Network Scanner** button.

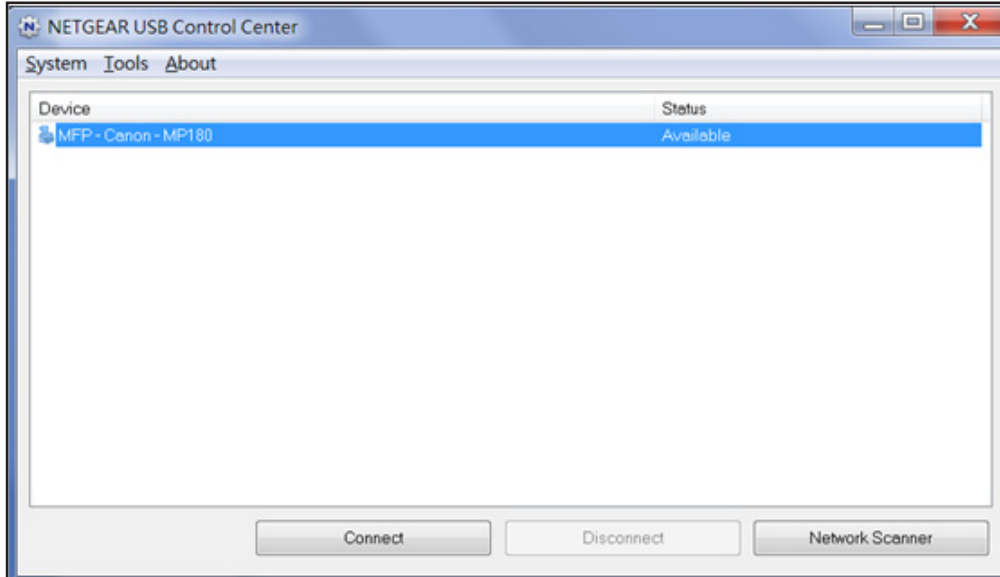

The scanner window opens so you can use the USB printer for scanning.

Security

7

Keep unwanted content out of your network

This chapter explains how to use the basic firewall features of the WiFi DSL modem router to prevent objectionable content from reaching the computers and other devices connected to your network.

This chapter includes the following sections:

- *Keyword Blocking of HTTP Traffic*
- *Firewall Rules*
- *Add Custom Services to Allow or Block*
- *Schedule for Firewall Rules*
- *Security Event Email Notifications*

Keyword Blocking of HTTP Traffic

Use keyword blocking to prevent certain types of HTTP traffic from accessing your network. The blocking can be always or according to a schedule.

1. Select **ADVANCED > Security > Block Sites**.

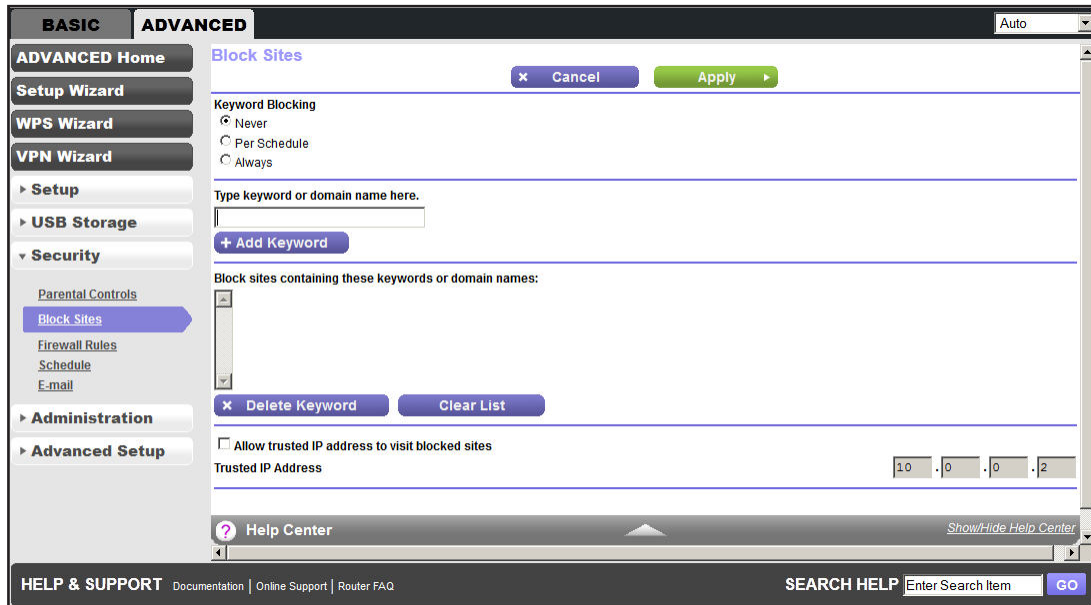

2. Select one of the keyword blocking options:
 - **Per Schedule.** Turn on keyword blocking according to the Schedule screen settings. For more information, see [Schedule for Firewall Rules](#) on page 86.
 - **Always.** Turn on keyword blocking all the time, independent of the Schedule screen.
3. In the Keyword field, enter a keyword or domain, and click **Add Keyword**.
The Keyword list supports up to 32 entries. Here are some sample entries:
 - Specify XXX to block <http://www.badstuff.com/xxx.html>.
 - Specify .com if you want to allow only sites with domain suffixes such as .edu or .gov.
 - Enter a period (.) to block all Internet browsing access.
4. Click **Apply**.

➤ **To delete a keyword or domain:**

1. Select the keyword you want to delete from the list.
2. Click **Delete Keyword**.
3. Click **Apply**

You can exempt one trusted computer from blocking and logging. The computer you exempt must have a fixed IP address.

- **To specify a trusted computer:**
 1. In the Trusted IP Address field, enter the IP address.
 2. Click **Apply**.

Firewall Rules

Services are functions performed by server computers at the request of client computers. For example, web servers serve web pages, time servers serve time and date information, and game hosts serve data about other players' moves. When a computer on the Internet sends a request for service to a server computer, the requested service is identified by a service or port number. This number appears as the destination port number in the transmitted IP packets. For example, a packet that is sent with the destination port number 80 is an HTTP (web server) request.

The service numbers for many common protocols are defined by the Internet Engineering Task Force (IETF at <http://www.ietf.org/>) and published in RFC1700, "Assigned Numbers." Service numbers for other applications are typically chosen from the range 1024–65535 by the authors of the application. Although the WiFi DSL modem router already holds a list of many service port numbers, you are not limited to these choices. You can often determine port number information by contacting the publisher of the application, by asking user groups or newsgroups, or by searching.

Note: This feature is for advanced administrators only! Incorrect configuration can cause serious problems.

➤ To create firewall rules:

1. Select **ADVANCED > Security > Firewall Rules**.

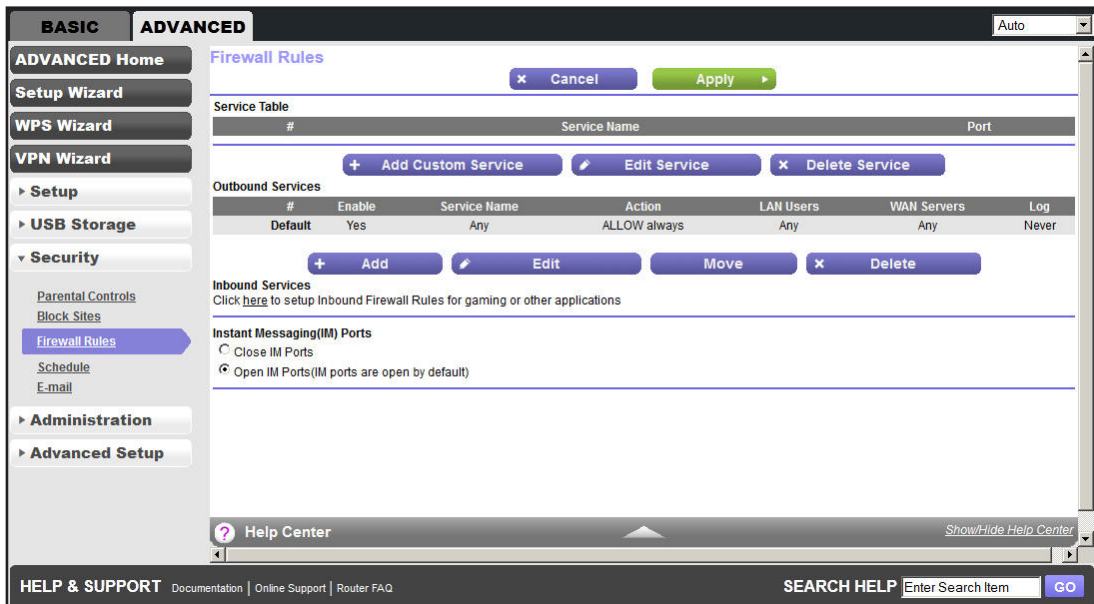

The Firewall Rules screen lists all firewall rule settings. The default rules allow all outgoing traffic and block all incoming traffic.

2. Under Outbound Services, click **Add**.

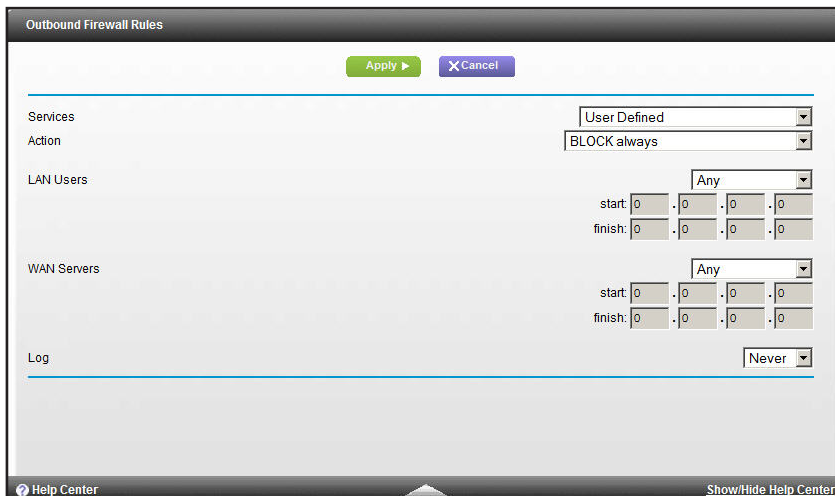

3. Configure the following settings:

- **Service.** Select the service or application to be covered by this rule.
If the service or application you want does not appear in the list, you have to define it as described in *Add Custom Services to Allow or Block* on page 85.
- **Action.** Select the action you want for traffic covered by this rule:
 - **BLOCK always.** Always block the traffic covered by this rule.

- **BLOCK by schedule, otherwise Allow.** Allow the traffic covered by this rule, unless it is blocked according to the schedule specified on the Schedule screen.

See *Schedule for Firewall Rules* on page 86.

- **ALLOW always.** Always allow the traffic covered by this rule.

This selection is the default setting.

- **ALLOW by schedule, otherwise Block.** Block the traffic covered by this rule, unless it is blocked according to the schedule specified on the Schedule screen.

See *Schedule for Firewall Rules* on page 86.

ALLOW rules are useful only when the traffic is already covered by a BLOCK rule. You would use these rules when you want to allow a subset of traffic that is blocked by another rule.

- **LAN Users.**

These settings determine which computers on your network are affected by this rule, based on their source (LAN) IP address. Select the option you want:

- **Any.** All local IP addresses are covered by this choice.
- **Address range.** You have to provide the Start and End fields when this option is selected.
- **Single address.** Enter the required address in the Start field.

- **WAN Servers.**

These settings determine which Internet locations are covered by the rule, based on their destination (WAN) IP address. Select the option you want:

- **Any.** All Internet IP addresses are covered by this choice.
- **Address range.** You have to provide the Start and End fields when this option is selected.
- **Single address.** Enter the required address in the Start field.

- **Log.**

This setting determines whether traffic covered by this rule is logged. Select the action you want:

- **Always.** Always log traffic that is covered by this rule, whether it matches or not. (This feature is useful when you are debugging your rules.)
- **Never.** Never log traffic covered by this rule, whether it matches or not.

- Click **Apply**.

Your changes take effect.

4. To allow or block an inbound service and to set up inbound firewall rules for gaming or other applications, under Inbound Services, click the **here** link.

You are redirected to the Port Forwarding/Port Triggering screen as described in *Port Forwarding and Port Triggering* on page 110.

5. To close or open the instant messaging ports, under Instant Messaging (IM) Ports, select the appropriate radio button:
 - Close IM Ports
 - Open IM Ports (IM ports are open by default)
6. Click **Apply**.

Add Custom Services to Allow or Block

You can define your own incoming and outgoing custom services to allow or block. To add a service for blocking, first determine which port number or range of numbers is used by the application.

➤ To add a custom service:

1. Select **ADVANCED > Security > Firewall Rules**.
2. Click **Add Custom Service**.

The Add Services screen allows you to specify or edit your own custom service definition. You can then use the custom service when creating firewall rules.

3. In the Name field, enter a suitable name for this service.
4. In the Type list, select the correct type for this service (if in doubt, select TCP/UDP):
 - TCP
 - UDP
 - TCP/UDP
5. Enter the starting and ending port numbers. If the application uses a single port number, enter that number in both fields.
6. Click **Apply**.

Your information is saved, and you return to the previous screen.

Schedule for Firewall Rules

You can specify the days and time that you want to block Internet access.

➤ **To specify the firewall rule schedule:**

1. Select **ADVANCED > Security > Schedule**.

2. Set up the schedule for blocking keywords and services:
 - **Days to Block.** Select days on which you want to apply blocking by selecting the appropriate check boxes, or select **Every Day** to select the check boxes for all days.
 - **Time of Day to Block.** Select a start and end time in 24-hour format, or select **All Day** for 24-hour blocking.
3. Select your time zone from the list. If you use daylight saving time, select the **Automatically adjust for daylight savings time** check box.
4. Click **Apply**.

Security Event Email Notifications

To receive logs and alerts by email, provide your email information in the E-mail screen and specify which alerts you want to receive and how often.

➤ **To set up email notifications:**

1. Select **ADVANCED > Security > E-mail**.

2. To receive email logs and alerts from the WiFi DSL modem router, select the **Turn E-mail Notification On** check box.

3. In the Your Outgoing Mail Server field, enter the name of your ISP outgoing (SMTP) mail server (such as mail.myISP.com).

You might be able to find this information in the configuration screen of your email program. When you leave this field blank, log and alert messages are not sent by email.

4. In the Send to This E-mail Address field, enter the email address to which logs and alerts are sent.

This email address is also used for the From address. When you leave this field blank, log and alert messages are not sent by email.

5. If your outgoing email server requires authentication, select the **My Mail Server requires authentication** check box.

Fill in the User Name and Password fields for the outgoing email server.

6. (Optional) Under Send Alert Immediately, select the check boxes for the kinds of alerts you want to receive.

You can have email alerts sent immediately when someone attempts to visit a blocked site and you can specify that logs are sent automatically.

7. (Optional) Under Send logs according to this schedule, specify how you want the logs sent to you.

If you select the Weekly, Daily, or Hourly option and the log fills up before the specified period, the log is automatically emailed to the specified email address. After the log is sent, the log is cleared from the WiFi DSL modem router's memory. If the WiFi DSL modem router cannot email the log file, the log buffer might fill up. In this case, the WiFi DSL modem router overwrites the log and discards its contents.

8. Click **Apply**.

Administration

8

Manage your network

This chapter describes the settings for administering and maintaining your WiFi DSL modem router and home network.

This chapter includes the following sections:

- [Upgrade the WiFi DSL Modem Router Firmware](#)
- [View WiFi DSL Modem Router Status](#)
- [View VPN Status](#)
- [View Logs of Web Access or Attempted Web Access](#)
- [Manage the Configuration File](#)
- [Set Password](#)
- [Diagnostics](#)

Related information for administering and maintaining your WiFi DSL modem router and home network is described in separate chapters:

- For information about the devices connected to your WiFi DSL modem router and home network, see [Attached Devices](#) on page 31.
- For information about upgrading or checking the status of your WiFi DSL modem router over the Internet, see [Remote Management](#) on page 124.
- For information about monitoring the volume of Internet traffic passing through your WiFi DSL modem router's Internet port, see [Traffic Meter](#) on page 128.

Upgrade the WiFi DSL Modem Router Firmware

The WiFi DSL modem router firmware (routing software) is stored in flash memory. You can update the firmware from the Administration menu on the Advanced tab. You might see a message at the top of the genie screens when new firmware is available for your product.

You can use the Check button on the Firmware Upgrade screen to check and update to the latest firmware for your product when new firmware is available.

➤ **To check for new firmware and update your WiFi DSL modem router:**

1. Select **ADVANCED > Administration > Router Update.**

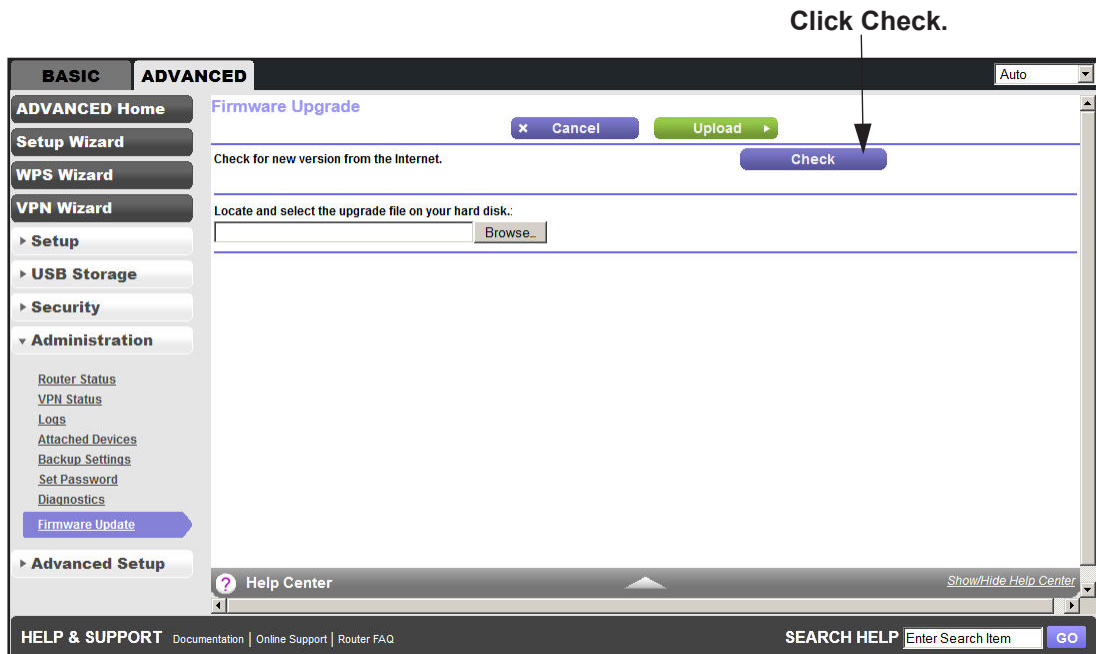

2. Click **Check.**

The WiFi DSL modem router finds new firmware information if any is available.

3. Click **Yes.**

The firmware you downloaded is stored on your computer (the file ends in .img).



WARNING:

When uploading firmware to the WiFi DSL modem router, *do not* interrupt the web browser by closing the window, clicking a link, or loading a new page. If the browser is interrupted, it could corrupt the firmware.

When the upload is complete, your WiFi DSL modem router restarts. The upgrade process typically takes about 1 minute. Read the new firmware release notes to determine whether you need to reconfigure the WiFi DSL modem router after upgrading.

View WiFi DSL Modem Router Status

You can view status and usage information about your WiFi DSL modem router.

➤ To view WiFi DSL modem router status and usage information:

Select **Advanced > Administration > Router Status**.

The screenshot displays the 'ADVANCED' administration interface. The 'Router Status' section is active, showing the following information:

Router Information		Internet Port	
Hardware Version	D6200	MAC Address	00:C0:02:13:46:A3
Firmware Version	V1.1.00.02_1.00.02NA	IP Address	192.168.0.11
GUI Language Version	V1.0.0.6	Active Connection	DHCP
LAN Port		IP Subnet Mask	255.255.255.0
MAC Address	00:C0:02:13:46:A1	Domain Name Server	192.168.0.1
IP Address	10.0.0.1		
DHCP Server	On		

Wireless Settings (2.4GHz)		Wireless Settings (5.0GHz)	
Name (SSID)	NETGEAR	Name (SSID)	NETGEAR-5G
Region	North America	Region	North America
Channel	Auto (6)	Channel	36
Mode	Up to 145 Mbps	Mode	Up to 450 Mbps
Wireless AP	ON	Wireless AP	ON
Broadcast Name	ON	Broadcast Name	ON
Wireless isolation	OFF	Wireless isolation	OFF
Wi-Fi Protected Setup	Configured	Wi-Fi Protected Setup	Configured

You can also select **ADVANCED Home**.

You can view the following information:

- **Router Information.**
 - **Hardware Version.** The WiFi DSL modem router model.
 - **Firmware Version.** The version of the WiFi DSL modem router firmware. It changes if you upgrade the WiFi DSL modem router firmware.
 - **GUI Language Version.** The localized language of the user interface.
 - **LAN Port.**
 - **MAC Address.** The Media Access Control address. This address is the unique physical address used by the Ethernet (LAN) port of the WiFi DSL modem router.
 - **IP Address.** The IP address used by the Ethernet (LAN) port of the WiFi DSL modem router. The default is 192.168.1.1.
 - **DHCP Server.** Identifies whether the WiFi DSL modem router's built-in DHCP server is active for the LAN-attached devices.

- **Internet Port.**
 - **MAC Address.** The Media Access Control address. This address is the unique physical address used by the Internet (WAN) port of the WiFi DSL modem router.
 - **IP Address.** The IP address used by the Internet (WAN) port of the WiFi DSL modem router. If no address is shown or the address is 0.0.0, the WiFi DSL modem router cannot connect to the Internet.
 - **Active Connection.** This shows if the WiFi DSL modem router is using a fixed IP address on the WAN. If the value is DHCP Client, the WiFi DSL modem router obtains an IP address dynamically from the ISP.
 - **IP Subnet Mask.** The IP subnet mask used by the Internet (WAN) port of the WiFi DSL modem router.
 - **Domain Name Server.** The Domain Name Server address used by the WiFi DSL modem router. A Domain Name Server translates human-language URLs such as www.netgear.com into IP addresses.
- **Wireless Settings (2.4 GHz and 5 GHz).**
 - **Name (SSID).** The wireless network name (SSID) used by the WiFi DSL modem router. The default names for the 5 GHz ends in -5G to distinguish it from the 2.4 GHz network.
 - **Region.** The geographic region where the WiFi DSL modem router is being used. It might be illegal to use the wireless features of the WiFi DSL modem router in some parts of the world.
 - **Channel.** Identifies the operating channel of the wireless port being used.
 - **Mode.** Indicates the wireless communication mode: Up to 54 Mbps, Up to 130 Mbps (default), and Up to 300 Mbps.
 - **Wireless AP.** Indicates whether the radio feature of the WiFi DSL modem router is enabled. If this feature is not enabled, the Wireless LED on the front panel is off.
 - **Broadcast Name.** Indicates whether the WiFi DSL modem router is broadcasting its SSID.
 - **Wireless Isolation.** Indicates whether wireless connections to the WiFi DSL modem router are prevented.
 - **Wi-Fi Protected Setup.** Indicates whether Wi-Fi Protected Setup is configured for this network.
- **Guest Network (2.4 GHz and 5 GHz).**
 - **Name (SSID).** The wireless network name (SSID) used by the WiFi DSL modem router. The default names are NETGEAR-Guest and NETGEAR-5G-Guest.
 - **Wireless AP.** Indicates whether the radio feature of the WiFi DSL modem router is enabled. If this feature is not enabled, the Wireless LED on the front panel is off.
 - **Broadcast Name.** Indicates whether the WiFi DSL modem router is broadcasting its SSID.
 - **Wireless Isolation.** Indicates whether wireless connections to the WiFi DSL modem router are prevented.

- **Allow guest to access My Local Network.** Indicates whether any user who connects to the network with this SSID can access local networks associated with the WiFi DSL modem router.

Reboot the Router

You can reboot your WiFi DSL modem router electronically. For information about the Reset button and the factory setting values, see *Factory Settings* on page 150.

- **To reboot the WiFi DSL modem router:**
 1. Select **Advanced > Administration > Router Status**.
 2. Click **Reboot**.

Connection Statistics

You can see how much traffic your Internet connection has occurred.

- **To show the connection statistics:**
 1. Select **Advanced > Administration > Router Status**.
 2. Click **Show Statistics**.

System Up Time 839:05:56							
Port	Status	TxPkts	RxPkts	Collisions	Tx B/s	Rx B/s	Up Time
WAN	DHCP Client	203424	3697910	0	5299	164167	00:59:17
LAN1	Link down						
LAN2	Link down						
LAN3	Link down						
LAN4	Link down						
WLAN b/g/n	145M	1123047	32128	0	93	1	839:04:59
WLAN a/n	450M	0	0	0	0	0	839:04:52
ADSL Link		Downstream			Upstream		
Link Rate		0 Kbps			0 Kbps		
Line Attenuation		0 dB			0 dB		
Noise Margin		0 dB			0 dB		
Poll Interval: <input type="text" value="5"/> (secs) <input type="button" value="Set Interval"/> <input type="button" value="Stop"/>							

The following information displays:

- **System Up Time.** The time elapsed since the WiFi DSL modem router was last restarted.
- **Port.** The statistics for the WAN (Internet) and LAN (Ethernet) ports. For each port, the screen displays:
 - **Status.** The link status of the port.
 - **TxPkts.** The number of packets transmitted on this port since reset or manual clear.
 - **RxPkts.** The number of packets received on this port since reset or manual clear.
 - **Collisions.** The number of collisions on this port since reset or manual clear.

- **Tx B/s.** The current transmission (outbound) bandwidth used on the WAN and LAN ports.
 - **Rx B/s.** The current reception (inbound) bandwidth used on the WAN and LAN ports.
 - **Up Time.** The time elapsed since this port acquired the link.
 - **Poll Interval.** The interval at which the statistics are updated in this screen.
3. To change the polling frequency, enter a time in seconds in the Poll Interval field.
 4. Click **Set Interval**.
To stop the polling entirely, click **Stop**.

Connection Status

You can see how long your Internet connection has been operating.

➤ **To show the connection status:**

1. Select **Advanced > Administration > Router Status**.
2. Click **Connection Status**.

Connection Status	
<input type="button" value="x Release"/> <input type="button" value="Renew >"/>	
IP Address	192.168.0.11
Subnet Mask	255.255.255.0
Default Gateway	192.168.0.1
DHCP Server :	192.168.0.1
DNS Server :	192.168.0.1
Lease Obtained	1 days,0 hours,0 minutes
Lease Expires	0 days,22 hours,59 minutes
<input type="button" value="Close Window"/>	

The following information displays:

- **IP Address.** The IP address that is assigned to the WiFi DSL modem router.
 - **Subnet Mask.** The subnet mask that is assigned to the WiFi DSL modem router.
 - **Default Gateway.** The IP address for the default gateway that the WiFi DSL modem router communicates with.
 - **DHCP Server.** The IP address for the Dynamic Host Configuration Protocol server that provides the TCP/IP configuration for all the computers that are connected to the WiFi DSL modem router.
 - **DNS Server.** The IP address of the Domain Name Service server that provides translation of network names to IP addresses.
 - **Lease Obtained.** The date and time when the lease was obtained.
 - **Lease Expires.** The date and time that the lease expires.
3. (Optional) To reset the information, click **Release**.
The Release button returns the status of all items to 0.
 4. (Optional) To refresh the information, click **Renew**.

The Renew button refreshes the items.

- To close the Connection Status window, click **Close Window**.

View VPN Status

The log is a detailed record of the websites you accessed or attempted to access. Up to 256 entries are stored in the log. Log entries appear only when keyword blocking is enabled and no log entries are made for the trusted user.

➤ To view the VPN status:

- Select **ADVANCED > Administration > VPN Status**.

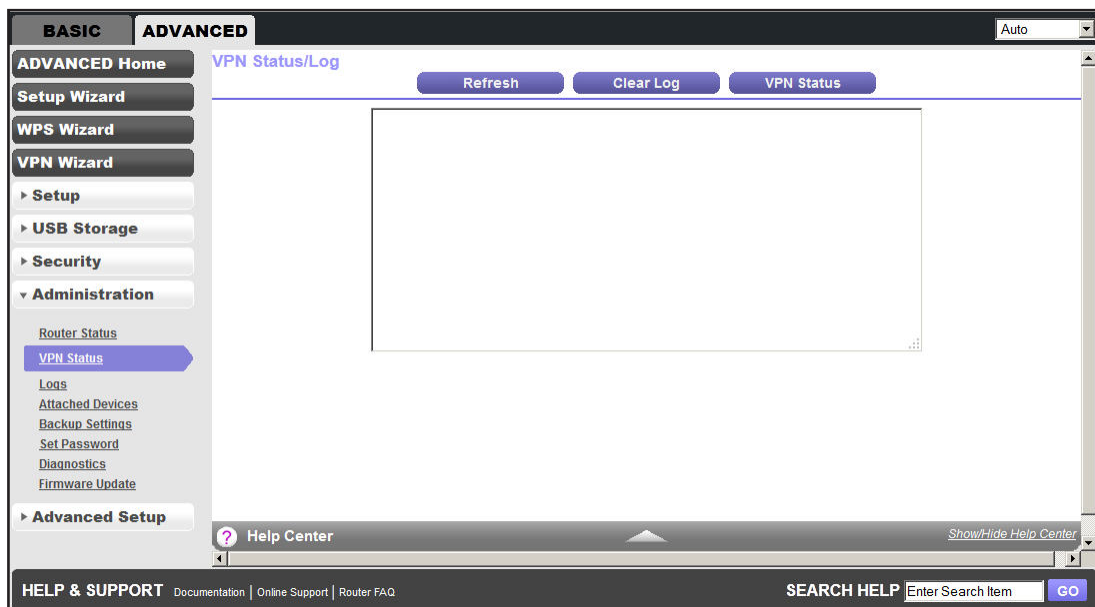

The VPN Status/Log screen shows the details of recent VPN activity.

- To refresh the log screen, click **Refresh**.
To clear the log entries, click **Clear Log**.
To email the log immediately, click **Send Log**.

View Logs of Web Access or Attempted Web Access

The log is a detailed record of the websites you accessed or attempted to access. Up to 256 entries are stored in the log. Log entries appear only when keyword blocking is enabled and no log entries are made for the trusted user.

➤ To view the logs:

1. Select **ADVANCED > Administration > Logs**.

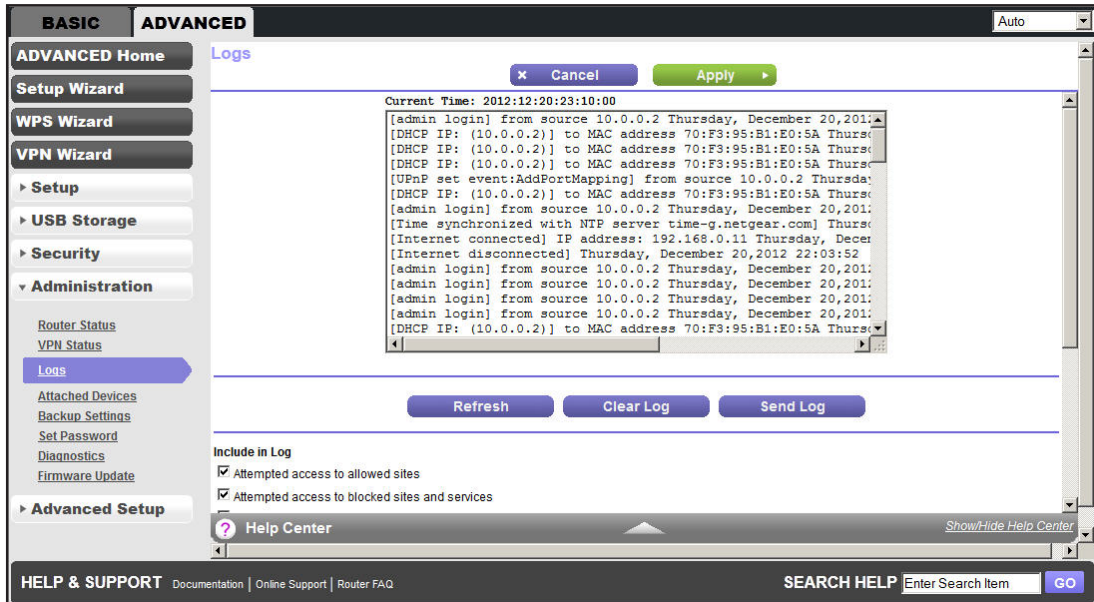

The Logs screen shows the following information:

- **Date and time.** The date and time the log entry was recorded.
- **Source IP.** The IP address of the initiating device for this log entry.
- **Target address.** The name or IP address of the website or news group visited or to which access was attempted.
- **Action.** Whether the access was blocked or allowed.
- **Include in Log.** A log is a detailed record of the websites that users on your network have accessed or attempted to access. If you have set up content filtering on the Block Sites screen, the Logs screen shows you when someone on your network tried to access a blocked site. When you have email notification on, you receive these logs in an email message. When you do not have email notification set up, you can view the logs here.
- **Syslog.** The logs can be sent to a syslog server. Enable one of these three options, as required:
 - **Disable.** Select this option when you do not have a syslog server.

- **Broadcast on LAN.** The syslog data is broadcast rather than sent to a specific syslog server. Use this option when your syslog server does not have a fixed IP address.
 - **Send to this Syslog server IP address.** When your syslog server has a fixed IP address, select this option and enter the IP address of your syslog server.
2. Click **Apply**.
 3. To refresh the log screen, click **Refresh**.
To clear the log entries, click **Clear Log**.
To email the log immediately, click **Send Log**.

Manage the Configuration File

The configuration settings of the WiFi DSL modem router are stored within the WiFi DSL modem router in a configuration file. You can back up (save) this file to your computer, restore it, or reset it to the factory default settings.

Back Up Settings

- To back up the WiFi DSL modem router's configuration settings:

1. Select **ADVANCED > Administration > Backup Settings**.

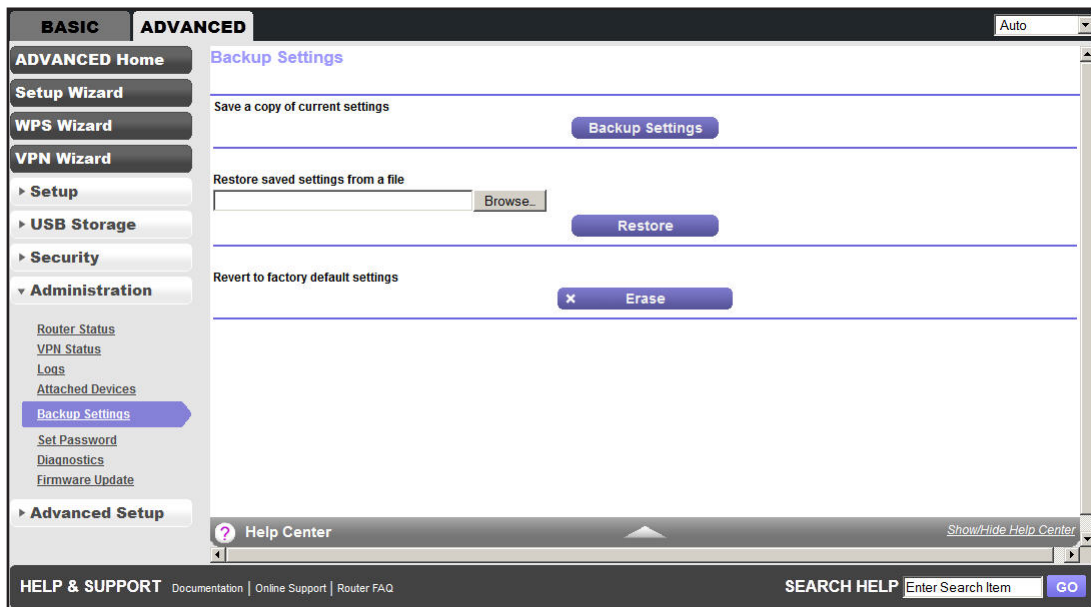

2. Click **Back Up**.
3. Choose a location to store the .cfg file that is on a computer on your network.
A copy of the current settings are saved on your hard drive.

Restore Configuration Settings

- To restore configuration settings that you backed up:
1. Select **ADVANCED > Administration > Backup Settings**.
 2. Enter the full path to the file on your network, or to find the file, click the **Browse** button.
 3. To upload the file to the WiFi DSL modem router, click the **Restore** button.

When the restoration is complete, the WiFi DSL modem router reboots.



WARNING:

Do not interrupt the reboot process.

Erase

Under some circumstances (for example, if you move the WiFi DSL modem router to a different network or if you have forgotten the password), you might want to erase the configuration and restore the factory default settings.

Either you can use the Reset button on the back of the WiFi DSL modem router (see *Factory Settings* on page 150), or you can click the **Erase** button in this screen.

Erase sets the user name to admin, the password to password, and the LAN IP address to 192.168.1.1, and enables the WiFi DSL modem router's DHCP.

Set Password

This feature allows you to change the default password that is used to log in to the WiFi DSL modem router with the user name admin.

This procedure is not the same as changing the password for wireless access. The label on the bottom of your WiFi DSL modem router shows your unique wireless network name (SSID) and password for wireless access (see *Label* on page 12).

➤ **To set the password for the user name admin:**

1. Select **ADVANCED > Administration > Set Password**.

2. Type the old password, and type the new password twice.
3. (Optional) Select the **Enable Password Recovery** check box.

The password recovery feature enables you to recover the password you use to log in to the router. Otherwise, you have to reset the router to its factory default settings and log in with the default password.

Note: Resetting the router to its factory default settings also resets all of the other settings you have configured.

4. Click **Apply**.

NETGEAR recommends that you enable password recovery when you change the password for the router's user name of admin. Then you have an easy way to recover the password when it is forgotten. This recovery process is supported in Internet Explorer, Firefox, and Chrome browsers, but not in the Safari browser.

➤ **To set up password recovery:**

1. Select the **Enable Password Recovery** check box.

The screen adjusts to display security questions.

2. Select two security questions, and provide answers to them.
3. Click **Apply**.

When you use your browser to access the router, the login screen displays. If password recovery is enabled, when you click Cancel, the password recovery process starts. You can then enter the saved answers to the security questions to recover the password.

Diagnostics

You can perform various diagnostics. For normal operation, these tests are not required.

➤ **To perform diagnostic tests:**

1. Select **ADVANCED > Administration > Diagnostics**.

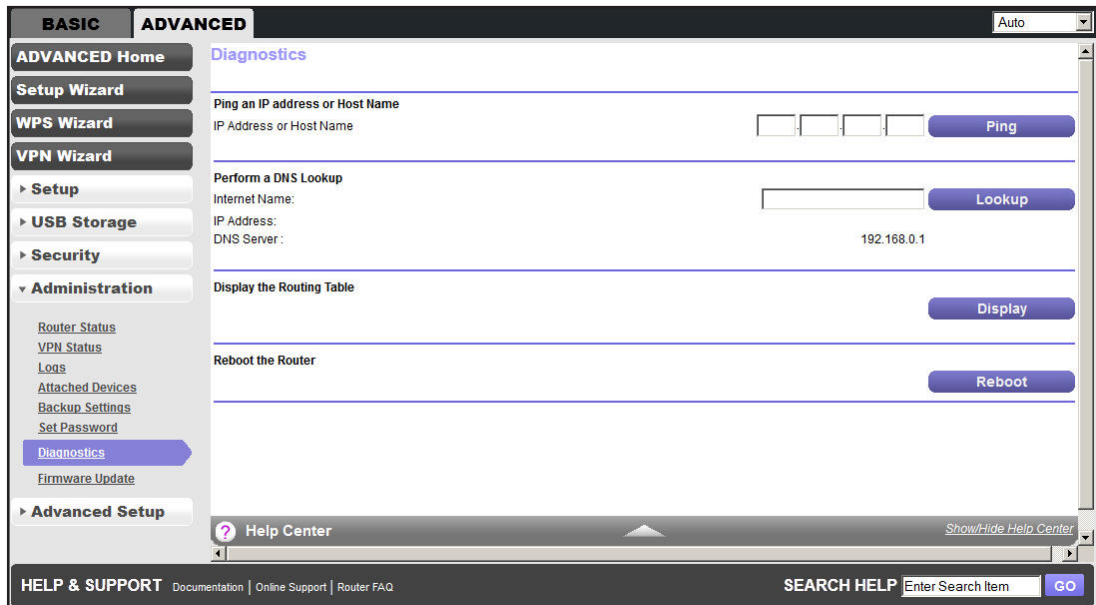

2. Do any of the following:

- In the Ping an IP address section, enter the IP address you want to ping, and click **Ping**.

Use this test to send a ping packet request to the specified IP address. This procedure is often used to test a connection. If the request times out because no reply is received, this result usually means that the destination is unreachable. However, some network devices can be configured not to respond to a ping.

- In the Perform a DNS Lookup section, specify the Internet name you want to look up, and click **Lookup**.

A DNS (Domain Name Server) converts the Internet name (for example, www.netgear.com) to an IP address. If you need the IP address of a web, FTP, mail, or other server on the Internet, you can do a DNS lookup to find the IP address.

- In the Display the Routing Table section, click **Display**.

This operation displays the internal routing table. Technical support and other staff who understand routing tables use this information.

- In the Reboot the Router section, click **Reboot**.

Use this button to perform a remote reboot (restart). You can use this procedure when the router seems to have become unstable or is not operating normally.

Note: Rebooting breaks any existing connections either to the router (such as this one) or through the router (such as LAN users accessing the Internet). However, connections to the Internet are automatically reestablished when possible.

9 Advanced Settings

9

Fine-tune your network

This chapter describes the advanced features of your WiFi DSL modem router. The information is for users with a solid understanding of networking concepts who want to set the WiFi DSL modem router up for unique situations such as when remote access from the Internet by IP or domain name is needed.

For added security, the WiFi DSL modem router can be set up to share only approved USB devices. See *Specify Approved USB Devices* on page 67 for the procedure.

This chapter includes the following sections:

- *Advanced Wireless Settings*
- *Wireless Repeating Function (WDS)*
- *Port Forwarding and Port Triggering*
- *Set Up Port Forwarding to Local Servers*
- *Set Up Port Triggering*
- *Dynamic DNS*
- *Static Routes*
- *Remote Management*
- *Universal Plug and Play*
- *IPv6*
- *Traffic Meter*
- *Device Mode*
- *VPN Policies*

Advanced Wireless Settings

Note: The wireless WiFi DSL modem router is already configured with the optimum settings. Do not alter these settings unless directed by NETGEAR support. Incorrect settings disable the wireless WiFi DSL modem router.

➤ To configure the advanced wireless settings:

1. Select **ADVANCED > Advanced Setup > Wireless Settings**.

The screenshot shows the 'Advanced Wireless Settings' page in the NETGEAR web interface. The page is titled 'Advanced Wireless Settings' and has 'Cancel' and 'Apply' buttons at the top. The left sidebar contains a navigation menu with 'Wireless Settings' selected. The main content area is divided into two sections: 'Wireless Settings (2.4GHz b/g/n)' and 'Wireless Settings (5GHz a/n)'. Both sections have a checked 'Enable Wireless Router Radio' checkbox. Below each section are input fields for 'Fragmentation Length (256-2346)' (set to 2346), 'CTS/RTS Threshold (1-2347)' (set to 2347), and 'Preamble Mode' (set to 'Long Preamble'). There is also an unchecked checkbox for 'Turn off wireless signal by schedule' with a sub-section for scheduling. The 'AP Mode' section at the bottom has an unchecked 'Enable AP Mode' checkbox. The bottom of the page has a 'Help Center' link and a 'Show/Hide Help Center' button.

2. To enable the wireless router radio, select the **Enable Wireless Router Radio** checkbox.

You can completely turn off the wireless portion of the wireless WiFi DSL modem router by clearing this check box. Select this check box again to enable the wireless portion of the WiFi DSL modem router.

When the wireless radio is disabled, other members of your household can use the WiFi DSL modem router by connecting their computers to the WiFi DSL modem router with an Ethernet cable.

Note: The Fragmentation Length, CTS/RTS Threshold, and Preamble Mode options are reserved for wireless testing and advanced configuration only. Do not change these settings.

3. (Optional) Select the **Turn off wireless signal by schedule** check box.

For more information, see [Turn Off Radio By Schedule](#) on page 104.

4. (Optional) Select the **AP Mode** check box.
The WiFi DSL modem router becomes an access point.
5. (Optional) Configure the WPS settings.
For more information, see [WPS Settings](#) on page 104.
6. (Optional) Set up the Wireless Access List.
For more information, see [Wireless Access List](#) on page 105.
7. Click **Apply**.

Turn Off Radio By Schedule

You can use this feature to turn off the wireless signal from your WiFi DSL modem router at times when you do not need a wireless connection. For example, you could turn it off for the weekend if you leave town.

➤ To turn off the radio by schedule:

1. Select **ADVANCED > Advanced Setup > Wireless Settings**.
2. Select the **Turn off wireless signal by schedule** check box.
3. With the Enable Wireless Router Radio check box selected for the radio band you want to configure, click the **Add a new period** button.

4. Click **Apply**.

WPS Settings

You can configure the WPS settings.

➤ **To configure the WPS settings:**

1. Select **ADVANCED > Advanced Setup > Wireless Settings**.
2. Under WPS Settings, configure the following settings:
 - **Router's PIN.** This PIN is the PIN number you use on a registrar (such as from Network Explorer on a Vista Windows computer) to configure the router's wireless settings through WPS. You can also find the PIN on the router's product label.
 - **Disable Router's PIN.** You can configure the router's wireless settings or add a wireless client through WPS using the router's PIN only when the PIN is enabled. The router's PIN can be disabled temporarily when the router detects suspicious attempts to break into the router's wireless settings by using the router's PIN through WPS. You can manually enable this function by clearing the check box and clicking the Apply button.
 - **Keep Existing Wireless Settings.** This setting shows whether the router is in the WPS configured state. If this check box is not selected, adding a new wireless client changes the router's wireless settings to an automatically generated random SSID and security key. In addition, when this check box is selected, some external registrars (such as Network Explorer on Vista Windows) might not see the router.

Configuring the basic wireless settings from the router's web management interface selects this option automatically.
3. Click **Apply**.

Wireless Access List

By default, any wireless computer that is configured with the correct SSID is allowed access to your wireless network. For increased security, restrict access to the wireless network to allow only specific computers based on their MAC addresses.

➤ **To configure the wireless access list:**

1. Select **ADVANCED > Advanced Setup > Wireless Settings**.
2. Click the **Set Up Access List** button.

3. Click the **Set Up Access List**.



4. Click **Turn Access Control On**.
5. Click **Add**.

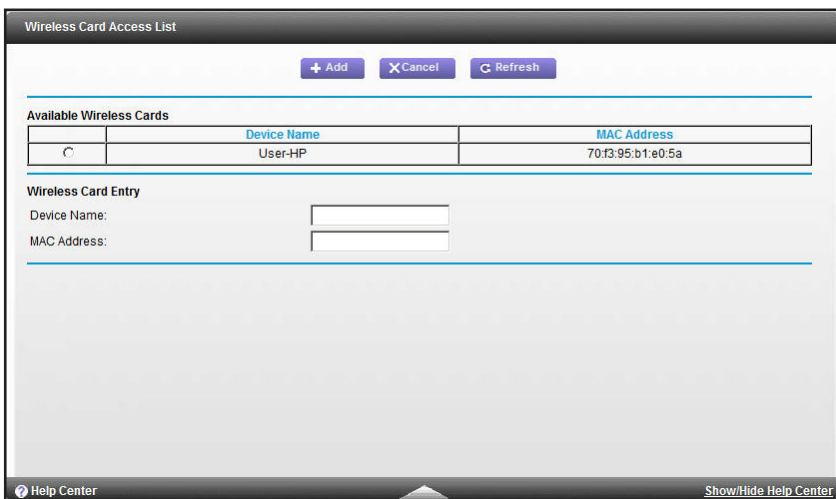

6. Click **Add**.
Access to your network is restricted based on its MAC address.
7. Click **Apply**.

Wireless Repeating Function (WDS)

You can set the WiFi DSL modem router up to be used as a wireless access point (AP). This setup enables the WiFi DSL modem router to act as a wireless repeater. A wireless repeater connects to another wireless WiFi DSL modem router as a client where the network to which it connects becomes the ISP service.

Wireless repeating is a type of wireless distribution system (WDS). A WDS allows a wireless network to be expanded through multiple access points instead of using a wired backbone to link them. The following figure shows a wireless repeating scenario.

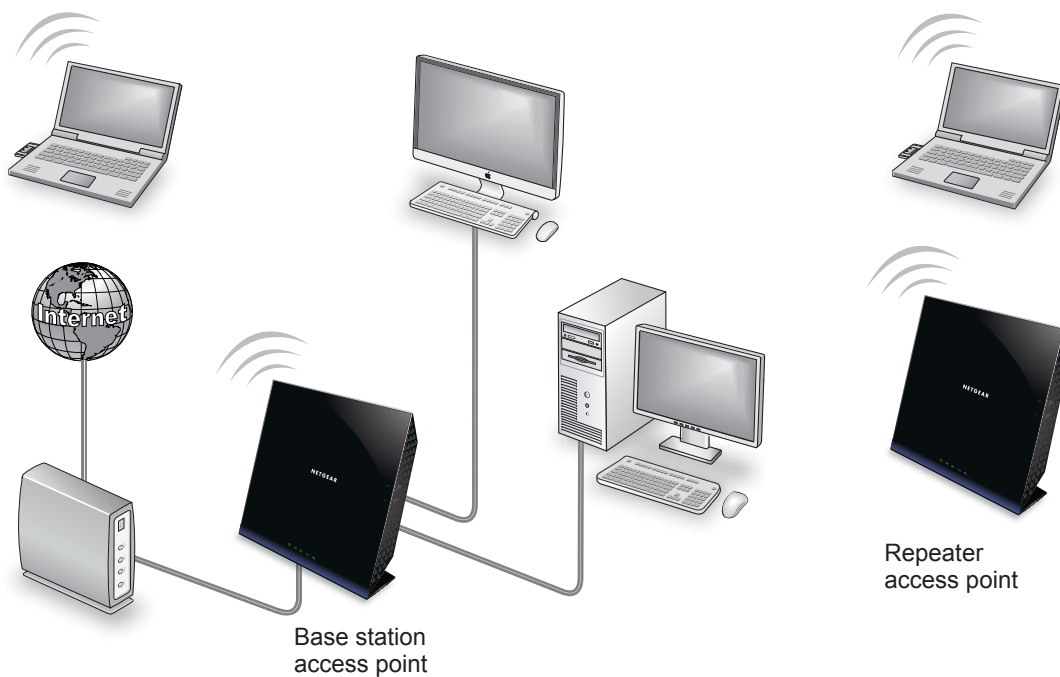

Figure 10. Wireless repeating scenario

Note: If you use the wireless repeating function, you need to select either **WEP** or **None** as a security option in the Wireless Settings screen. The WEP option displays only if you select the wireless mode **Up to 54 Mbps** in the Wireless Settings screen. For more information, see [Basic Wireless Settings](#) on page 32.

Wireless base station. The WiFi DSL modem router acts as the parent access point, bridging traffic to and from the child repeater access point, as well as handling wireless and wired local computers. To configure this mode, you have to know the MAC address of the child repeater access point.

Wireless repeater. The WiFi DSL modem router sends all traffic from its local wireless or wired computers to a remote access point. To configure this mode, you have to know the MAC address of the remote parent access point.

The D6200 WiFi DSL modem router is always in dual-band concurrent mode, unless you turn off one radio. If you enable the wireless repeater in either radio band, the wireless base station or wireless repeater cannot be enabled in the other radio band. However, if you enable the wireless base station in either radio band and use the other radio band as a wireless WiFi DSL modem router or wireless base station, dual-band concurrent mode is not affected.

For you to set up a wireless network with WDS, the following conditions have to be met for both access points:

- Both access points have to use the same SSID, wireless channel, and encryption mode.
- Both access points have to be on the same LAN IP subnet. That is, all the access point LAN IP addresses are in the same network.
- All LAN devices (wired and wireless computers) have to be configured to operate in the same LAN network address range as the access points.

Wireless Repeating Function

Use the Wireless Repeating Function screen to view or change the wireless repeater settings.

➤ To view or change the wireless repeater settings:

1. Select **ADVANCED > Advanced Setup > Wireless Repeating Function**.

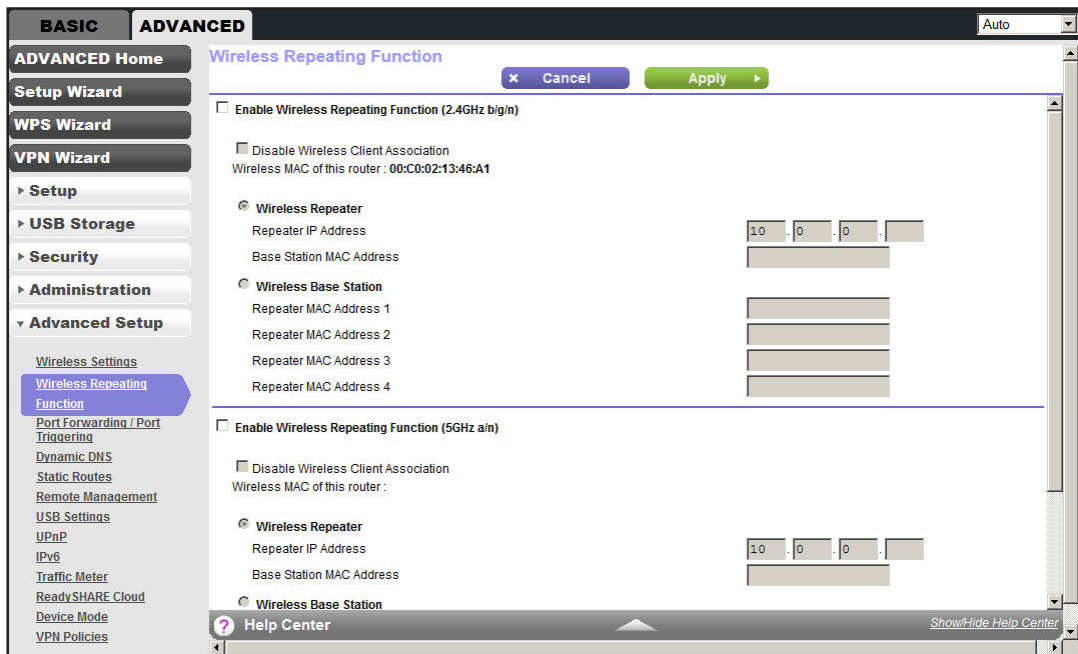

2. Configure the following settings:

- **Enable Wireless Repeating Function.** Select the check box for the 2.4 GHz or 5 GHz network to use the wireless repeating function.

- **Wireless MAC of this router.** This field displays the MAC address for your WiFi DSL modem router for your reference. You need to enter this MAC address in the corresponding Wireless Repeating Function screen of the other access point you are using.
- **Wireless Repeater.** If your WiFi DSL modem router is the repeater, select this radio button.

Repeater IP Address. If your WiFi DSL modem router is the repeater, enter the IP address of the other access point.

Disable Wireless Client Association. If your WiFi DSL modem router is the repeater, selecting this check box means that wireless clients cannot associate with it. Only LAN client associations are allowed.

- If you are setting up a point-to-point bridge, select this check box.
- If you want all client traffic to go through the other access point (repeater with wireless client association), leave this check box cleared.

Base Station MAC Address. If your WiFi DSL modem router is the repeater, enter the MAC address for the access point that is the base station.

- **Wireless Base Station.** If your WiFi DSL modem router is the base station, select this radio button.

Disable Wireless Client Association. If your WiFi DSL modem router is the base station, selecting this check box means that wireless clients cannot associate with it. Only LAN client associations are allowed.

Repeater MAC Address (1 through 4). If your WiFi DSL modem router is the base station, it can act as the “parent” of up to 4 other access points. Enter the MAC addresses of the other access points in these fields.

3. Click **Apply**.

Set Up the Base Station

The wireless repeating function works only in hub and spoke mode. The units cannot be daisy-chained. You have to know the wireless settings for both units. You have to know the MAC address of the remote unit. First, set up the base station and then set up the repeater.

Set up both units with the same wireless settings (SSID, mode, channel, and security). The wireless security option has to be set to None or WEP.

➤ **To set up the base station:**

1. Select **ADVANCED > Advanced Setup > Wireless Repeating Function**.
2. Select the **Enable Wireless Repeating Function** check box and select the **Wireless Base Station** radio button.
3. Enter the MAC address for one or more repeater units.
4. Click **Apply**.

Set Up a Repeater Unit

Use a wired Ethernet connection to set up the repeater unit to avoid conflicts with the wireless connection to the base station.

Note: If you are using the D6200 base station with a non-NETGEAR WiFi DSL modem router as the repeater, you might need to change more configuration settings. In particular, you should disable the DHCP server function on the wireless repeater AP.

➤ **To configure the WiFi DSL modem router as a repeater unit:**

1. Log in to the WiFi DSL modem router that is to be the repeater.
2. Select **BASIC > Wireless Settings** and verify that the wireless settings match those of the base unit exactly.

The wireless security option has to be set to **WEP** or **None**.

3. Select **ADVANCED > Advanced > Wireless Repeating Function**.
4. Select the **Enable Wireless Repeating Function check box** and the **Wireless Repeater** radio button.
5. Fill in the Repeater IP Address field.

This IP address has to be in the same subnet as the base station, but different from the LAN IP address of the base station.

6. Click **Apply**.
7. Verify connectivity across the LANs.

A computer on any wireless or wired LAN segment of the WiFi DSL modem router should be able to connect to the Internet or share files and printers with any other wireless or wired computer or server connected to the other access point.

Port Forwarding and Port Triggering

By default, the WiFi DSL modem router blocks inbound traffic from the Internet to your computers except replies to your outbound traffic. You might need to create exceptions to this rule for these purposes:

- To allow remote computers on the Internet to access a server on your local network.
- To allow certain applications and games to work correctly when their replies are not recognized by your WiFi DSL modem router.

Your WiFi DSL modem router provides two features for creating these exceptions: port forwarding and port triggering. The next sections provide background information to help you understand how port forwarding and port triggering work, and the differences between the two.

Remote Computer Access Basics

When a computer on your network needs to access a computer on the Internet, your computer sends your WiFi DSL modem router a message containing the source and destination address and process information. Before forwarding your message to the remote computer, your WiFi DSL modem router has to modify the source information and create and track the communication session so that replies can be routed back to your computer.

Here is an example of normal outbound traffic and the resulting inbound responses:

1. You open a browser, and your operating system assigns port number 5678 to this browser session.
2. You type `http://www.example.com` into the URL field, and your computer creates a web page request message with the following address and port information. The request message is sent to your WiFi DSL modem router.
 - **Source address.** Your computer's IP address.
 - **Source port number.** 5678, which is the browser session.
 - **Destination address.** The IP address of `www.example.com`, which your computer finds by asking a DNS server.
 - **Destination port number.** 80, which is the standard port number for a web server process.
3. Your WiFi DSL modem router creates an entry in its internal session table describing this communication session between your computer and the web server at `www.example.com`. Before sending the web page request message to `www.example.com`, your WiFi DSL modem router stores the original information and then modifies the source information in the request message, performing Network Address Translation (NAT):
 - The source address is replaced with your WiFi DSL modem router's public IP address. This requirement is necessary because your computer uses a private IP address that is not globally unique and cannot be used on the Internet.
 - The source port number is changed to a number chosen by the WiFi DSL modem router, such as 33333. This requirement is necessary because two computers could independently be using the same session number.

Your WiFi DSL modem router then sends this request message through the Internet to the web server at `www.example.com`.

4. The web server at `www.example.com` composes a return message with the requested web page data. The return message contains the following address and port information. The web server then sends this reply message to your WiFi DSL modem router.
 - **Source address.** The IP address of `www.example.com`.
 - **Source port number.** 80, which is the standard port number for a web server process.
 - **Destination address.** The public IP address of your WiFi DSL modem router.
 - **Destination port number.** 33333.
5. Upon receiving the incoming message, your WiFi DSL modem router checks its session table to determine whether an active session for port number 33333 exists. Finding an active session, the WiFi DSL modem router then modifies the message to restore the original

address information replaced by NAT. Your WiFi DSL modem router sends this reply message to your computer, which displays the web page from `www.example.com`. The message now contains the following address and port information:

- **Source address.** The IP address of `www.example.com`.
 - **Source port number.** 80, which is the standard port number for a web server process.
 - **Destination address.** Your computer's IP address.
 - **Destination port number.** 5678, which is the browser session that made the initial request.
6. When you finish your browser session, your WiFi DSL modem router eventually detects a period of inactivity in the communications. Your WiFi DSL modem router then removes the session information from its session table, and incoming traffic is no longer accepted on port number 33333.

Port Triggering to Open Incoming Ports

In the preceding example, requests are sent to a remote computer by your WiFi DSL modem router from a particular service port number, and replies from the remote computer to your WiFi DSL modem router are directed to that port number. If the remote server sends a reply to a different port number, your WiFi DSL modem router does not recognize it and discards it. However, some application servers (such as FTP and IRC servers) send replies to multiple port numbers. Using the port triggering function of your WiFi DSL modem router, you can tell the WiFi DSL modem router to open more incoming ports when a particular outgoing port originates a session.

An example is Internet Relay Chat (IRC). Your computer connects to an IRC server at destination port 6667. The IRC server not only responds to your originating source port, but also sends an "identify" message to your computer on port 113. Using port triggering, you can tell the WiFi DSL modem router, "When you initiate a session with destination port 6667, you have to also allow incoming traffic on port 113 to reach the originating computer." Using steps similar to the preceding example, the following sequence shows the effects of the port triggering rule you have defined:

1. You open an IRC client program to start a chat session on your computer.
2. Your IRC client composes a request message to an IRC server using a destination port number of 6667, the standard port number for an IRC server process. Your computer then sends this request message to your WiFi DSL modem router.
3. Your WiFi DSL modem router creates an entry in its internal session table describing this communication session between your computer and the IRC server. Your WiFi DSL modem router stores the original information, performs Network Address Translation (NAT) on the source address and port, and sends this request message through the Internet to the IRC server.
4. Noting your port triggering rule and having observed the destination port number of 6667, your WiFi DSL modem router creates an additional session entry to send any incoming port 113 traffic to your computer.
5. The IRC server sends a return message to your WiFi DSL modem router using the NAT-assigned source port (as in the previous example, say port 33333) as the destination

port. The IRC server also sends an identify message to your WiFi DSL modem router with destination port 113.

6. Upon receiving the incoming message to destination port 33333, your WiFi DSL modem router checks its session table to determine whether an active session for port number 33333 exists. Finding an active session, the WiFi DSL modem router restores the original address information replaced by NAT and sends this reply message to your computer.
7. Upon receiving the incoming message to destination port 113, your WiFi DSL modem router checks its session table and learns that an active session exists for port 113 associated with your computer. The WiFi DSL modem router replaces the message's destination IP address with your computer's IP address and forwards the message to your computer.
8. When you finish your chat session, your WiFi DSL modem router eventually senses a period of inactivity in the communications. The WiFi DSL modem router then removes the session information from its session table, and incoming traffic is no longer accepted on port numbers 33333 or 113.

To configure port triggering, you need to know which inbound ports the application needs. Also, you need to know the number of the outbound port that triggers the opening of the inbound ports. You can usually determine this information by contacting the publisher of the application or user groups or newsgroups.

Note: Only one computer at a time can use the triggered application.

Port Forwarding to Permit External Host Communications

In both of the preceding examples, your computer initiates an application session with a server computer on the Internet. However, you might need to allow a client computer on the Internet to initiate a connection to a server computer on your network. Normally, your WiFi DSL modem router ignores any inbound traffic that is not a response to your own outbound traffic. You can configure exceptions to this default rule by using the port forwarding feature.

A typical application of port forwarding can be shown by reversing the client-server relationship from the previous web server example. In this case, a remote computer's browser needs to access a web server running on a computer in your local network. Using port forwarding, you can tell the WiFi DSL modem router, "When you receive incoming traffic on port 80 (the standard port number for a web server process), forward it to the local computer at 192.168.1.123." The following sequence shows the effects of the port forwarding rule you have defined:

1. The user of a remote computer opens a browser and requests a web page from `www.example.com`, which resolves to the public IP address of your WiFi DSL modem router. The remote computer composes a web page request message with the following destination information:
 - **Destination address.** The IP address of `www.example.com`, which is the address of your WiFi DSL modem router.
 - **Destination port number.** 80, which is the standard port number for a web server process.

The remote computer then sends this request message through the Internet to your WiFi DSL modem router.

2. Your WiFi DSL modem router receives the request message and looks in its rules table for any rules covering the disposition of incoming port 80 traffic. Your port forwarding rule specifies that incoming port 80 traffic should be forwarded to local IP address 192.168.1.123. Therefore, your WiFi DSL modem router modifies the destination information in the request message:

The destination address is replaced with 192.168.1.123.

Your WiFi DSL modem router then sends this request message to your local network.

3. Your web server at 192.168.1.123 receives the request and composes a return message with the requested web page data. Your web server then sends this reply message to your WiFi DSL modem router.
4. Your WiFi DSL modem router performs Network Address Translation (NAT) on the source IP address, and sends this request message through the Internet to the remote computer, which displays the web page from www.example.com.

To configure port forwarding, you need to know which inbound ports the application needs. Usually you can determine this information by contacting the publisher of the application or the relevant user groups and newsgroups.

How Port Forwarding Differs from Port Triggering

The following points summarize the differences between port forwarding and port triggering:

- Port triggering can be used by any computer on your network, although only one computer can use it at a time.
- Port forwarding is configured for a single computer on your network.
- Port triggering does not require that you know the computer's IP address in advance. The IP address is captured automatically.
- Port forwarding requires that you specify the computer's IP address during configuration, and the IP address can never change.
- Port triggering requires specific outbound traffic to open the inbound ports, and the triggered ports are closed after a period of no activity.
- Port forwarding is always active and does not need to be triggered.

Set Up Port Forwarding to Local Servers

Using the port forwarding feature, you can allow certain types of incoming traffic to reach servers on your local network. For example, you might want to make a local web server, FTP server, or game server visible and available to the Internet.

Use the Port Forwarding/Port Triggering screen to configure the WiFi DSL modem router to forward specific incoming protocols to computers on your local network. In addition to servers

for specific applications, you can also specify a default DMZ server to which all other incoming protocols are forwarded.

Before starting, you need to determine which type of service, application, or game you want to provide, and the local IP address of the computer that provides the service. The server computer has to always have the same IP address.

Tip: To ensure that your server computer always has the same IP address, use the reserved IP address feature of your WiFi DSL modem router.

➤ **To set up port forwarding:**

1. Select **ADVANCED > Advanced Setup > Port Forwarding/Port Triggering.**



Port Forwarding is selected as the service type.

2. Click **Add**.

3. From the Service list, select the service or game that you host on your network.
If the service does not appear in the list, see [Add a Custom Service](#) on page 116.
4. From the Action list, select the action that you want.
5. In the Send to LAN Server field, enter the last digit of the IP address of your local computer that provides this service.
6. Click **Apply**.
The service appears in the list in the screen.

Add a Custom Service

To define a service, game, or application that does not appear in the Service Name list, you have to first determine which port number or range of numbers is used by the application. You can usually determine this information by contacting the publisher of the application or user groups or newsgroups.

➤ **To add a custom service:**

1. Select **ADVANCED > Advanced Setup > Port Forwarding/Port Triggering**.
2. Select **Port Forwarding** as the service type.

3. Click the **Add Custom Service**.

4. In the Name field, enter a descriptive name.
5. In the Type list, select the protocol. If you are unsure, select **TCP/UDP**.
6. In the Start Port field, enter the beginning port number.
 - If the application uses a single port, enter the same port number in the End Port field.
 - If the application uses a range of ports, enter the ending port number of the range in the End Port field.
7. Click **Apply**.

The service appears in the list in the Port Forwarding/Port Triggering screen.

Edit or Delete a Port Forwarding Entry

- **To edit or delete a port forwarding entry:**
 1. Select **ADVANCED > Advanced Setup > Port Forwarding/Port Triggering**.
 2. In the table, select the radio button next to the service name.
 3. Click **Edit Service** or **Delete Service**.

Application Example: Making a Local Web Server Public

If you host a web server on your local network, you can use port forwarding to allow web requests from anyone on the Internet to reach your web server.

- **To make a local web server public:**
 1. Assign your web server either a fixed IP address or a dynamic IP address using DHCP address reservation.

In this example, your WiFi DSL modem router always gives your web server an IP address of 192.168.1.33.

2. In the Port Forwarding/Port Triggering screen, configure the WiFi DSL modem router to forward the HTTP service to the local address of your web server at **192.168.1.33**.

HTTP (port 80) is the standard protocol for web servers.

3. (Optional) Register a host name with a Dynamic DNS service, and configure your WiFi DSL modem router to use the name.

For more information, see *Dynamic DNS* on page 120.

To access your web server from the Internet, a remote user has to know the IP address that has been assigned by your ISP. However, if you use a Dynamic DNS service, the remote user can reach your server by a user-friendly Internet name, such as mynetgear.dyndns.org.

Set Up Port Triggering

Port triggering is a dynamic extension of port forwarding that is useful in these cases:

- More than one local computer needs port forwarding for the same application (but not simultaneously).
- An application needs to open incoming ports that are different from the outgoing port.

When port triggering is enabled, the WiFi DSL modem router monitors outbound traffic looking for a specified outbound “trigger” port. When the WiFi DSL modem router detects outbound traffic on that port, it remembers the IP address of the local computer that sent the data. The WiFi DSL modem router then temporarily opens the specified incoming port or ports and forwards incoming traffic on the triggered ports to the triggering computer.

While port forwarding creates a static mapping of a port number or range to a single local computer, port triggering can dynamically open ports to any computer that needs them and can close the ports when they are no longer needed.

Note: If you use applications such as multiplayer gaming, peer-to-peer connections, real-time communications such as instant messaging, or remote assistance (a feature in Windows XP), you should also enable Universal Plug and Play (UPnP). For more information, see *Universal Plug and Play* on page 126.

To set up port triggering, you need to know which inbound ports the application needs. Also, you need to know the number of the outbound port that triggers the opening of the inbound ports. You can usually determine this information by contacting the publisher of the application or user groups or newsgroups.

➤ To set up port triggering:

1. Select **ADVANCED > Advanced Setup > Port Forwarding/Port Triggering**.

2. Select the **Port Triggering** radio button.



3. Clear the **Disable Port Triggering** check box if it is selected.

Note: If the Disable Port Triggering check box is selected after you configure port triggering, port triggering is disabled. However, any port triggering configuration information you added to the WiFi DSL modem router is retained even though it is not used.

4. In the Port Triggering Timeout field, enter a value up to 9999 minutes.

This value controls the inactivity timer for the designated inbound ports. The inbound ports close when the inactivity time expires. This closure is required because the WiFi DSL modem router cannot be sure when the application has terminated.

5. Click **Add Service**.

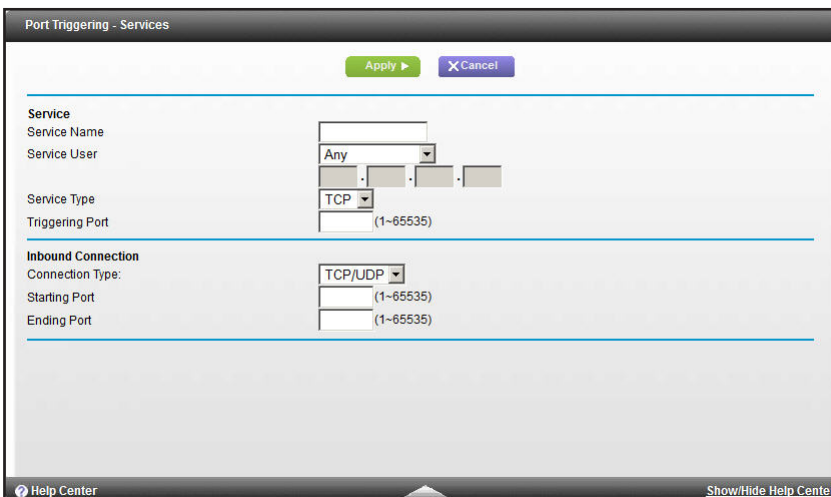

6. In the Service Name field, type a descriptive service name.
7. In the Service User list, select **Any** (the default).

This service can be used by any computer on the Internet.

Otherwise, select **Single address**, and enter the IP address of one computer to restrict the service to a particular computer.

8. Select the service type, either **TCP** or **UDP** or both (**TCP/UDP**).

If you are not sure, select TCP/UDP.

9. In the Triggering Port field, enter the number of the outbound traffic port that causes the inbound ports to open.
10. Enter the inbound connection port information in the Connection Type, Starting Port, and Ending Port fields.
11. Click **Apply**.

The service appears in the Port Triggering Portmap table.

Dynamic DNS

If your Internet service provider (ISP) gave you a permanently assigned IP address, you can register a domain name and have that name linked with your IP address by public Domain Name Servers (DNS). However, if your Internet account uses a dynamically assigned IP address, you do not know in advance what your IP address is, and the address can change frequently. In this case, you can use a commercial Dynamic DNS service. This type of service lets you register your domain to their IP address and forwards traffic directed at your domain to your frequently changing IP address.

If your ISP assigns a private WAN IP address (such as 192.168.x.x or 10.x.x.x), the Dynamic DNS service does not work because private addresses are not routed on the Internet.

Your WiFi DSL modem router contains a client that can connect to the Dynamic DNS service provided by DynDNS.org. First visit their website at <http://www.dyndns.org> and obtain an account and host name that you configure in the WiFi DSL modem router. Then, whenever your ISP-assigned IP address changes, your WiFi DSL modem router automatically contacts the Dynamic DNS service provider, logs in to your account, and registers your new IP address. If your host name is hostname, for example, you can reach your WiFi DSL modem router at <http://hostname.dyndns.org>.

➤ To set up Dynamic DNS:

1. Select **ADVANCED** > **Advanced Setup** > **Dynamic DNS**.

The screenshot shows the 'Dynamic DNS' configuration page in the router's web interface. The interface has a sidebar on the left with navigation options: ADVANCED Home, Setup Wizard, WPS Wizard, VPN Wizard, Setup, USB Storage, Security, Administration, and Advanced Setup. Under 'Advanced Setup', there are links for Wireless Settings, Wireless Repeating Function, Port Forwarding / Port Triggering, Dynamic DNS (highlighted), Static Routes, Remote Management, USB Settings, UPnP, IPv6, Traffic Meter, ReadySHARE Cloud, Device Mode, and VPN Policies. The main content area is titled 'Dynamic DNS' and includes a 'Show Status' button, a 'Cancel' button, and an 'Apply' button. A checkbox labeled 'Use a Dynamic DNS Service' is present. Below it, there is a 'Service Provider' dropdown menu with 'www.DynDNS.org' selected. There are also input fields for 'Host Name', 'User Name', and 'Password'. At the bottom of the page, there is a 'Help Center' link and a 'Show/Hide Help Center' button.

2. Register for an account with one of the Dynamic DNS service providers whose URLs appear in the Service Provider list.
3. Select the **Use a Dynamic DNS Service** check box.
4. Select the URL of your Dynamic DNS service provider.
For example, for DynDNS.org, select **www.dyndns.org**.
5. Type the host name (or domain name) that your Dynamic DNS service provider gave you.
6. Type the user name for your Dynamic DNS account.
This name is the name that you use to log in to your account, not your host name.
7. Type the password (or key) for your Dynamic DNS account.
8. Click **Apply**.

Static Routes

Static routes provide more routing information to your WiFi DSL modem router. Under usual circumstances, the WiFi DSL modem router has adequate routing information after it has been configured for Internet access, and you do not need to configure more static routes. You have to configure static routes only for unusual cases such as multiple WiFi DSL modem routers or multiple IP subnets on your network.

As an example of when a static route is needed, consider the following case:

- Your primary Internet access is through a cable modem to an ISP.

- You have an ISDN WiFi DSL modem router on your home network for connecting to the company where you are employed. This WiFi DSL modem router's address on your LAN is 192.168.1.100.
- Your company's network address is 134.177.0.0.

When you first configured your WiFi DSL modem router, two implicit static routes were created. A default route was created with your ISP as the gateway, and a second static route was created to your local network for all 192.168.1.x addresses. With this configuration, if you attempt to access a device on the 134.177.0.0 network, your WiFi DSL modem router forwards your request to the ISP. The ISP forwards your request to the company where you are employed, and the request is likely to be denied by the company's firewall.

In this case you have to define a static route, telling your WiFi DSL modem router that 134.177.0.0 should be accessed through the ISDN WiFi DSL modem router at 192.168.1.100. In this example:

- The Destination IP Address and IP Subnet Mask fields specify that this static route applies to all 134.177.x.x addresses.
- The Gateway IP Address field specifies that all traffic for these addresses should be forwarded to the ISDN WiFi DSL modem router at 192.168.1.100.
- A metric value of 1 works since the ISDN WiFi DSL modem router is on the LAN.
- Private is selected only as a precautionary security measure in case RIP is activated.

➤ **To set up a static route:**

1. Select **ADVANCED > Advanced Setup > Static Routes**.



2. Click **Add**.

3. In the Route Name field, type a name for this static route (for identification purposes only.)

4. (Optional) Select the **Private** check box if you want to limit access to the LAN only.

If Private is selected, the static route is not reported in RIP.

5. Select the **Active** check box.

6. Type the IP address of the final destination.

7. Type the IP subnet mask for this destination.

If the destination is a single host, type **255.255.255.255**.

8. Type the gateway IP address.

The gateway IP address has to be a WiFi DSL modem router on the same LAN segment as the WiFi DSL modem router.

9. Type a number from 1 through 15 as the metric value.

This value represents the number of WiFi DSL modem routers between your network and the destination. Usually, a setting of 2 or 3 works, but if this connection is a direct connection, set it to 1.

10. Click **Apply**.

The route is made effective.

Remote Management

The remote management feature lets you upgrade or check the status of your WiFi DSL modem router over the Internet.

Note: Be sure to change the WiFi DSL modem router's default login password to a secure password. The ideal password should contain no dictionary words from any language and contain uppercase and lowercase letters, numbers, and symbols. It can be up to 30 characters. For more information, see [Set Password](#) on page 98.

➤ **To set up remote management:**

1. Select **ADVANCED > Advanced Setup > Remote Management**.

2. Select the **Turn Remote Management On** check box.
3. Under Allow Remote Access By, select the external IP addresses that are allowed access to the WiFi DSL modem router's remote management.

Note: For enhanced security, restrict access to as few external IP addresses as practical.

- To allow access from a single IP address on the Internet, select **Only This Computer**. Enter the IP address that is allowed access.

- To allow access from a range of IP addresses on the Internet, select **IP Address Range**. Enter a beginning and ending IP address to define the allowed range.
- To allow access from a list of specific IP addresses on the Internet, select **IP Address List**. Enter the IP addresses that are allowed access.
- To allow access from any IP address on the Internet, select **Everyone**.

4. Specify the port number for accessing the web management interface.

Normal web browser access uses the standard HTTP service port 80. For greater security, enter a custom port number for the remote web management interface. Choose a number from 1024 through 65535, but do not use the number of any common service port. The default is 8080, which is a common alternate for HTTP.

5. Click **Apply**.

6. When accessing your WiFi DSL modem router from the Internet, type your WiFi DSL modem router's WAN IP address into your browser's address or location field followed by a colon (:) and the custom port number.

For example, if your external address is 134.177.0.123 and you use port number 8080, enter **http://134.177.0.123:8080** in your browser.

Universal Plug and Play

Universal Plug and Play (UPnP) helps devices, such as Internet appliances and computers, to access the network and connect to other devices as needed. UPnP devices can automatically discover the services from other registered UPnP devices on the network.

Note: If you use applications such as multiplayer gaming, peer-to-peer connections, or real-time communications such as instant messaging or remote assistance (a feature in Windows XP), you should enable UPnP.

➤ **To turn on Universal Plug and Play:**

1. Select **ADVANCED > Advanced Setup > UPnP**.

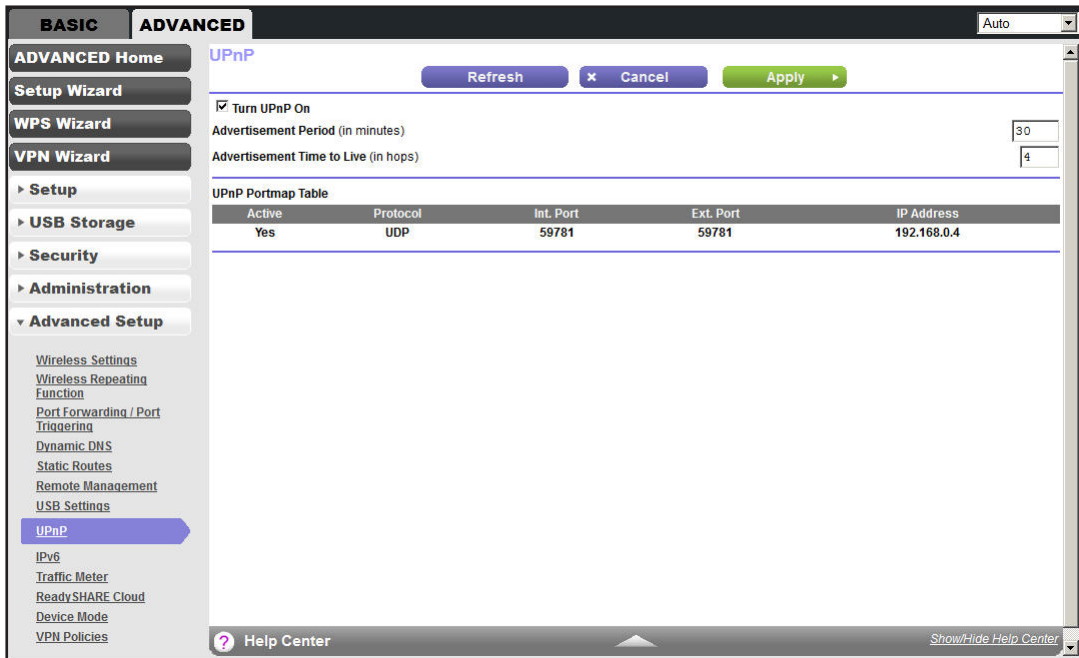

2. Configure the following settings:

- **Turn UPnP On.** Enable or disable automatic device configuration. The default setting for UPnP is disabled. If this check box is not selected, the WiFi DSL modem router does not allow any device to automatically control the resources, such as port forwarding (mapping), of the WiFi DSL modem router.
- **Advertisement Period.** The advertisement period is how often the WiFi DSL modem router broadcasts its UPnP information. This value can range from 1 to 1440 minutes. The default period is 30 minutes. Shorter durations ensure that control points have current device status at the expense of more network traffic. Longer durations can compromise the freshness of the device status, but can significantly reduce network traffic.

- **Advertisement Time to Live.** The time to live for the advertisement is measured in hops (steps) for each UPnP packet sent. The time to live hop count is the number of steps a broadcast packet is allowed to propagate for each UPnP advertisement before it disappears. The number of hops can range from 1 to 255. The default value for the advertisement time to live is 4 hops, which should be fine for most home networks. If you notice that some devices are not being updated or reached correctly, it might be necessary to increase this value.
- **UPnP Portmap Table.** The UPnP Portmap table displays the IP address of each UPnP device that is accessing the WiFi DSL modem router and which ports (internal and external) that device has opened. The UPnP Portmap table also displays what type of port is open and whether that port is still active for each IP address.

3. Click **Apply**.

IPv6

You can use this feature to set up an IPv6 Internet connection type if NETGEAR genie does not detect it automatically.

➤ **To set up an IPv6 Internet connection type:**

1. Select **ADVANCED > Advanced Setup > IPv6**.

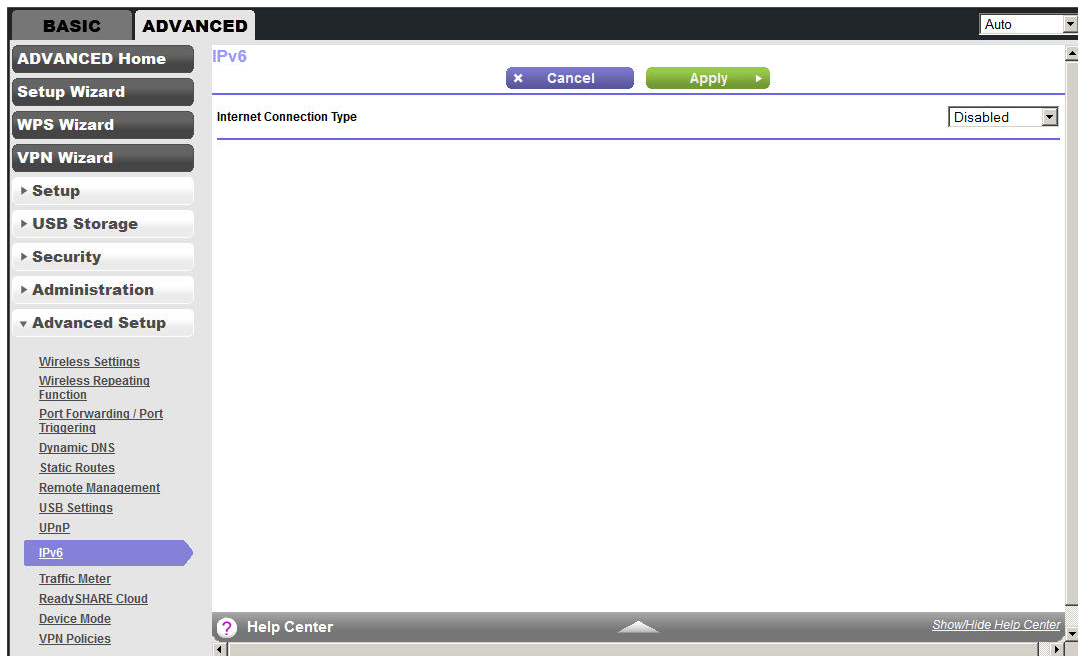

2. Select the IPv6 connection type from the list. Your Internet service provider (ISP) can provide this information.
- If your ISP did not provide details, select **IPv6 Tunnel**.
 - If you are not sure and want to have the WiFi DSL modem router detect the IPv6 type that is in use, select **Auto Detect**.

- If your Internet connection does not use PPPoE, DHCP, or fixed, but is IPv6, then select **IPv6 auto config**.

3. Click **Apply**.

Traffic Meter

Traffic metering allows you to monitor the volume of Internet traffic passing through your WiFi DSL modem router's Internet port. With the traffic meter utility, you can set limits for traffic volume, set a monthly limit, and get a live update of traffic usage.

➤ **To monitor Internet traffic:**

1. Click **ADVANCED > Advanced Setup > Traffic Meter**.

2. Select the **Enable Traffic Meter** check box.
3. Enter the time and day to restart the traffic counter.
4. Click **Restart Counter Now**.
5. (Optional) Select the **Traffic volume control by** radio button.

To record and restrict the volume of Internet traffic, select one of the following options for controlling the traffic volume:

- **No limit.** No restriction is applied when the traffic limit is reached.
 - **Download only.** The restriction is applied to incoming traffic only.
 - **Both directions.** The restriction is applied to both incoming and outgoing traffic.
6. Specify how many Mbytes of data traffic per month are allowed, or specify how many hours of traffic are allowed.

7. Set the traffic counter to begin at a specific time and date.
8. Set up traffic control to issue a warning message before the monthly limit of Mbytes or hours is reached.

You can select one of the following to occur when the limit is attained:

- The Internet LED blinks green or amber.
 - The Internet connection is disconnected and disabled.
9. Set up Internet traffic statistics to monitor the data traffic.
 10. Click the **Traffic Status** button.

You get a live update of the status of Internet traffic on your WiFi DSL modem router.
 11. Click **Apply**.

Device Mode

When the WiFi DSL modem router is in Router mode, this screen allows switching to Modem mode, where the WiFi DSL modem router acts as a pure bridge or DSL modem.

Routing, firewall, wireless support, USB, and the traffic meter are not available in Modem mode. A typical application is a small-to-medium business scenario where the WiFi DSL modem router is used for DSL connectivity behind a carrier class router or firewall or security device manager. When the WiFi DSL modem router is in Modem mode, this screen allows switching back to Router mode with all of the standard features.

➤ **To switch the device mode:**

1. Select **ADVANCED > Advanced Setup > Device Mode**.

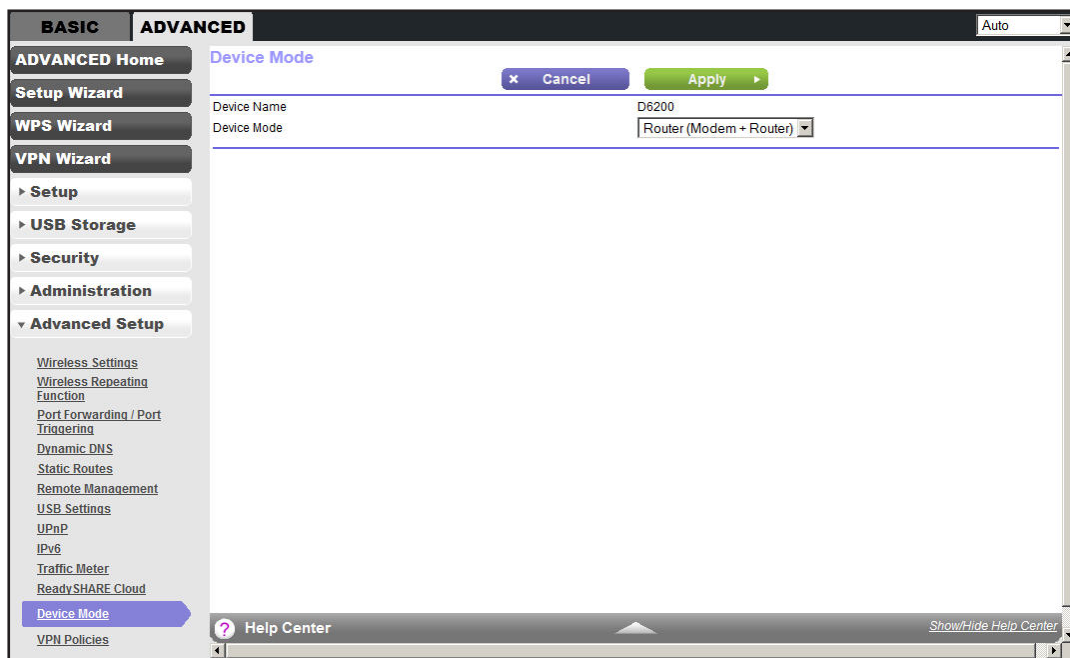

2. From the Device Mode list, select **Router (Modem + Router)** or **Modem (Modem only)**.
3. Click **Apply**.

VPN Policies

Manage your VPN policies from the VPN Policies screen.

- Traffic covered by a policy is automatically sent through a VPN tunnel.
- Where traffic is covered by two or more policies, the first matching policy is used. In this situation, the order of the policies is important. However, if you only have one policy for each remote VPN endpoint, the policy order is not important.
- The VPN tunnel is created according to the parameters in the SA (security association).

- The remote VPN endpoint must have a matching SA, or else it refuses the connection.

Two types of VPN policies are possible:

- **Manual.** All settings (including the keys) for the VPN tunnel are input manually at each end (both VPN endpoints). No third-party server or organization is involved.
- **Auto.** Some parameters for the VPN tunnel are generated automatically. This process requires using the IKE (Internet Key Exchange) protocol to perform negotiations between the two VPN endpoints.

➤ **To manage the VPN policies:**

1. Click **ADVANCED > Advanced Setup > VPN Policies.**

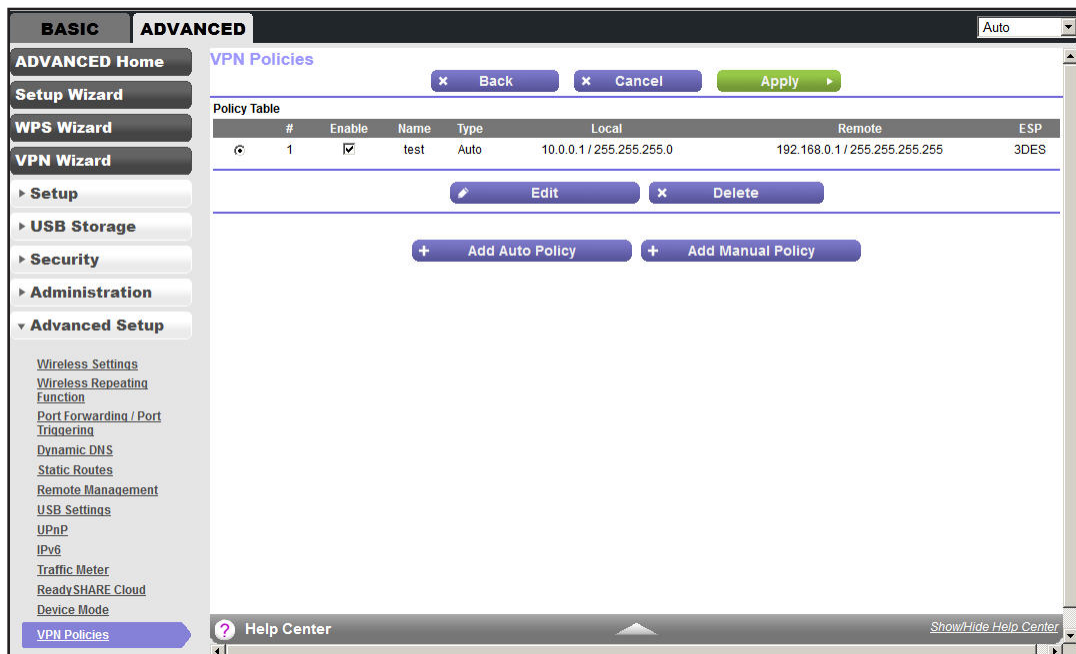

The Policy Table contains the following data:

- **Enable.** Use this check box to enable or disable a policy as required. Click **Apply** when you are finished.
 - **Name.** Each policy has a unique name to identify it.
 - **Type.** The type is Auto or Manual.
 - **Local.** IP address or address range on your local LAN. Traffic must be from (or to) the addresses covered by this policy.
 - **Remote.** IP address or address range of the remote network. Traffic must be to (or from) the addresses covered by this policy.
 - **ESP.** Encapsulating Security Payload. This setting specifies the encryption protocol used for the VPN data.
2. Click the appropriate button to manage a VPN policy:
 - **Edit.** Edit (modify) the selected policy. (Select a policy by selecting the radio button.)

- **Delete.** Delete the selected policy.
- **Apply.** Save any changes to the Enable setting for each policy.
- **Cancel.** Discard any unsaved changes to the Enable setting for each policy.
- **Add Auto Policy.** Display the VPN - Auto Policy screen. When the new policy is saved, it appears in the bottom row of the Policy Table. See [Add or Edit an Auto VPN Policy](#) on page 132.
- **Add Manual Policy.** Display the VPN - Manual Policy screen. When the new policy is saved, it appears in the bottom row of the Policy Table. See [Add or Edit a Manual VPN Policy](#) on page 135.

Add or Edit an Auto VPN Policy

An Auto VPN policy uses the IKE (Internet Key Protocol) to exchange and negotiate parameters for the IPsec SA (security association). Because of this negotiation, not all of the settings on this VPN gateway have to match the settings on the remote VPN endpoint. Where settings have match, this requirement is indicated.

➤ To add or edit an Auto VPN Policy:

1. Click **ADVANCED > Advanced Setup > VPN Policies.**
2. Click the **Add Auto Policy.**

The screenshot shows the 'VPN - Auto Policy' configuration page. On the left is a navigation menu with 'VPN Policies' selected. The main area has tabs for 'BASIC' and 'ADVANCED'. The 'ADVANCED' tab is active, showing the following settings:

- General:** Policy Name (text field), Remote Endpoint (text field), Address Type: Dynamic IP Address (dropdown), Address Data: n/a (text field), Ping IP Address: (IP address fields).
- Local LAN:** IP Address (text field), Subnet address (dropdown), Single/Start IP Address: 10.0.0.1 (IP address fields), Finish IP Address: (IP address fields), Subnet Mask: 255.255.255.0 (IP address fields).
- Remote LAN:** IP Address (text field), Single PC - no Subnet (dropdown), Single/Start IP Address: (IP address fields), Finish IP Address: (IP address fields), Subnet Mask: (IP address fields).
- IKE:** Direction: Responder only (dropdown), Exchange Mode: Main Mode (dropdown), Diffie-Hellman (DH) Group: Auto (dropdown).

3. Enter or select the following settings:
 - **General.** These settings identify this policy and determine its major characteristics.
 - **Policy Name.** Enter a unique name to identify this policy.

This name is not supplied to the remote VPN endpoint. It is used only to help you manage the policies.

- **Remote VPN Endpoint.** If the remote endpoint has a dynamic IP address, select **Dynamic IP Address**.

No address data input is required.

Otherwise, select the desired option (IP address or domain name) and enter the address of the remote VPN endpoint you wish to connect to.

The remote VPN endpoint must have this VPN gateway's address entered as its remote VPN endpoint.

- **IKE Keep Alive.** Check this check box if you wish to ensure that a connection is kept open, or, if that is not possible, it is quickly reestablished when disconnected.

The ping IP address has to be associated with the remote endpoint. Either the WAN or a LAN address can be used; a LAN address is preferable. This IP address is pinged to generate some traffic for the VPN tunnel.

- **Local LAN.** These settings identify which computers on your LAN are covered by this policy. For each selection, data must be provided as follows:

- **Single address.** Enter an IP address in the Single/Start IP address field.

Typically, this setting is used when you wish to make a single server on your LAN available to remote users.

- **Range address.** Enter the starting IP address in the Single/Start IP address field, and the finish IP address in the Finish IP address field.

A range must be an address range used on your LAN.

- **Subnet address.** Enter an IP address in the Single/Start IP address field, and the desired network mask in the Subnet Mask field.

The remote VPN endpoint must have these IP addresses entered as its remote addresses.

- **Remote LAN.** These settings identify which computers on the remote LAN are covered by this policy. For each selection, data must be provided as follows:

- **Single PC - no Subnet.** Select this option if there is no LAN (only a single computer) at the remote endpoint.

If this option is selected, no additional data is required.

- **Single address.** Enter an IP address in the Single/Start IP address field.

This value must be an address on the remote LAN. Typically, this setting is used when you wish to access a server on the remote LAN.

- **Range address.** Enter the starting IP address in the Single/Start IP address field, and the finish IP address in the Finish IP address field.

This range must be an address range used on the remote LAN.

- **Subnet address.** Enter an IP address in the Single/Start IP address field, and the desired network mask in the Subnet Mask field.

The remote VPN endpoint must have these IP addresses entered as its local addresses.

- **IKE.**

- **Direction/Type.** This setting is used to determine if the IKE policy matches the current traffic. Select the desired option.
- **Responder only.** Incoming connections are allowed, but outgoing connections are blocked.
- **Initiator and Responder.** Both incoming and outgoing connections are allowed.
- **Exchange Mode.** Currently, only Main Mode is supported. Ensure that the remote VPN endpoint is set to use Main Mode.
- **Diffie-Hellman (DH) Group.** When the VPN connection keys are exchanged, the Diffie-Hellman algorithm is used. The DH Group setting determines the bit size used in the exchange. This value must match the value used on the remote VPN gateway.
- **Local Identity Type.** Select the desired option to match the Remote Identity Type setting on the remote VPN endpoint.
- **WAN IP Address.** Your Internet IP address.
- **Fully Qualified Domain Name.** Your domain name.
- **Fully Qualified User Name.** Your name, email address, or other ID.
- **Local Identity Data.** Enter the data for the selection. When WAN IP Address is selected, no input is required.
- **Remote Identity Type.** Select the desired option to match the Local Identity Type setting on the remote VPN endpoint.
- **IP Address.** The Internet IP address of the remote VPN endpoint.
- **Fully Qualified Domain Name.** The domain name of the remote VPN endpoint.
- **Fully Qualified User Name.** The name, email address, or other ID of the remote VPN endpoint.
- **Remote Identity Data.** Enter the data for the selection. When IP Address is selected, no input is required.

- **Parameters.**

- **Encryption Algorithm.** The encryption algorithm used for both IKE and IPSec. This setting must match the setting used on the remote VPN gateway.
- **Authentication Algorithm.** The authentication algorithm used for both IKE and IPSec. This setting must match the setting used on the remote VPN gateway.
- **Pre-shared Key.** The key has to be entered both here and on the remote VPN gateway.
- **SA Life Time.** This setting determines the time interval before the SA (security association) expires. (It is automatically reestablished as required.) While using a short time period (or data amount) increases security, it also degrades

performance. It is common to use periods over an hour (3600 seconds) for the SA lifetime. This setting applies to both IKE and IPSec SAs.

- **Enable PFS (Perfect Forward Secrecy).** If enabled, security is enhanced by ensuring that the key is changed at regular intervals. Also, even if one key is broken, subsequent keys are no easier to break. (Each key has no relationship to the previous key.)

This setting applies to both IKE and IPSec SAs. When configuring the remote endpoint to match this setting, you might need to specify the key group used. For this device, the key group is the same as the DH Group setting in the IKE section.

4. Click **Apply**.

Add or Edit a Manual VPN Policy

A Manual VPN policy requires all settings (including the keys) for the VPN tunnel to be manually input at each end (both VPN endpoints). No third-party server or organization is involved.

- **To add or edit a Manual VPN policy:**
 1. Select **ADVANCED > Advanced Setup > VPN Policies**.
 2. Click the **Add Manual Policy**.

The screenshot shows the 'VPN - Manual Policy' configuration page. The left sidebar contains navigation options like 'ADVANCED Home', 'Setup Wizard', 'WPS Wizard', 'VPN Wizard', and 'Advanced Setup'. The main content area is titled 'VPN - Manual Policy' and includes 'Back', 'Cancel', and 'Apply' buttons. The configuration is organized into several sections:

- General:** Policy Name (text input), Remote Endpoint (Address Type: Fixed IP Address, Address Data: text input).
- Local LAN:** IP Address (Subnet address dropdown, Single/Start IP Address: 10.0.0.1, Finish IP Address: text input, Subnet Mask: 255.255.255.0).
- Remote LAN:** IP Address (Single PC - no Subnet dropdown, Single/Start IP Address: text input, Finish IP Address: text input, Subnet Mask: text input).
- ESP Configuration:** SPI - Incoming (Hex, 3 Characters), SPI - Outgoing (Hex, 3 Characters), Encryption Algorithm (3DES dropdown), Key (text input, DES - 8 chars; 3DES - 24 chars).

3. Enter or select the following parameters:
 - **General.** These settings identify this policy and determine its major characteristics.
 - **Policy Name.** Enter a unique name to identify this policy. This name is not supplied to the remote VPN endpoint. It is used only to help you manage the policies.

- **Remote VPN Endpoint.** Select the desired option (IP address or domain name) and enter the address or domain name of the remote VPN endpoint you wish to connect to.

The remote VPN endpoint must have this VPN gateway's address entered as its remote VPN endpoint.

- **Local LAN.** These settings identify which computers on your LAN are covered by this policy. For each selection, data must be provided as follows:
 - **Single address.** Enter an IP address in the Single/Start IP address field. Typically, this setting is used when you wish to make a single server on your LAN available to remote users.
 - **Range address.** Enter the starting IP address in the Single/Start IP address field, and the finish IP address in the Finish IP address field. This setting must be an address range used on your LAN.
 - **Subnet address.** Enter an IP address in the Single/Start IP address field, and the desired network mask in the Subnet Mask field.

The remote VPN endpoint must have these IP addresses entered as its remote addresses.

- **Remote LAN.** These identify which computers on the remote LAN are covered by this policy. For each selection, data must be provided as follows:
 - **Single PC - dynamic IP.** Select this option if there is no LAN (only a single computer) at the remote endpoint. If this option is selected, no additional data is required.
 - **Single address.** Enter an IP address in the Single/Start IP address field. This setting must be an address on the remote LAN. Typically, this setting is used when you wish to access a server on the remote LAN.
 - **Range address.** Enter the starting IP address in the Single/Start IP address field, and the finish IP address in the Finish IP address field. This range must be an address range used on the remote LAN.
 - **Subnet address.** Enter an IP address in the Single/Start IP address field, and the desired network mask in the Subnet Mask field.

The remote VPN endpoint must have these IP addresses entered as its local addresses.

- **ESP Configuration.** ESP (encapsulating security payload) provides security for the payload (data) sent through the VPN tunnel.
 - **SPI.** Enter the required SPIs. Each policy must have unique SPIs. These settings must match those for the remote VPN endpoint. The Incoming setting here must match the Outgoing setting on the remote VPN endpoint, and the Outgoing setting here must match the Incoming setting on the remote VPN endpoint.
 - **Encryption.** Select the desired encryption algorithm, and enter the key in the field provided. For 3DES, the keys should be 24 ASCII characters (48 hex characters).

- **Authentication.** Select the desired authentication algorithm, and enter the key in the field provided. For MD5, the keys should be 16 ASCII characters (32 hex characters). For SHA-1, the keys should be 20 ASCII (40 hex characters).
4. Click **Apply**.

10 Troubleshooting

10

Diagnose and solve problems

This chapter provides information to help you diagnose and solve problems you might have with your WiFi DSL modem router. If you do not find the solution here, check the NETGEAR support site at <http://support.netgear.com/general/contact/default.aspx> for product and contact information.

This chapter contains the following sections:

- *Quick Tips*
- *Troubleshoot with the LEDs*
- *Cannot Log In to the Router*
- *Cannot Access the Internet*
- *Changes Not Saved*
- *Incorrect Date or Time*
- *Wireless Connectivity*
- *Restore the Factory Settings and Password*
- *Troubleshoot Your Network Using the Ping Utility*

Quick Tips

This section describes tips for troubleshooting some common problems.

Sequence to Restart Your Network

Be sure to restart your network in this sequence:

1. Turn off *and* unplug the modem.
2. Turn off the WiFi DSL modem router and computers.
3. Plug in the modem and turn it on. Wait 2 minutes.
4. Turn on the WiFi DSL modem router. Wait 2 minutes.
5. Turn on the computers.

Check Ethernet Cable Connections

Make sure that the Ethernet cables are securely plugged in:

- The Internet status LED on the WiFi DSL modem router is lit if the Ethernet cable connecting the WiFi DSL modem router and the modem is plugged in securely and the modem and WiFi DSL modem router are turned on.
- For each powered-on computer connected to the WiFi DSL modem router by an Ethernet cable, the corresponding numbered router LAN port LED on the back of the WiFi DSL modem router is lit.

Wireless Settings

Make sure that the wireless settings in the computer and WiFi DSL modem router match exactly.

- For a wirelessly connected computer, the wireless network name (SSID) and wireless security settings of the WiFi DSL modem router and wireless computer need to match exactly.
- If you set up an access list in the Advanced Wireless Settings screen, you have to add each wireless computer's MAC address to the WiFi DSL modem router's access list.

Network Settings

Make sure that the network settings of the computer are correct:

- Wired and wirelessly connected computers need to have network (IP) addresses on the same network as the WiFi DSL modem router. The simplest way to achieve this address commonality is to configure each computer to obtain an IP address automatically using DHCP.

- Some cable modem service providers require you to use the MAC address of the computer initially registered on the account. You can view the MAC address in the Attached Devices screen.

Troubleshoot with the LEDs

After you turn on power to the WiFi DSL modem router, the following sequence of events should occur:

1. When power is first applied, verify that the Power LED is lit.
2. Verify that the Power LED turns red within a few seconds, indicating that the self-test is running.
3. After approximately 30 seconds, verify the following:
 - The Power LED is solid green.
 - The Internet LED is lit.
 - The Ethernet LED is lit for any local port that is connected to a computer. This LED indicates that a link has been established to the connected device.

The LEDs on the front panel of the WiFi DSL modem router can be used for troubleshooting.

Power LED Is Off or Blinking

- Make sure that the power cord is securely connected to your WiFi DSL modem router and that the power adapter is securely connected to a functioning power outlet.
- Make sure that you are using the power adapter that NETGEAR supplied for this product.
- If the Power LED blinks slowly and continuously, the WiFi DSL modem router firmware is corrupted. This situation can happen if a firmware upgrade is interrupted, or if the WiFi DSL modem router detects a problem with the firmware. If the error persists, you have a hardware problem. For recovery instructions or help with a hardware problem, contact technical support at <http://support.netgear.com/general/contact/default.aspx>.

Power LED Stays Red

When the WiFi DSL modem router is turned on, the Power LED turns red for about 20 seconds and then turns green. If the LED does not turn green, the WiFi DSL modem router has a problem.

If the Power LED is still red 1 minute after you turn on power to the WiFi DSL modem router:

1. Turn off the power and back on to see if the WiFi DSL modem router recovers.
2. Press and hold the **Reset** button to return the WiFi DSL modem router to its factory settings.

See *Factory Settings* on page 150.

If the error persists, you might have a hardware problem and should contact technical support at www.netgear.com/support.

LEDs Never Turn Off

When the WiFi DSL modem router is turned on, the LEDs light for about 10 seconds and then turn off. If all the LEDs stay lit, a fault exists within the WiFi DSL modem router.

If all LEDs are still lit 1 minute after power-up:

- Cycle the power to see if the WiFi DSL modem router recovers.
- Press and hold the **Reset** button to return the WiFi DSL modem router to its factory settings. See *Factory Settings* on page 150.

If the error persists, you might have a hardware problem and should contact technical support at www.netgear.com/support.

Internet or Ethernet Port LEDs Are Off

If the Internet LED or the Ethernet port LEDs do not light when the Ethernet connection is made, check the following:

- Make sure that the Ethernet cable connections are secure at the WiFi DSL modem router and at the modem or computer.
- Make sure that power is turned on to the connected modem or computer.
- Be sure that you are using the correct cable.

When connecting the WiFi DSL modem router's Internet port to a cable or DSL modem, use the cable that was supplied with the cable or DSL modem. This cable could be a standard straight-through Ethernet cable or an Ethernet crossover cable.

Wireless LED Is Off

If the Wireless LED stays off, check to see if the WiFi On/Off button on the WiFi DSL modem router has been pressed. This button turns the wireless radios in the WiFi DSL modem router on and off. The Wireless LEDs are lit when the wireless radio is turned on.

The Push 'N' Connect (WPS) Button Does Not Work

If after you press the WPS button and the Wireless LED does not blink, check the following:

- Make sure that you are using the button and not the WiFi DSL modem router's built-in registrar.
- Check that PIN verification has succeeded for the wireless device you are adding to the wireless network.
- Make sure that you have not pressed the WPS button on the side of the WiFi DSL modem router after disabling the WPS feature (you logged in to the WiFi DSL modem router and disabled this feature previously).
- Check that the WiFi DSL modem router is not in the temporary AP setup locked state (if you are using the wireless repeater function).

Cannot Log In to the Router

If you are unable to log in to the WiFi DSL modem router from a computer on your local network, check the following:

- If you are using an Ethernet-connected computer, check the Ethernet connection between the computer and the WiFi DSL modem router. For more information, see [Check Ethernet Cable Connections](#) on page 139.
- Make sure that your computer's IP address is on the same subnet as the WiFi DSL modem router. If you are using the recommended addressing scheme, your computer's address should be in the range of 192.168.0.2 to 192.168.0.254.
- If your computer's IP address is shown as 169.254.x.x, recent versions of Windows and Mac OS generate and assign an IP address if the computer cannot reach a DHCP server. These autogenerated addresses are in the range of 169.254.x.x. If your IP address is in this range, check the connection from the computer to the WiFi DSL modem router, and reboot your computer.
- If your WiFi DSL modem router's IP address was changed and you do not know the current IP address, clear the WiFi DSL modem router's configuration to factory defaults. This procedure sets the WiFi DSL modem router's IP address to 192.168.0.1. This procedure is explained in [Factory Settings](#) on page 150.
- Make sure that your browser has Java, JavaScript, or ActiveX enabled. If you are using Internet Explorer, click **Refresh** to be sure that the Java applet is loaded.
- Try quitting the browser and launching it again.
- Make sure that you are using the correct login information. The factory default login name is admin and the password is password. Make sure that Caps Lock is off when you enter this information.
- If you are attempting to set up your NETGEAR WiFi DSL modem router as an additional router behind an existing router in your network, consider replacing the existing router instead. NETGEAR does not support such a configuration.
- If you are attempting to set up your NETGEAR WiFi DSL modem router as a replacement for an ADSL gateway in your network, the WiFi DSL modem router cannot perform many gateway services, for example, converting ADSL or cable data into Ethernet networking information. NETGEAR does not support such a configuration.

Cannot Access the Internet

If you can access your router but you are unable to access the Internet, first determine whether the WiFi DSL modem router can obtain an IP address from your Internet service provider (ISP). Unless your ISP provides a fixed IP address, your WiFi DSL modem router requests an IP address from the ISP. You can determine whether the request was successful using the Router Status screen.

➤ **To check the WAN IP address:**

1. Start your browser and select an external site such as <http://www.netgear.com>.
2. Access the WiFi DSL modem router interface at <http://www.routerlogin.net>.
3. Select **Administration > Router Status**.
4. Check that an IP address is shown for the Internet port. If 0.0.0.0 is shown, your WiFi DSL modem router has not obtained an IP address from your ISP.

If your WiFi DSL modem router cannot obtain an IP address from the ISP, you might need to force your cable or DSL modem to recognize your new WiFi DSL modem router by restarting your network. For more information, see [Sequence to Restart Your Network](#) on page 139.

If your WiFi DSL modem router is still unable to obtain an IP address from the ISP, the problem might be one of the following:

- Your Internet service provider (ISP) might require a login program.
Ask your ISP whether it requires PPP over Ethernet (PPPoE) or some other type of login.
- If your ISP requires a login, the login name and password might be set incorrectly.
- Your ISP might check for your computer's host name.
Assign the computer host name of your ISP account as the account name in the Internet Setup screen.
- Your ISP allows only one Ethernet MAC address to connect to the Internet and might check for your computer's MAC address. In this case, do one of the following:
 - Inform your ISP that you have bought a new network device, and ask them to use the WiFi DSL modem router's MAC address.
 - Configure your WiFi DSL modem router to clone your computer's MAC address.

If your WiFi DSL modem router can obtain an IP address, but your computer is unable to load any web pages from the Internet:

- Your computer might not recognize any DNS server addresses.

A DNS server is a host on the Internet that translates Internet names (such as www addresses) to numeric IP addresses. Typically, your ISP provides the addresses of one or two DNS servers for your use. If you entered a DNS address during the WiFi DSL modem router's configuration, reboot your computer, and verify that DNS address. You can configure your computer manually with DNS addresses, as explained in your operating system documentation.

- Your computer might not have the WiFi DSL modem router configured as its TCP/IP gateway.

If your computer obtains its information from the WiFi DSL modem router by DHCP, reboot the computer, and verify the gateway address.

- You might be running login software that is no longer needed.

If your ISP provided a program to log you in to the Internet (such as WinPoET), you no longer need to run that software after installing your WiFi DSL modem router. You might need to go to Internet Explorer and select **Tools > Internet Options**, click the **Connections** tab, and select **Never dial a connection**.

Troubleshoot PPPoE

If you are using PPPoE, try troubleshooting your Internet connection.

➤ **To troubleshoot a PPPoE connection:**

1. Log in to the WiFi DSL modem router.
2. Select **Administration > Router Status**.
3. Click **Connection Status**.

If time remains on Lease Expires, your PPPoE connection is working. Otherwise, there might also be a provisioning problem with your ISP.

Note: Unless you connect manually, the WiFi DSL modem router does not authenticate using PPPoE until data is transmitted to the network.

Troubleshoot Internet Browsing

If your WiFi DSL modem router can obtain an IP address but your computer is unable to load any web pages from the Internet, check the following:

- Your computer might not recognize any DNS server addresses. A DNS server is a host on the Internet that translates Internet names (such as www addresses) to numeric IP addresses.

Typically, your ISP provides the addresses of one or two DNS servers for your use. If you entered a DNS address during the WiFi DSL modem router's configuration, restart your computer.

Alternatively, you can configure your computer manually with a DNS address, as explained in the documentation for your computer.

- Your computer might not have the WiFi DSL modem router configured as its default gateway.

Reboot the computer, and verify that the WiFi DSL modem router address (www.routerlogin.net) is listed by your computer as the default gateway address.

- You might be running login software that is no longer needed. If your ISP provided a program to log you in to the Internet (such as WinPoET), you no longer need to run that software after installing your WiFi DSL modem router. You might need to go to Internet Explorer and select **Tools > Internet Options**, click the **Connections** tab, and select **Never dial a connection**.

Changes Not Saved

If the WiFi DSL modem router does not save the changes you make in the WiFi DSL modem router interface, check the following:

- When entering configuration settings, always click the **Apply** button before moving to another screen or tab, or your changes are lost.
- Click the **Refresh** or **Reload** button in the web browser. The changes might have occurred, but the old settings might be in the web browser's cache.

Incorrect Date or Time

Select **ADVANCED > Security > Schedule** to display the current date and time. The WiFi DSL modem router uses the Network Time Protocol (NTP) to obtain the current time from one of several network time servers on the Internet. Each entry in the log is stamped with the date and time of day. Problems with the date and time function can include the following:

- Date shown is January 1, 2000. This value means the WiFi DSL modem router has not yet successfully reached a network time server. Check that your Internet access is configured correctly. If you have finished setting up the WiFi DSL modem router, wait at least 5 minutes, and check the date and time again.
- Time is off by one hour. The WiFi DSL modem router does not automatically sense daylight saving time. In the Schedule screen, select the **Automatically adjust for daylight savings time** check box.

Wireless Connectivity

If you are having trouble connecting wirelessly to the WiFi DSL modem router, try to isolate the problem.

- Does the wireless device or computer that you are using find your wireless network?

If not, check the Wireless LED on the front of the WiFi DSL modem router. It should be lit. If they are not, you can press the **WiFi On/Off** button on the side of the WiFi DSL modem router to turn the WiFi DSL modem router's wireless radio back on.

If you disabled the WiFi DSL modem router's SSID broadcast, then your wireless network is hidden and does not show up in your wireless client's scanning list. By default, SSID broadcast is enabled.

- Does your wireless device support the security that you are using for your wireless network (WPA or WPA2)?
- If you want to view the wireless settings for the WiFi DSL modem router, use an Ethernet cable to connect a computer to a LAN port on the WiFi DSL modem router. Then log in to the WiFi DSL modem router and select **BASIC > Wireless**. For more information, see [Basic Wireless Settings](#) on page 32.

Note: Be sure to click **Apply** when you make changes.

If your wireless device finds your network, but the signal strength is weak, check these conditions:

- Is your WiFi DSL modem router too far from your computer, or too close? Place your computer near the WiFi DSL modem router, but at least 6 feet away, and see whether the signal strength improves.
- Is your wireless signal blocked by objects between the WiFi DSL modem router and your computer?

Restore the Factory Settings and Password

This section explains how to restore the factory settings, changing the WiFi DSL modem router's administration password back to **password**. You can erase the current configuration and restore factory defaults in two ways:

- Use the Erase function of the WiFi DSL modem router (see *Erase* on page 98).
- Use the Reset button on the back of the WiFi DSL modem router. See *Factory Settings* on page 150. If you restore the factory settings and the WiFi DSL modem router fails to restart, or the green Power LED continues to blink, the unit might be defective. If the error persists, you might have a hardware problem and should contact technical support at <http://www.netgear.com/support>.

Troubleshoot Your Network Using the Ping Utility

Most network devices and routers contain a ping utility that sends an echo request packet to the designated device. The device then responds with an echo reply. You can easily troubleshoot a network by using the ping utility in your computer or workstation.

Test the LAN Path to Your Router

You can ping the WiFi DSL modem router from your computer to verify that the LAN path to your WiFi DSL modem router is set up correctly.

➤ **To ping the WiFi DSL modem router from a computer running Windows:**

1. From the Windows toolbar, click **Start** and select **Run**.
2. In the field provided, type **ping** followed by the IP address of the WiFi DSL modem router, as in this example:

```
ping www.routerlogin.net
```

3. Click **OK**.

You should see a message like this one:

```
Pinging <IP address > with 32 bytes of data
```

If the path is working, you see this message:

```
Reply from < IP address >: bytes=32 time=NN ms TTL=xxx
```

If the path is not working, you see this message:

```
Request timed out
```

If the path is not functioning correctly, you might have one of the following problems:

- Wrong physical connections

For a wired connection, make sure that the numbered LAN port LED is lit for the port to which you are connected.

Check that the appropriate LEDs are lit for your network devices. If your WiFi DSL modem router and computer are connected to a separate Ethernet switch, make sure that the Ethernet LEDs are lit for the switch ports that are connected to your computer and WiFi DSL modem router.

- Wrong network configuration

Verify that the Ethernet card driver software and TCP/IP software are both installed and configured on your computer.

Verify that the IP address for your WiFi DSL modem router and your computer are correct and that the addresses are on the same subnet.

Test the Path from Your Computer to a Remote Device

After verifying that the LAN path works correctly, test the path from your computer to a remote device.

1. From the Windows toolbar, click **Start** and select **Run**.
2. In the Windows Run window, type:

```
ping -n 10 <IP address>
```

where <IP address> is the IP address of a remote device such as your ISP DNS server.

If the path is functioning correctly, replies like the examples shown in the previous section are displayed.

If you do not receive replies:

- Check that your computer has the IP address of your WiFi DSL modem router listed as the default gateway. If the IP configuration of your computer is assigned by DHCP, this information is not visible in your computer's Network Control Panel. Verify that the IP address of the WiFi DSL modem router is listed as the default gateway.
- Check to see that the network address of your computer (the portion of the IP address specified by the subnet mask) is different from the network address of the remote device.
- Check that your cable or DSL modem is connected and functioning.

- If your ISP assigned a host name to your computer, enter that host name as the account name in the Internet Setup screen.
- Your ISP could be rejecting the Ethernet MAC addresses of all but one of your computers.

Many broadband ISPs restrict access by allowing traffic only from the MAC address of your broadband modem, but some ISPs additionally restrict access to the MAC address of a single computer connected to that modem. If so, configure your WiFi DSL modem router to “clone” or “spoof” the MAC address from the authorized computer.

A Supplemental Information

A

Factory settings and technical specifications

This appendix provides factory default settings and technical specifications for the D6200 WiFi DSL Modem Router.

- *Factory Settings*
- *Technical Specifications*

Factory Settings

You can return the WiFi DSL modem router to its factory settings. Use the end of a paper clip or some other similar object to press and hold the **Reset** button on the back of the router for at least 5 seconds. The WiFi DSL modem router resets and returns to the factory settings. Your device returns to the factory configuration settings shown in the following table.

Table 10. Factory default settings

Feature		Default Behavior
Router login	User login URL	www.routerlogin.com or www.routerlogin.net
	User name (case-sensitive)	admin
	Login password (case-sensitive)	password
Internet connection	WAN MAC address	Use default hardware address
	WAN MTU size	1500
	Port speed	Autosensing
Local network (LAN)	LAN IP	192.168.0.1
	Subnet mask	255.255.255.0
	DHCP server	Enabled
	DHCP range	192.168.0.2 to 192.168.0.254
	Allow a registrar to configure this router	Enabled
	DHCP starting IP address	192.168.0.2
	DHCP ending IP address	192.168.0.254
Local network (LAN) continued	DMZ	Disabled
	Time zone	GMT for WW except NA and GR, GMT+1 for GR, GMT-8 for NA
	Time zone adjusted for daylight saving time	Disabled
Firewall	Inbound (communications coming in from the Internet)	Disabled (except traffic on port 80, the HTTP port)
	Outbound (communications going out to the Internet)	Enabled (all)
	Source MAC filtering	Disabled

Table 10. Factory default settings (continued)

Feature		Default Behavior
Wireless	Wireless communication	Enabled
	SSID name	See router label
	Security	Enabled
	Broadcast SSID	Enabled
	Transmission speed	Auto ¹
	Country/region	United States in the US; otherwise, varies by region
	RF channel	6 until region selected
	Operating mode	Up to 867 Mbps
	Data rate	Best
	Output power	Full
Firewall	Inbound (communications coming in from the Internet)	Disabled (bars all unsolicited requests)
	Outbound (communications going out to the Internet)	Enabled (all)

1. Maximum wireless signal rate derived from IEEE Standard 802.11 specifications. Actual throughput varies. Network conditions and environmental factors, including volume of network traffic, building materials and construction, and network overhead lower actual data throughput rate.

Technical Specifications

Table 11. D6200 Router specifications

Feature	Description
Data and routing protocols	TCP/IP, RIP-1, RIP-2, DHCP, PPPoE, Dynamic DNS, UPnP, and SMB
Power adapter	<ul style="list-style-type: none"> • North America: 120V, 60 Hz, input • UK, Australia: 240V, 50 Hz, input • Europe: 230V, 50 Hz, input • All regions (output): 12V DC @ 2.5A, output
Dimensions	205 mm x 255 mm x 77 mm (8.07 in. x 10.04 in. x 3.03 in.)
Weight	654g (1.44 lbs)
Operating temperature	0° to 40°C (32° to 104°F)
Operating humidity	90% maximum relative humidity, noncondensing
Electromagnetic emissions	FCC Part 15 Class B EN 55 022 (CISPR 22), Class B C-Tick N10947
LAN	10BASE-T or 1000BASE-Tx, RJ-45

Table 11. D6200 Router specifications (continued)

Feature	Description
WAN	10BASE-T or 1000BASE-Tx, RJ-45
Wireless	Maximum wireless signal rate complies with the IEEE 802.11 standard. See the footnote for the previous table.
Radio data rates	Auto Rate Sensing
Data encoding standards	IEEE 802.11n version 2.0 IEEE 802.11n, IEEE 802.11g, IEEE 802.11b 2.4 GHz IEEE 802.11n, IEEE 802.11a 5.0 GHz
Maximum computers per wireless network	Limited by the amount of wireless network traffic generated by each node (typically 50–70 nodes).
Operating frequency range	2.4 GHz 2.412–2.462 GHz (US) 2.412–2.472 GHz (Japan) 2.412–2.472 GHz (Europe ETSI) 5 GHz 5.18–5.24 + 5.745–5.825 GHz (US) 5.18–5.24 GHz (Europe ETSI)
802.11 security	WPA-PSK, WPA2-PSK, and WPA/WPA2 Enterprise

Index

A

- AC power adapter input **14**
- access
 - remote **124**
 - viewing logs **95, 96**
- access points **107**
- accessing remote computer **111**
- address reservation **53**
- ADSL microfilters **18**
- ADSL port **13**
- ADSL setup **46**
- advertisement period **126**
- alerts, emailing **87**
- approved USB devices **67**
- authentication, required by mail server **87**
- automatic firmware checking **90**
- automatic Internet connection **41**

B

- back panel **13**
- backing up configuration **97, 98**
- base station, setting up **109**
- blocking
 - inbound traffic **110**
 - keywords and sites **81**
- box contents **11**
- broadcasting SSID **34**

C

- cables, checking **139**
- changes not saved, router **145**
- configuration file **97, 98**
- connecting wirelessly **17**
- country setting **40**
- crossover cable **141**
- CTS/RTS Threshold **103**
- custom service (port forwarding) **116**

D

- dashboard **25**
- data packets, fragmented **49**
- date and time **145**
- daylight saving time **145**
- default DMZ server **48**
- default factory settings **12, 98, 150**
- default gateway **94**
- denial of service (DoS) protection **80**
- device mode **130**
- DHCP server **52, 94**
- DHCP setting **92**
- DMZ server **48**
- DNS addresses
 - primary **30**
 - troubleshooting **143**
- DNS servers **111**
- Domain Name Server (DNS) addresses **30, 92**
- DSL port LED **15**
- Dynamic DNS **120**

E

- electromagnetic emissions **151**
- email notices **87**
- erasing configuration **98**
- Ethernet cables, checking **139**
- Ethernet LED, troubleshooting **140, 141**

F

- factory default settings
 - list of **150**
 - restoring **98**
- file sharing **60**
- firewall settings **80**
- firmware version **91**
- firmware, upgrading **24, 90**
- fragmentation length **103**
- fragmented data packets **49**
- front panel **14, 16**

G

gateway IP address **30**
 genie, NETGEAR
 advanced settings **39**
 basic settings **28**
 setup, initial **23**
 using, after installation **24**
 guest networks **36, 92**

H

host name **30**
 host, trusted **81**

I

inbound traffic, allowing or blocking **110**
 Internet connection
 IPv6 **127**
 setting up **29**
 troubleshooting **142**
 Internet port **41, 92**
 Internet port LEDs **15, 140**
 Internet Relay Chat (IRC) **112**
 Internet service provider (ISP)
 account information **22**
 DSL synchronization **15**
 Internet Setup screen fields **29**
 interval, poll **94**
 IP addresses
 current **92**
 DHCP **22**
 dynamic **120**
 reserved **53**
 IP subnet mask **92**
 IPv6 Internet connection **127**

K

keywords **81**

L

LAN port
 settings **91**
 LAN ports **13**
 LAN setup **50**
 language setting **40**
 large files, sharing **61**
 lease, DHCP **94**
 LEDs **14, 16**

troubleshooting **140**
 verifying cabling **20**
 Live Parental Controls **32**
 local servers, port forwarding to **114**
 logging in **22, 24**
 logs
 emailing **87**
 viewing **95, 96**

M

MAC addresses
 current **92**
 mail server, outgoing **87**
 maintenance settings **89**
 managing router remotely **124**
 media server, setting router as **66**
 menus, described **25**
 metric value **123**
 microfilters **18**
 mixed mode security options **35**
 Modem mode **130**
 MTU size **48**
 multicasting **52**

N

NAT (Network Address Translation) **48, 111**
 NETGEAR genie
 advanced settings **39**
 basic settings, initial **28**
 setup, initial **23**
 using, after installation **24**
 Network Time Protocol (NTP) **145**
 networks
 correct settings, checking **139**
 guest **36, 92**
 restarting **139**

O

On/Off button **13**
 On/Off LED **15**
 one-line ADSL microfilter **18**
 outgoing mail server **87**

P

packets, fragmented **49**
 Parental Controls **32**
 passphrases, changing **35**

- password recovery, admin **99**
- passwords, restoring **146**
- photos, sharing **60**
- poll interval **94**
- port forwarding **110, 113, 114**
- port numbers **82**
- port status **93**
- port triggering **110, 112, 114, 118**
- ports, back panel **13**
- positioning the router **17**
- power adapter, AC **14**
- Power LED, troubleshooting **140**
- PPPoE (PPP over Ethernet) **143**
- Preamble mode **103**
- preset security
 - about **32**
 - passphrase **35**
- primary DNS addresses **30**
- printing files and photos **60**
- prioritizing traffic **54**
- Push 'N' Connect **27**

Q

- QoS (Quality of Service) **54**

R

- radio, wireless **103**
- range of wireless connections **17**
- ReadySHARE access **59, 63**
- ReadySHARE printing **70**
- recovering admin password **99**
- releasing connection status **94**
- remote management **124**
- renewing connection status **95**
- repeater units **110**
- reserved IP addresses **53**
- restarting network **139**
- restoring
 - configuration file **98**
 - default factory settings **146**
- router interface, described **25**
- Router mode **130**
- router status, viewing **91**

S

- scheduling keyword and service blocking **86**
- secondary DNS **30**

- security **32, 80**
- security options **35**
- security PIN **43**
- sending logs by email **87**
- Setup Wizard **40, 41**
- sharing files **60**
- sites, blocking **81**
- SMTP server **87**
- specifications, technical **149**
- splitters **18**
- SSID, described **34**
- static routes **121**
- status, router, viewing **91**
- subnet mask **92**
- system up time **93**

T

- technical specifications **149**
- technical support **2**
- Temporal Key Integrity Protocol (TKIP) **35**
- time of day **145**
- time to live, advertisement **127**
- time-out, port triggering **119**
- trademarks **2**
- traffic metering **128**
- troubleshooting **138**
- trusted host **81**
- two-line ADSL microfilter **18**

U

- Universal Plug and Play (UPnP) **126**
- up time, system **93**
- upgrading firmware **24, 90**
- USB
 - advanced configuration **64**
 - advanced settings **102**
 - basic storage settings **62**
 - drive requirements **59**
 - file sharing **60**
 - ReadySHARE access **59, 63**
 - remote computer connection **68**
 - specifying approved devices **67**
 - unmounting a USB drive **68**
- USB devices, approved **67**
- USB port LED **16**
- USB printer **70, 73**
- user-defined services **85**

W

- WAN IP address, troubleshooting [143](#)
- WAN setup [47](#)
- wireless channel [34](#)
- wireless connections, troubleshooting [145](#)
- wireless connectivity [17](#)
- wireless devices, adding to the network [26](#)
- wireless distribution system (WDS) [107](#), [108](#)
- Wireless LEDs
 - front panel [15](#), [17](#)
 - troubleshooting [141](#)
- wireless mode [34](#)
- wireless network name (SSID), broadcasting [34](#)
- wireless network settings [34](#)
- wireless radio [103](#)
- wireless repeating [107](#), [108](#), [109](#), [110](#)
- wireless security options [35](#)
- wireless settings [32](#), [93](#)
 - checking for correct [139](#)
 - SSID broadcast [34](#)
- WMM (Wi-Fi Multimedia) [54](#)
- WPA encryption [35](#)
- WPA2 encryption [35](#)
- WPA2-PSK encryption [35](#)
- WPA-PSK encryption [35](#)
- WPA-PSK/WPA2-PSK mixed mode [35](#)
- WPS (WiFi Protected Setup) [26](#), [42](#)
- WPS button [27](#)
- WPS LED [17](#)
- WPS-PSK encryption [35](#)
- WPS-PSK+ WPA2-PSK encryption [35](#)