



MOTOROLA
intelligence everywhere™

SBG1000 Wireless Cable Modem Gateway User Guide



SURFboard®
Cable Modem

Next page ►

WARNING: TO PREVENT FIRE OR SHOCK HAZARD, DO NOT EXPOSE THIS PRODUCT TO RAIN OR MOISTURE. THE UNIT MUST NOT BE EXPOSED TO DRIPPING OR SPLASHING. DO NOT PLACE OBJECTS FILLED WITH LIQUIDS, SUCH AS VASES, ON THE UNIT.

CAUTION: TO PREVENT ELECTRICAL SHOCK, THIS EQUIPMENT REQUIRES A GROUNDING CONDUCTOR IN THE LINE CORD. THE LINE CORD PROVIDED WITH THE EQUIPMENT IS ACCEPTABLE FOR USE WITH NEMA STYLE 5-15R AC RECEPTACLE SUPPLYING NOMINAL 120 VOLTS. DO NOT CONNECT THE PLUG INTO AN EXTENSION CORD, RECEPTACLE, OR OTHER OUTLET UNLESS THE PLUG CAN BE FULLY INSERTED WITH NO PART OF THE BLADES EXPOSED.

CAUTION: TO ENSURE REGULATORY AND SAFETY COMPLIANCE, USE ONLY THE PROVIDED POWER AND INTERFACE CABLES.

CAUTION: DO NOT OPEN THE UNIT. DO NOT PERFORM ANY SERVICING OTHER THAN THAT CONTAINED IN THE INSTALLATION AND TROUBLESHOOTING INSTRUCTIONS. REFER ALL SERVICING TO QUALIFIED SERVICE PERSONNEL.

CAUTION: CHANGES AND MODIFICATIONS NOT EXPRESSLY APPROVED BY MOTOROLA FOR COMPLIANCE COULD VOID USER'S AUTHORITY TO OPERATE THE EQUIPMENT.

This device complies with part 15 of the FCC Rules. Operation is subject to the following two conditions: (1) This device may not cause harmful interference, and (2) this device must accept any interference received, including interference that may cause undesired operation.

Note: This equipment has been tested and found to comply with the limits for a Class B digital device, pursuant to part 15 of the FCC Rules. These limits are designed to provide reasonable protection against harmful interference in a residential installation. This equipment generates, uses and can radiate radio frequency energy and, if not installed and used in accordance with the instructions, may cause harmful interference to radio communications. However, there is no guarantee that interference will not occur in a particular installation. If this equipment does cause harmful interference to radio or television reception, which can be determined by turning the equipment off and on, the user is encouraged to try to correct the interference by one or more of the following measures:

- Reorient or relocate the receiving antenna.
- Increase the separation between the equipment and receiver.
- Connect the equipment into an outlet on a circuit different from that to which the receiver is connected.
- Consult the dealer or an experienced radio/TV technician for help.

This device must be installed and used in strict accordance with the manufacturer's instructions as described in the user documentation that comes with the product.

Postpone cable modem installation until there is no risk of thunderstorm or lightning activity in the area.

Do not overload outlets or extension cords, as this can result in a risk of fire or electric shock. Overloaded AC outlets, extension cords, frayed power cords, damaged or cracked wire insulation, and broken plugs are dangerous. They may result in a shock or fire hazard.

Route power supply cords so that they are not likely to be walked on or pinched by items placed upon or against them. Pay particular attention to cords where they are attached to plugs and convenience receptacles, and examine the point where they exit from the product.

Place this equipment in a location that is close enough to an electrical outlet to accommodate the length of the power cord.

Place this equipment on a stable surface.

Be sure that the outside cable system is grounded, so as to provide some protection against voltage surges and built-up static charges. Article 820-20 of the NEC (Section 54, Part I of the Canadian Electrical Code) provides guidelines for proper grounding and, in particular, specifies the CATV cable ground shall be connected in the grounding system of the building, as close to the point of cable entry as practical.

When using this device, basic safety precautions should always be followed to reduce the risk of fire, electric shock and injury to persons, including the following:

- Read all of the instructions {listed here and/or in the user manual} before you operate this equipment. Give particular attention to all safety precautions. Retain the instructions for future reference.
- Comply with all warning and caution statements in the instructions. Observe all warning and caution symbols that are affixed to this equipment.
- Comply with all instructions that accompany this equipment.
- *Avoid using this product during an electrical storm.* There may be a risk of electric shock from lightning. For added protection for this product during a lightning storm, or when it is left unattended and unused for long periods of time, unplug it from the wall outlet, and disconnect the cable system. This will prevent damage to the product due to lightning and power surges.
- Avoid damaging the cable modem with static by touching the coaxial cable when it is attached to the earth grounded coaxial cable TV wall outlet.
- Always first touch the coaxial cable connector on the cable modem when disconnecting or re-connecting USB or Ethernet cable from the cable modem or the user's PC.
- Operate this product only from the type of power source indicated on the product's marking label. If you are not sure of the type of power supplied to your home, consult your dealer or local power company.
- Upon completion of any service or repairs to this products, ask the service technician to perform safety checks to determine that the product is in safe operating condition.

It is recommended that the customer install an AC surge protector in the AC outlet to which this device is connected. This is to avoid damaging the equipment by local lightning strikes and other electrical surges.

Different types of cord sets may be used for connections to the main supply circuit. Use only a main line cord that complies with all applicable product safety requirements of the country of use.

Installation of this product must be in accordance with national wiring codes.

Place unit to allow for easy access when disconnecting the power cord/adaptor of the device from the AC wall outlet.

Wipe the unit with a clean, dry cloth. Never use cleaning fluid or similar chemicals. Do not spray cleaners directly on the unit or use forced air to remove dust.

This product was qualified under test conditions that included the use of the supplied cables between system components. To be in compliance with regulations, the user must use these cables and install them properly. Connect the unit to a grounding type AC wall outlet (100-240 V AC) using the standard power cord/adaptor as supplied with the unit.

Do not cover the device, or block the airflow to the device with any other objects. Keep the device away from excessive heat and humidity and keep the device free from vibration and dust.

Installation must at all times conform to local regulations.

This product is provided with a separate *Regulatory, Safety, Software License, and Warranty Information* card. If one is not provided with this product, please ask your service provider or point-of-purchase representative, as the case may be.

- THIS PRODUCT IS IN COMPLIANCE WITH ONE OR MORE OF THE STANDARDS LISTED ON THE *REGULATORY, SAFETY, SOFTWARE LICENSE, AND WARRANTY INFORMATION* CARD. NOT ALL STANDARDS APPLY TO ALL MODELS.
- NO WARRANTIES OF ANY KIND ARE PROVIDED BY MOTOROLA WITH RESPECT TO THIS PRODUCT, EXCEPT AS STATED ON THE *REGULATORY, SAFETY, SOFTWARE LICENSE, AND WARRANTY INFORMATION* CARD. MOTOROLA'S WARRANTIES DO NOT APPLY TO PRODUCT THAT HAS BEEN REFURBISHED OR REISSUED BY YOUR SERVICE PROVIDER.

Copyright © 2002 by Motorola, Inc.

All rights reserved. No part of this publication may be reproduced in any form or by any means or used to make any derivative work (such as translation, transformation or adaptation) without written permission from Motorola, Inc.

Motorola reserves the right to revise this publication and to make changes in content from time to time without obligation on the part of Motorola to provide notification of such revision or change. Motorola provides this guide without warranty of any kind, either implied or expressed, including, but not limited to, the implied warranties of merchantability and fitness for a particular purpose. Motorola may make improvements or changes in the product(s) described in this manual at any time.

MOTOROLA and the Stylized M Logo are registered in the US Patent & Trademark Office. Microsoft and Windows are registered trademarks and Windows Me and Windows XP are trademarks of Microsoft Corporation. Microsoft Windows screen shots are used by permission of Microsoft Corporation. Macintosh and AppleTalk are registered trademarks of Apple Computer, Inc. Iomega is a registered trademark of Iomega Corporation. Linux is a registered trademark of Linus Torvalds. Acrobat Reader is a registered trademark of Adobe Systems, Inc. Netscape and Navigator are registered trademarks of Netscape Communications Corporation. UNIX is a registered trademark of the Open Group in the United States and other countries. All other product or service names are the property of their respective owners. © Motorola, Inc. 2002.

Contents

Overview	1	Firewall Pages in the SBG Setup Program	37
Powerful Features in a Single Unit	2	Firewall > POLICY — basic Page	38
Easy Setup	2	Firewall > POLICY — advanced Page	39
Sample LAN	3	Firewall > ALERT — basic Page	40
Optional Accessories	4	Firewall > ALERT — email Page	41
Front Panel	6	Firewall > LOGS Page	42
Rear Panel	8		
Label on the Bottom of the Unit	9	Configuring the Gateway	43
Wiring the SBG LAN	9	Gateway > STATUS Page	44
Wired Ethernet LAN	10	Gateway > WAN Page	45
USB Connection	12	Gateway > LAN — nat config Page	47
HPNA LAN	13	Gateway > LAN — dhcp server config Page	48
IEEE 802.11b Wireless LAN	14	Gateway > LAN — dhcp reservations Page	49
Security	15	Gateway > ALG — basic Page	50
Firewall	15	Gateway > ALG — advanced Page	50
DMZ	16	Gateway > LOG Page	51
Wireless Security	16		
Virtual Private Networks	16	Configuring TCP/IP	53
Print Server	17	Configuring TCP/IP in Windows 95, Windows 98, or	
Related Documentation	17	Windows Me	54
		Configuring TCP/IP in Windows 2000	56
Installation	19	Configuring TCP/IP in Windows XP	60
Before You Begin	19	Verifying the IP Address in Windows 95, Windows 98, or	
Precautions	20	Windows Me	64
Signing Up for Service	21	Verifying the IP Address in Windows 2000 or Windows XP	
Computer System Requirements	21	65	
Connecting the SBG1000 to the Cable System	22		
Cabling the Ethernet or HPNA LAN	23	Setting Up the Wireless LAN	67
Obtaining an IP address in Windows 98, Windows 98		Configuring a Unique Wireless Network Name	68
SE, or Windows Me	23	Configuring Basic Wireless LAN Security	69
Obtaining an IP address in Windows 2000 or		Configuring Wireless Clients	70
Windows XP	23	Wireless Pages in the SBG Setup Program	70
Obtaining an IP address on Macintosh or UNIX Systems		Wireless > STATUS Page	71
23		Wireless > NETWORK Page	72
Connecting a PC to the USB Port	24	Wireless > SECURITY — basic Page	73
Setting Up the Wireless LAN	24	Wireless > SECURITY — advanced Page	74
Connecting the Printer	24	Wireless > STATISTICS page	75
Wall Mounting the Wireless Gateway	25		
Wall Mounting Template	27	Configuring the Print Server	77
Installing the Optional External Diversity Antenna	28	Configuring the SBG1000 Print Server	77
		Printer > CONFIGURATION — Microsoft smb Page	78
Configuring the SBG1000	31	Printer > CONFIGURATION — Apple Page	79
Starting the SBG Setup Program	32	Printer > CONFIGURATION — lpr Page	80
Changing the Default Password	34	Adding a Printer in Windows 98 or Windows Me	80
Getting Help	35	Adding a Printer in Windows 2000	86
Setting the Firewall Policy	36		



Setting Up a USB Driver	95
Setting Up a USB Driver in Windows 98	96
Setting Up a USB Driver in Windows 2000	100
Setting Up a USB Driver in Windows Me	103
Setting Up a USB Driver in Windows XP	104
Removing the USB Driver from Windows 98 or Windows Me	105
Removing the USB Driver from Windows 2000	108
Removing the USB Driver from Windows XP	111
Troubleshooting	117
Front-Panel Lights and Error Conditions	117
Contact Us	119
Frequently-Asked Questions	121
Specifications	123
General Specifications	123
Cable Modem Specifications	124
Glossary	125
Software License	143

Overview

Thank you for purchasing the Motorola® SBG1000 Wireless Cable Modem Gateway. The SBG1000 combines a SURFboard™ cable modem, IEEE 802.11b wireless access point, router with five-port 10/100Base-T switch, print server, and an advanced firewall into one compact product. It is the perfect networking solution for the home, home office, or small business/enterprise. You can create a custom network to share a single broadband connection, files, printers, and other peripherals like scanners, with or without wires.

The SBG1000:

- Eliminates the need for five separate products, enabling you to maximize the potential of your existing resources
- Offers enhanced network security for wired and wireless users
- Enables operators to add future value-added services



The features and physical appearance of your SBG may differ slightly from the picture.

This product is subject to change. Not all features described in this *User Guide* are available on all SBG models. For the most recent documentation, visit the [Product Documentation](http://www.motorola.com/broadband) page on www.motorola.com/broadband.

Powerful Features in a Single Unit

The Motorola SBG1000 Wireless Cable Modem Gateway combines high-speed Internet access, networking, and computer security for a home or small-office local area network (LAN). It provides:

- An integrated high-speed SURFboard cable modem for continuous [broadband](#) access to the Internet and other online services, with much faster data transfer than traditional dial-up or ISDN modems.
- A [router](#) with a five-port 10/100Base-T [Ethernet switch](#), supporting:
 - Half- or full-[duplex](#) connections
 - Five dual-purpose switch/uplink ports
 - [Auto-MDIX](#)
- An [IEEE 802.11b Wi-Fi](#) certified wireless [access point](#) to enable laptop users to remain connected while moving around the home or small office or to connect desktop computers without installing network wiring. Depending on distance, wireless connection speeds can match that of Ethernet at 11 Mbps.
- An [HPNA](#) connection to connect computers to the LAN over existing telephone wiring — this provides the advantage of using your existing phone lines for network wiring with up to 10 Mbps throughput.
- A [USB](#) connection for a single PC.
- A single broadband connection for up to 245 computers to surf the web; all computers on the Ethernet, wireless, HPNA LAN, and USB communicate as if they were connected to the same physical network.
- A built-in [DHCP](#) server to easily configure a combined wired and/or wireless [class C private LAN](#).
- An advanced [firewall](#), supporting:
 - [stateful-inspection](#)
 - Intrusion detection
 - DMZ
 - Denial-of-service attack prevention
 - Network Address Translation (NAT)
- Virtual private network (VPN) [pass-through](#) operation supporting [IPSec](#), [PPTP](#), or [L2TP](#) to securely connect remote computers over the Internet.
- A print server to enable Windows[®], Macintosh[®], UNIX[®], and Linux[®] computers to share one or more printers.

Easy Setup

It is much easier to configure a [LAN](#) using the Motorola SBG1000 Wireless Cable Modem Gateway than it is using typical networking equipment:

- The Installation Assistant application on the *Motorola SBG1000 Wireless Cable Modem Gateway* CD-ROM enables easy connection to the cable network.
- For basic operation, most default settings require no modification.
- The Setup Program provides a graphical user interface ([GUI](#)) for easy configuration of necessary wireless, Ethernet, router, DHCP, and security settings. For a list of important issues, see “[Configuring the SBG1000](#)” on page 31.

Sample LAN

The sample LAN shown in the figure contains the following devices, all protected by the SBG1000 firewall:

- A printer connected to the print server through the parallel connection
- A PDA connected through the wireless IEEE 802.11b connection
- One desktop Macintosh on a wireless connection
- One desktop PC on a wireless connection using a Motorola USB Adapter
- A laptop PC on a wireless connection connected using a Motorola PC Card
- One computer connected directly to Ethernet port one
- Three computers connected to Ethernet port two using a hub or switch
- Two computers connected over telephone wiring through HPNA
- One PC connected to the USB port

Sample SBG1000 hybrid network

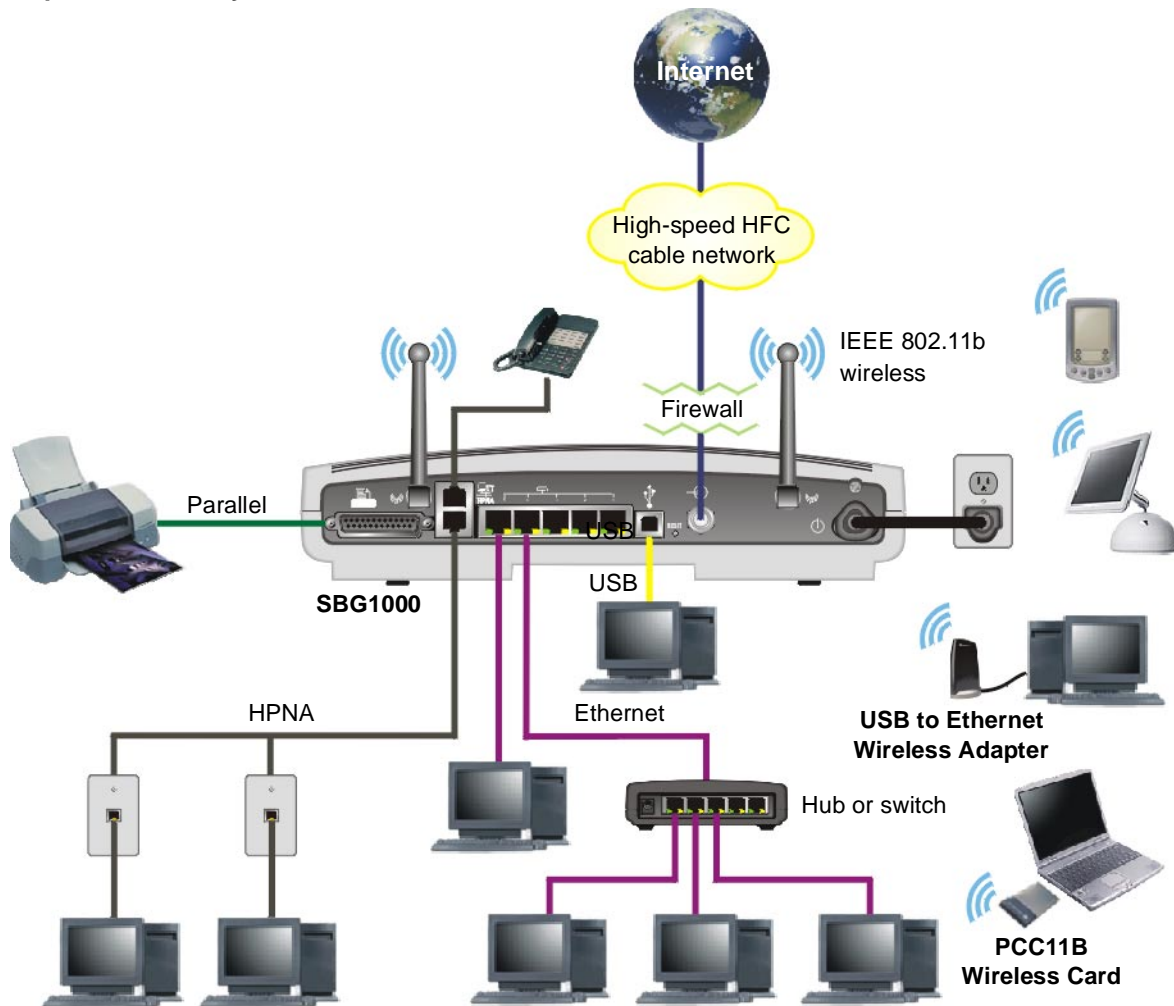

Optional Accessories

Accessories available for the Motorola SBG1000 Wireless Cable Modem Gateway include wireless adapters and an external high-gain diversity antenna.

You can use the Motorola PCC11b wireless card or the USB11b wireless adapter, which comply with the IEEE 802.11b wireless standard, to connect a PC to the wireless LAN:

USB11b Wireless Adapter

Connects a desktop, laptop, printer, or other peripheral device to the wireless LAN. It has a built-in antenna and a two meter (six feet) long cable that connects to the PC USB port. Its light indicates:

- Off — Not connected to a USB port or not receiving power from the PC
- Yellow — Not installed or initializing
- Green — Installed and operational
- Flashing Green — Receiving data from another wireless LAN device
- Flashing Yellow — Transmitting data to another wireless LAN device

PCC11Bb Wireless Card

A credit-card sized adapter that connects a laptop to the wireless LAN. You can roam in, or around, the home or small office and remain connected. It fits in a [PCMCIA](#) Type II standard slot on the laptop supporting 3.3 Volt PC card. The PCC11b has also has a built-in antenna.

Motorola USB11b Wireless Adapter (left) and PCC11b Wireless Card



For installation instructions, see the documentation provided with each product.

The Motorola External Diversity Antenna connects to the Motorola SBG1000 Wireless Cable Modem Gateway, providing higher gain to increase wireless LAN performance and coverage, even in obstructed locations. The External Diversity Antenna specifications are:

Frequency	2400 to 2500 MHz
Gain	5 dBi peak gain, nominal
Pattern Type	Directional, vertically polarized
Connection	Reverse-polarity TNC male, RG-142 cable

For information about connecting the external antenna, see ["Installing the Optional External Diversity Antenna"](#) on page 28.

Motorola External Diversity Antenna



Front Panel



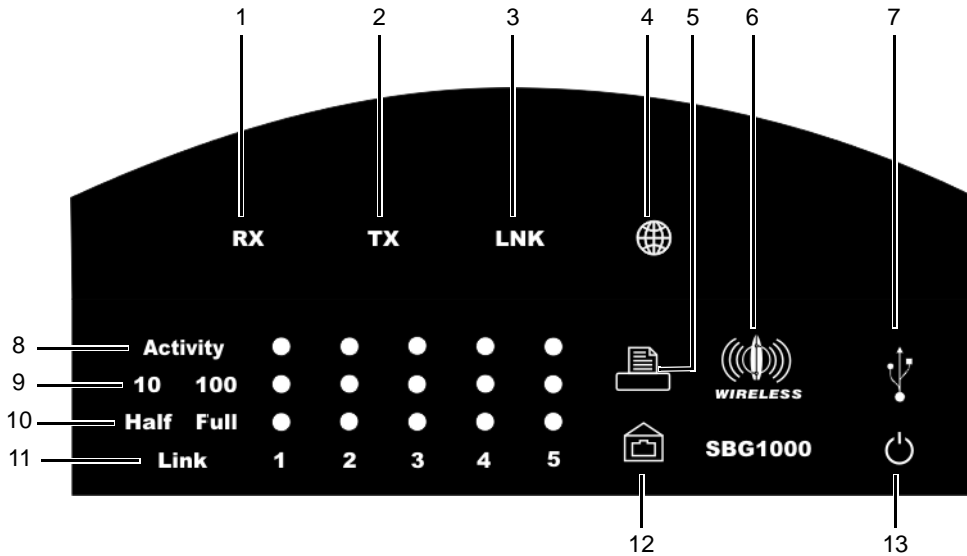

The front panel provides indicator lights. *The model number on your SBG may be different than in some illustrations and screen images.*



Front-panel top section lights

Key	Light	Flashing	On
1	RX (Receive)	Scanning for a receive (downstream) channel connection	The downstream channel is connected
2	TX (Transmit)	Scanning for a send (upstream) channel connection	The upstream channel is connected
3	LNK (Link)	Scanning for a network connection	The startup process is complete and the SBG is online
4		Transmitting or receiving data	There is no solid on state

Front-panel bottom section lights

Key	Light	Flashing	On
5		Data transfer to printer	Printer is connected
6	 WIRELESS	Wireless activity	Wireless feature is functioning normally
7		USB activity	There is a proper USB connection
8	Activity	Ethernet activity on the port	
9	10 100	none	Indicates the LAN connection speed: <ul style="list-style-type: none"> • Amber for a 10Base-T connection • Green for a 100Base-T connection
10	Half Full	none	Indicates the LAN port duplex mode <ul style="list-style-type: none"> • Amber for half duplex • Green for full duplex
11	Link 1 to 5	No flashing mode	There is a proper Ethernet connection to the port
12		Data transfer over phone line using HPNA	There is no solid on state
13	 Power	No flashing mode	The SBG1000 power supply is working properly

Rear Panel

The rear panel provides cabling connectors, status lights, and the power receptacle:

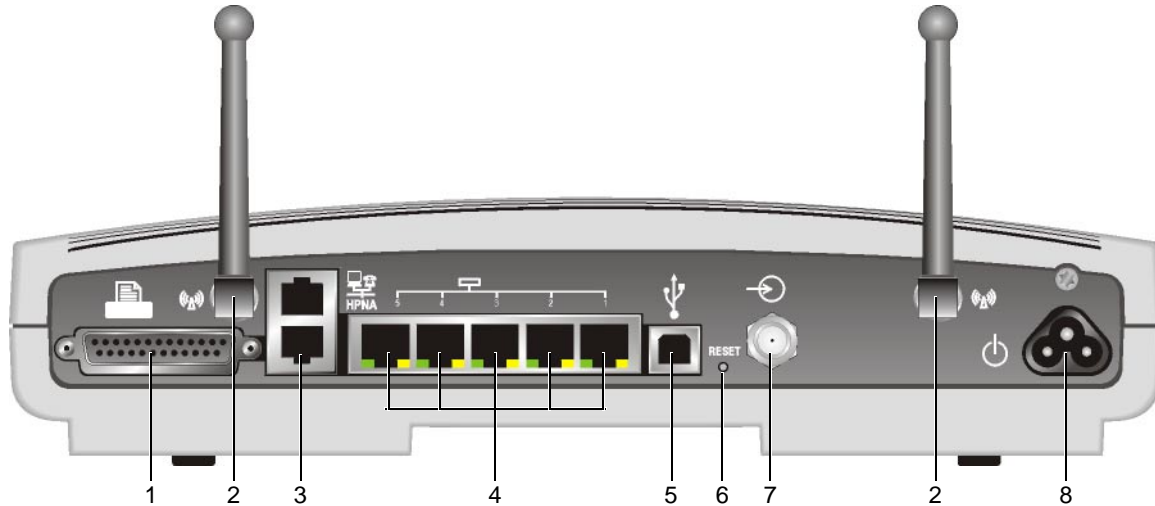

Key	Item	Description
-----	------	-------------

- | | | |
|---|--|--|
| 1 | | The printer port provides a connection for one printer. |
| 2 | | The Motorola SBG1000 Wireless Cable Modem Gateway includes two antennas. The optional Motorola External Diversity Antenna provides higher gain to increase wireless LAN performance and coverage. For information about the External Diversity Antenna, see "Optional Accessories" on page 4. |
| 3 | | Use the HPNA ports to connect an HPNA LAN: <ul style="list-style-type: none"> • Connect the bottom HPNA port to the telephone jack using the supplied telephone wire terminated with RJ-11 connectors. • You can connect a telephone to the top HPNA port. |
| 4 | | Use Ethernet ports 1 to 5 to connect an Ethernet LAN cable with RJ-45 connectors. You can connect Ethernet-equipped computers, hubs , bridges , or switches . The adjacent lights to each Ethernet port are:
LINK/ACT — On when the Ethernet connection is available. It blinks during data transfer.
100 — On if there is a 100Base-T link and off for a 10Base-T link. |
| 5 | | Use the USB port for Connecting a PC to the USB Port (see page 24). |
| 6 | | If you experience a problem, you can push this recessed button to restart the SBG1000 (see "Troubleshooting" on page 117). To reset all values to their defaults, hold down the button for more than five seconds. Resetting may take 5 to 30 minutes because the SBG1000 must find and lock on the appropriate communications channels. |
| 7 | | The cable port provides a connection to the coaxial cable outlet. |
| 8 | | The power connector provides power to the SBG1000. |

Label on the Bottom of the Unit

To receive data service, you need to provide the **MAC address** marked **HFC MAC ID** to your cable service provider:

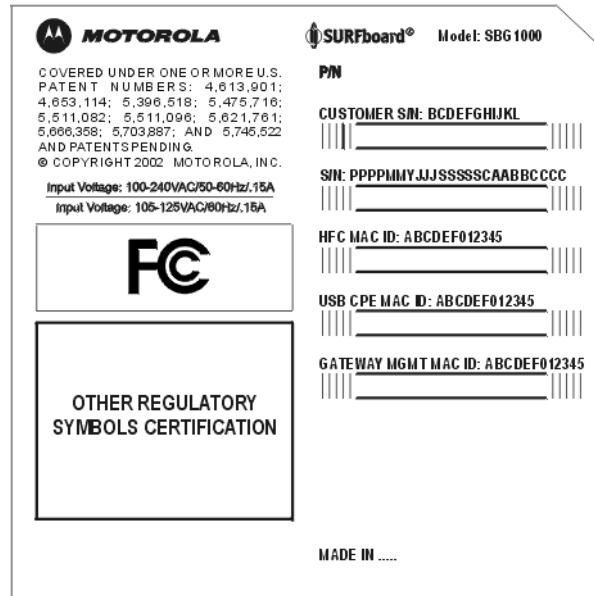

Wiring the SBG LAN

The Motorola SBG1000 Wireless Cable Modem Gateway enables connection of a **class C network** with up to 245 **client** computers and other IEEE 802.11b compliant devices on a combination of:

- 10/100Base-T **Ethernet**
- **IEEE 802.11b** wireless networking
- **HPNA V2.0**
- **USB V1.1**

Each computer needs appropriate network **adapter** hardware and **driver** software. The clients on the Ethernet, wireless, HPNA, or USB interfaces can share:

- Internet access with a single cable service provider account (subject to network operator terms and conditions)
- Files, printers, storage devices, multi-user software applications, games, and video conferencing

Wireless and wired network connections use Windows networking to share files and peripheral devices such as printers, CD-ROM drives, floppy disk drives, and Iomega® Zip Drives.

Wired Ethernet LAN

Each computer on the Ethernet LAN requires an Ethernet network interface card (NIC) and [driver](#) software installed.

Because the Motorola SBG1000 Wireless Cable Modem Gateway Ethernet ports support [auto-MDIX](#), you can use either [straight-through](#) or cross-over cable to connect a hub, switch, or computer. Use [category 5](#) cabling for all Ethernet connections.

The physical wiring arrangement has no connection to the logical network allocation of IP addresses.

Sample SBG Ethernet network connections

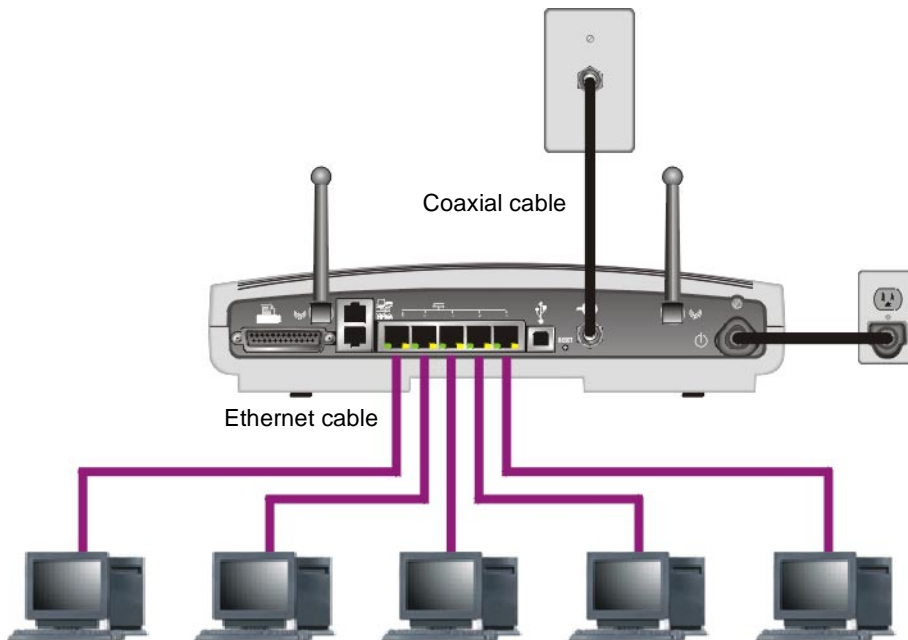

A wired Ethernet LAN with more than five computers requires one or more [hubs](#) or [switches](#). You can connect a hub or switch to any Ethernet port on the Motorola SBG1000 Wireless Cable Modem Gateway.

The following illustration is an example of an Ethernet LAN you can set up using the Motorola SBG1000 Wireless Cable Modem Gateway. You should cable the Ethernet LAN in an appropriate manner for the site. A complete discussion of Ethernet cabling is beyond the scope of this document.

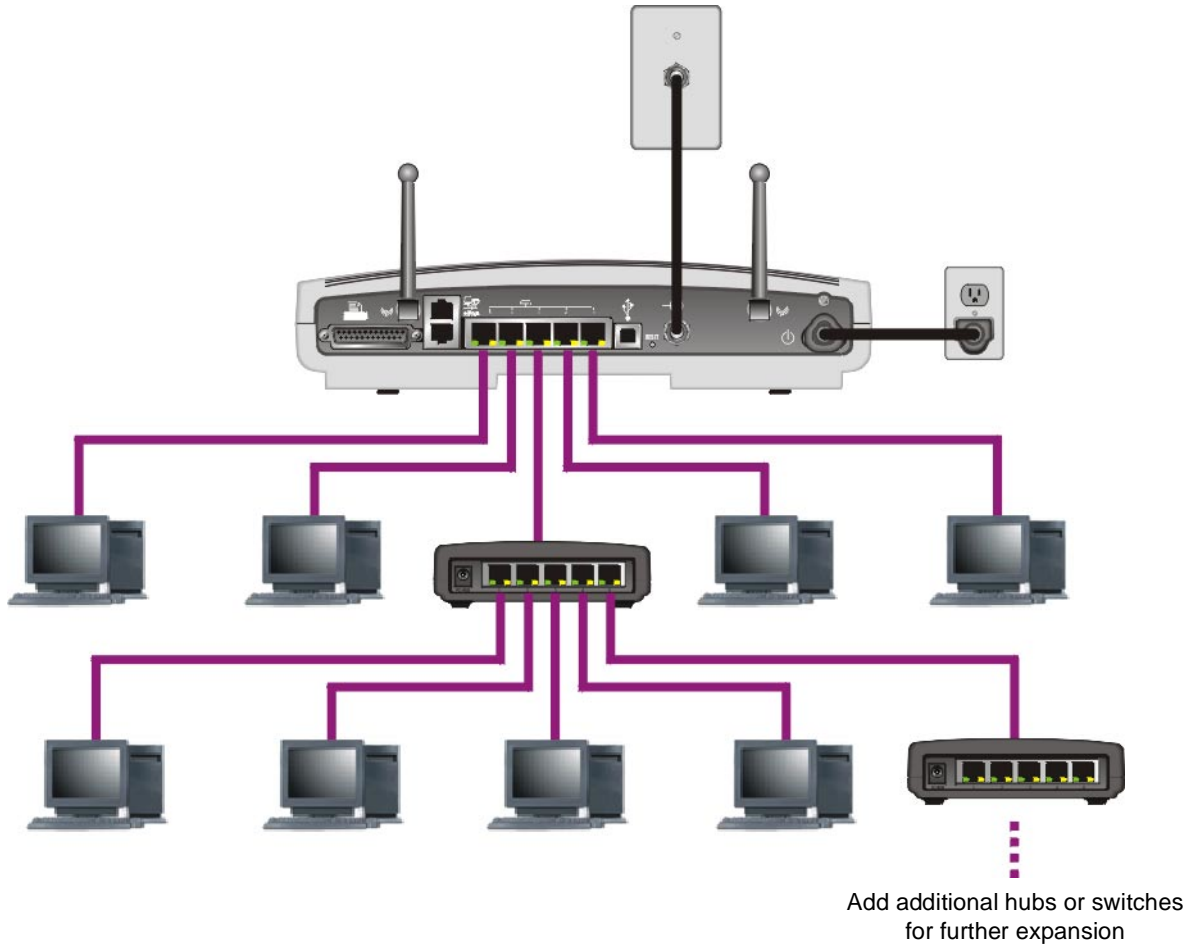

You can connect a hub or switch to any Ethernet port on the Motorola SBG1000 Wireless Cable Modem Gateway.

USB Connection

You can connect a single PC running Windows® 98, Windows XP™, Windows Me®, or Windows® 2000 to the Motorola SBG1000 Wireless Cable Modem Gateway USB port. For cabling instructions, see “[Connecting a PC to the USB Port](#)” on page 24.

Sample USB connection.

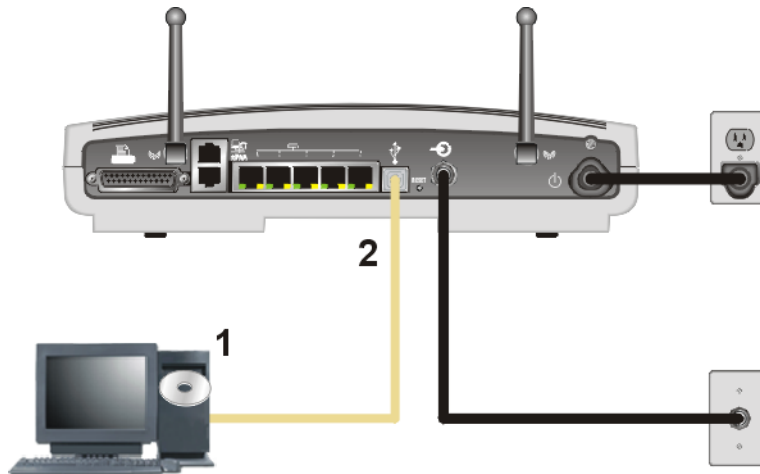

Caution!



Before plugging in the USB cable, be sure the Motorola SBG1000 Wireless Cable Modem Gateway CD-ROM is inserted in the PC CD-ROM drive.

HPNA LAN

To eliminate the need to install network wiring, the Motorola SBG1000 Wireless Cable Modem Gateway provides a Home Phoneline Network Alliance (HPNA or HomePNA) connection. HPNA networks use existing telephone lines to connect the computers without interfering with telephone voice service, DSL, ISDN, modems, or fax machines. HPNA networks can extend up to 300 meters (1000 feet).

Sample HPNA network connections

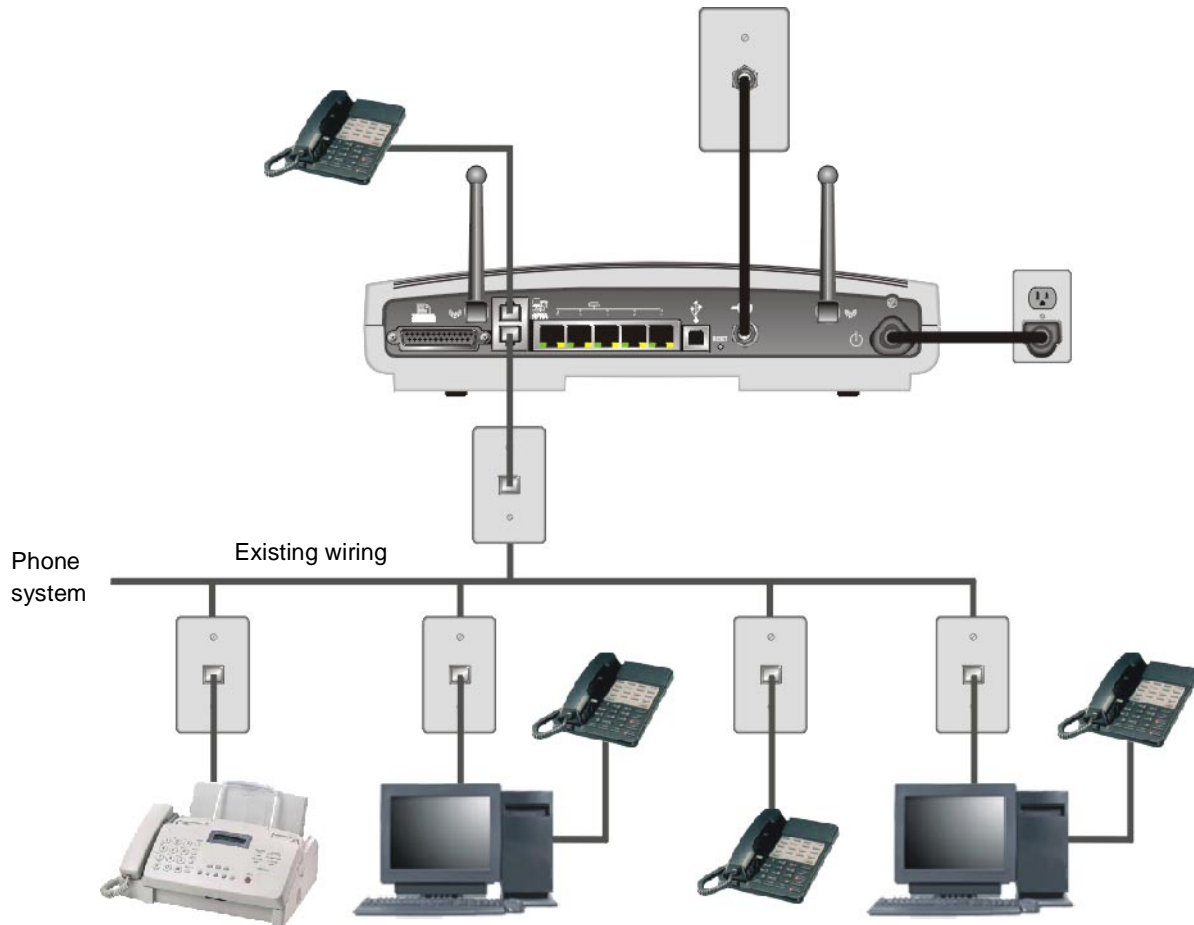

Each computer requires an HPNA adapter to connect to the HPNA network. HPNA adapters (sold elsewhere) are available for PCI or USB. After installing the HPNA adapter, you must install HPNA driver software on the computer following the instructions provided with the HPNA adapter.

HPNA 2.0 supports 10 Mbps data transfer similar to Ethernet 10Base-T.

If there is more than one telephone line, you must make all HPNA connections to the same line. You can connect a telephone to the top HPNA port on the SBG1000 (see "Front Panel" on page 6).

IEEE 802.11b Wireless LAN

Wireless communication occurs over radio waves rather than a wire. Like a cordless telephone, a wireless LAN uses radio signals instead of wires to exchange data. A wireless network eliminates the need for expensive and intrusive wiring to connect computers throughout the home or office. Mobile users can remain connected to the network even when carrying their laptop to different locations in the home or office.

Each computer on a wireless LAN requires an adapter described in [“Optional Accessories”](#) on page 4:

- For wireless laptops connections, use a Motorola PCC11b Wireless Card in the PCMCIA slot.
- For wireless desktop connections, use a Motorola USB11b Wireless Adapter to connect your PC USB port.

Sample wireless network connections



To set up the SBG, on a computer wired to the SBG over Ethernet or USB, perform the procedures in [“Setting Up the Wireless LAN”](#) on page 67.

To set up each wireless **client** (station):

- 1 Insert the *PCC11b and USB11b Wireless Adapter* CD-ROM in the CD-ROM drive on the client.
- 2 Install the device software from the CD.
- 3 Connect the Motorola PCC11b wireless card or USB11b wireless adapter following the instructions supplied with the card or adapter

Security

The Motorola SBG1000 Wireless Cable Modem Gateway provides:

- A [firewall](#) to protect the SBG LAN from undesired attacks over the Internet
- Security measures to prevent eavesdropping of wireless data

Network Address Translation ([NAT](#)) provides some security because the IP addresses of SBG LAN computers are not visible on the Internet.

The logical network diagram does not necessarily correspond to the network cabling. A full discussion of network security is beyond the scope of this document.

SBG1000 security measures shown in a logical network diagram

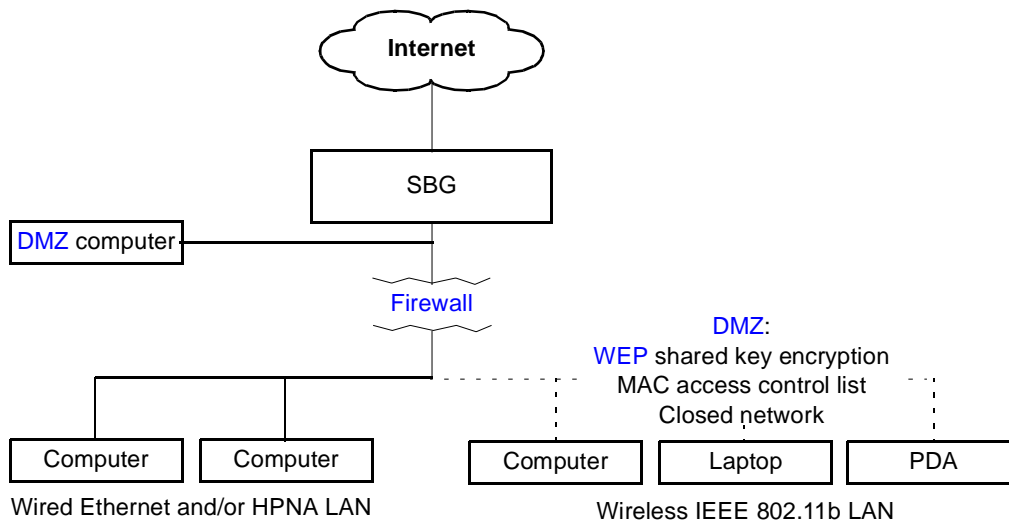

Firewall

The SBG1000 firewall protects the SBG LAN from undesired attacks and other intrusions from the Internet. It provides an advanced integrated [stateful-inspection](#) firewall supporting intrusion detection, session tracking, and denial-of-service attack prevention. The firewall:

- Maintains state data for every [TCP/IP](#) session on the [OSI](#) network and transport layers
- Monitors all incoming and outgoing [packets](#), applies the firewall [policy](#) to each one, and screens for improper packets and intrusion attempts
- Provides comprehensive logging for all:
 - User authentications
 - Rejected internal and external connection requests
 - Session creation and termination
 - Outside attacks (intrusion detection)

You can configure the firewall filters to set rules for port usage and to block specific IP domains and networks. For information about choosing a default firewall policy, see [“Setting the Firewall Policy”](#) on page 36.

DMZ

A de-militarized zone ([DMZ](#)) is one or more computers logically located outside the firewall between an SBG LAN and the Internet. A DMZ prevents direct access by outside users to private data. You can use a DMZ to set up a web [server](#) without exposing confidential data on your network. A DMZ is also useful for gamers that have a problem running a computer game's protocol through a firewall. DMZ provides the gamer a way to expose a single host directly to the Internet and thus overcome any firewall issues.

Wireless Security

To prevent unauthorized eavesdropping of data transmitted over the wireless LAN, you must enable wireless security. *The default Open authentication setting provides no security for transmitted data.*

You can [encrypt](#) data transmitted over the IEEE 802.11b wireless interface by configuring a [WEP](#) key on the Motorola SBG1000 Wireless Cable Modem Gateway and wireless LAN [clients](#) (stations).

You can also define a MAC access control list to restrict wireless LAN access to specified clients based on the client [MAC address](#).

If you enable closed network operation, the network name (ESSID) is not transmitted in the IEEE 802.11b beacon frame. This provides additional network protection because only IEEE 802.11b stations that are configured with your network name can associate with the SBG. Closed network operation is not part of the IEEE 802.11b standard

For information about configuring a WEP key, see "[Configuring Basic Wireless LAN Security](#)" on page 69.

Virtual Private Networks

The SBG1000 allows multiple [tunnel](#) VPN [pass-through](#) operation to securely connect remote computers over the Internet through the SBG1000. The SBG1000:

- Is compatible with Point to Point Tunneling Protocol ([PPTP](#)) and Layer 2 Tunneling Protocol ([L2TP](#))
- Is fully interoperable with any [IPSec](#) client or gateway and [ANX](#) certified IPSec stacks

Print Server

You can connect a printer to the Motorola SBG1000 Wireless Cable Modem Gateway back panel using a standard DB-25 connector. The print server:

- Enables Windows, UNIX, Linux, or Macintosh computers on the wired or wireless SBG LAN to share a printer
- Supports the [SMB](#), [LPR](#), AppleTalk® printing protocols

Printer connection

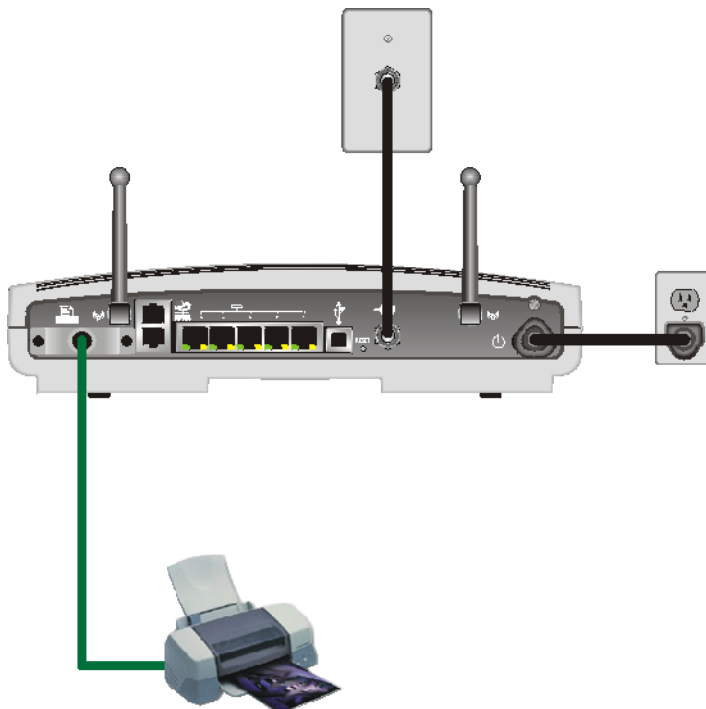

For information about configuring the print server, see [“Configuring the Print Server”](#) on page 77.

Related Documentation

The following documents also provide information you can use with the Motorola SBG1000 Wireless Cable Modem Gateway:

- *Motorola SBG1000 Wireless Cable Modem Gateway Quick Start Guide*
- *Motorola PCC11b Wireless Card Quick Start Guide and on-line help on the PCC11b and USB11b Wireless Adapter CD-ROM*
- *Motorola USB11b Wireless Adapter Quick Start Guide and on-line help on the PCC11b and USB11b Wireless Adapter CD-ROM*
- *Motorola Diversity Antenna Installation Instructions*

For the most recent documentation, visit the [Product Documentation](#) page on www.motorola.com/broadband.





Installation

To install the Motorola SBG1000 Wireless Cable Modem Gateway hardware:

- Determine the type of connections you will make to the SBG1000 — Ethernet, HPNA, wireless, USB, and/or printer
- Check that you have the proper cables, adapters, and adapter software to connect to your SBG1000:
 - For Ethernet, you'll need Ethernet cables and network interface cards (NICs) with accompanying installation software.
 - For HPNA, you'll need telephone jumper cables, HPNA interface cards, and the installation software.
 - For wireless connections, you'll need wireless adapters and the installation software for the adapters.
 - For USB, you'll need a USB cable and the *Motorola SBG1000 Wireless Cable Modem Gateway* CD-ROM which contains the software for USB installation.
 - For the printer, you'll need a printer cable.

Before You Begin

Before you begin the installation, check that you received the following items with the Motorola SBG1000 Wireless Cable Modem Gateway:

Item	Image	Description
Power cord		Connects the SBG1000 to the AC electrical outlet
10/100Base-T Ethernet cable		Connects to the Ethernet port
USB cable		Connects to the USB port
Phone wire jumper with RJ-11 connectors		Connects to a telephone line used for the HPNA network
Motorola SBG1000 Wireless Cable Modem Gateway CD-ROM		Contains this <i>User Guide</i> and USB drivers

You will need 75-ohm [coaxial cable](#) with F-type connectors to connect the SBG1000 to the nearest cable outlet. If a TV is connected to the cable outlet, you may need a 5-900 MHz RF [splitter](#) and two additional coaxial cables to use both the TV and the SBG1000.

You may need:

To Set Up

A wired Ethernet LAN with more than five computers

An HPNA LAN

An IEEE 802.11b wireless LAN

You Will Need

One or more Ethernet [hubs](#) or [switches](#)

An HPNA [adapter](#) and [driver](#) software for each computer connected using HPNA

An IEEE 802.11b adapter and driver software for each computer having a wireless connection (see "[Optional Accessories](#)" on page 4)

If you are installing the optional Motorola External Diversity Antenna, you may need a pair of needle nose pliers. Coaxial cable, RF splitters, hubs, and switches are available at consumer electronic stores.

Precautions

Postpone SBG1000 installation until there is no risk of thunderstorm or lightning activity in the area.

To avoid damaging the SBG1000 with static electricity:

- Always first connect the coaxial cable to the grounded cable TV wall outlet.
- Before you connect or disconnect the USB or Ethernet cable from the SBG1000 or PC, always touch the coaxial cable connector on the SBG1000 to release any static charges.

To avoid damaging the SBG1000 or computers with static electricity:

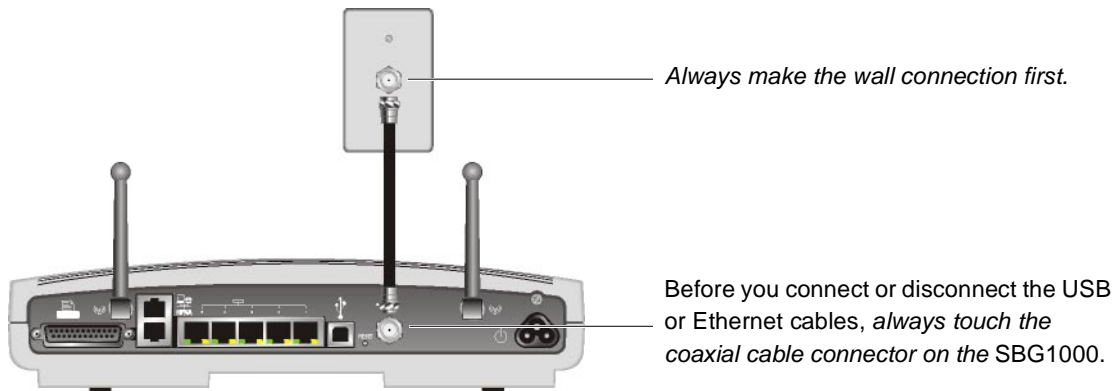

To avoid potential shock, always unplug the power cord from the wall outlet or other power source before disconnecting it from the SBG1000 rear panel.

To prevent overheating the SBG1000, do not block the ventilation holes on the bottom of the unit.

Do not open the unit. Refer all service to your cable service provider.

Wipe the unit with a clean, dry cloth. Never use cleaning fluid or similar chemicals. Do not spray cleaners directly on the unit or use forced air to remove dust.

Signing Up for Service

You must sign up with a cable service provider to access the Internet and other online services.

To activate your service, call your local cable service provider.

You need to provide the **MAC address** printed on the bar code label marked **HFC MAC ID** on the Motorola SBG1000 Wireless Cable Modem Gateway rear panel. You can record it here:

00 : _____ : _____ : _____ : _____ : _____

You should ask your cable service provider the following questions:

- Do you have any special system requirements?
- When can I begin to use my SBG1000?
- Are there any files I need to download after I am connected?
- Do I need a user name or password to access the Internet or use e-mail?

Computer System Requirements

You can connect Microsoft Windows, Macintosh, UNIX, or Linux computers equipped as follows to the SBG LAN:

- One of the following:

Ethernet 10Base-T or 10/100Base-T Ethernet adapter with proper NIC driver software installed

IEEE 802.11b Any IEEE 802.11b device

For information about the Motorola PCC11b Wireless Card (PCMCIA type II 3.3 V slot) or USB11b Wireless Adapter, see "Optional Accessories" on page 4.

HPNA HPNA phone line adapter installed with proper HPNA driver software installed

- PC with Pentium class or better processor
- Windows 98, Windows 98 SE, Windows Me, Windows 2000, Windows XP, Windows NT, Macintosh, or Linux operating system with operating system CD-ROM available
- Minimum 16 MB RAM recommended
- 10 MB available hard disk space

You can use any web browser such as Microsoft® Internet Explorer or Netscape Navigator® with the Motorola SBG1000 Wireless Cable Modem Gateway.

You can use the USB connection with any PC running Windows 98, Windows 2000, Windows Me, or Windows XP that has a USB interface. The USB connection requires special USB driver software that is supplied on the Motorola SBG1000 Wireless Cable Modem Gateway CD-ROM. You can upgrade the USB drivers from the Internet. For information, check our website <http://www.motorola.com/broadband>.

Connecting the SBG1000 to the Cable System

Allow 5 to 30 minutes the first time you turn on the SBG1000 to find and lock on the appropriate communications channels.

- 1 Be sure the computer is on and the SBG1000 is unplugged.
- 2 Connect one end of the coaxial cable to the cable outlet or splitter.
- 3 Connect the other end of the coaxial cable to the cable connector on the SBG1000.
Hand-tighten the connectors to avoid damaging them.
- 4 If you are using the optional Motorola External Diversity Antenna, install it now. Follow the instructions in [“Installing the Optional External Diversity Antenna”](#) on page 28.
- 5 Insert the *Motorola SBG1000 Wireless Cable Modem Gateway* CD-ROM into the CD-ROM drive.
- 6 Plug the power cord into the power connector on the SBG1000.
- 7 Plug the power cord into the electrical outlet. *This turns the Motorola SBG1000 Wireless Cable Modem Gateway on. You do not need to unplug it when not in use.*
- 8 Check that the lights on the [Front Panel](#) cycle through this sequence:
 - Power icon turns on when AC power is connected to the SBG1000 and indicates that the power supply is working properly.
 - RX (receive) light flashes while scanning for the receive channel and changes to solid green when the receive channel is locked.
 - TX (transmit) light flashes while scanning for the send channel and changes to solid green when the send channel is locked.
 - LNK (link) light flashes during SBG1000 registration and configuration and changes to solid green when the cable modem wireless gateway is registered.
 - Globe icon flashes when the SBG1000 is transmitting or receiving data.

Connecting the SBG1000 to the cable system

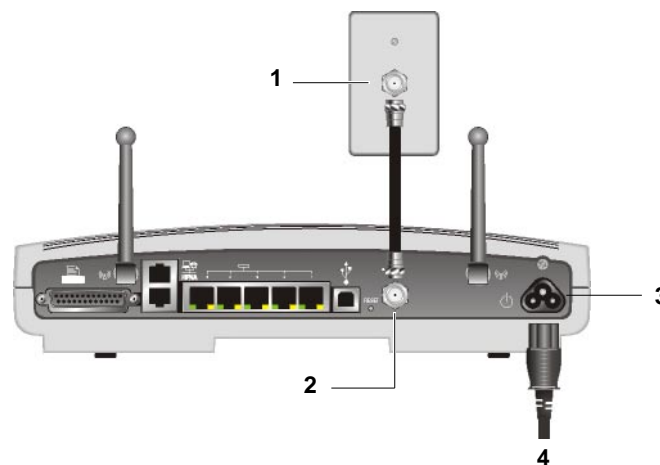

Cabling the Ethernet or HPNA LAN

After connecting to the cable system, you can connect your wired Ethernet and/or HPNA LAN. Some samples are shown in “Wired Ethernet LAN” on page 10 and “HPNA LAN” on page 13. Detailed information about network cabling is beyond the scope of this document. You must install proper drivers for the Ethernet NIC or HPNA adapter.

Obtaining an IP address in Windows 98, Windows 98 SE, or Windows Me

You must do the following on each Ethernet client PC running Windows 98, Windows 98 SE, or Windows Me:

- 1 On the Windows Desktop, click **Start**.
- 2 Select **Run**. The Run window is displayed.
- 3 Type **winipcfg.exe** and click **OK**. The IP Configuration window is displayed:

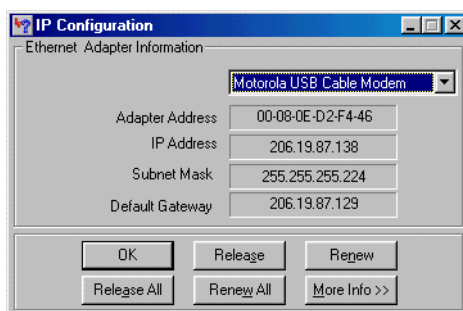

- 4 Click the **Renew** button to obtain an IP address for the PC from the DHCP server on the SBG1000.

Obtaining an IP address in Windows 2000 or Windows XP

You must do the following on each Ethernet client PC running Windows 2000 or Windows XP:

- 1 On the Windows Desktop, click **Start**.
- 2 Select **Run**. The Run window is displayed.
- 3 Type **cmd** and click **OK** to display a command prompt window.
- 4 Type **ipconfig /renew** and press ENTER to obtain an IP address for the PC from the DHCP server on the SBG1000.
- 5 Type **exit** and press ENTER to return to Windows.

Obtaining an IP address on Macintosh or UNIX Systems

Follow the instructions in your user manual.

Connecting a PC to the USB Port

You can connect a single PC running Windows 98, Windows XP, Windows Me, or Windows 2000 to the Motorola SBG1000 Wireless Cable Modem Gateway [USB](#) port.

Caution!



Before plugging in the USB cable, be sure the Motorola SBG1000 Wireless Cable Modem Gateway CD-ROM is inserted in the PC CD-ROM drive.

To connect a PC to the USB port:

- 1 Connect the USB cable to the USB port on the SBG1000.
- 2 Connect the other end to the USB port on the computer.
- 3 Install the USB driver following the appropriate procedure for ["Setting Up a USB Driver"](#) on page 95.

Setting Up the Wireless LAN

For information about wireless LAN setup, see ["Setting Up the Wireless LAN"](#) on page 67.

Connecting the Printer

Connect the printer to the Motorola SBG1000 Wireless Cable Modem Gateway printer port. If a cable was supplied with the printer, use that cable. Consult your printer documentation to determine cabling requirements from the SBG1000 to the printer.

After connecting the printer, power it on and follow the instructions for ["Configuring the Print Server"](#) on page 77.

Wall Mounting the Wireless Gateway

If you mount the SBG1000 on the wall, you must:

- Locate the unit as specified by the local or national codes governing residential or business cable TV and communications services.
- Follow all local standards for installing a network interface unit/network interface device (NIU/NID).

If possible, mount the SBG1000 to concrete, masonry, a wooden stud, or other very solid wall material. Use anchors if necessary; for example if you must mount the unit on drywall.

To mount your SBG1000 on the wall:

- 1 Print the [Wall Mounting Template](#) on page 27:

Click the Print icon or choose Print from the File menu to display the Print dialog box. (The following image is from Adobe Acrobat Reader[®] running on Windows 2000; there may be slight differences in your version.)

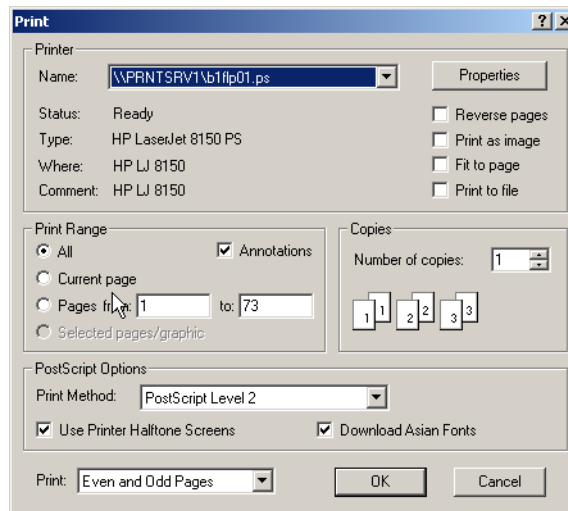

Be sure you print the template at 100% scale. Be sure Fit to page is not checked in the Print dialog box.

Click the OK button to print the template.

- 2 Measure the printed template with a ruler to ensure that it is the correct size.
- 3 Use a center punch to mark the center of the holes.
- 4 On the wall, locate the marks for the mounting holes.

Caution!



Before drilling holes, check the structure for potential damage to water, gas, or electric lines.

- 5 Drill the holes to a depth of at least 3.8 cm (1½ inches).
- 6 If necessary, seat an anchor in each hole.

Use M5 x 38 mm (#10-16 x 1¹/₂ inch) screws with a flat underside and maximum screw head diameter of 10.5 mm to mount the SBG1000.

7 Using a screwdriver, turn each screw until part of it protrudes from the wall, as shown:

- There must be 4.0 mm (.16 inches) between the wall and the underside of the screw head.
- The maximum distance from the wall to the top of the screw head is 7.6 mm (.3 in).

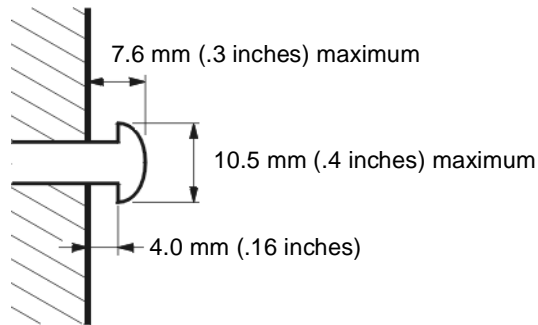

8 Place the SBG1000 so the keyholes are above the mounting screws.

9 Slide the SBG1000 down so it stops against the top of the keyhole opening.

Wall Mounting Template

You can print this page to use as a wall mounting template.

Be sure you print it at 100% scale. In Acrobat Reader, be sure that Fit To Page is not checked in the Print dialog box.

Measure the printed template with a ruler to ensure that it is the correct size.

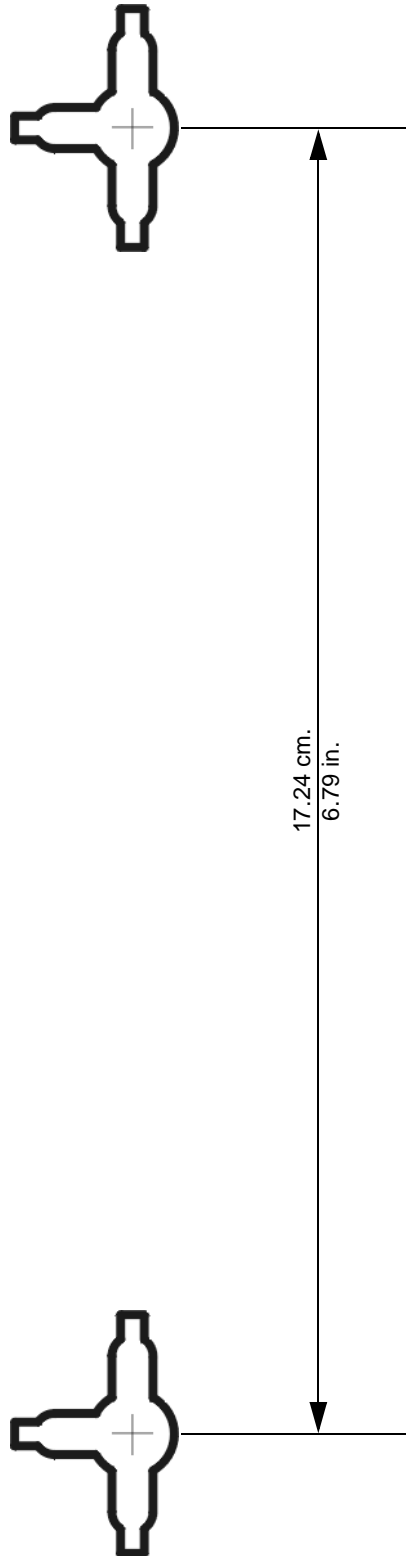

Installing the Optional External Diversity Antenna

The optional Motorola External Diversity Antennas are designed to provide an indoor operating range with WEP enabled of at least:

Distance	Data Transfer Rate
30 meters (100 feet)	11 Mbps
50 meters (165 feet)	5.5 Mbps
75 meters (230 feet)	2 Mbps
95 meters (300 feet)	1 Mbps

The maximum wireless operation distance depends on the type of materials through which the signal must pass and the location of the [diversity antennas](#) and [clients](#) (stations). *Motorola cannot guarantee wireless operation for all supported distances in all environments.*

To install the optional Motorola External Diversity Antenna:

- 1 Be sure the SBG1000 is unplugged. As with all electronic equipment, avoid potential shock by always unplugging the power cord from the wall outlet or other power source before disconnecting it from the SBG1000 rear panel.
- 2 Remove the antennas on the SBG1000 by unscrewing the connectors. You may need a pair of needle nose pliers to loosen them.

Store the antennas supplied on the SBG1000 in a safe place.

Disconnecting the antennas provided with the SBG1000



- 3 Connect the cables from the Motorola External Diversity Antenna to the connectors on the Motorola SBG1000 Wireless Cable Modem Gateway [Front Panel](#). *Hand-tighten the connectors to avoid damaging them. Using excessive force may damage the connectors.*

Connecting the Optional External Diversity Antenna to the SBG1000



- 4 Position or mount the External Diversity Antenna in a suitable location away from the computer and monitor. *Follow the instructions provided with the External Diversity Antenna. Do not twist the antenna cables.*

To obtain optimum results, try moving the External Diversity Antennas to slightly different locations.

❖ Configuring the SBG1000

Configuring the SBG1000 includes:

- [Starting the SBG Setup Program](#) (see page 32)
- [Changing the Default Password](#) (see page 34)
- [Getting Help](#) (see page 35)
- [Setting the Firewall Policy](#) (see page 36)

For more information about configuration, see [“Configuring TCP/IP”](#) on page 53, [“Setting Up the Wireless LAN”](#) on page 67, [“Configuring the Print Server”](#) on page 77, or [“Setting Up a USB Driver”](#) on page 95.

For normal operation, you do not need to change most default settings. The following caution statements summarize the issues you must be aware of:

Caution!



To prevent unauthorized configuration, change the default password *immediately* when you first configure the Motorola SBG1000 Wireless Cable Modem Gateway. See [“Changing the Default Password”](#) on page 34

[Firewalls](#) are not foolproof. Choose the most secure firewall [policy](#) you can. See [“Setting the Firewall Policy”](#) on page 36.

For a wireless LAN only, be sure you follow the instructions in [“Setting Up the Wireless LAN”](#) on page 67.

Starting the SBG Setup Program

- 1 On a computer on the LAN, open a web browser.
- 2 In the Address or Location field, type **192.168.100.1** and press ENTER to display the Login window:

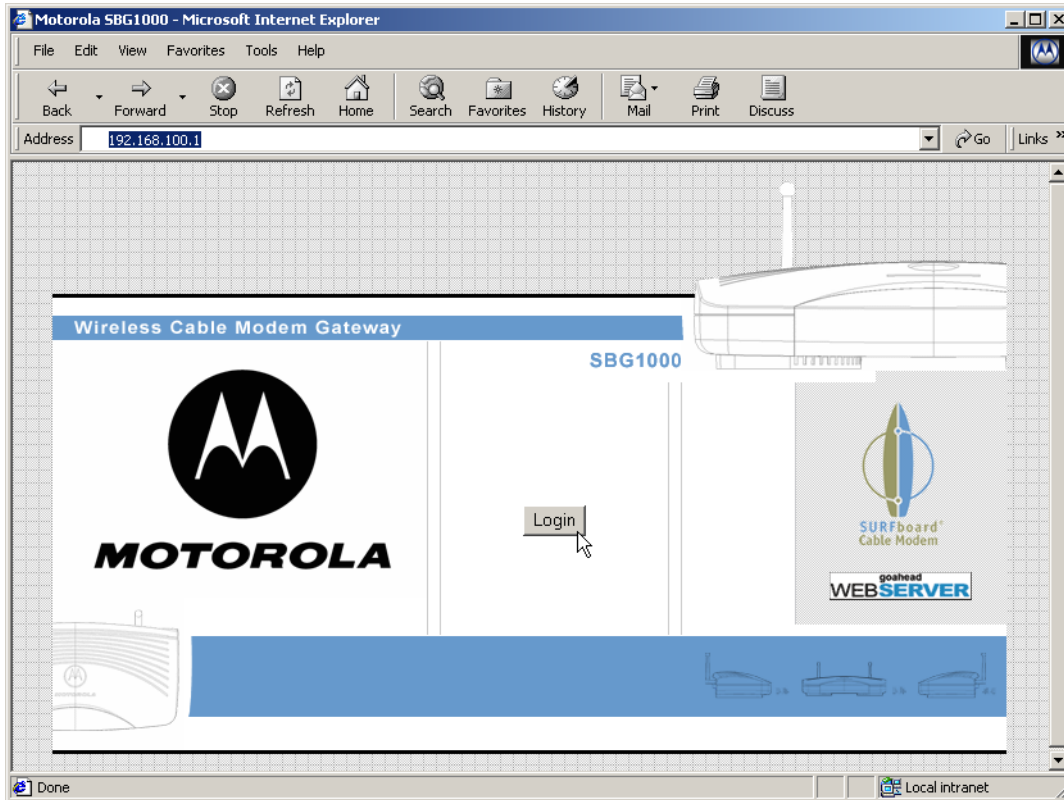

- 3 Click **Login** to display the Enter Network Password window:



- 4 In the User Name field, type the *User Name* (the default is "admin").
- 5 In the Password field, type the *Password* (the default is "motorola").

6 Click **OK** to display the SBG Setup Program:

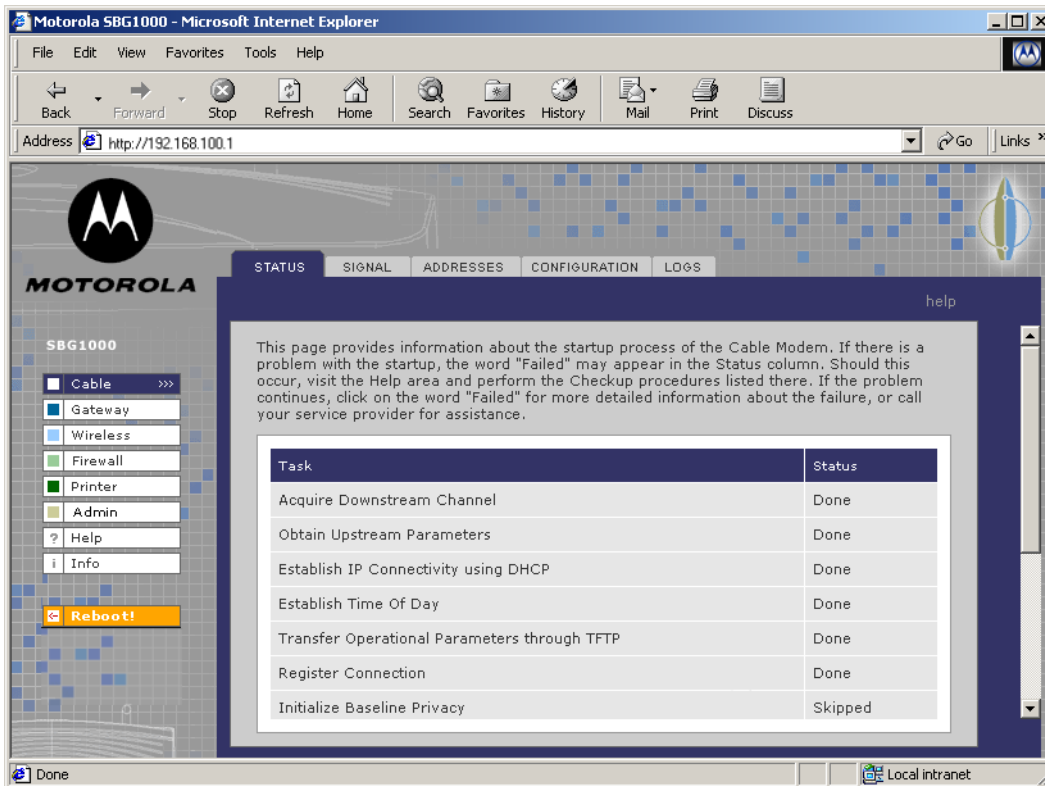

Click To Perform

- Cable** Configure and monitor the cable system connection
- Gateway** Configure and monitor the gateway preferences (see [“Configuring the Gateway”](#) on page 43)
- Wireless** Configure and monitor the wireless interface (see [“Setting Up the Wireless LAN”](#) on page 67)
- Firewall** Configure and monitor the firewall (see [“Setting the Firewall Policy”](#) on page 36)
- Printer** Configure the SBG1000 print server (see [“Configuring the Print Server”](#) on page 77)
- Admin** [Changing the Default Password](#) (see page 34)
- Help** Display information about the SBG1000 (see [“Getting Help”](#) on page 35)
- Info** Display information about the SBG Setup Program
- Reboot** Restart the SBG1000. It is the same as pressing the reset button on the [Rear Panel](#) for less than five seconds.

*For some settings, after you edit the field and click Apply, you are warned that you must **Reboot** for your change to take effect. Rebooting takes 10 to 15 seconds. After rebooting, you must log-in again.*

Changing the Default Password

Caution!



To prevent unauthorized configuration, change the default password *immediately* when you first configure the Motorola SBG1000 Wireless Cable Modem Gateway.

To change the default password:

- 1 On the SBG Setup Program screen, click **Admin** to display the ADMIN — basic page:

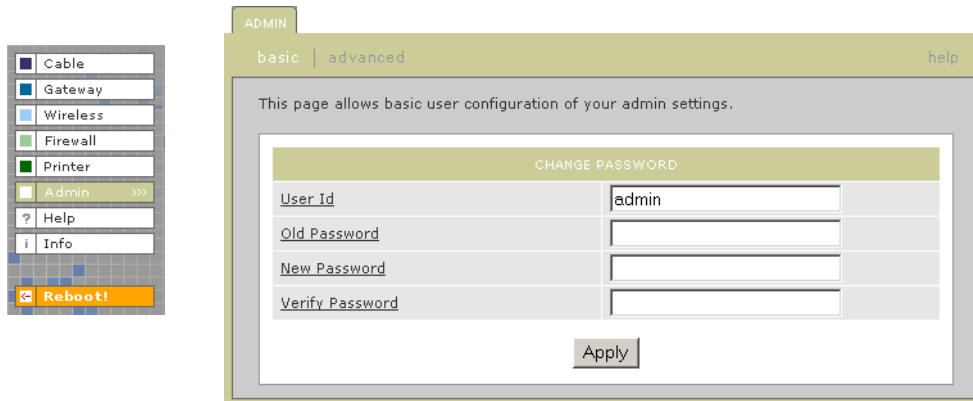

- 2 Type the old *password* in the **Old Password** field. (The default password is “motorola.”)
- 3 Type the new *password* in the **New Password** field.
- 4 Type the new *password* again in the **Verify Password** field.
- 5 Click **Apply** to apply your changes.

Getting Help

To get help on any underlined item, field, click the text. For example, if you click a field or the help button on the ADMIN — basic page, the following help is displayed:

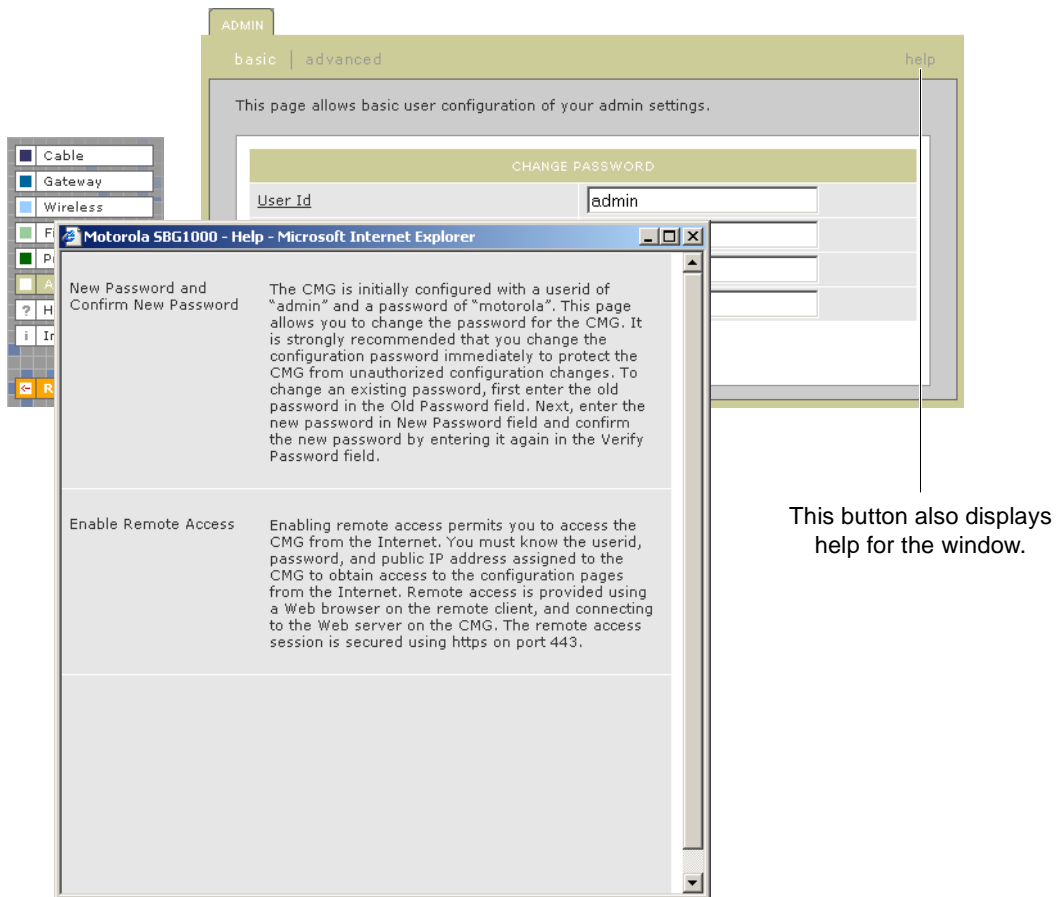

You can scroll to browse the help, or click another item to display help for that item.

Setting the Firewall Policy

Caution!



Firewalls are not foolproof. Choose the most secure firewall policy you can. To enable easy network setup, the default firewall policy is Low, which provides minimum security.

To select a predefined policy for all packets processed by the firewall:

- 1 On the SBG Setup Program left panel, click **Firewall**.
- 2 Click **POLICY**.
- 3 Click **basic** to display the options for firewall policy:

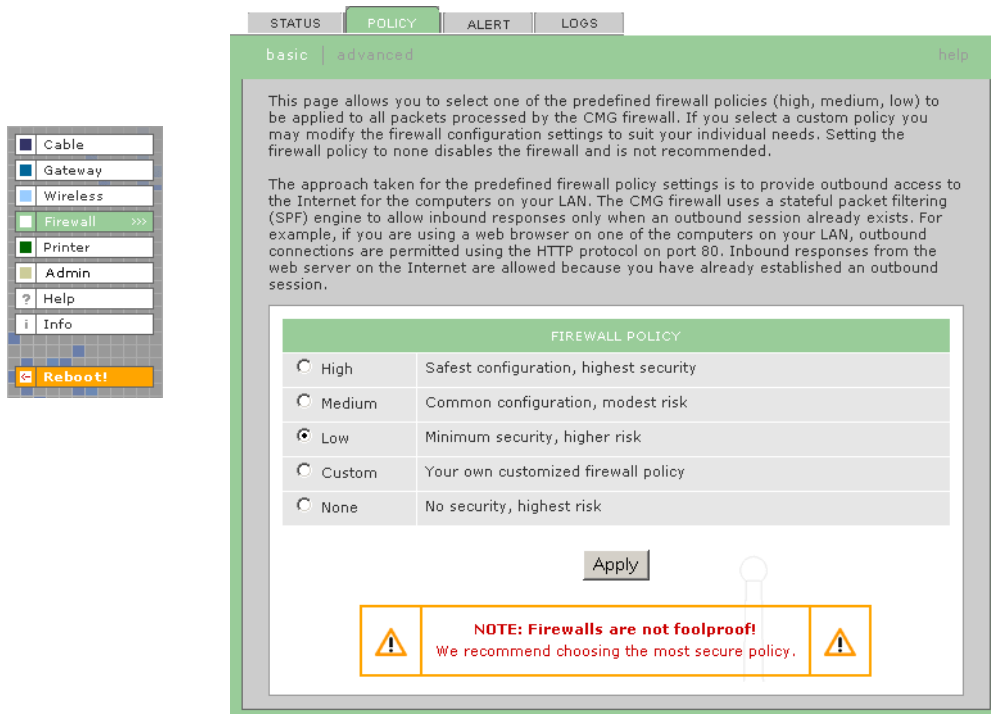

The screenshot shows the 'FIREWALL POLICY' configuration page. It includes a table with the following options:

FIREWALL POLICY	
<input type="radio"/> High	Safest configuration, highest security
<input type="radio"/> Medium	Common configuration, modest risk
<input checked="" type="radio"/> Low	Minimum security, higher risk
<input type="radio"/> Custom	Your own customized firewall policy
<input type="radio"/> None	No security, highest risk

Below the table is an **Apply** button and a red warning box with the text: **NOTE: Firewalls are not foolproof!** We recommend choosing the most secure policy.

- 4 Select one of the following. *Unless you have the necessary expertise and need to setup a custom firewall, use High, Medium, or Low.*

High Safest configuration, highest security. *We recommend this setting.*

Medium Common configuration, modest risk

Low Minimum security, higher risk

Custom You can create a custom firewall policy on the [Firewall > POLICY — advanced Page](#) (see page 39). *Do not create a custom policy unless you have the necessary expertise and the need to do so.*

None This setting disables the firewall and provides no security. *We do not recommend this setting.*

- 5 Click **Apply** to apply your changes.

Firewall Pages in the SBG Setup Program

Use the following pages to configure the firewall:

- [Firewall > POLICY — basic Page](#) (see page 38)
- [Firewall > POLICY — advanced Page](#) (see page 39)
- [Firewall > ALERT — basic Page](#) (see page 40)
- [Firewall > ALERT — email Page](#) (see page 41)
- [Firewall > LOGS Page](#) (see page 42)

*For some settings, after you edit the field and click Apply, you are warned that you must **Reboot** for your change to take effect. Rebooting takes 10 to 15 seconds. After rebooting, you must log-in again.*

Firewall > POLICY — basic Page

Use this page to select a predefined firewall policy for all packets processed by the SBG firewall, as described in “Setting the Firewall Policy” on page 36. Advanced users *only* can create a custom policy on the [Firewall > POLICY — advanced Page](#) (see page 39). The FIREWALL POLICY setting None disables the firewall and provides no security. *We do not recommend this setting.*

The predefined policies provide outbound Internet access for computers on the SBG LAN.

The SBG firewall uses [stateful inspection](#) to allow inbound responses when there already is an outbound session running corresponding to the data flow. For example, if you use a web browser, outbound HTTP connections are permitted on port 80. Inbound responses from the Internet are allowed because an outbound session is established. When required, the SBG firewall can be configured to allow inbound packets without first establishing an outbound session.

STATUS POLICY ALERT LOGS

basic | advanced help

This page allows you to select one of the predefined firewall policies (high, medium, low) to be applied to all packets processed by the CMG firewall. If you select a custom policy you may modify the firewall configuration settings to suit your individual needs. Setting the firewall policy to none disables the firewall and is not recommended.

The approach taken for the predefined firewall policy settings is to provide outbound access to the Internet for the computers on your LAN. The CMG firewall uses a stateful packet filtering (SPF) engine to allow inbound responses only when an outbound session already exists. For example, if you are using a web browser on one of the computers on your LAN, outbound connections are permitted using the HTTP protocol on port 80. Inbound responses from the web server on the Internet are allowed because you have already established an outbound session.

FIREWALL POLICY	
<input type="radio"/> High	Safest configuration, highest security
<input type="radio"/> Medium	Common configuration, modest risk
<input checked="" type="radio"/> Low	Minimum security, higher risk
<input type="radio"/> Custom	Your own customized firewall policy
<input type="radio"/> None	No security, highest risk

Apply

NOTE: Firewalls are not foolproof!
We recommend choosing the most secure policy.

Firewall > POLICY — advanced Page

Use this page to construct a custom firewall policy.

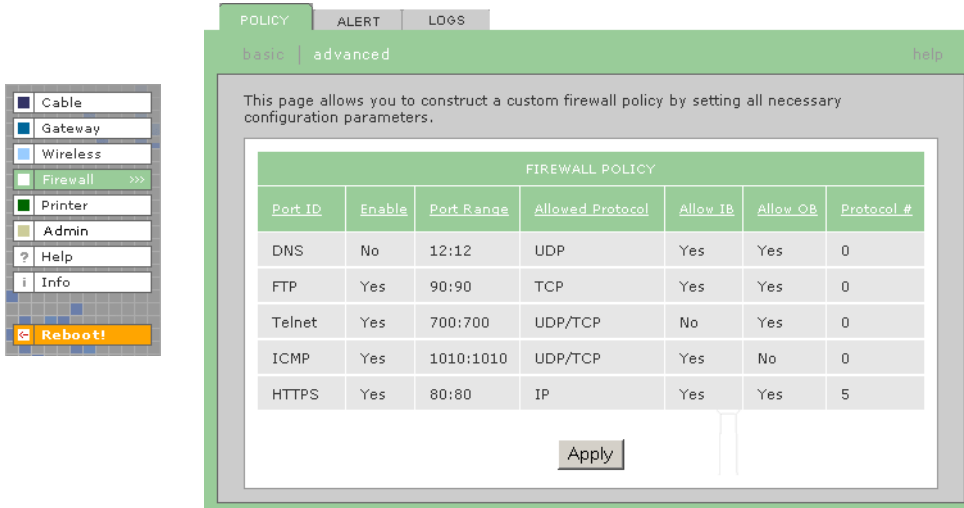

Firewall > POLICY — advanced page fields

Field	Description
Port ID	The name of the protocol being filtered.
Enable	Check this box to enable firewall policy filtering for the port.
Port Range (From:To)	Sets the from and to port range, which must contain all ports required by the protocol.
Allowed Protocol	The allowed protocols.
Allow IB (Inbound)	Filters inbound data from the Internet on the specified ports.
Allow OB (Outbound)	Filters outbound data to the Internet on the specified ports. Stateful inspection ensures appropriate responses for outbound sessions.
Protocol #	The protocol number associated with the IP packets to allow in the firewall policy.

Firewall > ALERT — basic Page

Use this page to set the alert mechanism for firewall intrusion detection events.

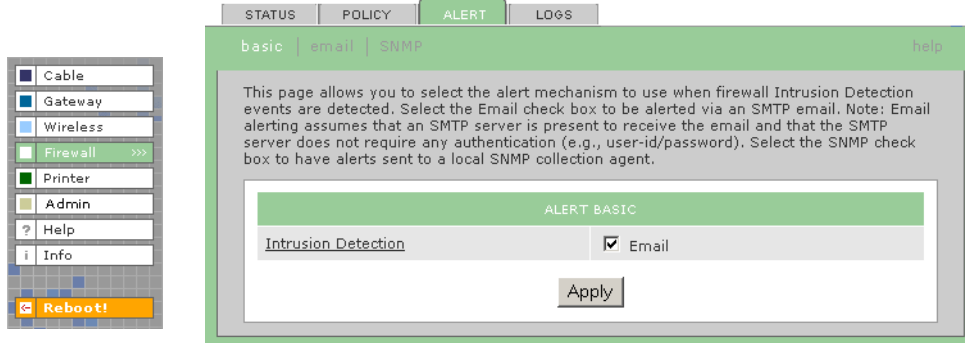

Firewall > ALERT — basic page fields

Field or Button	Description
-----------------	-------------

Intrusion Detection	Check Email to be alerted through SMTP e-mail. An SMTP server that does not require any authentication such as a user name or password must be present to receive the e-mail.
----------------------------	---

Apply	Click to apply your changes.
--------------	------------------------------

Firewall > ALERT — email Page

Use this page to configure the e-mail alert parameters:

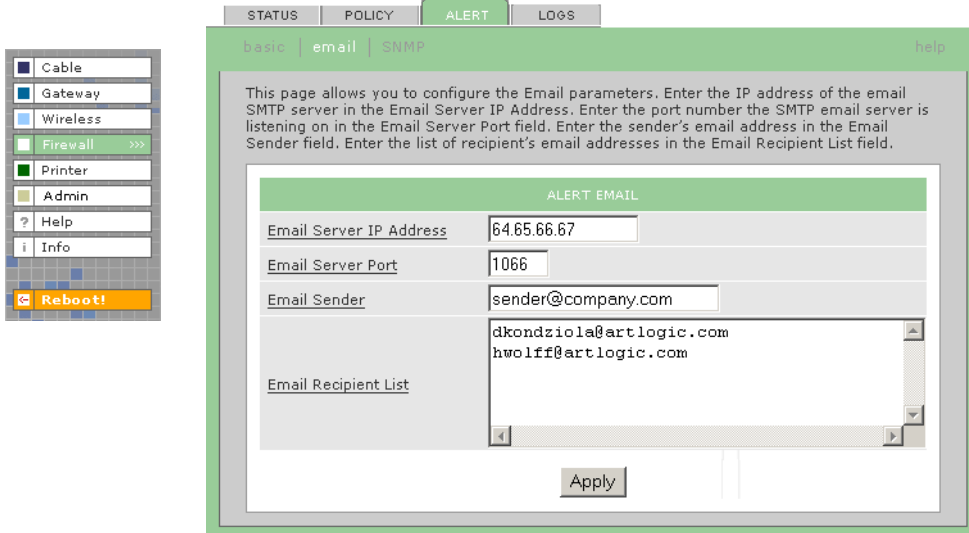

Firewall > ALERT — email page fields

Field or Button	Description
E-mail Server IP Address	Sets the e-mail server IP address, in dotted-decimal format .
E-mail Server Port	Sets the e-mail server port number.
E-mail Sender	Sets the sender e-mail address.
E-mail Recipient List	Sets the list of e-mail addresses that receive alerts from the SBG firewall.
Apply	Click to apply your changes.

Firewall > LOGS Page

Use this page to set which firewall events are logged.

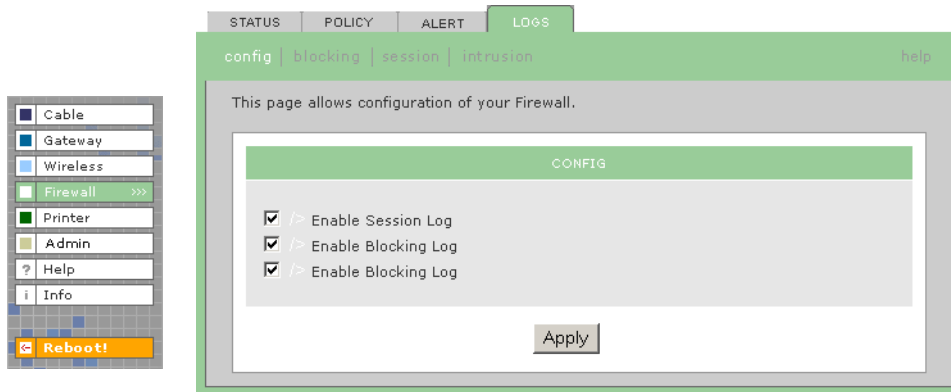

Firewall > LOGS page fields

Field or Button	Description
Enable Session Log	Check this box to log session events.
Enable Blocking Log	Check this box to log blocking events.
Enable Intrusion Log	Check this box to log intrusions.
Apply	Click to apply your changes.

Configuring the Gateway

This section describes the Gateway configuration pages in the SBG Setup Program:

- [Gateway > STATUS Page](#) (see page 44)
- [Gateway > WAN Page](#) (see page 45)
- [Gateway > LAN — nat config Page](#) (see page 47)
- [Gateway > LAN — dhcp server config Page](#) (see page 48)
- [Gateway > LAN — dhcp reservations Page](#) (see page 49)
- [Gateway > LOG Page](#) (see page 51)

*For some settings, after you edit the field and click Apply, you are warned that you must **Reboot** for your change to take effect. Rebooting takes 10 to 15 seconds. After rebooting, you must log-in again.*

Gateway > STATUS Page

This page displays the gateway status information:

The screenshot shows the 'STATUS' page of a Gateway configuration utility. On the left is a navigation menu with options: Cable, Gateway (selected), Wireless, Firewall, Printer, Admin, Help, and Info. Below the menu is a 'Reboot!' button. The main content area has tabs for STATUS, WAN, LAN, ALG, and LOG. A 'help' link is in the top right. The page contains the following sections:

This page lists the status information for several gateway configuration parameters.

WAN Status	Data
DNS Address 1	206.19.80.10
DNS Address 2	206.19.86.10
DNS Address 3	0.0.0.0
WAN IP Address	206.19.87.147
TCP Session Wait Timeout	300
UDP Session Wait Timeout	300
ICMP Session Wait Timeout	300

LAN Status	Data
LAN IP Address	192.168.0.1
LAN Subnet Mask	255.255.255.0
MAC Address	00:08:0E:D2:F4:47
DHCP Server Enabled	Yes

DHCP LEASE TABLE					
IP Address	Client ID	Hostname	Method	Lease Create Time	Lease Expire Time
192.168.0.10	00:10:4B:93:91:48	Micron1	Dynamic	2002-10-01 13:26:08	2002-10-01 14:26:09
192.168.0.11	00:30:65:1F:4D:CF	Applications Engineering Computer	Dynamic	2002-10-01 12:25:00	2002-10-01 14:25:05

TRANSLATED ADDRESS					
WAN IP Address	WAN Port	LAN IP Address	LAN Port	Mapping Mode	Mapping Protocol
206.19.86.10	53	206.19.87.147	1120	1	3
206.19.86.10	53	206.19.87.147	1121	1	3
206.19.86.10	53	206.19.87.147	1122	1	3
206.19.86.10	53	206.19.87.147	1123	1	3
206.19.86.10	53	206.19.87.147	1124	1	3
206.19.86.10	53	206.19.87.147	1125	1	3
206.19.86.10	53	206.19.87.147	1126	1	3
206.19.86.10	53	206.19.87.147	1127	1	3

These fields display settings that are set on the other Gateway pages. For descriptions, see the sections about those pages.

Gateway > WAN Page

Use this page to configure the external (public) wide area network (WAN) interface:

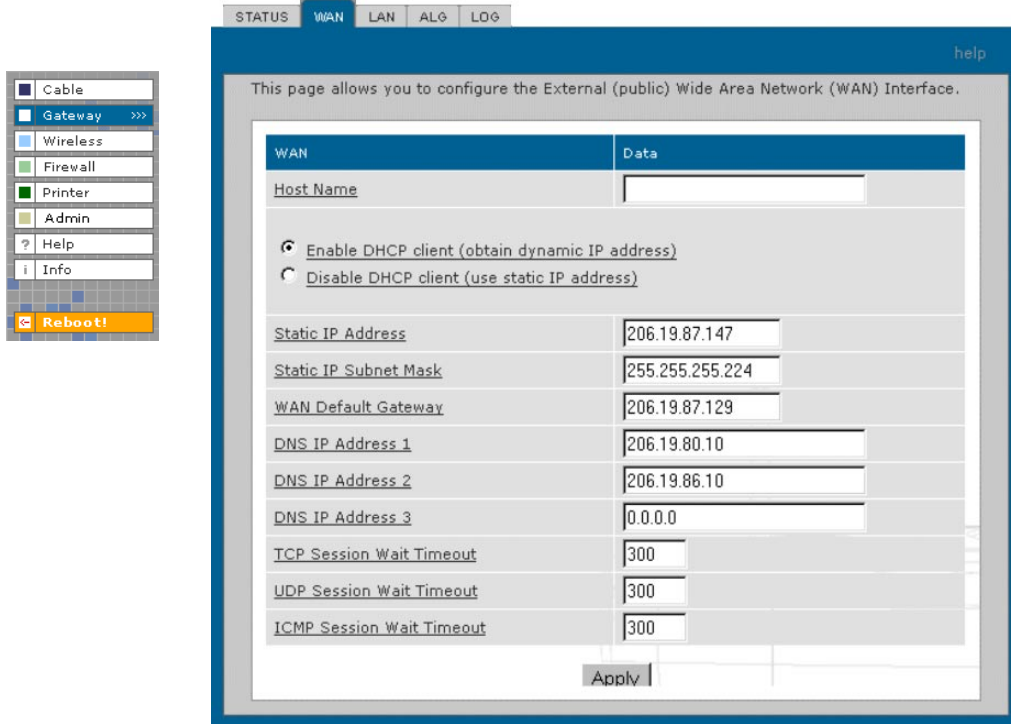

Gateway > WAN page fields

Field	Description
Host Name	If the cable service provider requires a hostname to access to their network, type the <i>hostname</i> they provided in this field. The default is None.
Enable DHCP Client	Enabling the DHCP client causes the wireless gateway to automatically obtain the public IP address , subnet mask , domain name , and DNS server(s). Most commonly, the DHCP client is enabled if the cable service provider automatically assigns a public IP address from their DHCP server. Enable DHCP Client is on by default.
Disable DHCP Client	If the cable service provider does not automatically assign a public IP address using DHCP, they must provide a static IP address . Select Disable DHCP Client. When you disable the DHCP client, you must type the static IP address, subnet mask, DNS server(s), and domain name (if necessary) in the fields provided. Disable DHCP Client is off by default.
Static IP Address	If Disable DHCP Client is on, type the static IP address provided by the cable service provider, in dotted-decimal format . The default is None.
Static IP Address Subnet Mask	If Disable DHCP Client is on, type the subnet mask associated with the static IP address, in dotted-decimal format. The default is None.
Domain Name	If the cable service provider requires a domain name, type the domain name they provided you in this field. The default is None.

Gateway > WAN page fields (continued)

Field	Description
DNS IP Address 1	The cable service provider DNS server provides name-to-IP address resolution. If the cable service provider does not automatically assign DNS addresses from their DHCP server, they must provide at least one DNS server IP address to enter in these fields, in dotted-decimal format. The default is None.
DNS IP Address 2	
DNS IP Address 3	
TCP Session Wait Timeout	Sets the maximum time in minutes to wait before assuming a TCP session has timed out. The default is 5 minutes.
UDP Session Wait Timeout	Sets the maximum time in minutes to wait before assuming a UDP session has timed out. The default is 5 minutes.
ICMP Session Wait Timeout	Sets the maximum time in minutes to wait before assuming an ICMP session has timed out. The default is 5 minutes.
Apply	Click to apply your changes.

Gateway > LAN — nat config Page

Use this page to configure NAT:

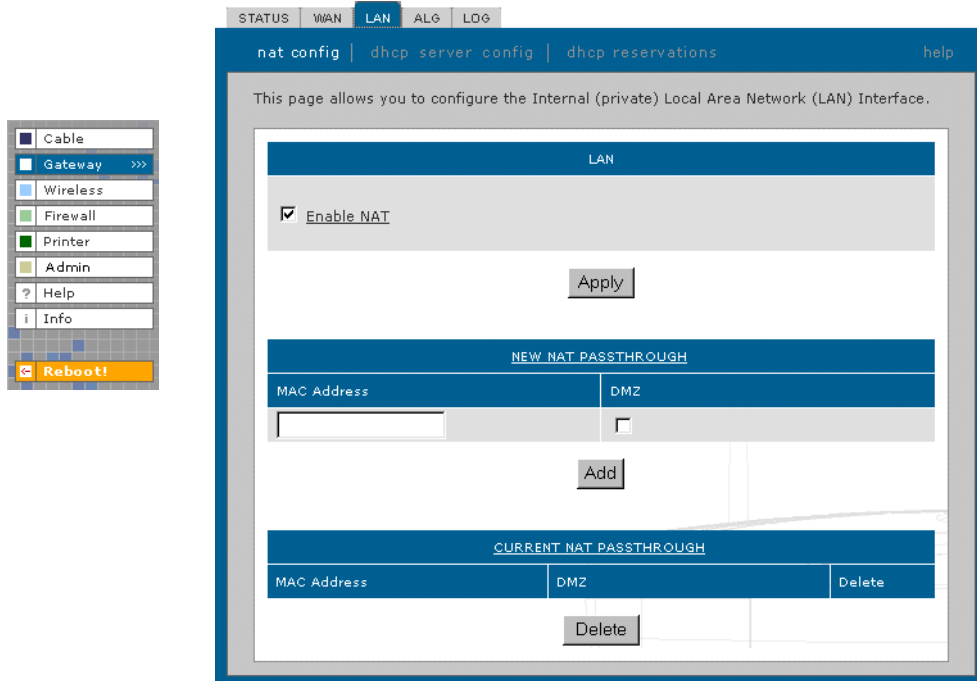

Gateway > LAN — nat config page fields

Field or Button	Description
LAN	
Enable NAT	If enabled, the single HFC IP Address (public IP address) assigned by the cable service provider is mapped to many private IP addresses on the SBG LAN.
Apply	Click to apply your changes. You must reboot the SBG1000.
NEW NAT PASSTHROUGH	
MAC Address	Sets the MAC address of the passthrough client. The format is 16 hexadecimal numerals.
DMZ	Check the box to set the MAC address as a de-militarized zone (DMZ) client. A DMZ is a computer on the LAN that can be accessed from the public Internet.
Add	Click to add the IP address to the reserved IP address table.
CURRENT NAT PASSTHROUGH	
Delete	Click to delete the MAC address from the NAT passthrough list.

Gateway > LAN — dhcp server config Page

Experienced network administrators *only* can use this page to perform advanced DHCP server configuration:

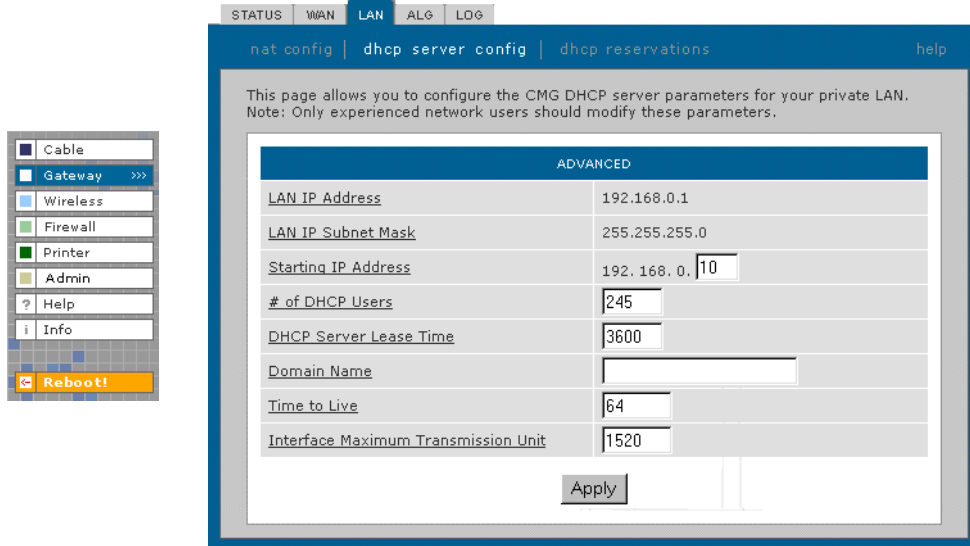

CAUTION!



Do not modify these settings unless you are an experienced network administrator with strong knowledge of IP addressing, subnetting, and DHCP.

Gateway > LAN — advanced page fields

Field	Description
LAN IP Address	Sets the SBG LAN IP address, in dotted-decimal format . The default is 192.168.0.1.
LAN IP Subnet Mask	Sets the subnet mask , in dotted-decimal format. The default is 255.255.255.0
Starting IP Address	Sets the starting IP address assigned by the SBG1000 DHCP server to clients, in dotted-decimal format. The default is 192.168.0.2.
# of DHCP Users	Sets the number of clients for the SBG1000 DHCP server to assign a private IP address. There are 245 possible client addresses. The default is 245.
DHCP Server Lease Time	Sets the time in seconds that the SBG1000 DHCP server leases an IP address to a client. The default is 60 seconds.
Domain Name	Sets the domain name for the SBG LAN. The default is None.
Time To Live	Sets the TTL (hop limit) for outbound packets . The default is 64.
Interface Maximum Transmission Unit	Sets the SBG LAN MTU , in bytes. The minimum is 68 bytes. The default is 1500 bytes.
Apply	Click to apply your changes. SBG1000 reboot required.

Gateway > LAN — dhcp reservations Page

Use this page to configure DHCP reservations:

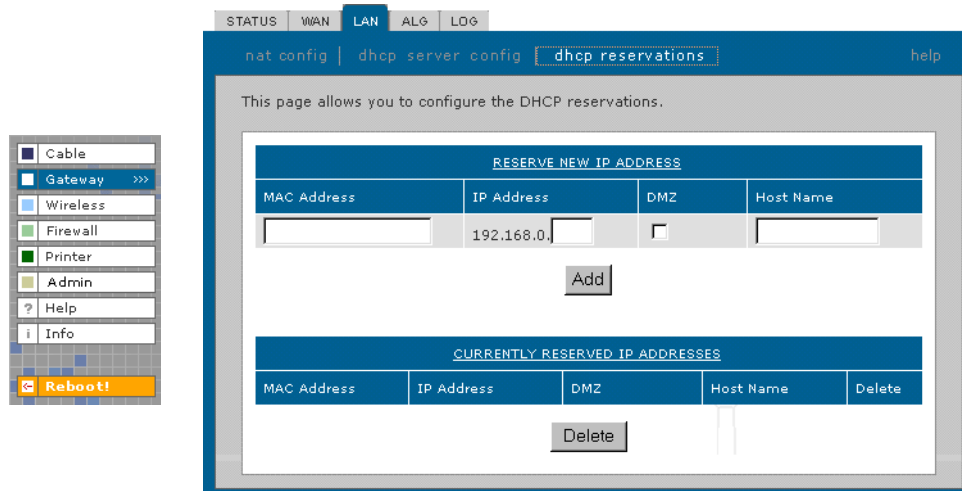

Gateway > LAN — dhcp reservations page fields

Field	Description
RESERVE NEW IP ADDRESS	You can reserve up to 32 IP addresses assigned by the SBG DHCP server for specific LAN clients. For example, you can reserve an IP address for a private FTP server to ensure that it always receives the same private IP address.
MAC Address	Type the MAC address of the DHCP client for which a reserved IP address is required. The format is 16 hexadecimal numerals.
IP Address	Sets the host portion of the reserved IP address for the LAN client having the specified MAC address. When the LAN client requests an IP address, the SBG DHCP server assigns the client this IP address.
DMZ	Check this box if you want the host to bypass NAT and be exposed directly to the Internet. When configuring a client as a NAT passthrough device, you can specify whether it should be a de-militarized zone (DMZ) host. A DMZ host is completely exposed to the Internet. <i>Any device configured as a DMZ is open to Internet hackers and should be used with extreme caution.</i>
Host Name	If your ISP requires a hostname to access their network, enter the hostname provided to you in the Host Name field.
Add	Click Add to reserve a new IP address.

Gateway > LAN — dhcp reservations page fields (continued)

Field	Description
CURRENTLY RESERVED IP ADDRESSES	Displays all DHCP clients that have specific IP addresses reserved for their use by MAC and IP address.
MAC Address	Displays the reserved MAC addresses.
IP Address	Displays the reserved IP addresses.
DMZ	Displays whether the client is configured as a DMZ.
Host Name	Displays the host name.
Delete	Click this box to remove the reserved IP address for the client.
Delete	Click this button to remove the reserved IP addresses for clients designated by the Delete box.

Gateway > ALG — basic Page

This may not be supported in your code release. For the most recent documentation, visit the [Product Documentation](#) page on www.motorola.com/broadband.

Gateway > ALG — advanced Page

This may not be supported in your code release. For the most recent documentation, visit the [Product Documentation](#) page on www.motorola.com/broadband.

Gateway > LOG Page

Use this page to:

The screenshot shows the Gateway configuration interface with the 'LOG' tab selected. On the left is a navigation menu with options: Cable, Gateway, Wireless, Firewall, Printer, Admin, Help, Info, and a Reboot! button. The main area displays a table of log entries with columns for Time, Priority, Code, and Message.

Time	Priority	Code	Message
1970-01-01 00:00:57	3-Critical	0x04E33948	No Ranging Response received - T3 time-out
1970-01-01 00:00:25	3-Critical	0x040D9964	DHCP FAILED - Discover sent, no offer received
1970-01-01 00:00:14	3-Critical	0x040D9A2C	DHCP WARNING - Non-critical field invalid in response.
1970-01-01 00:00:19	4-Error	0x040D9A93	ToD request sent- No Response received
1970-01-01 00:00:53	3-Critical	0x0501BD64	SYNC Timing Synchronization failure - Failed to acquire QAM/QPSK symbol timing
2002-10-01 13:32:10	5-Warning	0x040DC13C	DHCP RENEW WARNING - Field invalid in response
2002-09-26 12:24:58	3-Critical	0x0501BEF4	SYNC Timing Synchronization failure - Loss of Sync
2002-09-26 12:25:17	3-Critical	0x0501BDC8	SYNC Timing Synchronization failure - Failed to acquire FEC framing
2002-09-26 12:25:22	3-Critical	0x04E33A10	Received Response to Broadcast Maintenance Request, But no Unicast Maintenance opportunities received - T4 timeout
2002-10-01 11:30:27	6-Notice	0x041D02B4	SW Download INIT - Via NMS
2002-10-01 11:31:43	6-Notice	0x041D069C	SW download Successful - Via NMS
			DHCP RENEW sent - Invalid DHCP

Gateway > LOG page fields

Field	Description
Time	The data and time in the format yyyy-mm-dd hh:mm:ss (hours hh are 00 to 23)
Priority	Indicates the importance of the message.
Code	
Message	Describes the event.

Configuring TCP/IP

You must be sure all client computers are configured for [TCP/IP](#) (a protocol for communication between computers). Perform *one* of:

- “[Configuring TCP/IP in Windows 95, Windows 98, or Windows Me](#)” on page 54
- “[Configuring TCP/IP in Windows 2000](#)” on page 56
- “[Configuring TCP/IP in Windows XP](#)” on page 60
- Follow the instructions in your Macintosh or UNIX user manual

After configuring TCP/IP, perform *one* of the following to verify the [IP address](#):

- “[Verifying the IP Address in Windows 95, Windows 98, or Windows Me](#)” on page 64
- “[Verifying the IP Address in Windows 2000 or Windows XP](#)” on page 65
- Follow the instructions in your Macintosh or UNIX user manual

Configuring TCP/IP in Windows 95, Windows 98, or Windows Me

- 1 On the Windows Desktop, click **Start**.
- 2 Select **Settings** and then **Control Panel** from the pop-up menus to display the Control Panel window.
- 3 Double-click the **Network** icon to display the Network window:

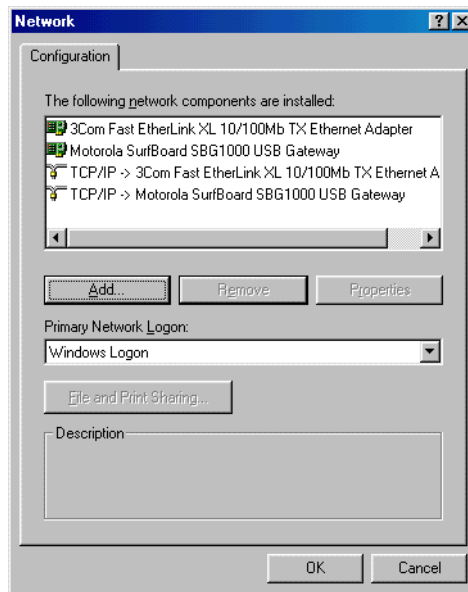

Although your SBG model number may be different than in the images in this guide, the procedure is the same.

- 4 Select the **Configuration** tab.
- 5 Verify that TCP/IP is installed for the adapter used to connect to the SBG1000. If TCP/IP is installed, skip to step 10. If TCP/IP is not installed for the adapter, continue with step 6.
- 6 Select the adapter to use for the SBG1000 connection and click **Add**. The Select Network Component Type window is displayed:

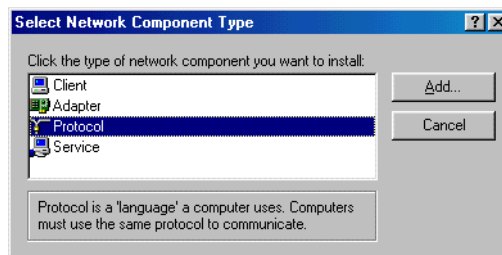

- 7 Click **Protocol** and click the **Add** button.

- 8 Click **Microsoft** in the Manufacturers section and click **TCP/IP** in the Network Protocol section of Select Network Protocol window:

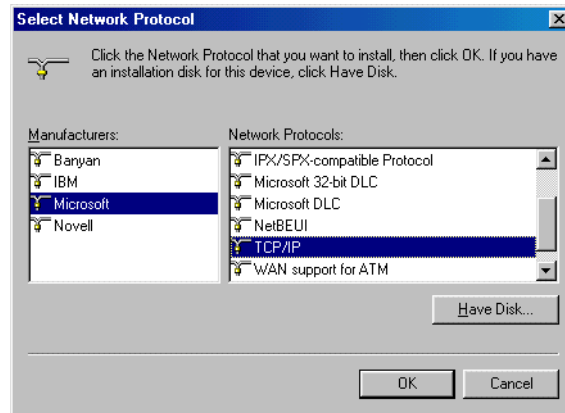

- 9 Click **OK**.
- 10 Click **TCP/IP** on the Network window. If there is more than one TCP/IP entry, choose the one for the Ethernet card or USB port connected to the SBG1000.
- 11 Click **Properties**. The TCP/IP Properties window is displayed:

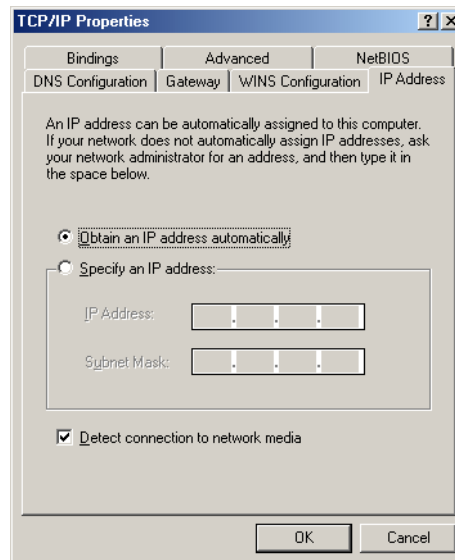

- 12 Click the **IP Address** tab.
- 13 Click **Obtain an IP address automatically**.
- 14 Click **OK** to accept the TCP/IP settings.
- 15 Click **OK** to close the Network window.
- 16 Click **OK** when prompted to restart the computer and click **OK** again.

When you complete TCP/IP configuration, go to ["Verifying the IP Address in Windows 95, Windows 98, or Windows Me"](#) on page 64.

Configuring TCP/IP in Windows 2000

- 1 On the Windows Desktop, click **Start**.
- 2 Select **Settings** and then **Control Panel** from the pop-up menus to display the Control Panel window:

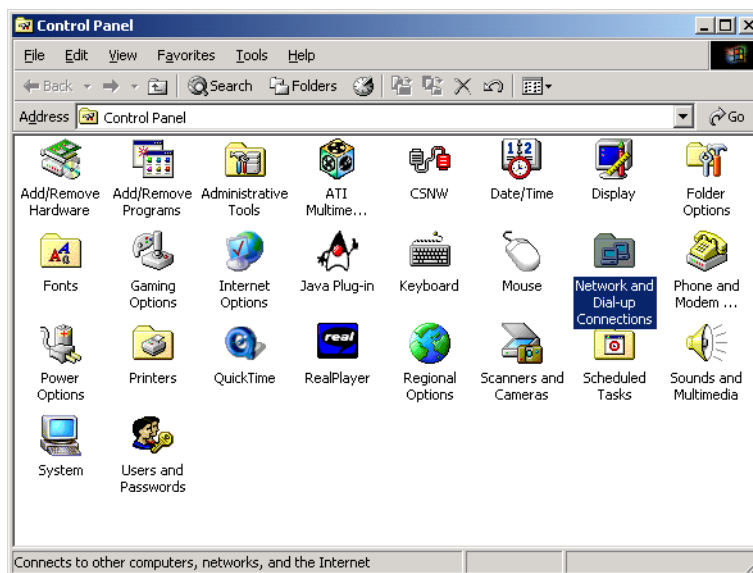

- 3 Double-click the **Network and Dial-up Connections** icon to display the Network and Dial-up Connections window:

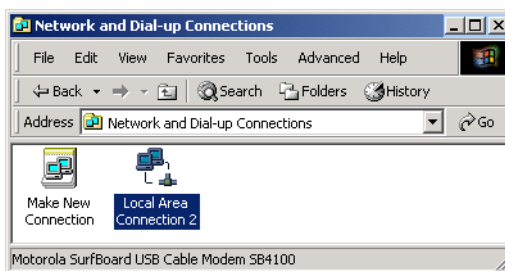

- 4 Click **Local Area Connection number**. The value of *number* varies from system to system. The Local Area Connection *number* Status window is displayed:

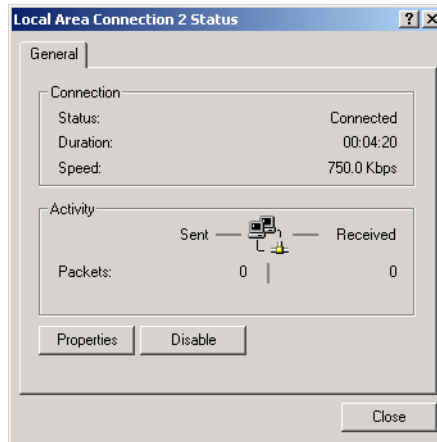

- 5 Click **Properties**. Information similar to the following window is displayed:

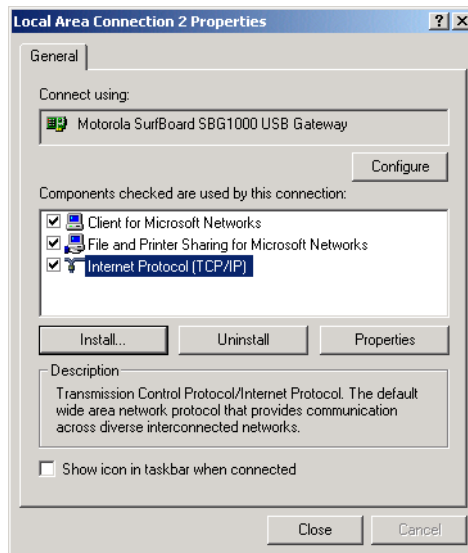

- 6 If Internet Protocol (TCP/IP) is in the list of components, TCP/IP is installed. You can skip to step 10.
If Internet Protocol (TCP/IP) is not in the list, click **Install**. The Select Network Component Type window is displayed:

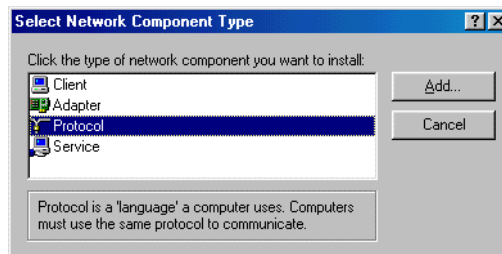

- Click **Protocol** on the Select Network Component Type window and click **Add**. The Select Network Protocol window is displayed:

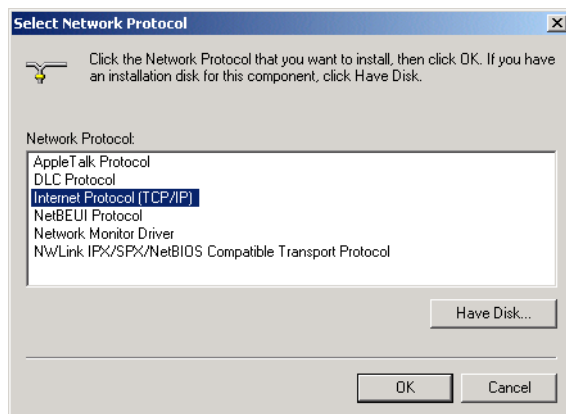

- Click **Internet Protocol (TCP/IP)**.
- Click **OK**. The Local Area Connection *number* Properties window is re-displayed.

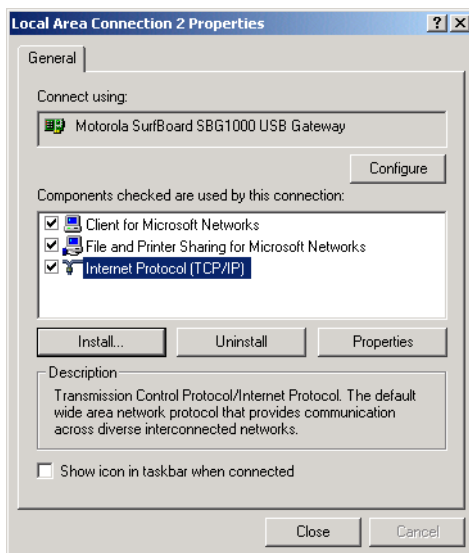

- Be sure the box next to Internet Protocol (TCP/IP) is checked.

- 11 Click **Properties**. The Internet Protocol (TCP/IP) Properties window is displayed:

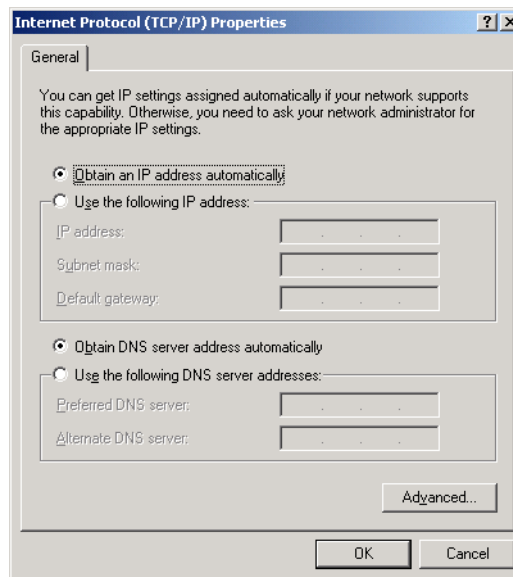

- 12 Be sure **Obtain IP address automatically** and **Obtain DNS server address automatically** are selected.
- 13 Click **OK** to accept the TCP/IP settings.
- 14 Click **OK** to close the Local Area Connection *number* Properties window.
- 15 Click **OK** when prompted to restart the computer and click **OK** again.

When you complete the TCP/IP configuration, go to [“Verifying the IP Address in Windows 2000 or Windows XP”](#) on page 65.

Configuring TCP/IP in Windows XP

- 1 On the Windows desktop, click **Start** to display the Start window:

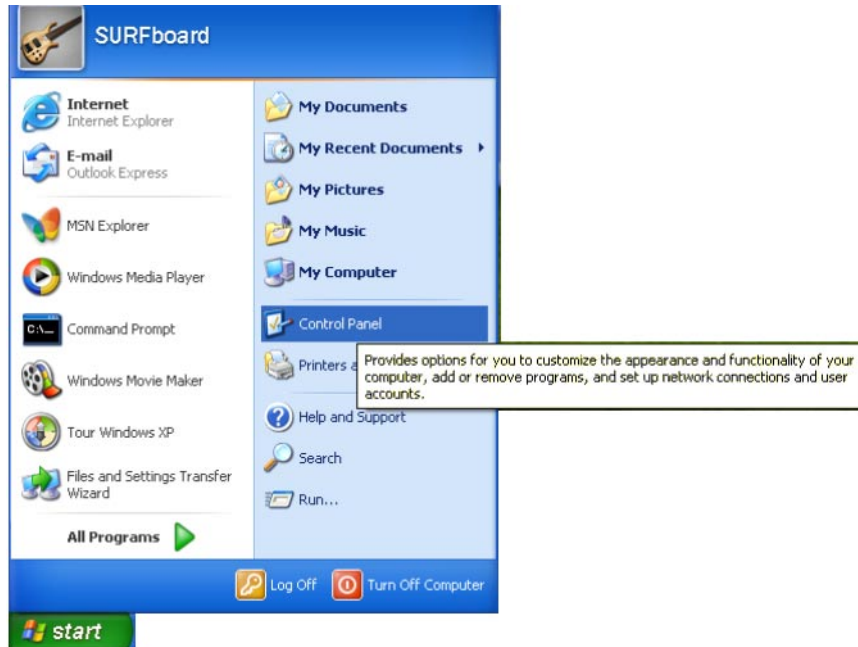

- 2 Click **Control Panel** to display the Control Panel window. The display varies, depending on the Windows XP view options. If the display is a Category view as shown below, continue with step 3. Otherwise, skip to step 5.

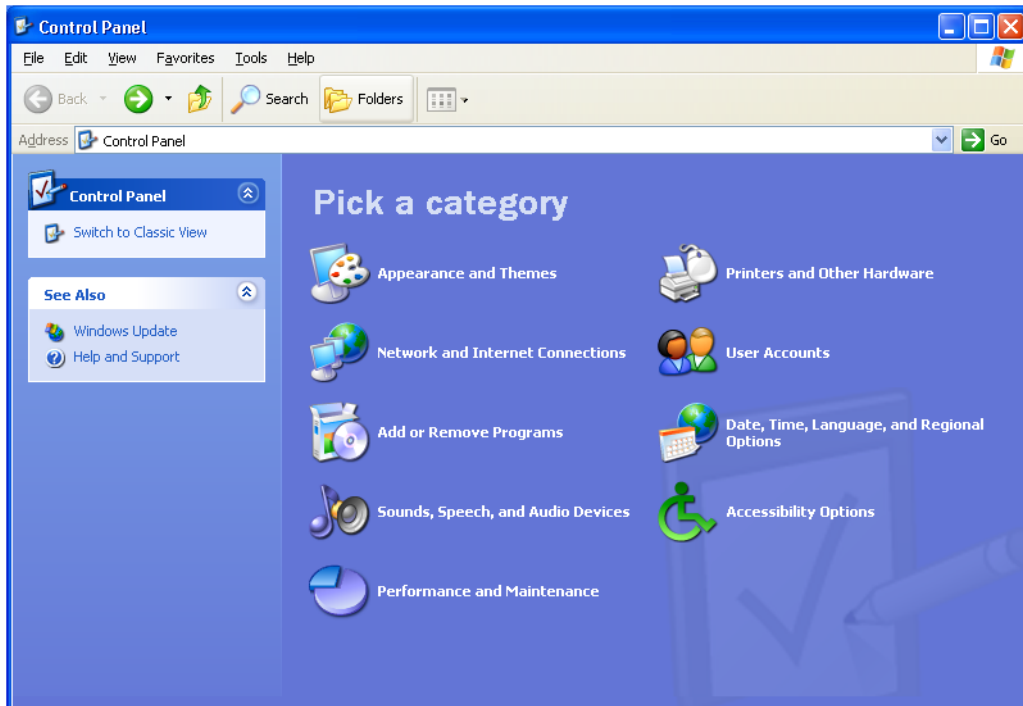

- Click **Network and Internet Connections** to display the Network and Internet Connections window:

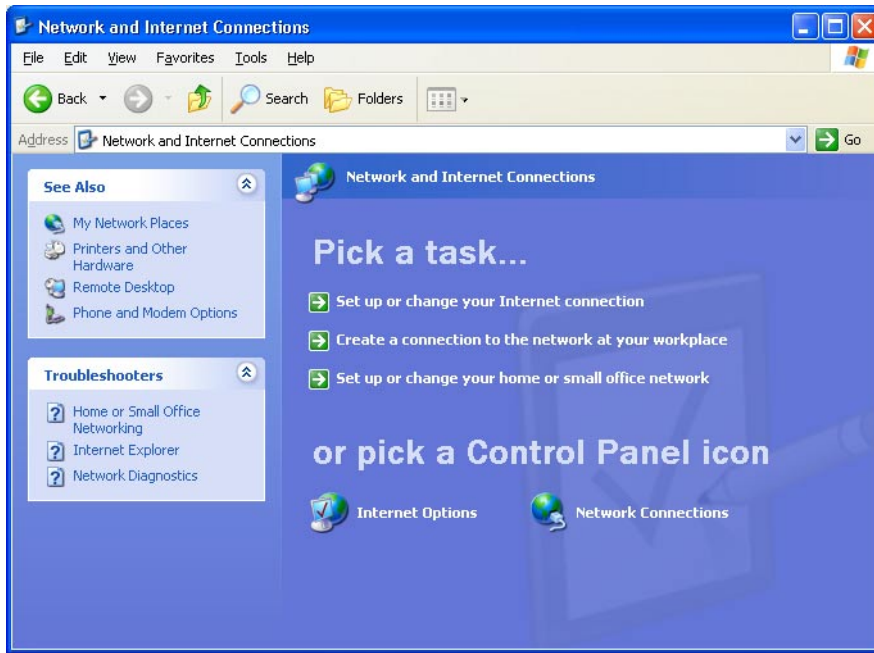

- On the Network and Internet Connections window in the "or pick a Control Panel icon, click **Network Connections** to display the LAN or High-speed Internet connections. Skip to step 6.
- If a classic view similar to below is displayed, click **Network Connections** to display the LAN or High-speed Internet connections:

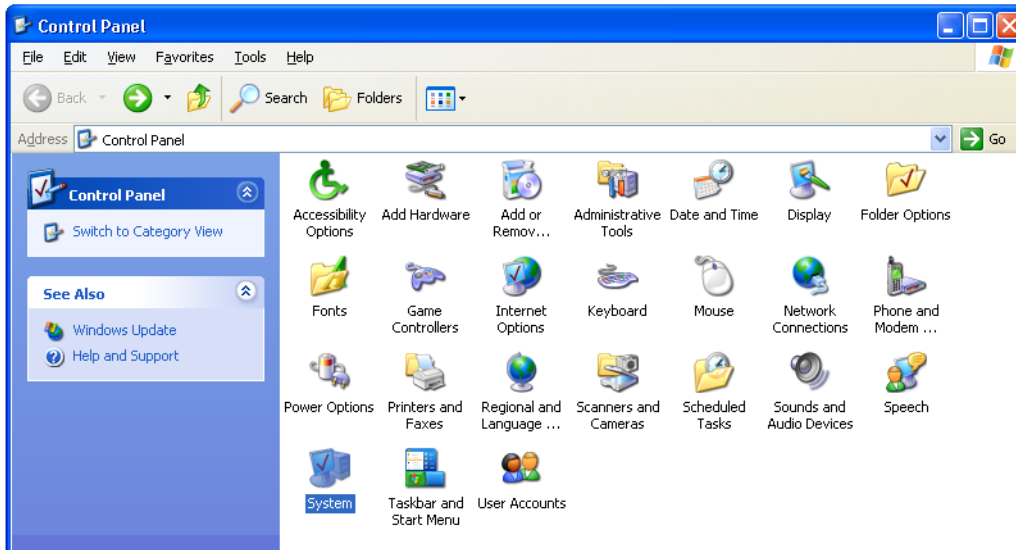

- 6 Right-click on the network connection. If more than one connection is displayed, be sure to select the one for your network interface:

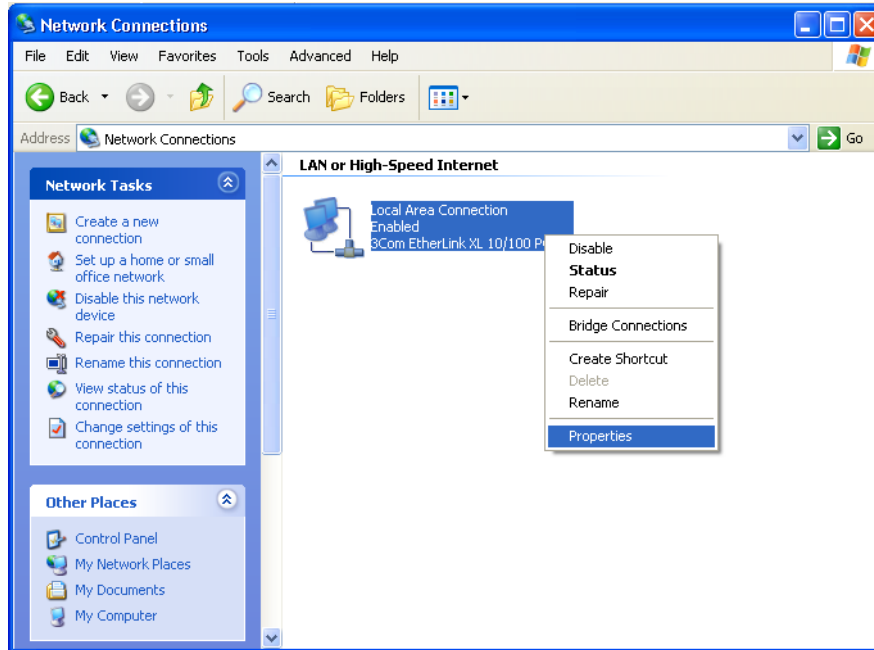

- 7 Select **Properties** from the pop-up menu to display the Local Area Connection Properties window:

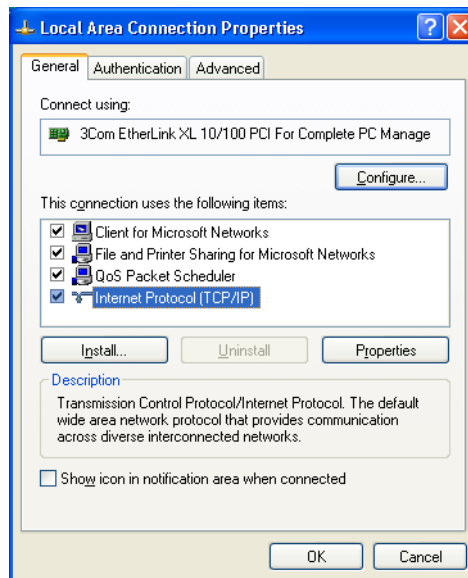

- 8 On the Local Area Connection Properties window, be sure Internet Protocol (TCP/IP) is checked. If it is not checked, check it.

- 9 Select **Internet Protocol (TCP/IP)** and click **Properties** to display the Internet Protocol (TCP/IP) Properties window:

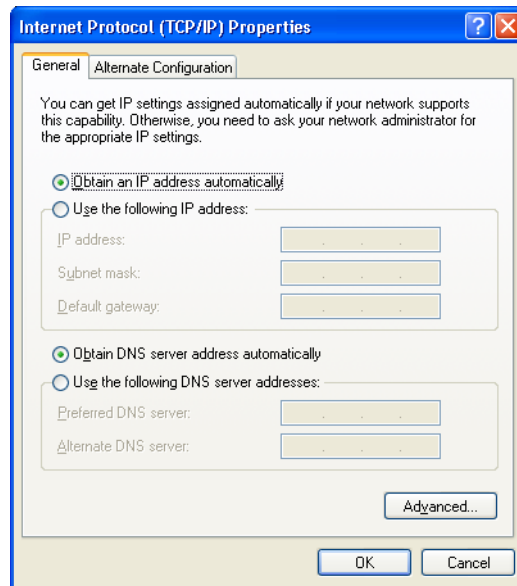

- 10 On the Internet Protocol (TCP/IP) Properties window, verify that the settings are correct, as shown above.
- 11 Click **OK** to close the TCP/IP Properties window.
- 12 Click **OK** to close the Local Area Connection Properties window.

When you complete the TCP/IP configuration, go to [“Verifying the IP Address in Windows 2000 or Windows XP”](#) on page 65.

Verifying the IP Address in Windows 95, Windows 98, or Windows Me

To check the IP address:

- 1 On the Windows Desktop, click **Start**.
- 2 Select **Run**. The Run window is displayed.
- 3 Type **wiipcfg.exe** and click **OK**. The IP Configuration window is displayed. The Ethernet Adapter Information field will vary depending on the system, as shown in the following examples:

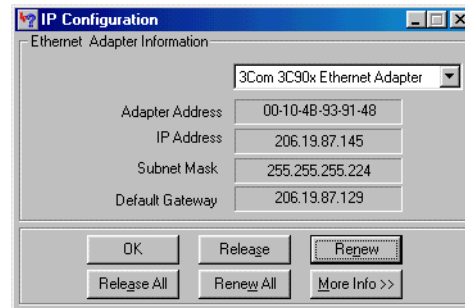
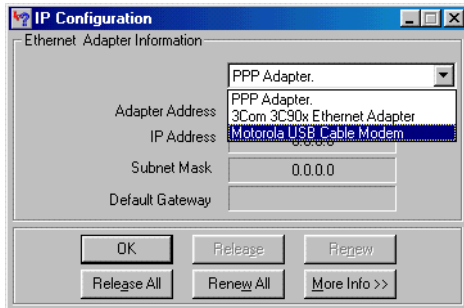
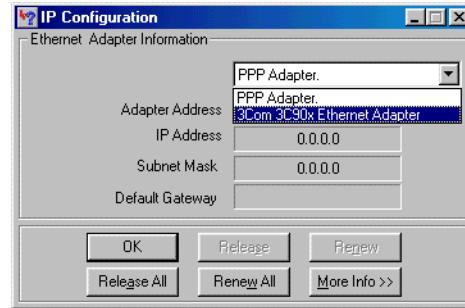
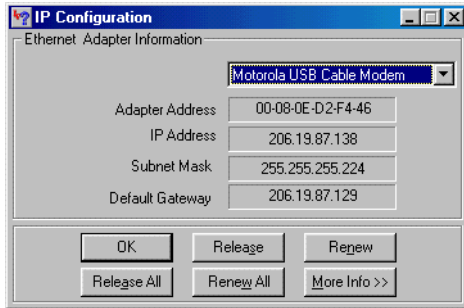

The values for Adapter Address, IP Address, Subnet Mask, and Default Gateway on the PC will be different than in the image.

In Windows 98, if "Autoconfiguration" is displayed before the IP Address as in the following image, call your service provider.

Adapter Address	00-80-C6-E7-59-E6
IP Autoconfiguration Address	169.254.191.251

- 4 Select the adapter name — the Ethernet card or USB device.
- 5 Click **Renew**.
- 6 Click **OK** after the system displays an IP address.

If after performing this procedure the computer cannot access the Internet, call your cable service provider for help.

Verifying the IP Address in Windows 2000 or Windows XP

To check the IP address:

- 1 On the Windows Desktop, click **Start**.
- 2 Select **Run**. The Run window is displayed.
- 3 Type **cmd** and click **OK** to display a command prompt window.
- 4 Type **ipconfig** and press ENTER to display the IP configuration. A display similar to the following indicates a normal configuration:

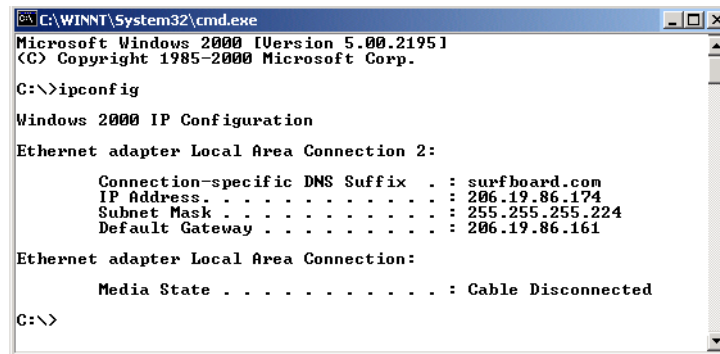

```
C:\WINNT\System32\cmd.exe
Microsoft Windows 2000 [Version 5.00.2195]
(C) Copyright 1985-2000 Microsoft Corp.

C:\>ipconfig

Windows 2000 IP Configuration

Ethernet adapter Local Area Connection 2:

    Connection-specific DNS Suffix  . : surfboard.com
    IP Address . . . . . : 206.19.86.174
    Subnet Mask . . . . . : 255.255.255.224
    Default Gateway . . . . . : 206.19.86.161

Ethernet adapter Local Area Connection:

    Media State . . . . . : Cable Disconnected

C:\>
```

If an Autoconfiguration IP Address is displayed as in the following window, there is an incorrect connection between the PC and the SBG1000 or there are cable network problems. Check the cable connections and determine if you can view cable-TV channels on your television:

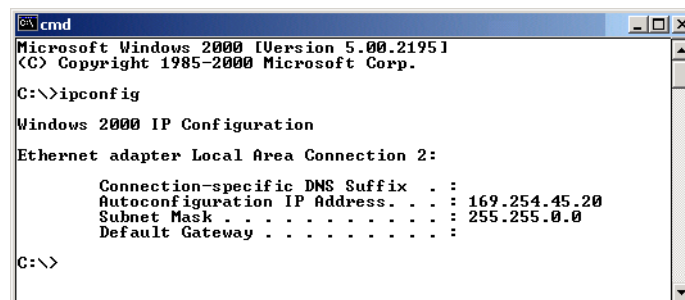

```
C:\cmd
Microsoft Windows 2000 [Version 5.00.2195]
(C) Copyright 1985-2000 Microsoft Corp.

C:\>ipconfig

Windows 2000 IP Configuration

Ethernet adapter Local Area Connection 2:

    Connection-specific DNS Suffix  . :
    Autoconfiguration IP Address. . . : 169.254.45.20
    Subnet Mask . . . . . : 255.255.0.0
    Default Gateway . . . . . :

C:\>
```

After verifying the cable connections and proper cable-TV operation, renew the IP address.

To renew the IP address:

- 1 Type **ipconfig /renew** and press ENTER. If a valid IP address is displayed as shown, Internet access should be available.

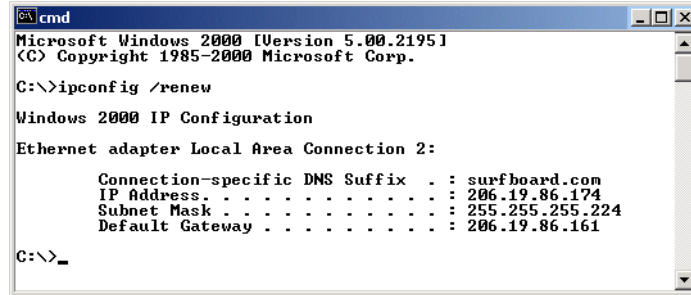

```
cmd
Microsoft Windows 2000 [Version 5.00.2195]
(C) Copyright 1985-2000 Microsoft Corp.

C:\>ipconfig /renew

Windows 2000 IP Configuration

Ethernet adapter Local Area Connection 2:

    Connection-specific DNS Suffix  . : surfboard.com
    IP Address . . . . . : 206.19.86.174
    Subnet Mask . . . . . : 255.255.255.224
    Default Gateway . . . . . : 206.19.86.161

C:\>_
```

- 2 Type **exit** and press ENTER to return to Windows.

If after performing this procedure the computer cannot access the Internet, call your cable service provider for help.

❖ Setting Up the Wireless LAN

You can use the Motorola SBG1000 Wireless Cable Modem Gateway as an [access point](#) for an [IEEE 802.11b](#) wireless LAN without changing its default settings. This section describes:

- [Configuring a Unique Wireless Network Name](#) (see page 68)
- [Configuring Basic Wireless LAN Security](#) (see page 69)
- [Configuring Wireless Clients](#) (see page 70)
- [Wireless Pages in the SBG Setup Program](#) (see page 70)

Caution!



The default *Wired Equivalent Privacy (WEP) Authentication* setting *Disable WEP* provides no security for wireless data. After the wireless LAN is operational, be sure to configure WEP as described in [“Configuring Basic Wireless LAN Security”](#) on page 69.

Configuring a Unique Wireless Network Name

All [clients](#) (stations) on the wireless LAN must have the same network name (ESSID) as the [access point](#) on the SBG1000. *You must configure the same ESSID on all IEEE 802.11b LAN clients.*

To configure the ESSID:

- 1 Start the SBG Setup Program as described in “Starting the SBG Setup Program” on page 32.
- 2 On the left frame, click **Wireless**.
- 3 Click the **NETWORK** tab to display:

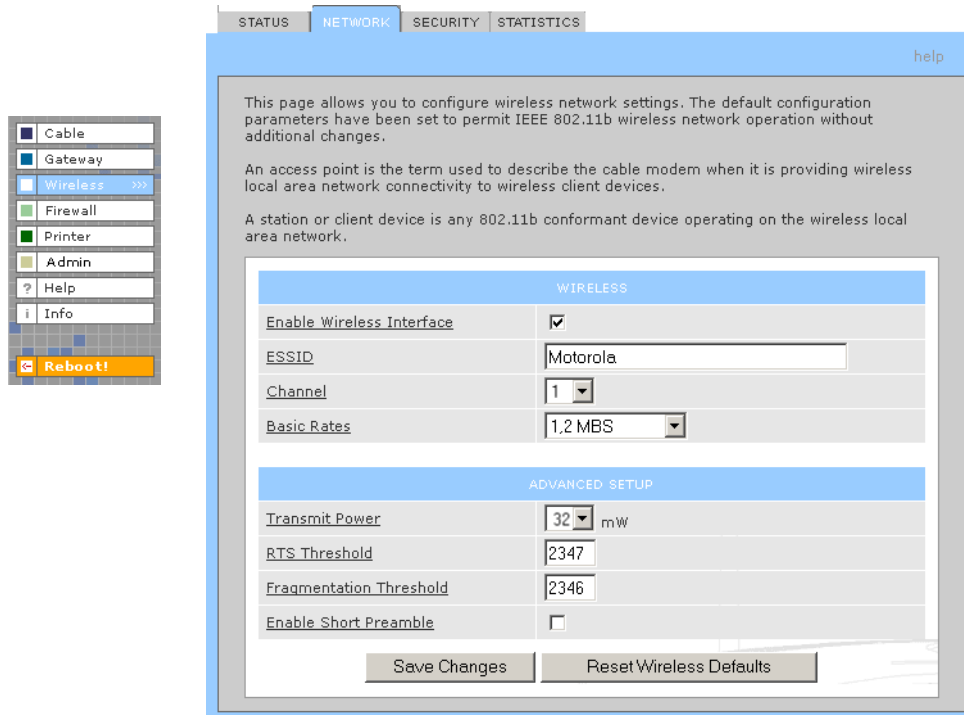

The screenshot shows the 'NETWORK' configuration page with the following settings:

WIRELESS	
Enable Wireless Interface	<input checked="" type="checkbox"/>
ESSID	Motorola
Channel	1
Basic Rates	1.2 MBS

ADVANCED SETUP	
Transmit Power	32 mW
RTS Threshold	2347
Fragmentation Threshold	2346
Enable Short Preamble	<input type="checkbox"/>

Buttons: Save Changes, Reset Wireless Defaults

- 4 In the ESSID field, type a *name*. It can be any alphanumeric, case-sensitive string up to 32 characters. The default is “Motorola.” *Do not use the default ESSID.*
- 5 Click **Save Changes** to save your changes.

Configuring Basic Wireless LAN Security

Caution!



The default settings provide no security for wireless data. After the wireless LAN is operational, be sure to enable Shared Key Authentication and Wired Equivalent Privacy (WEP) encryption. You must configure the same WEP key on the SBG1000 [access point](#) and all wireless [clients](#) (stations).

To enable WEP and set the key on the SBG1000:

- 1 On the SBG Setup Program left frame, click **Wireless**.
- 2 Click the **SECURITY** tab to display the Wireless > SECURITY — basic screen:

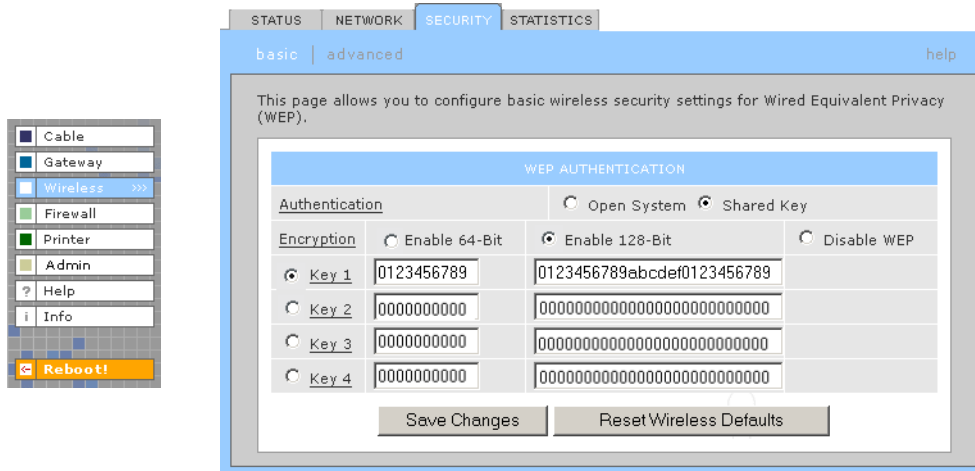

- 3 Set the following:

- Authentication** Sets whether shared key authentication is enabled to provide data privacy on the wireless LAN:
- Open System — Any wireless LAN [client](#) can transmit data to any other client without authentication. *Open authentication provides no security for transmitted data.*
 - Shared Key — All data transmitted over the wireless LAN is [encrypted](#). The SBG authenticates and transfers data to and from all clients having shared key authentication enabled and an identical WEP key.

For optimal security, we recommend changing the WEP keys frequently. The default is Open System.

- Encryption** Use a WEP key length that is compatible with your wireless client adapters. Choose *one* of:
- Enable 64-Bit — Use only if you have wireless clients that do not support 128-bit encryption
 - Enable 128-Bit — The recommended setting for stronger encryption; supported by the Motorola PCC11b wireless card, USB11b wireless adapter, and most current wireless adapters
 - Disable WEP — Recommended during network setup *only*

- Key 1 to Key 4** Sets the active WEP key. You can enter up to four 64-bit or 128-bit WEP *keys* containing the non-case-sensitive [hexadecimal](#) characters 0 to 9 and A to F. Only *one* key can be active:
- For 64-bit encryption, the key must be 10 characters long.
 - For 128-bit encryption, the key must be 26 characters long.

- 4 If necessary, click Reset Wireless Defaults to reset the wireless defaults.
- 5 Click **Save Changes** to save your changes.

Configuring Wireless Clients

For each wireless client computer (station), install the wireless client card or adapter — such as a Motorola PCC11b wireless card or Motorola USB11b wireless adapter — following the instructions supplied with the card or adapter.

Configure the card or adapter to obtain an IP address automatically. The Motorola PCC11b wireless card and Motorola USB11b wireless adapter are supplied with a client configuration program called Wireless Client Manger, which is installed in the Windows Startup group.

If Wireless Client Manager is running, the  icon is displayed on the Windows task bar. Double-click the icon to launch the utility.

To distinguish it from other nearby IEEE 802.11b wireless LANs, each wireless LAN is identified by a unique network name (also known as a network identifier or ESSID). When prompted for the network identifier, network name, or ESSID, type the *name* set in the ESSID field on the Wireless > NETWORK window in the SBG Setup Program. For more information, see “[Configuring a Unique Wireless Network Name](#)” on page 68.

After you specify the network name, the wireless card or adapter automatically scans for an [IEEE 802.11b access point](#) such as the SBG1000 and the proper channel and data rate.

If shared key authentication is enabled and a WEP key is set on the SBG1000 as described in “[Configuring Basic Wireless LAN Security](#)” on page 69, you must enter the same WEP key on the wireless client. The SBG1000 cannot authenticate a client if:

- Shared key authentication is enabled on the SBG1000 but not on the client
- The client WEP key does not match the SBG1000 WEP key

Caution!



If shared key authentication is not enabled and no WEP key is set, there is no security for wireless data. You must configure the same WEP key on the SBG1000 and all wireless [clients](#).

After you correctly set the network name and WEP key on the client computer, you should be able to use it to surf the Internet.

Wireless Pages in the SBG Setup Program

Use the Wireless pages to control and monitor the wireless interface:

- [Wireless > STATUS Page](#) (see page 71)
- [Wireless > NETWORK Page](#) (see page 72)
- [Wireless > SECURITY — basic Page](#) (see page 73)
- [Wireless > SECURITY — advanced Page](#) (see page 74)
- [Wireless > STATISTICS page](#) (see page 75)

*For some settings, after you edit the field and click Apply, you are warned that you must **Reboot** for your change to take effect. Rebooting takes 10 to 15 seconds. After rebooting, you must log-in again.*

Wireless > STATUS Page

Use this page to view the wireless interface status.

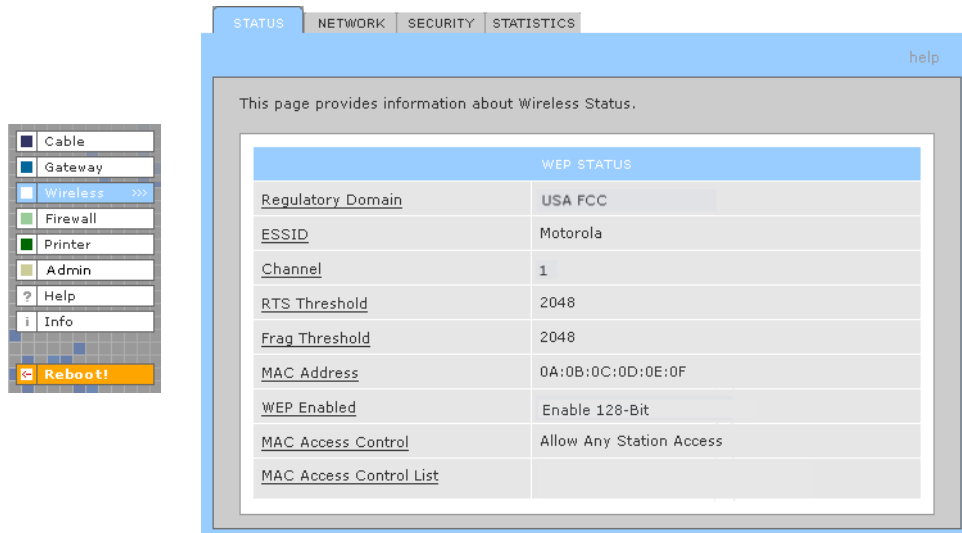

Wireless > STATUS Page Fields

- Regulatory Domain** Indicates the country the SBG is manufactured for. The list of channels depends on the country's standards for operation of IEEE 802.11b devices. Depending on the domain set at the factory, you may see FCC USA, Europe, Spain, France, Japan, or some other country name in this field.
- ESSID (Network Name)** Displays the network name set on Wireless > Network page. For more information, see "[Configuring a Unique Wireless Network Name](#)" on page 68.
- Channel** Displays the radio channel for the access point. If you encounter interference, you can set a different channel on the [Wireless > NETWORK Page](#) (see page 72).
- RTS Threshold** Displays the RTS Threshold set on the [Wireless > NETWORK Page](#).
- Fragmentation Threshold** Displays the Fragmentation Threshold set on the [Wireless > NETWORK Page](#).
- MAC Address** Displays the SBG MAC address.
- WEP Enabled** Displays the type of Wired Equivalent Privacy (WEP) that is enabled. For more information, see "[Configuring Basic Wireless LAN Security](#)" on page 69.
- MAC Access Control** Displays the state of MAC access control setting. It is set on the [Wireless > SECURITY — advanced Page](#) (see page 74).
- Allow Listed — Only IEEE 802.11b stations in the MAC access control list can access the wireless LAN.
 - Allow Any Station Access — Any 802.11b station can access the wireless LAN.
- MAC ACCESS CONTROL LIST** Displays the [MAC addresses](#) of wireless clients having access. The list is set on the [Wireless > SECURITY — advanced Page](#).

Wireless > NETWORK Page

Use this page to configure wireless LAN settings.

You can use the Motorola SBG1000 Wireless Cable Modem Gateway to operate an IEEE 802.11b wireless LAN without changing its default settings.

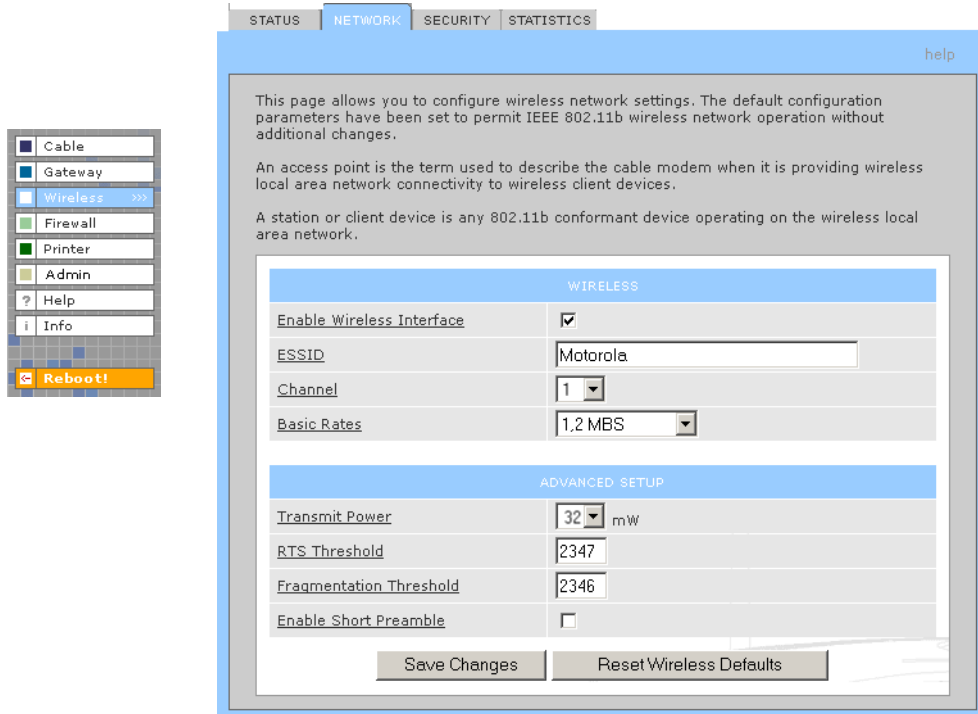

Wireless > NETWORK page fields

Field	Description
Enable Wireless Interface	Check this box to enable the wireless interface.
ESSID	Sets a unique identifier to associate wireless clients with the SBG access point. This distinguishes between multiple wireless LANs in the same area. All clients on wireless LAN must have the same Network Name as the access point. It can be any alphanumeric, case-sensitive string up to 32 characters. The default is "Motorola." <i>We strongly recommend not using the default.</i>
Channel	Sets the wireless radio channel. You can change the channel if you encounter interference on the default channel. The default is 1 (one), except in countries where the first channel permitted for IEEE 802.11b wireless operation is not one.
Basic Rate	Sets the wireless data transmission rates that all wireless LAN clients must be able to receive: <ul style="list-style-type: none"> • 1, 2 Mbps. The SBG1000 attempts to transmit at 2 Mbps. Use this setting if the wireless LAN has only legacy IEEE 802.11b clients. • 1, 2, 5.5, and 11 Mbps. The SBG1000 attempts to transmit at 11 Mbps. If there are obstacles or interference, it automatically steps down to the highest rate that allows transmission. Use this setting if the wireless LAN has fully-compliant IEEE 802.11b clients. The default is 1, 2, 5.5, 11 Mbps.

Wireless > NETWORK page fields (continued)

Field	Description
Transmit Power	Sets the transmit power on the SBG1000 wireless access point — 1, 2, 5, 10, 25, 50, or 100 mW. The default is 32 mW. Transmit power control is an optional IEEE 802.11b feature.
RTS Threshold	The Request To Send Threshold sets the packet size at which the access point issues an RTS before sending the packet. A low RTS can help when many clients are associated with the SBG1000 or when the clients are far apart and can detect the SBG1000 but not each other. The value can be 0 to 2347 bytes. The default is 2347.
Fragmentation Threshold	Sets the size at which packets are fragmented (sent as several packets instead of as one packet). A low Fragmentation Threshold can help when communication is poor or when there is a significant interference. The default is 2346. The value can be 256 to 2346 bytes.
Enable Short Preamble	Short preamble can improve throughput when the SBG1000 access point and associated clients operate at 2, 5.5, or 11 Mbps. If you enable short preamble, be sure all wireless clients also support short preamble. Short preamble is an optional IEEE 802.11b feature that is useful if maximum throughput is important and interoperability with legacy IEEE 802.11b equipment is not required. The default is Disabled.

Wireless > SECURITY — basic Page

Use this page to configure basic Wired Equivalent Privacy (WEP) settings.

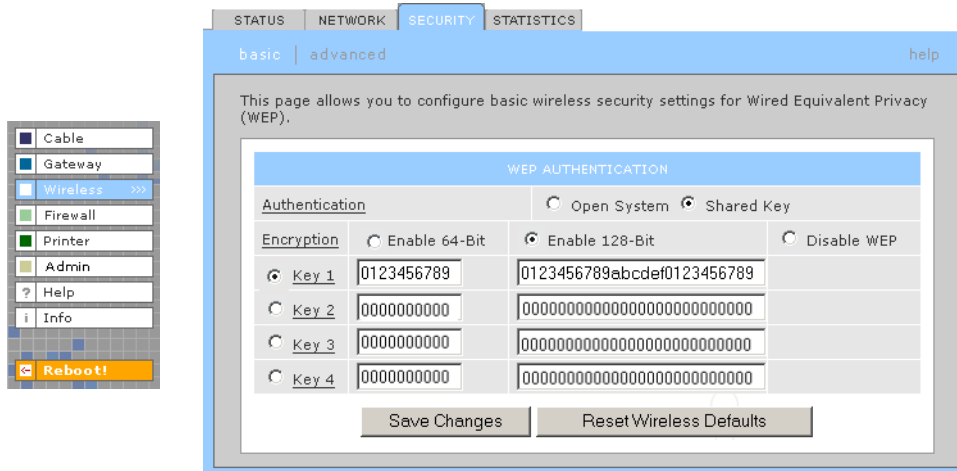

CAUTION!



The default Authentication setting of Disable WEP provides no security for transmitted data.

For information about using this page, see “Configuring Basic Wireless LAN Security” on page 69.

Wireless > SECURITY — advanced Page

Use this page to configure advanced wireless security settings.

Wireless > Security — ADVANCED page fields

Field or Button	Description
-----------------	-------------

Closed Network	If you enable closed network operation, only wireless clients configured with the Network Name can associate with the SBG1000. Closed network operation is a SBG enhancement to IEEE 802.11b. The default is Disabled.
-----------------------	--

MAC ACCESS CONTROL LIST	The MAC access control list restricts wireless LAN access to identified 802.11b station MAC addresses. Up to five 802.11b station MAC addresses can be entered.
--------------------------------	---

Allow Any Station Access	Any 802.11b station can access the wireless network.
---------------------------------	--

Allow Only Listed Stations	Only 802.11b stations in the MAC access control list can access the wireless network.
-----------------------------------	---

Apply	Click to apply your changes.
--------------	------------------------------

Listed Stations	Displays stations that have restricted wireless access by their MAC addresses .
------------------------	---

Delete	Click to select a station to be removed from the control list.
---------------	--

Wireless > Security — ADVANCED page fields (continued)

Field or Button	Description
New Station	Enter the MAC address of a station that you want to add to the list of allowed stations.
Add Station	Click to add the new station.

Wireless > STATISTICS page

Use this page to display wireless statistics.

The screenshot shows a web interface with a navigation menu on the left and a main content area. The main content area is titled 'STATISTICS' and contains a table of WEP Security statistics. The table has two columns: the field name and the count. Below the table are 'Refresh' and 'Clear' buttons.

WEP SECURITY	
Transmitted Fragment Count	5672
Multicast Transmitted Fragment Count	5193
Failed Count	0
Retry Count	10003
Multiple Retry Count	0
Frame Duplicate Count	0
Request to Send Success Count	0
Request to Send Failure Count	0
Acknowledge Failed Count	17
Received Fragment Count	0
Multicast Received Fragment Count	26
Frame Check Sequence Error Count	1
Transmitted Frame Count	5672
WEP Undecryptable Count	0

Wireless > STATISTICS page fields

Field or Button	Description
Transmitted Fragment Count	The number of acknowledged MAC protocol data units (MPDUs) with an address in the address 1 field or an MPDU with a multicast address in the address 1 field of type data or management.
Multicast Transmitted Fragment Count	The number of transmitted fragments when the multicast bit is set in the destination MAC address of a successfully transmitted MAC service data unit (MSDU). When operating as a STA in an ESS, where these frames are directed to the AP, this implies having received an acknowledgment to all associated MPDUs.
Failed Count	The number of MSDUs not transmitted successfully because the number of transmit attempts exceeded the IEEE 802.11b short or long retry limit.
Retry Count	The number of successfully transmitted MSDUs after one or more retransmissions.
Multiple Retry Count	The number of successfully transmitted MSDUs after more than one retransmission.

Wireless > STATISTICS page fields (continued)

Field or Button	Description
Frame Duplicate Count	The number of frames received where the Sequence Control field indicated the frame was a duplicate.
Request To Send Success Count	The number of CTS messages received in response to RTS messages.
Request To Send Failure Count	The number of CTS messages not received in response to RTS messages.
Acknowledgement Failed Count	The number of acknowledgment messages not received when expected from a data message transmission.
Received Fragment Count	The number of successfully received MPDUs of type Data or Management.
Multicast Received Fragment Count	The number of MSDUs received when the multicast bit was set in the destination MAC address.
Frame Check Sequence Error Count	The number of FCS errors detected in a received MPDU.
Transmitted Frame Count	The number of successfully transmitted MSDUs.
WEP Undecryptable Count	This number of frames received with the WEP subfield of the Frame Control field set to one and the WEPOn key value mapped to the client MAC address. This indicates that the frame should not have been encrypted or that frame was discarded due to the receiving client not having WEP enabled.
Refresh	Click to collect new data.

❖ Configuring the Print Server

The SBG1000 print server supports a printer connected to its printer port using Microsoft, UNIX (Linux), or Apple printing. Configuring printing consists of:

- [Configuring the SBG1000 Print Server](#)
- Connecting the printer to the SBG1000 as shown in “[Installation](#)” on page 19
- Adding a printer to each PC following *one* of:
 - “[Adding a Printer in Windows 98 or Windows Me](#)” on page 80
 - “[Adding a Printer in Windows 2000](#)” on page 86

Configuring the SBG1000 Print Server

- 1 Start the SBG Setup Program as described in “[Starting the SBG Setup Program](#)” on page 32.
- 2 On the left frame, click Printer to display the Printer CONFIGURATION > basic page:

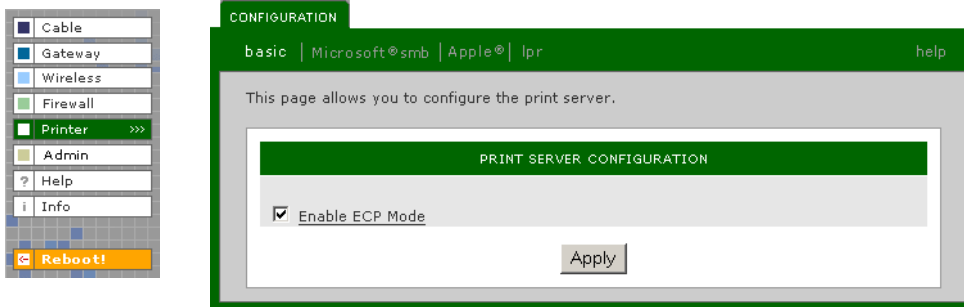

- 3 (Optional) For a printer that supports bi-directional communication, you can enable Extended Capabilities Port (ECP) Mode, which can provide a performance benefit over a standard port.
- 4 Use the following pages to configure the print server for the necessary platform(s):

Windows [Printer > CONFIGURATION — Microsoft smb Page](#) (see page 78)

Macintosh [Printer > CONFIGURATION — Apple Page](#) (see page 79)

UNIX (Linux) [Printer > CONFIGURATION — lpr Page](#) (see page 80)

- 5 Power off the SBG1000.
- 6 Connect the printer to the printer port on the SBG1000 [Rear Panel](#) as shown in “[Installation](#)” on page 19.
- 7 Power on the printer.
- 8 Power on the SBG1000. If printer configuration was successful, the printer icon displays on the SBG1000 front panel.

If the printer icon is not displayed, check the printer cable connection and power the printer and the SBG1000 off and on again. Verify that Enable printer is checked on the Printer CONFIGURATON > basic page.

Printer > CONFIGURATION — Microsoft smb Page

Use this page to configure the print server for Microsoft printing:

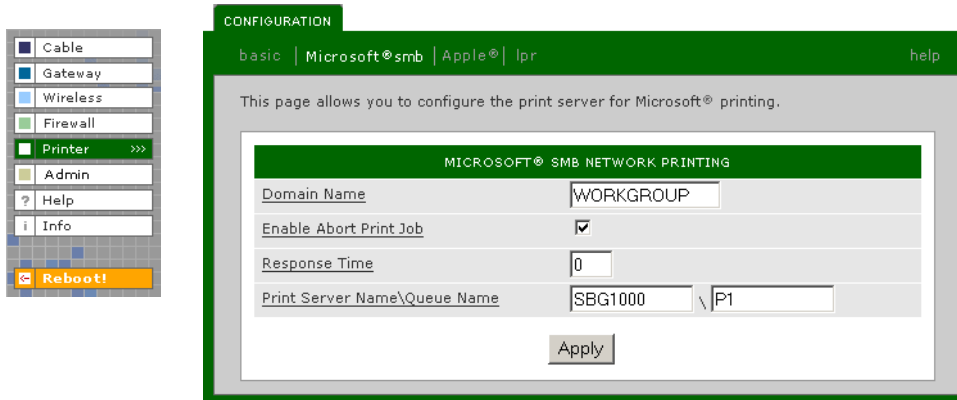

Printer > CONFIGURATION — Microsoft smb page fields

Field	Description
Domain Name	Sets the Microsoft <i>workgroup</i> for the SBG1000 print server. <i>You must use this setting for the Workgroup when you add the printer connected to the SBG1000 to each client PC running Windows.</i>
Enable Abort Print Job	Check this box to abort a print job if the printer runs out of paper. When this is disabled, the print server waits to resume printing the job until you add paper to the printer. The default is Disabled.
Response Time	Sets the response time if you need to slow down the response to a Microsoft SMB client for a slow legacy printer. The value can be from 0 (no wait) to 255 seconds. The default is 0 (zero).
Print Server Name \ Queue Name	Sets the print server name and queue.
Apply	Click to apply your changes.

Printer > CONFIGURATION — Apple Page

Use this page to configure the print server for AppleTalk printing:

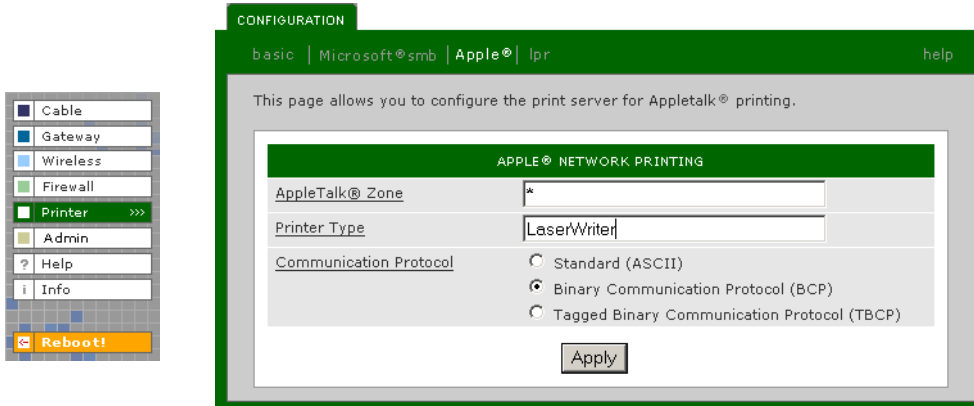

Printer > CONFIGURATION — apple page fields

Field	Description
AppleTalk Zone	Sets the AppleTalk zone having access to the print server. The zone name can be up to 32 characters long. The default "*" enables all AppleTalk zones to use the printer(s) connected to the print server.
Printer Type	Sets the printer type. The default, LaserWriter, is used for most AppleTalk printers. If you have an Epson printer that supports AppleTalk, it has a different printer type, found in the Epson printer manual or web site. The SBG1000 print server only responds to the Chooser if the AppleTalk zone and printer type are the same.
Communication Protocol	Choose Standard if the printer uses a communication protocol that supports sending and receiving ASCII data. The Standard protocol is typically supported on devices using RS-232 and centronics channels. The default is ASCII. Choose Binary Communication Protocol (BCP) if the printer can send and receive binary data. BCP is used by some devices for flow control, status request, abort job, and end of file functions. BCP can provide a significant performance advantage over ASCII printing on serial and parallel ports. Choose Tagged Binary Communication Protocol (TBCP) for a printer containing a language-independent feature to determine which language interprets a print job. TBCP is typically supported by P.J.L printers. To determine the protocol a printer supports, see the documentation provided with the printer.
Apply	Click to apply your changes.

Printer > CONFIGURATION — lpr Page

Use this page to configure the print server for UNIX printing:

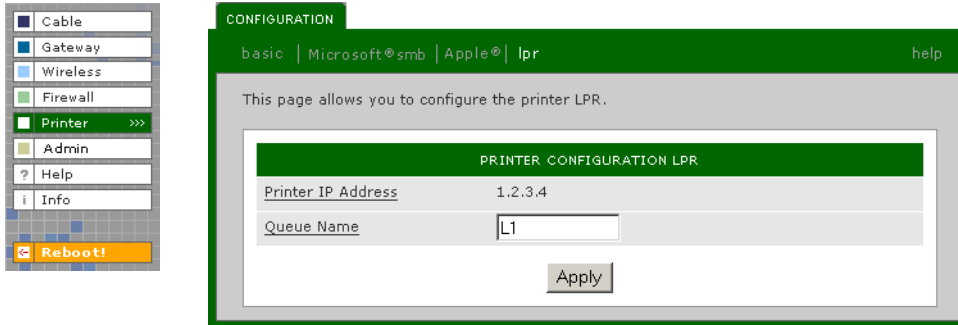

Printer > CONFIGURATION — lpr page fields

Field	Description
Printer IP Address	Displays the SBG1000 IP address; by default 192.168.100.1
Queue Name	Sets the queue name; typically lpx; where x is 0, 1, 2, ...
Apply	Click to apply your changes

Adding a Printer in Windows 98 or Windows Me

- 1 On the Windows desktop, click **Start**.
- 2 Click **Settings**.
- 3 Click **Control Panel** to display the Control Panel window:

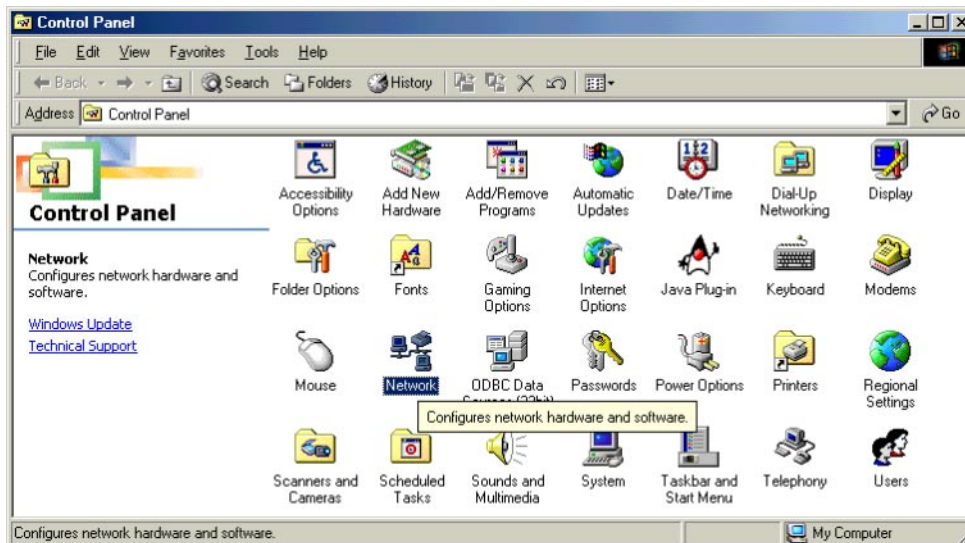

- 4 Double-click the **Network** icon to display the Network window.
- 5 Click the **Identification** tab:

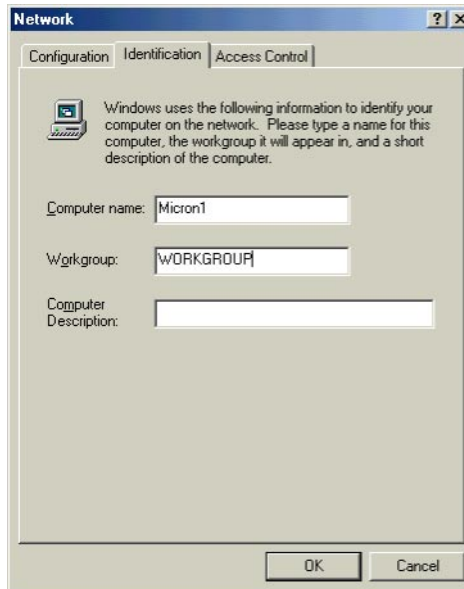

- 6 In the **Workgroup** field, type the Workgroup name. Be sure it matches the "Domain Name" configured on the SBG1000 Printer > CONFIGURATION — Microsoft smb Page (see page 78).
- 7 Click the **Configuration** tab to display the Configuration page:

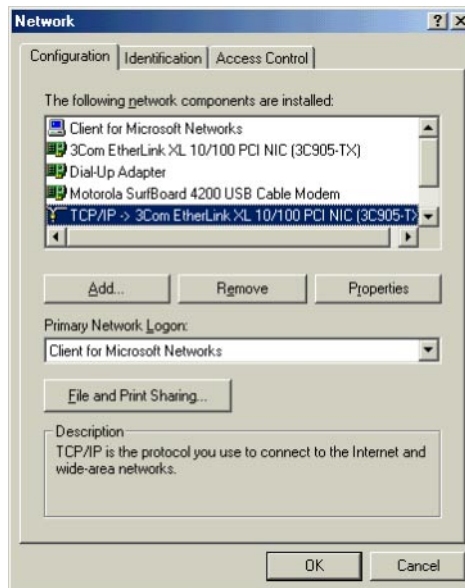

- 8 Select the TCP/IP for the SBG1000 network interface, as shown above.

- 9 Click **Properties** to display the TCP/IP Properties window:

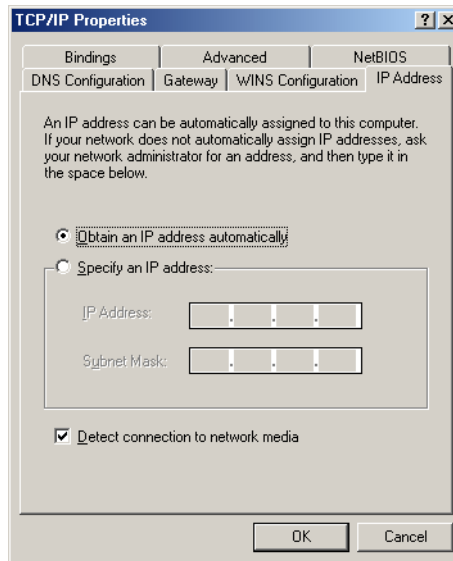

Be sure **Obtain an IP address automatically** is selected.

- 10 Click the **WINS Configuration** tab to display:

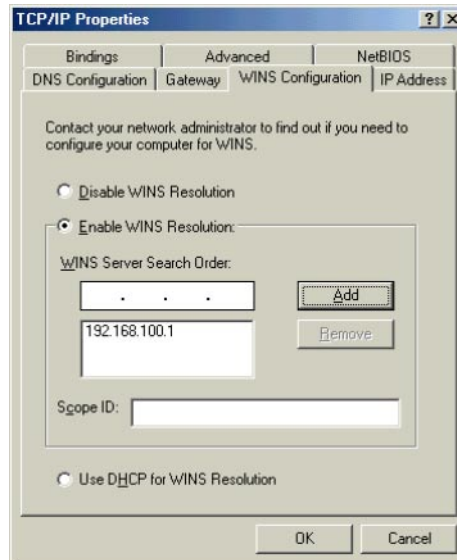

- 11 To **Enable WINS Resolution**, select its radio button.
- 12 In the **WINS Server Search Order** field, type **192.168.100.1** and click **Add**.
- 13 Click **OK** to exit the TCP/IP Properties window.
- 14 Click **OK** to exit the Network window.
- 15 On the Windows desktop, click **Start**.
- 16 Click **Settings**.

17 Click **Printer** to display the Printers window:

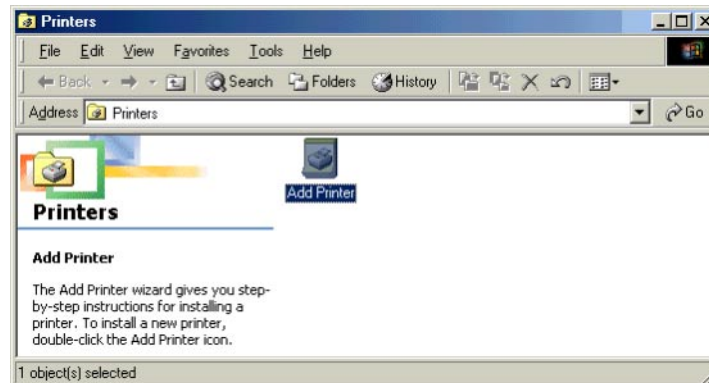

18 Double-click the **Add Printer** icon to start the Add Printer Wizard:

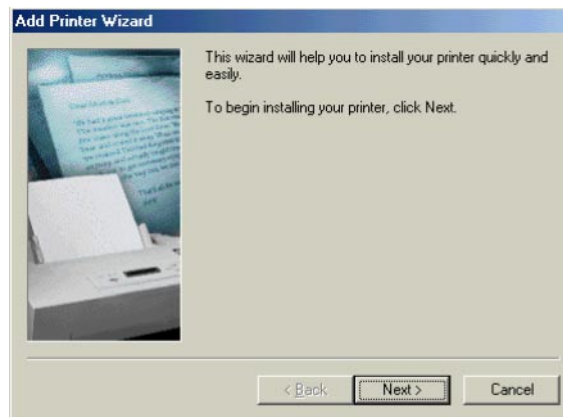

19 Click **Next**:



20 Select **Network printer** by clicking its radio button and click **Next**:

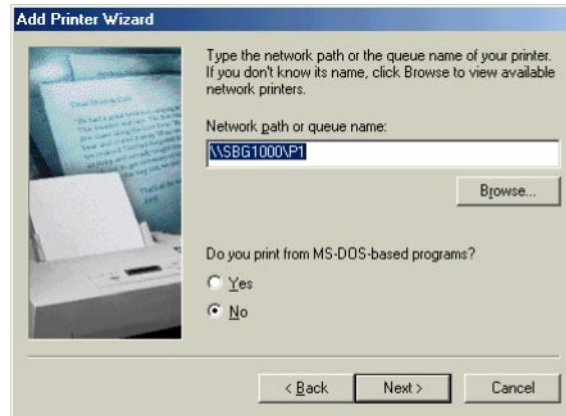

21 In the **Network path or queue name** field, type `\\Print Server Name\Queue Name` and click **Next**. It must match the Print Server Name\Queue Name set on the SBG1000 [Printer > CONFIGURATION — Microsoft smb Page](#) (see page 78). The default is `\\SBG1000\IP1`.

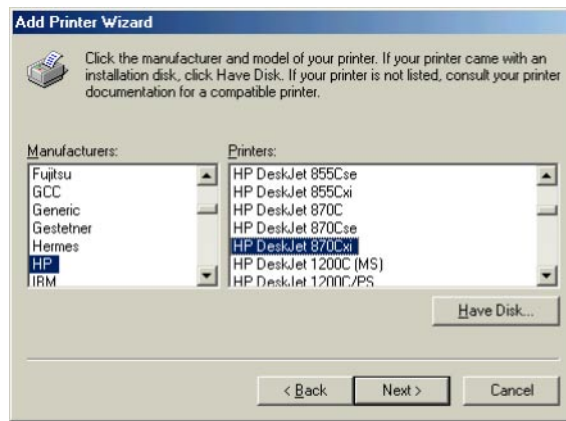

22 In the **Manufacturers** field, click the *manufacturer* of the printer connected to the SBG1000.

23 In the **Printers** field, click the printer *model*.

If your printer is not listed, its [driver](#) software is not installed in Windows on the PC. You need to provide the driver from a disk or download the driver from the Internet.

24 Click **Next**.

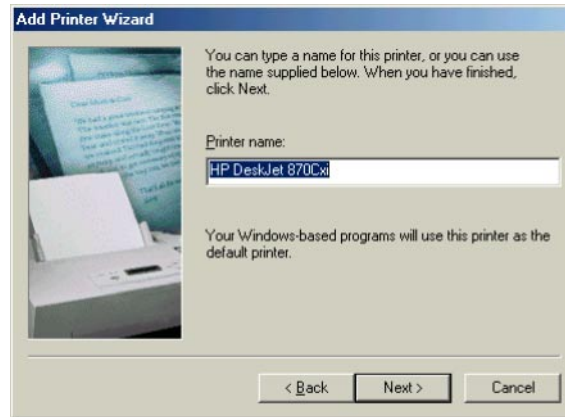

25 Click **Next** to accept the default printer name.

or

Type the *name* and click **Next**.

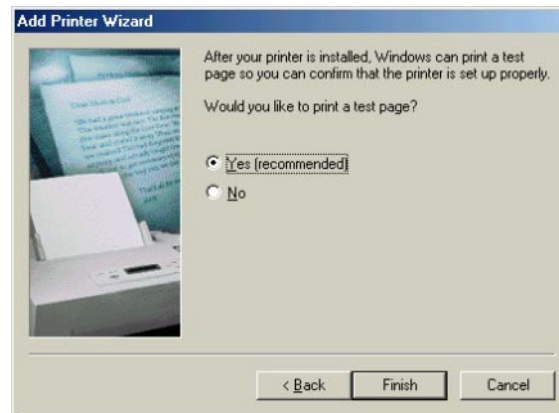

26 Click **Finish** to complete printer installation and print a test page.

Adding a Printer in Windows 2000

- 1 On the Windows desktop, click **Start**.
- 2 Click **Settings**.
- 3 Click **Control Panel** to display the Control Panel window:

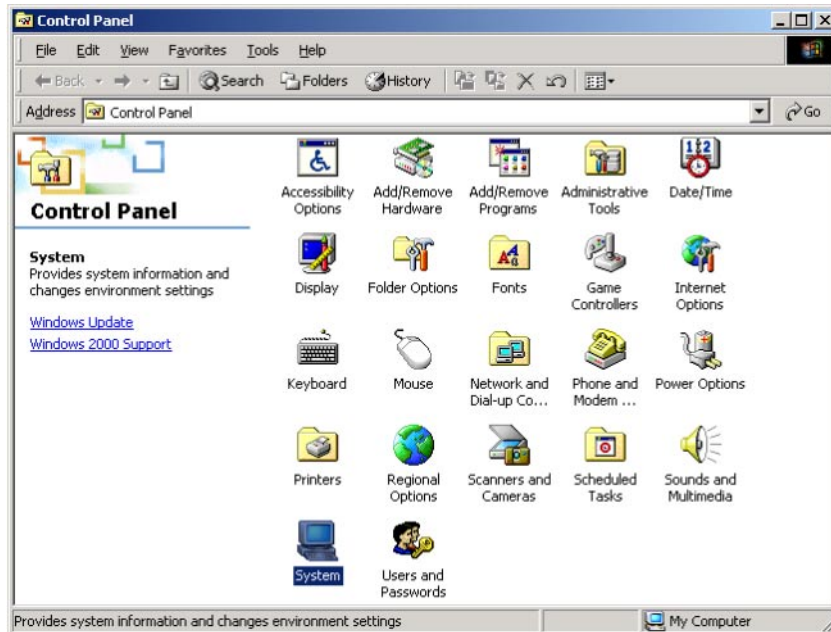

- 4 Double-click the **System** icon to display the System Properties window.
- 5 Click the **Network Identification** tab:

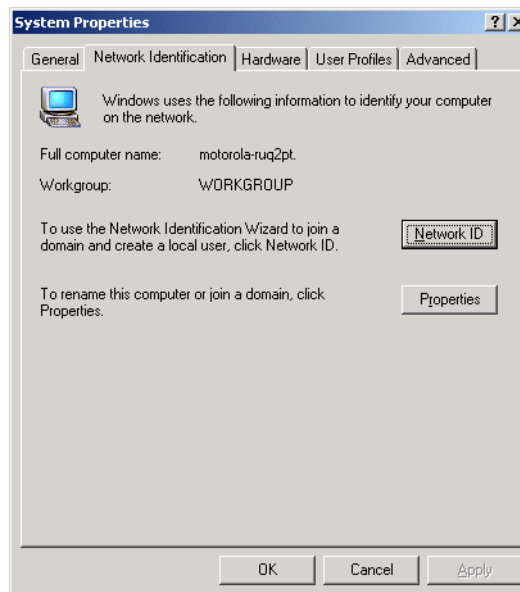

- 6 Click Properties. The Identification Changes window is displayed:

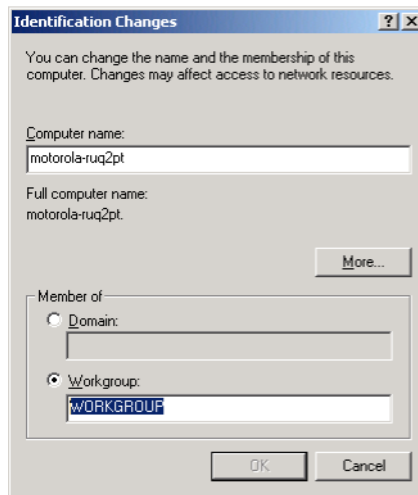

- 7 In the **Workgroup** field, type the Workgroup name. Be sure it matches the "Domain Name" configured on the SBG1000 Printer > CONFIGURATION — Microsoft smb Page (see page 78).
- 8 Click **OK**.
- 9 On the System Properties window, click **OK**. You are prompted to reboot your computer.
- 10 Click **Yes** to reboot.
- 11 After the PC reboots, click **Start**.
- 12 Click **Settings**.
- 13 Click **Control Panel** to display the Control Panel window:
- 14 Double-click the **Network and Dial-up Connections** icon.

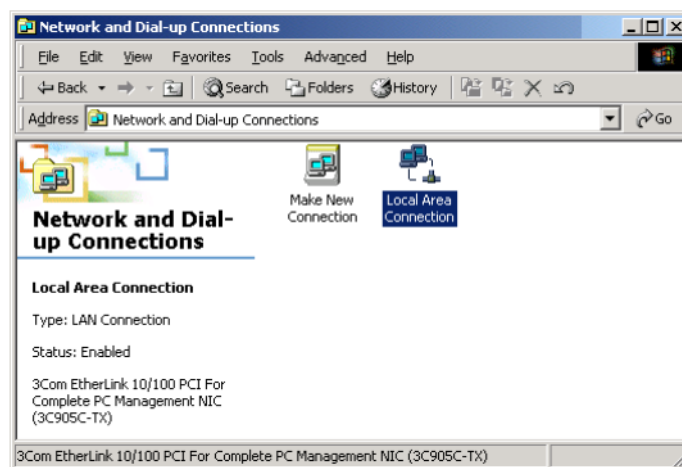

- 15 Double-click the **Local Area Connection** icon. If more than one is present, be sure you select the one connected to the SBG1000. The Local Area Connection Status window is displayed:

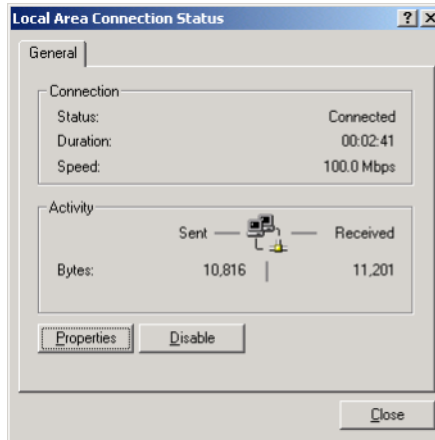

- 16 Click **Properties**. The Local Area Connection Properties window is displayed:

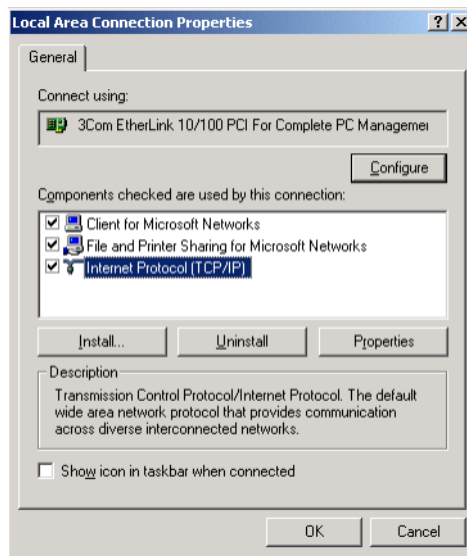

- 17 Click **Internet Protocol TCP/IP** and click the **Properties** button. The Local Area Connection Properties window is displayed:

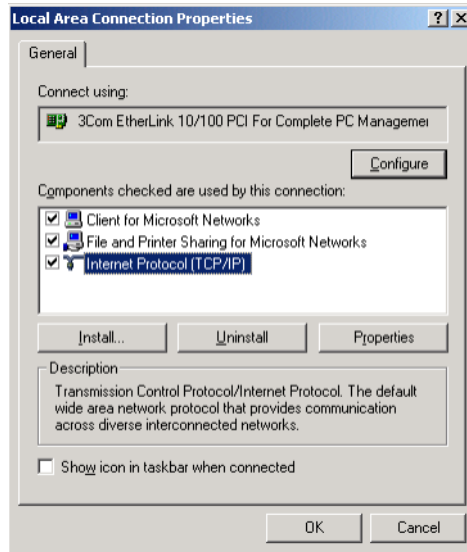

- 18 Click **Properties**. The Internet Protocol (TCP/IP) Properties window is displayed:

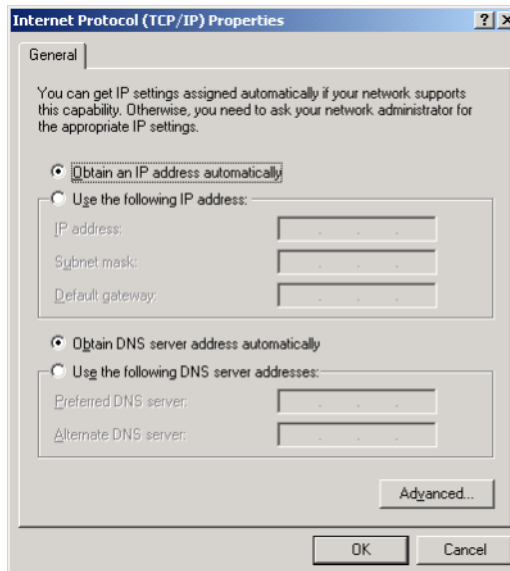

Be sure **Obtain an IP address automatically** is selected.

- 19 Click **Advanced** to display the Advanced TCP/IP Settings window.

20 Click the **WINS** tab:

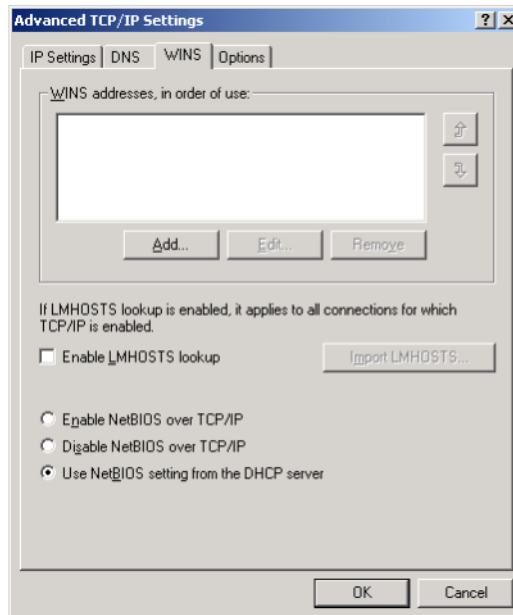

21 Click **Add**. The TCP/IP WINS Server window is displayed:

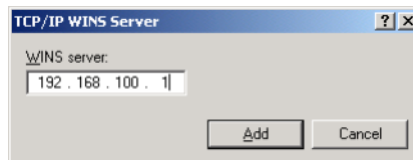

22 In the **WINS server** field, type **192.168.100.1** click **Add**.

23 Click **OK** three times to close the Advanced TCP/IP Settings window, the Internet Protocol (TCP/IP) Properties window, and the Local Area Connection Properties window.

24 Click **Start**.

25 Click **Settings**.

26 Click **Printers** to display the Printers window:

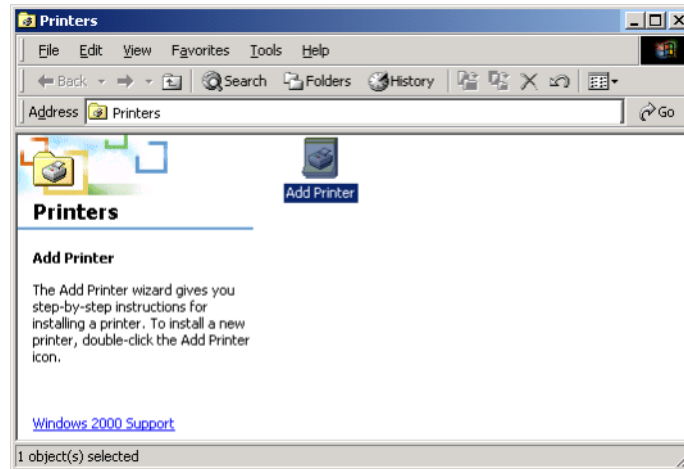

27 Double-click the **Add Printer** icon to start the Add Printer Wizard:



28 Click **Next**:

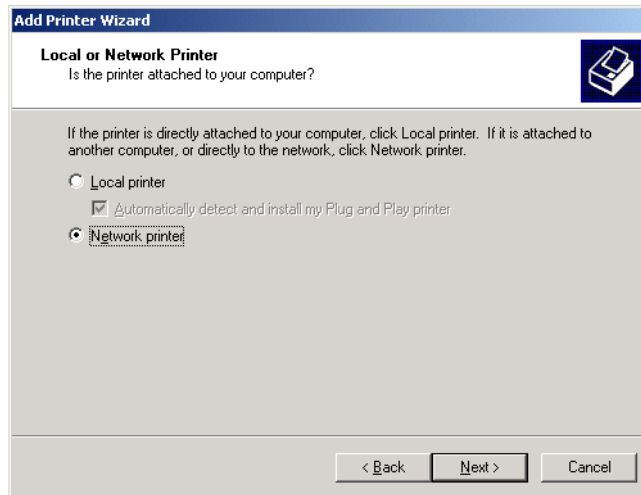

29 Click the **Network printer** radio button to select it and click **Next**:

30 Click **Next** to browse the network for the SBG1000 printer. This step will fail but is necessary.

31 Click **Back** to return to the following window:

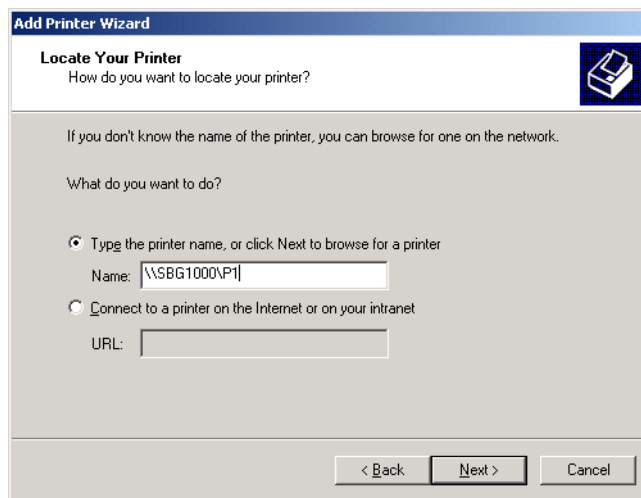

32 In the **Type the printer name,...** field, type `\\Print Server Name\Queue Name` and click **Next**. It must match the Print Server Name\Queue Name set on the SBG1000 [Printer > CONFIGURATION — Microsoft smb Page](#) (see page 78). The default is `\\SBG1000\P1`.

If a message such as the following displays, indicating that the printer driver is not present, insert the driver disk provided with your printer in the drive and click **OK**.

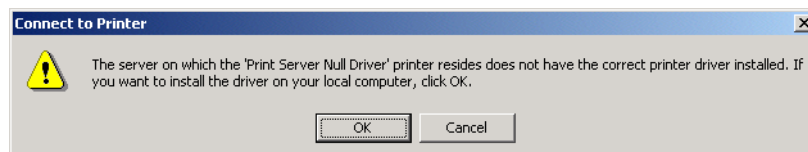

The following message should display:

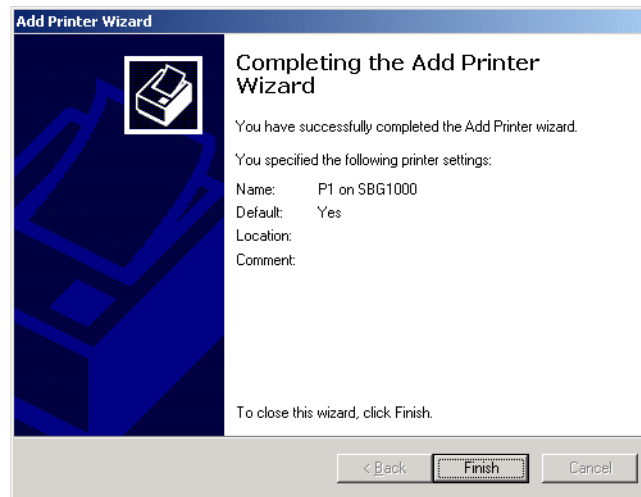

33 Click **Finish** to complete printer installation.

Setting Up a USB Driver

The following subsections describe setting up a USB driver if you connect a PC to the USB port on the SBG. Perform one of the following procedures based on your Windows version:

- [“Setting Up a USB Driver in Windows 98”](#) on page 96
- [“Setting Up a USB Driver in Windows 2000”](#) on page 100
- [“Setting Up a USB Driver in Windows Me”](#) on page 103
- [“Setting Up a USB Driver in Windows XP”](#) on page 104

The SBG1000 USB driver does not support Macintosh or UNIX computers. For those systems, you can connect through Ethernet *only*.

CAUTION!



Be sure the Motorola SBG1000 Wireless Cable Modem Gateway CD-ROM is inserted in the CD-ROM drive before you plug in the USB cable.

If you have a problem setting up the USB driver, remove it by performing *one* of the following procedures:

- [“Removing the USB Driver from Windows 98 or Windows Me”](#) on page 105
- [“Removing the USB Driver from Windows 2000”](#) on page 108
- [“Removing the USB Driver from Windows XP”](#) on page 111

Setting Up a USB Driver in Windows 98

Be sure the Motorola SBG1000 Wireless Cable Modem Gateway CD-ROM is inserted in the CD-ROM drive before you plug in the USB cable. This CD contains the USB drivers and must be inserted and read by the PC before you connect the SBG1000 to the PC.

A few seconds after you complete the USB connection, the Add New Hardware Wizard window is displayed:



1 Click **Next**. The following window is displayed:



Be sure “Search for the best driver for your device” is selected.

- 2 Click **Next**. The following window is displayed:



Be sure “CD-ROM drive” is the only box checked.

- 3 Click **Next**. The message “Please wait while Windows searches for a new driver for this device” is displayed. If the computer successfully locates the driver, you can skip to step 6. If the computer does not locate the driver, the previous window is displayed again.
- 4 Select **Specify a location** and type the location of the CD-ROM drive:



To load the driver successfully, you may need to click **Browse** to manually select the NetMotCM.sys file on the CD-ROM.

- 5 Click **Next**. The following window is displayed:



- 6 Select **The updated driver...** and click **Next**. If the following window is not displayed, verify that the *Motorola SBG1000 Wireless Cable Modem Gateway* CD-ROM is properly inserted in the CD-ROM drive. If you still cannot find the correct driver file, click **Cancel** to cancel the installation and perform the procedure for [“Removing the USB Driver from Windows 98 or Windows Me”](#) on page 105. Then repeat this procedure.

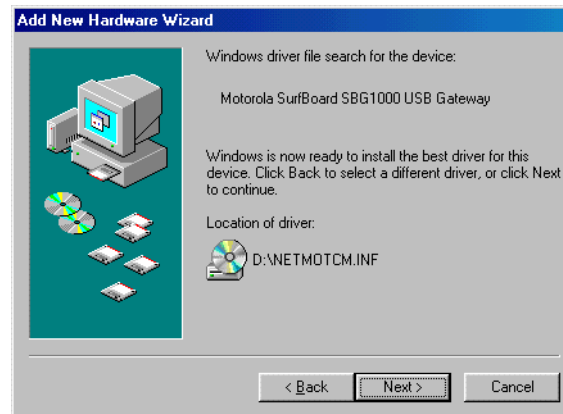

Although your SBG model number may be different than in the images in this guide, the procedure is the same.

- 7 After the window shown under step 6 is displayed, click **Next**.

If a window with the message *Copying Files...* displays and asks for the CD-ROM drive, type the CD-ROM drive *letter* (for example, "D:") and click **OK**.

If an Insert Disk window similar to the one below is displayed, Windows 98 system files are needed to complete the installation. To install the files, insert your Windows 98 CD-ROM in the CD-ROM drive and click **OK**.

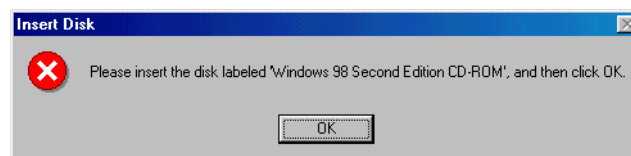

After all the necessary files are loaded, the following window is displayed to confirm a successful installation:



- 8 Click **Finish**. The Systems Settings Change window is displayed:

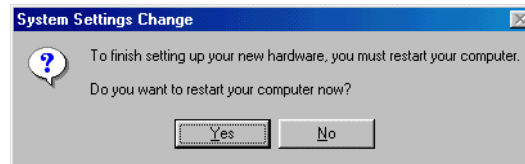

- 9 Click **Yes** to restart the computer.

When you finish setting up the USB driver, you can continue with [“Configuring TCP/IP”](#) on page 53.

If you have difficulties setting up the USB driver, perform [“Removing the USB Driver from Windows 98 or Windows Me”](#) on page 105 and repeat this procedure. If that does not correct the problem, see the *Regulatory, Safety, Software License, and Warranty Information* card provided with the SBG1000 for information about obtaining warranty service.

Setting Up a USB Driver in Windows 2000

Be sure the *Motorola SBG1000 Wireless Cable Modem Gateway* CD-ROM is inserted into the CD-ROM drive before you plug in the USB cable. A few seconds after you complete the USB connection, the Found New Hardware window is displayed:



1 Click **Next**. The following window is displayed:



Although your SBG model number may be different than in the images in this guide, the procedure is the same.

Be sure "Search for a suitable driver for my device" is selected.

- 2 Click **Next**. The following window is displayed:

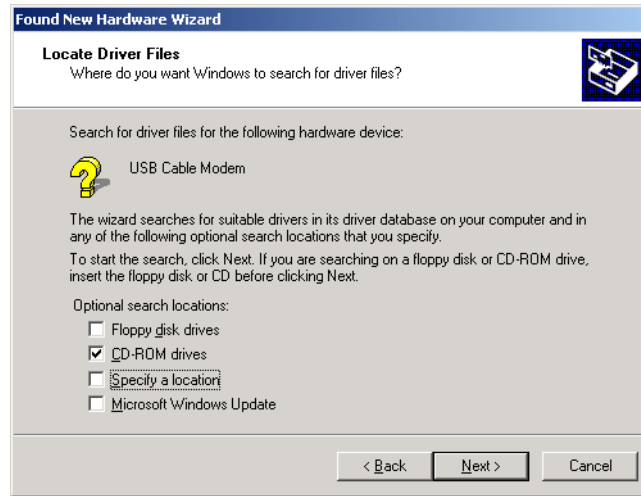

Be sure "CD-ROM drives" is the only box checked.

- 3 Click **Next**. The following window is displayed:

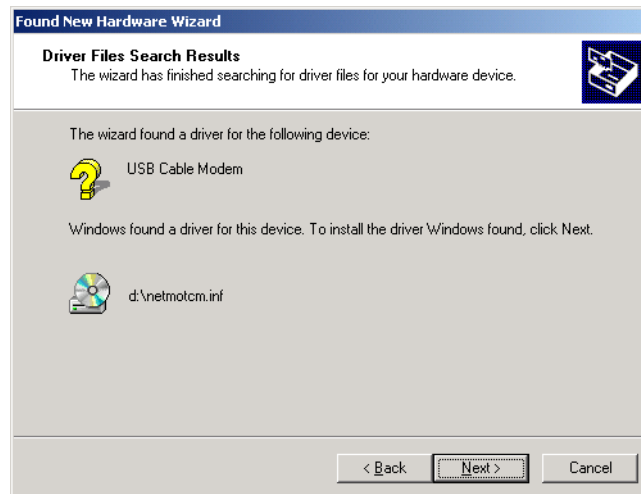

- 4 Click **Next**.

If the Insert Disk window is displayed, be sure the *Motorola SBG1000 Wireless Cable Modem Gateway* CD-ROM is in the CD-ROM drive and follow steps 5 to 10. Otherwise, you can skip to step 11.

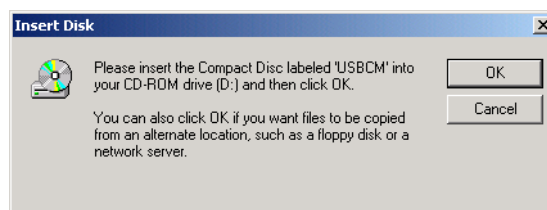

- 5 On the Insert Disk window, click **OK**. The Files Needed window is displayed:

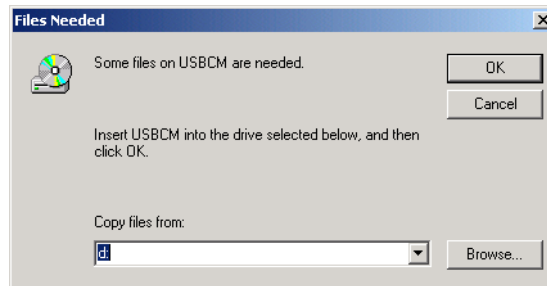

- 6 If necessary, select the CD-ROM drive in the Copy files from list.
- 7 Click **Browse**.
- 8 Locate the NetMotCM.sys file in the CD-ROM root directory.
- 9 Double-click the **NetMotCM.sys** file. The Files Needed window is displayed.
- 10 Click **OK**. The Found New Hardware Wizard window is displayed:

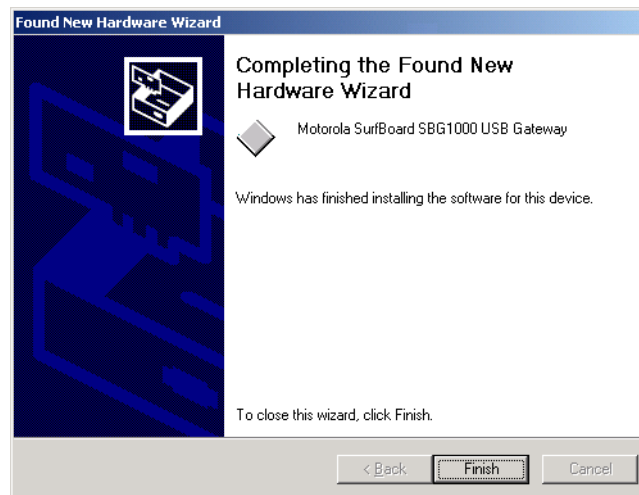

- 11 Click **Finish** to complete the installation.

When you finish setting up the USB driver, you can continue with ["Configuring TCP/IP"](#) on page 53.

If you have any difficulties setting up the USB driver, perform ["Removing the USB Driver from Windows 2000"](#) on page 108 and repeat this procedure.

Setting Up a USB Driver in Windows Me

Be sure the *Motorola SBG1000 Wireless Cable Modem Gateway* CD-ROM is inserted into the CD-ROM drive before you plug in the USB cable. A few seconds after you complete the USB connection, the Add New Hardware Wizard window is displayed:



- 1 Click **Next**. Windows automatically searches for the correct USB drivers and installs them. If the installation is successful, the following window is displayed:



Although your SBG model number may be different than in the images in this guide, the procedure is the same.

- 2 If the window above is displayed, click **Finish**. Otherwise, be sure the *Motorola SBG1000 Wireless Cable Modem Gateway* CD-ROM is correctly inserted in the CD-ROM drive.

When you finish setting up the USB driver, you can continue with "[Configuring TCP/IP](#)" on page 53.

Setting Up a USB Driver in Windows XP

Be sure the *Motorola SBG1000 Wireless Cable Modem Gateway* CD-ROM is inserted into the CD-ROM drive before you plug in the USB cable. A few seconds after you complete the USB connection, the Found New Hardware Wizard window is displayed:



- 1 Be sure "Install the software automatically" is selected.
- 2 Click **Next**. Windows automatically searches for the correct USB drivers and installs them. If the installation is successful, the following window is displayed:



Although your SBG model number may be different than in the images in this guide, the procedure is the same.

- 3 Click **Finish** to complete the installation. Otherwise, be sure the *Motorola SBG1000 Wireless Cable Modem Gateway* CD-ROM is correctly inserted in the CD-ROM drive.

When you finish setting up the USB driver, you can continue with "[Configuring TCP/IP](#)" on page 53.

Removing the USB Driver from Windows 98 or Windows Me

- 1 On the Windows Desktop, right-click *one* of:
 - In Windows 98, the **Network Neighborhood** icon
 - In Windows ME, the **My Network Places** icon

The Network window is displayed:

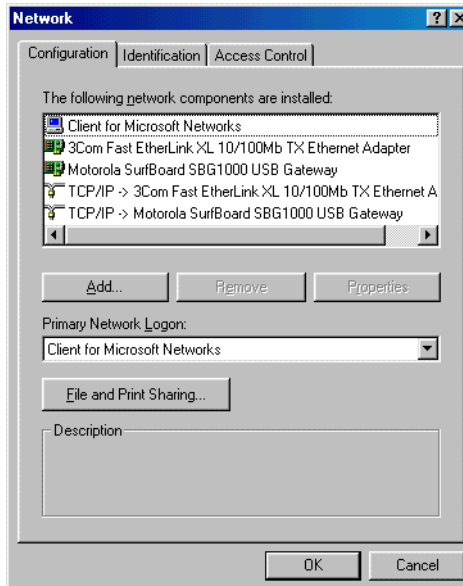

Although your SBG model number may be different than in the images in this guide, the procedure is the same.

- 2 Click the **Motorola SurfBoard SBG1000 USB Gateway**.

- Click **Remove**. The Network window no longer displays Motorola SurfBoard SBG1000 USB Gateway in the list:

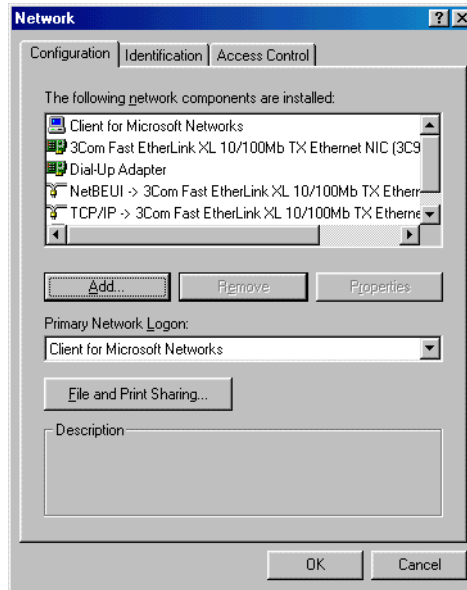

- Click **OK**. The System Settings Change window is displayed:

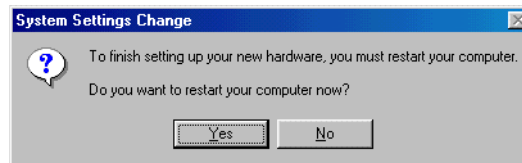

- Disconnect the USB cable from the PC or SBG1000.
- Click **Yes** to restart the computer.
- Insert the *Motorola SBG1000 Wireless Cable Modem Gateway* CD-ROM in the CD-ROM drive. After a short time, a window with language choices is displayed.
- Press the **Esc** key on the keyboard to exit the start-up screens.
- To start Windows Explorer, click **Start** and select **Run**.

10 In the Run window, type **explorer** and click **OK**. The Exploring window is displayed:

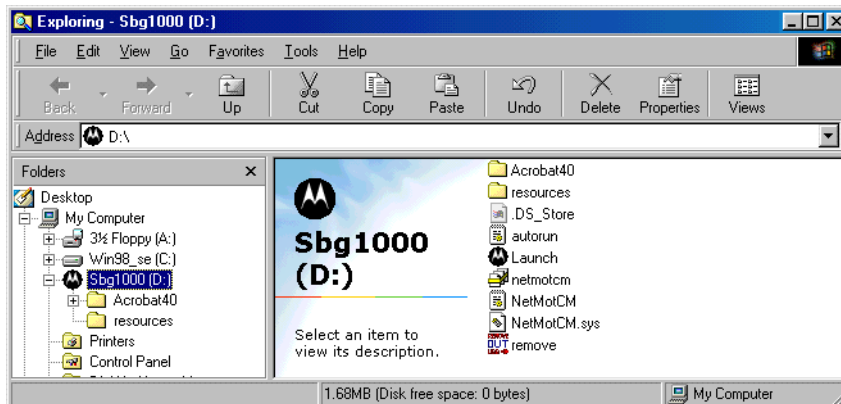

Windows Explorer may appear different than in the image. There are variations between Windows versions and you can configure Windows Explorer as you like.

- 11 Double-click the **Motorola SBG1000** CD-ROM drive (D: in the image above).
- 12 Double-click **remove** or **remove.exe** to run the Remove utility from the *Motorola SBG1000 Wireless Cable Modem Gateway* CD-ROM. The SURFboard Cable Modem USB Driver Removal window is displayed:

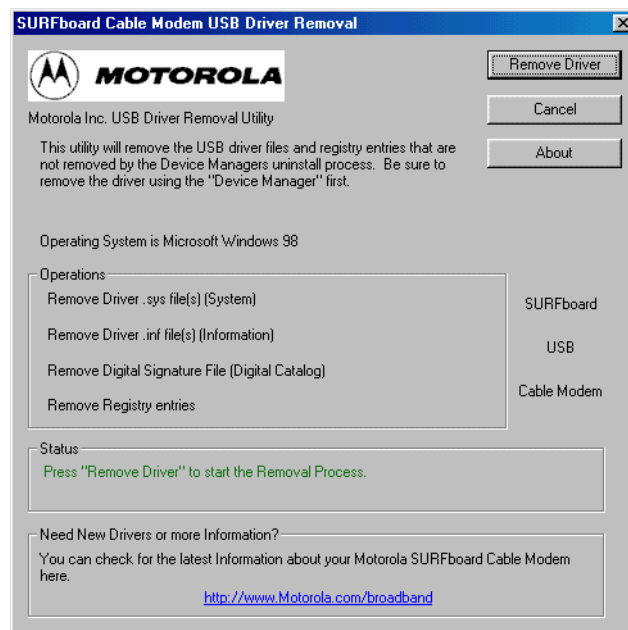

13 Click **Remove Driver**.

After you remove the USB driver, re-install it on the computer:

- “Setting Up a USB Driver in Windows 98” on page 96
- “Setting Up a USB Driver in Windows Me” on page 103

If you continue to have problems, contact your cable service provider.

Removing the USB Driver from Windows 2000

- 1 On the Windows desktop, click **Start**.
- 2 Click **Settings**.
- 3 Click **Control Panel** to display the Control Panel window:

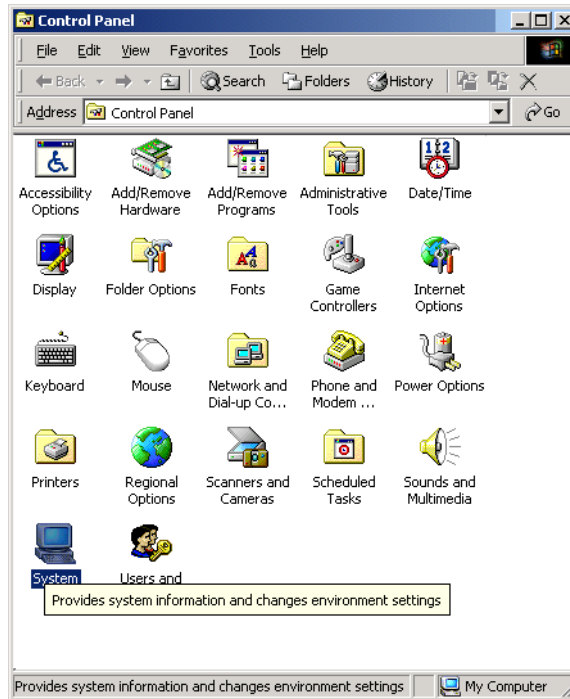

- 4 Double-click **System** to display the System Properties window:

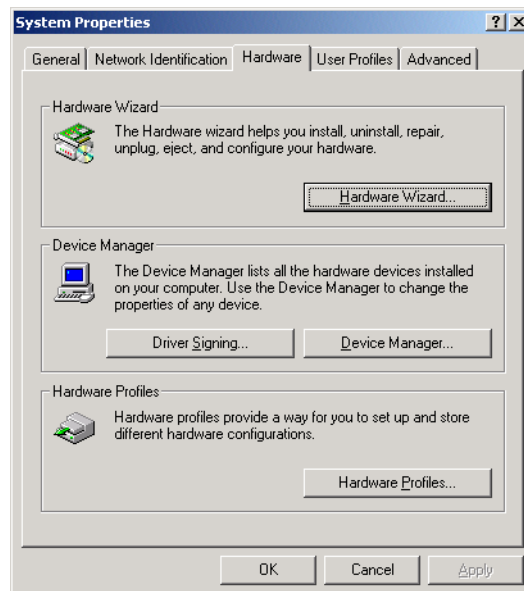

- 5 On the System Properties window, click the **Hardware** tab.
- 6 Click the **Device Manager** button to display the Device Manager window:

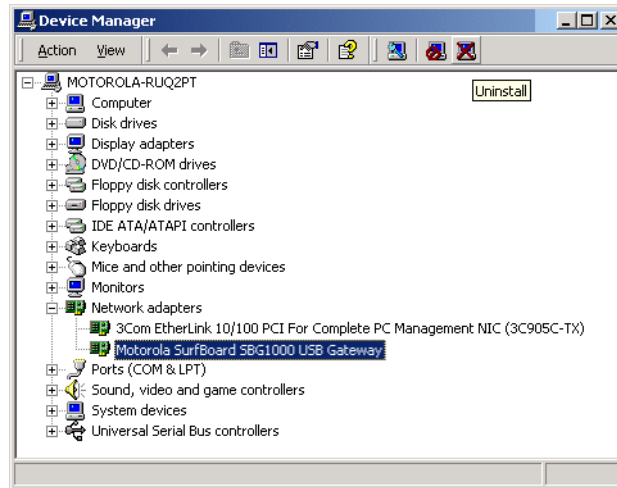

Although your SBG model number may be different than in the images in this guide, the procedure is the same.

- 7 On the Device Manager window, double-click **Network Adapters**.
- 8 Click the **Motorola SurfBoard SBG1000 USB Gateway**. The Uninstall icon displays on the window near the top.
- 9 Click the **Uninstall** icon. The following window is displayed:



- 10 Click **OK**.
- 11 Close the Device Manager window.
- 12 Close the Control Panel window.
- 13 Insert the *Motorola SBG1000 Wireless Cable Modem Gateway* CD-ROM in the CD-ROM drive. After a short time, a window with language choices is displayed.
- 14 Press the **Esc** key on the keyboard to exit the start-up screens.
- 15 To start Windows Explorer, click **Start** and select **Run** to display the Run window.

- 16 On the Run window, type **explorer** and click **OK** to display Windows Explorer:

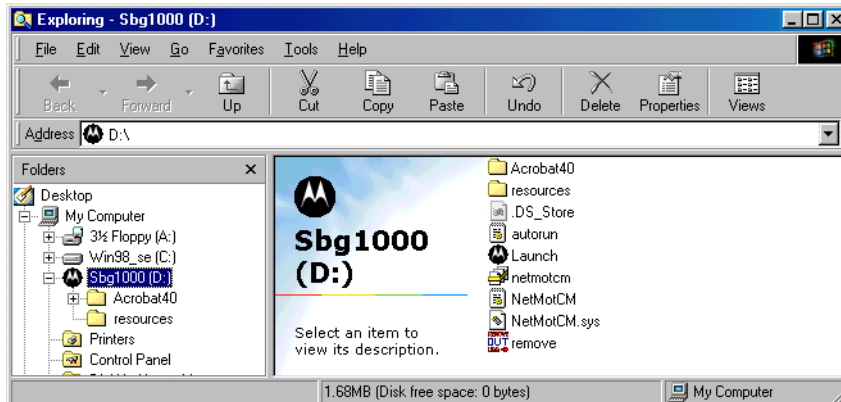

Windows Explorer may appear different than in the image. There are variations between Windows versions and you can configure Windows Explorer as you like.

- 17 Double-click **My Computer**.
- 18 Double-click the **Motorola SBG1000** CD icon (D: in the image).
- 19 Double-click **remove** or **remove.exe** to run the Remove utility from the *Motorola SBG1000 Wireless Cable Modem Gateway* CD-ROM. The SURFboard Cable Modem USB Driver Removal window is displayed:

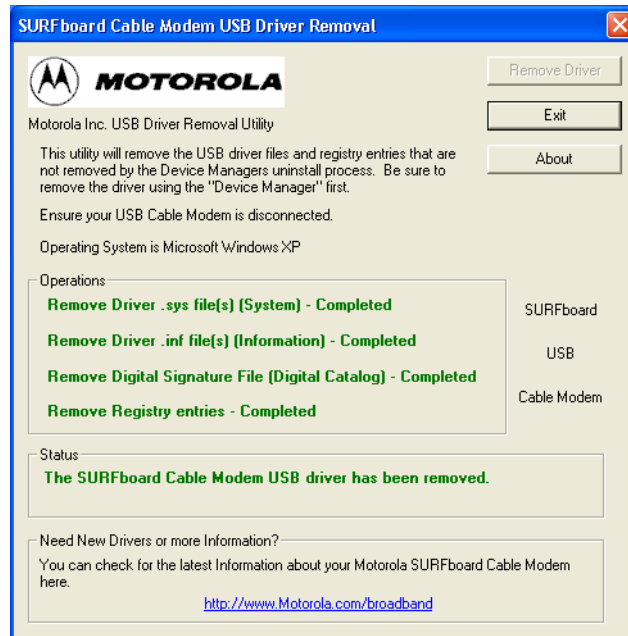

- 20 Be sure the USB cable is disconnected.
- 21 Click **Remove Driver**.

Informational messages similar to the ones shown are displayed on the SURFboard Cable Modem USB Driver Removal window.

After you remove the USB driver, re-install it following “[Setting Up a USB Driver in Windows 2000](#)” on page 100. If you continue to have problems, contact your cable service provider.

Removing the USB Driver from Windows XP

- 1 On the Windows desktop, click **Start** to display the Start window:

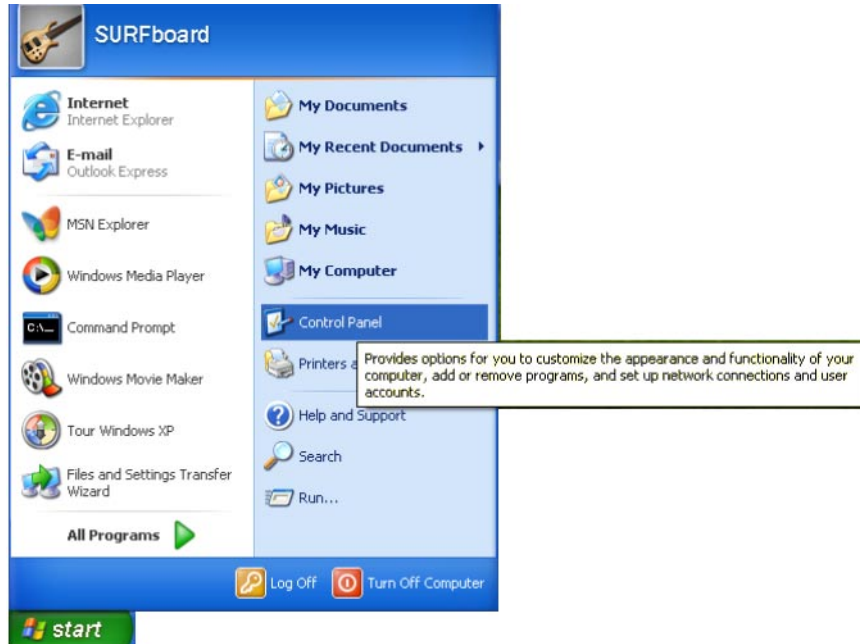

- 2 Click **Control Panel** to display the Control Panel window. The display varies, depending on the Windows XP view options:

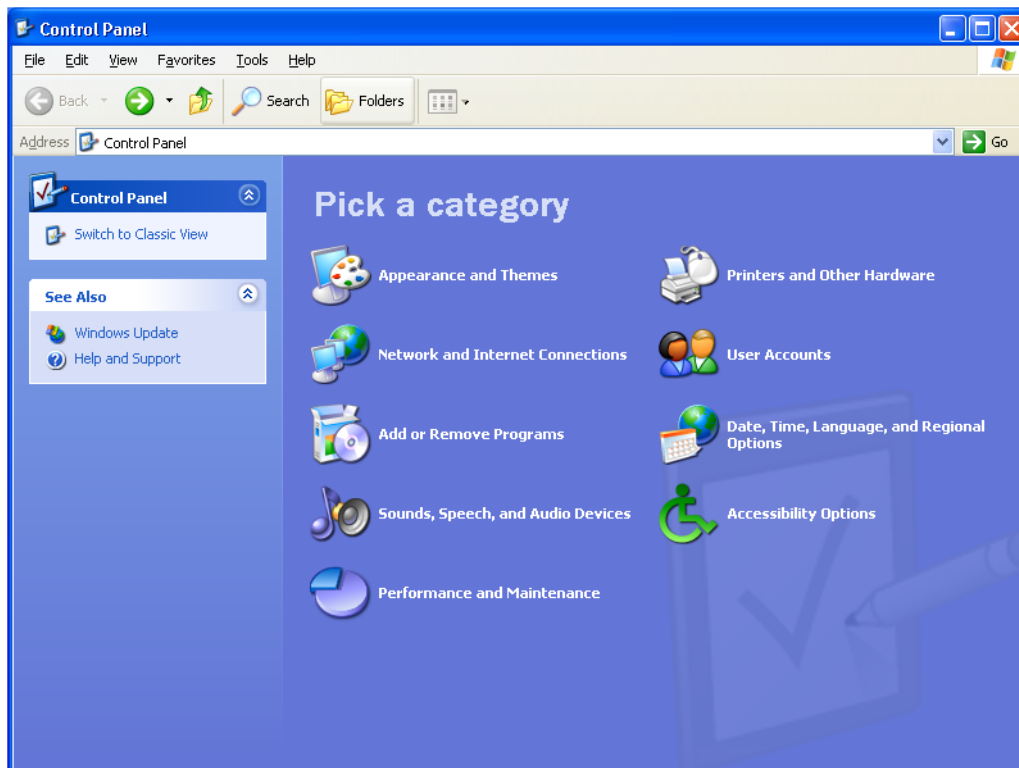

- 3 If a Category view similar to the image under step 2 is displayed, click **Performance and Maintenance** to display the Performance and Maintenance window. Otherwise, skip to step 5.

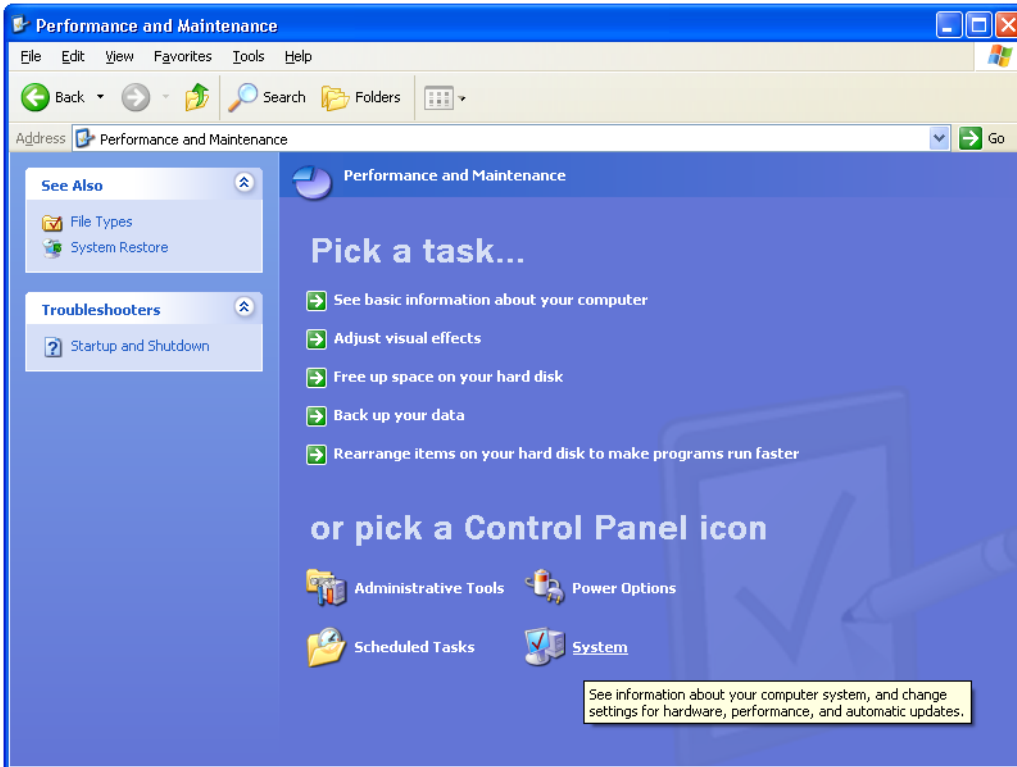

- 4 Click **System** to display the System Properties window. Skip to step 6.

- 5 If a classic view similar to the following is displayed, click System to display the System Properties window:

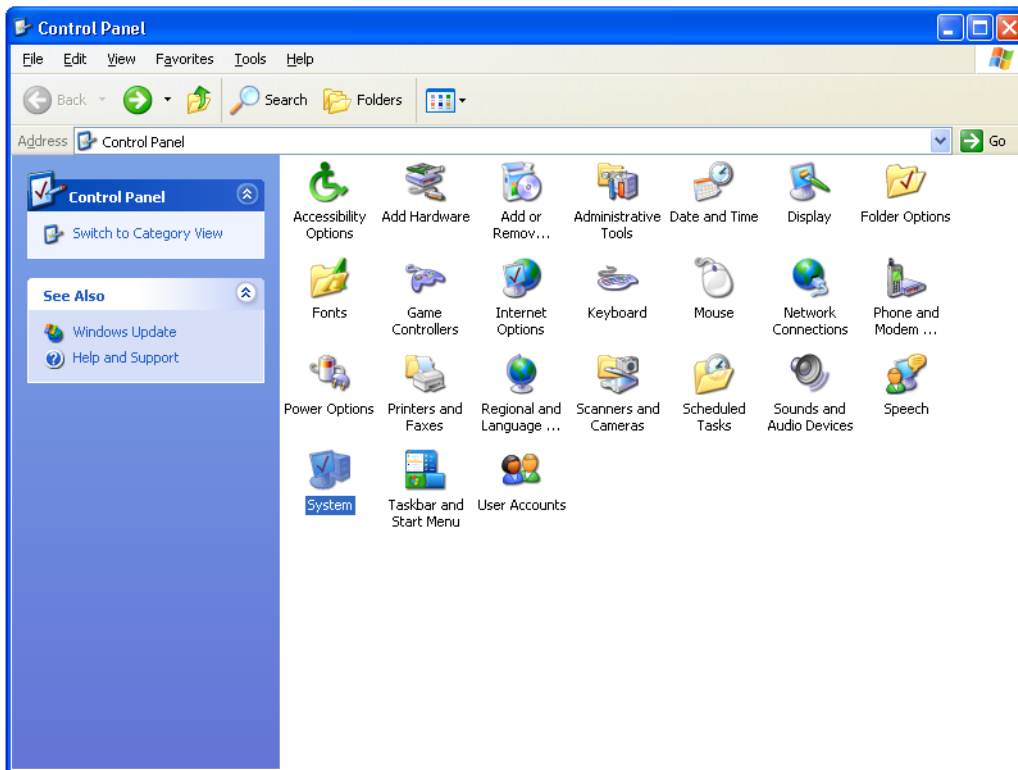

- 6 On the System Properties window, click the **Hardware** tab to display the Hardware page:

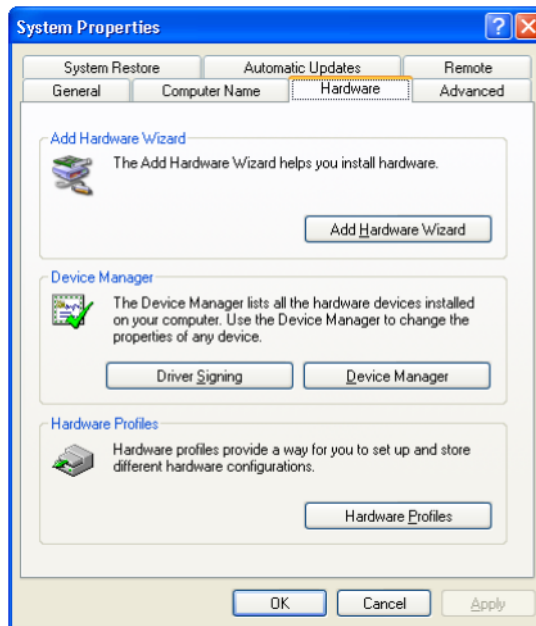

- 7 Double-click the **Device Manager** button to display the Device Manager window:

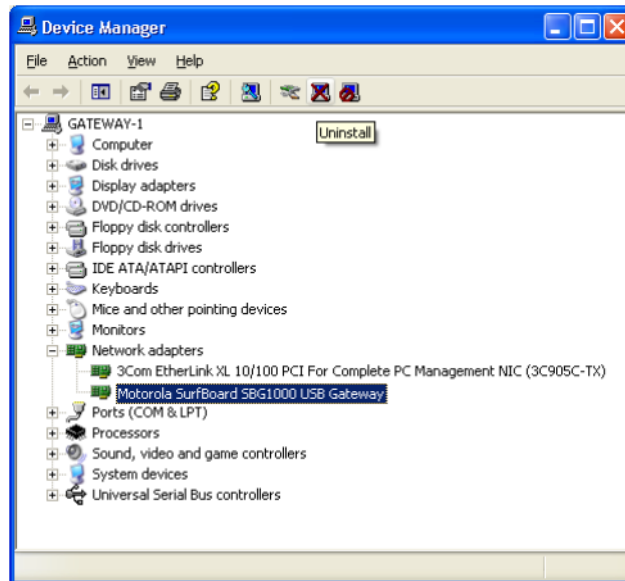

Although your SBG model number may be different than in the images in this guide, the procedure is the same.

- 8 Double-click **Network adapters**.
- 9 Click the **Motorola SurfBoard SBG1000 USB Gateway**. The Uninstall icon displays on the window near the top.
- 10 Click the **Uninstall** icon.
- 11 Close the Device Manager and Control Panel windows.
- 12 Insert the *Motorola SBG1000 Wireless Cable Modem Gateway* CD-ROM in the CD-ROM drive. After a short time, a window with language choices is displayed.
- 13 Press the **Esc** key on the keyboard to exit the start-up screens.
- 14 To start Windows Explorer, click **Start** and select **Run** to display the Run window.

15 Type **explorer** and click **OK** to display Windows Explorer.

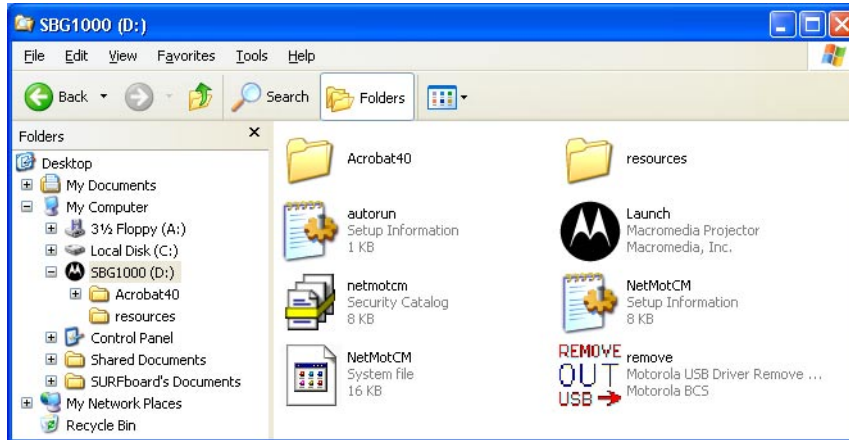

Windows Explorer may appear slightly different than in the image. There are variations between Windows versions and you can configure Windows Explorer as you like.

16 Double-click **My Computer**.

17 Double-click the **Motorola** CD icon (D: in the image).

18 Double-click **remove** or **remove.exe** to run the Remove utility from the *Motorola SBG1000 Wireless Cable Modem Gateway* CD-ROM. The SURFboard Cable Modem USB Driver Removal window is displayed:

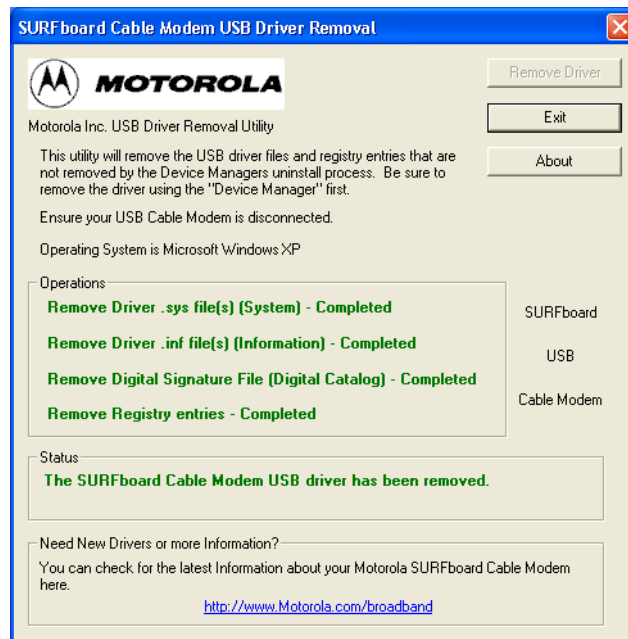

19 Be sure the USB cable is disconnected.

20 Click **Remove Driver**. Informational messages similar to the ones shown are displayed on the SURFboard Cable Modem USB Driver Removal window.

After you remove the USB driver, re-install it following [“Setting Up a USB Driver in Windows XP”](#) on page 104. If you continue to have problems, contact your cable service provider.

Troubleshooting

If the solutions listed here do not solve the problem, contact your cable service provider. Before calling your cable service provider, try pressing the reset button on the rear panel. Resetting the SBG1000 may take 5 to 30 minutes. Your service provider may ask for the status of the front-panel lights as described in [Front-Panel Lights and Error Conditions](#).

Problem	Possible Solutions
Green power icon light is off	<ul style="list-style-type: none"> Check that the power cord is properly plugged into the electrical outlet and the SBG1000. Check that the electrical outlet is working. Press the Reset button.
Cannot send or receive data	<ul style="list-style-type: none"> On the top front panel, note which is the first light (starting from the left) that is off. This light indicates where the error occurred as described in the Front-Panel Lights and Error Conditions table. If you have cable TV, check that the TV is working and the picture is clear. If you cannot receive regular TV channels, the data service will not function. Check the coaxial cable at the SBG1000 and wall outlet. Hand-tighten if necessary. Check the IP address. Follow the steps for Setting Up a USB Driver for your system. Call your cable service provider if you need an IP address. Check that the Ethernet cable is properly connected to the SBG1000 and the computer.
Problems related to unsuccessful USB driver installation	<ul style="list-style-type: none"> Remove the USB driver. Follow the appropriate procedure for your system in "Setting Up a USB Driver" on page 95.
The printer icon is not displayed	<ul style="list-style-type: none"> Check the printer cable connection and power the printer and SBG1000 off and on again. Verify that Enable printer is checked on the Printer CONFIGURATION > basic page.

Front-Panel Lights and Error Conditions

Light	Turns Off During Startup If	Turns Off During Normal Operation If
RX (receive)	The receive channel cannot be acquired	The receive channel is lost
TX (transmit)	The send channel cannot be acquired	The send channel is lost
LNK light is not on	IP registration is unsuccessful	The IP registration is lost
Green power icon light is off	The SBG1000 is not properly plugged into the power outlet	The SBG1000 is unplugged

For more information about the lights, see "[Front Panel](#)" on page 6.

Contact Us

In the United States and Canada, if you need assistance while working with the SBG1000 and related equipment, call **1-800-942-7721** for technical and warranty support. Support is available 24 hours a day, seven days a week.

For information about customer service, technical support, or warranty claims, see the *Regulatory, Safety, Software License, and Warranty Information* card provided with the SURFboard SBG1000.

For answers to typical questions, see "[Frequently-Asked Questions](#)" on page 121.

For more information about Motorola consumer cable products, education, and support, visit <http://www.motorola.com/broadband>.

Frequently-Asked Questions

Here are answers to questions our customers frequently ask:

Q What is high-speed cable Internet access?

A Cable Internet access uses cable television wires instead of telephone lines to connect to the Internet. It is extremely fast and does not tie up telephone lines for incoming or outgoing calls and faxes.

Q How fast is the Motorola SBG1000 Wireless Cable Modem Gateway?

A Cable modems offer Internet access at speeds up to 100 times faster than a traditional phone modem. You can experience speeds of over 1,000 Kbps. Due to network condition such as traffic volume and the speed of the sites you visit, actual speed may vary. Many network and other factors can affect download speeds.

Q How many users can one SBG support?

A A single SBG can support up to 245 users, each assigned a unique IP address, on a class C network.

Q What is Network Address Translation?

A NAT is a technique to translate private IP addresses on your LAN to a single IP address assigned by your cable service provider that is that is visible to outside users on the Internet.

Q What is IEEE_802.11b?

A [IEEE 802.11b](#) is the IEEE wireless network standard.

Q What type of firewall is provided on the SBG1000?

A The SBG1000 provides a [stateful-inspection](#) firewall.

Q What wireless security measures are provided on the SBG1000?

A To protect data transmitted over wireless connections, the SBG1000 supports [WEP](#) encryption and [MAC](#) access control lists. For information, see "[Setting Up the Wireless LAN](#)" on page 67.

Q Why is there no Standby button?

A As a security measure, current Motorola SURFboard cable modems provide a Standby button to temporarily suspend the Internet connection. Because the SBG [firewall](#) provides high security levels while connected, the Standby button is not required.

Q Can I still watch cable TV while using my Motorola SBG1000 Wireless Cable Modem Gateway?

A Yes, your cable TV line can carry the TV signal while you send and receive information on the Internet.

Q What are CableLabs Certified, DOCSIS, and Euro-DOCSIS?

A CableLabs Certified, DOCSIS, and Euro-DOCSIS are the industry standards for high-speed data distribution over cable television system networks. They are intended to ensure that all compliant SBGs interface with all compliant cable systems. Your SBG1000 is DOCSIS or Euro-DOCSIS certified.

Q If I have an SBG1000, can I still use my old 28.8 Kbps or 56 Kbps modem?

A Yes you can. However, once you've experienced the speed of cable Internet access, you'll never again want to wait for traditional dial-up services.

Q Do I need to change my Internet service provider (ISP)?

A Currently, most Internet service providers do not provide cable Internet access. Contact your cable company for your specific information.

Q Do I need to subscribe to cable TV to get cable Internet access?

A No, but you will need to subscribe to cable Internet service. Some systems require that you subscribe to basic service before you can get Internet access and/or offer a discount when you use your own SBG1000. Check with your local cable company for specific information.

Q What type of technical support is available?

A For questions about your Internet service, connection, or SBG1000, call your cable service provider.

Q What do I do if my SBG stops working?

A “[Troubleshooting](#)” on page 117 provides tips to diagnose problems and simple solutions. If you continue to have problems, call your cable service provider.

Q Can multiple game players on the SBG LAN log onto the same game server and play simultaneously with just one public IP address?

A It depends on the game server.

Specifications

General Specifications

Wireless

Standards Compliance	IEEE 802.11, 802.11b Direct Sequence Spread Spectrum - DSSS
RF Frequency Range	Range 2.4 to 2.4835 GHz, 2.4 to 2.497 GHz for Japan
Data Rate	Auto, 11, 5.5, 2, and 1 Mb/s
Modulation	Auto 11 and 5.5 Mb/s = CCK, 2 Mb/s = DQPSK, 1 Mb/s = DBPSK
Number of channels	Europe = 13, Spain = 2, France = 4, US = 11, Japan = 14
Transmit Power	17.5 dBm (EIRP)
Receive Sensitivity	-83 dBm at 11 Mbps

Router

Ethernet Standards Compliance	IEEE 802.3, IEEE 802.3u
Number of Ports	5
Number of Uplink Ports	5

Electrical

Input Voltage Range	-100 – 240 VAC, 50 – 60 Hz
Power Consumption	18 Watts

Print Server	Windows, Mac, Linux
---------------------	---------------------

Environmental

Operating Temperature	0° C – 40° C, -150 to 10000 ft.
Storage Temperature	-30° C to 80° C
Humidity	5 to 95% (non-condensing)
Mechanical Antenna	2 External Articulating Antennas, with Unique Connectors per FCC Requirements

LED Indicators

Modem	Modem Receive, Send, Online, Internet
Router (each port 1 – 5)	Activity, 10/100, Half/Full, Link
Access Point	Wireless
Other	USB, Power, Model Number

Interfaces	(1) AC Power, (1) F-Type, (5) RJ-45, (2) RJ-11, (1) DB-25
-------------------	---

Dimensions	290 W x 160 D x 70 H (mm)
-------------------	---------------------------

Weight	0.8 lbs (Unit Only)
---------------	---------------------

Cable Modem Specifications

Downstream

Modulation	64 QAM or 256 QAM
Maximum Data rate	38 Mbps maximum
Frequency	88 MHz to 860 MHz (30 kHz minimum step size)
Bandwidth	6 MHz
Symbol rate:	
64 QAM	5.069 Msym/s maximum
256 QAM	5.361 Msym/s maximum
Operating Level Range	-15 dBmV to +15 dBmV
Input impedance	75 ohms (nominal)
Frequency Range	88 to 860 MHz

Upstream

Modulation	16 QAM or QPSK (variable symbol rates)
Maximum Data Rate	10 Mbps maximum
Bandwidth	200 kHz to 3200 kHz
Frequency	5 MHz to 42 MHz (edge to edge)
Symbol rates	160, 320, 640, 1280, and 2560 ksym/s
Operating Level Range:	
16 QAM	+8 dBmV to +55 dBmV
QPSK	+8 dBmV to +58 dBmV
Output impedance	75 ohms nominal

General

Cable Interface	F-Connector, female, 75 ohm
CPE Network Interface	Interface USB, Ethernet 10/100Base-T (auto sensing)
Data protocol	TCP/IP
Dimensions	7.2" H x 2.0" W x 7.8" L
Power	9 Watts (nominal)
Input Power	100-240 VAC, 50-60 Hz

Environmental

Operating temperature	0 to +40° C
Storage temperature	-30° C to +80° C
Operating humidity	0% to 95% RH, non-condensing

Glossary

This glossary defines terms and lists acronyms used with the Motorola SBG1000 Wireless Cable Modem Gateway.

To return to your previous page, click the Acrobat Go to Previous Page  button.

A

access point	A device that provides wireless LAN connectivity to wireless clients (stations). The SBG acts as a wireless access point.
adapter	A device or card that connects a computer, printer, or other peripheral device to the network or to some other device. A <i>wireless adapter</i> connects a computer to the wireless LAN.
address translation	See NAT .
ALG	Application level gateway triggers are required by some file transfer (for example, FTP), game, and video conferencing applications to open one or more ports to enable the application to operate properly.
American Wire Gauge (AWG)	A standard system used to designate the size of electrical conductors; gauge numbers are inverse to size.
ANSI	The American National Standards Institute is a non-profit, independent organization supported by trade organizations, industry, and professional societies for standards development in the United States. This organization defined ASCII and represents the United States to the International Organization for Standardization.
ANX	Automotive Network Exchange
ARP	Address Resolution Protocol broadcasts a datagram to obtain a response containing a MAC address corresponding to the host IP address. When it is first connected to the network, a client sends an ARP message. The SBG1000 responds with a message containing its MAC address. Subsequently, data sent by the computer uses the SBG1000 MAC address as its destination.
ASCII	The American Standard Code for Information Interchange refers to alphanumeric data for processing and communication compatibility among various devices; normally used for asynchronous transmission.
asynchronous timing	The SBG1000 uses synchronous timing for upstream data transmissions. The CMTS broadcasts messages that bandwidth is available. The SBG1000 reserves data bytes requiring x-number of mini-slots. The CMTS replies that it can receive data at a specified time (synchronized). At the specified time, the SBG transmits the x-number of data bytes.
attenuation	The difference between transmitted and received power resulting from loss through equipment, transmission lines, or other devices; usually expressed in decibels.
authentication	A process where the CMTS verifies that access is authorized, using a password, trusted IP address, or serial number.
authorization	Part of the process between a CMTS and the cable modem or gateway to enable Baseline Privacy .
auto-MDIX	Automatic medium-dependent interface crossover detects and corrects cabling errors by automatically reversing the send and receive pins on any port . It enables the use of straight-through wiring between the SBG Ethernet ports and any computer, printer, or hub.

To return to your previous page, click the Acrobat Go to Previous Page  button.

B

bandwidth	The transmission capacity of a medium in terms of a range of frequencies. Greater bandwidth indicates the ability to transmit more data over a given period of time.
Baseline Privacy	An optional feature that encrypts data between the CMTS and the cable modem or gateway. Protection of service is provided by ensuring that a cable modem or gateway, uniquely identified by its MAC address, can only obtain keys for services it is authorized to access.
baud	The analog signaling rate. For complex modulation modes, the digital bit rate is encoded in multiple bits per baud, for example, 64 QAM encodes 6 bits per baud and 16 QAM encodes 4 bits per baud.
BCP	Binary Communication Protocol
BER	The bit error rate is the ratio of the number of erroneous bits or characters received from some fixed number of bits transmitted.
binary	A numbering system that uses two digits, 0 and 1.
bit rate	The number of bits (digital 0s and 1s) transmitted per second in a communications channel. It is usually measured in bits per second bps.
BPKM	Baseline Protocol Key Management encrypts data flows between a cable modem or gateway and the CMTS. The encryption occurs after the cable modem or gateway registers to ensure data privacy across the RF network.
bps	bits per second
bridge	An OSI layer 2 networking device that connects two LANs using similar protocols . It filters frames based on the MAC address to reduce the amount of traffic. A bridge can be placed between two groups of hosts that communicate a lot together, but not so much with the hosts in the other group. The bridge examines the destination of each packet to determine whether to transmit it to the other side. See also switch .
broadband	High bandwidth network technology that multiplexes multiple, independent carriers to carry voice, video, data, and other interactive services over a single cable. A communications medium that can transmit a relatively large amount of data in a given time period. A frequently used synonym for cable TV that can describe any technology capable of delivering multiple channels and services.
broadcast	Simultaneous transmission to multiple network devices; a protocol mechanism supporting group and universal addressing. See also multicast and unicast .

To return to your previous page, click the Acrobat Go to Previous Page  button.

C

CableHome	A project of CableLabs and technology suppliers to develop interface specifications for extending high-quality cable-based services to home network devices. It addresses issues such as device interoperability, QoS, and network management. CableHome will enable cable service providers to offer more services over HFC. It will improve consumer convenience by providing cable-delivered services throughout the home.
CableLabs	A research consortium that defines the interface requirements for cable modems and acknowledges that tested equipment complies with DOCSIS.
cable modem	A device installed at a subscriber location to provide data communications over an HFC network. Unless otherwise specified, all references to “cable modem” in this documentation refers to DOCSIS or Euro-DOCSIS cable modems <i>only</i> .
cable modem configuration file	File containing operational parameters that a cable modem or gateway downloads from the cable service provider TFTP server during registration.
circuit-switched	Network-connection scheme used in the traditional PSTN telephone network where each connection requires a dedicated path for its duration. An alternative is packet-switched .
class C network	An IP network containing up to 245 hosts . Class C IP addresses are in the form “network.network.network.host.”
client	In a client/server architecture, a client is a computer that requests files or services such as file transfer, remote login, or printing from the server . On an IEEE 802.11b wireless LAN, a client is any host that can communicate with the access point . Also called a CPE . A wireless client is also called a “station.”
CMTS	A cable modem termination system is a device in the cable system headend that interfaces the HFC network to local or remote IP networks to connecting IP hosts , cable modems or gateways , and subscribers. It manages all cable modem bandwidth. It is sometimes called an edge router.
CNR	carrier to noise ratio
coaxial cable (coax)	A type of cable consisting of a center wire surrounded by insulation and a grounded shield of braided wire. The shield minimizes electrical and radio frequency interference. Coaxial cable has high bandwidth and can support transmission over long distances.
CoS	Class of service traffic management or scheduling functions are performed when transferring data upstream or downstream on HFC.
CPE	Customer premise equipment, typically computers, printers, etc., are connected to the cable modem or gateway at the subscriber location. CPE can be provided by the subscriber or the cable service provider. Also called a client .
crosstalk	Undesired signal interfering with the desired signal.
CSMA/CD	carrier sense multiple access with collision detection

To return to your previous page, click the Acrobat Go to Previous Page  button.

D

datagram	In RFC 1594 , a datagram is defined as “a self-contained, independent entity of data carrying sufficient information to be routed from the source to the destination computer without reliance on earlier exchanges between this source and destination computer and the transporting network.” For the most part, it has been replaced by the term packet .
default route	The route by which packets are forwarded when other routes in the routing table do not apply.
dB	decibel
dBc	Signal level expressed in dB relative to the unmodulated carrier level desired.
DBm	A unit of measurement referenced to one milliwatt across specified impedance. 0dBm = 1 milliwatt across 75 ohms.
dBmV	Signal level expressed in dB as the ratio of the signal power in a 75-ohm system to a reference power when 1 mV is across 75 ohms.
demodulation	An operation to restore a previously modulated wave and separate the multiple signals that were combined and modulated on a subcarrier.
DHCP	A Dynamic Host Configuration Protocol server dynamically assigns IP addresses to client hosts on an IP network. DHCP eliminates the need to manually assign static IP addresses by “leasing” an IP address and subnet mask to each client. It enables the automatic reuse of unused IP addresses: <i>The SBG is simultaneously a DHCP client and a DHCP server.</i> <ul style="list-style-type: none">• A DHCP server at the cable system headend assigns a public IP address to the SBG1000 and optionally to clients on the SBG LAN.• The SBG contains a built-in DHCP server that assigns private IP addresses to clients.
distortion	An undesired change in signal waveform within a transmission medium. A nonlinear reproduction of the input waveform.
diversity antennas	Two identical antennas located a small distance apart to reduce multipath distortion and improve wireless reception. Properly placed diversity antennas improve SBG wireless reception.
DNS	The Domain Name System is the Internet system for converting domain names to IP addresses . A DNS server contains a table matching domain names such as Internetname.com to IP addresses such as 192.169.9.1. When you access the world-wide web, a DNS server translates the URL displayed on the browser to the destination website IP address. The DNS lookup table is a distributed Internet database; no one DNS server lists all domain name to IP address matches.
DOCSIS	The CableLabs Data-Over-Cable Service Interface Specification defines interface standards for cable modems, gateways, and supporting equipment to deliver data between an HFC network and a computer systems or television sets. To emphasize its use as a cable modem standard, DOCSIS is now called CableLabs Certified Cable Modems. Euro-DOCSIS is DOCSIS adapted for use in Europe.
domain name	A unique name, such as motorola.com, that maps to an IP address . Domain names are typically much easier to remember than are IP addresses.
dotted-decimal format	Method of representing an IP address or subnet mask using four decimal numbers called octets. Each octet represents eight bits. In a class C IP address, the octets are “network.network.network.host.” The first three octets together represent the network address and the final octet is the host address. In the SBG LAN default configuration, 192.168.100 represents the network address. In the final octet, the host address can be from 2 to 254.
download	To copy a file from one computer to another. You can use the Internet to download files from a server to a computer. A DOCSIS or Euro-DOCSIS cable modem or gateway downloads its configuration file from a TFTP server during start-up.
downstream	In a cable data network, the direction of data received by the computer from the Internet.

driver	Software that enables a computer to interact with a network or other device. For example, there are drivers for printers, monitors, graphics adapters, modems, Ethernet , USB , HPNA , and many others.
DSL	Digital Subscriber Line
DSSS	Direct Sequence Spread Spectrum is an IEEE 802.11b RF modulation protocol.
dynamic IP address	An IP address that is temporarily leased to a host by a DHCP server. The opposite of static IP address .

E

encapsulate	To include data into some other data unit to hide the format of the included data.
encode	To alter an electronic signal so that only an authorized user can unscramble it to view the information.
encrypt	To encode data.
endpoint	A VPN endpoint terminates the VPN at the router so that computers on the SBG LAN do not need VPN client software to tunnel through the Internet to the VPN server.
ESSID	The Extended Service Set Identifier or network name is a unique identifier that wireless clients use to associate with an access point to distinguish between multiple wireless LANs in the same area. All clients on a wireless LAN must have the same ESSID as the access point. On the SBG, you can set the ESSID on the Wireless > NETWORK page.
Ethernet	The most widely used LAN type, also known as IEEE 802.3 . The most common Ethernet networks are 10Base-T, which provide transmission speeds up to 10 Mbps , usually over unshielded, twisted-pair wire terminated with RJ-45 connectors. Fast Ethernet (100Base-T) provides speeds up to 100 Mbps. "Base" means "baseband technology" and "T" means "twisted pair cable." Each Ethernet port has a physical address called the MAC address .
Euro-DOCSIS	A tComLabs standard that is DOCSIS adapted for use in Europe
event	A message generated by a device to inform an operator or the network management system that something has occurred.
expansion slot	An connection point in a computer where a circuit board can be inserted to add new capabilities.

To return to your previous page, click the Acrobat Go to Previous Page  button.

F

FCS	frame check sequence
F-type connector	A type of connector used to connect coaxial cable to equipment such as the SBG.
firewall	A security software system on the SBG that enforces an access control policy between the Internet and the SBG LAN .
flow	A data path moving in one direction.
FEC	Forward error correction is a technique to correct transmission errors without requiring the transmitter to resend any data.
FDMA	Frequency Division Multiple Access is a method to allow multiple users to share a specific radio spectrum. Each active user is assigned an individual RF channel (or carrier) with the carrier frequency of each channel offset from its adjacent channels by an amount equal to the channel spacing, which allows the required bandwidth per channel.
frame	A unit of data transmitted between network nodes that contains addressing and protocol control data. Some control frames contain no data.
frequency	Number of times an electromagnetic signal repeats an identical cycle in a unit of time, usually one second, measured in Hz , kHz , mHz , or GHz .
FTP	File Transfer Protocol is a standard Internet protocol for exchanging files between computers. FTP is commonly used to download programs and other files to a computer from web pages on Internet servers.
full-duplex	The ability to simultaneously transmit and receive data. See also half-duplex .

G

gateway	A device that enables communication between networks using different protocols . See also router . The SBG enables up to 245 computers supporting IEEE 802.11b , Ethernet , USB , or HPNA to share a single broadband Internet connection.
gateway IP address	The address of the default gateway router on the internet. Also known as the “giaddr.”
GHz	Gigahertz — one billion cycles per second.
GUI	graphical user interface

To return to your previous page, click the Acrobat Go to Previous Page  button.

H

- H.323** A suite of [protocols](#) created by the [ITU](#) for interactive video-conferencing, data sharing, and audio applications such as [VoIP](#).
- half-duplex** Network where only one device at a time can transmit data. See also [full-duplex](#).
- headend** A location that receives TV programming, radio programming, data, and telephone calls that it modulates onto the HFC network. It also sends return data and telephone transmissions. Headend equipment includes transmitters, preamplifiers, frequency terminals, demodulators, modulators, and other devices that amplify, filter, and convert incoming broadcast TV signals to wireless and cable channels.
- header** The data at the beginning of a [packet](#) that identifies what is in the packet.
- hexadecimal** A base-sixteen numbering system that uses sixteen sequential numbers (0 to 9 and the letters A to F) as base units before adding a new position. On computers, hexadecimal is a convenient way to express [binary](#) numbers.
- HFC** A hybrid fiber/coaxial cable network uses fiber-optic cable as the [trunk](#) and [coaxial cable](#) to the subscriber premises.
- hop** The interval between two routers on an IP network. The number of hops a [packet](#) traverses toward its destination (called the hop count) is saved in the packet header. For example, a hop count of six means the packet has traversed six routers. The packet hop count increases as the time-to-live ([TTL](#)) value decreases.
- host** In [IP](#), a host is any computer supporting end-user applications or services with full two-way network access. Each host has a unique host number that combined with the network number forms its [IP address](#).
Host also can mean:
- A computer running a web server that serves pages for one or more web sites belonging to organization(s) or individuals
 - A company that provides this service
 - In IBM environments, a mainframe computer
- HPNA** The Home Phoneline Networking Alliance (HomePNA) standard enables home network devices to interact over existing telephone wiring without disturbing normal voice service. An HPNA network processes, manages, transports, and stores data to enable telephones, fax machines, desktops, laptops, printers, scanners and web cameras to connect and interoperate over home telephone wiring. HPNA uses frequencies that are not used for phone modems or voice communications. HPNA can work on a Digital Subscriber Line (DSL). Motorola is an HPNA participant.
- HTML** Hyper Text Markup Language
- hub** On a [LAN](#), a hub is a device that connects multiple [hosts](#) to the LAN. A hub performs no data filtering. See also [bridge](#) and [router](#). An IP hub is typically a unit on a rack or desktop.
On an HFC network, a hub is a scaled-down [headend](#) that performs some or all headend functions for part of the system.
- Hz** Hertz — one cycle per second. The unit to measure the [frequency](#) that an alternating electromagnetic signal cycles through its highest and lowest states. Used to define the bands of the electromagnetic spectrum used in voice and data communications, or to define the [bandwidth](#) of a transmission [medium](#).

To return to your previous page, click the Acrobat Go to Previous Page  button.

I

IANA	The Internet Numbering Address Authority (IANA) is an organization under the Internet Architecture Board (IAB) of the Internet Society that oversees IP address allocation. It is under a contract from the U.S. government.
ICMP	Internet Control Message Protocol is a protocol used for error, problem, and informational messages sent between IP hosts and gateways . ICMP messages are processed by the IP software and are not usually apparent to the end-user.
ICSA	The International Computer Security Association is the security industry's main source of research, intelligence, and product certification.
IEEE	The Institute of Electrical and Electronics Engineers, Inc. (http://www.ieee.org) is an organization that produces standards, technical papers, and symposiums for the electrical and electronic industries and is accredited by ANSI .
IEEE 802.11b	IEEE wireless network standard.
IEEE 802.3	See Ethernet .
IETF	The Internet Engineering Task Force (http://www.ietf.org) is an open international community of network designers, operators, vendors, and researchers to develop and maintain Internet architecture. Technical working groups issue working documents called Internet-Drafts. The IETF publishes review versions of the drafts called requests for comments (RFCs).
IGMP	Internet Group Membership Protocol the Internet multicasting standard. IGMP establishes and maintains a database of group multicast addresses and interfaces to which a multicast router forwards multicast packets. IGMP runs between multicast hosts and their immediately-neighborbing multicast routers.
IGMP spoofing	A process where a router acts as an IGMP querier for multicast hosts and an IGMP host to a multicast router.
impedance	The total opposition to ac electron current flow within a device. Impedance is typically 75 ohms for coax cable and other CATV components.
impulse noise	Noise of very short in duration, typically of the order of 10 microseconds. It is caused by electrical transients such as voltage spikes, electric motors turning on, and lightning or switching equipment that bleed over to the cable.
ingress noise	Noise typically caused by discrete frequencies picked up by the cable plant from radio broadcasts or an improperly grounded or shielded home appliance such as a hair dryer. Ingress is the major source of cable system noise.
Internet	A worldwide collection of interconnected networks using TCP/IP .
internetwork	A collection of interconnected networks allowing communication between all devices connected to any network in the collection.
IP	Internet Protocol is a set of standards that enable different types of computers to communicate with one another and exchange data through the Internet. IP provides the appearance of a single, seamless communication system and makes the Internet a virtual network.

IP address	<p>A unique 32-bit value that identifies each host on a TCP/IP network. TCP/IP networks route messages based on the destination IP address. An IP address has two parts:</p> <ul style="list-style-type: none">• The network address is assigned by IANA.• The SBG network administrator assigns a host address to each host connected to the SBG1000, automatically using its DHCP server or as a static IP address. <p>For a class C network, the first 24 bits are the network address and the final 8 bits are the host address; in dotted-decimal format it appears “network.network.network.host.”</p> <p>If you enable the SBG1000 DHCP client on the WAN page, the cable service provider automatically assigns the network address, subnet mask, domain name, and DNS server to provide a continuous Internet connection.</p>
IPSec	<p>The Internet Protocol Security protocols are IETF authentication and encryption standards for secure packet exchange over the Internet. IPSec works at OSI layer 3 and secures everything on the network.</p>
IKE	<p>Internet Key Exchange</p>
ISAKMP	<p>Internet Security Association and Key Management Protocol</p>
ISDN	<p>Integrated Services Digital Network</p>
ISO	<p>The International Organization for Standardization (http://www.iso.ch) is a worldwide federation of national standards bodies from approximately 140 countries. ISO is a non-governmental organization established in 1947 to promote the development of standardization and related activities in the world with a view to facilitating the international exchange of goods and services, and to developing cooperation in the spheres of intellectual, scientific, technological, and economic activity.</p>
ISP	<p>Internet Service Provider</p>
ITU	<p>International Telecommunications Union</p>
K	
kHz	<p>kilohertz — one thousand cycles per second</p>

L

- L2F** Layer 2 Forwarding is an [OSI](#) layer 2 [protocol](#) that establishes a secure [tunnel](#) across the Internet to create a virtual [PPP](#) connection between the user and the enterprise network. L2F is the most established and stable layer 2 tunneling protocol.
- L2TP** Layer 2 Tunnel Protocol is a PPP extension that enables ISPs to operate [VPNs](#). L2TP merges the best features of the [PPTP](#) and L2F. L2TP is the emerging [IETF](#) standard.
- LAC** An L2TP access concentrator is a device to which the [client](#) directly connects through which PPP frames are tunneled to the LNS. The LAC need only implement the media over which L2TP operates to transmit traffic to one or more LNSs. The LAC may tunnel any protocol carried within PPP. The LAC initiates incoming calls and receives outgoing calls. A LAC is analogous to an L2F NAS.
- LAN** A local area network provides a full-time, high-[bandwidth](#) connection over a limited area, such as a building or campus. [Ethernet](#) is the most widely used LAN standard.
- layer** In networks, layers are software [protocol](#) levels. Each layer performs functions for the layers above it. [OSI](#) is a reference model having seven functional layers.
- LCP** Link Control Protocol establishes, configures, and tests data link connections used by [PPP](#).
- latency** The time required for a signal to pass through a device. It is often expressed in a quantity of symbols.
- LED** light-emitting diode
- LNS** An L2TP network server is a termination point for L2TP tunnels where PPP frames are processed and passed to higher layer protocols. An LNS can operate on any platform that terminates PPP. The LNS handles the server side of the L2TP protocol. L2TP relies only on the single media over which L2TP tunnels arrive. The LNS can have a single LAN or WAN interface but can terminate calls arriving at any of the LACs full range of PPP interfaces (asynchronous, synchronous, ISDN, V.120, etc.). The LNS initiates outgoing calls and receives incoming calls. An LNS is analogous to a home gateway in L2F technology.
- loopback** A test that loops the transmit signal to the receive signal. Usually the loopback test is initiated on a network device. The test is used to verify a path or to measure the quality of a signal on that path.

To return to your previous page, click the Acrobat Go to Previous Page  button.

M

MAC address	The Media Access Control address is a unique, 48-bit value permanently saved in ROM at the factory to identify each Ethernet network device. It is expressed as a sequence of 12 hexadecimal digits printed on the SBG rear panel. You need to provide the HFC MAC address to the cable service provider. Also called an Ethernet address, physical address, hardware address, or NIC address.
MB	One megabyte; equals 1,024 x 1,024 bytes, 1,024 kilobytes, or about 8 million bits.
Mbps	Million bits per second (megabits per second). A rate of data transfer.
media	The various physical environments through which signals pass; for example, coaxial, unshielded twisted-pair (UTP), or fiber-optic cable.
MIB	A management information base is a unique hierarchical structure of software objects used by the SNMP manager and agent to configure, monitor, or test a device.
MHz	Megahertz — one million cycles per second. A measure of radio frequency.
MPDU	MAC protocol data unit (PDU)
MSDU	MAC service data unit
MSO	Multiple Systems Operator. A company that owns and operates more than one cable system. Also called a group operator.
MTU	The Maximum Transmission Unit is the largest amount of data that can be transmitted in one discrete message on a given physical network. The MTU places an upper bound on the size of a message that can be transferred by the network in a single frame. Messages exceeding the MTU must be fragmented before transmission, and reassembled at the destination.
multicast	A data transmission sent from one sender to multiple receivers. See also broadcast and unicast .
mW	milliwatts

To return to your previous page, click the Acrobat Go to Previous Page  button.

N

NAS	network access server
NAT	Network Address Translation is an Internet standard for a LAN to use one set of IP addresses for internal traffic and a second set of IP addresses for external traffic. NAT provides some security because the IP addresses of SBG LAN computers are invisible on the Internet. If NAT is enabled on the Gateway page, there is a one-to-one mapping between each public IP address and client IP address.
NAPT	Network Address Port Translation is the most common form of address translation between public and private IP addresses. NAPT is a mapping of one public IP address to many private IP addresses. If NAPT is enabled on the Gateway page, one public IP address is mapped to an individual private IP address for up to 245 LAN clients.
NEC	National Electrical Code (United States) — The regulations for construction and installation of electrical wiring and apparatus, suitable for mandatory application by a wide range of state and local authorities.
network	Two or more computers connected to communicate with each other. Networks have traditionally been connected using some kind of wiring.
network driver	Software packaged with a NIC that enables the computer to communicate with the NIC.
network layer	Layer 3 in the OSI architecture that provides services to establish a path between open systems. The network layer knows the address of the neighboring nodes, packages output with the correct network address data, selects routes, and recognizes and forwards to the transport layer incoming messages for local host domains.
NIC	A network interface card converts computer data to serial data in a packet format that it sends over the LAN. A NIC is installed in an expansion slot or can be built-in. Every Ethernet NIC has a MAC address permanently saved in its ROM.
node	On a LAN, a generic term for any network device. On an HFC network, the interface between the fiber-optic trunk and coaxial cable feeders to subscriber locations. A node is typically located in the subscriber neighborhood.
noise	Random spurts of electrical energy or interface. May produce a salt-and-pepper pattern on a television picture.

To return to your previous page, click the Acrobat Go to Previous Page  button.

O

ohm	A unit of electrical resistance.
OSI	The Open Systems Interconnection reference model is an illustrative model describing how data moves from an application on the source host through a network to an application on the destination host. It is a conceptual framework developed by ISO that is now the primary model for intercomputer communications. OSI is a model <i>only</i> ; it does not define a specific networking interface.

To return to your previous page, click the Acrobat Go to Previous Page  button.

P

packet	The unit of data that is routed between the sender and destination on the Internet or other packet-switched network. When data such as an e-mail message or other file is sent over the Internet, IP on the sender divides the data into uniquely-numbered packets. The packet header contains the source and destination IP addresses. The individual packets may travel different routes. When all packets arrive at the destination, IP at that end reassembles the packets. The header and the data can vary in length. Packet and datagram are similar in meaning.
packet-switched	A scheme to handle transmissions on a connectionless network such as the Internet. An alternative is circuit-switched .
PacketCable	A CableLabs®-led project to define a common platform to deliver advanced real-time multimedia services over two-way HFC cable plant. Built on DOCSIS 1.1 , PacketCable networks use IP technology as the basis for a highly-capable multimedia architecture.
pass-through	A pass-through client on the SBG LAN obtains its public IP address from the cable service provider DHCP server.
PAT	Port Address Translation
PCMCIA	The Personal Computer Memory Card International Association sets international standards for connecting peripherals to portable computers. Laptop computers typically have a PCMCIA slot that can hold one or two PC Cards to provide features such as Ethernet connectivity.
PDA	personal desktop assistant
PDU	A protocol data unit is a message containing operational instructions used for SNMP . The basic SNMP V2 PDU types are get-request, get-next-request, get-bulk-request, response, set-request, inform-request, and trap.
periodic ranging	Ranging that is performed on an on-going basis after initial ranging has taken place.
physical layer	Layer 1 in the OSI architecture. It provides services to transmit bits or groups of bits over a transmission link between open systems. It entails the electrical, mechanical, and handshaking procedures.
piggybacking	A process that occurs when a cable modem simultaneously transmits data and requests additional bandwidth .
PING	A network utility that tests host reachability by sending a small packet to the host and waiting for a reply. If you PING a computer IP address and receive a reply, you know the computer is reachable over the network. It also stands for "Packet InterNet Groper."
PJL	(Hewlett-Packard) Printer Job Language
PMD	The physical media-dependent sublayer of the physical layer which transmits bits or groups of bits over particular types of transmission links between open systems. It entails the electrical, mechanical, and handshaking procedures.
point-to-point	Physical connection made from one point to another.
POTS	The "plain old telephone service" offered through the PSTN ; basic analog telephone service. POTS uses the lowest 4 kHz of bandwidth on twisted pair wiring.
port	On a computer or other electronic device, a port is a socket or plug used to physically connect it to the network or to other devices. in TCP/IP , a port is a number from 0 to 65536 used logically by a client program to specify a server program. Ports 0 to 1024 are reserved
port mirroring	A feature that enables one port (source) on the SBG1000 to be copied to another port (destination) to be studied. The destination mirrors the transmitted (from) or received (to) data on the source port to enable the person managing the network to monitor activity.

PPP	Point-to-Point Protocol is used to transport other protocols, typically for simple links over serial lines. It is most commonly used to access the Internet with a dial-up modem.
PPTP	Point-to-Point Tunneling Protocol encapsulates other protocols . It is a new technology to create VPNs developed jointly by several vendors.
private IP address	An IP address assigned to a computer on the SBG LAN by the DHCP server on the SBG for a specified lease time. Private IP addresses are used by the SBG LAN only; they are invisible to devices on the Internet. See also public IP address .
protocol	A formal set of rules and conventions for exchanging data. Different computer types (for example PC, UNIX, or mainframe) can communicate if they support common protocols.
provisioning	The process of autodiscovery or manually configuring a cable modem on the CMTS .
PSTN	The public switched telephone network is the traditional circuit-switched , voice-oriented telephone network. See also POTS .
public IP address	The IP address assigned to the SBG by the cable service provider. A public IP address is visible to devices on the Internet. See also private IP address .

Q

QAM	Quadrature Amplitude Modulation uses amplitude and phase modulation to encode multiple bits of data in one signaling element. QAM achieves faster data transfer than amplitude or phase modulation alone, but the signal is more prone to errors caused by noise . QAM requires a transmission circuit with a higher CNR than alternate modulation formats such as QPSK. Two types of QAM are: <ul style="list-style-type: none">• 16 QAM encodes four bits per symbol as one of 16 possible amplitude and phase combinations.• 64 QAM encodes six bits per symbol as one of 64 possible amplitude and phase combinations.
QPSK	Quadrature Phase Shift Key (QPSK) modulation sends two bits of information per symbol period with one symbol 90 degrees out of phase with other symbols. The four constellation points represented by the coordinates (0,0 - 0,1 - 1,0 - 1,1) represent the four possible combinations.
QoS	Quality of service describes the priority, delay, throughput, and bandwidth of a connection.

To return to your previous page, click the Acrobat Go to Previous Page  button.

R

RAS	Remote Access Server
registration	How a cable modem makes itself known to the CMTS . The cable modem configuration file and authorization are verified and the CoS is negotiated.
return loss	A measurement of the quality of the match of the device to the cable system. Return loss is the ratio of the amount of power reflected by the device. A return loss of 20 dB or greater is preferred.
RF	Radio Frequency — signals used by the CMTS transmitter and receiver to send data over HFC. The carrier is modulated to encode the digital data stream for transmission across the cable network.
RFC	Request for Comments published on the IETF or other websites. Many RFCs become international standards.
RJ-11	The most common type of connector for household or office phones.
RJ-45	An 8-pin modular connector; the most common connector type for 10Base-T or 100Base-T Ethernet networks.
ROM	read-only memory
router	<p>On IP networks, a device connecting at least two networks, which may or may not be similar. A router is typically located at a gateway between networks. A router operates on OSI network layer 3. It filters packets based on the IP address, examining the source and destination IP addresses to determine the best route on which to forward them.</p> <p>A router is often included as part of a network switch. A router can also be implemented as software on a computer.</p>
routing table	A table listing available routes that is used by a router to determine the best route for a packet.
RTS	request to send

To return to your previous page, click the Acrobat Go to Previous Page  button.

S

server	In a client/server architecture, a dedicated computer that supplies files or services such as file transfer, remote login, or printing to clients .
scope	The set of IP addresses that a DHCP server can lease to clients .
service provider	A company providing cable data services to subscribers.
SID	A service ID is a unique 14-bit identifier the CMTS assigns to a cable modem or gateway that identifies the traffic type it carries (for example, data or voice). The SID provides the basis for the CMTS to allocate bandwidth to the cable modem and implement CoS .
SDU	service data unit
SME	small and medium enterprise
SMTP	Simple Mail Transfer Protocol is a standard Internet protocol for transferring e-mail.
SNMP	Simple Network Management Protocol is a standard to monitor and manage networks and network devices. Data is exchanged using PDU messages.
SOHO	small office home office
spectrum	A specified range of frequencies used for transmission of electromagnetic signals.
spectrum allocation	An allocation of portions of the available electromagnetic spectrum for specific services, such as AM, FM, or personal communications.
splitter	A device that divides the signal from an input cable between two or more cables.
stateful inspection	<p>A type of firewall that tracks each connection traversing all firewall interfaces to ensure validity. In addition to examining the source and destination in the packet header based on static rules, a stateful inspection firewall:</p> <ul style="list-style-type: none">• Examines packet headers on context established by previous packets that traversed the firewall• Monitors the connection state and saves it in a table• Closes ports until a connection to a specific port is requested• May examine the packet contents up through the application layer to determine more than just the source and destination <p>A stateful-inspection firewall is more advanced than a static filter firewall.</p>
static filter	A type of firewall that examines the source and destination in the packet header based on administrator-defined rules <i>only</i> .
static IP address	An IP address that is permanently assigned to a host . Normally, a static IP address must be assigned manually. The opposite of dynamic IP address .
static route	A manually-defined route.
station	IEEE 802.11b term for wireless client .
subscriber	A home or office user who accesses television, data, or other services from a cable service provider.
subnet mask	A bit mask that is logically ANDed with the destination IP address of a packet to determine the network address. A router routes packets using the network address.
subnetwork	A part of a network; commonly abbreviated "subnet." When subnetting is used, the host portion of the IP address is divided into a subnet and host number. Hosts and routers use the subnet mask to identify the bits used for the network and subnet number.
switch	On an Ethernet network, a switch filters frames based on the MAC address , in a manner similar to a bridge . A switch is more advanced because it can connect more than two segments.

symbol rate Also known as baud rate, is a measure of the number of times per second a signal in a communications channel varies, or makes a transition between states (states being frequencies, voltage levels or phase angles). Usually measured in symbols per second (sps).

SYSLOG A de-facto UNIX standard for logging system events.

T

TBCP Tagged Binary Communication Protocol

TCP Transmission Control Protocol on OSI transport layer four, provides reliable transport over the network for data transmitted using IP (network layer three). It is an end-to-end protocol defining rules and procedures for data exchange between hosts on top of connectionless IP. TCP uses a timer to track outstanding packets, checks error in incoming packets, and retransmits packets if requested.

TCP/IP The Transmission Control Protocol/Internet Protocol suite provides standards and rules for data communication between networks on the Internet. It is the worldwide internetworking standard and the basic communications protocol of the Internet.

TFTP Trivial File Transfer Protocol is a very simple protocol used to transfer files.

transparent bridging A method to enable all hosts on the wired Ethernet LAN, IEEE 802.11b wireless LAN, HPNA LAN, and USB connection to communicate as if they were all connected to the same physical network.

transport layer Layer of the OSI concerned with protocols for error recognition and recovery. This layer also regulates information flow.

trunk Electronic path over which data is transmitted.

TTL The time to live is the number of routers (or hops) a packet can traverse before being discarded. When a router processes a packet, it decreases the TTL by 1. When the TTL reaches zero, the packet is discarded.

tunnel To place packets inside other packets to send over a network. The protocol of the enclosing packet is understood by each endpoint, or tunnel interface, where the packet enters and exits the network. VPNs rely on tunneling to create a secure network.

Tunneling requires the following protocol types:

- A carrier protocol, such as TCP, used by the network that the data travels over
- An encapsulating protocol, such as IPSec, L2F, L2TP, or PPTP, that is wrapped around the original data
- A passenger protocol, such as IP, for the original data

two-way A cable system that can transmit signals in both directions to and from the headend and the subscriber.

To return to your previous page, click the Acrobat Go to Previous Page  button.

U-Z

UDP	User Datagram Protocol
unicast	A point-to-point data transmission sent from one sender to one receiver. This the normal way you access websites. See also broadcast and multicast .
upstream	In a cable data network, upstream describes the direction of data sent from the subscriber computer through the cable modem to the CMTS and the Internet.
USB	Universal Serial Bus is a computer interface for add-on devices such as printers, scanners, mice, modems, or keyboards. USB supports data transfer rates of 12 Mbps and plug-and-play installation. You can connect up to 127 devices to a single USB port.
UTP	unshielded twisted pair (wire)
VLAN	A virtual local area network is group of devices on different LAN segments that are logically configured to communicate as if they are connected to the same wire.
VoIP	Voice over Internet Protocol is a method to exchange voice, fax, and other information over the Internet. Voice and fax have traditionally been carried over traditional telephone lines of the PSTN using a dedicated circuit for each line. VoIP enables calls to travel as discrete data packets on shared lines. VoIP is an important part of the convergence of computers, telephones, and television into a single integrated information network.
VPN	A virtual private network is a private network that uses “virtual” connections (tunnels) routed over a public network (usually the Internet) to provide a secure and fast connection; usually to users working remotely at home or in small branch offices. A VPN connection provides security and performance similar to a dedicated link (for example, a leased line), but at much lower cost.
WAN	A wide-area network provides a connection over a large geographic area, such as a country or the whole world. The bandwidth depends on need and cost, but is usually much lower than for a LAN .
WAP	Wireless access point or Wireless Access Protocol. See also access point .
WECA	The Wireless Ethernet Compatibility Alliance is a trade organization that works to ensure that all wireless IEEE 802.11b Wi-Fi devices — computer cards, laptops, air routers, PDAs, etc — can communicate with each other.
WEP	Wired Equivalent Privacy encryption protects the privacy of data transmitted over a wireless LAN . WEP uses keys to encrypt and decrypt transmitted data. The access point must authenticate a client before it can transfer data to another client. WEP is part of IEEE 802.11b .
Wi-Fi	Wireless fidelity (pronounced y-phi) brand name applied to products supporting IEEE 802.11b.
Wireless Cable Modem Gateway	The Motorola SBG1000 Wireless Cable Modem Gateway is a single device that combines a cable modem, router , Ethernet switch, wireless access point , HPNA connection, print server, and DHCP server for SOHO or SME use.
WLAN	wireless LAN
world wide web	An interface to the Internet that you use to navigate and hyperlink to information.

To return to your previous page, click the Acrobat Go to Previous Page  button.

❖ Software License

Motorola, Inc., Broadband Communications Sector (“Motorola”), 101 Tournament Drive, Horsham, PA 19044

IMPORTANT: PLEASE READ THIS SOFTWARE LICENSE (“LICENSE”) CAREFULLY BEFORE YOU INSTALL, DOWNLOAD OR USE ANY APPLICATION SOFTWARE, USB DRIVER SOFTWARE, FIRMWARE AND RELATED DOCUMENTATION (“SOFTWARE”) PROVIDED WITH MOTOROLA’S CABLE DATA PRODUCT (THE “CABLE DATA PRODUCT”). BY USING THE CABLE DATA PRODUCT AND/OR INSTALLING, DOWNLOADING OR USING ANY OF THE SOFTWARE, YOU INDICATE YOUR ACCEPTANCE OF EACH OF THE TERMS OF THIS LICENSE. UPON ACCEPTANCE, THIS LICENSE WILL BE A LEGALLY BINDING AGREEMENT BETWEEN YOU AND MOTOROLA. THE TERMS OF THIS LICENSE APPLY TO YOU AND TO ANY SUBSEQUENT USER OF THIS SOFTWARE.

IF YOU DO NOT AGREE TO ALL OF THE TERMS OF THIS LICENSE (I) DO NOT INSTALL OR USE THE SOFTWARE AND (II) RETURN THE CABLE DATA PRODUCT AND THE SOFTWARE (COLLECTIVELY, “PRODUCT”), INCLUDING ALL COMPONENTS, DOCUMENTATION AND ANY OTHER MATERIALS PROVIDED WITH THE PRODUCT, TO YOUR POINT OF PURCHASE OR SERVICE PROVIDER, AS THE CASE MAY BE, FOR A FULL REFUND.

The Software includes associated media, any printed materials, and any “on-line” or electronic documentation, as well as any updates, revisions, bug fixes, or drives obtained by you from Motorola or your service provider. Software provided by third parties may be subject to separate end-user license agreements from the manufacturers of such Software.

The Software is never sold. Motorola licenses the Software to the original customer and to any subsequent licensee for personal use only on the terms of this License. Motorola and its 3rd party licensors retain the ownership of the Software.

You may:

USE the Software only in connection with the operation of the Product.

TRANSFER the Software (including all component parts and printed materials) permanently to another person, but only if the person agrees to accept all of the terms of this License. If you transfer the Software, you must at the same time transfer the Product and all copies of the Software (if applicable) to the same person or destroy any copies not transferred.

TERMINATE this License by destroying the original and all copies of the Software (if applicable) in whatever form.

You may not:

(1) Loan, distribute, rent, lease, give, sublicense or otherwise transfer the Software, in whole or in part, to any other person, except as permitted under the TRANSFER paragraph above. (2) Copy or translate the User Guide included with the Software, other than for personal use. (3) Copy, alter, translate, decompile, disassemble or reverse engineer the Software, including but not limited to, modifying the Software to make it operate on non-compatible hardware. (4) Remove, alter or cause not to be displayed, any copyright notices or startup message contained in the Software programs or documentation. (5) Export the Software or the Product components in violation of any United States export laws.

The Product is not designed or intended for use in on-line control of aircraft, air traffic, aircraft navigation or aircraft communications; or in design, construction, operation or maintenance of any nuclear facility. MOTOROLA AND ITS 3RD PARTY LICENSORS DISCLAIM ANY EXPRESS OR IMPLIED WARRANTY OF FITNESS FOR SUCH USES. YOU REPRESENT AND WARRANT THAT YOU SHALL NOT USE THE PRODUCT FOR SUCH PURPOSES.

Title to this Software, including the ownership of all copyrights, mask work rights, patents, trademarks and all other intellectual property rights subsisting in the foregoing, and all adaptations to and modifications of the foregoing shall at all times remain with Motorola and its 3rd party licensors. Motorola retains all rights not expressly licensed under this License. The Software, including any images, graphics, photographs, animation, video, audio, music and text incorporated therein is owned by Motorola or its 3rd party licensors and is protected by United States copyright laws and international treaty provisions. Except as otherwise expressly provided in this License, the copying, reproduction, distribution or preparation of derivative works of the Software, any portion of the Product or the documentation is strictly prohibited by such laws and treaty provisions. Nothing in this License constitutes a waiver of Motorola’s rights under United States copyright law.

This License and your rights regarding any matter it addresses are governed by the laws of the Commonwealth of Pennsylvania, without reference to conflict of laws principles. THIS LICENSE SHALL TERMINATE AUTOMATICALLY if you fail to comply with the terms of this License.

Motorola is not responsible for any third party software provided as a bundled application, or otherwise, with the Software.

U.S. GOVERNMENT RESTRICTED RIGHTS

The Product and documentation is provided with RESTRICTED RIGHTS. The use, duplication or disclosure by the Government is subject to restrictions as set forth in subdivision (c)(1)(ii) of The Rights in Technical Data and Computer Software clause at 52.227-7013. The contractor/manufacturer is Motorola, Inc., Broadband Communications Sector, 101 Tournament Drive, Horsham, PA 19044.



495002-001
10/02

MGBI

