



EMINENT



EM4597

Concurrent AC1200

Dual Band Wi-Fi Repeater and Access point

en

Manual

EM4597 - Concurrent AC1200 Dual Band Wi-Fi Repeater and Access point

Table of contents

| | |
|---|----|
| 1.0 Introduction | 2 |
| 1.1 Packing contents | 3 |
| 1.2 Device Overview..... | 3 |
| 2.0 Where to place the EM4597 repeater? | 7 |
| 3.0 Dual Band explanation..... | 8 |
| 3.1 Connect the EM4597 to your single-band Wi-Fi network and upgrade to a Dual Band Wi-Fi network. | 8 |
| 3.2 Connect the EM4597 to a Dual Band Wi-Fi network. | 8 |
| 3.3 Cross Band technology..... | 9 |
| 3.4 Mixed Wi-Fi clients | 10 |
| 4.0 Connecting the EM4597 to your modem/router..... | 11 |
| 4.1 Configure the wireless repeater using the WPS button | 11 |
| 4.2 Manual configuration using encryption key | 12 |
| 5.0 Changing the wireless network name (SSID) of the repeater | 15 |
| 5.1 Find your repeaters IP address..... | 15 |
| 5.2 Change repeaters SSID name..... | 19 |
| 6.0 Access Point mode..... | 21 |
| 7.0 Frequently Asked Questions and other related information | 24 |
| 8.0 Service and support..... | 24 |
| 9.0 Warning and points of attention | 24 |
| 10.0 Warranty conditions | 26 |

1.0 Introduction

Congratulations with the purchase of this high-quality Eminent product! This product has undergone extensive testing by Eminent's technical experts. Should you experience any problems with this product, you are covered by Eminent warranty. Please keep this manual and the receipt in a safe place.

Register your product now on www.eminent-online.com and receive product updates!

1.1 Packing contents

The following parts need to be present in the packing:

- EM4597
- QIG
- Ethernet cable

1.2 Device Overview

Front panel

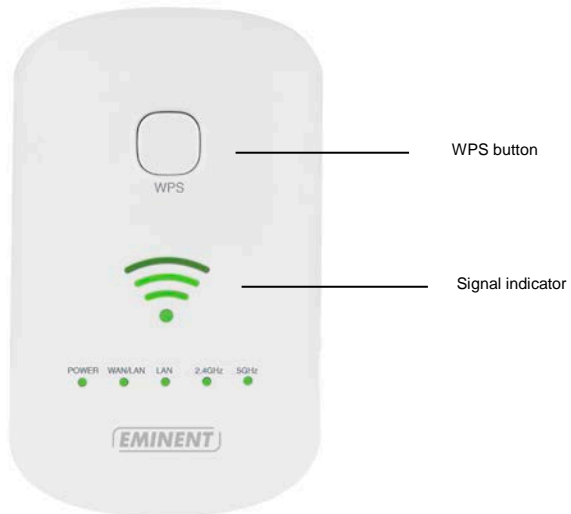

| LABEL | STATE | DESCRIPTION |
|---------------------|-----------|---------------------------|
| LED Signal strength | | |
| 3 BARS | Connected | 90% and above (Excellent) |
| 2 BARS | Connected | 55-89% (Recommended) |
| 1 BAR | Connected | 10-54% (Weak) |

| LABEL | DESCRIPTION |
|------------|---|
| WPS Button | Connect EM4597 to any WPS capable devices (7 sec. to connect to router/AP or 2 sec. when connecting a wireless client) |
| Reset | Press the reset button for 10 seconds to restore the device to default factory settings. Wait approx. 1 minute for the device to reboot |

Bottom



| LABEL | DESCRIPTION |
|--------------|---|
| LAN port | Connect to computers / Ethernet devices |
| WAN/LAN port | Connect to computers / Ethernet devices/ Connect to router port |

Side panel

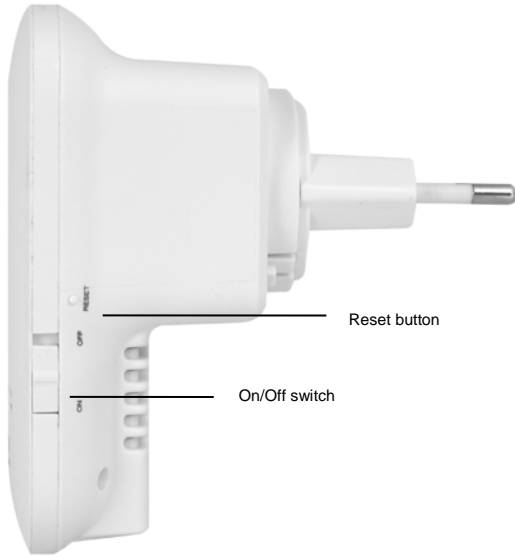

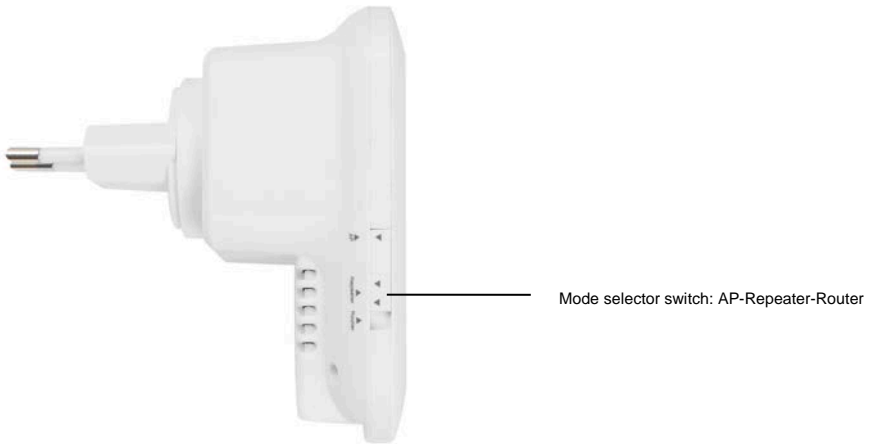



| LABEL | DESCRIPTION |
|----------|--|
| AP mode | When mode selector switch has switched to AP, Repeater will work as Access Point |
| Repeater | When mode selector switch has switched to AP, Repeater will work as Repeater |
| Router | When mode selector switch has switched to AP, Repeater will work as Router |

2.0 Where to place the EM4597 repeater?

The best location to place the EM4597 is approximately half-way between your wireless modem/router and your Wi-Fi client (laptop/smartphone/tablet) which has/have the weakest wireless reception. This way, the signal strength will be as good as possible. Refer to the following images for an example:

| Weak  | Recommended  | Excellent  |
|--|---|---|
| Throughput less than 30% | Throughput up to 60% | Throughput up to 80% |
| Wireless Coverage Extended up to 90% | Wireless Coverage Extended up to 60% | Wireless Coverage Extended up to 40% |

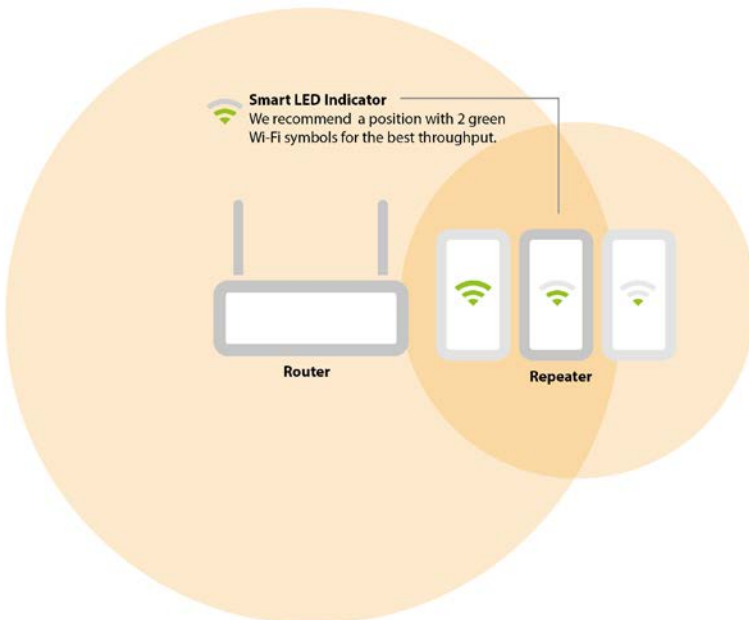

Hint: Before placing the EM4597 on its destined location, the device needs to be setup. Setting up the EM4597 wireless repeater can be done best, if the EM4597 is located near your wireless modem/router. After setting up the EM4597, you can place the EM4597 at a location defined by using the signal indicator LEDs and the recommended setup as described previously.

3.0 Dual Band explanation.

In chapter 3.1 to 3.4 we will explain the different kinds of setups you can configure with the EM4597, so you will be able to determine what setup will fit best to your situation.

Comparison of the 2 Wi-Fi bands.

- 2.4GHz
 - + best coverage
 - more interference with other wireless devices
 - lower bandwidth.

- 5GHz
 - lower coverage
 - + less interference with other wireless devices
 - + higher bandwidth.

3.1 Connect the EM4597 to your single-band Wi-Fi network and upgrade to a Dual Band Wi-Fi network.

If you do not have a Dual Band modem/router you can upgrade your Wi-Fi network by using the EM4597 to create a Dual Band Wi-Fi network. The EM4597 will be connected to your existing 2.4GHz Wi-Fi connection and will repeat this connection into a Dual Band connection.



3.2 Connect the EM4597 to a Dual Band Wi-Fi network.

If you have a Dual Band modem/router there are a few factors to consider to fit your situation best.

First check which Wi-Fi connection has the best performance in signal strength and connection speed. 2.4GHz band has the best coverage but also has the most interference with other Wireless devices. The 5GHz band has a lower coverage but less interference with other wireless devices and a higher bandwidth.

To get the best performance we advise to connect the EM4597 to the 5GHz band of the modem/router.



To get the best coverage we advise to connect the EM4597 to the 2.4GHz band of the modem/router.



3.3 Cross Band technology

If your performance and signal strength are ok on both bands we advise to determine which band is used by the most (preferably by all) Wi-Fi clients and use the opposite band to communicate between the EM4597 and your modem/router, and connect your Wi-Fi clients to the other band. In this case the EM4597 can provide the best performance between Wi-Fi clients and modem/router.

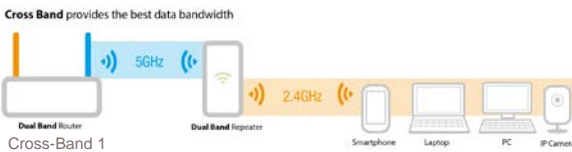

2.4GHz Wi-Fi clients connected to the EM4597 and the EM4597 connected to the modem/router by 5GHz (see picture Cross-Band 1)

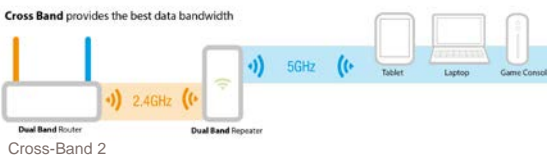

5GHz Wi-Fi clients connected to the EM4597 and the EM4597 connected to the modem/router by 2.4GHz (see picture Cross-Band 2)

Note: We advise to use the 5GHz band to communicate between the EM4597 and the modem/router for best performance. Please use the 2.4GHz band if you prefer coverage above performance, or when you only have a single band router.

Note: If a Wi-Fi client is connected to the EM4597 and uses the same band as the connection between EM4597 and modem/router. The EM4597 will have to wait for the data package to be send from the Wi-Fi client to the Repeater before it can send the data package to the modem/router this applies for communication in both directions. In this case the network speed is reduced by 50%. If the Wi-Fi client uses the opposite band to communicate with the EM4597 the network speed is not reduced by 50%.

3.4 Mixed Wi-Fi clients

In most cases the Repeater will be used in mixed mode (2.4GHz and 5GHz Wi-Fi clients are connected to the EM4597)

Note: If possible we advise to use gaming and Video devices on the 5GHz Band and other devices preferably on 2.4GHz to provide the best performance to these devices.

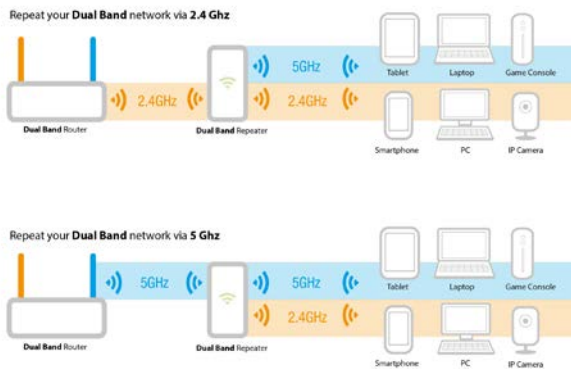

- 2.4GHz
 - + best coverage
 - more interference with other wireless devices
 - lower bandwidth.

- 5GHz
 - lower coverage
 - + less interference with other wireless devices
 - + higher bandwidth.

4.0 Connecting the EM4597 to your modem/router

There are three different ways to connect your EM4597 to your modem/router.

4.1 Configure the wireless repeater using the WPS button

1. Please check if your wireless modem/router has a WPS button. Also check whether your wireless router has a properly configured internet connection.
2. Connect the EM4597 to a wall outlet. Please place the EM4597 close to the modem/router during setup.
3. Wait for the LED to turn green (flashing). This will take approx.. 1 minute.
4. Press the WPS button on your wireless router for approximately 3 seconds*.

**Refer to the manual of your wireless router for the exact duration of pressing the WPS button. This can differ from brand or model.*

5. Now press the WPS button on the EM4597 Wireless Repeater for approximately 7 seconds. Refer to the following image for the WPS button:



6. The connection between your wireless router and the EM4597 wireless repeater will be established automatically. This will take approx. 1 minute including reboot.

Note: If a modem/router is sending out SSIDs on both 2.4GHz and 5GHz bands at the same time, priority of connection depends on which frequency will be found first. If you prefer to manually choose the corresponding frequency to make a WPS connection between the modem/router and the EM4597 then please connect to the Wi-Fi network using the WebGUI. See chapter 5.2

Note: If the WPS button is used, the SSID and network key and frequencies are the same as used on your wireless router. Some WPS routers will change their original SSID to another SSID if WPS is used. In this installation guide, the SSID of the wireless router is 'Eminent Test 1'. After using WPS button the SSID will automatically change to SSID + (2.4GHz/5GHz) + (R). If you wish to use different settings from your modem/router you will need to setup the EM4597 manually using a web browser.

4.2 Manual configuration using encryption key

1. Connect the EM4597 to a wall outlet (preferably close to the modem/router).
2. Wait for the signal indicator to flash green. This will take approximately 1 minute.
3. Connect to the EM4597 via Wi-Fi SSID: **Eminent_repeater** or **Eminent_repeater(5G)**, or use the Ethernet cable to connect directly from your PC LAN port to the EM4597 “LAN” port
4. Open your internet browser and type `http://192.168.10.1` in your internet browser and then hit Enter.
5. The login screen will appear. Enter the **Username:** “admin” and **Password:** “admin”, then click “Login” to login.

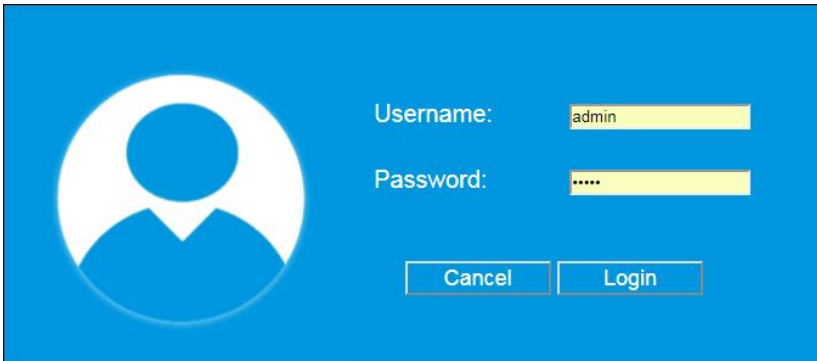

Username:

Password:

6. In the next step you will need to enter the WEP or WPA Passphrase of the Wi-Fi network you wish to connect to.

Select **"Repeater Wizard"** from the menu.

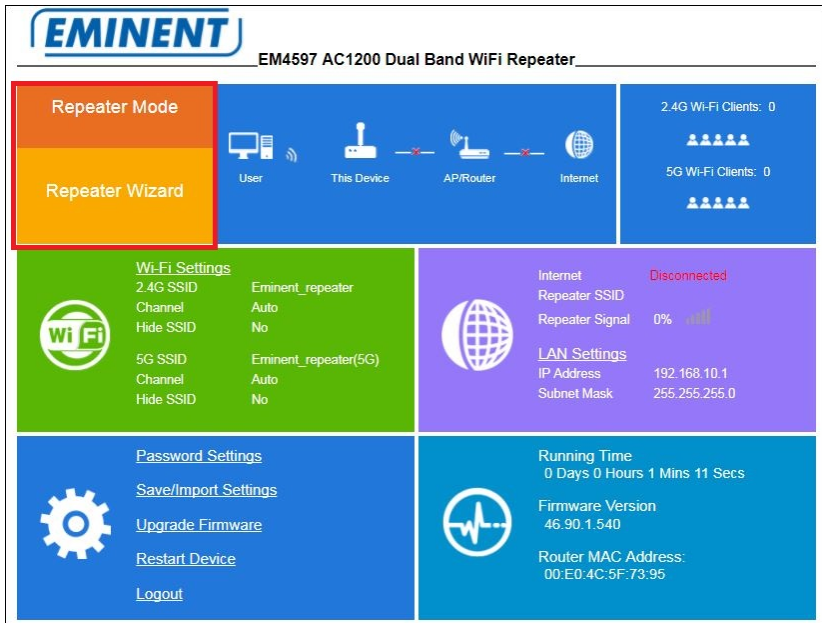

EMINENT
EM4597 AC1200 Dual Band WiFi Repeater

Repeater Mode

Repeater Wizard

User This Device AP/Router Internet

2.4G Wi-Fi Clients: 0

5G Wi-Fi Clients: 0

Wi-Fi Settings

2.4G SSID Eminent_repeater
Channel Auto
Hide SSID No

5G SSID Eminent_repeater(5G)
Channel Auto
Hide SSID No

Internet **Disconnected**

Repeater SSID
Repeater Signal 0%

LAN Settings

IP Address 192.168.10.1
Subnet Mask 255.255.255.0

Password Settings

[Save/Import Settings](#)

[Upgrade Firmware](#)

[Restart Device](#)

[Logout](#)

Running Time
0 Days 0 Hours 1 Mins 11 Secs

Firmware Version
46.90.1.540

Router MAC Address:
00:E0:4C:5F:73:95

7. You will see a screen with all the available Wi-Fi networks (2.4GHz and 5GHz bands).

Repeater Wizard

| SSID | Channel | Security and Encryption | Signal | Choose |
|-----------------------|---------|-------------------------|--------|----------------------------------|
| | 1 | WPA2-PSK | | <input type="radio"/> |
| Eminent 2.4GHz | 1 | WPA-PSK/WPA2-PSK | | <input type="radio"/> |
| | 1 | WPA-PSK/WPA2-PSK | | <input type="radio"/> |
| | 36 | WPA2-PSK | | <input type="radio"/> |
| | 44 | WPA2-PSK | | <input type="radio"/> |
| Eminent 5GHz | 44 | WPA-PSK/WPA2-PSK | | <input checked="" type="radio"/> |
| | 1 | WPA2-PSK | | <input type="radio"/> |
| | 5 | WPA-PSK/WPA2-PSK | | <input type="radio"/> |

Connect to:

5G SSID:

2.4G SSID:

8. Select the corresponding network you want to connect to in the “**Choose**” field.
9. You may notice that the repeater will automatically make a new Wi-Fi SSID name for 2,4GHz and 5GHz SSID. Enter the security key of your wireless network in the Wi-Fi “Key” field.

Repeater Wizard

| SSID | Channel | Security and Encryption | Signal | Choose |
|-----------------------|---------|-------------------------|--------|----------------------------------|
| Eminent 2.4GHz | 1 | WPA2-PSK | | <input type="radio"/> |
| | 1 | WPA-PSK/WPA2-PSK | | <input checked="" type="radio"/> |
| | 1 | WPA-PSK/WPA2-PSK | | <input type="radio"/> |
| | 36 | WPA2-PSK | | <input type="radio"/> |
| | 44 | WPA2-PSK | | <input type="radio"/> |
| Eminent 5GHz | 44 | WPA-PSK/WPA2-PSK | | <input type="radio"/> |
| | 1 | WPA2-PSK | | <input type="radio"/> |
| | 5 | WPA-PSK/WPA2-PSK | | <input type="radio"/> |

Connect to:

Key:

Notice: The Repeater Wireless Key will be the same as your Wireless AP/Router after these settings.

5G SSID:

2.4G SSID:

10. Click "**Save**", the EM4597 will reboot and connect to your router.
11. You can now connect your wireless network adapter(s) to the new made Wi-Fi SSID and entering the wireless encryption key of the wireless network you previously connected.

Note: After the settings have been applied, the EM4597 will reboot. Your device will no longer be connected to the wireless network SSID of the EM4597.

5.0 Changing the wireless network name (SSID) of the repeater.

After you setup the repeater to connect to your home network, the repeater will receive an IP address from your router. You can access the repeaters menu by fill in the repeaters ip address, that has been obtained by your router, into your internet browser. In below picture is shown how you can find your new repeaters IP address for Windows, Android and IOS.

5.1 Find your repeaters IP address

Windows:

1. For Windows Vista and 7, click on "**Start**" button, type "**cmd**" and press "**Enter**". For windows 8 and 10, right click on "**Start**" button and select "**Run**"

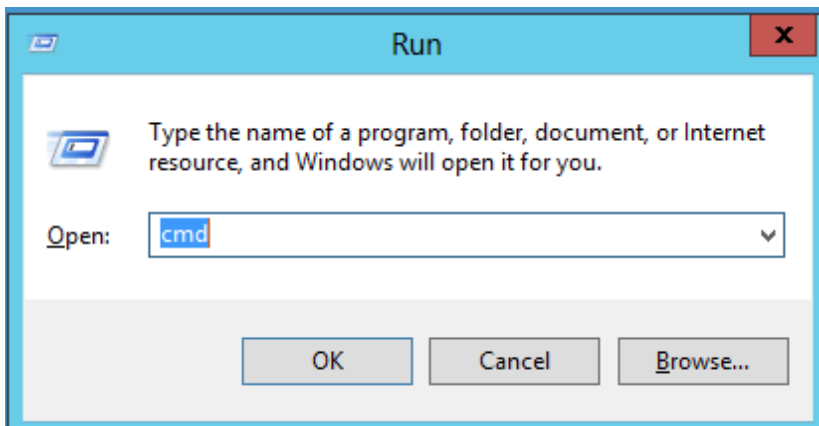

Type "**cmd**" and press "**Enter**". Type ipconfig/all and press enter. The following screen appears:

Example:

```
cmd C:\Windows\system32\cmd.exe
Windows IP Configuration
Host Name . . . . . : Win8Test
Primary Dns Suffix . . . . . :
Node Type . . . . . : Hybrid
IP Routing Enabled. . . . . : No
WINS Proxy Enabled. . . . . : No

Ethernet adapter Ethernet:

Connection-specific DNS Suffix . . . :
Description . . . . . : Realtek PCIe GBE Family-controller
Physical Address. . . . . : 9C-B6-54-F0-C3-A9
DHCP Enabled. . . . . : Yes
Autoconfiguration Enabled . . . . . : Yes
Link-local IPv6 Address . . . . . : fe80::4443:eb25:a9bf:319e%3(Preferred)
IPv4 Address. . . . . : 192.168.8.13(Preferred)
Subnet Mask . . . . . : 255.255.255.0
Lease Obtained. . . . . : dinsdag 12 januari 2016 12:49:12
Lease Expires . . . . . : dinsdag 12 januari 2016 14:49:30
Default Gateway . . . . . : 192.168.8.1
DHCP Server . . . . . : 192.168.8.1
DHCPv6 Iaid . . . . . : 60601940
DHCPv6 Client DUID. . . . . : 00-01-00-01-1C-EB-B9-8F-9C-B6-54-F0-C3-A9

DNS Servers . . . . . : 192.168.8.12
                       192.168.100.1
NetBIOS over Tcpip. . . . . : Enabled
```

2. You will now see the repeaters IP address behind the section DNS Servers

Android:

The easiest way to show your network configuration in Android is by downloading and installing "Ipconfig" in the Google Play Store.

1. After you have installed this app, open it and the following screen will be shown.

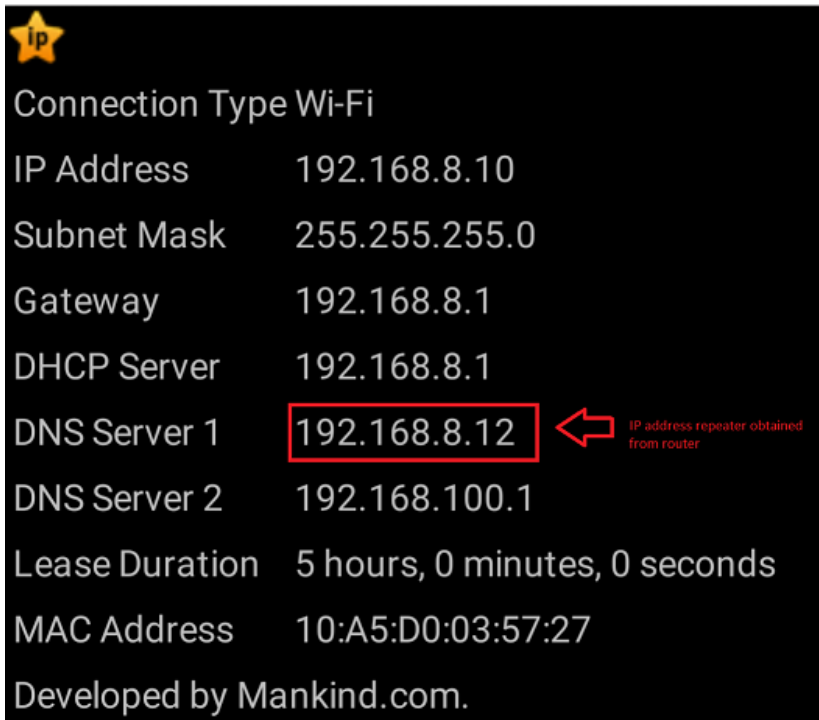
Example:

2. You will now see the repeaters IP address behind the section DNS Server 1

IOS:

1. Select "Settings" from the Home screen and enter the Wi-Fi section.
2. In the Wi-fi section you will see the repeaters SSID you are connected with.

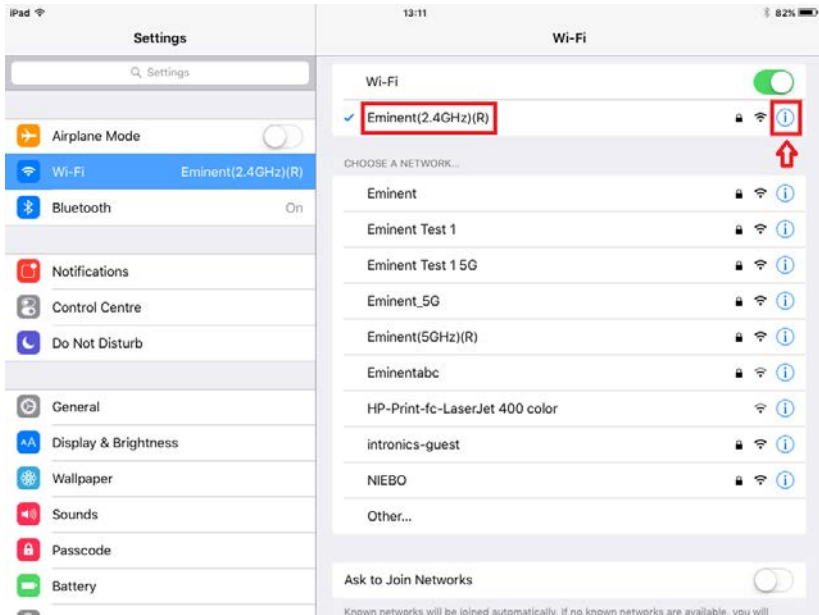
Example:

3. Click on the info button next to Wi-Fi icon. The following screen appears:

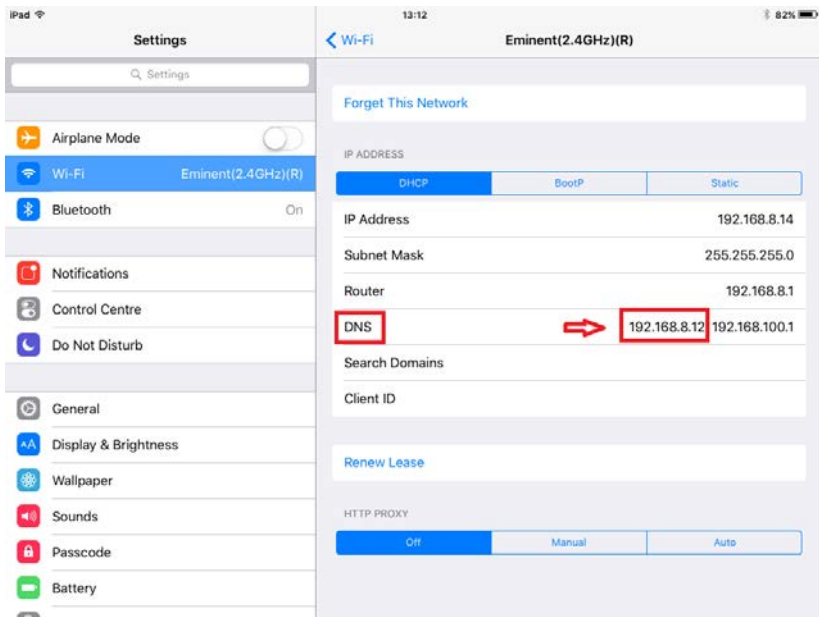
Example:

4. You will now see the repeaters IP address behind the section DNS.

5.2 Change repeaters SSID name

If you wish to use a different Wi-Fi network SSID name for the EM4597 repeater. You can change this by entering the User Interface of the EM4597.

1. Open your internet browser and type your repeaters IP address in your internet browser and then hit Enter.
2. The login screen will appear. Enter the **Username: "admin"** and **Password: "admin"**, then click **"Login"** to login.

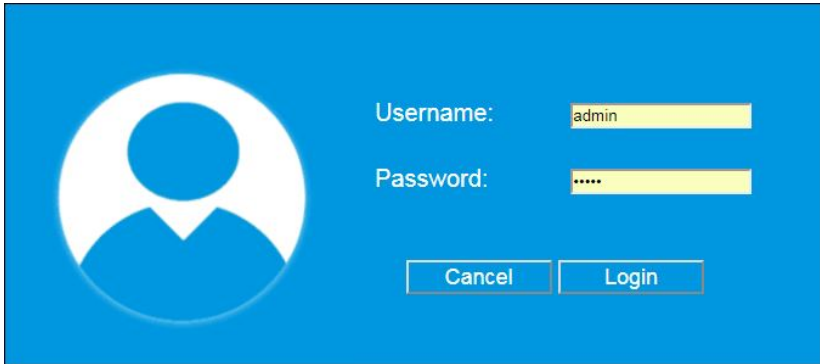

Username:

Password:

3. Select "**Wi-Fi settings**" from the Wi-Fi menu. See picture.

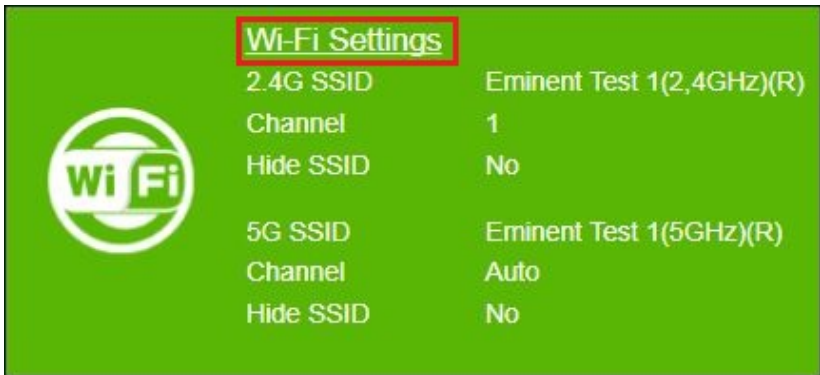

Wi-Fi Settings

| | |
|-----------|---------------------------|
| 2.4G SSID | Eminent Test 1(2,4GHz)(R) |
| Channel | 1 |
| Hide SSID | No |
| 5G SSID | Eminent Test 1(5GHz)(R) |
| Channel | Auto |
| Hide SSID | No |

4. Select the Wi-Fi band you wish to edit the network name for.

- Change the SSID name to the preferred name for the Wi-Fi network of the Repeater. See picture.

2.4G Wi-Fi Settings

WiFi SSID: Hide SSID

Encrypted: ▼

Channel: ▼

5G Wi-Fi Settings

WiFi SSID: Hide SSID

Encrypted: ▼

Channel: ▼

- Click **“Save”**. (If you wish to change both Network names please repeat step 3 and 4).
- Remove the repeater from the power socket or switch off the repeater by switching the **“On/Off”** button to **“Off”**.
- Connect the EM4597 back to the wall outlet and make sure the **“On/Off”** button is switched to **“ON”**.

Note: After the settings have been applied, the EM4597 will reboot. Your device will no longer be connected to the wireless network SSID of the EM4597. Reconnect your device to the Wireless network (SSID) you entered in step 5.

6.0 Access Point mode

- First make sure the mode selector switch is set to **“AP”** position for **“AP”** mode.
- Connect the EM4597 to a wall outlet (preferably close to the modem/router).
- Wait for the signal indicator to light up all three leds. This will take approximately 1 minute.
- Connect to the EM4597 via Wi-Fi SSID: **Eminent_repeater** or **Eminent_repeater(5G)**, or use the Ethernet cable to connect directly from your PC LAN port to the EM4597 **“LAN”** port.
- Open your internet browser and type <http://192.168.10.1> in your internet browser and then hit Enter.

6. The login screen will appear. Enter the **Username:** “admin” and **Password:** “admin”, then click “**Login**” to login.

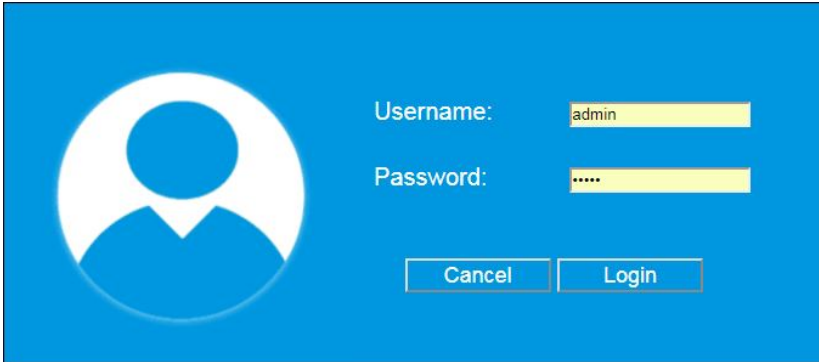

7. Select “**AP Wizard**” from the Menu.

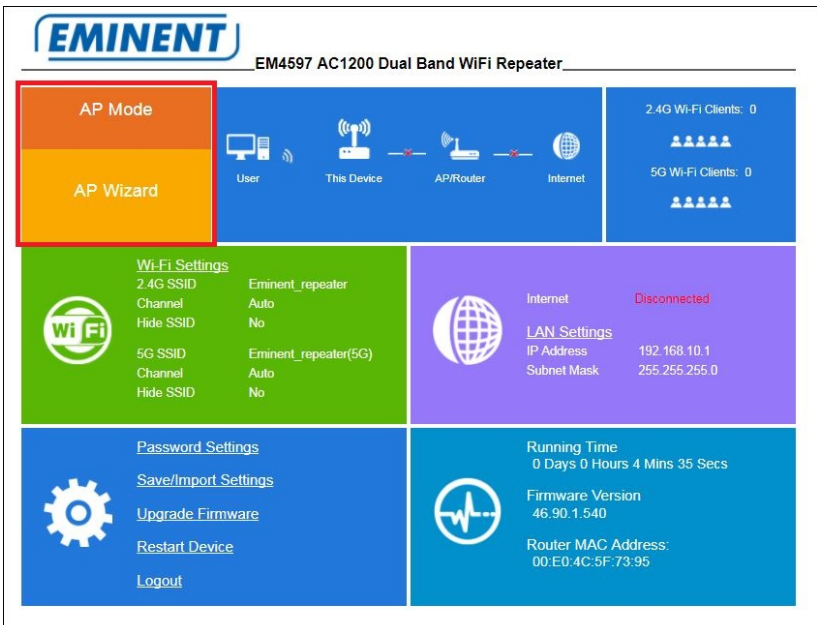

EMINENT EM4597 AC1200 Dual Band WiFi Repeater

AP Mode

AP Wizard

User This Device AP/Router Internet

2.4G Wi-Fi Clients: 0

5G Wi-Fi Clients: 0

Wi-Fi Settings

| | |
|-----------|----------------------|
| 2.4G SSID | Eminent_repeater |
| Channel | Auto |
| Hide SSID | No |
| 5G SSID | Eminent_repeater(5G) |
| Channel | Auto |
| Hide SSID | No |

Internet Disconnected

LAN Settings

| | |
|-------------|---------------|
| IP Address | 192.168.10.1 |
| Subnet Mask | 255.255.255.0 |

Password Settings

[Save/Import Settings](#)

[Upgrade Firmware](#)

[Restart Device](#)

[Logout](#)

Running Time

0 Days 0 Hours 4 Mins 35 Secs

Firmware Version

46.90.1.540

Router MAC Address:

00:E0:4C:5F:73:95

8. The following screen will appear:

The screenshot displays two sections for Wi-Fi settings. The top section is titled "2.4G Wi-Fi Settings" and includes fields for "WiFi SSID" (Eminent_repeater AP), "Encrypted" (Encrypted), "Wi-Fi Key" (empty), and "Channel" (Auto). A "Hide SSID" checkbox is present. The bottom section is titled "5G Wi-Fi Settings" and includes fields for "WiFi SSID" (Eminent_repeater(5G) AP), "Encrypted" (Encrypted), "Wi-Fi Key" (empty), and "Channel" (Auto). A "Hide SSID" checkbox is also present. At the bottom of the interface are "Cancel" and "Save" buttons.

9. You will notice that the repeater will automatically fill in the default SSID name from repeater in to SSID field. It is not necessarily needed but we suggest to rename the SSID name to: SSID name + AP so you will always know that you are connected as Access Point.
10. You also have the option to secure the Wi-Fi network by adding an encryption key. Click in the **"Encrypted"** field to change the security. Now enter an encryption key in the **"Wi-Fi Key"** field.
11. Click **"Save"** to confirm. The repeater will reboot and make the changes. This will take approximately 1 minute.
12. Remove the repeater from the power socket or switch off the repeater by switching the **"On/Off"** button to **"Off"**.
13. Install your Ethernet cable from modem/router or router into the **"LAN/WAN"** port of the repeater.
14. Connect the EM4597 back to the wall outlet and make sure the **"On/Off"** button is switched to **"ON"**
15. Wait until the "signal indicator" lights up the three leds. This will take approximately 1 minute.
16. You can now make wireless connection with new made SSID as Access Point. If you would like to make connection with a PC, you have to repeat step 12 to 15 only now by plugging in a Ethernet cable into **"LAN"** port from your Access point to the LAN port from your PC.

7.0 Frequently Asked Questions and other related information

The latest Frequently asked questions for your product can be found on the support page of your product. Eminent will update these pages frequently to assure you have the most recent information. Visit www.eminent-online.com for more information about your product.

8.0 Service and support

This user manual has been carefully written by Eminent's technical experts. If you have problems installing or using the product, please fill out the support form at the website www.eminent-online.com/support.

You can also contact us by phone. Please check www.eminent-online.com/support for the helpdesk phone number and opening hours.

9.0 Warning and points of attention



Due to laws, directives and regulations set out by the European parliament, some (wireless) devices could be subject to limitations concerning its use in certain European member states. In certain European member states the use of such devices could be prohibited. Contact your (local) government for more information about this limitations.

Always follow up the instructions in the manual*, especially where it concerns devices which need to be assembled.

Warning: In most cases this concerns an electronic device. Wrong/improper use may lead to (severe) injuries!

When you connect the device to the mains, make sure it will not be damaged or subject to (high) pressure.

A power socket is needed which should be close and easy accessible from the device.

Repairing of the device should be done by qualified Eminent staff. Never try to repair the device yourself. The warranty immediately voids when products have undergone self-repair and/or by misuse. For extended warranty conditions, please visit our website at www.eminent-online.com/warranty.

Dispose of the device appropriately. Please follow your countries regulation for the disposal of electronic goods.

Please check below safety points carefully:

- Do not apply external force on the cables
- Do not unplug the device by pulling the power cable
- Do not place the device near heating elements
- Do not let the device come in contact with water or other liquids
- If there is any strange sound, smoke or odor, remove the device immediately from the power outlet.
- Do not put any sharp objects into the venting hole of a product
- Do not use any damaged cables (risk of electric shock)
- Keep the product out of reach of children
- Wipe off the product with soft fabric, not water mop.
- Keep the power plug and outlet clean
- Do not unplug the device from the power outlet with wet hands
- Unplug the device when you don't use it for a long time
- Use the device at a well ventilated place

**Tip: Eminent manuals are written with great care. However, due to new technological developments it can happen that a printed manual does not longer contain the most recent information. If you are experiencing any problems with the printed manual or you cannot find what you are looking for, please always check our website www.eminent-online.com first for the newest updated manual.*

Also, you will find frequently asked questions in the FAQ section. It is highly recommended to consult the FAQ section. Very often the answer to your questions will be found here.

10.0 Warranty conditions

The Eminent warranty applies to all Eminent products. After buying a second-hand Eminent product the remaining period of warranty is measured from the moment of purchase by the product's initial owner. Eminent warranty applies to all Eminent products and parts, indissolubly connected or mounted to the product it concerns. Power supply adapters, batteries, antennas and all other products not directly integrated in or connected to the main product or products of which, without reasonable doubt, can be assumed that wear and tear during use will show a different pattern than the main product, are not covered by the Eminent warranty. Products are not covered by the Eminent warranty when exposed to incorrect/improper use, external influences or when opening the service parts of the product by parties other than Eminent. Eminent may use refurbished materials for repair or replacement of your defective product. Eminent cannot be held responsible for changes in network settings by internet providers. We cannot guarantee that the Eminent networking product will keep working when settings are changed by the internet providers. Eminent cannot guarantee the working of web services, apps and other third party content that is available through Eminent products.

When my product gets defective

Should you encounter a product rendered defective for reasons other than described above: Please contact your point of purchase for taking care of your defective product.



Trademarks: all brand names are trademarks and/or registered trademarks of their respective holders. The information contained in this document has been created with the utmost care. No legal rights can be derived from these contents. Eminent cannot be held responsible, nor liable for the information contained in this document.



Eminent is a member of the Intronics Group