



# RT-AC55U Dual Band Wireless-AC1200 Gigabit Router



## Quick Start Guide

NA9135 / Second Edition / June 2014



## Table of contents

English .....	3
繁體中文 .....	16
Français .....	29
Português.....	42
Español.....	55

---

### **NOTE / <注意> / <REMARQUE> / <NOTA> / <NOTA>**

- For more details, refer to the user manual included in the support CD.
  - 更多資訊，請參考請參考驅動程式與公用程式光碟中的使用手冊。
  - Pour plus de détails, consultez le manuel de l'utilisateur contenu dans le CD de support.
  - Para mais detalhes, consulte o manual do utilizador incluído no CD de suporte.
  - Para obtener más detalles, consulte el manual del usuario incluido en el CD de soporte.
- 





## Package contents

- ☑ RT-AC55U wireless router
- ☑ Network cable (RJ-45)
- ☑ Support CD (User Guide)
- ☑ AC adapter
- ☑ Quick Start Guide
- ☑ Two external antennas



**NOTE:** If any of the items is damaged or missing, contact your retailer.

English

## A quick look at your RT-AC55U

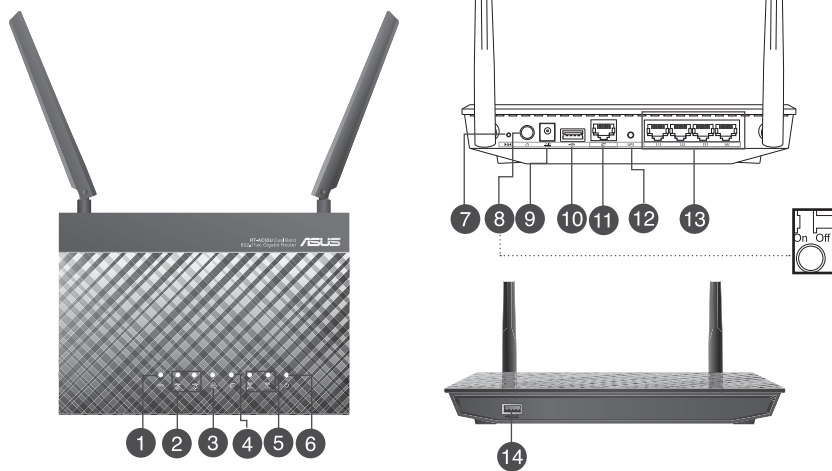

1) WPS LED	6) Power LED	11) WAN (Internet) port
2) USB3.0/2.0 LED	7) Reset button	12) WPS button
3) LAN 1~4 LED	8) Power switch	13) LAN 1~4 ports
4) WAN (Internet) LED*	9) Power (DC-IN) port	14) USB3.0 port
5) 2.4GHz / 5GHz LED	10) USB2.0 port	



\* **WAN (Internet) LED indications**

Status	Indications
Off	No power.
Blue light on	Successful physical connection to a wide area network (WAN).
Red light on	<ul style="list-style-type: none"><li>• No physical connection to WAN;</li><li>• Limited or no Internet connection;</li><li>• In the rescue mode.</li></ul>



**NOTES:**

• **USB External HDD/Flash disk:**

- The wireless router works with most USB HDDs/Flash disks up to 2TB and supports read-write access for FAT16, FAT32, EXT2, EXT3, and NTFS.
- To safely remove the USB disk, launch the web GUI (<http://router.asus.com> or <http://192.168.1.1>), then in the **Network Map** page's upper right corner, click the USB icon and click **Eject USB disk**.
- Incorrect removal of the USB disk may cause data corruption.
- For the list of file system and hard disk partitions that the wireless router supports, visit <http://event.asus.com/networks/disksupport>
- For the list of printers that the wireless router supports, visit <http://event.asus.com/networks/printersupport>

## Installing your router



**IMPORTANT:** Before installing the router, ensure that Internet connection is available

### 1. Position your wireless router.

For the optimal wireless transmission between the wireless router and connected wireless devices, ensure that you:

- Place the wireless router in a centralized area for a maximum wireless coverage for the network devices.
- Keep the wireless router away from metal obstructions and away from direct sunlight.
- Keep the wireless router away from 802.11g or 20MHz only Wi-Fi devices, 2.4GHz computer peripherals, Bluetooth devices, cordless phones, transformers, heavy-duty motors, fluorescent lights, microwave ovens, refrigerators, and other industrial equipment to prevent signal interference or loss.
- To ensure the best wireless signal, orient the two detachable antennas as shown in the drawing below.
- Always update to the latest firmware. Visit the ASUS website at <http://www.asus.com> to get the latest firmware updates.

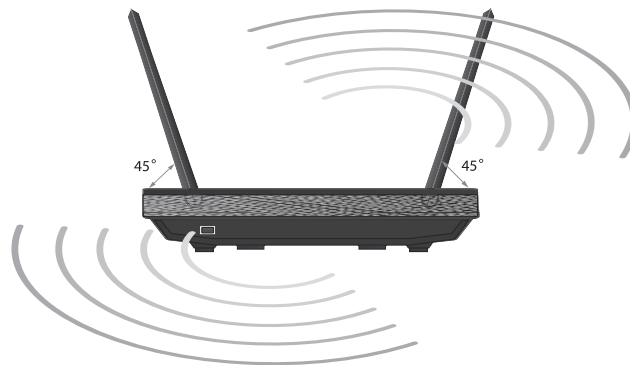

## 2. Prepare your modem.

- Unplug the AC adapter from the power outlet and disconnect it from your cable/ADSL modem.
- Disconnect the network cable from your cable/ADSL modem.
- Reboot your computer (recommended).

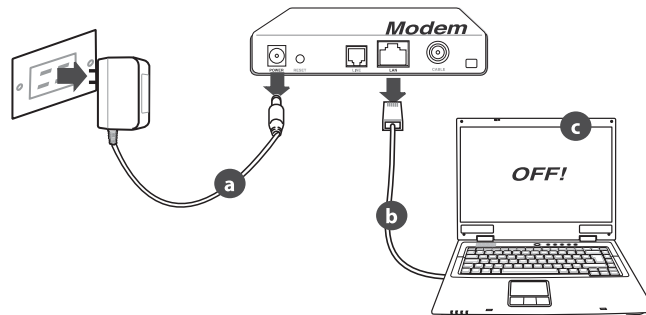

**WARNING!** Before disconnecting the wires/cables, ensure that your cable/ADSL modem has been turned off for at least two minutes. If your modem has a backup battery, remove it as well.

## 3. Set up your wireless environment.

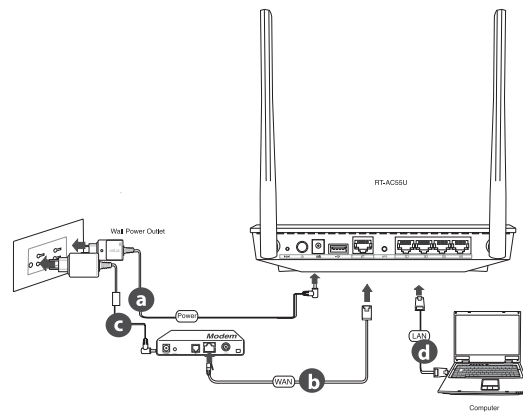



- a. Insert your wireless router's AC adapter to the DC-IN port and plug it to a power outlet.
- b. Using another network cable, connect your modem to your wireless router's WAN port.
- c. Insert your modem's AC adapter to the the DC-IN port and plug it to a power outlet.
- d. Using the bundled network cable, connect your computer to your wireless router's LAN port. Ensure that the WAN and LAN LEDs are blinking.

**4. Disable some settings on your computer.**

- a. Disable the proxy server, if enabled.
- b. Set the TCP/IP settings to automatically obtain an IP address.
- c. Disable the dial-up connection, if enabled.



---

**NOTE:** For more details on disabling your computer settings, refer to *Frequently Asked Questions (FAQs)*.

---



## Setting up your router using the Quick Internet Setup Wizard

To set up your router using QIS (Quick Internet Setup):

1. Press the power button at the back of your router. Ensure that the Power, LAN and WAN LEDs are on.
2. Launch your web browser such as Internet Explorer, Firefox, Google Chrome, or Safari.



**NOTE:** If QIS does not launch automatically, enter <http://192.168.1.1> or <http://router.asus.com> in the address bar and refresh the browser again.

3. Assign your router login name and password and click **Next**. You will need this login name and password to log into RT-AC55U to view or change the router settings. You can take note of your router login name and password for future use.



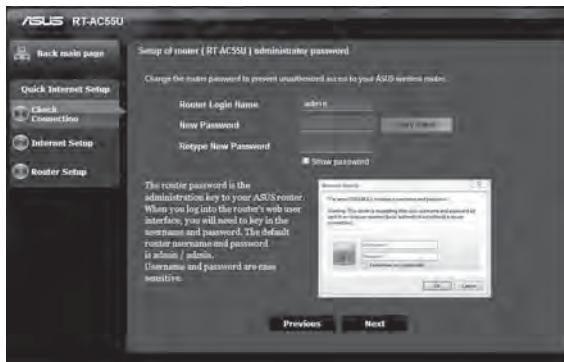

Login name: \_\_\_\_\_

Login password: \_\_\_\_\_

English

4. The wireless router's Quick Internet Setup (QIS) feature automatically detects if your ISP connection type is **Dynamic IP**, **PPPoE**, **PPTP**, **L2TP**, and **Static IP**. Please obtain the necessary information about your Internet connection type from your Internet Service Provider (ISP). If your connection type is Dynamic IP (DHCP), QIS wizard will automatically direct you to the next step.



**NOTE:** If your connection type is Static IP, choose **Static IP** and click **Next**. Key in IP address, subnet mask, default gateway and DNS server information provided by your ISP. Click **Next** to proceed.

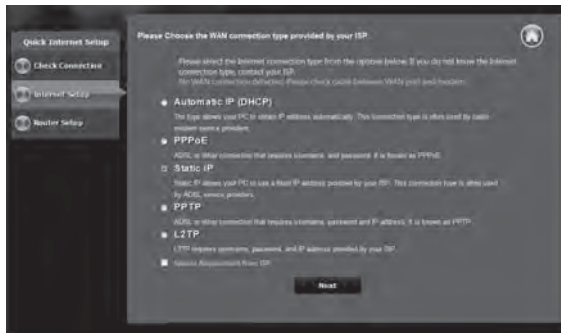



English



5. Assign the network name (SSID) and security key for your 2.4GHz and 5GHz wireless connection. Click **Apply** when done.



6. Your Internet and wireless settings are displayed. Click **Next** to continue.  
 7. Read the wireless network connection tutorial. When done, click **Finish**.



**NOTES:**

- You can assign a network name with up to 32 characters.
- Watch the setup tutorial video if needed.





## Connect to the wireless network

There are two ways for your wireless clients (notebook, tablet PC, smartphone and so on) to connect to RT-AC55U's wireless network.

### Connect to the wireless network manually

To connect to the wireless network manually:

1. Enable the Wi-Fi function on your wireless client to scan for available wireless networks.
2. Select the SSID or network name that you assigned to your RT-AC55U's network.
3. Enter the password and click **Connect**.

### Connect to the wireless network through WPS

RT-AC55U has a WPS (Wi-Fi Protected Setup) button for you to connect your wireless client to RT-AC55U's network without entering password.

To connect to the wireless network through WPS:

1. Press the WPS button at the back of RT-AC55U. Refer to the section **A quick look at your RT-AC55U** for the location of the WPS button).
2. Press the WPS button of your wireless client within two minutes or follow the WPS instructions that came with the wireless client. When connecting via WPS, the WPS LED on your router blinks fast.
3. Wait until your router's WPS LED turns into a solid light for a few seconds and then turns off, which indicates a successful connection between your router and your wireless client.





**English**

### Managing the router via the ASUSWRT web GUI

Your wireless router comes with the intuitive ASUSWRT web graphical user interface. ASUSWRT allows you to easily configure its various features through a web browser such as Internet Explorer, Firefox, Safari, or Google Chrome.



**NOTE:** Use the search bar on the bottom of the interface to get more information from ASUS technical support site <http://support.asus.com>.



**IMPORTANT:**

- For more details on using your router's Web GUI, refer to the user manual.
- Always check and upgrade firmware to the latest version for better experience.
- Visit ASUS Networking video channel for tutorial videos on featured functions.





## AiCloud

ASUS AiCloud app provides you with access to your data wherever and whenever you have an Internet connection. It also allows you to access your ASUS WebStorage account via the AiCloud mobile app on your iOS or Android device, or via a web browser.

To install AiCloud:

1. Ensure that your router's firmware version is the latest one and supports AiCloud.
2. Download AiCloud app from Google Play or App Store.
3. Install your USB storage device to your router. Refer to section **A quick look at your RT-AC55U** for the location of the USB ports.
4. Connect your iOS or Android devices to the router through Wi-Fi. The AiCloud app will automatically guide you through the setup process.
5. You can now access, stream and share to all files in your USB storage. Search ASUS AiCloud for more information. Watch tutorial videos for step-by-step guide.

English



Google Play



App Store



## Frequently Asked Questions (FAQs)

### **After following the steps, I still cannot access the wireless router's web graphics user interface (web GUI) to configure the wireless router settings.**

Ensure that your PC's proxy settings are disabled and your PC'S IP address is obtained from the DHCP server automatically. for details on disabling the proxy settings, visit the ASUS Support site at <http://support.asus.com>. For details on using the DHCP server to obtain IP addresses automatically, refer to your Windows® or Mac operating system's help feature.

### **The client cannot establish a wireless connection with the router.**

#### **Out of Range:**

- Put the router closer to the wireless client.
- Try to change the channel settings.

#### **Authentication:**

- Use wired connection to connect to the router.
- Check the wireless security settings.
- Press the Reset button at the rear panel for more than five seconds.

#### **Cannot find the router:**

- Press the Reset button at the rear panel for more than five seconds.
- Check the setting in the wireless adapter such as SSID and encryption settings.

#### **Cannot access the Internet via wireless LAN adapter.**

- Move the router closer to the wireless client.
- Check whether the wireless adapter is connected to the correct wireless router.
- Check whether the wireless channel in use conforms to the channels available in your country/area.
- Check the encryption settings.



- Check if the ADSL or Cable connection is correct.
- Retry using another Ethernet cable.

**If the ADSL “LINK” light blinks continuously or stays off, Internet access is not possible - the Router is unable to establish a connection with the ADSL network.**

- Ensure that all your cables are all properly connected .
- Disconnect the power cord from the ADSL or cable modem, wait a few minutes, then reconnect the cord.
- If the ADSL light continues to blink or stays OFF, contact your ADSL service provider.

**Network name or encryption keys are forgotten.**

- Try setting up the wired connection and configuring the wireless encryption again.
- Press the Reset button of the wireless router for more than five seconds.
- Factory default settings:

<b>User name / Password:</b> admin / admin	<b>IP address:</b> 192.168.1.1	<b>SSID:</b> ASUS
---	-----------------------------------	----------------------

**Where can I find more information about the wireless router?**

- User Manual in the support CD
- Online FAQ site: <http://support.asus.com/faq>
- Technical Support site: <http://support.asus.com>
- Customer Hotline: Refer to the Support Hotline in this Quick Start Guide



## 包裝內容物

- ☑ RT-AC55U 無線路由器
- ☑ RJ-45 網路線
- ☑ 使用手冊光碟
- ☑ 電源變壓器
- ☑ 快速使用指南
- ☑ 外接天線 x2



注意：若以上列出的任何一項配件有毀損或是短缺的情形，請儘速聯絡您的經銷商。

## 認識您的 RT-AC55U 無線路由器

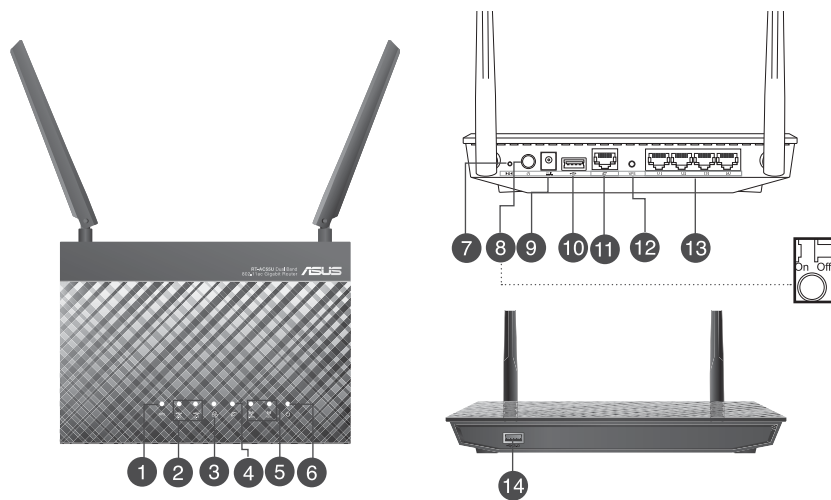

1)WPS 指示燈	6) 電源指示燈	11)WAN (網際網路)連接埠
2)USB3.0/2.0 指示燈	7) 重置按鈕	12)WPS 按鈕
3)LAN 1~4 指示燈	8)電源開關	13)LAN 1~4 連接埠
4)WAN (網際網路) 指示燈*	9)電源輸入埠 (DC-IN)	14)USB3.0 連接埠
5)2.4GHz / 5GHz 指示燈	10)USB2.0 連接埠	



## \* WAN（網際網路）指示燈說明

狀態	說明
熄滅	無電源。
藍燈亮	有實體連接至廣域網路（WAN）
紅燈亮	<ul style="list-style-type: none"><li>無實體連接至廣域網路（WAN）。</li><li>無網際網路連線或連線受限制。</li><li>裝置處於救援模式。</li></ul>



## 注意：

- USB 外接硬碟 / 隨身碟：
  - 此無線路由器相容大多數容量高達 2TB 的 USB 硬碟 / 隨身碟，並支援 FAT16、FAT32、EXT2、EXT3 與 NTFS 的存取。
  - 欲安全移除 USB 磁碟，請登入網頁圖形使用者介面（<http://router.asus.com> 或 <http://192.168.1.1>），接著在「網路地圖」頁面的右上角點選 USB 圖示並選擇 **退出 USB 磁碟**。
  - 錯誤移除 USB 碟將會導致資料遺失。
  - 請造訪 <http://event.asus.com/networks/disksupport> 獲得此無線路由器所支援的檔案系統與硬碟磁區清單。
- 請造訪 <http://event.asus.com/networks/printersupport> 獲得此無線路由器所支援的印表機清單。

## 安裝您的路由器



**重要！** 安裝路由器之前，請確認網際網路連線可用。

### 1. 放置您的路由器

為獲得無線路由器與所連線的網路裝置之間的最佳無線傳送訊號，請確認以下幾點：

- 建議將路由器放置在中心區域，以覆蓋所有無線行動裝置。
- 請勿將裝置放在靠近金屬物品與陽光直射的地方。
- 請遠離其它 802.11g 或 20MHz Wi-Fi 裝置、2.4GHz 電腦周邊裝置、藍芽裝置、無線室內電話、傳送器、重型發動機、日光燈、微波爐、電冰箱與其他工業裝置，以防止訊號干擾或丟失。
- 請按照下圖所示擺放路由器上的兩根可拆卸式天線以獲得最佳前後訊號覆蓋。
- 請經常更新至最新版本韌體。您可以登入華碩官網 <http://tw.asus.com> 獲得最新韌體。





## 2. 準備數據機

- 拔掉 AC 變壓器的電源並斷開與有線 / ADSL 數據機的連接。
- 拔掉您有線 / ADSL 數據機的網路線。
- 重新開啟您的電腦（建議執行）。

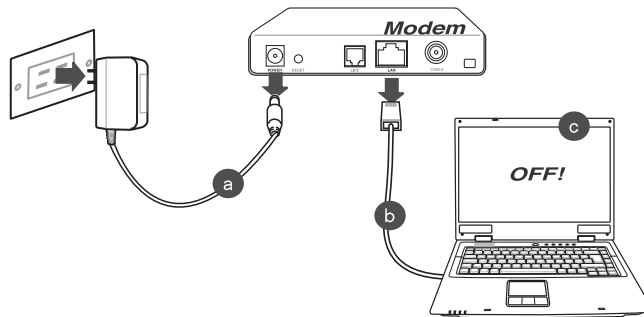

**警示！**請在斷開數據纜線與網路線之前，確認您的有線 / ADSL 已關閉超過二分鐘。若您的數據機有備用電池，請一併移除。

## 3. 設定無線環境

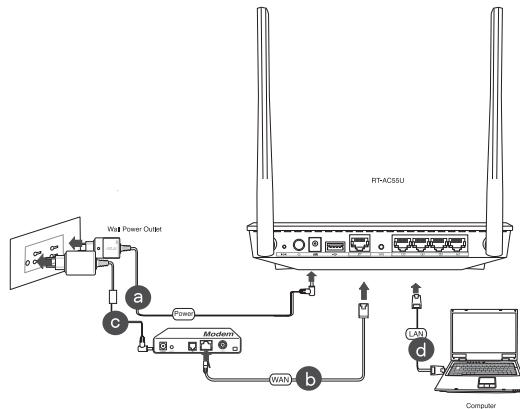

- a. 將無線路由器的 AC 變壓器插入電源輸入埠 (DC-IN) 並插上電源。
- b. 用另一條網路線將您的數據機連接至無線路由器的 WAN 連接埠。
- c. 將數據機的 AC 變壓器插入電源輸入埠 (DC-IN) 並插上電源。
- d. 使用附贈的網路線將您的電腦連接至您的無線路由器的 LAN 連接埠。

#### 4. 關閉電腦中的某些設定

- a. 若開啟了代理伺服器，請將其關閉。
- b. 設定 TCP/IP 自動取得 IP 位址。
- c. 關閉撥號連線。



---

注意：更多資訊請參閱「常見問題解答 (FAQs)」。

---



## 使用網路設定精靈 (QIS) 設定路由器

依據以下步驟進行設定：

1. 按下路由器後側的電源按鈕。確定電源指示燈、LAN 指示燈以及 WAN 指示燈亮起。
2. 開啟一個網路瀏覽器，如 Internet Explorer、Firefox、Safari 或 Google Chrome。



注意：若網路設定精靈 (QIS) 未能自動開啟，請在您的網路瀏覽器中輸入 <http://192.168.1.1> 或 <http://router.asus.com> 並重新載入頁面。

3. 為路由器設定登入名稱與密碼，接著點選 **Next**。您需要使用此名稱與密碼來登入 RT-AC55U 檢視並變更路由器設定。記錄下路由器登入名稱與密碼以備日後使用。





登入名稱：

登入密碼：

- 此路由器的網路設定精靈 (QIS) 可自動偵測 ISP 連線類型：自動取得 IP、PPPoE、PPTP、L2TP 與固定 IP。請從您的 ISP 獲得網路連接類型的相關資訊。若您的網路連線類型為「自動取得 IP」(DHCP)，網路設定精靈 (QIS) 將自動引導您進入下一步。



**注意：**若您的網路連線類型為固定 IP，選擇「Static IP」並點選 **Next**。輸入 IP 位址、子網路遮罩、預設閘道以及 DNS 伺服器資訊。點選 **Next** 繼續。

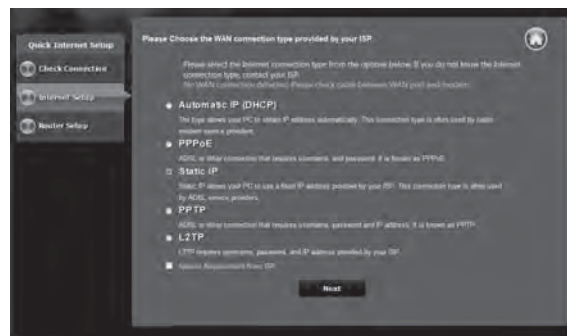



5. 指定網路名稱 (SSID) 與安全密鑰以連接 2.4GHz 與 5GHz 無線網路。完成後點選 **Apply**。



6. 畫面將顯示您的網路與無線設定。點選 **Next** 繼續。
7. 閱讀無線網路連線教程。完成後點選 **Finish**。



**注意：**

- 您可以指定一個多達 32 字元的網路名稱。
- 若有需要，觀看設定視訊教程。



## 連線到無線網路

無線用戶端（筆電、平板電腦以及智慧型手機等）可以透過兩種方式連線到 RT-AC55U 的無線網路。

### 手動連線到無線網路

1. 開啟行動裝置的 Wi-Fi 功能，並搜尋可用的無線網路。
2. 選擇您指定給 RT-AC55U 網路的 SSID 或網路名稱。
3. 輸入密碼，並點選 **Connect**。

### 透過 WPS 連線到無線網路

RT-AC55U 路由器具備一個 WPS 按鈕，無需輸入密碼您就可以連線無線用戶端至 RT-AC55U 的網路。

1. 按下 RT-AC55U 後側的 WPS 按鈕。參考「認識您的 RT-AC55U 無線路由器」部份的說明找到 WPS 按鈕的具體位置。
2. 在兩秒內按下無線用戶端的 WPS 按鈕，或依據無線用戶端附贈的 WPS 說明操作。透過 WPS 連線時，路由器上的 WPS 指示燈快速閃爍。
3. 等待路由器的 WPS 指示由閃爍轉為常亮數秒，即表示路由器與無線用戶端成功建立連線。





## 透過 ASUSWRT 網頁圖形使用介面管理路由器

您的無線路由器配備一個直覺式 ASUSWRT 網頁圖形使用介面。ASUSWRT 允許您透過網頁瀏覽器（如 Internet Explorer、Firefox、Safari 或 Google Chrome）輕鬆設定各項功能。



**注意：**點選使用者介面底部的搜尋列可從 ASUS 技術支援網站 <http://support.asus.com> 獲得更多資訊。



繁體中文



**注意：**

- 關於使用路由器網頁圖形使用者介面的詳細資訊，請參考使用手冊的說明。
- 經常檢查並更新韌體至最新版本以獲得最佳使用體驗。
- 造訪 ASUS Networking 視訊頻道獲得更多教學視訊。



## AiCloud

ASUS AiCloud 應用程式可讓您在有網際網路連線的情況下隨時隨地存取您的資料。您可以透過 iOS 或 Android 裝置上的 AiCloud 行動應用程式存取您的 ASUS WebStorage 帳戶。

依據以下步驟安裝 AiCloud：

1. 確定您的路由器之韌體為最新版本，且支援 AiCloud。
2. 從 Google Play 或 App Store 下載 AiCloud 應用程式。
3. 將 USB 儲存裝置連接到路由器。請參考「認識您的 RT-AC55U 無線路由器」部份的說明找到 USB 連接埠的具體位置。
4. 將 iOS 或 Android 裝置透過 Wi-Fi 連線到路由器。AiCloud 應用程式將自動引導您進行設定。
5. 現在您就可以存取、串流並分享 USB 儲存裝置中的所有檔案。搜尋 ASUS AiCloud 獲得更多資訊。請觀看教學視訊了解具體設定步驟。



Google Play



App Store



## 常見問題解答 (FAQ)

按照以上步驟執行後，我依然無法獲得無線路由器的網頁圖形使用者介面 (web GUI) 以設定無線路由器。

確定關閉您電腦上的代理設定，並且您的電腦的 IP 位址為自動從 DHCP 伺服器獲得。關於關閉代理設定的詳細資訊，請造訪 ASUS 支援網站 <http://support.asus.com>。關於使用 DHCP 伺服器自動獲得 IP 位址的詳細資訊，請參考您的 Windows® 或 Mac 作業系統說明。

### 無法建立無線網路連線

#### 超出有效範圍：

- 請將路由器放置於較靠近用戶端裝置之處。
- 嘗試進行頻道設定的變更。

#### 認證問題：

- 請使用採用有線連線的電腦來連接路由器。
- 檢查網路安全設定。
- 您可以嘗試按路由器後方的重置 (Reset) 按鈕超過 5 秒鐘後，進行硬體重置的動作。

#### 無法搜尋到路由器：

- 您可以嘗試按路由器後方的重置 (Reset) 按鈕超過 5 秒鐘後，進行硬體重置的動作。
- 檢查無線網路卡上的 SSID 與加密等設定。

#### 無法透過無線網路卡來連線至網際網路。

- 請將路由器更換至用戶端可以連線到的範圍內。
- 檢查您所使用的無線網路卡是否有連線到正確的路由器。
- 檢查所使用的無線網路頻道是符合您的所在地區 / 國家所規範的頻道。



- 檢查加密設定。
- 檢查您所使用的 ADSL 或有線數據機是否有連接至正確的網路埠。
- 重新更換另一條乙太網路線來連接。

當 ADSL 數據機「Link」（連線）的燈號持續閃爍或熄滅，這表示無法存取至網際網路 - 路由器無法與 ADSL 網路建立連線。

- 請確認網路線已有正確連接。
- 請將 ADSL 或有線數據機的電源線拔除，並等待幾分鐘後，再重新接上電源。
- 若 ADSL 數據機燈號持續閃爍或為熄滅（顯示 OFF）的狀態，請與您的網路電信業者聯絡。

忘記網路名稱或金鑰密碼。

- 試著再次透過有線連接來設定無線的加密動作。
- 按下位於路由器後方的重置（Reset）按鈕超過 5 秒鐘後，進行硬體重置的動作。
- 出廠預設值設定：

使用者名稱 / 密碼： admin / admin	IP 位址： 192.168.1.1	SSID： ASUS
------------------------------	-----------------------	---------------

哪裡可以找到更多的無線路由器資訊？

- 驅動程式與公用程式光碟中的使用手冊
- 線上 FAQ 網址：<http://support.asus.com/faq>
- 技術支援網址：<http://support.asus.com>
- 客戶服務熱線：請參閱此快速使用指南的支援熱線

## Contenu de la boîte

- ☑ Routeur sans fil RT-AC55U
- ☑ Adaptateur secteur
- ☑ CD de support (Manuel + utilitaires)
- ☑ Câble réseau
- ☑ Guide de démarrage rapide
- ☑ Deux antennes externes



**REMARQUE :** contactez votre service après-vente ASUS si l'un des éléments est manquant ou endommagé.

## Aperçu rapide de votre RT-AC55U

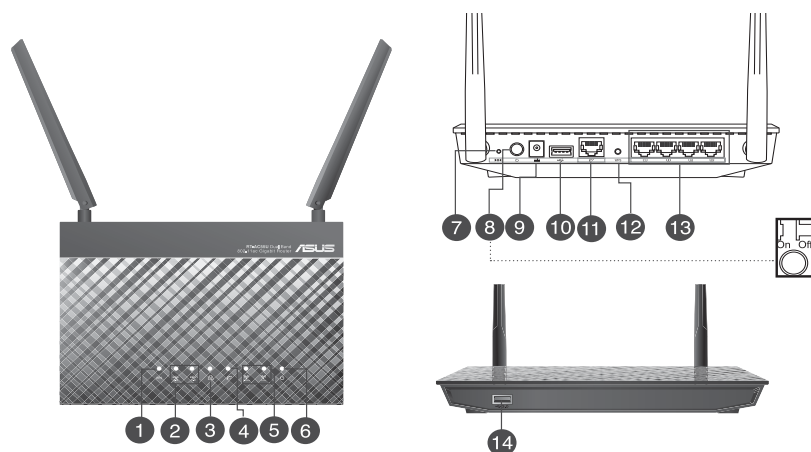

1) LED WPS	6) LED d'alimentation	11) Port réseau étendu (Internet)
2) LED USB3.0/2.0	7) Bouton de réinitialisation	12) Bouton WPS
3) LED réseau local 1~4	8) Interrupteur d'alimentation	13) Port réseau local 1~4
4) LED réseau étendu (Internet)*	9) Prise d'alimentation	14) Port USB3.0
5) LED 2.4GHz / 5GHz	10) Port USB2.0	

\* **Tableau explicatif du témoin Internet**

État	Indication
Éteint	Routeur éteint
Bleu	Connexion Internet établie
Rouge	<ul style="list-style-type: none"><li>• Aucune connexion physique à Internet</li><li>• Connexion Internet limitée ou indisponible</li><li>• Mode Secours activé</li></ul>

**REMARQUES :**• **Périphérique de stockage USB externe :**

- Le routeur sans fil fonctionne avec la plupart des périphériques de stockage USB d'une taille maximum de 3To et supporte la lecture/écriture pour les formats de fichiers FAT16, FAT32, EXT2, EXT3 et NTFS
- Pour retirer un lecteur USB en toute sécurité, allez dans l'interface de gestion du routeur (<http://router.asus.com> ou <http://192.168.1.1>), puis cliquez sur l'icône **USB** située sur le coin supérieur droit de l'écran **Network Map** (Carte réseau). Cliquez ensuite sur **Eject USB Disk** (Éjecter le lecteur USB).
- Une mauvaise éjection du périphérique de stockage peut endommager les données contenues sur le disque.
- Pour consulter la liste des systèmes de fichiers et de partitions de disques supportés par le routeur sans fil, visitez le site <http://event.asus.com/networks/disksupport>
- Pour consulter la liste des imprimantes supportées par le routeur sans fil, visitez le site <http://event.asus.com/networks/printersupport>