



VigorPro 5500 Series Unified Security Firewall User's Guide

Version: 3.0

Date: 2007/05/02

Copyright 2007 All rights reserved.

This publication contains information that is protected by copyright. No part may be reproduced, transmitted, transcribed, stored in a retrieval system, or translated into any language without written permission from the copyright holders. The scope of delivery and other details are subject to change without prior notice.

Microsoft is a registered trademark of Microsoft Corp.

Windows, Windows 95, 98, Me, NT, 2000, XP and Explorer are trademarks of Microsoft Corp.

Apple and Mac OS are registered trademarks of Apple Computer Inc.

Other products may be trademarks or registered trademarks of their respective manufacturers.

Safety Instructions and Approval

Safety Instructions

- Read the installation guide thoroughly before you set up the router.
- The router is a complicated electronic unit that may be repaired only by authorized and qualified personnel. Do not try to open or repair the router yourself.
- Do not place the router in a damp or humid place, e.g. a bathroom.
- The router should be used in a sheltered area, within a temperature range of +5 to +40 Celsius.
- Do not expose the router to direct sunlight or other heat sources. The housing and electronic components may be damaged by direct sunlight or heat sources.
- Do not deploy the cable for LAN connection outdoor to prevent electronic shock hazards.
- Keep the package out of reach of children.
- When you want to dispose of the router, please follow local regulations on conservation of the environment.

Warranty

We warrant to the original end user (purchaser) that the router will be free from any defects in workmanship or materials for a period of two (2) years from the date of purchase from the dealer. Please keep your purchase receipt in a safe place as it serves as proof of date of purchase. During the warranty period, and upon proof of purchase, should the product have indications of failure due to faulty workmanship and/or materials, we will, at our discretion, repair or replace the defective products or components, without charge for either parts or labor, to whatever extent we deem necessary to restore the product to proper operating condition. Any replacement will consist of a new or re-manufactured functionally equivalent product of equal value, and will be offered solely at our discretion. This warranty will not apply if the product is modified, misused, tampered with, damaged by an act of God, or subjected to abnormal working conditions. The warranty does not cover the bundled or licensed software of other vendors. Defects which do not significantly affect the usability of the product will not be covered by the warranty. We reserve the right to revise the manual and online documentation and to make changes from time to time in the contents hereof without obligation to notify any person of such revision or changes.

Be a Registered Owner

Web registration is preferred. You can register your Vigor router via <http://www.draytek.com>.

Firmware & Tools Updates

Please consult the DrayTek web site for more information on newest firmware, tools and documents. For more detailed information, please refer to <http://www.draytek.com>



Parts of the anti-virus features are powered by Kaspersky Lab ZAO. For more detailed information, please refer to <http://www.kaspersky.com>.

European Community Declarations

Manufacturer: DrayTek Corp.
Address: No. 26, Fu Shing Road, HuKou County, HsinChu Industrial Park, Hsin-Chu, Taiwan 303
Product: VigorPro 5500

DrayTek Corp. declares that VigorPro 5500 Series is in compliance with the following essential requirements and other relevant provisions of R&TTE Directive 1999/5/EEC.

The product conforms to the requirements of Electro-Magnetic Compatibility (EMC) Directive 89/336/EEC by complying with the requirements set forth in EN55022/Class A and EN55024/Class A.

The product conforms to the requirements of Low Voltage (LVD) Directive 73/23/EEC by complying with the requirements set forth in EN60950.

Regulatory Information

Federal Communication Commission Interference Statement

This equipment has been tested and found to comply with the limits for a Class A digital device, pursuant to Part 15 of the FCC Rules. These limits are designed to provide reasonable protection against harmful interference in a residential installation. This equipment generates, uses and can radiate radio frequency energy and, if not installed and used in accordance with the instructions, may cause harmful interference to radio communications. However, there is no guarantee that interference will not occur in a particular installation. If this equipment does cause harmful interference to radio or television reception, which can be determined by turning the equipment off and on, the use is encouraged to try to correct the interference by one of the following measures:

- Reorient or relocate the receiving antenna.
- Increase the separation between the equipment and receiver.
- Connect the equipment into an outlet on a circuit different from that to which the receiver is connected.
- Consult the dealer or an experienced radio/TV technician for help.

This device complies with Part 15 of the FCC Rules. Operation is subject to the following two conditions:

- (1) This device may not cause harmful interference, and
- (2) This device may accept any interference received, including interference that may cause undesired operation.

Taiwanese BSMI (Bureau of Standards, Metrology and Inspection) A Warning:

Warning: This device might cause interference of radio frequency under the environment of dwelling. In such condition, the users might be asked to adopt some proper strategies.

Please visit "www.draytek.com/about_us/Regulatory.php"



This product is designed for the 2.4 GHz WLAN network throughout the EC region and Switzerland with restrictions in France.



This is a class A product. In a domestic environment, this product may cause radio interference in which case the user may be required to take adequate measures.

Table of Contents

1

Preface	1
1.1 Web Configuration Buttons Explanation	1
1.2 LED Indicators and Connectors	1
1.2.1 For VigorPro 5500	2
1.2.2 For VigorPro 5500G.....	3
1.2.3 For VigorPro 5500i.....	4
1.2.4 For VigorPro 5500Gi.....	5
1.3 Hardware Installation	7

2

Configuring Basic Settings	9
2.1 Changing Password.....	9
2.2 Quick Start Wizard	11
2.2.1 PPPoE	12
2.2.2 PPTP.....	14
2.2.3 Static IP.....	15
2.2.4 DHCP.....	16
2.3 Online Status.....	17
2.4 Saving Configuration.....	19

3

Advanced Web Configuration.....	21
3.1 WAN	21
3.1.1 Basics of Internet Protocol (IP) Network.....	21
3.1.2 General Setup.....	22
3.1.3 Internet Access	24
3.1.4 Load-Balance Policy	30
3.2 LAN	33
3.2.1 Basics of LAN	33
3.2.2 General Setup.....	35
3.2.3 Static Route	37
3.2.4 VLAN.....	40
3.2.5 Bind IP to MAC	41
3.3 NAT	42
3.3.1 Port Redirection	43
3.3.2 DMZ Host.....	46
3.3.3 Open Ports.....	48
3.4 Objects Settings	50
3.4.1 IP Object	50
3.4.2 IP Group	52
3.4.3 Service Type Object	53

3.4.4 Service Type Group.....	54
3.4.5 CSM Profile.....	55
3.5 Firewall.....	57
3.5.1 Basics for Firewall.....	57
3.5.2 General Setup.....	60
3.5.3 Filter Setup	62
3.5.4 DoS Defense	67
3.5.5 URL Content Filter	70
3.5.6 Web Content Filter.....	72
3.6 Anti-Intrusion	73
3.6.1 Basic Setup.....	73
3.6.2 Advanced Setup	74
3.7 Anti-Virus	77
3.7.1 Profile Setting	77
3.7.2 Virus List.....	79
3.7.3 File Pattern List.....	80
3.8 Anti-Spam.....	83
3.8.1 Profile Setting	83
3.8.2 Activating Anti-Spam	85
3.9 Bandwidth Management	85
3.9.1 Sessions Limit.....	86
3.9.2 Bandwidth Limit	87
3.9.3 Quality of Service.....	88
3.10 Applications	95
3.10.1 Dynamic DNS	95
3.10.2 Schedule.....	97
3.10.3 RADIUS	99
3.10.4 UPnP.....	100
3.10.5 Wake On LAN.....	102
3.11 VPN and Remote Access.....	103
3.11.1 Remote Access Control.....	103
3.11.2 PPP General Setup	104
3.11.3 IPSec General Setup.....	105
3.11.4 IPSec Peer Identity	106
3.11.5 Remote Dial-in User	108
3.11.6 LAN to LAN.....	111
3.11.7 Connection Management	119
3.12 Certificate Management.....	120
3.12.1 Local Certificate.....	120
3.12.2 Trusted CA Certificate	122
3.12.3 Certificate Backup.....	123
3.13 ISDN.....	123
3.13.1 Basic Concept.....	123
3.13.2 General Settings.....	124
3.13.3 Dial to Single/Dual ISPs.....	125
3.13.4 Virtual TA	128
3.13.5 Call Control	131
3.14 Wireless LAN	133
3.14.1 Basic Concepts.....	133
3.14.2 General Setup.....	135

3.14.3 Security	137
3.14.4 Access Control.....	138
3.14.5 WDS.....	140
3.14.6 AP Discovery	142
3.14.7 Station List	143
3.14.8 Station Rate Control	144
3.15 VLAN	144
3.15.1 Wired VLAN	144
3.15.2 Wireless VLAN.....	145
3.15.3 VLAN Cross Setup.....	148
3.15.4 Wireless Rate Control.....	150
3.16 System Maintenance.....	151
3.16.1 System Status.....	151
3.16.2 Administrator Password.....	152
3.16.3 Configuration Backup	153
3.16.4 Syslog/Mail Alert	154
3.16.5 Time and Date	156
3.16.6 Management.....	157
3.16.7 Reboot System	158
3.16.8 Firmware Upgrade	159
3.16.9 Signature Upgrade.....	160
3.17 Diagnostics.....	163
3.17.1 Dial-out Trigger	163
3.17.2 Routing Table	164
3.17.3 ARP Cache Table	164
3.17.4 DHCP Table.....	165
3.17.5 NAT Sessions Table	165
3.17.6 Wireless VLAN Online Station Table	166
3.17.7 Ping Diagnosis.....	167
3.17.8 Data Flow Monitor.....	168
3.17.9 Traffic Graph.....	169
3.17.10 Trace Route	170

4

Registration for the Router	171
4.1 Creating and Activating an Account from VigorPro Website	171
4.2 Creating and Activating an Account from Router Web Configurator.....	175
4.3 Registering Your Vigor Router	180
4.4 Activating Anti-Virus/Anti-Intrusion/Anti-Spam Service	185
4.4.1 For Anti-Virus and Anti-Intrusion Service	185
4.4.2 For Anti-Spam Service.....	190
4.5 Applying a New License for Anti-Intrusion/Anti-Virus	198
4.6 Backup and Upgrade Signature for Anti-Intrusion/Anti-Virus	205
4.7 Switching between DT-DT and DT-KL	206
4.8 Enabling Anti-Virus/Anti-Intrusion/Anti-Spam.....	209

5

Application and Examples	211
---------------------------------------	------------

5.1 Create a LAN-to-LAN Connection Between Remote Office and Headquarter	211
5.2 Create a Remote Dial-in User Connection Between the Teleworker and Headquarter.....	218
5.3 QoS Setting Example.....	222
5.4 LAN – Created by Using NAT	225
5.5 Upgrade Firmware for Your Router	227
5.6 Request a certificate from a CA server on Windows CA Server	229
5.7 Request a CA Certificate and Set as Trusted on Windows CA Server	233

6

Trouble Shooting	235
6.1 Checking If the Hardware Status Is OK or Not.....	235
6.2 Checking If the Network Connection Settings on Your Computer Is OK or Not	235
6.3 Pinging the Router from Your Computer	238
6.4 Checking If the ISP Settings are OK or Not.....	239
6.5 Backing to Factory Default Setting If Necessary	241
6.6 Contacting Your Dealer	242



1

Preface

The VigorPro5500 series router provides Dual-WAN interface (which is a configurable second WAN) for Internet access to make the Internet connection more reliable. The wireless LAN supports more secure features and the transmission speed is up to 108Mbps (Super G™). Object-oriented firewall is flexible and allows your network be safe.

1.1 Web Configuration Buttons Explanation

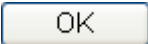
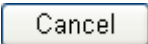
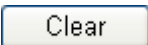
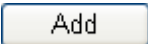
Several main buttons appeared on the web pages are defined as the following:

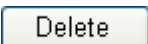
	Save and apply current settings.
	Cancel current settings and recover to the previous saved settings.
	Clear all the selections and parameters settings, including selection from drop-down list. All the values must be reset with factory default settings.
	Add new settings for specified item.
	Edit the settings for the selected item.
	Delete the selected item with the corresponding settings.

Note: For the other buttons shown on the web pages, please refer to Chapter 3 for detailed explanation.

1.2 LED Indicators and Connectors

Before you use the Vigor router, please get acquainted with the LED indicators and connectors first.

The displays of LED indicators and connectors for the routers are different slightly. The following sections will introduce them respectively.

1.2.1 For VigorPro 5500

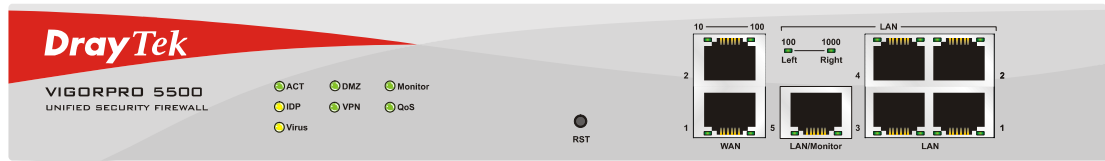



LED	Status	Explanation
ACT (Activity)	Blinking	The router is powered on and running normally.
	Off	The router is powered off.
Virus	On (Yellow)	The anti-virus function is enabled.
IDP (Intrusion Detection and Prevention)	On (Yellow)	The anti-intrusion function is enabled.
DMZ	On	DMZ Host is specified in certain site.
Monitor	On	LAN traffic monitor is active.
VPN	On	The VPN tunnel is launched.
	Off	The VPN tunnel is closed.
QoS	On	The QoS function is active.

LED on Connector

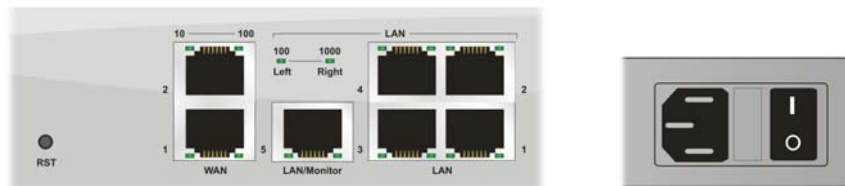
WAN	10 (left LED)	On	The port is connected with 10Mbps.
		Off	The port is disconnected.
		Blinking	The data is transmitting.
	100 (right LED)	On	The port is connected with 100Mbps.
		Off	The port is disconnected.
		Blinking	The data is transmitting.
LAN/Monitor LAN	100 (left LED)	On	The port is connected with 100Mbps.
		Off	The port is disconnected.
		Blinking	The data is transmitting.
	1000 (right LED)	On	The port is connected with 1000Mbps.
		Off	The port is disconnected.
		Blinking	The data is transmitting.



Interface	Description
RST (Factory Reset)	Restore the default settings. Usage: Turn on the router (ACT LED is blinking). Press the hole and keep for more than 5 seconds. When you see the ACT LED begins to blink rapidly than usual, release the button. Then the router will restart with the factory default configuration.
WAN(1/2)	Connector for remote networked devices.
LAN/Monitor	Connector for local networked devices.
LAN (1-4)	Connector for local networked devices.
	Connector for a power cord with 100-240VAC (inlet).
	Power Switch. "1" is ON; "0" is OFF.

1.2.2 For VigorPro 5500G

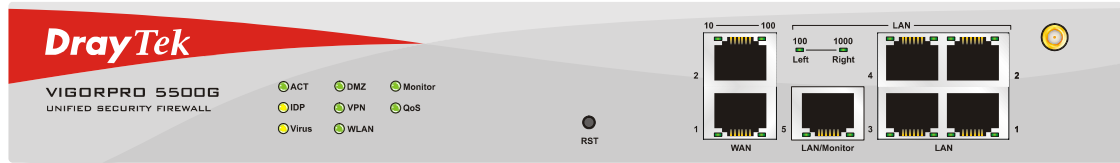



LED	Status	Explanation
ACT (Activity)	Blinking	The router is powered on and running normally.
	Off	The router is powered off.
Virus	On (Yellow)	The anti-virus function is enabled.
IDP (Intrusion Detection and Prevention)	On (Yellow)	The anti-intrusion function is enabled.
DMZ	On	DMZ Host is specified in certain site.
Monitor	On	LAN traffic monitor is active.
VPN	On	The VPN tunnel is launched.
	Off	The VPN tunnel is closed.
QoS	On	The QoS function is active.
WLAN	On	Wireless access point is ready.
	Blinking	Ethernet packets are transmitting over wireless LAN.
	Off	The WLAN function is inactive.

LED on Connector

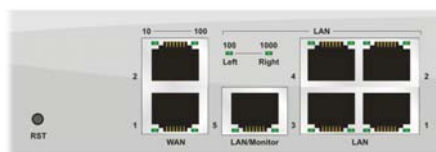
WAN	10 (left LED)	On	The port is connected with 10Mbps.
		Off	The port is disconnected.
		Blinking	The data is transmitting.
	100 (right LED)	On	The port is connected with 100Mbps.
		Off	The port is disconnected.
		Blinking	The data is transmitting.
LAN/Monitor LAN	100 (left LED)	On	The port is connected with 100Mbps.
		Off	The port is disconnected.
		Blinking	The data is transmitting.
	1000 (right LED)	On	The port is connected with 1000Mbps.
		Off	The port is disconnected.
		Blinking	The data is transmitting.



Interface	Description
RST (Factory Reset)	Restore the default settings. Usage: Turn on the router (ACT LED is blinking). Press the hole and keep for more than 5 seconds. When you see the ACT LED begins to blink rapidly than usual, release the button. Then the router will restart with the factory default configuration.
WAN(1/2)	Connector for remote networked devices.
LAN/Monitor	Connector for local networked devices.
LAN (1-4)	Connector for local networked devices.
	Connector for a power cord with 100-240VAC (inlet).
	Power Switch. "1" is ON; "0" is OFF.

1.2.3 For VigorPro 5500i

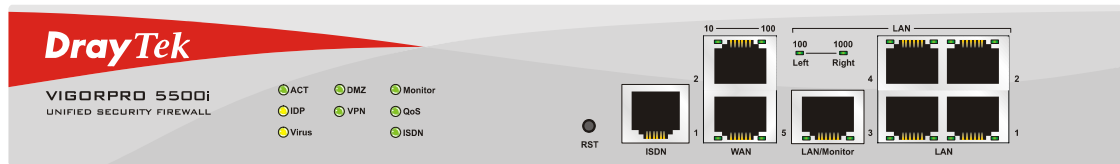



LED	Status	Explanation
ACT (Activity)	Blinking	The router is powered on and running normally.
	Off	The router is powered off.
Virus	On (Yellow)	The anti-virus function is enabled.
IDP (Intrusion Detection and Prevention)	On (Yellow)	The anti-intrusion function is enabled.
DMZ	On	DMZ Host is specified in certain site.
Monitor	On	LAN traffic monitor is active.
VPN	On	The VPN tunnel is launched.
	Off	The VPN tunnel is closed.
QoS	On	The QoS function is active.
ISDN	On	The ISDN service function is active.
	Blinking	A successful connection on the ISDN BRI B1/B2 channel.

LED on Connector

WAN	10 (left LED)	On	The port is connected with 10Mbps.
		Off	The port is disconnected.
		Blinking	The data is transmitting.
	100 (right LED)	On	The port is connected with 100Mbps.
		Off	The port is disconnected.
		Blinking	The data is transmitting.
LAN/Monitor LAN	100 (left LED)	On	The port is connected with 100Mbps.
		Off	The port is disconnected.
		Blinking	The data is transmitting.
	1000 (right LED)	On	The port is connected with 1000Mbps.
		Off	The port is disconnected.
		Blinking	The data is transmitting.



Interface	Description
RST (Factory Reset)	Restore the default settings. Usage: Turn on the router (ACT LED is blinking). Press the hole and keep for more than 5 seconds. When you see the ACT LED begins to blink rapidly than usual, release the button. Then the router will restart with the factory default configuration.
ISDN	Connect for NT1 (or NT1+) box provided by ISDN service provider.
WAN(1/2)	Connector for remote networked devices.
LAN/Monitor	Connector for local networked devices.
LAN (1- 4)	Connector for local networked devices.
	Connector for a power cord with 100-240VAC (inlet).
	Power Switch. "1" is ON; "0" is OFF.

1.2.4 For VigorPro 5500Gi





LED	Status	Explanation
ACT (Activity)	Blinking	The router is powered on and running normally.
	Off	The router is powered off.
Virus	On (Yellow)	The anti-virus function is enabled.
IDP (Intrusion Detection and Prevention)	On (Yellow)	The anti-intrusion function is enabled.
DMZ	On	DMZ Host is specified in certain site.
Monitor	On	LAN traffic monitor is active.
VPN	On	The VPN tunnel is launched.
	Off	The VPN tunnel is closed.
QoS	On	The QoS function is active.
WLAN	On	Wireless access point is ready.
	Blinking	Ethernet packets are transmitting over wireless LAN.
	Off	The WLAN function is inactive.
ISDN	On	The ISDN service function is active.
	Blinking	A successful connection on the ISDN BRI B1/B2 channel.

LED on Connector

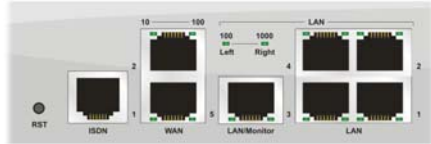
WAN	10 (left LED)	On	The port is connected with 10Mbps.
		Off	The port is disconnected.
		Blinking	The data is transmitting.
	100 (right LED)	On	The port is connected with 100Mbps.
		Off	The port is disconnected.
		Blinking	The data is transmitting.
LAN/Monitor LAN	100 (left LED)	On	The port is connected with 100Mbps.
		Off	The port is disconnected.
		Blinking	The data is transmitting.
	1000 (right LED)	On	The port is connected with 1000Mbps.
		Off	The port is disconnected.
		Blinking	The data is transmitting.



Interface	Description
RST (Factory Reset)	Restore the default settings. Usage: Turn on the router (ACT LED is blinking). Press the hole and keep for more than 5 seconds. When you see the ACT LED begins to blink rapidly than usual, release the button. Then the router will restart with the factory default configuration.
ISDN	Connect for NT1 (or NT1+) box provided by ISDN service provider.
WAN(1/2)	Connector for remote networked devices.
LAN/Monitor	Connector for local networked devices.
LAN (1- 4)	Connector for local networked devices.
	Connector for a power cord with 100-240VAC (inlet).
	Power Switch. "1" is ON; "0" is OFF.

1.3 Hardware Installation

This section will guide you to install the router through hardware connection and configure the router's settings through web browser.

Before starting to configure the router, you have to connect your devices correctly.

1. Connect the power cord to the router's power port on the rear panel, and the other side into a wall outlet.
2. Power on the device by pressing down the power switch on the rear panel.
3. The system starts to initiate. After completing the system test, the **ACT** LED will light up and start blinking.
4. Connect one end of an Ethernet cable (RJ-45) to one of the **LAN** ports of the router and the other end of the cable (RJ-45) into the Ethernet port on your computer (that device also can connect to other computers to form a small area network). The **LAN** LED will light up according to the network card feature (10Mbps or 100Mbps) of the device that it connected.
5. Connect a modem/router (depends on your requirement) to any WAN port of router with Ethernet cable (RJ-45). The **WAN1/WAN2** LED (down/up) will light up according to the network card feature ((10Mbps or 100Mbps) of the device that it connected.

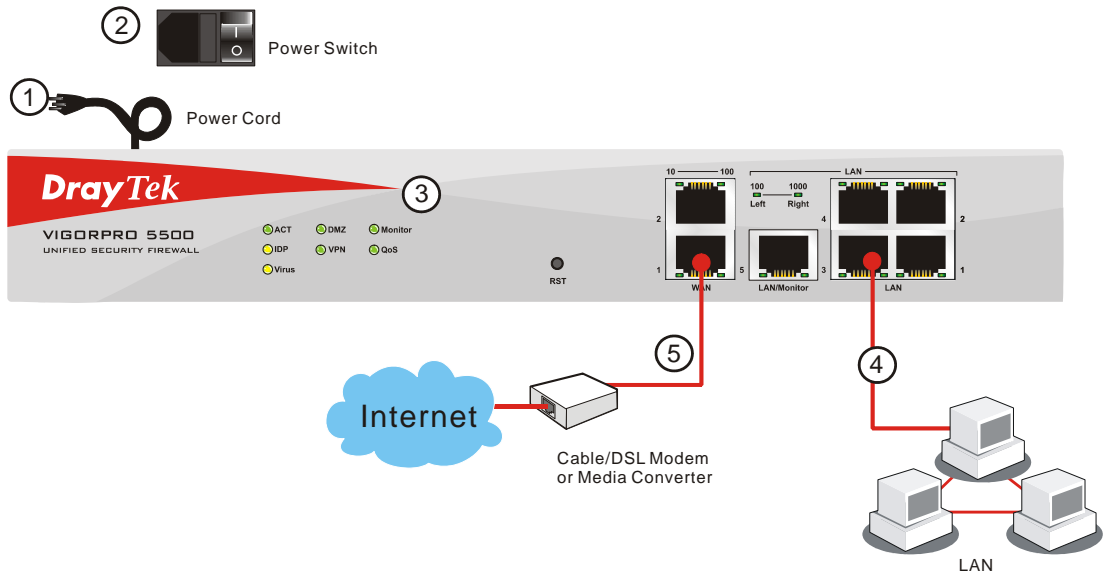

(For the detailed information of LED status, please refer to section 1.2.)

2

Configuring Basic Settings

For use the router properly, it is necessary for you to change the password of web configuration for security and adjust primary basic settings.

This chapter explains how to setup a password for an administrator and how to adjust basic settings for accessing Internet successfully. Be aware that only the administrator can change the router configuration.

2.1 Changing Password

To change the password for this device, you have to access into the web browse with default password first.

1. Make sure your computer connects to the router correctly.



Notice: You may either simply set up your computer to get IP dynamically from the router or set up the IP address of the computer to be the same subnet as **the default IP address of Vigor router 192.168.1.1**. For the detailed information, please refer to the later section - Trouble Shooting of this guide.

2. Open a web browser on your PC and type **http://192.168.1.1**. A pop-up window will open to ask for username and password. Please type default values (both username and password are Null) on the window for the first time accessing and click **OK** for next screen.



- Now, the **Main Screen** will pop up.

DrayTek VIGORPRO 5500
UNIFIED SECURITY FIREWALL

System Status

Model Name : VigorPro5500 series
 Firmware Version : 3.2.0_RC1a
 Build Date/Time : Apr 16 2007 18:57:40
 Signature Version : basic
 Signature Build Date : Tue Aug 29 09:16:25.00 2006

LAN	
MAC Address	: 00-50-7F-C0-2E-BC
1st IP Address	: 192.168.1.1
1st Subnet Mask	: 255.255.255.0
DHCP Server	: Yes
DNS	: 194.109.6.66

WAN 1	
Link Status	: Connected
MAC Address	: 00-50-7F-C0-2E-8D
Connection	: Static IP
IP Address	: 172.16.3.229
Default Gateway	: 172.16.3.4

WAN 2	
Link Status	: Disconnected
MAC Address	: 00-50-7F-C0-2E-BE
Connection	: ---
IP Address	: ---
Default Gateway	: ---

Note: The home page will change slightly in accordance with the router you have.

- Go to **System Maintenance** page and choose **Administrator Password**.

System Maintenance >> Administrator Password Setup

Administrator Password

Old Password	<input type="text"/>
New Password	<input type="text"/>
Confirm Password	<input type="text"/>

OK

- Enter the login password (the default is blank) on the field of **Old Password**. Type a new one in the field of **New Password** and retype it on the field of **Retype New Password**. Then click **OK** to continue.
- Now, the password has been changed. Next time, use the new password to access the Web Configurator for this router.

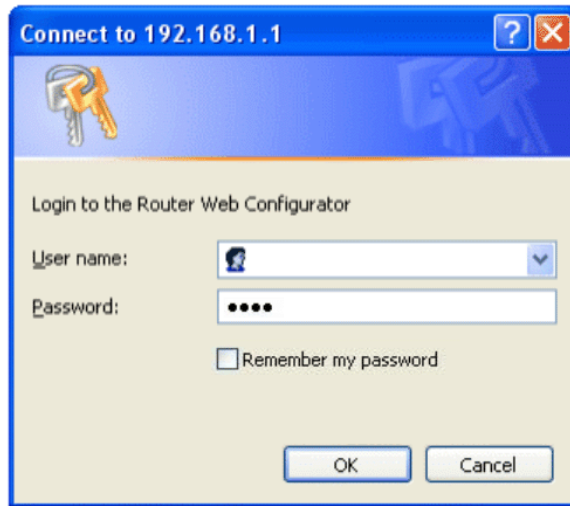

2.2 Quick Start Wizard

If your router can be under an environment with high speed NAT, the configuration provide here can help you to deploy and use the router quickly. The first screen of **Quick Start Wizard** is entering login password. After typing the password, please click **Next**.

Quick Start Wizard

Enter login password

Please enter an alpha-numeric string as your **Password** (Max 23 characters).

New Password

Confirm Password

< Back Next > Finish Cancel

On the next page as shown below, please select the WAN interface that you use. Choose **Auto negotiation** as the physical type for your router. Then click **Next** for next step.

Quick Start Wizard

Select WAN Interface

Select WAN Interface:	WAN1 ▾
Display Name:	<input type="text"/>
Physical Mode:	Ethernet
Physical Type:	Auto negotiation ▾

< Back Next > Finish Cancel

On the next page as shown below, please select the appropriate Internet access type according to the information from your ISP. For example, you should select PPPoE mode if the ISP provides you PPPoE interface. Then click **Next** for next step.

Quick Start Wizard

Connect to Internet

WAN 1
Select one of the following Internet Access types provided by your ISP.

- PPPoE
- PPTP
- Static IP
- DHCP

< Back Next > Finish Cancel

In the **Quick Start Wizard**, you can configure the router to access the Internet with different protocol/modes such as **PPPoE**, **PPTP**, **Static IP** or **DHCP**. The router supports the DSL WAN interface for Internet access.

2.2.1 PPPoE

PPPoE stands for **Point-to-Point Protocol over Ethernet**. It relies on two widely accepted standards: PPP and Ethernet. It connects users through an Ethernet to the Internet with a common broadband medium, such as a single DSL line, wireless device or cable modem. All the users over the Ethernet can share a common connection.

PPPoE is used for most of DSL modem users. All local users can share one PPPoE connection for accessing the Internet. Your service provider will provide you information about user name, password, and authentication mode.

If your ISP provides you the **PPPoE** connection, please select **PPPoE** for this router. The following page will be shown.

Quick Start Wizard

PPPoE Client Mode

WAN 1
Enter the user name and password provided by your ISP.

User Name	<input type="text" value="admin"/>
Password	<input type="password" value="••••"/>
Confirm Password	<input type="password" value="••••"/>

User Name Assign a specific valid user name provided by the ISP.

Password Assign a valid password provided by the ISP.

Confirm Password Retype the password for confirmation.

Click **Next** for viewing summary of such connection.

Quick Start Wizard

Please confirm your settings:

WAN Interface:	WAN1
Physical Mode:	Ethernet
Physical Type:	Auto negotiation
Internet Access:	PPPoE

Click **Back** to modify changes if necessary. Otherwise, click **Finish** to save the current settings and restart the Vigor router.

Click **Finish**. A page of **Quick Start Wizard Setup OK!!!** will appear. Then, the system status of this protocol will be shown.

Quick Start Wizard Setup OK !!!

2.2.2 PPTP

Click **PPTP** as the protocol. Type in all the information that your ISP provides for this protocol.

Quick Start Wizard

PPTP Client Mode

WAN 1	
Enter the user name, password, WAN IP configuration and PPTP server IP provided by your ISP.	
User Name	<input type="text" value="admin"/>
Password	<input type="password" value="••••"/>
Confirm Password	<input type="password" value="••••"/>
WAN IP Configuration	
<input type="radio"/> Obtain an IP address automatically	
<input checked="" type="radio"/> Specify an IP address	
IP Address	<input type="text" value="172.16.3.229"/>
Subnet Mask	<input type="text" value="255.255.0.0"/>
PPTP Server IP	<input type="text"/>

Click **Next** for viewing summary of such connection.

Quick Start Wizard

Please confirm your settings:

WAN Interface:	WAN1
Physical Mode:	Ethernet
Physical Type:	Auto negotiation
Internet Access:	PPTP

Click **Back** to modify changes if necessary. Otherwise, click **Finish** to save the current settings and restart the Vigor router.

Click **Finish**. A page of **Quick Start Wizard Setup OK!!!** will appear. Then, the system status of this protocol will be shown.

Quick Start Wizard Setup OK !!!

2.2.3 Static IP

Click **Static IP** as the protocol. Type in all the information that your ISP provides for this protocol.

Quick Start Wizard

Static IP Client Mode

WAN 1	
Enter the Static IP configuration provided by your ISP.	
WAN IP	<input type="text" value="172.16.3.229"/>
Subnet Mask	<input type="text" value="255.255.0.0"/>
Gateway	<input type="text" value="172.16.1.1"/>
Primary DNS	<input type="text" value="168.95.1.1"/>
Secondary DNS	<input type="text"/> (optional)

After finishing the settings in this page, click **Next** to see the following page.

Quick Start Wizard

Please confirm your settings:

WAN Interface:	WAN1
Physical Mode:	Ethernet
Physical Type:	Auto negotiation
Internet Access:	Static IP

Click **Back** to modify changes if necessary. Otherwise, click **Finish** to save the current settings and restart the Vigor router.

Click **Finish**. A page of **Quick Start Wizard Setup OK!!!** will appear. Then, the system status of this protocol will be shown.

Quick Start Wizard Setup OK !!!

2.2.4 DHCP

Click **DHCP** as the protocol. Type in all the information that your ISP provides for this protocol.

Quick Start Wizard

DHCP Client Mode

WAN 1

If your ISP requires you to enter a specific host name or specific MAC address, please enter it in.

Host Name (optional)

MAC (optional)

< Back

Next >

Finish

Cancel

After finishing the settings in this page, click **Next** to see the following page.

Quick Start Wizard

Please confirm your settings:

WAN Interface: WAN1
Physical Mode: Ethernet
Physical Type: Auto negotiation
Internet Access: DHCP

Click **Back** to modify changes if necessary. Otherwise, click **Finish** to save the current settings and restart the Vigor router.

< Back

Next >

Finish

Cancel

Click **Finish**. A page of **Quick Start Wizard Setup OK!!!** will appear. Then, the system status of this protocol will be shown.

Quick Start Wizard Setup OK !!!

2.3 Online Status

The online status shows the system status, WAN status, ADSL Information and other status related to this router within one page. If you select **PPPoE/PPTP** as the protocol, you will find out a link of **Dial PPPoE/PPPoA** or **Drop PPPoE/PPPoA** in the Online Status web page.

Online status for PPPoE (WAN2)

System Status				System Uptime: 0:0:18		
LAN Status		Primary DNS: 168.95.192.1		Secondary DNS: 168.95.1.1		
IP Address		TX Packets	RX Packets			
192.168.1.1		77	56			
WAN 1 Status						
Enable	Line	Name	Mode	Up Time		
Yes	Ethernet		Static IP	0:00:11		
IP	GW IP	TX Packets	TX Rate	RX Packets	RX Rate	
192.168.5.100	192.168.5.1	3	17	3	42	
WAN 2 Status						>> Drop PPPoE
Enable	Line	Name	Mode	Up Time		
Yes	Ethernet		PPPoE	0:00:11		
IP	GW IP	TX Packets	TX Rate	RX Packets	RX Rate	
61.230.209.207	61.230.192.254	10	16	10	12	

Online status for PPTP (for WAN2)

System Status				System Uptime: 0:0:18		
LAN Status		Primary DNS: 168.95.192.1		Secondary DNS: 168.95.1.1		
IP Address		TX Packets	RX Packets			
192.168.1.1		77	56			
WAN 1 Status						
Enable	Line	Name	Mode	Up Time		
Yes	Ethernet		Static IP	0:00:11		
IP	GW IP	TX Packets	TX Rate	RX Packets	RX Rate	
192.168.5.100	192.168.5.1	3	17	3	42	
WAN 2 Status						>> Drop PPPoE
Enable	Line	Name	Mode	Up Time		
Yes	Ethernet	WAN2	PPTP	0:00:15		
IP	GW IP	TX Packets	TX Rate	RX Packets	RX Rate	
192.168.29.202	192.168.29.1	103	119	14	6	

Online status for Static IP (for WAN1)

System Status				System Uptime: 0:0:18		
LAN Status		Primary DNS: 168.95.192.1		Secondary DNS: 168.95.1.1		
IP Address		TX Packets	RX Packets			
192.168.1.1		77	56			
WAN 1 Status						
Enable	Line	Name	Mode	Up Time		
Yes	Ethernet		Static IP	0:00:11		
IP	GW IP	TX Packets	TX Rate	RX Packets	RX Rate	
192.168.5.100	192.168.5.1	3	17	3	42	
WAN 2 Status						>> Drop PPPoE
Enable	Line	Name	Mode	Up Time		
Yes	Ethernet		PPPoE	0:00:11		
IP	GW IP	TX Packets	TX Rate	RX Packets	RX Rate	
61.230.209.207	61.230.192.254	10	16	10	12	

Online status for DHCP

System Status			System Uptime: 0:6:52		
LAN Status		Primary DNS: 168.95.192.1		Secondary DNS: 168.95.1.1	
IP Address	TX Packets	RX Packets			
192.168.1.1	677	558			
WAN 1 Status					>> Release
Enable	Line	Name	Mode	Up Time	
Yes	Ethernet		DHCP Client	0:06:45	
IP	GW IP	TX Packets	TX Rate	RX Packets	RX Rate
192.168.5.10	192.168.5.1	89	3	68	3
WAN 2 Status					>> Drop PPPoE
Enable	Line	Name	Mode	Up Time	
Yes	Ethernet		PPPoE	0:01:34	
IP	GW IP	TX Packets	TX Rate	RX Packets	RX Rate
61.230.213.66	61.230.192.254	21	7	45	13

Detailed explanation is shown below:

Primary DNS	Displays the IP address of the primary DNS.
Secondary DNS	Displays the IP address of the secondary DNS.
LAN Status	
IP Address	Displays the IP address of the LAN interface.
TX Packets	Displays the total transmitted packets at the LAN interface.
RX Packets	Displays the total number of received packets at the LAN interface.
WAN1/2 Status	
Line	Displays the physical connection (Ethernet) of this interface.
Name	Displays the name set in WAN1/WAN web page.
Mode	Displays the type of WAN connection (e.g., PPPoE).
Up Time	Displays the total uptime of the interface.
IP	Displays the IP address of the WAN interface.
GW IP	Displays the IP address of the default gateway.
TX Packets	Displays the total transmitted packets at the WAN interface.
TX Rate	Displays the speed of transmitted octets at the WAN interface.
RX Packets	Displays the total number of received packets at the WAN interface.
RX Rate	Displays the speed of received octets at the WAN interface.

Note: The words in green mean that the WAN connection of that interface (WAN1/WAN2) is ready for accessing Internet; the words in red mean that the WAN connection of that interface (WAN1/WAN2) is not ready for accessing Internet.

2.4 Saving Configuration

Each time you click **OK** on the web page for saving the configuration, you can find messages showing the system interaction with you.



Status: Ready

Ready indicates the system is ready for you to input settings.

Settings Saved means your settings are saved once you click **Finish** or **OK** button.

This page is left blank.

3

Advanced Web Configuration

After finished basic configuration of the router, you can access Internet with ease. For the people who want to adjust more setting for suiting his/her request, please refer to this chapter for getting detailed information about the advanced configuration of this router. As for other examples of application, please refer to chapter 4.

3.1 WAN

Quick Start Wizard offers user an easy method to quick setup the connection mode for the router. Moreover, if you want to adjust more settings for different WAN modes, please go to **WAN** group and click the **Internet Access** link.

3.1.1 Basics of Internet Protocol (IP) Network

IP means Internet Protocol. Every device in an IP-based Network including routers, print server, and host PCs, needs an IP address to identify its location on the network. To avoid address conflicts, IP addresses are publicly registered with the Network Information Centre (NIC). Having a unique IP address is mandatory for those devices participated in the public network but not in the private TCP/IP local area networks (LANs), such as host PCs under the management of a router since they do not need to be accessed by the public. Hence, the NIC has reserved certain addresses that will never be registered publicly. These are known as *private* IP addresses, and are listed in the following ranges:

From 10.0.0.0 to 10.255.255.255

From 172.16.0.0 to 172.31.255.255

From 192.168.0.0 to 192.168.255.255

What are Public IP Address and Private IP Address

As the router plays a role to manage and further protect its LAN, it interconnects groups of host PCs. Each of them has a private IP address assigned by the built-in DHCP server of the Vigor router. The router itself will also use the default **private IP** address: 192.168.1.1 to communicate with the local hosts. Meanwhile, Vigor router will communicate with other network devices through a **public IP** address. When the data flow passing through, the Network Address Translation (NAT) function of the router will dedicate to translate public/private addresses, and the packets will be delivered to the correct host PC in the local area network. Thus, all the host PCs can share a common Internet connection.

Get Your Public IP Address from ISP

In ADSL deployment, the PPP (Point to Point)-style authentication and authorization is required for bridging customer premises equipment (CPE). Point to Point Protocol over Ethernet (PPPoE) connects a network of hosts via an access device to a remote access concentrator or aggregation concentrator. This implementation provides users with significant ease of use. Meanwhile it provides access control, billing, and type of service according to user requirement.

When a router begins to connect to your ISP, a serial of discovery process will occur to ask for a connection. Then a session will be created. Your user ID and password is authenticated via **PAP** or **CHAP** with **RADIUS** authentication system. And your IP address, DNS server, and other related information will usually be assigned by your ISP.

Below shows the menu items for WAN.

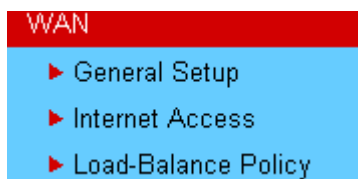

3.1.2 General Setup

This section will introduce some general settings of Internet and explain the connection modes for WAN1 and WAN2 in details.

This router supports dual WAN function. It allows users to access Internet and combine the bandwidth of the dual WAN to speed up the transmission through the network. Each WAN port can connect to different ISPs, Even if the ISPs use different technology to provide telecommunication service (such as DSL, Cable modem, etc.). If any connection problem occurred on one of the ISP connections, all the traffic will be guided and switched to the normal communication port for proper operation. Please configure WAN1 and WAN2 settings.

This webpage allows you to set general setup for WAN1 and WAN2 respectively.

Note: In default, WAN1 and WAN2 are enabled.

WAN >> General Setup

A screenshot of the 'WAN >> General Setup' configuration page. The page is divided into two columns for WAN1 and WAN2. Each column has a 'General Setup' section. For WAN1, the 'Enable' dropdown is set to 'Yes', 'Physical Mode' is 'Ethernet', 'Physical Type' is 'Auto negotiation', 'Load Balance Mode' is 'Auto Weight', 'Active Mode' is 'Always On', and 'Active on demand' has radio buttons for 'WAN2 Fail' (selected) and 'WAN2 Upload speed exceed' and 'WAN2 Download speed exceed' with input fields. For WAN2, the 'Enable' dropdown is set to 'Yes', 'Physical Mode' is 'Ethernet', 'Physical Type' is 'Auto negotiation', 'Load Balance Mode' is 'Auto Weight', 'Active Mode' is 'Active on demand', and 'Active on demand' has radio buttons for 'WAN1 Fail' (selected) and 'WAN1 Upload speed exceed' and 'WAN1 Download speed exceed' with input fields. An 'OK' button is located at the bottom center of the form.

Enable

Choose **Yes** to invoke the settings for this WAN interface. Choose **No** to disable the settings for this WAN interface.

Display Name

Type the description for the WAN1/WAN2 interface.

Physical Mode

For WAN1, the physical connection is done through ADSL port; yet the physical connection for WAN2 is done through an Ethernet port (P1). You cannot change it.

Physical Type

You can change the physical type for WAN2 or choose **Auto negotiation** for determined by the system.

Physical Type: 

The dropdown menu shows the following options: Auto negotiation (selected), 10M half duplex, 10M full duplex, 100M half duplex, and 100M full duplex.

Load Balance Mode

If you know the practical bandwidth for your WAN interface, please choose the setting of **According to Line Speed**. Otherwise, please choose **Auto Weigh** to let the router reach the best load balance.

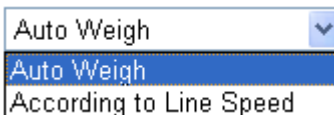
Load Balance Mode: 

The dropdown menu shows the following options: Auto Weigh (selected) and According to Line Speed.

Line Speed

If your choose **According to Line Speed** as the **Load Balance Mode**, please type the line speed for downloading and uploading through WAN1/WAN2. The unit is kbps.

Active Mode

Choose **Always On** to make the WAN connection (WAN1/WAN2) being activated always; or choose **Active on demand** to make the WAN connection (WAN1/WAN2) activated if it is necessary.

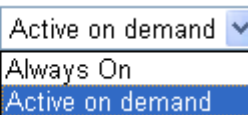
Active Mode: 

The dropdown menu shows the following options: Active on demand (selected), Always On, and Active on demand.

If you choose Active on demand, the Idle Timeout will be available for you to set for PPPoE and PPTP access modes in the Details Page of WAN>>Internet Access. In addition, there are three selections for you to choose for different purposes.

WAN2 Fail – It means the connection for WAN1 will be activated when WAN2 is failed.

WAN2 Upload speed exceed XX kbps – It means the connection for WAN1 will be activated when WAN2 Upload speed exceed certain value that you set in this box for 15 seconds.

WAN2 Download speed exceed XX kbps– It means the connection for WAN1 will be activated when WAN2 Download speed exceed certain value that you set in this box for 15 seconds.

WAN1 Fail – It means the connection for WAN2 will be activated when WAN1 is failed.

WAN1 Upload speed exceed XX kbps – It means the connection for WAN2 will be activated when WAN1 Upload speed exceed certain value that you set in this box for 15 seconds.

WAN1 Download speed exceed XX kbps– It means the connection for WAN2 will be activated when WAN1 Download speed exceed certain value that you set in this box for 15 seconds.

3.1.3 Internet Access

For the router supports dual WAN function, the users can set different WAN settings (for WAN1/WAN2) for Internet Access. Due to different physical mode for WAN1 and WAN2, the Access Mode for these two connections also varies slightly.

WAN >> Internet Access

Internet Access

Index	Display Name	Physical Mode	Access Mode	
WAN1		Ethernet	Static or Dynamic IP	Details Page
WAN2		Ethernet	None	Details Page

Index

It shows the WAN modes that this router supports. WAN1 is the default WAN interface for accessing into the Internet. WAN2 is the optional WAN interface for accessing into the Internet when WAN 1 is inactive for some reason.

Display Name

It shows the name of the WAN1/WAN2 that entered in general setup.

Physical Mode

It shows the physical port for WAN1/WAN2.

Access Mode

Use the drop down list to choose a proper access mode. The details page of that mode will be popped up. If not, click Details Page for accessing the page to configure the settings.

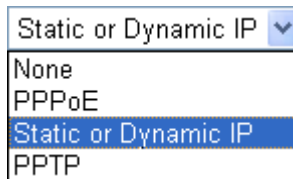

There are three access modes provided for PPPoE, Static or Dynamic IP and PPTP.

Details Page

This button will open different web page according to the access mode that you choose in WAN1 or WAN2.

Details Page for PPPoE

To use **PPPoE** as the accessing protocol of the internet, please choose **Internet Access** from **WAN** menu. Then, select **PPPoE** mode for WAN2. The following web page will be shown.

WAN >> Internet Access

WAN 1

PPPoE Client Mode <input checked="" type="radio"/> Enable <input type="radio"/> Disable	PPP/MP Setup PPP Authentication: PAP or CHAP Idle Timeout: -1 second(s)
ISP Access Setup Username: admin Password: ●●●● Index(1-15) in Schedule Setup: => [] , [] , [] , []	IP Address Assignment Method (IPCP) Fixed IP: <input type="radio"/> Yes <input checked="" type="radio"/> No (Dynamic IP) Fixed IP Address: []
ISDN Dial Backup Setup Dial Backup Mode: None	<input checked="" type="radio"/> Default MAC Address <input type="radio"/> Specify a MAC Address MAC Address: [00] [50] [7F] [22] [33] [45]

OK Cancel

PPPoE Client Mode

Click **Enable** for activating this function. If you click **Disable**, this function will be closed and all the settings that you adjusted in this page will be invalid.

ISP Access Setup

Enter your allocated username, password and authentication parameters according to the information provided by your ISP. If you want to connect to Internet all the time, you can check **Always On**.

Username – Type in the username provided by ISP in this field.

Password – Type in the password provided by ISP in this field.

Index (1-15) in Schedule Setup - You can type in four sets of time schedule for your request. All the schedules can be set previously in **Application – Schedule** web page and you can use the number that you have set in that web page.

PPP/MP Setup

PPP Authentication – Select **PAP only** or **PAP or CHAP** for PPP.

Idle Timeout – Set the timeout for breaking down the Internet after passing through the time without any action. This setting is active only when the **Active on demand** option for Active Mode is selected in **WAN>> General Setup** page.

IP Address Assignment Method (IPCP)

Usually ISP dynamically assigns IP address to you each time you connect to it and request. In some case, your ISP provides service to always assign you the same IP address whenever you request. In this case, you can fill in this IP address in the Fixed IP field. Please contact your ISP before you want to use this function.

WAN IP Alias - If you have multiple public IP addresses and would like to utilize them on the WAN interface, please use WAN IP Alias. You can set up to 8 public IP addresses other than the current one you are using.

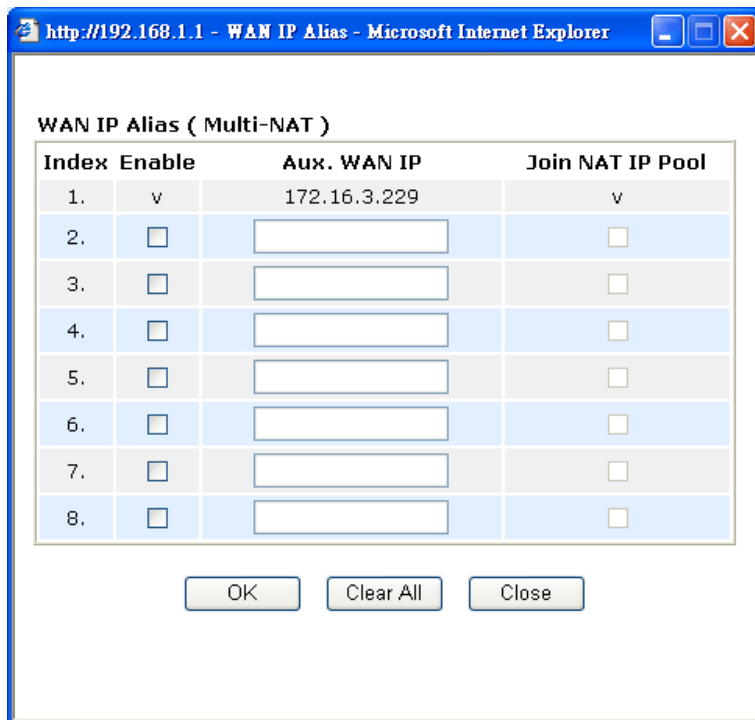

Fixed IP – Click **Yes** to use this function and type in a fixed IP address in the box of **Fixed IP Address**.

Default MAC Address – You can use **Default MAC Address** or specify another MAC address by typing on the boxes of MAC Address for the router.

Specify a MAC Address – Type the MAC address for the router manually.

After finishing all the settings here, please click **OK** to activate them.

Details Page for Static or Dynamic IP

For static IP mode, you usually receive a fixed public IP address or a public subnet, namely multiple public IP addresses from your DSL or Cable ISP service providers. In most cases, a Cable service provider will offer a fixed public IP, while a DSL service provider will offer a public subnet. If you have a public subnet, you could assign an IP address or many IP address to the WAN interface.

To use **Static or Dynamic IP** as the accessing protocol of the internet, please choose **Internet Access** from **WAN** menu. Then, select **Static or Dynamic IP** mode for WAN2. The following web page will be shown.

WAN 1

<p>Static or Dynamic IP (DHCP Client)</p> <p><input checked="" type="radio"/> Enable <input type="radio"/> Disable</p> <hr/> <p>Keep WAN Connection</p> <p><input type="checkbox"/> Enable PING to keep alive</p> <p>PING to the IP <input type="text"/></p> <p>PING Interval <input type="text"/> minute(s)</p> <hr/> <p>RIP Protocol</p> <p><input type="checkbox"/> Enable RIP</p>	<p>WAN IP Network Settings WAN IP Alias</p> <p><input type="radio"/> Obtain an IP address automatically</p> <p>Router Name <input type="text"/> *</p> <p>Domain Name <input type="text"/> *</p> <p>* : Required for some ISPs</p> <p><input checked="" type="radio"/> Specify an IP address</p> <p>IP Address <input type="text" value="172.16.3.229"/></p> <p>Subnet Mask <input type="text" value="255.255.0.0"/></p> <p>Gateway IP Address <input type="text" value="172.16.1.1"/></p> <hr/> <p><input checked="" type="radio"/> Default MAC Address</p> <p><input type="radio"/> Specify a MAC Address</p> <p>MAC Address:</p> <p><input type="text" value="00"/> <input type="text" value="50"/> <input type="text" value="7F"/> <input type="text" value="22"/> <input type="text" value="33"/> <input type="text" value="45"/></p> <hr/> <p>DNS Server IP Address</p> <p>Primary IP Address <input type="text"/></p> <p>Secondary IP Address <input type="text"/></p>
--	---

Static or Dynamic IP (DHCP Client)

Click **Enable** for activating this function. If you click **Disable**, this function will be closed and all the settings that you adjusted in this page will be invalid.

Keep WAN Connection

Normally, this function is designed for Dynamic IP environments because some ISPs will drop connections if there is no traffic within certain periods of time. Check **Enable PING to keep alive** box to activate this function.

PING to the IP - If you enable the PING function, please specify the IP address for the system to PING it for keeping alive.

PING Interval - Enter the interval for the system to execute the PING operation.

RIP Protocol

Routing Information Protocol is abbreviated as RIP (RFC1058) specifying how routers exchange routing tables information. Click **Enable RIP** for activating this function.

WAN IP Network Settings

This group allows you to obtain an IP address automatically and allows you type in IP address manually.

WAN IP Alias - If you have multiple public IP addresses and would like to utilize them on the WAN interface, please use WAN IP Alias. You can set up to 8 public IP addresses other than the current one you are using. Notice that this setting is available for WAN1 only.

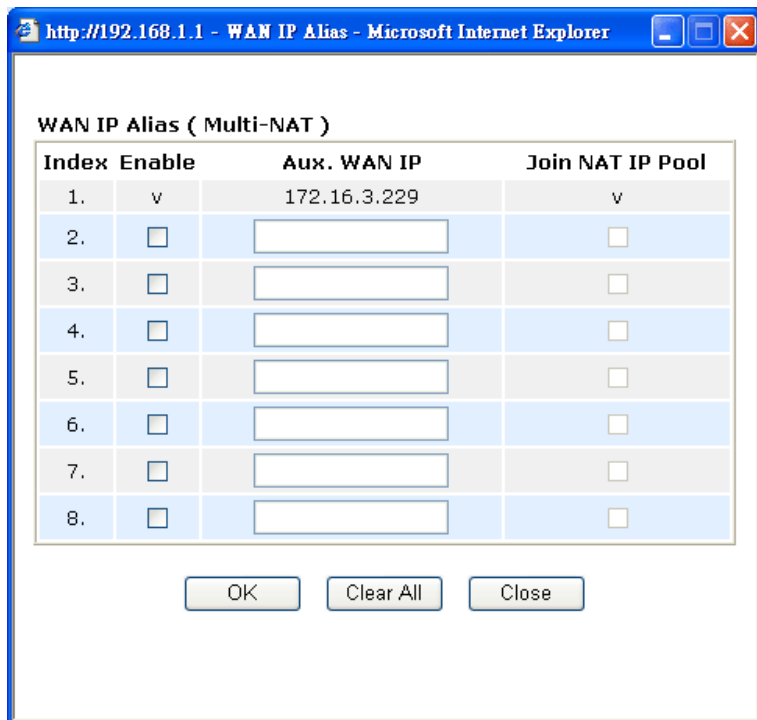

Obtain an IP address automatically – Click this button to obtain the IP address automatically if you want to use **Dynamic IP** mode.

Router Name: Type in the router name provided by ISP.

Domain Name: Type in the domain name that you have assigned.

Specify an IP address – Click this radio button to specify some data if you want to use **Static IP** mode.

IP Address: Type the IP address.

Subnet Mask: Type the subnet mask.

Gateway IP Address: Type the gateway IP address.

Default MAC Address: Click this radio button to use default MAC address for the router.

Specify a MAC Address: Some Cable service providers specify a specific MAC address for access authentication. In such cases you need to click the **Specify a MAC Address** and enter the MAC address in the MAC Address field.

DNS Server IP Address

Type in the primary IP address for the router if you want to use **Static IP** mode. If necessary, type in secondary IP address for necessity in the future.

Details Page for PPTP

To use **PPTP** as the accessing protocol of the internet, please choose **Internet Access** from **WAN** menu. Then, select **PPTP** mode for WAN2. The following web page will be shown.

WAN >> Internet Access

WAN 1

PPTP Client Mode <input type="radio"/> Enable <input checked="" type="radio"/> Disable PPTP Server <input type="text"/>	PPP Setup PPP Authentication <input type="text" value="PAP or CHAP"/> Idle Timeout <input type="text" value="-1"/> second(s)
ISP Access Setup Username <input type="text"/> Password <input type="text"/> Index(1-15) in Schedule Setup: => <input type="text"/> , <input type="text"/> , <input type="text"/> , <input type="text"/>	IP Address Assignment Method (IPCP) <input type="text" value="WAN IP Alias"/> Fixed IP: <input type="radio"/> Yes <input checked="" type="radio"/> No (Dynamic IP) Fixed IP Address <input type="text"/> WAN IP Network Settings <input type="radio"/> Obtain an IP address automatically <input checked="" type="radio"/> Specify an IP address IP Address <input type="text" value="172.16.3.229"/> Subnet Mask <input type="text" value="255.255.0.0"/>

OK Cancel

PPTP Setup

PPTP Link - Click **Enable** to enable a PPTP client to establish a tunnel to a DSL modem on the WAN interface.

PPTP Server - Specify the IP address of the PPTP server.

ISP Access Setup

Username -Type in the username provided by ISP in this field.

Password -Type in the password provided by ISP in this field.

Index (1-15) in Schedule Setup - You can type in four sets of time schedule for your request. All the schedules can be set previously in **Application – Schedule** web page and you can use the number that you have set in that web page.

PPP Setup

PPP Authentication - Select **PAP only** or **PAP or CHAP** for PPP.

Idle Timeout - Set the timeout for breaking down the Internet after passing through the time without any action. This setting is active only when the **Active on demand** option for Active Mode is selected in **WAN>> General Setup** page.

IP Address Assignment Method(IPCP)

Fixed IP - Usually ISP dynamically assigns IP address to you each time you connect to it and request. In some case, your ISP provides service to always assign you the same IP address whenever you request. In this case, you can fill in this IP address in the Fixed IP field. Please contact your ISP before you want to use this function. Click **Yes** to use this function and type in a fixed IP address in the box.

Fixed IP Address -Type a fixed IP address.

WAN IP Alias - If you have multiple public IP addresses and would like to utilize them on the WAN interface, please use WAN IP Alias. You can set up to 8 public IP addresses other than the current one you are using. Notice that this setting is available for WAN1 only.

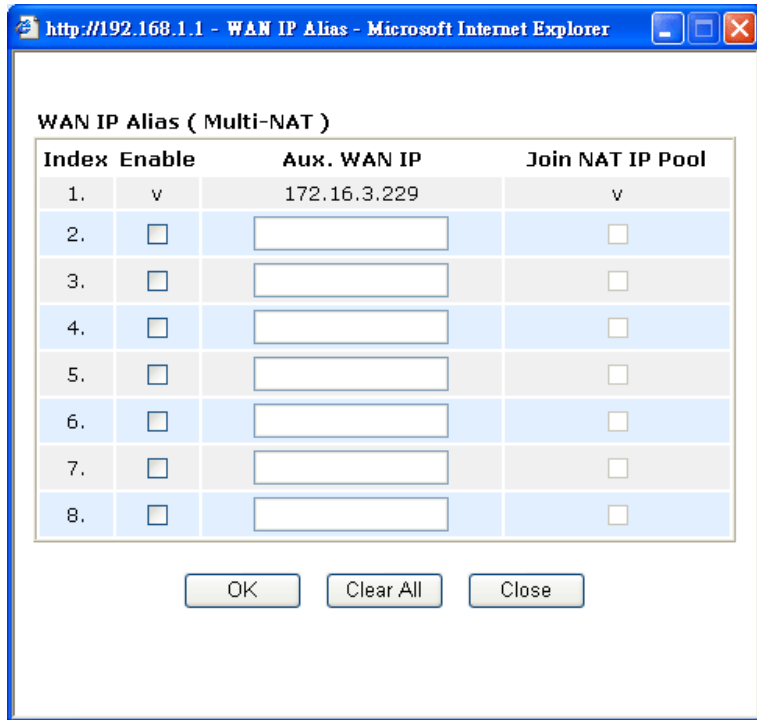

Default MAC Address – Click this radio button to use default MAC address for the router.

Specify a MAC Address - Some Cable service providers specify a specific MAC address for access authentication. In such cases you need to click the **Specify a MAC Address** and enter the MAC address in the MAC Address field.

WAN IP Network Settings

Obtain an IP address automatically – Click this button to obtain the IP address automatically.

Specify an IP address – Click this radio button to specify some data.

IP Address – Type the IP address.

Subnet Mask – Type the subnet mask.

3.1.4 Load-Balance Policy

This router supports the function of load balancing. It can assign traffic with protocol type, IP address for specific host, a subnet of hosts, and port range to be allocated in WAN1 or WAN2 interface. The user can assign traffic category and force it to go to dedicate network interface based on the following web page setup. Twenty policies of load-balance are supported by this router.

Note: Load-Balance Policy is running only when both WAN1 and WAN2 are activated.

Load-Balance Policy

Index	Enable	Protocol	WAN	Src IP Start	Src IP End	Dest IP Start	Dest IP End	Dest Port Start	Dest Port End
1	<input type="checkbox"/>	any							
2	<input type="checkbox"/>	any							
3	<input type="checkbox"/>	any							
4	<input type="checkbox"/>	any							
5	<input type="checkbox"/>	any							
6	<input type="checkbox"/>	any							
7	<input type="checkbox"/>	any							
8	<input type="checkbox"/>	any							
9	<input type="checkbox"/>	any							
10	<input type="checkbox"/>	any							

<< 1-10 | 11-20 >>

Next >>

OK

Index Click the number of index to access into the load-balance policy configuration web page.

Enable Check this box to enable this policy.

Protocol Use the drop-down menu to change the protocol for the WAN interface.

WAN Use the drop-down menu to change the WAN interface.

WAN



Src IP Start Displays the IP address for the start of the source IP.

Src IP End Displays the IP address for the end of the source IP.

Dest IP Start Displays the IP address for the start of the destination IP.

Dest IP End Displays the IP address for the end of the destination IP.

Dest Port Start Displays the IP address for the start of the destination port.

Dest Port End Displays the IP address for the end of the destination port.

Click **Index 1** to access into the following page for configuring load-balance policy.

Index: 1

<input type="checkbox"/> Enable	
Protocol	TCP
Binding WAN interface	WAN1
Src IP Start	192.168.1.3
Src IP End	192.168.1.5
Dest IP Start	168.95.0.0
Dest IP End	168.95.0.100
Dest Port Start	80
Dest Port End	100

OK Cancel

Enable Check this box to enable this policy.

Protocol Use the drop-down menu to choose a proper protocol for the WAN interface.

Protocol

any
TCP
UDP
TCP/UDP
ICMP
IGMP

Binding WAN interface Choose the WAN interface (WAN1 or WAN2) for binding.

Src IP Start Type the source IP start for the specified WAN interface.

Src IP End Type the source IP end for the specified WAN interface. If this field is blank, it means that all the source IPs inside the LAN will be passed through the WAN interface.

Dest IP Start Type the destination IP start for the specified WAN interface.

Dest IP End Type the destination IP end for the specified WAN interface. If this field is blank, it means that all the destination IPs will be passed through the WAN interface.

Dest Port Start Type the destination port start for the destination IP.

Dest Port End Type the destination port end for the destination IP. If this field is blank, it means that all the destination ports will be passed through the WAN interface.

3.2 LAN

Local Area Network (LAN) is a group of subnets regulated and ruled by router. The design of network structure is related to what type of public IP addresses coming from your ISP.

LAN
▶ General Setup
▶ Static Route
▶ VLAN
▶ Bind IP to MAC

3.2.1 Basics of LAN

The most generic function of Vigor router is NAT. It creates a private subnet of your own. As mentioned previously, the router will talk to other public hosts on the Internet by using public IP address and talking to local hosts by using its private IP address. What NAT does is to translate the packets from public IP address to private IP address to forward the right packets to the right host and vice versa. Besides, Vigor router has a built-in DHCP server that assigns private IP address to each local host. See the following diagram for a briefly understanding.

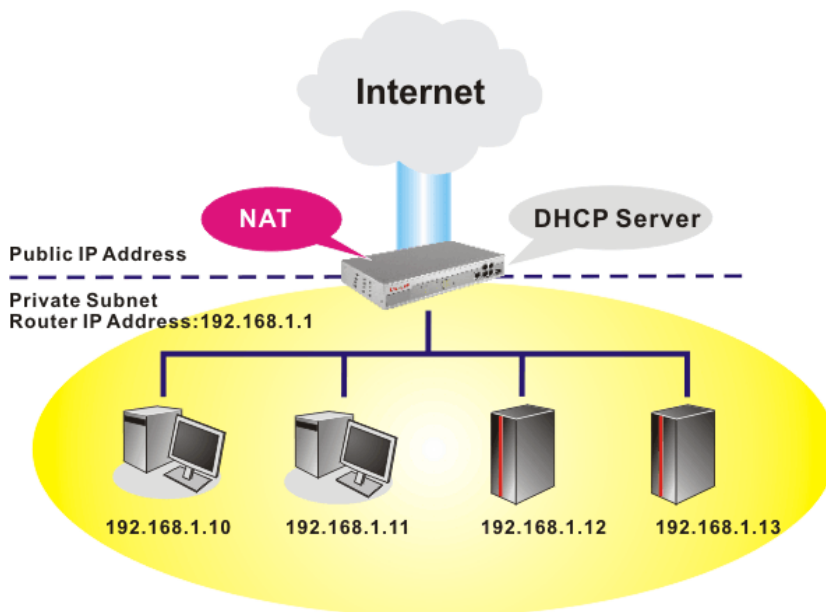

In some special case, you may have a public IP subnet from your ISP such as 220.135.240.0/24. This means that you can set up a public subnet or call second subnet that each host is equipped with a public IP address. As a part of the public subnet, the Vigor router will serve for IP routing to help hosts in the public subnet to communicate with other public hosts or servers outside. Therefore, the router should be set as the gateway for public hosts.

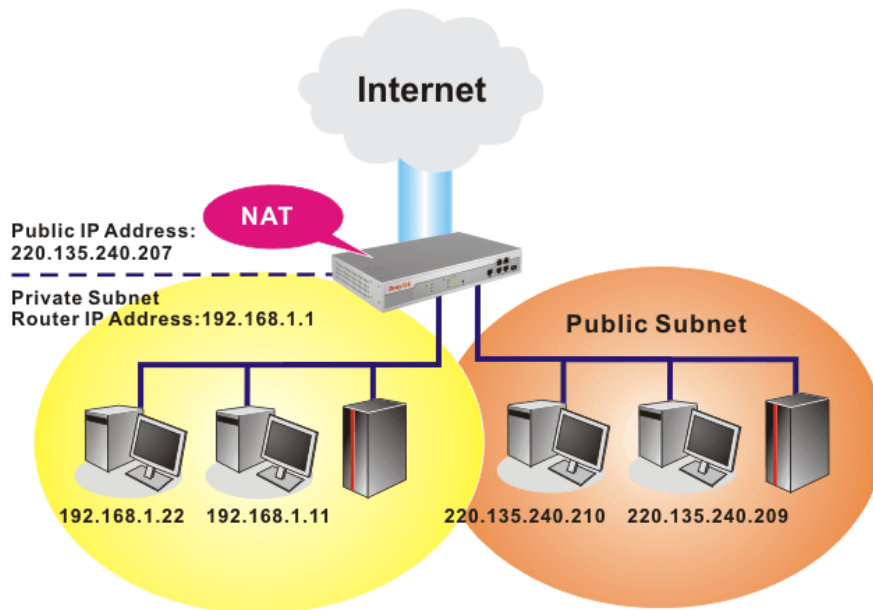

What is Routing Information Protocol (RIP)

Vigor router will exchange routing information with neighboring routers using the RIP to accomplish IP routing. This allows users to change the information of the router such as IP address and the routers will automatically inform for each other.

What is Static Route

When you have several subnets in your LAN, sometimes a more effective and quicker way for connection is the **Static routes** function rather than other method. You may simply set rules to forward data from one specified subnet to another specified subnet without the presence of RIP.

What are Virtual LANs and Rate Control

You can group local hosts by physical ports and create up to 4 virtual LANs. To manage the communication between different groups, please set up rules in Virtual LAN (VLAN) function and the rate of each.

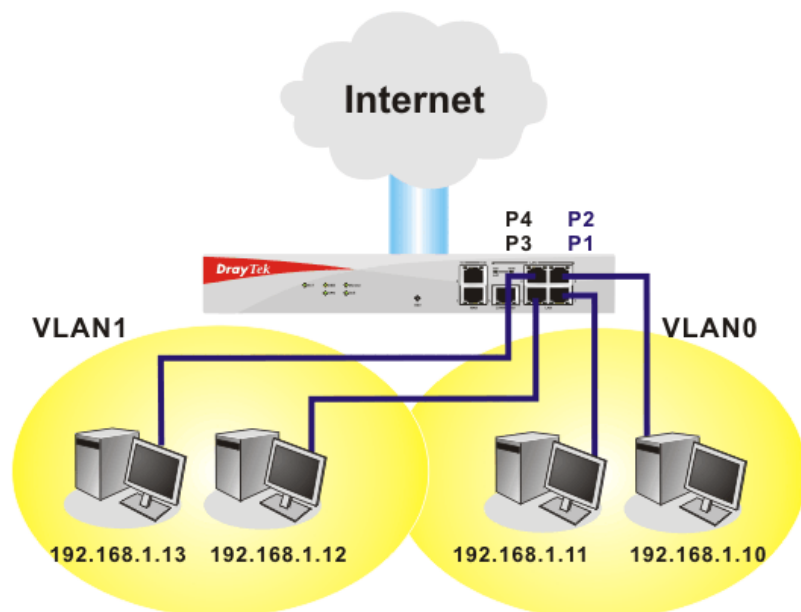

3.2.2 General Setup

This page provides you the general settings for LAN.

Click **LAN** to open the LAN settings page and choose **General Setup**.

LAN >> General Setup

Ethernet TCP / IP and DHCP Setup

LAN IP Network Configuration		DHCP Server Configuration	
For NAT Usage		<input checked="" type="radio"/> Enable Server <input type="radio"/> Disable Server	
1st IP Address	<input type="text" value="192.168.1.1"/>	Relay Agent:	<input type="radio"/> 1st Subnet <input type="radio"/> 2nd Subnet
1st Subnet Mask	<input type="text" value="255.255.255.0"/>	Start IP Address	<input type="text" value="192.168.1.10"/>
For IP Routing Usage <input type="radio"/> Enable <input checked="" type="radio"/> Disable		IP Pool Counts	<input type="text" value="50"/>
2nd IP Address	<input type="text" value="192.168.2.1"/>	Gateway IP Address	<input type="text" value="192.168.1.1"/>
2nd Subnet Mask	<input type="text" value="255.255.255.0"/>	DHCP Server IP Address for Relay Agent	<input type="text"/>
<input checked="" type="checkbox"/> 2nd Subnet DHCP Server		DNS Server IP Address	
RIP Protocol Control <input type="text" value="Disable"/>		<input type="checkbox"/> Force DNS manual setting	
		Primary IP Address	<input type="text" value="168.95.1.1"/>
		Secondary IP Address	<input type="text"/>

- 1st IP Address** Type in private IP address for connecting to a local private network (Default: 192.168.1.1).
- 1st Subnet Mask** Type in an address code that determines the size of the network. (Default: 255.255.255.0/ 24)
- For IP Routing Usage** Click **Enable** to invoke this function. The default setting is **Disable**.
- 2nd IP Address** Type in secondary IP address for connecting to a subnet. (Default: 192.168.2.1/ 24)
- 2nd Subnet Mask** An address code that determines the size of the network. (Default: 255.255.255.0/ 24)
- 2nd DHCP Server** You can configure the router to serve as a DHCP server for the 2nd subnet.

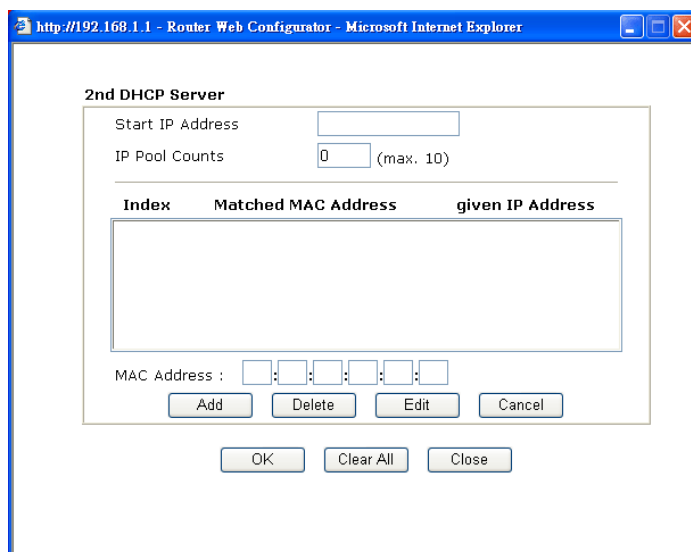

Start IP Address: Enter a value of the IP address pool for the DHCP server to start with when issuing IP addresses. If the 2nd IP address of your router is 220.135.240.1, the starting IP address must be 220.135.240.2 or greater, but smaller than 220.135.240.254.

IP Pool Counts: Enter the number of IP addresses in the pool. The maximum is 10. For example, if you type 3 and the 2nd IP address of your router is 220.135.240.1, the range of IP address by the DHCP server will be from 220.135.240.2 to 220.135.240.11.

MAC Address: Enter the MAC Address of the host one by one and click **Add** to create a list of hosts to be assigned, deleted or edited IP address from above pool. Set a list of MAC Address for 2nd DHCP server will help router to assign the correct IP address of the correct subnet to the correct host. So those hosts in 2nd subnet won't get an IP address belonging to 1st subnet.

RIP Protocol Control

Disable deactivates the RIP protocol. It will lead to a stoppage of the exchange of routing information between routers. (Default)

RIP Protocol Control

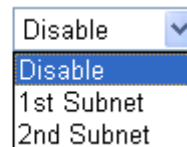

1st Subnet - Select the router to change the RIP information of the 1st subnet with neighboring routers.

2nd Subnet - Select the router to change the RIP information of the 2nd subnet with neighboring routers.

DHCP Server Configuration

DHCP stands for Dynamic Host Configuration Protocol. The router by factory default acts a DHCP server for your network so it automatically dispatch related IP settings to any local user configured as a DHCP client. It is highly recommended that you leave the router enabled as a DHCP server if you do not have a DHCP server for your network.

If you want to use another DHCP server in the network other than the Vigor Router's, you can let Relay Agent help you to redirect the DHCP request to the specified location.

Enable Server - Let the router assign IP address to every host in the LAN.

Disable Server - Let you manually assign IP address to every host in the LAN.

Relay Agent - (1st subnet/2nd subnet) Specify which subnet that DHCP server is located the relay agent should redirect the DHCP request to.

Start IP Address - Enter a value of the IP address pool for the DHCP server to start with when issuing IP addresses. If the 1st IP address of your router is 192.168.1.1, the starting IP address must be 192.168.1.2 or greater, but smaller than 192.168.1.254.

IP Pool Counts - Enter the maximum number of PCs that you want the DHCP server to assign IP addresses to. The default is 50 and the maximum is 253.

Gateway IP Address - Enter a value of the gateway IP address for the DHCP server. The value is usually as same as the 1st IP address of the router, which means the router is the default gateway.

DNS Server Configuration

DHCP Server IP Address for Relay Agent - Set the IP address of the DHCP server you are going to use so the Relay Agent can help to forward the DHCP request to the DHCP server.

DNS stands for Domain Name System. Every Internet host must have a unique IP address, also they may have a human-friendly, easy to remember name such as www.yahoo.com. The DNS server converts the user-friendly name into its equivalent IP address.

Force DNS manual setting - Force router to use DNS servers in this page instead of DNS servers given by the Internet Access server (PPPoE, PPTP, L2TP or DHCP server).

Primary IP Address - You must specify a DNS server IP address here because your ISP should provide you with usually more than one DNS Server. If your ISP does not provide it, the router will automatically apply default DNS Server IP address: 194.109.6.66 to this field.

Secondary IP Address - You can specify secondary DNS server IP address here because your ISP often provides you more than one DNS Server. If your ISP does not provide it, the router will automatically apply default secondary DNS Server IP address: 194.98.0.1 to this field.

The default DNS Server IP address can be found via Online Status:

System Status			System Uptime: 0:53:43	
LAN Status		Primary DNS: 168.95.1.1	Secondary DNS: 168.95.1.1	
IP Address	TX Packets	RX Packets		
192.168.1.1	1878	1739		

If both the Primary IP and Secondary IP Address fields are left empty, the router will assign its own IP address to local users as a DNS proxy server and maintain a DNS cache.

If the IP address of a domain name is already in the DNS cache, the router will resolve the domain name immediately. Otherwise, the router forwards the DNS query packet to the external DNS server by establishing a WAN (e.g. DSL/Cable) connection.

There are two common scenarios of LAN settings that stated in Chapter 4. For the configuration examples, please refer to that chapter to get more information for your necessity.

3.2.3 Static Route

Go to LAN to open setting page and choose **Static Route**.

LAN >> Static Route Setup

Static Route Configuration			Set to Factory Default		View Routing Table	
Index	Destination Address	Status	Index	Destination Address	Status	
<u>1.</u>	???	?	<u>6.</u>	???	?	
<u>2.</u>	???	?	<u>7.</u>	???	?	
<u>3.</u>	???	?	<u>8.</u>	???	?	
<u>4.</u>	???	?	<u>9.</u>	???	?	
<u>5.</u>	???	?	<u>10.</u>	???	?	

Status: v --- Active, x --- Inactive, ? --- Empty

Index

The number (1 to 10) under Index allows you to open next page to set up static route.

Destination Address Displays the destination address of the static route.

Status Displays the status of the static route.

Viewing Routing Table Displays the routing table for your reference.

Diagnostics >> View Routing Table

Current Running Routing Table		Refresh
Key: C - connected, S - static, R - RIP, * - default, ~ - private		
* 0.0.0.0/	0.0.0.0 via 172.16.3.1,	WAN1
C~ 192.168.1.0/	255.255.255.0 is directly connected,	LAN
C 172.16.3.0/	255.255.255.0 is directly connected,	WAN1

Add Static Routes to Private and Public Networks

Here is an example of setting Static Route in Main Router so that user A and B locating in different subnet can talk to each other via the router. Assuming the Internet access has been configured and the router works properly:

- use the Main Router to surf the Internet.
- create a private subnet 192.168.10.0 using an internal Router A (192.168.1.2)
- create a public subnet 211.100.88.0 via an internal Router B (192.168.1.3).
- have set Main Router 192.168.1.1 as the default gateway for the Router A 192.168.1.2.

Before setting Static Route, user A cannot talk to user B for Router A can only forward recognized packets to its default gateway Main Router.

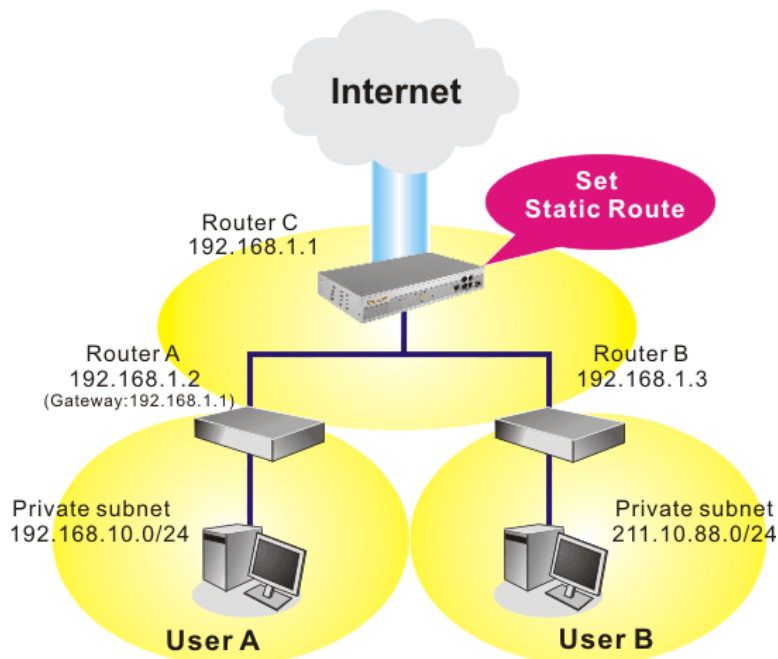

Go to **LAN** page and click **General Setup**, select 1st Subnet as the **RIP Protocol Control**. Then click the **OK** button.

Note: There are two reasons that we have to apply RIP Protocol Control on 1st Subnet. The first is that the LAN interface can exchange RIP packets with the neighboring routers via the 1st subnet (192.168.1.0/24). The second is that those hosts on the internal private subnets (ex. 192.168.10.0/24) can access the Internet via the router, and continuously exchange of IP routing information with different subnets.

1. Click the **LAN - Static Route** and click on the **Index Number 1**. Check the **Enable** box. Please add a static route as shown below, which regulates all packets destined to 192.168.10.0 will be forwarded to 192.168.1.2. Click **OK**.

LAN >> Static Route Setup

Index No. 1

Enable

Destination IP Address: 192.168.10.0

Subnet Mask: 255.255.255.0

Gateway IP Address: 192.168.1.2

Network Interface: LAN

OK Cancel

2. Return to **Static Route Setup** page. Click on another **Index Number** to add another static route as show below, which regulates all packets destined to 211.100.88.0 will be forwarded to 192.168.1.3.

LAN >> Static Route Setup

Index No. 1

Enable

Destination IP Address: 211.100.88.0

Subnet Mask: 255.255.255.0

Gateway IP Address: 192.168.1.3

Network Interface: LAN

OK Cancel

3. Go to **Diagnostics** and choose **Routing Table** to verify current routing table.

Diagnostics >> View Routing Table

Current Running Routing Table | Refresh

```

Key: C - connected, S - static, R - RIP, * - default, ~ - private
*      0.0.0.0/      0.0.0.0 via 172.16.3.1,  WAN1
S~    192.168.10.0/  255.255.255.0 via 192.168.1.2,  LAN
C~    192.168.1.0/   255.255.255.0 is directly connected,  LAN
C      172.16.3.0/   255.255.255.0 is directly connected,  WAN1
S~    211.100.88.0/  255.255.255.0 via 192.168.1.3,  LAN

```

3.2.4 VLAN

Note: This menu is available for **Vigor5500** model. For Vigor5500G, please refer to 3.13.

Virtual LAN function provides you a very convenient way to manage hosts by grouping them based on the physical port. You can also manage the in/out rate of each port. Go to **LAN** page and select **VLAN**. The following page will appear. Click **Enable** to invoke VLAN function.

LAN >> VLAN Configuration

VLAN Configuration

Enable

	P1	P2	P3	P4
VLAN0	<input type="checkbox"/>	<input type="checkbox"/>	<input type="checkbox"/>	<input type="checkbox"/>
VLAN1	<input type="checkbox"/>	<input type="checkbox"/>	<input type="checkbox"/>	<input type="checkbox"/>
VLAN2	<input type="checkbox"/>	<input type="checkbox"/>	<input type="checkbox"/>	<input type="checkbox"/>
VLAN3	<input type="checkbox"/>	<input type="checkbox"/>	<input type="checkbox"/>	<input type="checkbox"/>

OK Clear Cancel

To add or remove a VLAN, please refer to the following example.

1. If, VLAN 0 is consisted of hosts linked to P1 and P2 and VLAN 1 is consisted of hosts linked to P3 and P4.

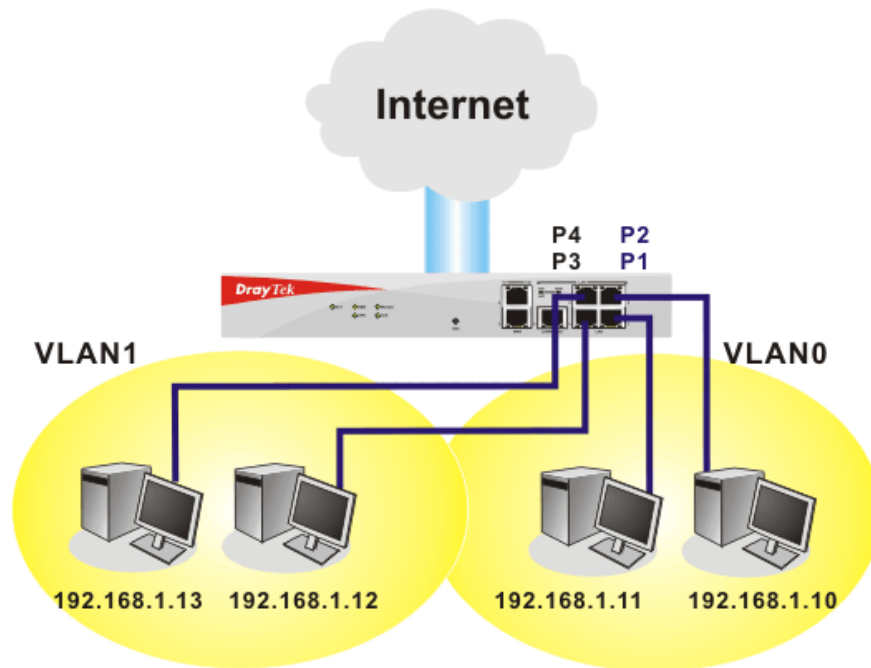

- After checking the box to enable VLAN function, you will check the table according to the needs as shown below.

LAN >> VLAN Configuration

VLAN Configuration

Enable

	P1	P2	P3	P4
VLAN0	<input checked="" type="checkbox"/>	<input checked="" type="checkbox"/>	<input type="checkbox"/>	<input type="checkbox"/>
VLAN1	<input type="checkbox"/>	<input type="checkbox"/>	<input checked="" type="checkbox"/>	<input checked="" type="checkbox"/>
VLAN2	<input type="checkbox"/>	<input type="checkbox"/>	<input type="checkbox"/>	<input type="checkbox"/>
VLAN3	<input type="checkbox"/>	<input type="checkbox"/>	<input type="checkbox"/>	<input type="checkbox"/>

OK Clear Cancel

To remove VLAN, uncheck the needed box and click **OK** to save the results.

3.2.5 Bind IP to MAC

This function is used to bind the IP and MAC address in LAN to have a strengthen control in network. When this function is enabled, all the assigned IP and MAC address binding together cannot be changed. If you modified the binding IP or MAC address, it might cause you not access into the Internet.

Click **LAN** and click **Bind IP to MAC** to open the setup page.

LAN >> Bind IP to MAC

Bind IP to MAC

Note: IP-MAC binding presets DHCP Allocations.
If you select Strict Bind, unspecified LAN clients cannot access the Internet.

Enable Disable Strict Bind

ARP Table | [Select All](#) | [Sort](#) | [Refresh](#) | **IP Bind List** | [Select All](#) | [Sort](#) |

IP Address	Mac Address
192.168.1.10	00-0E-A6-2A-D5-A1
192.168.1.100	00-08-A1-36-97-5D
192.168.1.11	00-13-D4-A4-99-92
192.168.1.12	00-0B-CD-55-CB-45
192.168.1.10	00-13-D4-A4-99-92
192.168.1.123	00-08-A1-01-53-BB

Index	IP Address	Mac Address
-------	------------	-------------

Add and Edit

IP Address

Mac Address : : : : :

Add Edit Delete

Enable Click this radio button to invoke this function. However, IP/MAC which is not listed in IP Bind List also can connect to Internet.

Disable Click this radio button to disable this function. All the settings on this page will be invalid.

Strict Bind Click this radio button to block the connection of the IP/MAC which is not listed in IP Bind List.

ARP Table This table is the LAN ARP table of this router. The information for IP and MAC will be displayed in this field. Each pair of IP

and MAC address listed in ARP table can be selected and added to IP Bind List by clicking **Add** below.

Add and Edit

IP Address – Type the IP address that will be used for the specified MAC address.

Mac Address – Type the MAC address that is used to bind with the assigned IP address.

Refresh

It is used to refresh the ARP table. When there is one new PC added to the LAN, you can click this link to obtain the newly ARP table information.

IP Bind List

It displays a list for the IP bind to MAC information.

Add

It allows you to add the one you choose from the ARP table or the IP/MAC address typed in **Add and Edit** to the table of **IP Bind List**.

Edit

It allows you to edit and modify the selected IP address and MAC address that you create before.

Delete

You can remove any item listed in **IP Bind List**. Simply click and select the one, and click **Delete**. The selected item will be removed from the **IP Bind List**.

Note: Before you select **Strict Bind**, you have to bind one set of IP/MAC address for one PC. If not, no one of the PCs can access into Internet. And the web configurator of the router might not be accessed.

3.3 NAT

Usually, the router serves as an NAT (Network Address Translation) router. NAT is a mechanism that one or more private IP addresses can be mapped into a single public one. Public IP address is usually assigned by your ISP, for which you may get charged. Private IP addresses are recognized only among internal hosts.

When the outgoing packets destined to some public server on the Internet reach the NAT router, the router will change its source address into the public IP address of the router, select the available public port, and then forward it. At the same time, the router shall list an entry in a table to memorize this address/port-mapping relationship. When the public server response, the incoming traffic, of course, is destined to the router's public IP address and the router will do the inversion based on its table. Therefore, the internal host can communicate with external host smoothly.

The benefit of the NAT includes:

- **Save cost on applying public IP address and apply efficient usage of IP address.** NAT allows the internal IP addresses of local hosts to be translated into one public IP address, thus you can have only one IP address on behalf of the entire internal hosts.
- **Enhance security of the internal network by obscuring the IP address.** There are many attacks aiming victims based on the IP address. Since the attacker cannot be aware of any private IP addresses, the NAT function can protect the internal network.

On NAT page, you will see the private IP address defined in RFC-1918. Usually we use the 192.168.1.0/24 subnet for the router. As stated before, the NAT facility can map one or more IP addresses and/or service ports into different specified services. In other words, the NAT function can be achieved by using port mapping methods.

Below shows the menu items for NAT.

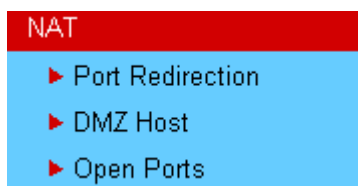

3.3.1 Port Redirection

Port Redirection is usually set up for server related service inside the local network (LAN), such as web servers, FTP servers, E-mail servers etc. Most of the case, you need a public IP address for each server and this public IP address/domain name are recognized by all users. Since the server is actually located inside the LAN, the network well protected by NAT of the router, and identified by its private IP address/port, the goal of Port Redirection function is to forward all access request with public IP address from external users to the mapping private IP address/port of the server.

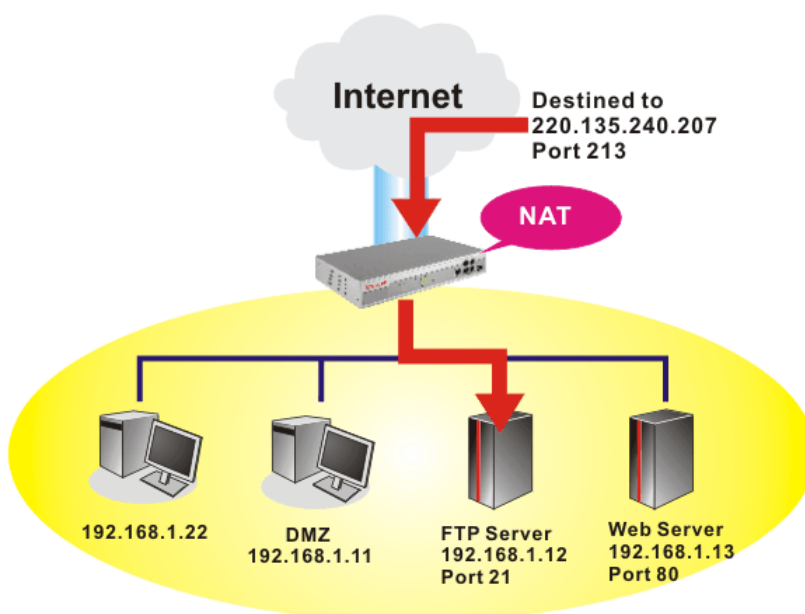

The port redirection can only apply to incoming traffic.

To use this function, please go to **NAT** page and choose **Port Redirection** web page. The **Port Redirection Table** provides 20 port-mapping entries for the internal hosts.

NAT >> Port Redirection

Port Redirection

| [Set to Factory Default](#) |

Index	Service Name	Public Port	Private IP	Status
<u>1.</u>				x
<u>2.</u>				x
<u>3.</u>				x
<u>4.</u>				x
<u>5.</u>				x
<u>6.</u>				x
<u>7.</u>				x
<u>8.</u>				x
<u>9.</u>				x
<u>10.</u>				x

<< [1-10](#) | [11-20](#) >>

[Next](#) >>

Press any number under Index to access into next page for configuring port redirection.

NAT >> Port Redirection

Index No. 1

Enable

Mode Range ▾

Service Name

Protocol TCP ▾

WAN IP 2.WAN IP Alias[1]172.16.3.229 ▾

Public Port -

Private IP -

Private Port

Note: In "Range" Mode the End IP will be calculated automatically once the Public Port and Start IP have been entered.

Enable

Check this box to enable such port redirection setting.

Mode

Two options (Single and Range) are provided here for you to choose. To set a range for the specific service, select **Range**. In Range mode, if the public port (start port and end port) and the starting IP of private IP had been entered, the system will calculate and display the ending IP of private IP automatically.

Service Name

Enter the description of the specific network service.

Protocol

Select the transport layer protocol (TCP or UDP).

Public Port

Specify which port can be redirected to the specified **Private IP and Port** of the internal host. If you choose **Range** as the port redirection mode, you will see two boxes on this field. Simply type the required numbers on these two boxes.

Private IP

Specify the private IP address of the internal host providing the service. If you choose **Range** as the port redirection mode, you will see two boxes on this field. Simply type the IP address in the first

box (as the starting point). The second one is assigned automatically after you type the private port number below.

Private Port

Specify the private port number of the service offered by the internal host. After you enter the proper number in this box, the second box of Private IP address will be assigned accordingly.

Active

Check this box to activate the port-mapping entry you have defined.

Note that the router has its own built-in services (servers) such as Telnet, HTTP and FTP etc. Since the common port numbers of these services (servers) are all the same, you may need to reset the router in order to avoid confliction.

For example, the built-in web configurator in the router is with default port 80, which may conflict with the web server in the local network, `http://192.168.1.13:80`. Therefore, you need to **change the router's http port to any one other than the default port 80** to avoid conflict, such as 8080. This can be set in the **System Maintenance >>Management Setup**. You then will access the admin screen of by suffixing the IP address with 8080, e.g., `http://192.168.1.1:8080` instead of port 80.

System Maintenance >> Management

Management Setup

Management Access Control <input type="checkbox"/> Enable remote firmware upgrade(FTP) <input type="checkbox"/> Allow management from the Internet <input checked="" type="checkbox"/> Disable PING from the Internet	Management Port Setup <input type="radio"/> Default Ports (Telnet: 23, HTTP: 80, HTTPS: 443, FTP: 21) <input checked="" type="radio"/> User Define Ports Telnet Port <input type="text" value="23"/> HTTP Port <input type="text" value="80"/> HTTPS Port <input type="text" value="443"/> FTP Port <input type="text" value="21"/>
Access List List IP Subnet Mask 1 <input type="text"/> <input type="text"/> 2 <input type="text"/> <input type="text"/> 3 <input type="text"/> <input type="text"/>	SNMP Setup <input type="checkbox"/> Enable SNMP Agent Get Community <input type="text" value="public"/> Set Community <input type="text" value="private"/> Manager Host IP <input type="text"/> Trap Community <input type="text" value="public"/> Notification Host IP <input type="text"/> Trap Timeout <input type="text" value="10"/> seconds

OK

3.3.2 DMZ Host

As mentioned above, **Port Redirection** can redirect incoming TCP/UDP or other traffic on particular ports to the specific private IP address/port of host in the LAN. However, other IP protocols, for example Protocols 50 (ESP) and 51 (AH), do not travel on a fixed port. Vigor router provides a facility **DMZ Host** that maps ALL unsolicited data on any protocol to a single host in the LAN. Regular web surfing and other such Internet activities from other clients will continue to work without inappropriate interruption. **DMZ Host** allows a defined internal user to be totally exposed to the Internet, which usually helps some special applications such as Netmeeting or Internet Games etc.

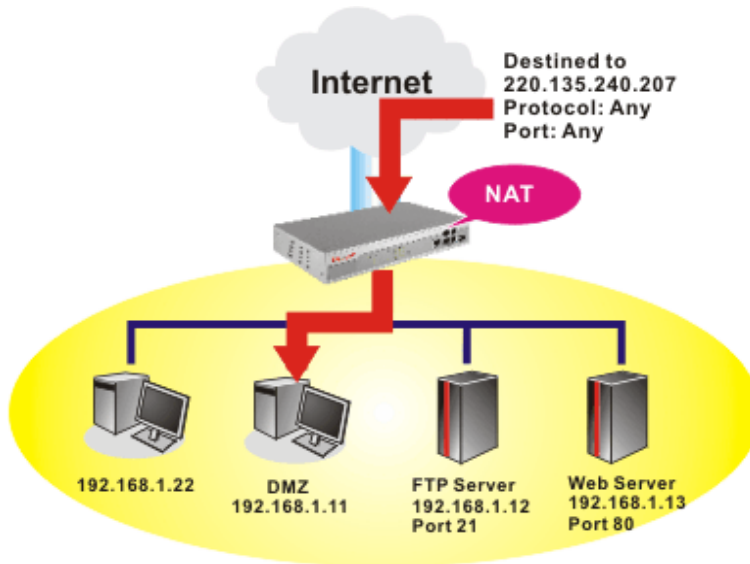

Note: The inherent security properties of NAT are somewhat bypassed if you set up DMZ host. We suggest you to add additional filter rules or a secondary firewall.

Click **DMZ Host** to open the following page:

NAT >> DMZ Host Setup

DMZ Host Setup

WAN 1

Active True IP ▼

Private IP Choose PC

MAC Address of the True IP DMZ Host 00 .00 .00 :00 .00 .00

Note: When a True-IP DMZ host is turned on, it will force the router's WAN connection to be always on.

WAN 2

Enable

Private IP Choose PC

OK

WAN1 This page allows you to configure **Private IP** or **Active True IP** as DMZ host.

Private IP If you choose **Private IP** as DMZ host, you can type a private IP in this box or use Choose PC button to choose the one you want.

MAC Address of the True.... If you choose **Active True IP** as DMZ host, please type the MAC address of the one you want.

If you previously have set up **WAN Alias** in **Internet Access>>PPPoE**, you will find them in **Aux. WAN IP list** for your selection.

NAT >> DMZ Host Setup

DMZ Host Setup

WAN 1			
Index	Enable	Aux. WAN IP	Private IP
1.	<input type="checkbox"/>	172.16.3.229	<input type="text"/> <input type="button" value="Choose PC"/>
2.	<input type="checkbox"/>	172.16.3.22	<input type="text"/> <input type="button" value="Choose PC"/>

WAN 2		
Enable	Private IP	
<input type="checkbox"/>	<input type="text"/>	<input type="button" value="Choose PC"/>

Enable

Check to enable the DMZ Host function.

Private IP

Enter the private IP address of the DMZ host, or click **Choose PC** to select one.

Choose PC

Click this button and then a window will automatically pop up, as depicted below. The window consists of a list of private IP addresses of all hosts in your LAN network. Select one private IP address in the list to be the DMZ host.

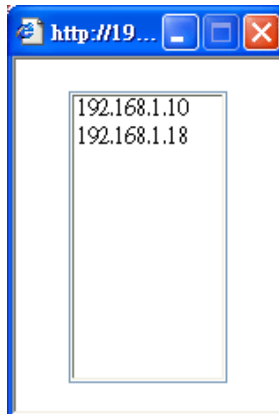

When you have selected one private IP from the above dialog, the IP address will be shown on the following screen. Click **OK** to save the setting.

NAT >> DMZ Host Setup

DMZ Host Setup

WAN 1			
Index	Enable	Aux. WAN IP	Private IP
1.	<input checked="" type="checkbox"/>	172.16.3.229	192.168.1.10 <input type="button" value="Choose PC"/>
2.	<input type="checkbox"/>	172.16.3.22	<input type="text"/> <input type="button" value="Choose PC"/>

WAN 2		
Enable	Private IP	
<input type="checkbox"/>	<input type="text"/>	<input type="button" value="Choose PC"/>

3.3.3 Open Ports

Open Ports allows you to open a range of ports for the traffic of special applications. Common application of Open Ports includes P2P application (e.g., BT, KaZaA, Gnutella, WinMX, eMule and others), Internet Camera etc. Ensure that you keep the application involved up-to-date to avoid falling victim to any security exploits.

Click **Open Ports** to open the following page:

NAT >> Open Ports

Open Ports Setup				Set to Factory Default
Index	Comment	WAN Interface	Local IP Address	Status
1.				X
2.				X
3.				X
4.				X
5.				X
6.				X
7.				X
8.				X
9.				X
10.				X

<< [1-10](#) | [11-20](#) >> [Next](#) >>

- Index** Indicate the relative number for the particular entry that you want to offer service in a local host. You should click the appropriate index number to edit or clear the corresponding entry.
- Comment** Specify the name for the defined network service.
- WAN Interface** Display the WAN interface for the entry.
- Local IP Address** Display the private IP address of the local host offering the service.
- Status** Display the state for the corresponding entry. X or V is to represent the **Inactive** or **Active** state.

To add or edit port settings, click one index number on the page. The index entry setup page will pop up. In each index entry, you can specify **10** port ranges for diverse services.

Index No. 1

<input checked="" type="checkbox"/> Enable Open Ports							
Comment		<input type="text" value="P2P"/>					
WAN Interface		<input type="text" value="WAN1"/>					
Local Computer		<input type="text" value="192.168.1.10"/>	<input type="button" value="Choose PC"/>				
	Protocol	Start Port	End Port		Protocol	Start Port	End Port
1.	<input type="text" value="TCP"/>	<input type="text" value="4500"/>	<input type="text" value="4700"/>	6.	<input type="text" value="-----"/>	<input type="text" value="0"/>	<input type="text" value="0"/>
2.	<input type="text" value="UDP"/>	<input type="text" value="4500"/>	<input type="text" value="4700"/>	7.	<input type="text" value="-----"/>	<input type="text" value="0"/>	<input type="text" value="0"/>
3.	<input type="text" value="-----"/>	<input type="text" value="0"/>	<input type="text" value="0"/>	8.	<input type="text" value="-----"/>	<input type="text" value="0"/>	<input type="text" value="0"/>
4.	<input type="text" value="-----"/>	<input type="text" value="0"/>	<input type="text" value="0"/>	9.	<input type="text" value="-----"/>	<input type="text" value="0"/>	<input type="text" value="0"/>
5.	<input type="text" value="-----"/>	<input type="text" value="0"/>	<input type="text" value="0"/>	10.	<input type="text" value="-----"/>	<input type="text" value="0"/>	<input type="text" value="0"/>

- Enable Open Ports** Check to enable this entry.
- Comment** Make a name for the defined network application/service.
- WAN Interface** Specify the WAN interface that will be used for this entry.
- Local Computer** Enter the private IP address of the local host or click **Choose PC** to select one.
- Choose PC** Click this button and, subsequently, a window having a list of private IP addresses of local hosts will automatically pop up. Select the appropriate IP address of the local host in the list.
- Protocol** Specify the transport layer protocol. It could be **TCP**, **UDP**, or **-----** (none) for selection.
- Start Port** Specify the starting port number of the service offered by the local host.
- End Port** Specify the ending port number of the service offered by the local host.

3.4 Objects Settings

For IPs in a range and service ports in a limited range usually will be applied for configuring router's settings, therefore we can define them with *objects* and bind them with *groups* for using conveniently. Later, we can select that object/group that can apply it. For example, all the IPs in the same department can be defined with an IP object (a range of IP address).

Objects Setting

- ▶ IP Object
- ▶ IP Group
- ▶ Service Type Object
- ▶ Service Type Group
- ▶ CSM Profile

3.4.1 IP Object

You can set up to 192 sets of IP Objects with different conditions.

Objects Setting >> IP Object

IP Object Profiles: | [Set to Factory Default](#) |

Index	Name	Index	Name
1.		17.	
2.		18.	
3.		19.	
4.		20.	
5.		21.	
6.		22.	
7.		23.	
8.		24.	
9.		25.	
10.		26.	
11.		27.	
12.		28.	
13.		29.	
14.		30.	
15.		31.	
16.		32.	

<< [1-32](#) | [33-64](#) | [65-96](#) | [97-128](#) | [129-160](#) | [161-192](#) >> [Next](#) >>

Set to Factory Default Clear all profiles.

Click the number under Index column for settings in detail.

Objects Setting >> IP Object

Profile Index : 1

Name:	<input type="text" value="RD Department"/>
Interface:	<input type="text" value="Any"/>
Address Type:	<input type="text" value="Range Address"/>
Start IP Address:	<input type="text" value="192.168.1.64"/>
End IP Address:	<input type="text" value="192.168.1.75"/>
Subnet Mask:	<input type="text" value="0.0.0.0"/>
Invert Selection:	<input type="checkbox"/>

Name Type a name for this profile. Maximum 15 characters are allowed.

Interface Choose a proper interface (WAN, LAN or Any).

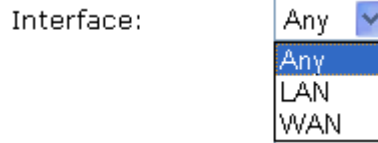

For example, the **Direction** setting in **Edit Filter Rule** will ask you specify IP or IP range for WAN or LAN or any IP address. If you choose LAN as the **Interface** here, and choose LAN as the direction setting in **Edit Filter Rule**, then all the IP addresses specified with LAN interface will be opened for you to choose in **Edit Filter Rule** page.

Address Type Determine the address type for the IP address.
Select **Single Address** if this object contains one IP address only.
Select **Range Address** if this object contains several IPs within a range.
Select **Subnet Address** if this object contains one subnet for IP address.
Select **Any Address** if this object contains any IP address.

Start IP Address Type the start IP address for Single Address type.

End IP Address Type the end IP address if the Range Address type is selected.

Subnet Mask Type the subnet mask if the Subnet Address type is selected.

Invert Select If it is checked, all the IP addresses except the ones listed above will be applied later while it is chosen.

Below is an example of IP objects settings.

Objects Setting >> IP Object

IP Object Profiles:

Index	Name
1.	RD Department
2.	Financial Dept.
3.	HR Department
4.	
5.	

3.4.2 IP Group

This page allows you to bind several IP objects into one IP group.

Objects Setting >> IP Group

IP Group Table: | [Set to Factory Default](#) |

Index	Name	Index	Name
1.		17.	
2.		18.	
3.		19.	
4.		20.	
5.		21.	
6.		22.	
7.		23.	
8.		24.	
9.		25.	
10.		26.	
11.		27.	
12.		28.	
13.		29.	
14.		30.	
15.		31.	
16.		32.	

Set to Factory Default Clear all profiles.

Click the number under Index column for settings in detail.

Objects Setting >> IP Group

Profile Index : 1

Name:

Interface: ▾

Available IP Objects

1-RD Department
 2-Financial Dept.
 3-HR Department

Selected IP Objects

(Empty)

Name Type a name for this profile. Maximum 15 characters are allowed.

Interface Choose WAN, LAN or Any to display all the available IP objects with the specified interface.

Available IP Objects All the available IP objects (created in IP Object web page) with the specified interface chosen above will be shown in this box.

Selected IP Objects Click button to add the selected IP objects in this box.

3.4.3 Service Type Object

You can set up to 96 sets of Service Type Objects with different conditions.

Objects Setting >> Service Type Object

Service Type Object Profiles: | [Set to Factory Default](#) |

Index	Name	Index	Name
1.		17.	
2.		18.	
3.		19.	
4.		20.	
5.		21.	
6.		22.	
7.		23.	
8.		24.	
9.		25.	
10.		26.	
11.		27.	
12.		28.	
13.		29.	
14.		30.	
15.		31.	
16.		32.	

<< [1-32](#) | [33-64](#) | [65-96](#) >> [Next](#) >>

Set to Factory Default Clear all profiles.

Click the number under Index column for settings in detail.

Objects Setting >> Service Type Object Setup

Profile Index : 1

Name	SIP	
Protocol	TCP	6
Source Port	=	1 ~ 65535
Destination Port	=	80 ~ 80

Name Type a name for this profile.

Protocol Specify the protocol(s) which this profile will apply to.

TCP	6
-----	---

- Any
- ICMP
- IGMP
- TCP
- UDP
- TCP/UDP
- Other

Source/Destination Port **Source Port** and the **Destination Port** column are available for TCP/UDP protocol. It can be ignored for other protocols. The filter rule will filter out any port number.

(=) – when the first and last value are the same, it indicates one port; when the first and last values are different, it indicates a range for the port and available for this profile.

(!=) – when the first and last value are the same, it indicates all the ports except the port defined here; when the first and last values are different, it indicates that all the ports except the range defined here are available for this service type.

(>) – the port number greater than this value is available.

(<) – the port number less than this value is available for this profile.

Below is an example of service type objects settings.

Service Type Object Profiles:

Index	Name
<u>1.</u>	SIP
<u>2.</u>	RTP
<u>3.</u>	
<u>4.</u>	

3.4.4 Service Type Group

This page allows you to bind several service types into one group.

Objects Setting >> Service Type Group

Service Type Group Table:

[Set to Factory Default](#)

Group	Name	Group	Name
<u>1.</u>		<u>17.</u>	
<u>2.</u>		<u>18.</u>	
<u>3.</u>		<u>19.</u>	
<u>4.</u>		<u>20.</u>	
<u>5.</u>		<u>21.</u>	
<u>6.</u>		<u>22.</u>	
<u>7.</u>		<u>23.</u>	
<u>8.</u>		<u>24.</u>	
<u>9.</u>		<u>25.</u>	
<u>10.</u>		<u>26.</u>	
<u>11.</u>		<u>27.</u>	
<u>12.</u>		<u>28.</u>	
<u>13.</u>		<u>29.</u>	
<u>14.</u>		<u>30.</u>	
<u>15.</u>		<u>31.</u>	
<u>16.</u>		<u>32.</u>	

Set to Factory Default Clear all profiles.

Click the number under Index column for settings in detail.

Profile Index : 1

Name:

Available Service Type Objects		Selected Service Type Objects
1-SIP 2-RTP	<input type="button" value=">>"/> <input type="button" value="<<"/>	

- Name** Type a name for this profile.
- Available Service Type Objects** You can add IP objects from IP Objects page. All the available IP objects will be shown in this box.
- Selected Service Type Objects** Click button to add the selected IP objects in this box.

3.4.5 CSM Profile

You can define policy profiles for different policy of IM (Instant Messenger)/P2P (Peer to Peer) application. CSM profile can be used in Filter Setup page.

CSM Profile Table: [Set to Factory Default](#)

Profile	Name	Profile	Name
<u>1.</u>		<u>17.</u>	
<u>2.</u>		<u>18.</u>	
<u>3.</u>		<u>19.</u>	
<u>4.</u>		<u>20.</u>	
<u>5.</u>		<u>21.</u>	
<u>6.</u>		<u>22.</u>	
<u>7.</u>		<u>23.</u>	
<u>8.</u>		<u>24.</u>	
<u>9.</u>		<u>25.</u>	
<u>10.</u>		<u>26.</u>	
<u>11.</u>		<u>27.</u>	
<u>12.</u>		<u>28.</u>	
<u>13.</u>		<u>29.</u>	
<u>14.</u>		<u>30.</u>	
<u>15.</u>		<u>31.</u>	
<u>16.</u>		<u>32.</u>	

Set to Factory Default Clear all profiles.

Click the number under Index column for settings in detail.

Profile Index : 1

Profile Name:

Check for Disallow :

IM		VoIP
<input type="checkbox"/> MSN	<input checked="" type="checkbox"/> Yahoo Messenger	<input type="checkbox"/> ICQ
<input type="checkbox"/> AIM	<input checked="" type="checkbox"/> QQ	<input type="checkbox"/> iChat
<input type="checkbox"/> Google Talk		<input type="checkbox"/> jajah
<input type="checkbox"/> Web IM (http://www.e-messenger.net/)		<input type="checkbox"/> Skype
<input type="checkbox"/> Web MSN (http://webmessenger.msn.com/)		

P2P	
Protocol	Applications
<input type="checkbox"/> SoulSeek	SoulSeek
<input type="checkbox"/> eDonkey	eDonkey, eMule, Shareaza
<input type="checkbox"/> FastTrack	KazaA, iMesh
<input type="checkbox"/> Gnutella	BearShare, Limewire, Shareaza
<input type="checkbox"/> BitTorrent	BitTorrent

Profile Name Type a name for the CSM profile.

There are several items for IM, VoIP, P2P provided here for you to choose to disallow people using. Simple check the box (es) and then click **OK**. Later, in the **Firewall>>Edit Filter Set>>Edit Filter Rule** page, you can use **Content Management** drop down list to choose the proper CSM profile as the standard for the host(s) to follow.

3.5 Firewall

3.5.1 Basics for Firewall

While the broadband users demand more bandwidth for multimedia, interactive applications, or distance learning, security has been always the most concerned. The firewall of the Vigor router helps to protect your local network against attack from unauthorized outsiders. It also restricts users in the local network from accessing the Internet. Furthermore, it can filter out specific packets that trigger the router to build an unwanted outgoing connection.

The most basic security concept is to set user name and password while you install your router. The administrator login will prevent unauthorized access to the router configuration from your router.

Quick Start Wizard

Enter login password

Please enter an alpha-numeric string as your **Password** (Max 23 characters).

New Password	<input type="password"/>
Confirm Password	<input type="password"/>

< Back Next > Finish Cancel

If you did not set password during installation; you can go to **System Maintenance** to set up your password.

System Maintenance >> Administrator Password Setup

Administrator Password

Old Password	<input type="password"/>
New Password	<input type="password"/>
Confirm Password	<input type="password"/>

OK

Firewall Facilities

The users on the LAN are provided with secured protection by the following firewall facilities:

- User-configurable IP filter (Call Filter/ Data Filter).
- Stateful Packet Inspection (SPI): tracks packets and denies unsolicited incoming data
- Selectable Denial of Service (DoS) /Distributed DoS (DDoS) attacks protection
- URL Content Filter

IP Filters

Depending on whether there is an existing Internet connection, or in other words “the WAN link status is up or down”, the IP filter architecture categorizes traffic into two: **Call Filter** and **Data Filter**.

- **Call Filter** - When there is no existing Internet connection, **Call Filter** is applied to all traffic, all of which should be outgoing. It will check packets according to the filter rules. If legal, the packet will pass. Then the router shall “**initiate a call**” to build the Internet connection and send the packet to Internet.
- **Data Filter** - When there is an existing Internet connection, **Data Filter** is applied to incoming and outgoing traffic. It will check packets according to the filter rules. If legal, the packet will pass the router.

The following illustrations are flow charts explaining how router will treat incoming traffic and outgoing traffic respectively.

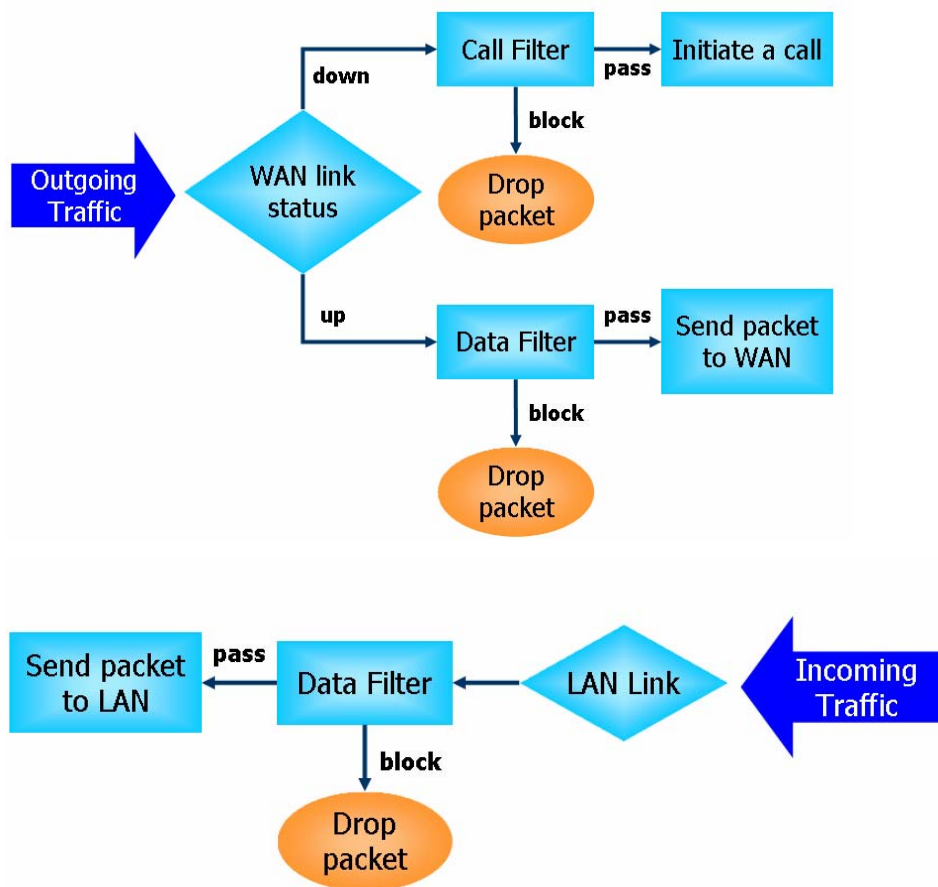

Stateful Packet Inspection (SPI)

Stateful inspection is a firewall architecture that works at the network layer. Unlike legacy static packet filtering, which examines a packet based on the information in its header, stateful inspection builds up a state machine to track each connection traversing all interfaces of the firewall and makes sure they are valid. The stateful firewall of Vigor router not just examine the header information also monitor the state of the connection.

Content Security Management (CSM)

As the popularity of all kinds of instant messenger application arises, communication cannot become much easier. Nevertheless, while some industry may leverage this as a great tool to connect with their customers, some industry may take reserve attitude in order to reduce employee misuse during office hour or prevent unknown security leak. It is similar situation for corporation towards peer-to-peer applications since file-sharing can be convenient but insecure at the same time. To address these needs, we provide CSM functionality.

Denial of Service (DoS) Defense

The **DoS Defense** functionality helps you to detect and mitigate the DoS attack. The attacks are usually categorized into two types, the flooding-type attacks and the vulnerability attacks. The flooding-type attacks will attempt to exhaust all your system's resource while the vulnerability attacks will try to paralyze the system by offending the vulnerabilities of the protocol or operation system.

The **DoS Defense** function enables the Vigor router to inspect every incoming packet based on the attack signature database. Any malicious packet that might duplicate itself to paralyze the host in the secure LAN will be strictly blocked and a Syslog message will be sent as warning, if you set up Syslog server.

Also the Vigor router monitors the traffic. Any abnormal traffic flow violating the pre-defined parameter, such as the number of thresholds, is identified as an attack and the Vigor router will activate its defense mechanism to mitigate in a real-time manner.

The below shows the attack types that DoS/DDoS defense function can detect:

1. SYN flood attack
2. UDP flood attack
3. ICMP flood attack
4. TCP Flag scan
5. Trace route
6. IP options
7. Unknown protocol
8. Land attack
9. Smurf attack
10. SYN fragment
11. ICMP fragment
12. Tear drop attack
13. Fraggle attack
14. Ping of Death attack
15. TCP/UDP port scan

Content Filtering

To provide an appropriate cyberspace to users, Vigor router equips with **URL Content Filter** not only to limit illegal traffic from/to the inappropriate web sites but also prohibit other web feature where malicious code may conceal.

Once a user type in or click on an URL with objectionable keywords, URL keyword blocking facility will decline the HTTP request to that web page thus can limit user's access to the website. You may imagine **URL Content Filter** as a well-trained convenience-store clerk who won't sell adult magazines to teenagers. At office, **URL Content Filter** can also provide a job-related only environment hence to increase the employee work efficiency. How can URL Content Filter work better than traditional firewall in the field of filtering? Because it checks the URL strings or some of HTTP data hiding in the payload of TCP packets while legacy firewall inspects packets based on the fields of TCP/IP headers only.

On the other hand, Vigor router can prevent user from accidentally downloading malicious codes from web pages. It's very common that malicious codes conceal in the executable objects, such as ActiveX, Java Applet, compressed files, and other executable files. Once downloading these types of files from websites, you may risk bringing threat to your system. For example, an ActiveX control object is usually used for providing interactive web feature. If malicious code hides inside, it may occupy user's system.

Web Filtering

We all know that the content on the Internet just like other types of media may be inappropriate sometimes. As a responsible parent or employer, you should protect those in your trust against the hazards. With Web filtering service of the Vigor router, you can protect your business from common primary threats, such as productivity, legal liability, network and security threats. For parents, you can protect your children from viewing adult websites or chat rooms.

Once you have activated your Web Filtering service in Vigor router and chosen the categories of website you wish to restrict, each URL address requested (e.g. www.bbc.co.uk) will be checked against our server database, powered by SurfControl. The database covering over 70 languages and 200 countries, over 1 billion Web pages divided into 40 easy-to-understand categories. This database is updated as frequent as daily by a global team of Internet researchers. The server will look up the URL and return a category to your router. Your Vigor router will then decide whether to allow access to this site according to the categories you have selected. Please note that this action will not introduce any delay in your Web surfing because each of multiple load balanced database servers can handle millions of requests for categorization.

Anti-Virus and Anti-Intrusion

Users might have much more confidence about the security in the network for data transmission if the functions of anti-virus and anti-intrusion are activated. The VigorPro router offers the mechanism of anti-virus and anti-intrusion. What you have to do is to set the proper profiles and invoke them. The anti-virus profile and anti-intrusion configuration can be set in Anti-Virus menu (refer to section 3.7) and Anti-Intrusion menu (refer to section 3.6). However, the mechanism must be enabled either in **Firewall>>General Setup** or **Firewall>>Filter Setup** web page. After you choose proper Anti-Virus profile and check Anti-Intrusion box, the Anti-Virus and Anti-Intrusion LEDs on the front panel will light up.

Below shows the menu items for Firewall.



3.5.2 General Setup

General Setup allows you to adjust settings of IP Filter and common options. Here you can enable or disable the **Call Filter** or **Data Filter**. Under some circumstance, your filter set can be linked to work in a serial manner. So here you assign the **Start Filter Set** only. Also you can configure the **Log Flag** settings, **Apply IP filter to VPN incoming packets**, and **Accept incoming fragmented UDP packets**.

Important: When some packet does not fit the rule configured in **Filter Setup** web page, the filtering action configured in general setup web page will apply to that packet.

Click **Firewall** and click **General Setup** to open the general setup page.

General Setup

Call Filter	<input checked="" type="radio"/> Enable <input type="radio"/> Disable	Start Filter Set	Set#1
Data Filter	<input checked="" type="radio"/> Enable <input type="radio"/> Disable	Start Filter Set	Set#2

Actions for default rule:

Application	Action/Profile	Log
Filter	Pass	<input type="checkbox"/>
Content Security Management	None	<input type="checkbox"/>
Anti-Virus	None	<input type="checkbox"/>
Anti-Intrusion:	<input type="checkbox"/> Enable	<input type="checkbox"/>
Anti-Spam	None	<input type="checkbox"/>

Accept large incoming fragmented UDP or ICMP packets (for some games, ex. CS)

OK Cancel

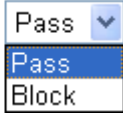
- Call Filter** Check **Enable** to activate the Call Filter function. Assign a start filter set for the Call Filter.
- Data Filter** Check **Enable** to activate the Data Filter function. Assign a start filter set for the Data Filter.
- Filter** Select **Pass** or **Block** for the packets that do not match with the filter rules.
- Filter 
- Content Security Management** Select a CSM profile for global IM/P2P application blocking. All the hosts in LAN must follow the standard configured in the CSM profile selected here. For detailed information, refer to the section of CSM profile setup.
- Anti-Virus** Select one of the anti-virus profile settings (created in **Anti-Virus>>Profile Setting**) for applying with this router. Please set at least one profile for anti-virus in **Anti-Virus-> Profile Setting** web page first.
- Anti-Intrusion** Check the **Enable** box to invoke anti-intrusion filter function.
- Anti-Spam** Select one of the anti-spam profile settings (created in **Anti-Spam>>Profile Setting**) for applying with this router. Please set at least one profile for anti-spam in **Anti-Spam>>Profile Setting** web page first.
- Log** For troubleshooting needs you can specify the filter/CSM/Anti-Virus/Anti-Intrusion/Anti-Spam log here by checking the box. Check this box to record all packets; or uncheck this box to ignore all the packet record. The log will be displayed on Draytek Syslog window.

Some on-line games (for example: Half Life) will use lots of fragmented UDP packets to transfer game data. Instinctively as a secure firewall, Vigor router will reject these fragmented packets to prevent attack unless you enable “**Accept Incoming Fragmented UDP Packets**”. By checking this box, you can play these kinds of on-line games. If security concern is in higher priority, you cannot enable “**Accept Incoming Fragmented UDP Packets**”.

3.5.3 Filter Setup

Click **Firewall** and click **Filter Setup** to open the setup page.

Firewall >> Filter Setup

Filter Setup		Set to Factory Default	
Set	Comments	Set	Comments
1.	Default Call Filter	7.	
2.	Default Data Filter	8.	
3.		9.	
4.		10.	
5.		11.	
6.		12.	

To edit or add a filter, click on the set number to edit the individual set. The following page will be shown. Each filter set contains up to 7 rules. Click on the rule number button to edit each rule. Check **Active** to enable the rule.

Firewall >> Filter Setup >> Edit Filter Set

Filter Set 1

Comments :

Filter Rule	Active	Comments	Move Up	Move Down
<input type="button" value="1"/>	<input checked="" type="checkbox"/>	Block NetBios		Down
<input type="button" value="2"/>	<input type="checkbox"/>		UP	Down
<input type="button" value="3"/>	<input type="checkbox"/>		UP	Down
<input type="button" value="4"/>	<input type="checkbox"/>		UP	Down
<input type="button" value="5"/>	<input type="checkbox"/>		UP	Down
<input type="button" value="6"/>	<input type="checkbox"/>		UP	Down
<input type="button" value="7"/>	<input type="checkbox"/>		UP	

Next Filter Set

Filter Rule Click a button numbered (1 ~ 7) to edit the filter rule. Click the button will open Edit Filter Rule web page. For the detailed information, refer to the following page.

Active Enable or disable the filter rule.

Comment Enter filter set comments/description. Maximum length is 23-character long.

Move Up/Down Use **Up** or **Down** link to move the order of the filter rules.

Next Filter Set Set the link to the next filter set to be executed after the current filter run. Do not make a loop with many filter sets.

To edit **Filter Rule**, click the **Filter Rule** index button to enter the **Filter Rule** setup page.

Filter Set 1 Rule 1

<input checked="" type="checkbox"/> Check to enable the Filter Rule		
Comments:	Block NetBios	
Index(1-15) in Schedule Setup:	, , ,	
<hr/>		
Direction:	LAN -> WAN	
Source IP:	Any	<input type="button" value="Edit"/>
Destination IP:	Any	<input type="button" value="Edit"/>
Service Type:	TCP/UDP, Port: from 137~139 to any	
Fragments:	Don't Care	
<hr/>		
Application	Action/Profile	Syslog
Filter:	Pass If No Further Match	<input type="checkbox"/>
Branch to Other Filter Set:	None	
Content Security Management:	None	<input type="checkbox"/>
Anti-Virus:	None	<input type="checkbox"/>
Anti-Intrusion:	<input type="checkbox"/> Enable	<input type="checkbox"/>
Anti-Spam:	None	<input type="checkbox"/>

Check to enable the Filter Rule

Check this box to enable the filter rule.

Comments

Enter filter set comments/description. Maximum length is 14-character long.

Index (1-15)

Set PCs on LAN to work at certain time interval only. You may choose up to 4 schedules out of the 15 schedules pre-defined in **Applications >> Schedule** setup. The default setting of this field is blank and the function will always work.

Direction

Set the direction of packet flow (LAN->WAN/WAN->LAN). It is for **Data Filter** only. For the **Call Filter**, this setting is not available since **Call Filter** is only applied to outgoing traffic.

Source/Destination IP

Click **Edit** to access into the following dialog to choose the source/destination IP or IP ranges.

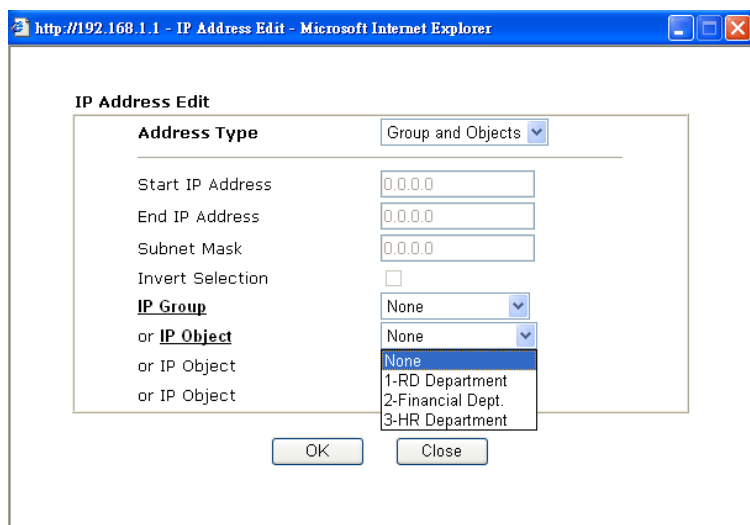

To set the IP address manually, please choose **Any Address/Single Address/Range Address/Subnet Address** as the Address Type and type them in this dialog. In addition, if you want to use the IP range from defined groups or objects, please choose **Group and Objects** as the Address Type.

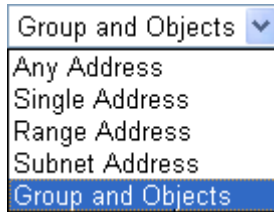

From the **IP Group** drop down list, choose the one that you want to apply. Or use the **IP Object** drop down list to choose the object that you want.

Service Type

Click **Edit** to access into the following dialog to choose a suitable service type.

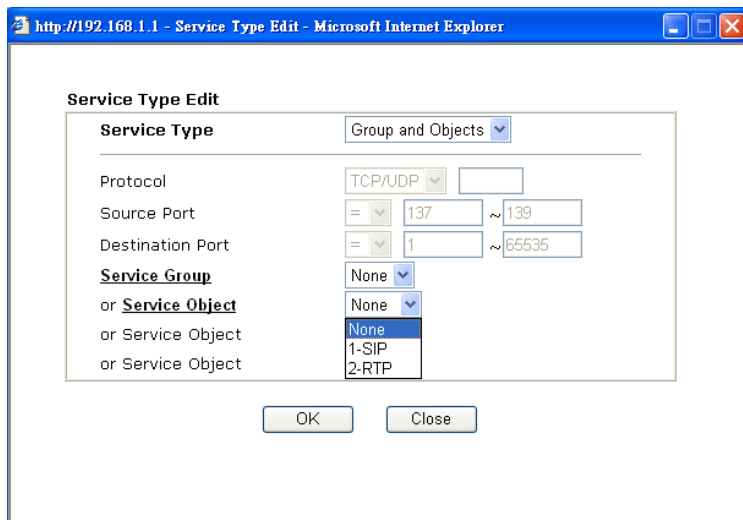

To set the service type manually, please choose **User defined** as the Service Type and type them in this dialog. In addition, if you want to use the service type from defined groups or objects, please choose **Group and Objects** as the Service Type.

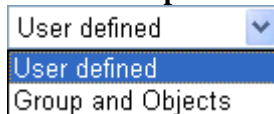

Protocol - Specify the protocol(s) which this filter rule will apply to.
Source/Destination Port -

(=) – when the first and last value are the same, it indicates one port; when the first and last values are different, it indicates a range for the port and available for this service type.

(!=) – when the first and last value are the same, it indicates all the ports except the port defined here; when the first and last values are different, it indicates that all the ports except the range defined here are available for this service type.

(>) – the port number greater than this value is available.

(<) – the port number less than this value is available for this profile.

Service Group/Object - Use the drop down list to choose the one that you want.

Fragments	<p>Specify the action for fragmented packets. And it is used for Data Filter only.</p> <p>Don't care -No action will be taken towards fragmented packets.</p> <p>Unfragmented -Apply the rule to unfragmented packets.</p> <p>Fragmented - Apply the rule to fragmented packets.</p> <p>Too Short - Apply the rule only to packets that are too short to contain a complete header.</p>
Pass or Block	<p>Specifies the action to be taken when packets match the rule.</p> <p>Block Immediately - Packets matching the rule will be dropped immediately.</p> <p>Pass Immediately - Packets matching the rule will be passed immediately.</p> <p>Block If No Further Match - A packet matching the rule, and that does not match further rules, will be dropped.</p> <p>Pass If No Further Match - A packet matching the rule, and that does not match further rules, will be passed through.</p>
Branch to other Filter Set	<p>If the packet matches the filter rule, the next filter rule will branch to the specified filter set. Select next filter rule to branch from the drop-down menu. Be aware that the router will apply the specified filter rule for ever and will not return to previous filter rule any more.</p>
Log	<p>For troubleshooting needs you can specify the filter/CSM/Anti-Virus/Anti-Intrusion/Anti-Spam log here by checking the box. Check this box to record all packets; or uncheck this box to ignore all the packet record. The log will be displayed on Draytek Syslog window.</p>
Content Security Management	<p>All the packets/connections within the range configured in the above conditions must follow the standard configured in the CSM profile selected here. For detailed information, refer to the section of CSM profile setup.</p>
Anti-Virus	<p>Select one of the anti-virus profile settings (created in Anti-Virus>>Profile Setting) for applying with this router. Please set at least one profile for anti-virus in Anti-Virus-> Profile Setting web page first.</p>
Anti-Intrusion	<p>Check the Enable box to invoke anti-intrusion filter function.</p>
Anti-Spam	<p>Select one of the anti-spam profile settings (created in Anti-Spam>>Profile Setting) for applying with this router. Please set at least one profile for anti-spam in Anti-Spam>>Profile Setting web page first.</p>

Example

As stated before, all the traffic will be separated and arbitrated using on of two IP filters: call filter or data filter. You may preset 12 call filters and data filters in **Filter Setup** and even link them in a serial manner. Each filter set is composed by 7 filter rules, which can be further defined. After that, in **General Setup** you may specify one set for call filter and one set for data filter to execute first.

Firewall >> General Setup

General Setup

Call Filter Enable Disable Start Filter Set: Set#1

Data Filter Enable Disable Start Filter Set: Set#2

Actions for default rule:

Application
Filter: Pass
Content Security Management: None
Anti-Virus: None
Anti-Intusion: Enable

Apply IP filter to VPN incoming packets
 Accept large incoming fragmented UDP or ICMP packets

OK Clear

Firewall >> Filter Setup

Filter Setup | Set to Factory Default

Set	Comments	Set	Comments
1.	Default Call Filter	7.	
2.	Default Data Filter	8.	
3.		9.	
4.		10.	
5.		11.	
6.		12.	

Firewall >> Filter Setup >> Edit Filter Set

Filter Set 1
Comments: Default Call Filter

Filter Rule	Active	Comments
1	<input checked="" type="checkbox"/>	Block NetBios
2	<input type="checkbox"/>	
3	<input type="checkbox"/>	
4	<input type="checkbox"/>	
5	<input type="checkbox"/>	
6	<input type="checkbox"/>	
7	<input type="checkbox"/>	

OK Clear Ca

Firewall >> Edit Filter Set >> Edit Filter Rule

Filter Set 1 Rule 1

Check to enable the Filter Rule
Comments: Block NetBios
Index(1-15) in **Schedule** Setup: 1, 3, 5, 7

Direction: LAN -> WAN
Source IP: Any Edit
Destination IP: Any Edit
Service Type: TCP/UDP, Port: from 137-139 to any Edit
Fragments: Don't Care

Application
Filter: Pass if No Further Match
Branch to Other Filter Set: None
Content Security Management: None
Anti-Virus: None
Anti-Intusion: Enable

Syslog

OK Clear Cancel

3.5.4 DoS Defense

As a sub-functionality of IP Filter/Firewall, there are 15 types of detect/defense function in the **DoS Defense** setup. The DoS Defense functionality is disabled for default.

Click **Firewall** and click **DoS Defense** to open the setup page.

DoS defense Setup

Enable DoS Defense

<input type="checkbox"/> Enable SYN flood defense	Threshold	<input type="text" value="50"/>	packets / sec
	Timeout	<input type="text" value="10"/>	sec
<input type="checkbox"/> Enable UDP flood defense	Threshold	<input type="text" value="150"/>	packets / sec
	Timeout	<input type="text" value="10"/>	sec
<input type="checkbox"/> Enable ICMP flood defense	Threshold	<input type="text" value="50"/>	packets / sec
	Timeout	<input type="text" value="10"/>	sec
<input type="checkbox"/> Enable Port Scan detection	Threshold	<input type="text" value="150"/>	packets / sec

Block IP options Block TCP flag scan
 Block Land Block Tear Drop
 Block Smurf Block Ping of Death
 Block trace route Block ICMP fragment
 Block SYN fragment Block UnknownProtocol
 Block Fraggle Attack

OK Clear All Cancel

Enable Dos Defense

Check the box to activate the DoS Defense Functionality.

Enable SYN flood defense

Check the box to activate the SYN flood defense function. Once detecting the Threshold of the TCP SYN packets from the Internet has exceeded the defined value, the Vigor router will start to randomly discard the subsequent TCP SYN packets for a period defined in Timeout. The goal for this is prevent the TCP SYN packets' attempt to exhaust the limited-resource of Vigor router. By default, the threshold and timeout values are set to 50 packets per second and 10 seconds, respectively.

Enable UDP flood defense

Check the box to activate the UDP flood defense function. Once detecting the Threshold of the UDP packets from the Internet has exceeded the defined value, the Vigor router will start to randomly discard the subsequent UDP packets for a period defined in Timeout. The default setting for threshold and timeout are 150 packets per second and 10 seconds, respectively.

Enable ICMP flood defense

Check the box to activate the ICMP flood defense function. Similar to the UDP flood defense function, once if the Threshold of ICMP packets from Internet has exceeded the defined value, the router will discard the ICMP echo requests coming from the Internet. The default setting for threshold and timeout are 50 packets per second and 10 seconds, respectively.

Enable PortScan detection

Port Scan attacks the Vigor router by sending lots of packets to many ports in an attempt to find ignorant services would respond. Check the box to activate the Port Scan detection. Whenever detecting this malicious exploration behavior by monitoring the port-scanning Threshold rate, the Vigor router will send out a warning. By default, the Vigor router sets the threshold as 150

packets per second.

- Block IP options** Check the box to activate the Block IP options function. The Vigor router will ignore any IP packets with IP option field in the datagram header. The reason for limitation is IP option appears to be a vulnerability of the security for the LAN because it will carry significant information, such as security, TCC (closed user group) parameters, a series of Internet addresses, routing messages...etc. An eavesdropper outside might learn the details of your private networks.
- Block Land** Check the box to enforce the Vigor router to defense the Land attacks. The Land attack combines the SYN attack technology with IP spoofing. A Land attack occurs when an attacker sends spoofed SYN packets with the identical source and destination addresses, as well as the port number to victims.
- Block Smurf** Check the box to activate the Block Smurf function. The Vigor router will ignore any broadcasting ICMP echo request.
- Block trace router** Check the box to enforce the Vigor router not to forward any trace route packets.
- Block SYN fragment** Check the box to activate the Block SYN fragment function. The Vigor router will drop any packets having SYN flag and more fragment bit set.
- Block Fraggle Attack** Check the box to activate the Block fraggle Attack function. Any broadcast UDP packets received from the Internet is blocked. Activating the DoS/DDoS defense functionality might block some legal packets. For example, when you activate the fraggle attack defense, all broadcast UDP packets coming from the Internet are blocked. Therefore, the RIP packets from the Internet might be dropped.
- Block TCP flag scan** Check the box to activate the Block TCP flag scan function. Any TCP packet with anomaly flag setting is dropped. Those scanning activities include *no flag scan*, *FIN without ACK scan*, *SYN FINscan*, *Xmas scan* and *full Xmas scan*.
- Block Tear Drop** Check the box to activate the Block Tear Drop function. Many machines may crash when receiving ICMP datagrams (packets) that exceed the maximum length. To avoid this type of attack, the Vigor router is designed to be capable of discarding any fragmented ICMP packets with a length greater than 1024 octets.
- Block Ping of Death** Check the box to activate the Block Ping of Death function. This attack involves the perpetrator sending overlapping packets to the target hosts so that those target hosts will hang once they re-construct the packets. The Vigor routers will block any packets realizing this attacking activity.
- Block ICMP Fragment** Check the box to activate the Block ICMP fragment function. Any ICMP packets with more fragment bit set are dropped.
- Block Unknown Protocol** Check the box to activate the Block Unknown Protocol function. Individual IP packet has a protocol field in the datagram header to indicate the protocol type running over the upper layer. However, the protocol types greater than 100 are reserved and undefined at this time. Therefore, the router should have ability to detect and

reject this kind of packets.

Warning Messages

We provide Syslog function for user to retrieve message from Vigor router. The user, as a Syslog Server, shall receive the report sending from Vigor router which is a Syslog Client.

All the warning messages related to **DoS defense** will be sent to user and user can review it through Syslog daemon. Look for the keyword **DoS** in the message, followed by a name to indicate what kind of attacks is detected.

System Maintenance >> SysLog / Mail Alert Setup

SysLog / Mail Alert Setup

SysLog Access Setup	Mail Alert Setup
<input checked="" type="checkbox"/> Enable	<input checked="" type="checkbox"/> Enable
Server IP Address <input type="text"/>	SMTP Server <input type="text"/>
Destination Port <input type="text" value="514"/>	Mail To <input type="text"/>
Enable syslog message:	Return-Path <input type="text"/>
<input checked="" type="checkbox"/> Firewall Log	<input type="checkbox"/> Authentication
<input checked="" type="checkbox"/> VPN Log	User Name <input type="text"/>
<input checked="" type="checkbox"/> User Access Log	Password <input type="text"/>
<input checked="" type="checkbox"/> Call Log	
<input checked="" type="checkbox"/> WAN Log	
<input checked="" type="checkbox"/> Router/DSL information	

OK Clear Cancel

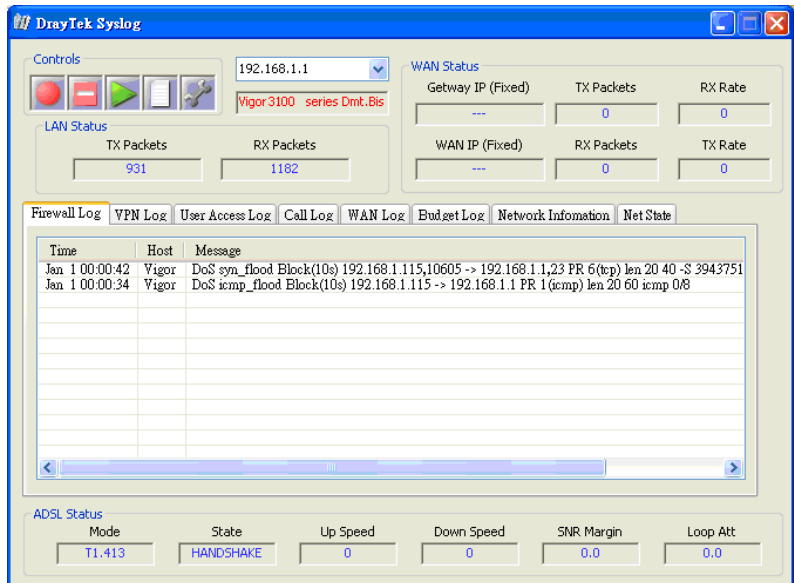

3.5.5 URL Content Filter

Based on the list of user defined keywords, the **URL Content Filter** facility in Vigor router inspects the URL string in every outgoing HTTP request. No matter the URL string is found full or partial matched with a keyword, the Vigor router will block the associated HTTP connection.

For example, if you add key words such as “sex”, Vigor router will limit web access to web sites or web pages such as “www.sex.com”, ”www.backdoor.net/images/sex/p_386.html”. Or you may simply specify the full or partial URL such as “www.sex.com” or “sex.com”.

Also the Vigor router will discard any request that tries to retrieve the malicious code.

Click **Firewall** and click **URL Content Filter** to open the setup page.

Firewall >> URL Content Filter

Content Filter Setup

Enable URL Access Control

Enable URL Access Log

Black List (block those matching keyword)

White List (pass those matching keyword)

No	ACT	Keyword	No	ACT	Keyword
1	<input checked="" type="checkbox"/>	sex	5	<input type="checkbox"/>	
2	<input checked="" type="checkbox"/>	gambling	6	<input type="checkbox"/>	
3	<input type="checkbox"/>		7	<input type="checkbox"/>	
4	<input type="checkbox"/>		8	<input type="checkbox"/>	

Note that multiple keywords are allowed to specify in the blank. For example: **hotmail yahoo msn**

Prevent web access from IP address

Enable Restrict Web Feature

Java ActiveX Compressed files Executable files Multimedia files

Cookie Proxy

Enable Excepting Subnets

No	Act	IP Address		Subnet Mask
1	<input type="checkbox"/>		~	
2	<input type="checkbox"/>		~	
3	<input type="checkbox"/>		~	
4	<input type="checkbox"/>		~	

Time Schedule

Index(1-15) in **Schedule** Setup: , , ,

Note: Action and Idle Timeout settings will be ignored.

Enable URL Access Control Check the box to activate URL Access Control.

Black List (block those matching keyword) Click this button to restrict accessing into the corresponding webpage with the keywords listed on the box below.

White List (pass those matching keyword) Click this button to allow accessing into the corresponding webpage with the keywords listed on the box below.

Keyword The Vigor router provides 8 frames for users to define keywords and each frame supports multiple keywords. The keyword could be

a noun, a partial noun, or a complete URL string. Multiple keywords within a frame are separated by space, comma, or semicolon. In addition, the maximal length of each frame is 32-character long. After specifying keywords, the Vigor router will decline the connection request to the website whose URL string matched to any user-defined keyword. It should be noticed that the more simplified the blocking keyword list, the more efficiently the Vigor router perform.

Prevent web access from IP address

Check the box to deny any web surfing activity using IP address, such as http://202.6.3.2. The reason for this is to prevent someone dodges the URL Access Control.

You must clear your browser cache first so that the URL content filtering facility operates properly on a web page that you visited before.

Enable Restrict Web Feature

Check the box to activate the function.

Java - Check the checkbox to activate the Block Java object function. The Vigor router will discard the Java objects from the Internet.

ActiveX - Check the box to activate the Block ActiveX object function. Any ActiveX object from the Internet will be refused.

Compressed file - Check the box to activate the Block Compressed file function to prevent someone from downloading any compressed file. The following list shows the types of compressed files that can be blocked by the Vigor router. .

zip, rar, .arj, .ace, .cab, .sit

Executable file - Check the box to reject any downloading behavior of the executable file from the Internet.

.exe, .com, .scr, .pif, .bas, .bat, .inf, .reg

Cookie - Check the box to filter out the cookie transmission from inside to outside world to protect the local user's privacy.

Proxy - Check the box to reject any proxy transmission. To control efficiently the limited-bandwidth usage, it will be of great value to provide the blocking mechanism that filters out the multimedia files downloading from web pages. Accordingly, files with the following extensions will be blocked by the Vigor router.

.mov .mp3 .rm .ra .au .wmv

.wav .asf .mpg .mpeg .avi .ram

Enable Excepting Subnets

Four entries are available for users to specify some specific IP addresses or subnets so that they can be free from the *URL Access Control*. To enable an entry, click on the empty checkbox, named as **ACT**, in front of the appropriate entry.

Time Schedule

Specify what time should perform the URL content filtering facility.

3.5.6 Web Content Filter

Click **Firewall** and click **Web Content Filter** to open the setup page.

For this section, please refer to **Web Content Filter** user's guide.

Firewall >> Web Content Filter Setup

CPA(Content Portal Authority) Web Content Filter Setup

Select a CPA server: asia site

[Activate Free Trial and Purchase Subscription](#)

[Check the Validity](#)

[Test a site to verify whether it is categorized](#)

Enable Web Content Filter

Groups

Categories (Tick categories to block. Untick to unblock)

Child Protection <input type="button" value="Select All"/> <input type="button" value="Clear All"/>	<input type="checkbox"/> Chat <input type="checkbox"/> Gambling <input type="checkbox"/> Sex	<input type="checkbox"/> Criminal <input type="checkbox"/> Hacking <input type="checkbox"/> Violence	<input type="checkbox"/> Drugs/Alcohol <input type="checkbox"/> Hate speech <input type="checkbox"/> Weapons
Leisure <input type="button" value="Select All"/> <input type="button" value="Clear All"/>	<input type="checkbox"/> Advertisements <input type="checkbox"/> Games <input type="checkbox"/> Hobbies <input type="checkbox"/> Personals <input type="checkbox"/> Sports	<input type="checkbox"/> Entertainment <input type="checkbox"/> Glamour <input type="checkbox"/> Lifestyle <input type="checkbox"/> Photo Searches <input type="checkbox"/> Streaming Media	<input type="checkbox"/> Food <input type="checkbox"/> Health <input type="checkbox"/> Motor Vehicles <input type="checkbox"/> Shopping <input type="checkbox"/> Travel
Business <input type="button" value="Select All"/> <input type="button" value="Clear All"/>	<input type="checkbox"/> Computing/Internet <input type="checkbox"/> Politics <input type="checkbox"/> Remote proxies	<input type="checkbox"/> Finance <input type="checkbox"/> Real Estate <input type="checkbox"/> Search Engine	<input type="checkbox"/> Job Search/Career <input type="checkbox"/> Reference <input type="checkbox"/> Web Mail
Others <input type="button" value="Select All"/> <input type="button" value="Clear All"/>	<input type="checkbox"/> Education <input type="checkbox"/> News <input type="checkbox"/> Usenet news	<input type="checkbox"/> Hosting sites <input type="checkbox"/> Religion <input type="checkbox"/> Block all uncategorised sites	<input type="checkbox"/> Kid Sites <input type="checkbox"/> Sex Education

Time Schedule

Index(1-15) in **Schedule** Setup: , , ,

Note: Action and Idle Timeout settings will be ignored.

OK

Cancel

3.6 Anti-Intrusion

This page allows you to prevent the intrusion from hackers while accessing into Internet. It can detect the intrusion and execute basic defense.

There are more than 200 basic rules for anti-intrusion and anti-virus for this router. To acquire more rules for anti-intrusion, it is suggested for you to register your router by entering www.vigorpro.com. When you finished the registration, you can get and activate a wide range of anti-intrusion rules from the website. In addition, you will be allowed to download/update new rules (if they are released) from the websites lately (during the valid time of the license key you purchased) after completing the registration.

You are allowed to use trial version with anti-intrusion and anti-virus features for 30 days after you register for the router. And you will be noticed with an e-mail while it is going to expire.

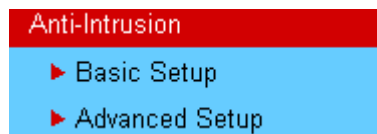

3.6.1 Basic Setup

Basic Setup page lets you to enable the anti-intrusion service and choose the suitable level for the detection.

Anti-Intrusion >> Basic Setup

Anti-Intrusion Control Setup [Signature Version : **basic**]

<input checked="" type="checkbox"/> Enable Anti-Intrusion Service: Intrusion detection of the hacker is made effective
Sensitiveness of intrusion detection:
<input checked="" type="radio"/> High Security: Matching all rules
<input type="radio"/> Medium Security: Matching high and medium severity rules
<input type="radio"/> Low Security: Matching high severity rules
Action's "default" processing at time of intrusion detection:
<input checked="" type="radio"/> Enable Pass processing
<input type="radio"/> Enable Disallow processing
<input type="radio"/> Enable Reset processing

Note : If you want to email alert or syslog, please setup on the [SysLog/Mail Alert Setup](#) page. If you need more information, please enter [Advanced Setup](#)

OK Cancel

Anti-Intrusion Control Setup

This field will display the signature version of this router. The default signature version is “**basic**”. In this version, you can modify the settings for Anti-Intrusion rules in **Anti-Intrusion >>Advanced Setup** page. However, if you restart/reset the router, all the modified configurations for the rules will not be available and return to the default settings. Except “**basic**”, the modified configurations for other signature versions are available all the time after you saved them in **Anti-Intrusion >>Advanced Setup** page.

Enable Anti-Intrusion Service

Check this box to enable the anti-intrusion function.

- High Security** Click this radio button to activate the anti-intrusion service with overall detecting conditions. That is, the router will detect and block the incoming/outgoing packets which match all the severity rules, including high, medium and low. The degree of severity for each rule is defined in Advance Setup.
- Medium Security** Click this radio button to activate the anti-intrusion service with medium detecting conditions. That is, the router will detect and block the incoming/outgoing packets which match the highest and medium severity rules. The degree of severity for each rule is defined in Advance Setup.
- Low Security** Click this radio button to activate the anti-intrusion service with minimum detecting conditions. That is, the router will detect and block the incoming/outgoing packets which match the highest severity rules. The degree of severity for each rule is defined in **Advanced Setup**.
- Enable Pass processing** Click this radio button to detect if there is any intrusion occurrence for your reference. The system will not do any advanced action for such condition.
- Enable Disallow processing** Click this radio button to block the incoming/outgoing packets with possible intrusion actions transmitting through the router.
- Enable Reset procession** Click this radio button to break down the communication between your computer and specific link which might have intrusion actions.

3.6.2 Advanced Setup

This page lists all the available types and allows you to adjust the rule setting for each type. The rules will be applied by the options chosen in the page of **Basic Setup** for Anti-Intrusion.

Anti-Intrusion >> Advanced Setup

Anti-Intrusion Type Setup		SID/NAME:	<input type="text"/>	<input type="button" value="Search"/>
BO (2)	Web-CGI (3)			
DDoS/DoS (4)	Web-Client (1)			
Exploit (47)	Web-IIS (6)			
ICMP (12)	Web-Misc (0)			
I-Worm (16)	Web-PHP (0)			
IRC (0)	Latest (0)			
Malware (41)				
Misc (3)				
RPC (5)				
Scan (5)				
SQL-Inject (0)				
Tunnel (0)				

SID/Name To find the specific type of anti-intrusion, you can type its SID number or name in this field if you know, and then click **Search**. The system will locate that type for you.

Search It can help the user to find out specific anti-intrusion rule quickly.

Type links

Click any anti-intrusion type link to access into next page for configuring the rules settings. Here we provide several rules for each type. The factory types and rules for anti-intrusion are shown in this page. If you want to acquire more types and rules, please go to www.vigorpro.com and finish the registration work. Later, the wide range of anti-intrusion types will be added into this page.

After you click any one of type links, you can access into the rules setup page for activating rules. We take the type of BO as an example. Below is the rules setup page for BO type.

For the detailed information about the full name, meaning of each rule and/or type, you can click the name link list on the Anti-Intrusion Rules Setup page to connect VigorPro webpage for viewing.

Anti-Intrusion >> Advanced Setup

Anti-Intrusion Rules Setup Page: 1 / 1

Enable	Name	SID	Severity	Log	Action			
					Pass	Disallow	Reset	Default
<input checked="" type="checkbox"/>	Format String %n%n%n%n	1336	M	<input checked="" type="checkbox"/>	<input type="radio"/>	<input type="radio"/>	<input type="radio"/>	<input checked="" type="radio"/>
<input checked="" type="checkbox"/>	SHELLCODE MIPS Ultrix NOOP	1467	L	<input checked="" type="checkbox"/>	<input type="radio"/>	<input type="radio"/>	<input type="radio"/>	<input checked="" type="radio"/>
<input type="checkbox"/>		0		<input type="checkbox"/>	<input type="radio"/>	<input type="radio"/>	<input type="radio"/>	<input type="radio"/>
<input type="checkbox"/>		0		<input type="checkbox"/>	<input type="radio"/>	<input type="radio"/>	<input type="radio"/>	<input type="radio"/>
<input type="checkbox"/>		0		<input type="checkbox"/>	<input type="radio"/>	<input type="radio"/>	<input type="radio"/>	<input type="radio"/>
<input type="checkbox"/>		0		<input type="checkbox"/>	<input type="radio"/>	<input type="radio"/>	<input type="radio"/>	<input type="radio"/>
<input type="checkbox"/>		0		<input type="checkbox"/>	<input type="radio"/>	<input type="radio"/>	<input type="radio"/>	<input type="radio"/>
<input type="checkbox"/>		0		<input type="checkbox"/>	<input type="radio"/>	<input type="radio"/>	<input type="radio"/>	<input type="radio"/>
<input type="checkbox"/>		0		<input type="checkbox"/>	<input type="radio"/>	<input type="radio"/>	<input type="radio"/>	<input type="radio"/>
<input type="checkbox"/>		0		<input type="checkbox"/>	<input type="radio"/>	<input type="radio"/>	<input type="radio"/>	<input type="radio"/>

Enable

Check to enable this rule. If you uncheck this box, the corresponding settings for the rule will not be executed.

SID

The number for each anti-intrusion rule is displayed in this field.

Name

A brief description name for the anti-intrusion rule is shown in this field. Click the name link to access into VigorPro website for checking the detailed information for the specified anti-intrusion.

Severity

It means the degree of the influence for this type to the computer, machine, network and environment.

H: representing that this type will cause severest affection which must crash/destroy your computer.

M: representing that this type will cause severer affection which might crash your computer.

L: representing that this type will cause small affection which might not crash your computer.

Log

In order to show the detection log with such rule on the window of Draytek Syslog, you have to check the log box here and enable the **SysLog Access Setup** from **System Maintenance >> Syslog/Mail Alert**.

Action

Pass - Click this radio button to detect if there is any intrusion occurrence for your reference. The system will not do any advanced action for such condition.

Disallow - Click this radio button to block the incoming/outgoing packets with possible intrusion actions transmitting through the router.

Reset - Click this radio button to break down the communication between your computer and specific link which might have intrusion actions.

Default - Click this radio button to execute the anti-intrusion detection according to the setting that you set in Basic Setup.

Page

Type the page number in this field (if there is more than one page of anti-virus detail view displayed on this page). Then click **Go** to the specified page. Or you can click **/>**, **>>**, **<<** or **>/** button on the right side of the **Go** button to access to the home/previous/next/end page.

3.7 Anti-Virus

Vigor router can offer basic virus scanning, destroying and cut off the connection between questionable link and your computer for the files transmitted through specified protocol. In addition, several types of compressed file formats such as .zip, .gzip, .bzip2 are supported and can be scanned with this router. There is no limitation in the file size for the transmitted (incoming or outgoing) file. With this feature, all the files processed with the protocol specified in Anti-Virus web page will be scanned for finding out virus while passing through the router.

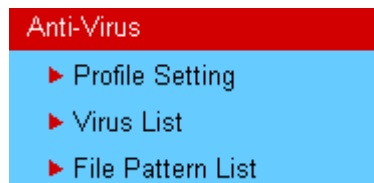

Note: Files with six-layer compression (the files are compressed with six times) also can be scanned by this router.

3.7.1 Profile Setting

This page allows you to set eight profiles for anti-virus scanning. These profiles can be invoked through firewall configuration. It is recommended to build one profile at least. Thus you will have selectable anti-virus profile setting in **Firewall->General Setup**.

Anti-Virus >> Profile Setting

Anti-Virus Profile Table [Signature Version: **basic**] | [Set to Factory Default](#) |

Profile	Name	Profile	Name
1.		5.	
2.		6.	
3.		7.	
4.		8.	

Administration Message (Max 255 characters)

This e-mail has been scanned by DrayTek VigorPro UTM products. No virus was effected.
If you need more support, please contact support@draytek.com

Note: If you want to email alert or syslog, please setup on the [SysLog/Mail Alert Setup](#) page. For more information, please visit the [Virus List](#) page.

OK

The Administration Message box allows you to fill in important notification directly for SMTP and POP3 protocols. It will be saved as a file. While receiving an e-mail, the user will receive an attached file with the content listed in this box.

To edit a profile setting, please click the number link under Profile. You can see the following screen. You can check the boxes listed below for different operation respectively. If you uncheck this box, the corresponding settings for the protocol will not be performed.

Profile Index : 1 Profile Name:

Operation/Protocol	SMTP	POP3	IMAP	HTTP	FTP
Action	Pass ▾	Pass ▾	Pass ▾	Pass ▾	Pass ▾
Enable Virus Scan	<input type="checkbox"/>	<input type="checkbox"/>	<input type="checkbox"/>	<input type="checkbox"/>	<input type="checkbox"/>
Enable Log	<input checked="" type="checkbox"/>	<input checked="" type="checkbox"/>	<input checked="" type="checkbox"/>	<input checked="" type="checkbox"/>	<input checked="" type="checkbox"/>
Detect Macro Attachment	<input type="checkbox"/>	<input type="checkbox"/>	<input type="checkbox"/>	<input type="checkbox"/>	<input type="checkbox"/>
Detect Encrypted Zipped Files	<input type="checkbox"/>	<input type="checkbox"/>	<input type="checkbox"/>	<input type="checkbox"/>	<input type="checkbox"/>
Detect Suspicious Compression	<input type="checkbox"/>	<input type="checkbox"/>	<input type="checkbox"/>	<input type="checkbox"/>	<input type="checkbox"/>
Append Message	<input type="checkbox"/>	<input type="checkbox"/>			
File Filter					
Block Fragmented Mail	<input type="checkbox"/>	<input type="checkbox"/>	<input type="checkbox"/>		
Block Multiple Sessions Download				<input type="checkbox"/>	

OK Cancel

Profile Name

Type a name for the profile.

Protocol

Currently, only the files transmitted through the protocols listed in this page including **SMTP**, **POP3**, **IMAP**, **HTTP** and **FTP** will be scanned by this router.

Action

Choose the action that you want to apply to the protocols of each operation.

Action	Pass ▾
	Pass Destroy Reset

Pass - Detect if there is any virus for your reference. The system will not do any advanced action for such condition.
Destroy- Destroy the infected file found by the router system.
Reset - Break down the communication between your computer and specific link which might have virus included.

Enable Virus Scan

Check this box to enable the general virus scan procedure for different protocols.

Enable Log

In order to show the virus detection log on the window of Draytek Syslog, you have to check the log box here and enable the **SysLog Access Setup** from **System Maintenance >> Syslog/Mail Alert**.

SysLog / Mail Alert Setup

SysLog Access Setup

Enable

Server IP Address

Destination Port

Enable syslog message:

- Firewall Log
- VPN Log
- User Access Log
- Call Log
- WAN Log
- Router/DSL information

Detect Macro Attachment	The file with macro attachment will be passed/destroyed/reset under different protocols. The system will detect it automatically if you set corresponding configuration here.
Detect Encrypted Zipped Files	The file zipped with encryption will be detected and then be passed/destroyed/reset according to the configuration set here.
Detect Suspicious Compression	The file with suspicious or non-support compression format will be detected and then be passed/destroyed/reset according to the configuration set here.
Append Message	This function is available for SMTP and POP3 protocols. If you check it, the message typed under the box of Administration Message will be sent out with e-mail.
File Filter	Click this link to open Anti-Virus >>File Pattern List for viewing current settings.
Block Fragmented Mail	The file with fragmentations will be passed/destroyed/reset under different protocols. The router cannot execute the scanning job for some mail fragmentation if you check the boxes here.
Block Multiple Sessions Download	The file with multiple sessions which are created by HTTP will be detected and then be passed/destroyed/reset according to the configuration set here.

3.7.2 Virus List

This page displays the virus list ordered by digits (0-9) and letters (A-Z). Each number after the letter link indicates the total types of the virus collected.

Anti-Virus >> Virus List

Anti-Virus List Overview

SID/NAME:

0 - 9 (0)	M - N (31)
A - B (16)	O - P (2)
C - D (1)	Q - R (2)
E - F (1)	S - T (21)
G - H (0)	U - V (0)
I - J (2)	W - X (0)
K - L (4)	Y - Z (1)

SID/NAME

To find the specific type of anti-virus, you can type its SID number or name in this field if you know, and then click **Search**. The system will locate that rule for you.

Search

Click this button to find out all the virus rules related to the SID/NAME that you entered. The page of the searching result will be shown as the following picture.

Anti-Virus Search Result



Name	SID
Bagle.AC	21593
Bagle.AF	22361
Bagle.AG	22417
Bagle.BL	34196
Bagle.BY-2	35493
Bagle.BZ-1	35496
Bagle.BZ-2	35497
Bagle.CB	35682
Bagle.CD-1	35686
Bagle.CD-2	35687

Click each name link to check the detailed information of the anti-virus rule.

Detailed View for Anti-Virus

From the fourteen types of anti-virus list, click any one of them to access into next page. The detailed view list for anti-virus rule will be shown as below.

Anti-Virus Detail View

Page: 1 / 1 

NAME	SID	NAME	SID
Bagle.AC	21593	Bagle.Gen-9	35683
Bagle.AF	22361	Bagle.Z	21339
Bagle.AG	22417	Blaster.A	18056
Bagle.BL	34196	BugBear.B	18078
Bagle.BY-2	35493		0
Bagle.BZ-1	35496		0
Bagle.BZ-2	35497		0
Bagle.CB	35682		0
Bagle.CD-1	35686		0
Bagle.CD-2	35687		0
Bagle.Gen-2	22985		0
Bagle.Gen-7	35505		0

NAME

A brief description name for the anti-virus rule is shown in this field. Click the name link to access into VigorPro website for checking the detailed information for the specified anti-virus.

SID

The number for each anti-virus rule is displayed in this field.

Page

Type the page number in this field (if there is more than one page of anti-virus detail view displayed on this page). Then click **Go** to the specified page. Or you can click **/>**, **>>**, **<<** or **</** button on the right side of the Go button to access to the home/previous/next/end page.

3.7.3 File Pattern List

To avoid confidential file being leaked out by someone else through network and cause severe consequence, you can specify the file name in this page and determine to destroy or scan or pass it while the file passes through the router.

To activate the File Patter List, you have to set one Anti-Virus profile on **Anti-Virus>>Profile Setting**. Also you can specify file names without virus appended to be ignored by anti-virus server to improve the performance.

File Filter	<input checked="" type="checkbox"/>	<input checked="" type="checkbox"/>	<input checked="" type="checkbox"/>	<input checked="" type="checkbox"/>	<input checked="" type="checkbox"/>
Block Fragmented Mail	<input type="checkbox"/>	<input type="checkbox"/>	<input type="checkbox"/>		
Block Multiple Sessions Download				<input type="checkbox"/>	

This page allows you to set 32 entries (rules) of file names to be filtered by the router. In such case, the file format is ignored. The router will destroy, scan or non-scan the specified filename according to the configuration that you set here.

Below is the page of **File Pattern List**. The priority of each entry is determined by the index number. That is, the entry of Index 1 has the highest priority in file name filtering; the entry of Index 32 has the lowest priority in filtering.

Anti-Virus >> File Pattern List

File Pattern List:
Default Action: | [Set to Factory Default](#)

Index	Action	Name	Move Up	Move Down
1.	<input type="button" value="Scan"/>	<input type="text"/>		Down
2.	<input type="button" value="Scan"/>	<input type="text"/>	UP	Down
3.	<input type="button" value="Scan"/>	<input type="text"/>	UP	Down
4.	<input type="button" value="Scan"/>	<input type="text"/>	UP	Down
5.	<input type="button" value="Scan"/>	<input type="text"/>	UP	Down
6.	<input type="button" value="Scan"/>	<input type="text"/>	UP	Down
7.	<input type="button" value="Scan"/>	<input type="text"/>	UP	Down
8.	<input type="button" value="Scan"/>	<input type="text"/>	UP	Down

Destroy the file if the file name is over length (Max 76 characters).
 Enable Default Action's SysLog / Mail Alert.

<< [1-8](#) | [9-16](#) | [17-24](#) | [25-32](#) >> [Next](#) >>

Default Action

Choose one of the actions (Scan, Non-Scan, Destroy) as the default action if the filename for one file does not meet the conditions configured in these thirty-two entries.

Action

Choose the action that you want to apply to the protocols of each operation.

Destroy- Destroy the file with name specified here which is found by the router system.

Non-Scan –The file will not be scanned and will not be processed by using general rules set in Anti-Virus profile.

Scan – Just scan the file with name specified here which is found by the router system, and be processed by using general rules set in Anti-Virus profile.

Name

Enter the keyword of the file that you want to filter. The maximum character is 30. And the name is case-sensitive.

Move Up/Down

Press **OK** to ensure the name you typed and then use **Up** or **Down** link to move the order of the file pattern entry.

Destroy the file if the file name is over length

Check this box to destroy the file with filename over 76 characters.

Enable Syslog/Mail Alert

Check this box to have Syslog/Mail Alert list the information

for Default Action for default action.

Click **OK** to finish the page configuration.

3.8 Anti-Spam

Many people suffer with unwanted mails coming from everywhere. Such device offers a mechanism, named Anti-Spam, to do basic scanning for filtering unnecessary mails and sorting the mails.

Below shows the menu items for Anti-Spam.



To activate function of Anti-Spam, you **have to configure profile(s) for your computer first**. Please open **Profile Setting** from **Anti-Spam** menu to access into the following page. There are sixteen profiles provided by this system for you to define.

Anti-Spam >> Profile Setting

Anti-Spam Profile Table		Set to Factory Default	
Profile	Name	Profile	Name
1.		9.	
2.		10.	
3.		11.	
4.		12.	
5.		13.	
6.		14.	
7.		15.	
8.		16.	

License [Status :Not Activated]

Service Activation	Activate
---------------------------	--------------------------

Anti-Spam Authentication Message

```
Authenticate fail, 2000-01-01 00:01:23
```

Note: If you want to use email alert or syslog, please configure the [SysLog/Mail Alert Setup](#) page.

Profile (1 ~16)

There are sixteen profiles provided for you to define. Simply click the number link under Profile, the setting page for that number will be open for you to configure.

Name

List the name for the profile setting.

Service Activation

The **Activate** link can guide user into www.vigorpro.com for creating account or register router for Anti-Spam. Meanwhile, it is used to activate Anti-Spam service.

Anti-Spam Authentication Message

As for authentication information of Anti-Spam, the process of authenticating will be displayed on this field for your reference.

3.8.1 Profile Setting

Simply click number under Profile item. The detailed page will be shown right away. The following graphic is the web page for the profile marked with number 1.

Profile Index : 1 Profile Name:

Choose Protocol to Scan Spam

SMTP POP3

Select an Action for Each Category

Category	Action	Log	Message(Max 30 characters)
Spam	Pass ▼	<input type="checkbox"/>	<input type="text"/>
Bulk	Pass ▼	<input type="checkbox"/>	<input type="text"/>

Select Specific Operation

Log All Mail Events

Choose Action for System Timeout or Network Problem

Action	Log	Message(Max 30 characters)
System Fail	Pass ▼	<input type="text"/>

Profile Name

Type a name for such profile setting.

Choose Protocol to Scan Spam

Spam files usually come with protocol of SMTP or POP3. Please check the box that you want to avoid. It would be better to check both protocols.

Select an Action for Each Category

Mails would be judged and categorized into Spam or Bulk. For the one that is confirmed as spam will be processed with the rule of **Spam**; and the one that is probably spam will be processed with the rule of **Bulk**. Please set different process action for Spam and Bulk respectively.

Pass - Choose this action to make all mails passing through.

Tag - Choose this action to make all mails be tagged with certain words for you to identify easily. For example, type "SPAM" on the box of **Message**. If the subject of some mail is "license page" and it is judged as spam, then it will be shown as "****SPAM***license page" in your mail box. Such tag can help users to identify which mail is useful or useless quickly.

Action

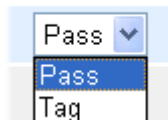

Select Specific Operation

Check the box of Log All Mail Events. All the events about the mails will be recorded on Syslog.

Choose Action for System Timeout or Network Problem

When the system fails due to system timeout or network problem, you can specify specific action (Pass or Tag) for the system to execute immediately.

Pass - Choose this action to make all mails passing through.

Tag - Choose this action to make all mails be tagged with certain words for you to identify easily. For example, type “timeout” on the box of **Message**. Then all the mails sending to your e-mail box at system timeout will be marked with “***timeout***” before the subjects of the mails. Later, these mails can be identified easily and categorized manually.

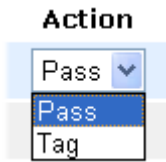

- Log** Check the box to have the process record stated on Syslog.
- Message** Type words which will be placed before the subject of mail and help you to identify.
- Clear** Delete the settings configured above and reset to default settings.
- Cancel** Delete the settings configured above and return to previous page.

Click **OK** to finish the page configuration.

3.8.2 Activating Anti-Spam

After you have finished the profile settings, it is the time to activate the mechanism for your computer. Click the **Activate** link on the following page to access www.vigorpro.com.

Anti-Spam >> Profile Setting

Anti-Spam Profile Table		Set to Factory Default	
Profile	Name	Profile	Name
<u>1.</u>		<u>9.</u>	
<u>2.</u>		<u>10.</u>	
<u>3.</u>		<u>11.</u>	
<u>4.</u>		<u>12.</u>	
<u>5.</u>		<u>13.</u>	
<u>6.</u>		<u>14.</u>	
<u>7.</u>		<u>15.</u>	
<u>8.</u>		<u>16.</u>	

License [Status :Not Activated]

Service Activation	Activate
---------------------------	--------------------------

Anti-Spam Authentication Message

Authenticate fail, 2000-01-01 00:01:23

Note: If you want to use email alert or syslog, please configure the [SysLog/Mail Alert Setup](#) page.

3.9 Bandwidth Management

Below shows the menu items for Bandwidth Management.



3.9.1 Sessions Limit

A PC with private IP address can access to the Internet via NAT router. The router will generate the records of NAT sessions for such connection. The P2P (Peer to Peer) applications (e.g., BitTorrent) always need many sessions for procession and also they will occupy over resources which might result in important accesses impacted. To solve the problem, you can use limit session to limit the session procession for specified Hosts.

In the **Bandwidth Management** menu, click **Sessions Limit** to open the web page.

Bandwidth Management >> Sessions Limit

Sessions Limit

Enable
 Disable

Default Max Sessions:

Limitation List

Index	Start IP	End IP	Max Sessions

Specific Limitation

Start IP: End IP:

Maximum Sessions:

Time Schedule

Index(1-15) in **Schedule** Setup: , , ,

Note: Action and Idle Timeout settings will be ignored.

To activate the function of limit session, simply click **Enable** and set the default session limit.

Enable Click this button to activate the function of limit session.

Disable Click this button to close the function of limit session.

Default session limit Defines the default session number used for each computer in LAN.

Limitation List Displays a list of specific limitations that you set on this web page.

Start IP Defines the start IP address for limit session.

End IP Defines the end IP address for limit session.

Maximum Number Defines the available session number for each host in the specific range of IP addresses. If you do not set the session number in this field, the system will use the default session limit for the specific limitation you set for each index.

- Add** Adds the specific session limitation onto the list above.
- Edit** Allows you to edit the settings for the selected limitation.
- Delete** Delete the selected settings existing on the limitation list.
- Index (1-15) in Schedule Setup** You can type in four sets of time schedule for your request. All the schedules can be set previously in **Application – Schedule** web page and you can use the number that you have set in that web page.

3.9.2 Bandwidth Limit

The downstream or upstream from FTP, HTTP or some P2P applications will occupy large of bandwidth and affect the applications for other programs. Please use Limit Bandwidth to make the bandwidth usage more efficient.

In the **Bandwidth Management** menu, click **Bandwidth Limit** to open the web page.

Bandwidth Management >> Bandwidth Limit

Bandwidth Limit

Enable
 Disable

Default TX Limit: Kbps
 Default RX Limit: Kbps

Limitation List

Index	Start IP	End IP	TX limit	RX limit

Specific Limitation

Start IP:
 End IP:

TX Limit: Kbps
 RX Limit: Kbps

Time Schedule

Index(1-15) in **Schedule** Setup: , , ,

Note: Action and Idle Timeout settings will be ignored.

To activate the function of limit bandwidth, simply click **Enable** and set the default upstream and downstream limit.

- Enable** Click this button to activate the function of limit bandwidth.
- Disable** Click this button to close the function of limit bandwidth.
- Default TX limit** Define the default speed of the upstream for each computer in LAN.
- Default RX limit** Define the default speed of the downstream for each computer in LAN.
- Limitation List** Display a list of specific limitations that you set on this web page.
- Start IP** Define the start IP address for limit bandwidth.
- End IP** Define the end IP address for limit bandwidth.

TX limit	Define the limitation for the speed of the upstream. If you do not set the limit in this field, the system will use the default speed for the specific limitation you set for each index.
RX limit	Define the limitation for the speed of the downstream. If you do not set the limit in this field, the system will use the default speed for the specific limitation you set for each index.
Add	Add the specific speed limitation onto the list above.
Edit	Allows you to edit the settings for the selected limitation.
Delete	Delete the selected settings existing on the limitation list.
Index (1-15) in Schedule Setup	You can type in four sets of time schedule for your request. All the schedules can be set previously in Application – Schedule web page and you can use the number that you have set in that web page.

3.9.3 Quality of Service

Deploying QoS (Quality of Service) management to guarantee that all applications receive the service levels required and sufficient bandwidth to meet performance expectations is indeed one important aspect of modern enterprise network.

One reason for QoS is that numerous TCP-based applications tend to continually increase their transmission rate and consume all available bandwidth, which is called TCP slow start. If other applications are not protected by QoS, it will detract much from their performance in the overcrowded network. This is especially essential to those are low tolerant of loss, delay or jitter (delay variation).

Another reason is due to congestions at network intersections where speeds of interconnected circuits mismatch or traffic aggregates, packets will queue up and traffic can be throttled back to a lower speed. If there's no defined priority to specify which packets should be discarded (or in another term "dropped") from an overflowing queue, packets of sensitive applications mentioned above might be the ones to drop off. How this will affect application performance?

There are two components within Primary configuration of QoS deployment:

- **Classification:** Identifying low-latency or crucial applications and marking them for high-priority service level enforcement throughout the network.
- **Scheduling:** Based on classification of service level to assign packets to queues and associated service types

The basic QoS implementation in Vigor routers is to classify and schedule packets based on the service type information in the IP header. For instance, to ensure the connection with the headquarter, a teleworker may enforce an index of QoS Control to reserve bandwidth for HTTPS connection while using lots of application at the same time.

One more larger-scale implementation of QoS network is to apply DSCP (Differentiated Service Code Point) and IP Precedence disciplines at Layer 3. Compared with legacy IP Precedence that uses Type of Service (ToS) field in the IP header to define 8 service classes, DSCP is a successor creating 64 classes possible with backward IP Precedence compatibility. In a QoS-enabled network, or Differentiated Service (DiffServ or DS) framework, a DS domain owner should sign a Service License Agreement (SLA) with other DS domain owners to define the service level provided toward traffic from different domains. Then each DS node in these domains will perform the priority treatment. This is called per-hop-behavior (PHB). The definition of PHB includes Expedited Forwarding (EF),

Assured Forwarding (AF), and Best Effort (BE). AF defines the four classes of delivery (or forwarding) classes and three levels of drop precedence in each class.

Vigor routers as edge routers of DS domain shall check the marked DSCP value in the IP header of bypassing traffic, thus to allocate certain amount of resource execute appropriate policing, classification or scheduling. The core routers in the backbone will do the same checking before executing treatments in order to ensure service-level consistency throughout the whole QoS-enabled network.

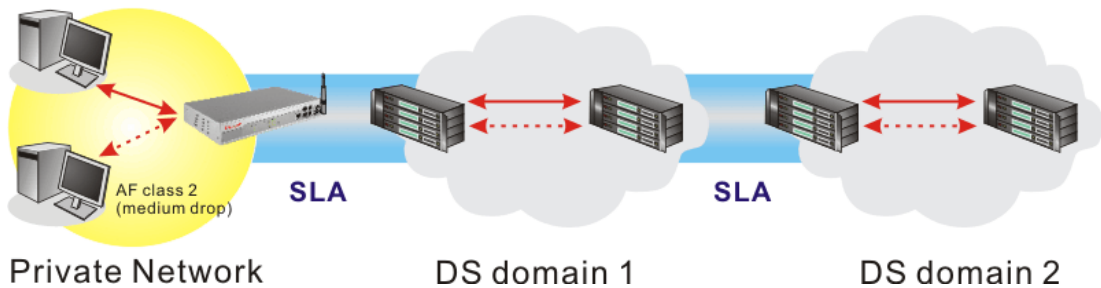

However, each node may take different attitude toward packets with high priority marking since it may bind with the business deal of SLA among different DS domain owners. It's not easy to achieve deterministic and consistent high-priority QoS traffic throughout the whole network with merely Vigor router's effort.

In the **Bandwidth Management** menu, click **Quality of Service** to open the web page.

Bandwidth Management >> Quality of Service

General Setup

Index	Status	Bandwidth	Directon	Class 1	Class 2	Class 3	Others	UDP Bandwidth Control	
WAN1	Disable	10000Kbps/10000Kbps		25%	25%	25%	25%	Inactive	Setup
WAN2	Disable	10000Kbps/10000Kbps		25%	25%	25%	25%	Inactive	Setup

Class Rule

Index	Name	Rule	Service Type
Class 1		Edit	Edit
Class 2		Edit	
Class 3		Edit	

This page displays the QoS settings result of the WAN interface. Click the **Setup** link to access into next page for the general setup of WAN (1/2) interface. As to class rule, simply click the **Edit** link to access into next for configuration.

You can configure general setup for the WAN interface, edit the Class Rule, and edit the Service Type for the Class Rule for your request.

General Setup for WAN Interface

When you click **Setup**, you can configure the bandwidth ratio for QoS of the WAN interface. There are four queues allowed for QoS control. The first three (Class 1 to Class 3) class rules can be adjusted for your necessity. Yet, the last one is reserved for the packets which are not suitable for the user-defined class rules.

WAN1 General Setup

Enable the QoS Control OUT ▼

WAN Inbound Bandwidth 10000 Kbps

WAN Outbound Bandwidth 10000 Kbps

Index	Class Name	Reserved_bandwidth Ratio
Class 1		25 %
Class 2		25 %
Class 3		25 %
	Others	25 %

Enable UDP Bandwidth Control Limited_bandwidth Ratio 25 %

Outbound TCP ACK Prioritize

OK
Clear
Cancel

Enable the QoS Control

The factory default for this setting is checked. Please also define which traffic the QoS Control settings will apply to.
IN- apply to incoming traffic only.
OUT- apply to outgoing traffic only.
BOTH- apply to both incoming and outgoing traffic.
 Check this box and click **OK**, then click **Setup** link again. You will see the **Online Statistics** link appearing on this page.

WAN Inbound Bandwidth

It allows you to set the connecting rate of data input for WAN. For example, if your ADSL supports 1M of downstream and 256K upstream, please set 10000kbps for this box. The default value is 10000kbps.

WAN Outbound Bandwidth

It allows you to set the connecting rate of data output for WAN. For example, if your ADSL supports 1M of downstream and 256K upstream, please set 256kbps for this box. The default value is 10000kbps.

Reserved Bandwidth Ratio

It is reserved for the group index in the form of ratio of **reserved bandwidth to upstream speed** and **reserved bandwidth to downstream speed**.

Enable UDP Bandwidth Control

Check this and set the limited bandwidth ratio on the right field. This is a protection of TCP application traffic since UDP application traffic such as streaming video will exhaust lots of bandwidth.

Outbound TCP ACK Prioritize

Check to enable this function.

Limited_bandwidth Ratio

The ratio typed here is reserved for limited bandwidth of UDP application.

Online Statistics

Display an online statistics for quality of service for your reference. This link will be seen only if you click **OK** in WAN1/WAN2 General Setup web page and click Setup again (for WAN1/WAN2) on the **Bandwith**

Management >> Quality of Service

Bandwidth Management >> Quality of Service

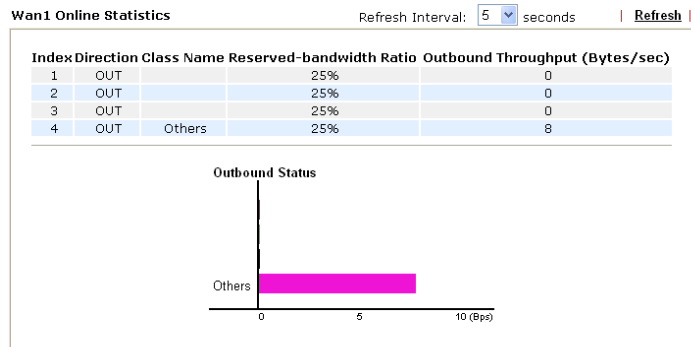

Edit the Class Rule for QoS

The first three (Class 1 to Class 3) class rules can be adjusted for your necessity. To add, edit or delete the class rule, please click the **Edit** link of that one.

Bandwidth Management >> Quality of Service

General Setup

Index	Status	Bandwidth	Directon	Class 1	Class 2	Class 3	Others	UDP Bandwidth Control	
WAN1	Disable	10000Kbps/10000Kbps		25%	25%	25%	25%	Inactive	Setup
WAN2	Disable	10000Kbps/10000Kbps		25%	25%	25%	25%	Inactive	Setup

Class Rule

Index	Name	Rule	Service Type
Class 1		Edit	Edit
Class 2		Edit	
Class 3		Edit	

After you click the **Edit** link, you will see the following page. Now you can define the name for that Class. In this case, "Test" is used as the name of Class Index #1.

Bandwidth Management >> Quality of Service

Class Index #1

Name

NO	Status	Local Address	Remote Address	DiffServ CodePoint	Service Type
1	Empty	-	-	-	-

For adding a new rule, click **Add** to open the following page.

Bandwidth Management >> Quality of Service

Rule Edit

ACT

Local Address

Remote Address

DiffServ CodePoint

Service Type

Note: Please choose/setup the **Service Type** first.

ACT

Check this box to invoke these settings.

Local Address

Click the **Edit** button to set the local IP address (on LAN) for the rule.

Remote Address

Click the **Edit** button to set the remote IP address (on Lan/WAN) for the rule.

Edit

It allows you to edit source address information.

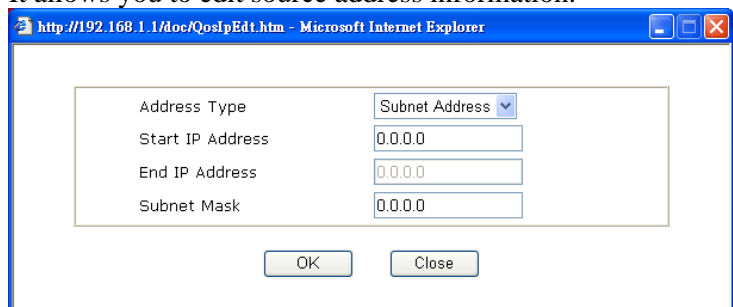

Address Type – Determine the address type for the source address.

For **Single Address**, you have to fill in Start IP address.

For **Range Address**, you have to fill in Start IP address and End IP address.

For **Subnet Address**, you have to fill in Start IP address and Subnet Mask.

DiffServ CodePoint

All the packets of data will be divided with different levels and will be processed according to the level type by the system. Please assign one of the level of the data for processing with QoS control.

Service Type

It determines the service type of the data for processing with QoS control. It can also be edited. You can choose the predefined service type from the Service Type drop down list. Those types are predefined in factory. Simply choose the one that you want for using by current QoS.

By the way, you can set up to 20 rules for one Class. If you want to edit an existed rule, please select the radio button of that one and click **Edit** to open the rule edit page for modification.

Class Index # 1

Name

NO	Status	Local Address	Remote Address	DiffServ CodePoint	Service Type
1 <input type="radio"/>	Active	Any	Any	IP precedence 2	ANY
2 <input type="radio"/>	Active	192.168.1.66	Any	ANY	TFTP(UDP:69)

Edit the Service Type for Class Rule

To add a new service type, edit or delete an existed service type, please click the Edit link under Service Type field.

General Setup

Index	Status	Bandwidth	Directon	Class 1	Class 2	Class 3	Others	UDP Bandwidth Control	
WAN1	Disable	10000Kbps/10000Kbps		25%	25%	25%	25%	Inactive	Setup
WAN2	Disable	10000Kbps/10000Kbps		25%	25%	25%	25%	Inactive	Setup

Class Rule

Index	Name	Rule	Service Type
Class 1		Edit	Edit
Class 2		Edit	
Class 3		Edit	

After you click the **Edit** link, you will see the following page.

User Defined Service Type

NO	Name	Protocol	Port
1	Empty	-	-

For adding a new service type, click **Add** to open the following page.

Service Type Edit

Service Name	<input type="text" value="Game"/>
Service Type	<input type="text" value="TCP"/> <input type="text" value="6"/>
Port Configuration	
Type	<input checked="" type="radio"/> Single <input type="radio"/> Range
Port Number	<input type="text" value="88"/> - <input type="text" value="0"/>

Service Name

Type in a new service for your request.

Service Type

Choose the type (TCP, UDP or TCP/UDP) for the new service.

Port Configuration

Click **Single** or **Range**. If you select Range, you have to type in the starting port number and the end porting number on the boxes below.

Port Number – Type in the starting port number and the end porting number here if you choose Range as the type.

By the way, you can set up to 40 service types. If you want to edit/delete an existed service type, please select the radio button of that one and click **Edit/Edit** for modification.

3.10 Applications

Below shows the menu items for Applications.

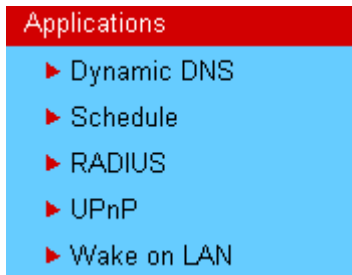

3.10.1 Dynamic DNS

The ISP often provides you with a dynamic IP address when you connect to the Internet via your ISP. It means that the public IP address assigned to your router changes each time you access the Internet. The Dynamic DNS feature lets you assign a domain name to a dynamic WAN IP address. It allows the router to update its online WAN IP address mappings on the specified Dynamic DNS server. Once the router is online, you will be able to use the registered domain name to access the router or internal virtual servers from the Internet. It is particularly helpful if you host a web server, FTP server, or other server behind the router.

Before you use the Dynamic DNS feature, you have to apply for free DDNS service to the DDNS service providers. The router provides up to three accounts from three different DDNS service providers. Basically, Vigor routers are compatible with the DDNS services supplied by most popular DDNS service providers such as www.dyndns.org, www.no-ip.com, www.dtdns.com, www.changeip.com, www.dynamic-nameserver.com. You should visit their websites to register your own domain name for the router.

Enable the Function and Add a Dynamic DNS Account

1. Assume you have a registered domain name from the DDNS provider, say *hostname.dyndns.org*, and an account with username: *test* and password: *test*.
2. In the DDNS setup menu, check **Enable Dynamic DNS Setup**.

Applications >> Dynamic DNS Setup

The screenshot shows the 'Dynamic DNS Setup' configuration page. At the top right, there is a link 'Set to Factory Default'. Below this, there is a checkbox labeled 'Enable Dynamic DNS Setup' which is checked. To the right of the checkbox are two buttons: 'View Log' and 'Force Update'. Below the checkbox is a section titled 'Accounts :'. It contains a table with four columns: 'Index', 'WAN Interface', 'Domain Name', and 'Active'. There are three rows in the table, each with an underlined index (1, 2, 3), 'WAN1 First' in the WAN Interface column, a period '.' in the Domain Name column, and an 'x' in the Active column. At the bottom of the page, there are two buttons: 'OK' and 'Clear All'.

Set to Factory Default Clear all profiles and recover to factory settings.

Enable Dynamic DNS Setup Check this box to enable DDNS function.

Index Click the number below Index to access into the setting page of DDNS setup to set account(s).

WAN Interface Display current WAN interface used for accessing Internet.

Domain Name	Display the domain name that you set on the setting page of DDNS setup.
Active	Display if this account is active or inactive.
View Log	Display DDNS log status.
Force Update	Force the router updates its information to DDNS server.

- Select Index number 1 to add an account for the router. Check **Enable Dynamic DNS Account**, and choose correct Service Provider: dyndns.org, type the registered hostname: *hostname* and domain name suffix: dyndns.org in the **Domain Name** block. The following two blocks should be typed your account Login Name: *test* and Password: *test*.

Applications >> Dynamic DNS Setup >> Dynamic DNS Account Setup

Index : 1

Enable Dynamic DNS Account

WAN Interface:

Service Provider:

Service Type:

Domain Name: .

Login Name: (max. 23 characters)

Password: (max. 23 characters)

Wildcards

Backup MX

Mail Extender:

Enable Dynamic DNS Account	Check this box to enable the current account. If you did check the box, you will see a check mark appeared on the Active column of the previous web page in step 2).
WAN Interface	Select the WAN interface order to apply settings here.
Service Provider	Select the service provider for the DDNS account.
Service Type	Select a service type (Dynamic, Custom, Static). If you choose Custom, you can modify the domain that is chosen in the Domain Name field.
Domain Name	Type in a domain name that you applied previously. Use the drop down list to choose the desired domain.
Login Name	Type in the login name that you set for applying domain.
Password	Type in the password that you set for applying domain.
Wildcards	It is not supported for all Dynamic DNS providers. Please get more detailed information from its website.
Backup MX	It is not supported for all Dynamic DNS providers. Please get more detailed information from its website.
Mail Extender	It allows you to control the delivery of mails for a given <i>domain</i> or <i>subdomain</i> . The entry you type here can be specified as a secondary mail exchanger. It means that delivery will be attempted to your host first, and then to the host you specify here if that fails.

4. Click **OK** button to activate the settings. You will see your setting has been saved.

The Wildcard and Backup MX features are not supported for all Dynamic DNS providers. You could get more detailed information from their websites.

Disable the Function and Clear all Dynamic DNS Accounts

In the DDNS setup menu, uncheck **Enable Dynamic DNS Setup**, and push **Clear All** button to disable the function and clear all accounts from the router.

Delete a Dynamic DNS Account

In the DDNS setup menu, click the **Index** number you want to delete and then push **Clear All** button to delete the account.

3.10.2 Schedule

The Vigor router has a built-in real time clock which can update itself manually or automatically by means of Network Time Protocols (NTP). As a result, you can not only schedule the router to dialup to the Internet at a specified time, but also restrict Internet access to certain hours so that users can connect to the Internet only during certain hours, say, business hours. The schedule is also applicable to other functions.

You have to set your time before set schedule. In **System Maintenance>> Time and Date** menu, press **Inquire Time** button to set the Vigor router's clock to current time of your PC. The clock will reset once if you power down or reset the router. There is another way to set up time. You can inquiry an NTP server (a time server) on the Internet to synchronize the router's clock. This method can only be applied when the WAN connection has been built up.

Applications >> Schedule

Schedule: | [Set to Factory Default](#) |

Index	Status	Index	Status
1.	x	9.	x
2.	x	10.	x
3.	x	11.	x
4.	x	12.	x
5.	x	13.	x
6.	x	14.	x
7.	x	15.	x
8.	x		

Status: v --- Active, x --- Inactive

Set to Factory Default Clear all profiles and recover to factory settings.

Index Click the number below Index to access into the setting page of schedule.

Status Display if this schedule setting is active or inactive.

You can set up to 15 schedules. Then you can apply them to your **Internet Access** or **VPN and Remote Access >> LAN-to-LAN** settings.

To add a schedule, please click any index, say Index No. 1. The detailed settings of the call schedule with index 1 are shown below.

Index No. 1

Enable Schedule Setup

Start Date (yyyy-mm-dd) 2000 - 1 - 1

Start Time (hh:mm) 0 : 0

Duration Time (hh:mm) 0 : 0

Action Force On

Idle Timeout 0 minute(s). (max. 255, 0 for default)

How Often

Once

Weekdays

Sun Mon Tue Wed Thu Fri Sat

OK Clear Cancel

- Enable Schedule Setup** Check to enable the schedule.
- Start Date (yyyy-mm-dd)** Specify the starting date of the schedule.
- Start Time (hh:mm)** Specify the starting time of the schedule.
- Duration Time (hh:mm)** Specify the duration (or period) for the schedule.
- Action** Specify which action Call Schedule should apply during the period of the schedule.
Force On -Force the connection to be always on.
Force Down -Force the connection to be always down.
Enable Dial-On-Demand -Specify the connection to be dial-on-demand and the value of idle timeout should be specified in **Idle Timeout** field.
Disable Dial-On-Demand -Specify the connection to be up when it has traffic on the line. Once there is no traffic over idle timeout, the connection will be down and never up again during the schedule.
- Idle Timeout** Specify the duration (or period) for the schedule.
How often -Specify how often the schedule will be applied
Once -The schedule will be applied just once
Weekdays -Specify which days in one week should perform the schedule.

Example

Suppose you want to control the PPPoE Internet access connection to be always on (Force On) from 9:00 to 18:00 for whole week. Other time the Internet access connection should be disconnected (Force Down).

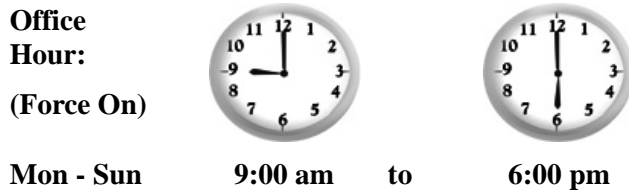

1. Make sure the PPPoE connection and **Time Setup** is working properly.
2. Configure the PPPoE always on from 9:00 to 18:00 for whole week.

3. Configure the **Force Down** from 18:00 to next day 9:00 for whole week.
4. Assign these two profiles to the PPPoE Internet access profile. Now, the PPPoE Internet connection will follow the schedule order to perform **Force On** or **Force Down** action according to the time plan that has been pre-defined in the schedule profiles.

3.10.3 RADIUS

Remote Authentication Dial-In User Service (RADIUS) is a security authentication client/server protocol that supports authentication, authorization and accounting, which is widely used by Internet service providers. It is the most common method of authenticating and authorizing dial-up and tunneled network users.

The built-in RADIUS client feature enables the router to assist the remote dial-in user or a wireless station and the RADIUS server in performing mutual authentication. It enables centralized remote access authentication for network management.

Applications >> RADIUS

RADIUS Setup

Enable

Server IP Address

Destination Port

Shared Secret

Confirm Shared Secret

- | | |
|------------------------------|---|
| Enable | Check to enable RADIUS client feature |
| Server IP Address | Enter the IP address of RADIUS server |
| Destination Port | The UDP port number that the RADIUS server is using. The default value is 1812 , based on RFC 2138. |
| Shared Secret | The RADIUS server and client share a secret that is used to authenticate the messages sent between them. Both sides must be configured to use the same shared secret. |
| Confirm Shared Secret | Re-type the Shared Secret for confirmation. |

3.10.4 UPnP

The **UPnP** (Universal Plug and Play) protocol is supported to bring to network connected devices the ease of installation and configuration which is already available for directly connected PC peripherals with the existing Windows 'Plug and Play' system. For NAT routers, the major feature of UPnP on the router is "NAT Traversal". This enables applications inside the firewall to automatically open the ports that they need to pass through a router. It is more reliable than requiring a router to work out by itself which ports need to be opened. Further, the user does not have to manually set up port mappings or a DMZ. **UPnP is available on Windows XP** and the router provides the associated support for MSN Messenger to allow full use of the voice, video and messaging features.

Applications >> UPnP



Note: If you intend running UPnP service inside your LAN, you should check the appropriate service above to allow control, as well as the appropriate UPnP settings.

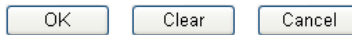

Enable UPnP Service Accordingly, you can enable either the **Connection Control Service** or **Connection Status Service**.

After setting **Enable UPnP Service** setting, an icon of **IP Broadband Connection on Router** on Windows XP/Network Connections will appear. The connection status and control status will be able to be activated. The NAT Traversal of UPnP enables the multimedia features of your applications to operate. This has to manually set up port mappings or use other similar methods. The screenshots below show examples of this facility.

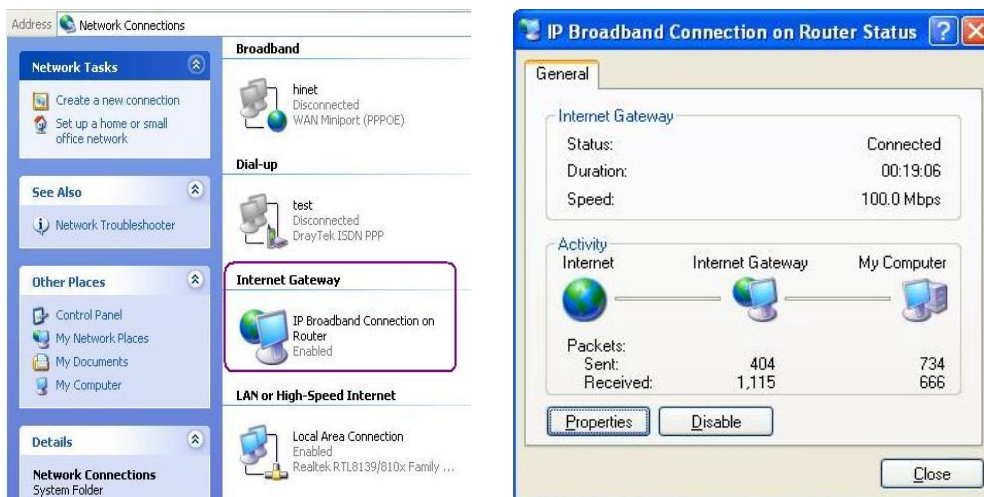

The UPnP facility on the router enables UPnP aware applications such as MSN Messenger to discover what are behind a NAT router. The application will also learn the external IP address and configure port mappings on the router. Subsequently, such a facility forwards packets from the external ports of the router to the internal ports used by the application.

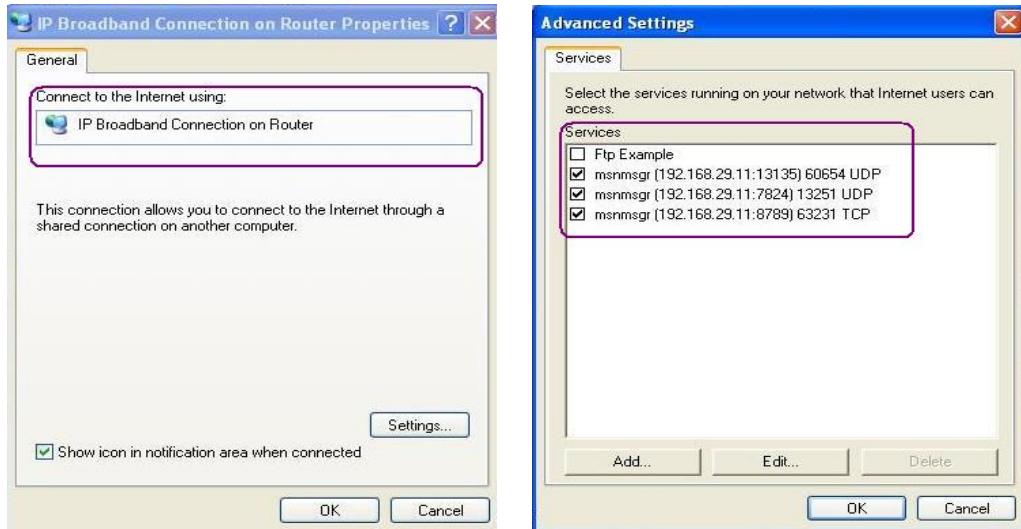

The reminder as regards concern about Firewall and UPnP

Can't work with Firewall Software

Enabling firewall applications on your PC may cause the UPnP function not working properly. This is because these applications will block the accessing ability of some network ports.

Security Considerations

Activating the UPnP function on your network may incur some security threats. You should consider carefully these risks before activating the UPnP function.

- Some Microsoft operating systems have found out the UPnP weaknesses and hence you need to ensure that you have applied the latest service packs and patches.
- Non-privileged users can control some router functions, including removing and adding port mappings.

The UPnP function dynamically adds port mappings on behalf of some UPnP-aware applications. When the applications terminate abnormally, these mappings may not be removed.

3.10.5 Wake On LAN

A PC client on LAN can be woken up by the router it connects. When a user wants to wake up a specified PC through the router, he/she must type correct MAC address of the specified PC on this web page of **Wake On LAN** of this router.

In addition, such PC must have installed a network card supporting WOL function. By the way, WOL function must be set as “Enable” on the BIOS setting.

Application >> Wake on LAN

Wake on LAN

Note: Wake on LAN integrates with **Bind IP to MAC** function, only binded PCs can wake up through IP.

Wake by:

IP Address:

MAC Address: : : : : :

Result

Wake by

Two types provide for you to wake up the binded IP. If you choose Wake by MAC Address, you have to type the correct MAC address of the host in MAC Address boxes. If you choose Wake by IP Address, you have to choose the correct IP address.

Wake by:

IP Address

The IP addresses that have been configured in **LAN>>Bind IP to MAC** will be shown in this drop down list. Choose the IP address from the drop down list that you want to wake up.

MAC Address

Type any one of the MAC address of the binded PCs.

Wake Up

Click this button to wake up the selected IP. See the following figure. The result will be shown on the box.

Application >> Wake on LAN

Wake on LAN

Note: Wake on LAN integrates with **Bind IP to MAC** function, only binded PCs can wake up through IP.

Wake by:

IP Address:

MAC Address: : : : : :

Result

Send command to client done.

3.11 VPN and Remote Access

A Virtual Private Network (VPN) is the extension of a private network that encompasses links across shared or public networks like the Internet. In short, by VPN technology, you can send data between two computers across a shared or public network in a manner that emulates the properties of a point-to-point private link.

Below shows the menu items for VPN and Remote Access.



Note: This feature can be applied for ISDN remote dial-in or ISDN LAN-to-LAN connection in *i* series models.

3.11.1 Remote Access Control

Enable the necessary VPN service as you need. If you intend to run a VPN server inside your LAN, you should disable the VPN service of Vigor Router to allow VPN tunnel pass through, as well as the appropriate NAT settings, such as DMZ or open port.

VPN and Remote Access >> Remote Access Control Setup

Remote Access Control Setup

<input checked="" type="checkbox"/>	Enable PPTP VPN Service
<input checked="" type="checkbox"/>	Enable IPSec VPN Service
<input checked="" type="checkbox"/>	Enable L2TP VPN Service
<input type="checkbox"/>	Enable ISDN Dial-In

Note: If you intend running a VPN server inside your LAN, you should uncheck the appropriate protocol above to allow pass-through, as well as the appropriate NAT settings.

OK Clear Cancel

The Vigor router will not accept the ISDN dial-in connection if the box of **Enable ISDN Dial-in** is not checked.

3.11.2 PPP General Setup

This submenu only applies to PPP-related VPN connections, such as PPTP, L2TP, L2TP over IPSec.

VPN and Remote Access >> PPP General Setup

PPP General Setup

PPP/MP Protocol	IP Address Assignment for Dial-In Users
Dial-In PPP Authentication: PAP or CHAP	Start IP Address: 192.168.1.200
Dial-In PPP Encryption (MPPE): Optional MPPE	
Mutual Authentication (PAP): <input type="radio"/> Yes <input checked="" type="radio"/> No	
Username: <input type="text"/>	
Password: <input type="text"/>	

OK

Dial-In PPP Authentication PAP Only

Select this option to force the router to authenticate dial-in users with the PAP protocol.

PAP or CHAP

Selecting this option means the router will attempt to authenticate dial-in users with the CHAP protocol first. If the dial-in user does not support this protocol, it will fall back to use the PAP protocol for authentication.

Dial-In PPP Encryption (MPPE Optional MPPE)

This option represents that the MPPE encryption method will be optionally employed in the router for the remote dial-in user. If the remote dial-in user does not support the MPPE encryption algorithm, the router will transmit “no MPPE encrypted packets”. Otherwise, the MPPE encryption scheme will be used to encrypt the data.

Optional MPPE

- Optional MPPE
- Require MPPE(40/128 bit)
- Maximum MPPE(128 bit)

Require MPPE (40/128bits) - Selecting this option will force the router to encrypt packets by using the MPPE encryption algorithm. In addition, the remote dial-in user will use 40-bit to perform encryption prior to using 128-bit for encryption. In other words, if 128-bit MPPE encryption method is not available, then 40-bit encryption scheme will be applied to encrypt the data.

Maximum MPPE - This option indicates that the router will use the MPPE encryption scheme with maximum bits (128-bit) to encrypt the data.

Mutual Authentication (PAP)

The Mutual Authentication function is mainly used to communicate with other routers or clients who need bi-directional authentication in order to provide stronger security, for example, Cisco routers. So you should enable this function when your peer router requires mutual authentication. You should further specify the **User Name** and **Password** of the mutual authentication peer.

Start IP Address

Enter a start IP address for the dial-in PPP connection. You should choose an IP address from the local private network.

For example, if the local private network is 192.168.1.0/255.255.255.0, you could choose 192.168.1.200 as the Start IP Address. But, you have to notice that the first two IP addresses of 192.168.1.200 and 192.168.1.201 are reserved for ISDN remote dial-in user.

3.11.3 IPSec General Setup

In **IPSec General Setup**, there are two major parts of configuration.

There are two phases of IPSec.

- Phase 1: negotiation of IKE parameters including encryption, hash, Diffie-Hellman parameter values, and lifetime to protect the following IKE exchange, authentication of both peers using either a Pre-Shared Key or Digital Signature (x.509). The peer that starts the negotiation proposes all its policies to the remote peer and then remote peer tries to find a highest-priority match with its policies. Eventually to set up a secure tunnel for IKE Phase 2.
- Phase 2: negotiation IPSec security methods including Authentication Header (AH) or Encapsulating Security Payload (ESP) for the following IKE exchange and mutual examination of the secure tunnel establishment.

There are two encapsulation methods used in IPSec, **Transport** and **Tunnel**. The **Transport** mode will add the AH/ESP payload and use original IP header to encapsulate the data payload only. It can just apply to local packet, e.g., L2TP over IPSec. The **Tunnel** mode will not only add the AH/ESP payload but also use a new IP header (Tunneled IP header) to encapsulate the whole original IP packet.

Authentication Header (AH) provides data authentication and integrity for IP packets passed between VPN peers. This is achieved by a keyed one-way hash function to the packet to create a message digest. This digest will be put in the AH and transmitted along with packets. On the receiving side, the peer will perform the same one-way hash on the packet and compare the value with the one in the AH it receives.

Encapsulating Security Payload (ESP) is a security protocol that provides data confidentiality and protection with optional authentication and replay detection service.

VPN and Remote Access >> IPSec General Setup

VPN IKE/IPSec General Setup

Dial-in Set up for Remote Dial-in users and Dynamic IP Client (LAN to LAN).

IKE Authentication Method

Pre-Shared Key

Confirm Pre-Shared Key

IPSec Security Method

Medium (AH)
Data will be authentic, but will not be encrypted.

High (ESP) DES 3DES AES
Data will be encrypted and authentic.

IKE Authentication Method This usually applies to those are remote dial-in user or node (LAN-to-LAN) which uses dynamic IP address and IPSec-related VPN connections such as L2TP over IPSec and IPSec tunnel.

Pre-Shared Key -Currently only support Pre-Shared Key authentication.

Pre-Shared Key- Specify a key for IKE authentication
Confirm Pre-Shared Key-Confirm the pre-shared key.

IPSec Security Method

Medium - Authentication Header (AH) means data will be authenticated, but not be encrypted. By default, this option is active.

High - Encapsulating Security Payload (ESP) means payload (data) will be encrypted and authenticated. You may select encryption algorithm from Data Encryption Standard (DES), Triple DES (3DES), and AES.

3.11.4 IPSec Peer Identity

To use digital certificate for peer authentication in either LAN-to-LAN connection or Remote User Dial-In connection, here you may edit a table of peer certificate for selection. As shown below, the router provides **200** entries of digital certificates for peer dial-in users.

VPN and Remote Access >> IPSec Peer Identity

X509 Peer ID Accounts: | [Set to Factory Default](#) |

Index	Name	Status	Index	Name	Status
1.	???	×	17.	???	×
2.	???	×	18.	???	×
3.	???	×	19.	???	×
4.	???	×	20.	???	×
5.	???	×	21.	???	×
6.	???	×	22.	???	×
7.	???	×	23.	???	×
8.	???	×	24.	???	×
9.	???	×	25.	???	×
10.	???	×	26.	???	×
11.	???	×	27.	???	×
12.	???	×	28.	???	×
13.	???	×	29.	???	×
14.	???	×	30.	???	×
15.	???	×	31.	???	×
16.	???	×	32.	???	×

<< [1-32](#) | [33-64](#) | [65-96](#) | [97-128](#) | [129-160](#) | [161-192](#) | [193-200](#) >> [Next](#) >>

Set to Factory Default Click it to clear all indexes.

Index Click the number below Index to access into the setting page of IPSec Peer Identity.

Name Display the profile name of that index.

Click each index to edit one peer digital certificate. There are three security levels of digital signature authentication: Fill each necessary field to authenticate the remote peer. The following explanation will guide you to fill all the necessary fields.

Profile Index : 1

Profile Name

Enable this account

Accept Any Peer ID

Accept Subject Alternative Name

Type

IP

Accept Subject Name

Country (C)

State (ST)

Location (L)

Organization (O)

Organization Unit (OU)

Common Name (CN)

Email (E)

- Profile Name** Type in a name in this file.
- Accept Any Peer ID** Click to accept any peer regardless of its identity.
- Accept Subject Alternative Name** Click to check one specific field of digital signature to accept the peer with matching value. The field can be **IP Address**, **Domain**, or **E-mail Address**. The box under the Type will appear according to the type you select and ask you to fill in corresponding setting.
- Accept Subject Name** Click to check the specific fields of digital signature to accept the peer with matching value. The field includes **Country (C)**, **State (ST)**, **Location (L)**, **Organization (O)**, **Organization Unit (OU)**, **Common Name (CN)**, and **Email (E)**.

3.11.5 Remote Dial-in User

You can manage remote access by maintaining a table of remote user profile, so that users can be authenticated to dial-in via ISDN or build the VPN connection. You may set parameters including specified connection peer ID, connection type (ISDN Dial-In connection, VPN connection - including PPTP, IPSec Tunnel, and L2TP by itself or over IPSec) and corresponding security methods, etc.

The router provides **200** access accounts for dial-in users. Besides, you can extend the user accounts to the RADIUS server through the built-in RADIUS client function. The following figure shows the summary table.

VPN and Remote Access >> Remote Dial-in User

Remote Access User Accounts: | [Set to Factory Default](#) |

Index	User	Status	Index	User	Status
1.	???	×	17.	???	×
2.	???	×	18.	???	×
3.	???	×	19.	???	×
4.	???	×	20.	???	×
5.	???	×	21.	???	×
6.	???	×	22.	???	×
7.	???	×	23.	???	×
8.	???	×	24.	???	×
9.	???	×	25.	???	×
10.	???	×	26.	???	×
11.	???	×	27.	???	×
12.	???	×	28.	???	×
13.	???	×	29.	???	×
14.	???	×	30.	???	×
15.	???	×	31.	???	×
16.	???	×	32.	???	×

<< [1-32](#) | [33-64](#) | [65-96](#) | [97-128](#) | [129-160](#) | [161-192](#) | [193-200](#) >> [Next](#) >>

Set to Factory Default

Click to clear all indexes.

Index

Click the number below Index to access into the setting page of Remote Dial-in User.

User

Display the username for the specific dial-in user of the LAN-to-LAN profile. The symbol ??? represents that the profile is empty.

Status

Display the access state of the specific dial-in user. The symbol V and X represent the specific dial-in user to be active and inactive, respectively.

Click each index to edit one remote user profile. **Each Dial-In Type requires you to fill the different corresponding fields on the right.** If the fields gray out, it means you may leave it untouched. The following explanation will guide you to fill all the necessary fields.

Index No. 1

User account and Authentication <input checked="" type="checkbox"/> Enable this account Idle Timeout <input type="text" value="300"/> second(s)	
Allowed Dial-In Type <input type="checkbox"/> ISDN <input checked="" type="checkbox"/> PPTP <input checked="" type="checkbox"/> IPsec Tunnel <input checked="" type="checkbox"/> L2TP with IPsec Policy <input type="text" value="None"/>	
<input type="checkbox"/> Specify Remote Node Remote Client IP or Peer ISDN Number <input type="text"/> or Peer ID <input type="text"/>	
Username <input type="text" value="???"/> Password <input type="text"/>	
IKE Authentication Method <input checked="" type="checkbox"/> Pre-Shared Key IKE Pre-Shared Key <input type="text"/> <input type="checkbox"/> Digital Signature (X.509) <input type="text" value="None"/>	
IPsec Security Method <input checked="" type="checkbox"/> Medium (AH) <input type="checkbox"/> High (ESP) <input checked="" type="checkbox"/> DES <input checked="" type="checkbox"/> 3DES <input checked="" type="checkbox"/> AES Local ID <input type="text"/> (optional)	
Callback Function <input type="checkbox"/> Check to enable Callback function <input type="checkbox"/> Specify the callback number Callback Number <input type="text"/> <input checked="" type="checkbox"/> Check to enable Callback Budget Control Callback Budget <input type="text" value="30"/> minute(s)	

Enable this account

Check the box to enable this function.

Idle Timeout- If the dial-in user is idle over the limitation of the timer, the router will drop this connection. By default, the Idle Timeout is set to 300 seconds.

ISDN

Allow the remote ISDN dial-in connection. You can further set up Callback function below. You should set the User Name and Password of remote dial-in user below. This feature is for *i* model only.

PPTP

Allow the remote dial-in user to make a PPTP VPN connection through the Internet. You should set the User Name and Password of remote dial-in user below

IPsec Tunnel

Allow the remote dial-in user to make an IPsec VPN connection through Internet.

L2TP

Allow the remote dial-in user to make a L2TP VPN connection through the Internet. You can select to use L2TP alone or with IPsec. Select from below:

None - Do not apply the IPsec policy. Accordingly, the VPN connection employed the L2TP without IPsec policy can be viewed as one pure L2TP connection.

Nice to Have - Apply the IPsec policy first, if it is applicable during negotiation. Otherwise, the dial-in VPN connection becomes one pure L2TP connection.

Must -Specify the IPsec policy to be definitely applied on the L2TP connection.

Specify Remote Node

Check the checkbox-You can specify the IP address of the remote dial-in user, ISDN number or peer ID (used in IKE aggressive mode).

Uncheck the checkbox-This means the connection type you

select above will apply the authentication methods and security methods in the **general settings**.

User Name

This field is applicable when you select ISDN, PPTP or L2TP with or without IPSec policy above.

Password

This field is applicable when you select ISDN, PPTP or L2TP with or without IPSec policy above.

IKE Authentication Method

This group of fields is applicable for IPSec Tunnels and L2TP with IPSec Policy when you specify the IP address of the remote node. The only exception is Digital Signature (X.509) can be set when you select IPSec tunnel either with or without specify the IP address of the remote node.

Pre-Shared Key - Check the box of Pre-Shared Key to invoke this function and type in the required characters (1-63) as the pre-shared key.

Digital Signature (X.509) – Check the box of Digital Signature to invoke this function and Select one predefined Profiles set in the **VPN and Remote Access >>IPSec Peer Identity**.

IPSec Security Method

This group of fields is a must for IPSec Tunnels and L2TP with IPSec Policy when you specify the remote node. Check the Medium, DES, 3DES or AES box as the security method. **Medium-Authentication Header (AH)** means data will be authenticated, but not be encrypted. By default, this option is invoked. You can uncheck it to disable it.

High-Encapsulating Security Payload (ESP) means payload (data) will be encrypted and authenticated. You may select encryption algorithm from Data Encryption Standard (DES), Triple DES (3DES), and AES.

Local ID - Specify a local ID to be used for Dial-in setting in the LAN-to-LAN Profile setup. This item is optional and can be used only in IKE aggressive mode.

Callback Function

The callback function provides a callback service only for the ISDN dial-in user (for *i* model only). The remote user will be charged the connection fee by the telecom.

Check to enable Callback function-Enables the callback function.

Specify the callback number-The option is for extra security. Once enabled, the router will ONLY call back to the specified Callback Number.

Check to enable callback budget control-By default, the callback function has a time restriction. Once the callback budget has been exhausted, the callback mechanism will be disabled automatically.

Callback Budget (Unit: minutes)- Specify the time budget for the dial-in user. The budget will be decreased automatically per callback connection.

3.11.6 LAN to LAN

Here you can manage LAN-to-LAN connections by maintaining a table of connection profiles. You may set parameters including specified connection direction (dial-in or dial-out), connection peer ID, connection type (ISDN connection, VPN connection - including PPTP, IPsec Tunnel, and L2TP by itself or over IPsec) and corresponding security methods, etc.

The router provides up to **200** profiles, which also means supporting **200** VPN tunnels simultaneously. The following figure shows the summary table.

VPN and Remote Access >> LAN to LAN

LAN-to-LAN Profiles: [Set to Factory Default](#)

Index	Name	Status	Index	Name	Status
1.	???	X	17.	???	X
2.	???	X	18.	???	X
3.	???	X	19.	???	X
4.	???	X	20.	???	X
5.	???	X	21.	???	X
6.	???	X	22.	???	X
7.	???	X	23.	???	X
8.	???	X	24.	???	X
9.	???	X	25.	???	X
10.	???	X	26.	???	X
11.	???	X	27.	???	X
12.	???	X	28.	???	X
13.	???	X	29.	???	X
14.	???	X	30.	???	X
15.	???	X	31.	???	X
16.	???	X	32.	???	X

<< [1-32](#) | [33-64](#) | [65-96](#) | [97-128](#) | [129-160](#) | [161-192](#) | [193-200](#) >> [Next](#) >>

Set to Factory Default

Click to clear all indexes.

Name

Indicate the name of the LAN-to-LAN profile. The symbol ??? represents that the profile is empty.

Status

Indicate the status of individual profiles. The symbol V and X represent the profile to be active and inactive, respectively.

Click each index to edit each profile and you will get the following page. Each LAN-to-LAN profile includes 4 subgroups. If the fields gray out, it means you may leave it untouched. The following explanations will guide you to fill all the necessary fields.

For the web page is too long, we divide the page into several sections for explanation.

Profile Index : 1

1. Common Settings

Profile Name: <input type="text" value="test"/>	Call Direction: <input checked="" type="radio"/> Both <input type="radio"/> Dial-Out <input type="radio"/> Dial-In
<input checked="" type="checkbox"/> Enable this profile	<input type="checkbox"/> Always on
VPN Connection Through: <input type="text" value="WAN1 First"/>	Idle Timeout: <input type="text" value="300"/> second(s)
	<input type="checkbox"/> Enable PING to keep alive
	PING to the IP: <input type="text"/>

2. Dial-Out Settings

Type of Server I am calling <input checked="" type="radio"/> ISDN <input type="radio"/> PPTP <input type="radio"/> IPSec Tunnel <input type="radio"/> L2TP with IPSec Policy <input type="text" value="None"/>	Link Type: <input type="text" value="64k bps"/> Username: <input type="text" value="???"/> Password: <input type="text"/> PPP Authentication: <input type="text" value="PAP/CHAP"/> VJ Compression: <input checked="" type="radio"/> On <input type="radio"/> Off
Dial Number for ISDN or Server IP/Host Name for VPN. (such as 5551234, draytek.com or 123.45.67.89) <input type="text"/>	IKE Authentication Method <input checked="" type="radio"/> Pre-Shared Key IKE Pre-Shared Key: <input type="text"/> <input type="radio"/> Digital Signature(X.509) <input type="text" value="None"/>
	IPSec Security Method <input checked="" type="radio"/> Medium(AH) <input type="radio"/> High(ESP) <input type="text" value="DES without Authentication"/> <input type="button" value="Advanced"/>
	Index(1-15) in Schedule Setup: <input type="text"/> <input type="text"/> <input type="text"/> <input type="text"/>
	Callback Function (CBCP) <input type="checkbox"/> Require Remote to Callback <input type="checkbox"/> Provide ISDN Number to Remote

Profile Name

Specify a name for the profile of the LAN-to-LAN connection.

Enable this profile

Check here to activate this profile.

VPN Connection Through

Use the drop down menu to choose a proper WAN interface for this profile. This setting is useful for dial-out only.

VPN Connection Through:

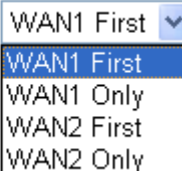

WAN1 First - While connecting, the router will use WAN1 as the first channel for VPN connection. If WAN1 fails, the router will use another WAN interface instead.

WAN1 Only - While connecting, the router will use WAN1 as the only channel for VPN connection.

WAN2 First - While connecting, the router will use WAN2 as the first channel for VPN connection. If WAN2 fails, the router will use another WAN interface instead.

WAN2 Only - While connecting, the router will use WAN2 as the only channel for VPN connection.

Call Direction

Specify the allowed call direction of this LAN-to-LAN profile.

Both:-initiator/responder

Dial-Out- initiator only

Dial-In- responder only.

Always On or Idle Timeout

Always On-Check to enable router always keep VPN connection.

Idle Timeout: The default value is 300 seconds. If the

connection has been idled over the value, the router will drop the connection.

Enable PING to keep alive This function is to help the router to determine the status of IPSec VPN connection, especially useful in the case of abnormal VPN IPSec tunnel disruption. For details, please refer to the note below. Check to enable the transmission of PING packets to a specified IP address.

PING to the IP Enter the IP address of the remote host that located at the other-end of the VPN tunnel.

Enable PING to Keep Alive is used to handle abnormal IPSec VPN connection disruption. It will help to provide the state of a VPN connection for router's judgment of redial.

Normally, if any one of VPN peers wants to disconnect the connection, it should follow a serial of packet exchange procedure to inform each other. However, if the remote peer disconnect without notice, Vigor router will be no where to know this situation. To resolve this dilemma, by continuously sending PING packets to the remote host, the Vigor router can know the true existence of this VPN connection and react accordingly. This is independent of DPD (dead peer detection).

ISDN Build ISDN LAN-to-LAN connection to remote network. You should set up Link Type and identity like User Name and Password for the authentication of remote server. You can further set up Callback (CBCP) function below. This feature is useful for *i* model only.

PPTP Build a PPTP VPN connection to the server through the Internet. You should set the identity like User Name and Password below for the authentication of remote server.

IPSec Tunnel Build an IPSec VPN connection to the server through Internet.

L2TP with ... Build a L2TP VPN connection through the Internet. You can select to use L2TP alone or with IPSec. Select from below:
None: Do not apply the IPSec policy. Accordingly, the VPN connection employed the L2TP without IPSec policy can be viewed as one pure L2TP connection.
Nice to Have: Apply the IPSec policy first, if it is applicable during negotiation. Otherwise, the dial-out VPN connection becomes one pure L2TP connection.
Must: Specify the IPSec policy to be definitely applied on the L2TP connection.

Server IP/Host Name for.. You can specify the IP address of the remote dial-out user.

User Name This field is applicable when you select ISDN, PPTP or L2TP with or without IPSec policy above.

Password This field is applicable when you select ISDN, PPTP or L2TP with or without IPSec policy above.

PPP Authentication This field is applicable when you select ISDN, PPTP or L2TP with or without IPSec policy above. PAP/CHAP is the most common selection due to wild compatibility.

VJ compression

This field is applicable when you select ISDN, PPTP or L2TP with or without IPSec policy above. VJ Compression is used for TCP/IP protocol header compression. Normally set to **Yes** to improve bandwidth utilization.

IKE Authentication Method

This group of fields is applicable for IPSec Tunnels and L2TP with IPSec Policy.

Pre-Shared Key-Input 1-63 characters as pre-shared key.

Digital Signature (X.509) - Select one predefined Profiles set in the **VPN and Remote Access >>IPSec Peer Identity**.

IPSec Security Method

This group of fields is a must for IPSec Tunnels and L2TP with IPSec Policy.

Medium (AH - Authentication Header) means data will be authenticated, but not be encrypted. By default, this option is active.

High (ESP-Encapsulating Security Payload)- means payload (data) will be encrypted and authenticated. Select from below:

DES without Authentication -Use DES encryption algorithm and not apply any authentication scheme.

DES with Authentication-Use DES encryption algorithm and apply MD5 or SHA-1 authentication algorithm.

3DES without Authentication-Use triple DES encryption algorithm and not apply any authentication scheme.

3DES with Authentication-Use triple DES encryption algorithm and apply MD5 or SHA-1 authentication algorithm.

AES without Authentication-Use AES encryption algorithm and not apply any authentication scheme.

AES with Authentication-Use AES encryption algorithm and apply MD5 or SHA-1 authentication algorithm.

Advanced

Specify mode, proposal and key life of each IKE phase, Gateway etc.

The window of advance setup is shown as below:

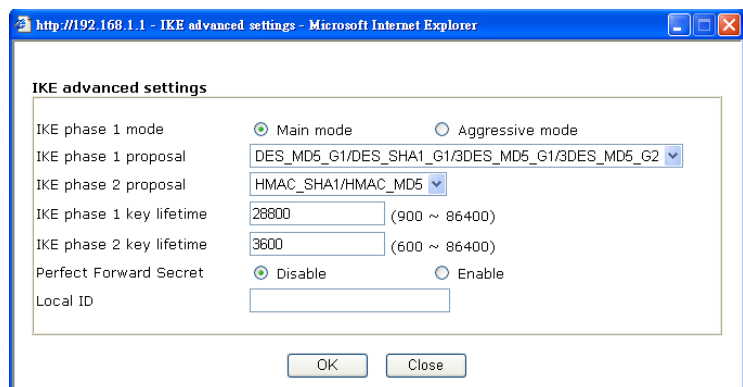

IKE phase 1 mode -Select from **Main** mode and **Aggressive** mode. The ultimate outcome is to exchange security proposals to create a protected secure channel. **Main** mode is more secure than **Aggressive** mode since more exchanges are done in a secure channel to set up the IPSec session. However, the **Aggressive** mode is faster. The default value in Vigor router is Main mode.

IKE phase 1 proposal-To propose the local available

authentication schemes and encryption algorithms to the VPN peers, and get its feedback to find a match. Two combinations are available for Aggressive mode and nine for **Main** mode. We suggest you select the combination that covers the most schemes.

IKE phase 2 proposal-To propose the local available algorithms to the VPN peers, and get its feedback to find a match. Three combinations are available for both modes. We suggest you select the combination that covers the most algorithms.

IKE phase 1 key lifetime-For security reason, the lifetime of key should be defined. The default value is 28800 seconds. You may specify a value in between 900 and 86400 seconds.

IKE phase 2 key lifetime-For security reason, the lifetime of key should be defined. The default value is 3600 seconds. You may specify a value in between 600 and 86400 seconds.

Perfect Forward Secret (PFS)-The IKE Phase 1 key will be reused to avoid the computation complexity in phase 2. The default value is inactive this function.

Local ID-In **Aggressive** mode, Local ID is on behalf of the IP address while identity authenticating with remote VPN server. The length of the ID is limited to 47 characters.

Callback Function (for *i* models only)

The callback function provides a callback service as a part of PPP suite only for the ISDN dial-in user. The router owner will be charged the connection fee by the telecom.

Require Remote to Callback-Enable this to let the router to require the remote peer to callback for the connection afterwards.

Provide ISDN Number to Remote-In the case that the remote peer requires the Vigor router to callback, the local ISDN number will be provided to the remote peer. Check here to allow the Vigor router to send the ISDN number to the remote router. This feature is useful for *i* model only.

3. Dial-In Settings

Allowed Dial-In Type <input checked="" type="checkbox"/> ISDN <input checked="" type="checkbox"/> PPTP <input checked="" type="checkbox"/> IPsec Tunnel <input checked="" type="checkbox"/> L2TP with IPsec Policy <input type="text" value="None"/> <input type="checkbox"/> Specify ISDN CLID or Remote VPN Gateway Peer ISDN Number or Peer VPN Server IP <input type="text"/> or Peer ID <input type="text"/>	Username <input type="text" value="???"/> Password <input type="text"/> VJ Compression <input checked="" type="radio"/> On <input type="radio"/> Off IKE Authentication Method <input checked="" type="checkbox"/> Pre-Shared Key IKE Pre-Shared Key <input type="text"/> <input type="checkbox"/> Digital Signature(X.509) <input type="text" value="None"/> IPsec Security Method <input checked="" type="checkbox"/> Medium (AH) High (ESP) <input checked="" type="checkbox"/> DES <input checked="" type="checkbox"/> 3DES <input checked="" type="checkbox"/> AES Callback Function (CBCP) <input type="checkbox"/> Enable Callback Function <input type="checkbox"/> Use the Following Number to Callback Callback Number <input type="text"/> Callback Budget <input type="text" value="0"/> minute(s)
4. TCP/IP Network Settings My WAN IP <input type="text" value="0.0.0.0"/> Remote Gateway IP <input type="text" value="0.0.0.0"/> Remote Network IP <input type="text" value="0.0.0.0"/> Remote Network Mask <input type="text" value="255.255.255.0"/> <input type="button" value="More"/>	RIP Direction <input type="text" value="RX Only"/> For NAT operation, treat remote subnet as <input type="text" value="Public IP"/> <input type="checkbox"/> Change default route to this VPN tunnel

Allowed Dial-In Type

Determine the dial-in connection with different types.

ISDN

Allow the remote ISDN LAN-to-LAN connection. You should set the User Name and Password of remote dial-in user below. This feature is useful for *i* model only. In addition, you can further set up Callback function below.

PPTP

Allow the remote dial-in user to make a PPTP VPN connection through the Internet. You should set the User Name and Password of remote dial-in user below.

IPsec Tunnel

Allow the remote dial-in user to trigger an IPsec VPN connection through Internet.

L2TP

Allow the remote dial-in user to make a L2TP VPN connection through the Internet. You can select to use L2TP alone or with IPsec. Select from below:

None- Do not apply the IPsec policy. Accordingly, the VPN connection employed the L2TP without IPsec policy can be viewed as one pure L2TP connection.

Nice to Have- Apply the IPsec policy first, if it is applicable during negotiation. Otherwise, the dial-in VPN connection becomes one pure L2TP connection.

Must- Specify the IPsec policy to be definitely applied on the L2TP connection.

Specify CLID or Remote VPN Gateway	<p>You can specify the IP address of the remote dial-in user or peer ID (should be the same with the ID setting in dial-in type) by checking the box. Enter Peer ISDN number if you select ISDN above (This feature is useful for <i>i</i> model only.). Also, you should further specify the corresponding security methods on the right side.</p> <p>If you uncheck the checkbox, the connection type you select above will apply the authentication methods and security methods in the general settings.</p>
User Name	This field is applicable when you select ISDN, PPTP or L2TP with or without IPSec policy above.
Password	This field is applicable when you select ISDN, PPTP or L2TP with or without IPSec policy above.
VJ Compression	VJ Compression is used for TCP/IP protocol header compression. This field is applicable when you select ISDN, PPTP or L2TP with or without IPSec policy above.
IKE Authentication Method	<p>This group of fields is applicable for IPSec Tunnels and L2TP with IPSec Policy when you specify the IP address of the remote node. The only exception is Digital Signature (X.509) can be set when you select IPSec tunnel either with or without specify the IP address of the remote node.</p> <p>Pre-Shared Key - Check the box of Pre-Shared Key to invoke this function and type in the required characters (1-63) as the pre-shared key.</p> <p>Digital Signature (X.509) – Check the box of Digital Signature to invoke this function and select one predefined Profiles set in the VPN and Remote Access >>IPSec Peer Identity.</p>
IPSec Security Method	<p>This group of fields is a must for IPSec Tunnels and L2TP with IPSec Policy when you specify the remote node.</p> <p>Medium- Authentication Header (AH) means data will be authenticated, but not be encrypted. By default, this option is active.</p> <p>High- Encapsulating Security Payload (ESP) means payload (data) will be encrypted and authenticated. You may select encryption algorithm from Data Encryption Standard (DES), Triple DES (3DES), and AES.</p>
Callback Function	<p>The callback function provides a callback service only for the ISDN LAN-to-LAN connection (this feature is useful for <i>i</i> model only). The remote user will be charged the connection fee by the telecom.</p> <p>Check to enable Callback function-Enables the callback function.</p> <p>Callback number-The option is for extra security. Once enabled, the router will ONLY call back to the specified Callback Number.</p> <p>Callback budget- By default, the callback function has limitation of callback period. Once the callback budget is exhausted, the function will be disabled automatically.</p> <p>Callback Budget (Unit: minutes)- Specify the time budget for the dial-in user. The budget will be decreased</p>

automatically per callback connection. The default value 0 means no limitation of callback period.

My WAN IP

This field is only applicable when you select ISDN, PPTP or L2TP with or without IPSec policy above. The default value is 0.0.0.0, which means the Vigor router will get a PPP IP address from the remote router during the IPCP negotiation phase. If the PPP IP address is fixed by remote side, specify the fixed IP address here. Do not change the default value if you do not select ISDN, PPTP or L2TP.

Remote Gateway IP

This field is only applicable when you select ISDN, PPTP or L2TP with or without IPSec policy above. The default value is 0.0.0.0, which means the Vigor router will get a remote Gateway PPP IP address from the remote router during the IPCP negotiation phase. If the PPP IP address is fixed by remote side, specify the fixed IP address here. Do not change the default value if you do not select ISDN, PPTP or L2TP.

Remote Network IP/ Remote Network Mask

Add a static route to direct all traffic destined to this Remote Network IP Address/Remote Network Mask through the VPN connection. For IPSec, this is the destination clients IDs of phase 2 quick mode.

More

Add a static route to direct all traffic destined to more Remote Network IP Addresses/ Remote Network Mask through the VPN connection. This is usually used when you find there are several subnets behind the remote VPN router.

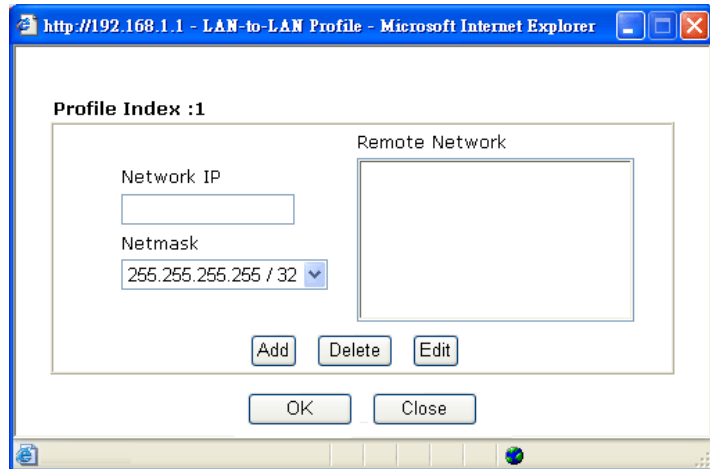

RIP Direction

The option specifies the direction of RIP (Routing Information Protocol) packets. You can enable/disable one of direction here. Herein, we provide four options: TX/RX Both, TX Only, RX Only, and Disable.

From first subnet to remote network, you have to do

If the remote network only allows you to dial in with single IP, please choose **NAT**, otherwise choose **Route**.

Change default route to this VPN tunnel

Check this box to change the default route with this VPN tunnel. Be aware that this setting is available only for one WAN interface is enabled. It is not available when both WAN interfaces are enabled.

3.11.7 Connection Management

You can find the summary table of all VPN connections. You may disconnect any VPN connection by clicking **Drop** button. You may also aggressively Dial-out by using Dial-out Tool and clicking **Dial** button.

VPN and Remote Access >> Connection Management

Dial-out Tool Refresh Seconds : 10

VPN Connection Status
Current Page: 1 Page No.

VPN	Type	Remote IP	Virtual Network	Tx Pkts	Tx Rate	Rx Pkts	Rx Rate	UpTime

xxxxxxx : Data is encrypted.
xxxxxxx : Data isn't encrypted.

Dial

Click this button to execute dial out function.

Refresh Seconds

Choose the time for refresh the dial information among 5, 10, and 30.

Refresh

Click this button to refresh the whole connection status.

3.12 Certificate Management

A digital certificate works as an electronic ID, which is issued by a certification authority (CA). It contains information such as your name, a serial number, expiration dates etc., and the digital signature of the certificate-issuing authority so that a recipient can verify that the certificate is real. Here Vigor router support digital certificates conforming to standard X.509.

Any entity wants to utilize digital certificates should first request a certificate issued by a CA server. It should also retrieve certificates of other trusted CA servers so it can authenticate the peer with certificates issued by those trusted CA servers.

Here you can manage generate and manage the local digital certificates, and set trusted CA certificates. Remember to adjust the time of Vigor router before using the certificate so that you can get the correct valid period of certificate.

Below shows the menu items for Certificate Management.

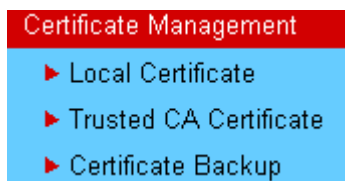

3.12.1 Local Certificate

Certificate Management >> Local Certificate

X509 Local Certificate Configuration

Name	Subject	Status	Modify	
Local	---	---	<input type="button" value="View"/>	<input type="button" value="Delete"/>

X509 Local Certificate

Generate

Click this button to open **Generate Certificate Request** window.

Generate Certificate Request

Subject Alternative Name

Type: IP Address (dropdown)
 IP:

Subject Name

Country (C):
 State (ST):
 Location (L):
 Organization (O):
 Organization Unit (OU):
 Common Name (CN):
 Email (E):

Key Type: RSA (dropdown)
Key Size: 1024 Bit (dropdown)

Generate

Type in all the information that the window request. Then click **Generate** again.

Import

Click this button to import a saved file as the certification information.

Refresh

Click this button to refresh the information listed below.

View

Click this button to view the detailed settings for certificate request.

After clicking **Generate**, the generated information will be displayed on the window below:

X509 Local Certificate Configuration

Name	Subject	Status	Modify
Local	/C=TW/O=Draytek/OU=RD/emailA...	Requesting	<input type="button" value="View"/> <input type="button" value="Delete"/>

X509 Local Certificate Request

```

-----BEGIN CERTIFICATE REQUEST-----
MIIBjzCB+QIBADBQMqswCQYDVQQGEwJUVzEQMA4GA1UEChMHRRHJheXR1azELMAkG
A1UECXMUkQxIjAgBgkqhkiG9wOBCQEWES3N1cnZpY2VAZHJheXR1ay5jb20wgZSw
DQYJKoZIhvcNAQEBBQADgYOAAMIGJAoGBAMemQ68+eOu+ESZ37c1TP51CRDFuxgxw
K89UJEeq1lh7rUYhrfgFjo7kZ0fQTPWjqU/wv3vmwOEnkg16mntzq9tBMdfi2djG
cDIzQh7H9MOmpP0qrPu0cga0Ete1oaLhgV1MovrojR6OXNPABq6kYr4NYLMh1bFH
MDkjEpdMQARpAgMBAAGGADANBgkqhkiG9w0BAQUFAAOBgQBWphus100n9rZ8y2C2
egi0n39FoAPathPmqH2oAYFGeDMbCHGUY4vHdkQo7R0bVtKkqs17D12hPESHgSO
P/D4zKQiJLTXSm8+3gX3ZdRq+IjpsruzZTTBPBMR93PhP3USUYTrBLolpNVQCgqj
jaquLf4Xpb0VVqOq8a4UbtXENw==
-----END CERTIFICATE REQUEST-----
    
```

3.12.2 Trusted CA Certificate

Trusted CA certificate lists three sets of trusted CA certificate.

Certificate Management >> Trusted CA Certificate

X509 Trusted CA Certificate Configuration

Name	Subject	Status	Modify	
Trusted CA-1	---	---	<input type="button" value="View"/>	<input type="button" value="Delete"/>
Trusted CA-2	---	---	<input type="button" value="View"/>	<input type="button" value="Delete"/>
Trusted CA-3	---	---	<input type="button" value="View"/>	<input type="button" value="Delete"/>

To import a pre-saved trusted CA certificate, please click **IMPORT** to open the following window. Use **Browse...** to find out the saved text file. Then click **Import**. The one you imported will be listed on the Trusted CA Certificate window. Then click **Import** to use the pre-saved file.

Certificate Management >> Trusted CA Certificate

Import X509 Trusted CA Certificate

Select a trusted CA certificate file.

Click [Import](#) to upload the certification.

For viewing each trusted CA certificate, click **View** to open the certificate detail information window. If you want to delete a CA certificate, choose the one and click **Delete** to remove all the certificate information.

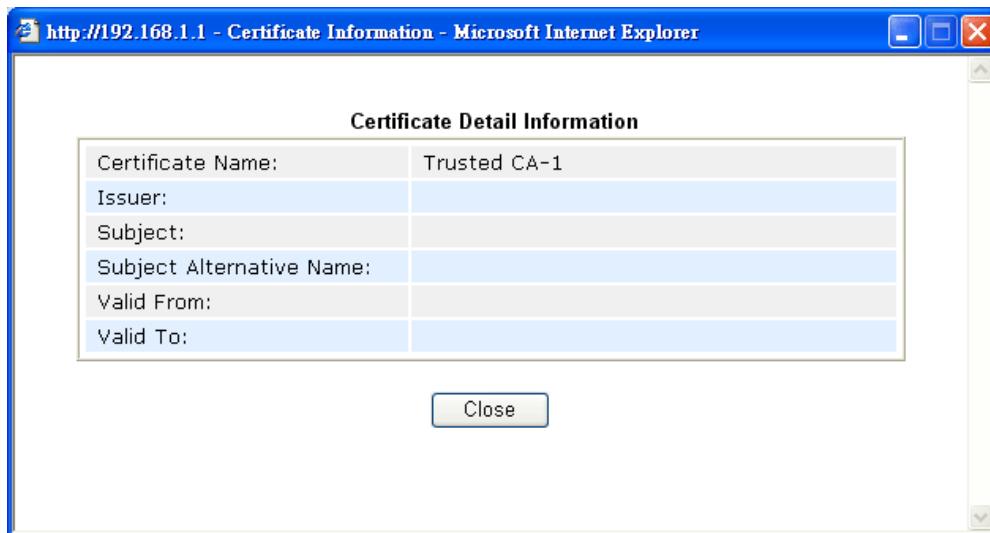

3.12.3 Certificate Backup

Local certificate and Trusted CA certificate for this router can be saved within one file. Please click **Backup** on the following screen to save them. If you want to set encryption password for these certificates, please type characters in both fields of **Encrypt password** and **Retype password**.

Also, you can use **Restore** to retrieve these two settings to the router whenever you want.

Certificate Management >> Certificate Backup

Certificate Backup / Restoration

Backup

Encrypt password:

Retype password:

Click to download certificates to your local PC as a file.

Restoration

Select a backup file to restore.

Decrypt password:

Click to upload the file.

3.13 ISDN

3.13.1 Basic Concept

ISDN means integrated services digital network that is an international communications standard for sending voice, video, and data over digital telephone lines or normal telephone wires.

Below shows the menu items for ISDN.

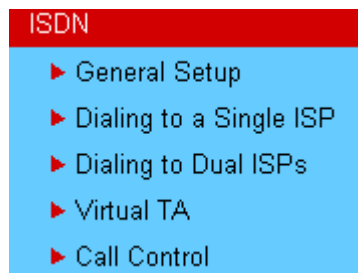

3.13.2 General Settings

This web page allows you to enable wireless LAN function.

ISDN >> General Setup

ISDN Setup

ISDN Port <input checked="" type="radio"/> Enable <input type="radio"/> Disable	Blocked MSN numbers for the router
Country Code <input type="text" value="International"/>	1. <input type="text"/>
Own Number <input type="text"/>	2. <input type="text"/>
"Own Number" means that the router will tell the remote end the ISDN number when it's placing an outgoing call.	3. <input type="text"/>
MSN numbers for the router	4. <input type="text"/>
1. <input type="text"/>	5. <input type="text"/>
2. <input type="text"/>	
3. <input type="text"/>	
"MSN Numbers" means that the router is able to accept number-matched incoming calls. In addition, MSN service should be supported by the local ISDN network provider.	

ISDN Port

Click **Enable** to open the ISDN port and **Disable** to close it.

Country Code

For proper operation on your local ISDN network, you should choose the correct country code.

Own Number

Enter your ISDN number that you got from ISDN service provider (To have such number, you have offer your request from ISDN service provider first). Every outgoing call will carry the number to the receiver.

MSN Numbers for the Router

MSN Numbers mean that the router is able to accept only number-matched incoming calls. In addition, local ISDN network provider should support MSN services. The router provides three fields for MSN numbers. Note that MSN services must be acquired from your local telecom operators. By default, MSN function is disabled. If you leave the fields blank, all incoming calls will be accepted without number matching.

1,2,3 fields – Fill in the portion that is different with the own number.

For example, the own number is **1234567** and three MSN numbers are **1234550**, **1234517** and **1234582** respectively. You can type in **1234567** in the filed of own number. Fill in **50**, **17** and **67** on the fields of 1,2 and 3 one by one without typing 12345.

Blocked MSN Numbers for the router

Enter the specified MSN number into the fields to prevent the router from dialing the specific MSN number

3.13.3 Dial to Single/Dual ISPs

Select **Dialing to a Single ISP** if you access the Internet via a single ISP.

ISDN >> Dialing to a Single ISP

Single ISP

ISP Access Setup	PPP/MP Setup
ISP Name <input type="text"/>	Link Type <input type="text" value="Dialup BOD"/>
Dial Number <input type="text"/>	PPP Authentication <input type="text" value="PAP or CHAP"/>
Username <input type="text"/>	Idle Timeout <input type="text" value="180"/> second(s)
Password <input type="text"/>	IP Address Assignment Method (IPCP)
<input type="checkbox"/> Require ISP callback (CBCP)	Fixed IP <input type="radio"/> Yes <input checked="" type="radio"/> No (Dynamic IP)
Index(1-15) in Schedule Setup:	Fixed IP Address <input type="text"/>
=> <input type="text"/> , <input type="text"/> , <input type="text"/> , <input type="text"/>	

ISP Access Setup

ISP Name - Enter your ISP name such as Seednet, Hinet, and so on.

Dial Number - Enter the ISDN access number provided by your ISP.

Username - Enter the username provided by your ISP.

Password - Enter the password provided by your ISP.

Require ISP Callback (CBCP) - If your ISP supports the callback function, check this box to activate the Callback Control Protocol during the PPP negotiation.

Scheduler (1-15) - Enter the index of schedule profiles to control the Internet access according to the preconfigured schedules. Refer to section 3.7.2 **Schedule** for detailed configuration.

PPP/MP Setup

Link Type - There are three link types provided here for different purpose. **Link Disable** disables the ISDN dial-out function. **Dialup 64Kbps** allows you to use one ISDN B channel for Internet access. **Dialup 128Kbps** allows you to use both ISDN B channels for Internet access. **Dialup BOD** (for detailed information of configuration, please refer to section 3.10.5) stands for bandwidth-on-demand. The router will use only one B channel in low traffic situations. Once the single B channel bandwidth is fully used, the other B channel will be activated automatically through the dialup. For more detailed BOD parameter settings, please refer to the section of **Call Control**.

PPP Authentication - PAP only allows you to configure the PPP session to use the PAP protocol to negotiate the username and password with the ISP. **PAP or CHAP** is to configure the PPP session to use the PAP or CHAP protocols to negotiate the username and password with the ISP.

Idle Timeout - Idle timeout means the router will be disconnect after being idle for a preset amount of time. The default is 180 seconds. If you set the time to 0, the ISDN connection to the ISP will always remain on.

IP Address Assignment

In most environments, you should not change these settings as

Method (IPCP)

most ISPs provide a dynamic IP address for the router when it connects to the ISP. If your ISP provides a fixed IP address, check **Yes** and enter the IP address in the field of **Fixed IP Address**.

Select **Dialing to Dual ISPs** if you have more than one ISP. You will be able to dial to both ISPs at the same time. This is mainly for those ISPs that do not support Multiple-Link PPP (ML-PPP). In such cases, dialing to two ISPs can increase the bandwidth utilization of the ISDN channels to 128kbps data speed.

ISDN >> Dialing to Dual ISPs

Dual ISP

Common Settings 1. <input type="checkbox"/> Enable Dual ISPs Function 2. <input type="checkbox"/> Require ISP callback (CBCP)	PPP/MP Setup Link Type: <input type="text" value="Dialup BOD"/> PPP Authentication: <input type="text" value="PAP or CHAP"/> Idle Timeout: <input type="text" value="180"/> second(s)
Primary ISP Setup ISP Name: <input type="text"/> Dial Number: <input type="text"/> Username: <input type="text"/> Password: <input type="text"/> IP Address Assignment Method (IPCP) Fixed IP: <input type="radio"/> Yes <input checked="" type="radio"/> No (Dynamic IP) Fixed IP Address: <input type="text"/>	Secondary ISP Setup ISP Name: <input type="text"/> Dial Number: <input type="text"/> Username: <input type="text" value="84005755@hinet.net"/> Password: <input type="text" value="....."/> IP Address Assignment Method (IPCP) Fixed IP: <input type="radio"/> Yes <input checked="" type="radio"/> No (Dynamic IP) Fixed IP Address: <input type="text"/>

OK

Common Settings

Enable Dual ISPs Function - Check to enable the Dual ISPs function. **Require ISP Callback (CBCP)** -If your ISP supports the callback function, check this box to activate the Callback Control Protocol during the PPP negotiation.

PPP/MP Setup

Link Type – There are three link types provided here for different purpose. **Link Disable** disables the ISDN dial-out function. **Dialup 128Kbps** allows you to use both ISDN B channels for Internet access. **Dialup BOD** (for detailed information of configuration, please refer to section 3.10.5) stands for bandwidth-on-demand. The router will use only one B channel in low traffic situations. Once the single B channel bandwidth is fully used, the other B channel will be activated automatically through the dialup.

PPP Authentication - PAP only allows you to configure the PPP session to use the PAP protocol to negotiate the username and password with the ISP. **PAP or CHAP** can configure the PPP session to use the PAP or CHAP protocols to negotiate the username and password with the ISP.

Idle Timeout - Idle timeout means the router will be disconnect after being idle for a preset amount of time. The default is 180 seconds. If you set the time to 0, the ISDN connection to the ISP will always remain on.

Primary ISP Setup

ISP Name - Enter your ISP name.

Dial Number - Enter the ISDN access number provided by your ISP.

Username - Enter the username provided by your ISP.

Password - Enter the password provided by your ISP.

IP Address Assignment Method (IPCP) for primary ISP setup

In most environments, you should not change these settings as most ISPs provide a dynamic IP address for the router when it connects to the ISP. If your ISP provides a fixed IP address, check **Yes** and enter the IP address in the field of **Fixed IP Address**.

Secondary ISP Setup)

ISP Name - Enter the secondary ISP name.

Dial Number - Enter the ISDN access number provided by the ISP.

Username - Enter the username provided by your ISP.

Password - Enter the password provided by your ISP.

IP Address Assignment Method (IPCP) for secondary ISP setup

In most environments, you should not change these settings as most ISPs provide a dynamic IP address for the router when it connects to the ISP. If your ISP provides a fixed IP address, check **Yes** and enter the IP address in the field of **Fixed IP Address**.

After entering the necessary settings and clicking **OK**, you will see **Goto ISDN Diagnostic** link appears on the bottom of the webpage. To have an ISDN connection, please click this link.

ISDN >> Dialing to a Single ISP

Active Configuration	
ISP Access Setup	PPP/MP Setup
ISP Name <input type="text"/>	Link Type <input type="text" value="Dialup BOD"/>
Dial Number <input type="text" value="30"/>	PPP Authentication <input type="text" value="PAP or CHAP"/>
Username <input type="text" value="vivian"/>	Idle Timeout 180 second(s)
Password <input type="password" value="•••••"/>	IP Address Assignment Method (IPCP)
<input type="checkbox"/> Require ISP callback	Fixed IP <input type="radio"/> Yes <input checked="" type="radio"/> No (Dynamic IP)
Index(1-15) in Schedule Setup:	Fixed IP Address
=> <input type="text"/> , <input type="text"/> , <input type="text"/> , <input type="text"/>	
>> Goto ISDN Diagnostic	

Now, the system will guide you to click **Dial ISDN**. Wait for a moment after clicking the dial link. Then, a successful ISDN connection will be shown as the following.

Online Status

System Status				System Uptime: 0:5:33			
LAN Status		Primary DNS: 168.95.192.1		Secondary DNS: 168.95.1.1			
IP Address		TX Packets	RX Packets				
192.168.1.1		1459	1426				
WAN 1 Status				>> Renew			
Enable	Line	Name	Mode	Up Time			
Yes	Ethernet		DHCP Client	00:00:00			
IP	GW IP	TX Packets	TX Rate(Bps)	RX Packets	RX Rate(Bps)		
---	---	0	0	0	0		
WAN 2 Status							
Enable	Line	Name	Mode	Up Time			
Yes	Ethernet		---	00:00:00			
IP	GW IP	TX Packets	TX Rate(Bps)	RX Packets	RX Rate(Bps)		
---	---	0	0	0	0		
ISDN Status				>> Dial ISDN >> Drop B1 >> Drop B2			
Channel	Active Connection	TX Pkts	TX Rate (Bps)	RX Pkts	RX Rate (Bps)	Up Time	AOC
B1	[218.173.161.212]	86	3	86	15	0:2:4	0
B2	Idle [---]	0	0	0	0	0:0:0	0
ISDN2-D		UP					

3.13.4 Virtual TA

Virtual TA means the local hosts or PCs in the network that uses popular CAPI-based software such as RVS-COM or BVRP to access the router as a local ISDN TA for sending or receiving FAX messages over the ISDN line. Basically, it is a client/server network model. The built-in Virtual TA server handles the establishment and release of connections. The Virtual TA client, which is installed on the local hosts or PCs, creates a CAPI-based driver to relay all CAPI messages between the applications and the router CAPI module. Before describing the configuration of **Virtual TA** in the Vigor routers, please notice the following limitations.

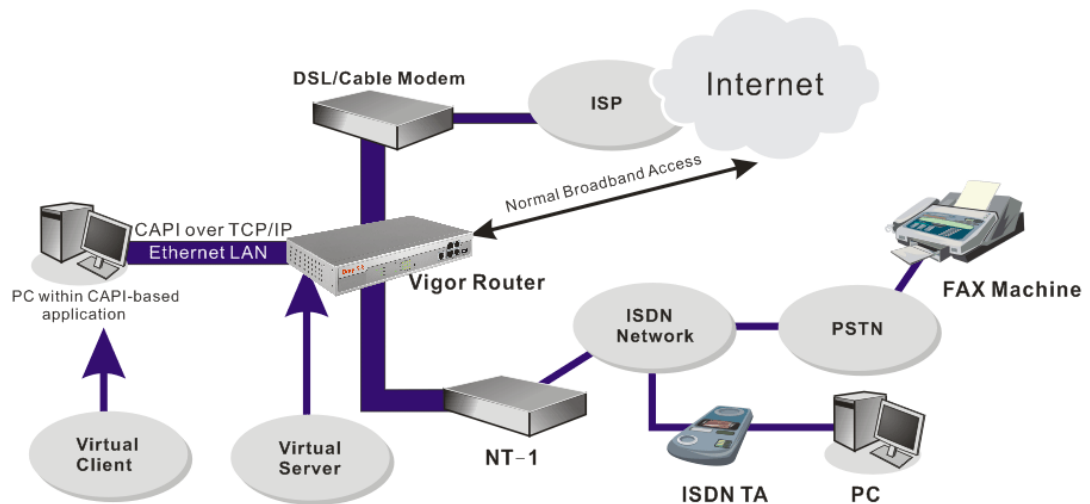

As depicted in the above application scenario, the Virtual TA client can make an outgoing call or accept an incoming call to/from a peer FAX machine or ISDN TA, etc. Click the **Virtual TA(Remote CAPI) Setup** tab in the **Quick Setup** field to configure the Virtual TA features.

Before describing the configuration of Virtual TA in the Vigor routers, please heed the following limitations.

- The Virtual TA client only supports Microsoft™ Windows 98/SE/2000/XP platforms.

- The Virtual TA client only supports the CAPI 2.0 protocol and has no built-in FAX engine.
- One ISDN BRI interface has two B channels. The maximum number of active clients is also 2.
- Before you configure the Virtual TA, you must set the correct country code in **ISDN Setup**.

ISDN >> Virtual TA

Virtual TA Setup

Virtual TA Server : Enable Disable

Virtual TA Users Profiles

	Username	Password	MSN1	MSN2	MSN3	Active
1.	<input type="text"/>	<input type="text"/>	<input type="text"/>	<input type="text"/>	<input type="text"/>	<input type="checkbox"/>
2.	<input type="text"/>	<input type="text"/>	<input type="text"/>	<input type="text"/>	<input type="text"/>	<input type="checkbox"/>
3.	<input type="text"/>	<input type="text"/>	<input type="text"/>	<input type="text"/>	<input type="text"/>	<input type="checkbox"/>
4.	<input type="text"/>	<input type="text"/>	<input type="text"/>	<input type="text"/>	<input type="text"/>	<input type="checkbox"/>
5.	<input type="text"/>	<input type="text"/>	<input type="text"/>	<input type="text"/>	<input type="text"/>	<input type="checkbox"/>

Virtual TA Server

Enable - Select it to activate the server.

Disable - Select it to deactivate the server. All Virtual TA applications will be terminated.

Virtual TA User Profiles

Username - Enter the username of a specific client.

Password - Enter the password of a specific client.

MSN 1/2/3 - MSN stands for Multiple Subscriber Number. It means you can apply to more than one ISDN lines number over a single subscribed line. Note that the service must be acquired from your telecom. Specify the MSN numbers for a specific client. If you have no MSN services, leave this field blank.

Active - Check it to enable the client to access the server.

Install a Virtual TA Client

1. Insert the CD-ROM bundled with your Vigor router. Find **VTA Client** tool in the Utility menu and click on the Install button.
2. Follow the on-screen instructions of the installer. The last step will ask you to restart your computer. Click **OK** to restart your computer.
3. After the computer restarts, you will see a VT icon in the taskbar (usually in the bottom-right of the screen, near the clock) as shown below.

When the icon text is GREEN, the Virtual TA client is connected to the Virtual TA server and you can launch your CAPI-based software to use the client to access the router. If the icon text is RED, it means the client has lost the connection to the server. This time, please check the physical Ethernet connection.



Configure a Virtual TA Client/ Server

Since the Virtual TA application is a client/server network model, you must configure it on both ends to run properly your Virtual TA application.

By default, the Virtual TA server is enabled and the Username/Password fields are left blank. Any Virtual TA client may login to the server. Once a single Username/Password field has been filled in, the Virtual TA server will only allow clients with a valid Username/Password to login. The screen of Virtual TA configuration is presented below.

User Profile

Note that creating a single user access account will limit the access to the Virtual TA server to only the specified account holders.

Assume you did not acquire any MSN service from your ISDN network provider.

On the server - Click **Virtual TA (Remote CAPI) Setup** link, and fill in the Username and Password fields. Check the **Active** box to enable the account.

	Username	Password	MSN1	MSN2	MSN3	Active
1.	Jack	••••				<input checked="" type="checkbox"/>

On the client - Right-click the mouse on the VT icon. The following pop-up menu will be shown.

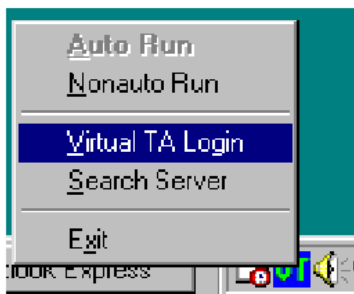

Click the **Virtual TA Login** tab to launch the login box.

Virtual TA Login

User Name : alan

Password : xxxx

OK Cancel

Enter the Username/Password and then click **OK**. After a short time, the VT icon text will turn green.

MSN Configuration

If you have applied to an MSN number service, the Virtual TA server can assign which client has the specified MSN number. When an incoming call arrives, the server will inform the appropriate client. Now we set an example to describe the configuration of the MSN number.

Suppose that you could assign the MSN number **123** to the client “Jack”.

Virtual TA Setup

Virtual TA Server : Enable Disable

Virtual TA Users Profiles

	Username	Password	MSN1	MSN2	MSN3	Active
1.	Jack	••••	123			<input checked="" type="checkbox"/>

Type the specified MSN number in the CAPI-based software. When the Virtual TA server sends an alert signal to the specified Virtual TA client, the CAPI-based software will also receive the action, the software will not accept the incoming call.

3.13.5 Call Control

Some applications require that the router (only for the ISDN models) be remotely activated, or be able to dial up to the ISP via the ISDN interface. Vigor routers provide this feature by allowing user to make a phone call to the router and then ask it to dial up to the ISP.

Accordingly, a teleworker can access the remote network to retrieve resources. Of course, a fixed IP address is required for WAN connection and some internal network resource has to be exposed for remote users, such as FTP, WWW.

ISDN >> Call Control

Call Control Setup

Dial Retry	<input type="text" value="0"/> times	Remote Activation	<input type="text"/>
Dial Delay Interval	<input type="text" value="0"/> second(s)		

PPP/MP Dial-Out Setup

Basic Setup		Bandwidth On Demand (BOD) Setup	
Link Type	<input type="text" value="Dialup BOD"/> ▼	High Water Mark	<input type="text" value="7000"/> cps
PPP Authentication	<input type="text" value="PAP or CHAP"/> ▼	High Water Time	<input type="text" value="30"/> second(s)
TCP Header Compression	<input type="text" value="None"/> ▼	Low Water Mark	<input type="text" value="6000"/> cps
Idle Timeout	<input type="text" value="180"/> second(s)	Low Water Time	<input type="text" value="30"/> second(s)

Call Control Setup

Dial Retry - It specifies the dial retry counts per triggered packet. A triggered packet is the packet whose destination is outside the local network. The default setting is no dial retry. If set to 5, for each triggered packet, the router will dial 5 times until it is connected to the ISP or remote access router.

Dial Delay Interval - It specifies the interval between dialup retries. By default, the interval is 0 second.

Remote Activation – It can help users who would like to access the server which is off the Internet in the head office. To remotely make the server to be available on the Internet, i.e. make the router in the head office activating its Internet access either by dialing-up or starting broadband connection, users can make a regular phone call (the number is set in the Remote Activation field) to the router as signaling it for

activation. The phone call will be soon disconnected once the router is on line.

Note: Dialing to a Single ISP should be pre-configured properly.

Basic Setup

Link Type - Because ISDN has two B channels (64Kbps/per channel), you can specify whether you would like to have single B channel, two B channels or BOD (Bandwidth on Demand). Four options are available: Link Disable, Dialup 64Kbps, Dialup 128Kbps, Dialup BOD.

Link Type

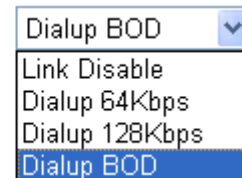

PPP Authentication - It specifies the PPP authentication method for PPP/MP connections. Normally you can set it to PAP/CHAP for better compatibility.

TCP Header Compression - VJ Compression: It is used for TCP/IP protocol header compression. Normally it is set to Yes to improve bandwidth utilization.

Idle Timeout - Because our ISDN link type is **Dial On Demand**, the connection will be initiated only when needed.

Bandwidth-On-Demand (BOD) Setup

Bandwidth-On-Demand is for Multiple-Link PPP (ML-PPP or MP). The parameters are only applied when you set the **Link Type to Dialup BOD**. The ISDN usually use one B channel to access the Internet or remote network when you choose the Dialup BOD link type. The router will use the parameters here to decide on when you activate/drop the additional B channel. Note that **cps** (characters-per-second) measures the total link utilization.

High Water Mark and High Water Time - These parameters specify the situation in which the second channel will be activated. With the first connected channel, if its utilization exceeds the High Water Mark and such a channel is being used over the High Water Time, the additional channel will be activated. Thus, the total link speed will be 128kbps (two B channels).

Low Water Mark and Low Water Time - These parameters specify the situation in which the second channel will be dropped. In terms of the two B channels, if their utilization is under the Low Water Mark and these two channels are being used over the High Water Time, the additional channel will be dropped. As a result, the total link speed will be 64kbps (one B channel).

3.14 Wireless LAN

This function is used for **G** models only.

3.14.1 Basic Concepts

Over recent years, the market for wireless communications has enjoyed tremendous growth. Wireless technology now reaches or is capable of reaching virtually every location on the surface of the earth. Hundreds of millions of people exchange information every day via wireless communication products. The Vigor G model, a.k.a. Vigor wireless router, is designed for maximum flexibility and efficiency of a small office/home. Any authorized staff can bring a built-in WLAN client PDA or notebook into a meeting room for conference without laying a clot of LAN cable or drilling holes everywhere. Wireless LAN enables high mobility so WLAN users can simultaneously access all LAN facilities just like on a wired LAN as well as Internet access.

The Vigor wireless routers are equipped with a wireless LAN interface compliant with the standard IEEE 802.11g protocol. To boost its performance further, the Vigor Router is also loaded with advanced wireless technology Super G™ to lift up data rate up to 108 Mbps*. Hence, you can finally smoothly enjoy stream music and video.

Note: * The actual data throughput will vary according to the network conditions and environmental factors, including volume of network traffic, network overhead and building materials.

In an Infrastructure Mode of wireless network, Vigor wireless router plays a role as an Access Point (AP) connecting to lots of wireless clients or Stations (STA). All the STAs will share the same Internet connection via Vigor wireless router. The **General Settings** will set up the information of this wireless network, including its SSID as identification, located channel etc.

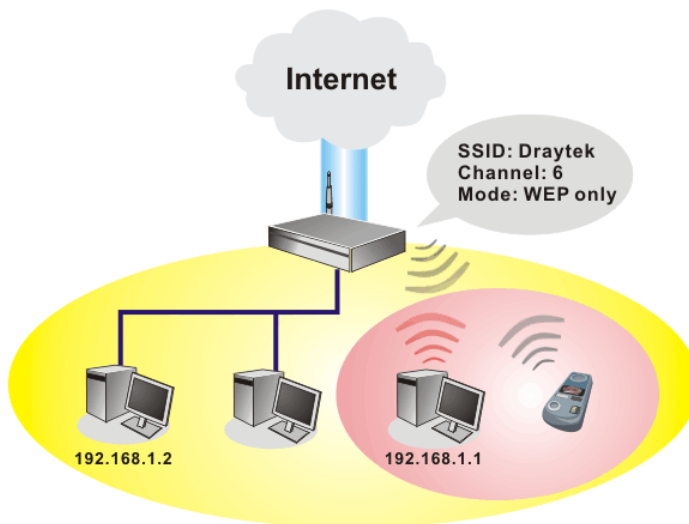

Security Overview

Real-time Hardware Encryption: Vigor Router is equipped with a hardware AES encryption engine so it can apply the highest protection to your data without influencing user experience.

Complete Security Standard Selection: To ensure the security and privacy of your wireless communication, we provide several prevailing standards on market.

WEP (Wired Equivalent Privacy) is a legacy method to encrypt each frame transmitted via radio using either a 64-bit or 128-bit key. Usually access point will preset a set of four keys and it will communicate with each station using only one out of the four keys.

WPA(Wi-Fi Protected Access), the most dominating security mechanism in industry, is separated into two categories: WPA-personal or called WPA Pre-Share Key (WPA/PSK), and WPA-Enterprise or called WPA/802.1x.

In WPA-Personal, a pre-defined key is used for encryption during data transmission. WPA applies Temporal Key Integrity Protocol (TKIP) for data encryption while WPA2 applies AES. The WPA-Enterprise combines not only encryption but also authentication.

Since WEP has been proved vulnerable, you may consider using WPA for the most secure connection. You should select the appropriate security mechanism according to your needs. No matter which security suite you select, they all will enhance the over-the-air data protection and /or privacy on your wireless network. The Vigor wireless router is very flexible and can support multiple secure connections with both WEP and WPA at the same time.

Example 1

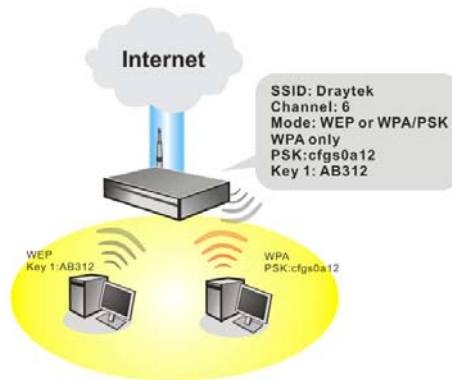

Example 2



Example 3

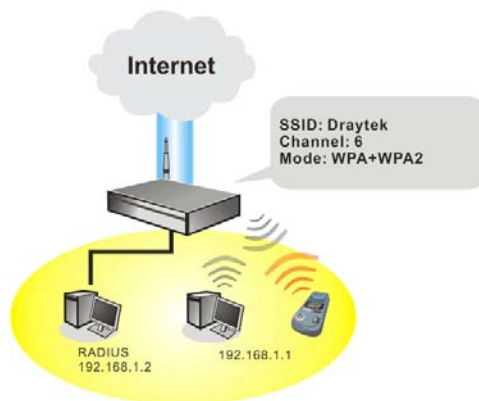

Separate the Wireless and the Wired LAN- WLAN Isolation enables you to isolate your wireless LAN from wired LAN for either quarantine or limit access reasons. To isolate means neither of the parties can access each other. To elaborate an example for business use, you may set up a wireless LAN for visitors only so they can connect to Internet without hassle of the confidential information leakage. For a more flexible deployment, you may add filters of MAC addresses to isolate users' access from wired LAN.

Manage Wireless Stations - Station List will display all the station in your wireless network and the status of their connection.

Below shows the menu items for Wireless LAN.

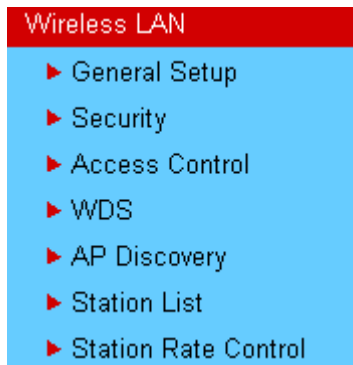

3.14.2 General Setup

By clicking the **General Settings**, a new web page will appear so that you could configure the SSID and the wireless channel. Please refer to the following figure for more information.

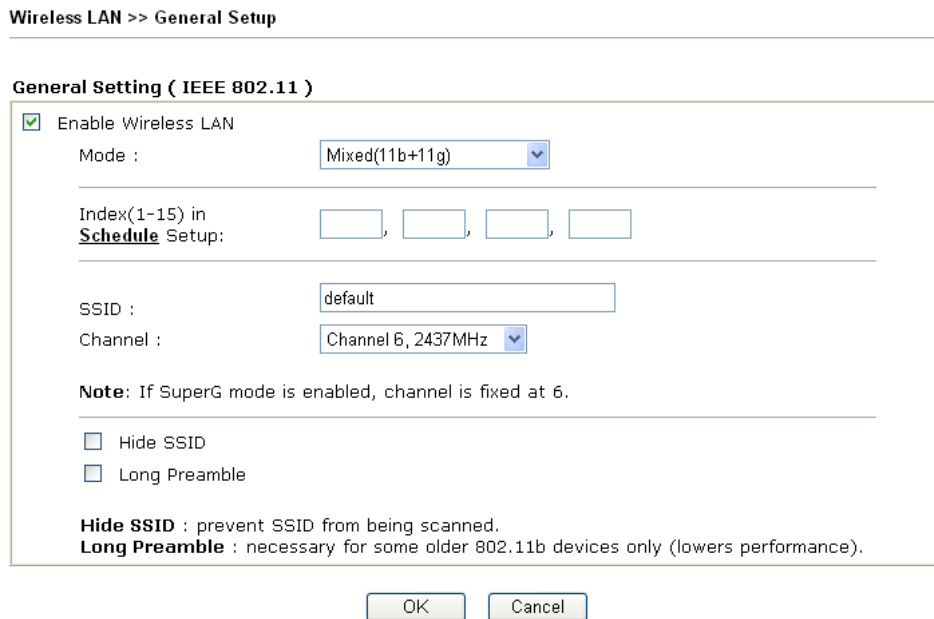

Enable Wireless LAN

Check the box to enable wireless function.

Mode

Select an appropriate wireless mode.

Mixed (11b+11g+SuperG) - The radio can support IEEE802.11b, IEEE802.11g and SuperG protocols simultaneously.

Mixed (11b+11g) - The radio can support both IEEE802.11b and IEEE802.11g protocols simultaneously.

SuperG - The radio only supports SuperG.

11g only - The radio only supports IEEE802.11g.

11b only - The radio only supports IEEE802.11b.

Mode :

Mixed(11b+11g)	▼
Mixed(11b+11g+SuperG)	
Mixed(11b+11g)	
SuperG Only	
11g Only	
11b Only	

Index (1-15)

Set the wireless LAN to work at certain time interval only. You may choose up to 4 schedules out of the 15 schedules pre-defined in **Applications >> Schedule** setup. The default setting of this filed is blank and the function will always work.

SSID

The default SSID is "default". We suggest you change it to a particular name. It is the identification of the wireless LAN. SSID can be any text numbers or various special characters.

Channel

The channel of frequency of the wireless LAN. The default channel is 6. You may switch channel if the selected channel is under serious interference.

Channel :

Channel 6, 2437MHz	▼
Channel 1, 2412MHz	
Channel 2, 2417MHz	
Channel 3, 2422MHz	
Channel 4, 2427MHz	
Channel 5, 2432MHz	
Channel 6, 2437MHz	
Channel 7, 2442MHz	
Channel 8, 2447MHz	
Channel 9, 2452MHz	
Channel 10, 2457MHz	
Channel 11, 2462MHz	
Channel 12, 2467MHz	
Channel 13, 2472MHz	

Hide SSID

Check it to prevent from wireless sniffing and make it harder for unauthorized clients or STAs to join your wireless LAN. Depending on the wireless utility, the user may only see the information except SSID or just cannot see any thing about Vigor wireless router while site surveying.

Long Preamble

This option is to define the length of the sync field in an 802.11 packet. Most modern wireless network uses short preamble with 56 bit sync filed instead of long preamble with 128 bit sync field. However, some original 11b wireless network devices only support long preamble. Check it to use **Long Preamble** if needed to communicate with this kind of devices.

3.14.3 Security

By clicking the **Security Settings**, a new web page will appear so that you could configure the settings of WEP and WPA.

Wireless LAN >> Security Settings

Security Settings

Mode :

Set up **RADIUS Server** if 802.1x is enabled.

WPA:
 Type: Mixed(WPA+WPA2) WPA2 Only

Pre-Shared Key(PSK)
 Type 8~63 ASCII character or 64 Hexadecimal digits leading by "0x", for example "cfigs01a2..." or "0x655abcd..."

WEP:
 Encryption Mode:

Use WEP Key

Key 1 :

Key 2 :

Key 3 :

Key 4 :

For 64 bit WEP key
 Type 5 ASCII character or 10 Hexadecimal digits leading by "0x", for example "AB312" or "0x4142333132".

For 128 bit WEP key
 Type 13 ASCII character or 26 Hexadecimal digits leading by "0x", for example "0123456789abc" or "0x30313233343536373839414243".

Mode

There are several modes provided for you to choose.

Mode :

-
- Disable
- WEP Only**
- WEP/802.1x Only
- WEP or WPA/PSK
- WEP/802.1x or WPA/802.1x
- WPA/PSK Only
- WPA/802.1x Only

Disable - Turn off the encryption mechanism.

WEP Only - Accept only WEP clients and the encryption key should be entered in WEP Key.

WEP/802.1x Only - Accept WEP clients with 802.1x authentication. Since the key will be auto-negotiated during authentication, the field of key setting below will be not available for input.

WEP or WPA/PSK - Accept WEP and WPA clients with legal key accordingly. Only Mixed (WPA+WPA2) is applicable if you select WPA/PSK.

WEP/802.1x or WPA/802.1x - Accept WEP or WPA clients with 802.1x authentication. Only Mixed (WPA+WPA2) is applicable if you select WPA/PSK. Since the key will be auto-negotiated during authentication, the field of key setting below will be not available for input.

WPA/PSK Only - Accept WPA clients and the encryption key should be entered in PSK. Remember to select WPA type to define either Mixed or WPA2 only in the field below.

WPA/802.1x Only - Accept WPA clients with 802.1x authentication. Remember to select WPA type to define either Mixed or WPA2 only in the field below. Since the key will be

auto-negotiated during authentication, the field of key setting below will be not available for input.

WPA

The WPA encrypts each frame transmitted from the radio using the key, which either PSK entered manually in this field below or automatically negotiated via 802.1x authentication.

Type - Select from Mixed (WPA+WPA2) or WPA2 only.

Pre-Shared Key (PSK) - Either **8~63** ASCII characters, such as 012345678..(or 64 Hexadecimal digits leading by 0x, such as "0x321253abcde...").

WEP

64-Bit - For 64 bits WEP key, either **5** ASCII characters, such as 12345 (or 10 hexadecimal digitals leading by 0x, such as 0x4142434445.)

128-Bit - For 128 bits WEP key, either **13** ASCII characters, such as ABCDEFGHIJKLM (or 26 hexadecimal digits leading by 0x, such as 0x4142434445464748494A4B4C4D).

Encryption Mode:

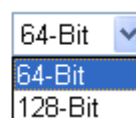

A dropdown menu with three options: 64-Bit (selected), 64-Bit, and 128-Bit.

All wireless devices must support the same WEP encryption bit size and have the same key. Four keys can be entered here, but only one key can be selected at a time. The keys can be entered in ASCII or Hexadecimal. Check the key you wish to use.

3.14.4 Access Control

For additional security of wireless access, the **Access Control** facility allows you to restrict the network access right by controlling the wireless LAN MAC address of client. Only the valid MAC address that has been configured can access the wireless LAN interface. By clicking the **Access Control**, a new web page will appear, as depicted below, so that you could edit the clients' MAC addresses to control their access rights.

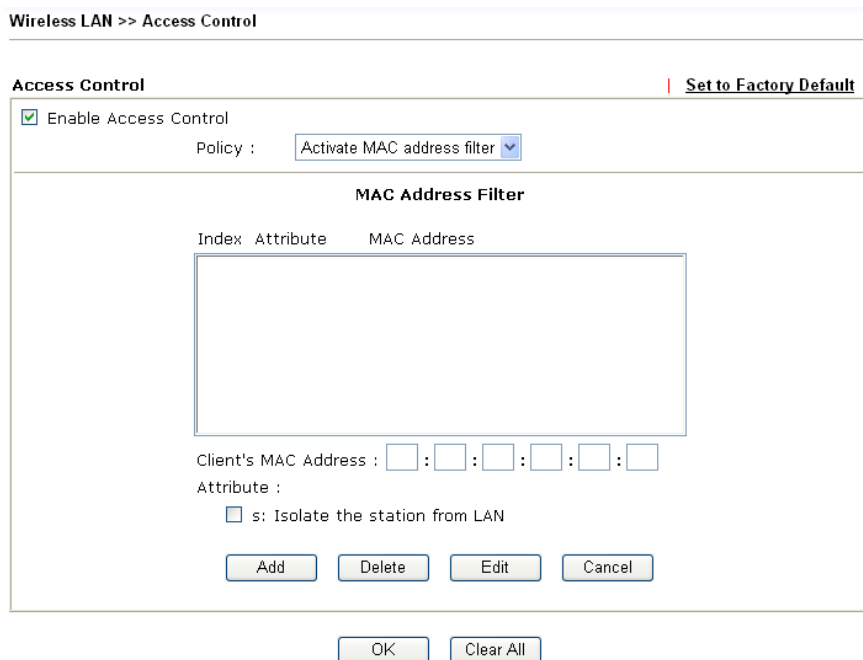

The screenshot shows the 'Wireless LAN >> Access Control' web page. It features a 'Set to Factory Default' link. The 'Enable Access Control' checkbox is checked. The 'Policy' dropdown is set to 'Activate MAC address filter'. Below this is a 'MAC Address Filter' table with columns for 'Index', 'Attribute', and 'MAC Address'. The table is currently empty. Below the table, there are input fields for 'Client's MAC Address' (six boxes) and 'Attribute' (checkboxes for 's: Isolate the station from LAN'). At the bottom of the table area are 'Add', 'Delete', 'Edit', and 'Cancel' buttons. Below the entire form are 'OK' and 'Clear All' buttons.

Enable Access Control

Select to enable the MAC Address access control feature.

Policy

Select to enable any one of the following policy. Choose **Activate MAC address filter** to type in the MAC

addresses for other clients in the network manually. Choose **Isolate WLAN from LAN** will separate all the WLAN stations from LAN based on the MAC Address list.

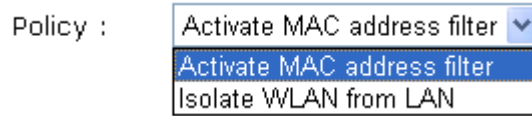

MAC Address Filter

Display all MAC addresses that are edited before. Four buttons (Add, Remove, **Client's MAC Address** - Manually enter the MAC address of wireless client.

Attribute

s - select to isolate the wireless connection of the wireless client of the MAC address from LAN.

Add

Add a new MAC address into the list.

Delete

Delete the selected MAC address in the list.

Edit

Edit the selected MAC address in the list.

Cancel

Give up the access control set up.

OK

Click it to save the access control list.

Clear All

Clean all entries in the MAC address list.

3.14.5 WDS

WDS means Wireless Distribution System. It is a protocol for connecting two access points (AP) wirelessly. Usually, it can be used for the following application:

- Provide bridge traffic between two LANs through the air.
- Extend the coverage range of a WLAN.

To meet the above requirement, two WDS modes are implemented in Vigor router. One is **Bridge**, the other is **Repeater**. Below shows the function of WDS-bridge interface:

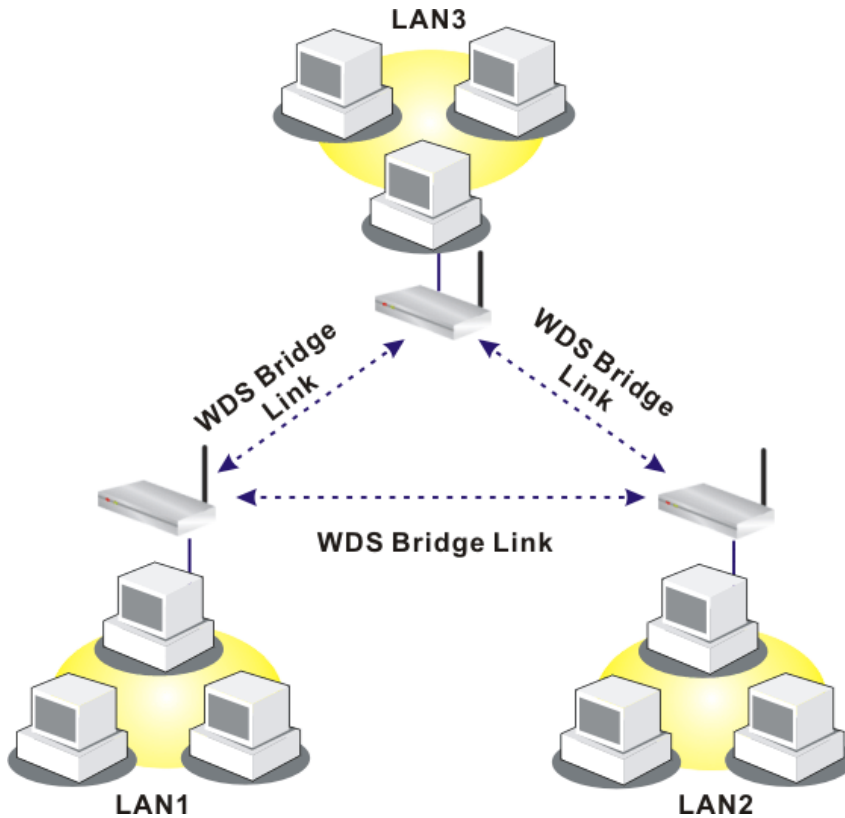

The application for the WDS-Repeater mode is depicted as below:

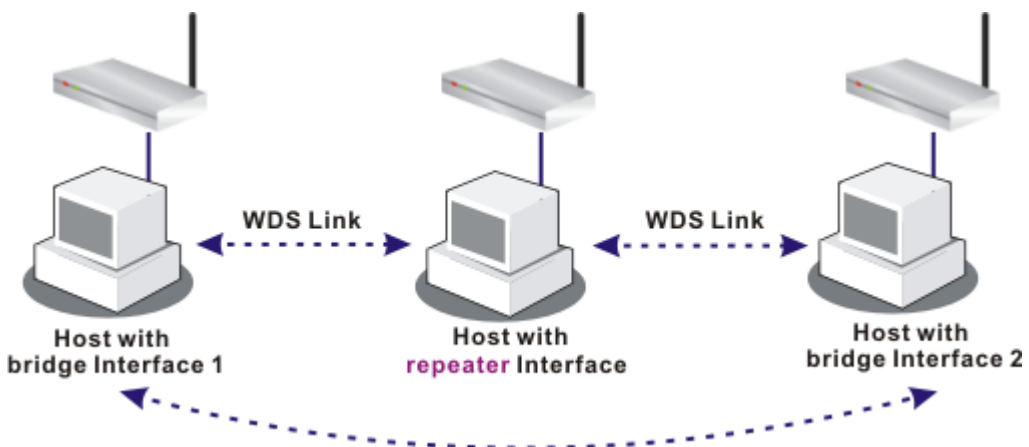

The major difference between these two modes is that: while in **Repeater** mode, the packets received from one peer AP can be repeated to another peer AP through WDS links. Yet in **Bridge** mode, packets received from a WDS link will only be forwarded to local wired or wireless hosts. In other words, only Repeater mode can do WDS-to-WDS packet forwarding.

In the following examples, hosts connected to Bridge 1 or 3 can communicate with hosts connected to Bridge 2 through WDS links. However, hosts connected to Bridge 1 CANNOT communicate with hosts connected to Bridge 3 through Bridge 2.

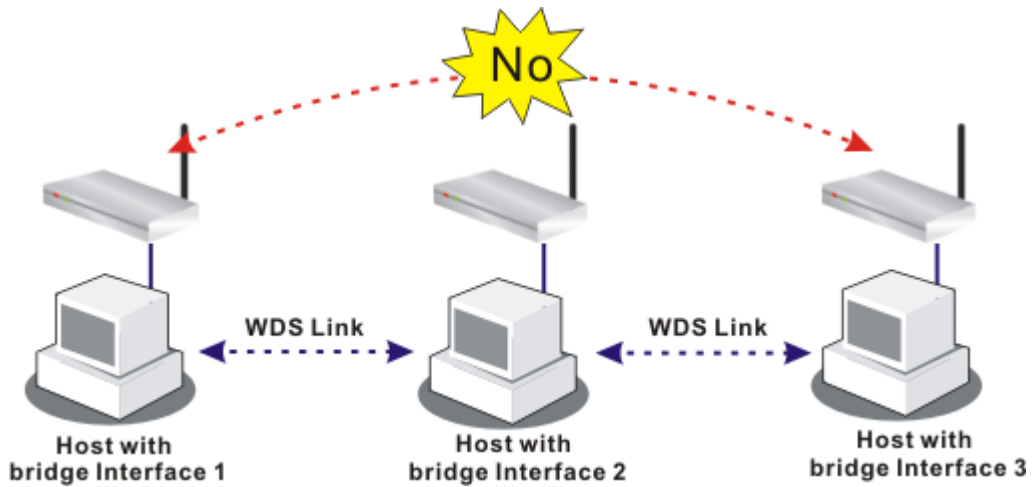

Click **WDS** from **Wireless LAN** menu. The following page will be shown.

Wireless LAN >> WDS Settings

| [Set to Factory Default](#) |

WDS Settings

Mode: Disable

Security:
 Disable WEP Pre-shared Key

WEP:
 Use the same WEP key set in [Security Settings](#).

Encryption Mode : 64-bit
 Key index : 1

The key index is fixed if the security mode is not "WEP Only".

Key : *****

The key format is the same as the one used in [Security Settings](#).

Pre-shared Key:
 Type : TKIP
 Key : *****

Type 8~63 ASCII characters or 64 hexadecimal digits leading by "0x", for example "cfgs01a2..." or "0x655abcd....".

Bridge

Enable Peer MAC Address

<input type="checkbox"/>	<input type="text"/>	:	<input type="text"/>	:	<input type="text"/>	:	<input type="text"/>	:	<input type="text"/>
<input type="checkbox"/>	<input type="text"/>	:	<input type="text"/>	:	<input type="text"/>	:	<input type="text"/>	:	<input type="text"/>
<input type="checkbox"/>	<input type="text"/>	:	<input type="text"/>	:	<input type="text"/>	:	<input type="text"/>	:	<input type="text"/>
<input type="checkbox"/>	<input type="text"/>	:	<input type="text"/>	:	<input type="text"/>	:	<input type="text"/>	:	<input type="text"/>
<input type="checkbox"/>	<input type="text"/>	:	<input type="text"/>	:	<input type="text"/>	:	<input type="text"/>	:	<input type="text"/>
<input type="checkbox"/>	<input type="text"/>	:	<input type="text"/>	:	<input type="text"/>	:	<input type="text"/>	:	<input type="text"/>

Note: Disable unused links to get better performance.

Repeater

Enable Peer MAC Address

<input type="checkbox"/>	<input type="text"/>	:	<input type="text"/>	:	<input type="text"/>	:	<input type="text"/>	:	<input type="text"/>
<input type="checkbox"/>	<input type="text"/>	:	<input type="text"/>	:	<input type="text"/>	:	<input type="text"/>	:	<input type="text"/>

Access Point Function:
 Enable Disable

Status:
 Send "Hello" message to peers.

Link Status

Note: The status is valid only when the peer also supports this function.

OK Clear Cancel

Mode

Choose the mode for WDS setting. **Disable** mode will not invoke any WDS setting. **Bridge** mode is designed to fulfill the first type of application. **Repeater** mode is for the second one.

Mode:

Disable ▾

Disable

Bridge

Repeater

Security	There are three types for security, Disable , WEP and Pre-shared key . The setting you choose here will make the following WEP or Pre-shared key field valid or not. Choose one of the types for the router.
WEP	Check this box to use the same key set in Security Settings page. If you did not set any key in Security Settings page, this check box will be dimmed. Encryption Mode - If you checked the box of Use the same WEP key ... , you do not need to choose 64-bit or 128-bit as the Encryption Mode. If you do not check that box, you can set the WEP key now in this page. Key Index - Choose the key that you want to use after selecting the proper encryption mode. Key - Type the content for the key.
Pre-shared Key	Type 8 ~ 63 ASCII characters or 64 hexadecimal digits leading by "0x".
Bridge	If you choose Bridge as the connecting mode, please type in the peer MAC address in these fields. Six peer MAC addresses are allowed to be entered in this page at one time. Yet please disable the unused link to get better performance. If you want to invoke the peer MAC address, remember to check Enable box in the front of the MAC address after typing.
Repeater	If you choose Repeater as the connecting mode, please type in the peer MAC address in these fields. Two peer MAC addresses are allowed to be entered in this page at one time. Similarly, if you want to invoke the peer MAC address, remember to check Enable box in the front of the MAC address after typing.
Access Point Function	Click Enable to make this router serving as an access point; click Disable to cancel this function.
Status	It allows user to send "hello" message to peers. Yet, it is valid only when the peer also supports this function.

3.14.6 AP Discovery

Vigor router can scan all regulatory channels and find working APs in the neighborhood. Based on the scanning result, users will know which channel is clean for usage. Also, it can be used to facilitate finding an AP for a WDS link. Notice that during the scanning process (about 5 seconds), no client is allowed to connect to Vigor.

This page is used to scan the existence of the APs on the wireless LAN. Yet, only the AP which is in the same channel of this router can be found. Please click **Scan** to discover all the connected APs.

Access Point List

BSSID	Channel	SSID

See [Statistics](#).

Note: During the scanning process (~5 seconds), no station is allowed to connect with the router.

Add to [WDS Settings](#) :

AP's MAC address : : : : :

If you want the found AP applying the WDS settings, please type in the AP's MAC address on the bottom of the page and click **Add**. Later, the MAC address of the AP will be added to the page of WDS setting.

3.14.7 Station List

Station List provides the knowledge of connecting wireless clients now along with its status code. There is a code summary below for explanation. For convenient **Access Control**, you can select a WLAN station and click **Add to Access Control** below.

Station List

Status	MAC Address

Status Codes :
C: Connected, No encryption.
E: Connected, WEP.
P: Connected, WPA.
A: Connected, WPA2.
B: Blocked by Access Control.
N: Connecting.
F: Fail to pass 802.1X or WPA/PSK authentication.

Note: After a station connects to the router successfully, it may be turned off without notice. In that case, it will still be on the list until the connection expires.

Add to [Access Control](#) :

Client's MAC address : : : : :

Refresh

Click this button to refresh the status of station list.

Add

Click this button to add current selected MAC address into **Access Control**.

3.14.8 Station Rate Control

This page allows you to control the upload and download rate of each wireless client (station). Please check the box of **Enable** to invoke this setting. The range for the rate is between 100 ~ 30,000 kbps.

Wireless LAN >> Station Rate Control

Station Rate Control

Enable

Upload Rate : 00 Kbps

Download Rate : 00 Kbps

Note:
1. Range: 100~30,000 Kbps, Increment: 100 Kbps.
2. The specified rates are applied to each associated wireless client.

3.15 VLAN

Virtual LAN function provides you a very convenient way to manage hosts by grouping them based on the physical port.

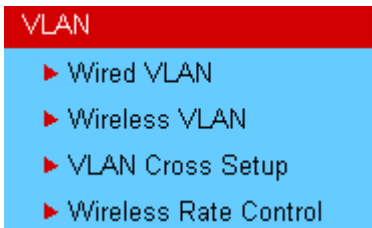

Note: This menu is available for **VigorPro5500G** model only. For VigorPro5500, please refer to 3.2.4.

3.15.1 Wired VLAN

PCs connected to Ethernet ports of the router can be divided into different groups and formed VLAN. PCs under the same groups can share each other information through the router and will not be peeked by other groups.

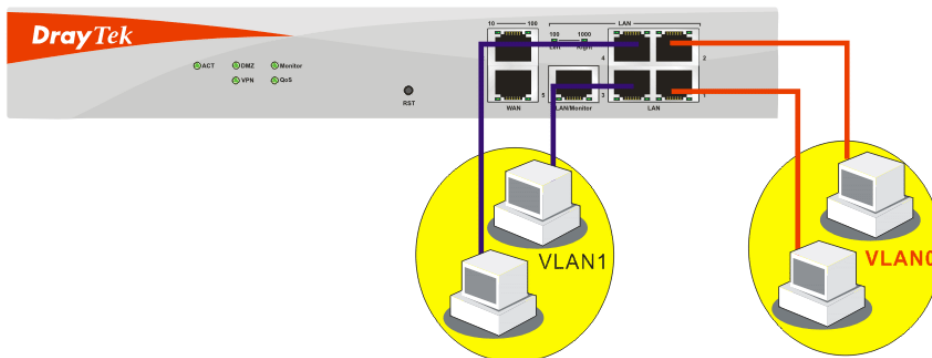

The **VLAN >> Wired VALN** allows you to configure VLAN settings through wired connection to achieve the above intention. Simply check P1 and P2 boxes on the line of VLAN0; and check P3 and P4 boxes on the line of VLAN1.

VLAN >> Wired VLAN Configuration

Wired VLAN Configuration

Enable

	P1	P2	P3	P4
VLAN0	<input checked="" type="checkbox"/>	<input checked="" type="checkbox"/>	<input type="checkbox"/>	<input type="checkbox"/>
VLAN1	<input type="checkbox"/>	<input type="checkbox"/>	<input checked="" type="checkbox"/>	<input checked="" type="checkbox"/>
VLAN2	<input type="checkbox"/>	<input type="checkbox"/>	<input type="checkbox"/>	<input type="checkbox"/>
VLAN3	<input type="checkbox"/>	<input type="checkbox"/>	<input type="checkbox"/>	<input type="checkbox"/>

OK Clear Cancel

Enable

Check this box to enable this function (for VLAN Configuration).

P1 – P4

Check the box to make the computer connecting to the port being grouped in specified VLAN. Be aware that each port can be grouped in different VLAN at the same time only if you check the box. For example, if you check the boxes of VLAN0-P1 and VLAN1-P1, you can make P1 to be grouped under VLAN0 and VLAN1 simultaneously.

VLAN0-3

This router allows you to set 4 groups of virtual LAN.

3.15.2 Wireless VLAN

PCs (equipped with wireless network cards) connected to the router through wireless interface can be divided into different groups and formed W_VLAN. PCs under the same groups can share each other information through the router and will not be peeked by other groups.

PCs under the same groups can use same Login ID and password to access into Internet. For example, see the following graphic. Both A and B use the same login ID (City) and password (1234). Therefore, they are grouped in the same W_VLAN.

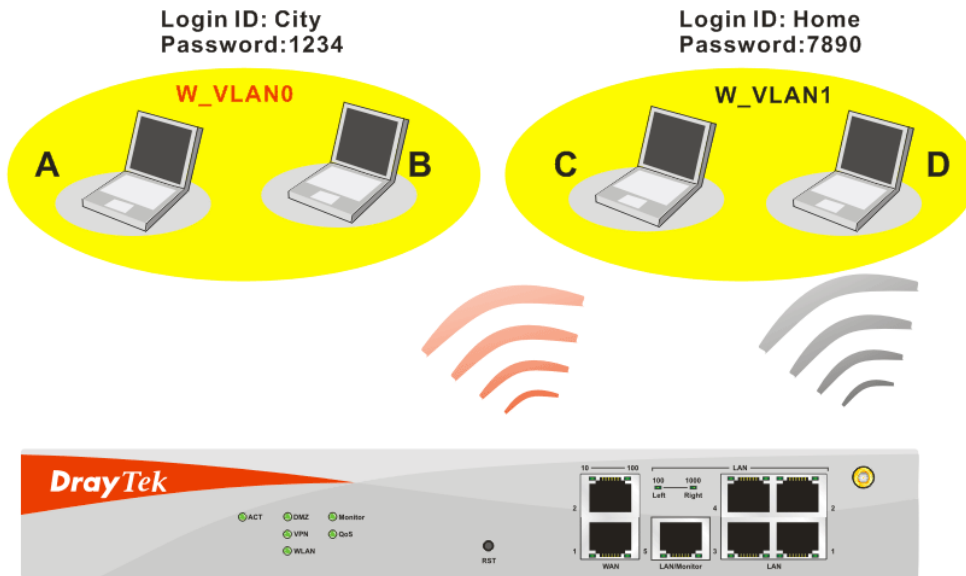

The VLAN >> Wireless VALN allows you to configure Wireless VLAN settings through wireless connection to achieve the above intention. Simply type Login ID and password with **City** and **1234** in the boxes of W_VLAN0. And type Login ID and password with **Home** and

7890 in the boxes of W_VLAN1. Users can configure fifteen groups of wireless VLAN in this page.

VLAN >> Wireless VLAN Setup

Wireless VLAN Configuration

Enable View [Online Station Table](#)

W_VLAN	Login ID	Password	Attributes	W_VLAN	Login ID	Password	Attributes
0	city	1234	Details	8			Details
1	home	7890	Details	9			Details
2			Details	10			Details
3			Details	11			Details
4			Details	12			Details
5			Details	13			Details
6			Details	14			Details
7			Details	15			Details

Disable broadcast and multicast traffic.

Notes:
 1. Login ID: 1~11 characters, Password: 1~11 characters.
 2. Disable broadcast and multicast traffic to maximize wireless VLAN security; however, the WLAN throughput will be reduced.
 3. Login URL for wireless clients:
<http://www.draytek.vlan/login.htm> or [http://\(Vigor IP Address\)/login.htm](http://(Vigor IP Address)/login.htm)

Enable

Check this box to invoke wireless VLAN function.

Login ID

Type Login ID for different groups of W_VLAN with 1 to 11 characters.

Password

Type password for different groups of W_VLAN with 1 to 11 characters.

Details

Click this button to set additional attributes settings for W_VLAN.

VLAN >> Wireless VLAN Setup

W_VLAN0 Attributes

Activated Date: 2006 -1 -1

Expired Date: 2010 -1 -1

Connect all WDS links with this VLAN group.
 Isolate each member in this VLAN group.

Activated Date – Use the drop down lists to set the activated date for the wireless VLAN. The wireless VLAN function will be available when the time is arrival.

Expired Date – Use the drop down lists to set the expired date for the wireless VALN. This function will be invalid when the time is arrival.

Connect all WDS links with this VALN group – Check this box to activate this connection.

Isolate each member in this VLAN group – Check this box to isolate all the members in this VLAN group and not allow the information sharing among them.

Disable broadcast and multicast traffic

Check this box to prevent broadcast and multicast traffic forwarding to all W_VLAN.

How can you (wireless client) access into Internet?

After finishing the configuration of wireless VLAN, the wireless clients connecting to this router must do the following steps to access into Internet.

1. Open a browser and type <http://www.draytek.vlan/login.htm> or [http://\(vigor router's IP address\)/login.htm](http://(vigor router's IP address)/login.htm) on the address line.
2. The following screen will appear.

DrayTek Wireless VLAN

Login ID	<input type="text" value="City"/>
Password	<input type="password" value="••••"/>

3. Type in Login ID and Password that was configured in Wireless VLAN Setup page. In this case, we choose the configuration set in first group of W_VLAN (City and 1234).
4. When the accessing is successful, the following screen will appear.



Note: The floating window with connection time will be shown on the screen till you logout.

- You can go to **Diagnostics>>Wireless VLAN Online Station** for viewing the connection status whenever you want.

Diagnostics >> Wireless VLAN Online Station

Wireless VLAN Online Station Table			Refresh
IP Address	MAC Address	Login ID	
192.168.1.15	00-14-85-26-00-8C	City	
192.168.1.16	00-0E-35-A8-A4-E7	Home	

3.15.3 VLAN Cross Setup

This function allows the router to integrate VLAN and W_VLAN for managing different computers (notebooks). See the following picture for an example. With **VLAN Cross Setup**, notebook A/B and PCs on VLAN0 can share resources without difficulty.

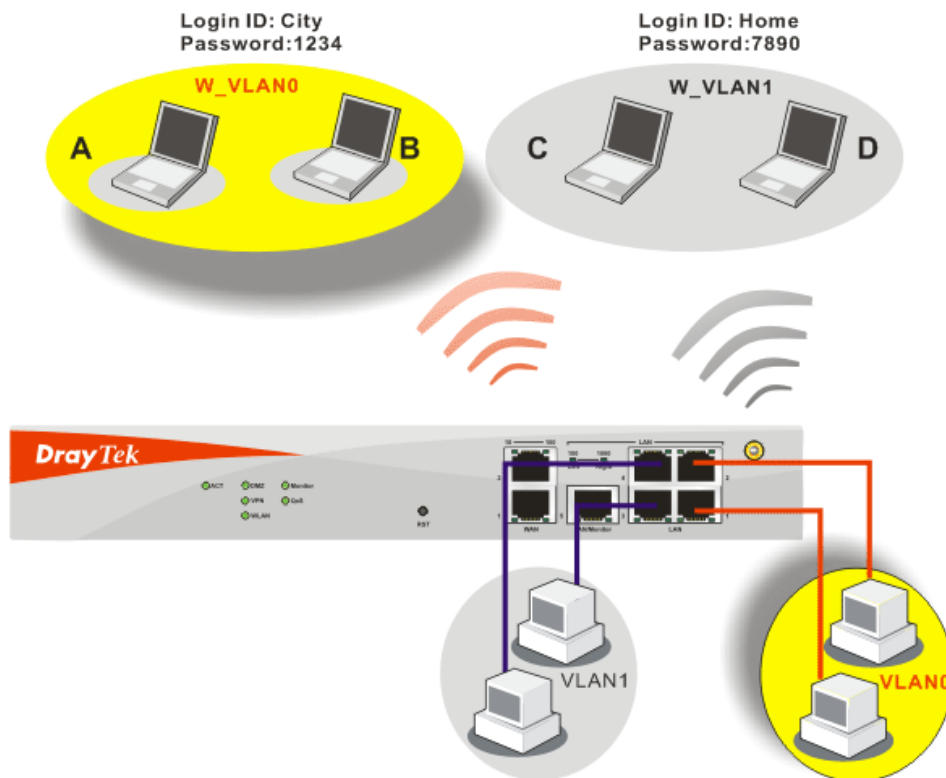

The **VLAN >> VALN Cross Setup** allows you to set a communication bridge between computers in Wireless VLAN and wired VLAN. To achieve the intention of the above illustration, simply check the box under VLAN0 on the line of W_VLAN0.

VLAN >> VLAN Cross Setup

VLAN Cross Configuration

Enable

	VLAN0	VLAN1	VLAN2	VLAN3
W_VLAN0	<input type="checkbox"/>	<input type="checkbox"/>	<input type="checkbox"/>	<input type="checkbox"/>
W_VLAN1	<input type="checkbox"/>	<input type="checkbox"/>	<input type="checkbox"/>	<input type="checkbox"/>
W_VLAN2	<input type="checkbox"/>	<input type="checkbox"/>	<input type="checkbox"/>	<input type="checkbox"/>
W_VLAN3	<input type="checkbox"/>	<input type="checkbox"/>	<input type="checkbox"/>	<input type="checkbox"/>
W_VLAN4	<input type="checkbox"/>	<input type="checkbox"/>	<input type="checkbox"/>	<input type="checkbox"/>
W_VLAN5	<input type="checkbox"/>	<input type="checkbox"/>	<input type="checkbox"/>	<input type="checkbox"/>
W_VLAN6	<input type="checkbox"/>	<input type="checkbox"/>	<input type="checkbox"/>	<input type="checkbox"/>
W_VLAN7	<input type="checkbox"/>	<input type="checkbox"/>	<input type="checkbox"/>	<input type="checkbox"/>
W_VLAN8	<input type="checkbox"/>	<input type="checkbox"/>	<input type="checkbox"/>	<input type="checkbox"/>
W_VLAN9	<input type="checkbox"/>	<input type="checkbox"/>	<input type="checkbox"/>	<input type="checkbox"/>
W_VLAN10	<input type="checkbox"/>	<input type="checkbox"/>	<input type="checkbox"/>	<input type="checkbox"/>
W_VLAN11	<input type="checkbox"/>	<input type="checkbox"/>	<input type="checkbox"/>	<input type="checkbox"/>
W_VLAN12	<input type="checkbox"/>	<input type="checkbox"/>	<input type="checkbox"/>	<input type="checkbox"/>
W_VLAN13	<input type="checkbox"/>	<input type="checkbox"/>	<input type="checkbox"/>	<input type="checkbox"/>
W_VLAN14	<input type="checkbox"/>	<input type="checkbox"/>	<input type="checkbox"/>	<input type="checkbox"/>
W_VLAN15	<input type="checkbox"/>	<input type="checkbox"/>	<input type="checkbox"/>	<input type="checkbox"/>
WDS	<input type="checkbox"/>	<input type="checkbox"/>	<input type="checkbox"/>	<input type="checkbox"/>

Notes:
 1. W_VLANi: wireless VLAN i, see **Wireless VLAN Setup** for details.
 2. All WDS links belong to the same VLAN group.
 3. VLANi: wired VLAN i, see **Wired VLAN Setup** for details.
 4. Both wired and wireless VLANs must be enabled for VLAN cross settings to be effective.

Enable

Check this box to invoke VLAN Cross Setup function.

VLAN0-3

It represents the groups of virtual LAN connected by Ethernet interface.

W_VLAN0-15

It represents the groups of wireless VLAN communicated by wireless interface.

3.15.4 Wireless Rate Control

Rate Control manages the transmission rate of data in and out through the router. You can also manage the in/out rate of each wireless VLAN. Go to **VLAN** menu and select **Wireless Rate Control**. The following page will appear. Click **Enable** to invoke VLAN function.

For the rate control of wireless connection, please open VLAN menu and choose **Wireless Rate Control**. The following page will be shown for you to adjust.

VLAN >> Wireless VLAN Rate Control

Wireless VLAN Rate Control

Enable Range : 100~30,000 Kbps, Increment : 100 Kbps

W_VLAN	Upload Rate (Kbps)	Download Rate (Kbps)	W_VLAN	Upload Rate (Kbps)	Download Rate (Kbps)
0	300 00	300 00	8	300 00	300 00
1	300 00	300 00	9	300 00	300 00
2	300 00	300 00	10	300 00	300 00
3	300 00	300 00	11	300 00	300 00
4	300 00	300 00	12	300 00	300 00
5	300 00	300 00	13	300 00	300 00
6	300 00	300 00	14	300 00	300 00
7	300 00	300 00	15	300 00	300 00

Note: Specified rate is an aggregate rate for the VLAN group.

Enable

Check this box to enable this function (for Rate Control). The rate control will limit the transmission rate for upload and download.

Upload Rate

It decides the rate of data transmission for output. The default setting is 300. The range must be between 100 kbps to 20,000kbps. Adjust the values according to your necessity.

Download Rate

It decides the rate of data transmission for input. The default setting is 300. The range must be between 100 kbps to 20,000kbps. Adjust the values according to your necessity.

3.16 System Maintenance

For the system setup, there are several items that you have to know the way of configuration: Status, Administrator Password, Configuration Backup, Syslog, Time setup, Reboot System, Firmware Upgrade.

Below shows the menu items for System Maintenance.

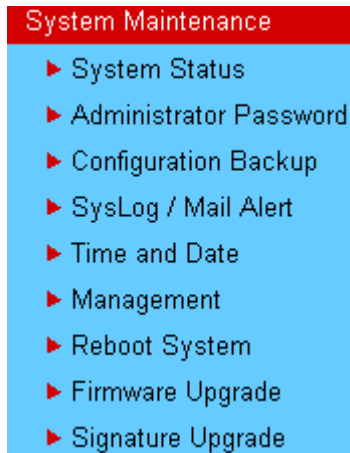

3.16.1 System Status

The **System Status** provides basic network settings of Vigor router. It includes LAN and WAN interface information. Also, you could get the current running firmware version or firmware related information from this presentation.

System Status

Model Name : VigorPro5500 series
Firmware Version : 3.2.0_RC1a
Build Date/Time : Apr 16 2007 18:57:40
Signature Version : basic
Signature Build Date : Tue Aug 29 09:16:25.00 2006

LAN	
MAC Address	: 00-50-7F-22-33-44
1st IP Address	: 192.168.1.1
1st Subnet Mask	: 255.255.255.0
DHCP Server	: Yes
DNS	: 194.109.6.66

WAN 1	
Link Status	: Connected
MAC Address	: 00-50-7F-22-33-45
Connection	: Static IP
IP Address	: 172.16.3.229
Default Gateway	: 172.16.1.1

WAN 2	
Link Status	: Disconnected
MAC Address	: 00-50-7F-22-33-46
Connection	: ---
IP Address	: ---
Default Gateway	: ---

Wireless LAN	
MAC Address	: 00-14-85-2d-b3-95
Frequency Domain	: Europe
Firmware Version	: v2.01.10.10.5.4

Model Name	Display the model name of the router.
Firmware Version	Display the firmware version of the router.
Build Date/Time	Display the date and time of the current firmware build.
MAC Address	Display the MAC address of the LAN Interface.
1st IP Address	Display the IP address of the LAN interface.
1st Subnet Mask	Display the subnet mask address of the LAN interface.

DHCP Server	Display the current status of DHCP server of the LAN interface.
MAC Address	Display the MAC address of the WAN Interface.
IP Address	Display the IP address of the WAN interface.
Default Gateway	Display the assigned IP address of the default gateway.
DNS	Display the assigned IP address of the primary DNS.
MAC Address	Display the MAC address of the wireless LAN.
Frequency Domain	It can be Europe (13 usable channels), USA (11 usable channels) etc. The available channels supported by the wireless products in different countries are various.
Firmware Version	It indicates information about equipped WLAN miniPCi card. This also helps to provide availability of some features that are bound with some WLAN miniPCi card.

3.16.2 Administrator Password

This page allows you to set new password.

System Maintenance >> Administrator Password Setup

Administrator Password

Old Password	<input type="text"/>
New Password	<input type="text"/>
Confirm Password	<input type="text"/>

Old Password Type in the old password. The factory default setting for password is blank.

New Password Type in new password in this field.

Confirm Password Type in the new password again.

When you click OK, the login window will appear. Please use the new password to access into the web configurator again.

3.16.3 Configuration Backup

Backup the Configuration

Follow the steps below to backup your configuration.

1. Go to **System Maintenance >> Configuration Backup**. The following windows will be popped-up, as shown below.

System Maintenance >> Configuration Backup

Configuration Backup / Restoration

Restoration

Select a configuration file.

Click Restore to upload the file.

Backup

Click Backup to download current running configurations as a file.

2. Click **Backup** button to get into the following dialog. Click **Save** button to open another dialog for saving configuration as a file.

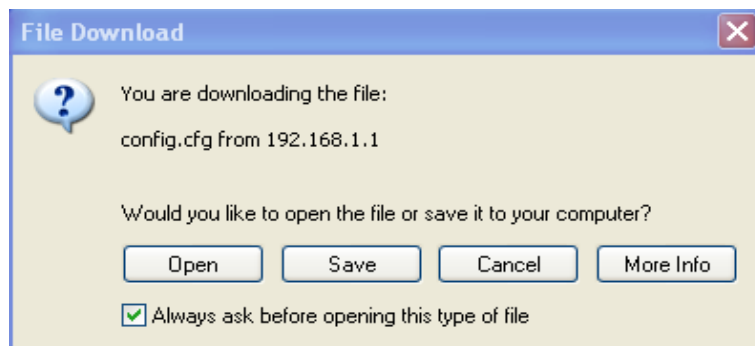

3. In **Save As** dialog, the default filename is **config.cfg**. You could give it another name by yourself.

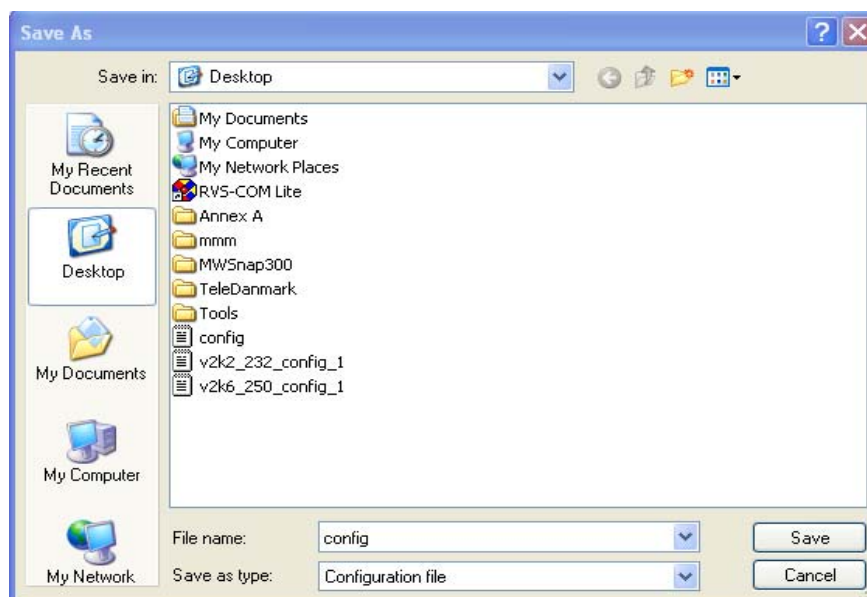

- Click **Save** button, the configuration will download automatically to your computer as a file named **config.cfg**.

The above example is using **Windows** platform for demonstrating examples. The **Mac** or **Linux** platform will appear different windows, but the backup function is still available.

Note: Backup for Certification must be done independently. The Configuration Backup does not include information of Certificate.

Restore Configuration

- Go to **System Maintenance >> Configuration Backup**. The following windows will be popped-up, as shown below.

System Maintenance >> Configuration Backup

Configuration Backup / Restoration

Restoration

Select a configuration file.

Click Restore to upload the file.

Backup

Click Backup to download current running configurations as a file.

- Click **Browse** button to choose the correct configuration file for uploading to the router.
- Click **Restore** button and wait for few seconds, the following picture will tell you that the restoration procedure is successful.

3.16.4 Syslog/Mail Alert

SysLog function is provided for users to monitor router. There is no bother to directly get into the Web Configurator of the router or borrow debug equipments.

System Maintenance >> SysLog / Mail Alert Setup

SysLog / Mail Alert Setup

<p>SysLog Access Setup</p> <p><input checked="" type="checkbox"/> Enable</p> <p>Server IP Address <input type="text"/></p> <p>Destination Port <input type="text" value="514"/></p> <p>Enable syslog message:</p> <p><input checked="" type="checkbox"/> Firewall Log</p> <p><input checked="" type="checkbox"/> VPN Log</p> <p><input checked="" type="checkbox"/> User Access Log</p> <p><input checked="" type="checkbox"/> Call Log</p> <p><input checked="" type="checkbox"/> WAN Log</p> <p><input checked="" type="checkbox"/> Router/DSL information</p>	<p>Mail Alert Setup</p> <p><input checked="" type="checkbox"/> Enable</p> <p>SMTP Server <input type="text"/></p> <p>Mail To <input type="text"/></p> <p>Return-Path <input type="text"/></p> <p><input type="checkbox"/> Authentication</p> <p>User Name <input type="text"/></p> <p>Password <input type="text"/></p>
---	--

Enable

Click “**Enable**” to activate this function.

Syslog Server IP

The IP address of the Syslog server.

Destination Port

Assign a port for the Syslog protocol.

SMTP Server

The IP address of the SMTP server.

- Mail To** Assign a mail address for sending mails out.
- Return-Path** Assign a path for receiving the mail from outside.
- Authentication** Check this box to activate this function while using e-mail application.
- User Name** Type the user name for authentication.
- Password** Type the password for authentication.

Click **OK** to save these settings.

For viewing the Syslog, please do the following:

1. Just set your monitor PC's IP address in the field of Server IP Address
2. Install the Router Tools in the **Utility** within provided CD. After installation, click on the **Router Tools>>Syslog** from program menu.

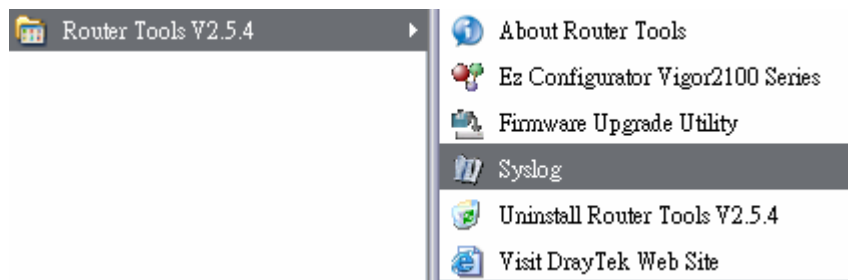

3. From the Syslog screen, select the router you want to monitor. Be reminded that in **Network Information**, select the network adapter used to connect to the router. Otherwise, you won't succeed in retrieving information from the router.

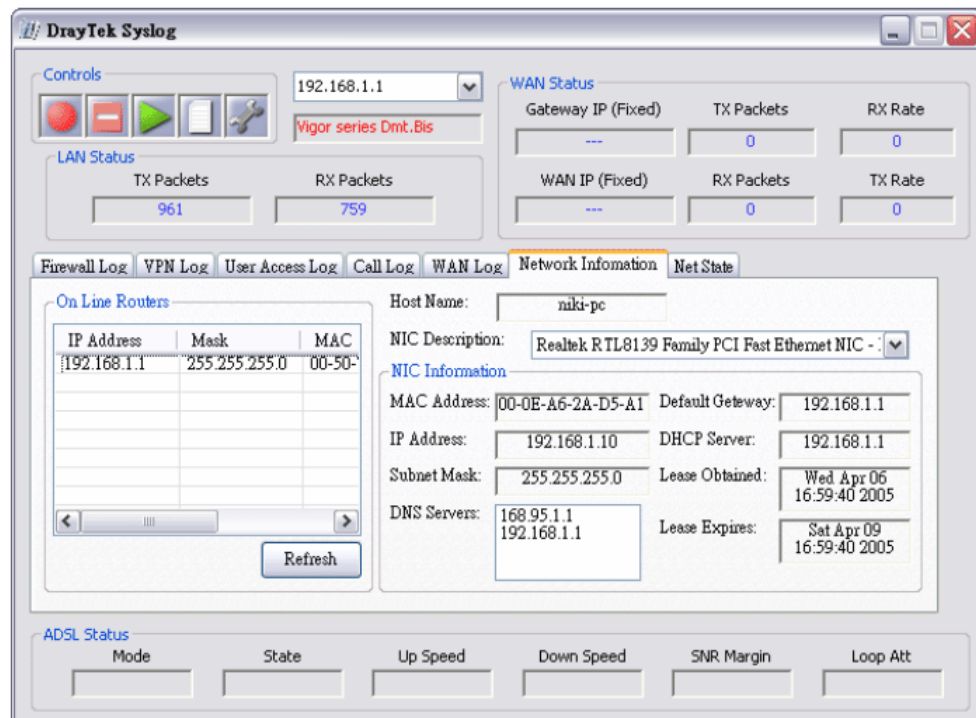

3.16.5 Time and Date

It allows you to specify where the time of the router should be inquired from.

System Maintenance >> Time and Date

Time Information

Current System Time	2006 Sep 5 Tue 6 : 44 : 17	Inquire Time
---------------------	----------------------------	--------------

Time Setup

<input type="radio"/> Use Browser Time	
<input checked="" type="radio"/> Use Internet Time Client	
Time Protocol	NTP (RFC-1305) ▼
Server IP Address	pool.ntp.org
Time Zone	(GMT) Greenwich Mean Time : Dublin ▼
Enable Daylight Saving	<input type="checkbox"/>
Automatically Update Interval	30 min ▼

OK Cancel

Current System Time

Click **Inquire Time** to get the current time.

Use Browser Time

Select this option to use the browser time from the remote administrator PC host as router's system time.

Use Internet Time

Select to inquire time information from Time Server on the Internet using assigned protocol.

Time Protocol

Select a time protocol.

Server IP Address

Type the IP address of the time server.

Time Zone

Select the time zone where the router is located.

Automatically Update Interval

Select a time interval for updating from the NTP server.

Click **OK** to save these settings.

3.16.6 Management

This page allows you to manage the settings for access control, access list, port setup, and SNMP setup. For example, as to management access control, the port number is used to send/receive SIP message for building a session. The default value is 5060 and this must match with the peer Registrar when making VoIP calls.

System Maintenance >> Management

Management Setup

<p>Management Access Control</p> <p><input type="checkbox"/> Enable remote firmware upgrade(FTP)</p> <p><input type="checkbox"/> Allow management from the Internet</p> <p><input checked="" type="checkbox"/> Disable PING from the Internet</p> <hr/> <p>Access List</p> <table border="1"> <thead> <tr> <th>List</th> <th>IP</th> <th>Subnet Mask</th> </tr> </thead> <tbody> <tr> <td>1</td> <td><input type="text"/></td> <td><input type="text"/> ▾</td> </tr> <tr> <td>2</td> <td><input type="text"/></td> <td><input type="text"/> ▾</td> </tr> <tr> <td>3</td> <td><input type="text"/></td> <td><input type="text"/> ▾</td> </tr> </tbody> </table>	List	IP	Subnet Mask	1	<input type="text"/>	<input type="text"/> ▾	2	<input type="text"/>	<input type="text"/> ▾	3	<input type="text"/>	<input type="text"/> ▾	<p>Management Port Setup</p> <p><input type="radio"/> Default Ports (Telnet: 23, HTTP: 80, HTTPS: 443, FTP: 21)</p> <p><input checked="" type="radio"/> User Define Ports</p> <p>Telnet Port <input type="text" value="23"/></p> <p>HTTP Port <input type="text" value="80"/></p> <p>HTTPS Port <input type="text" value="443"/></p> <p>FTP Port <input type="text" value="21"/></p> <hr/> <p>SNMP Setup</p> <p><input type="checkbox"/> Enable SNMP Agent</p> <p>Get Community <input type="text" value="public"/></p> <p>Set Community <input type="text" value="private"/></p> <p>Manager Host IP <input type="text"/></p> <hr/> <p>Trap Community <input type="text" value="public"/></p> <p>Notification Host IP <input type="text"/></p> <p>Trap Timeout <input type="text" value="10"/> seconds</p>
List	IP	Subnet Mask											
1	<input type="text"/>	<input type="text"/> ▾											
2	<input type="text"/>	<input type="text"/> ▾											
3	<input type="text"/>	<input type="text"/> ▾											

Enable remote firmware upgrade

Click the checkbox to allow remote firmware upgrade through FTP (File Transfer Protocol).

Allow management from the Internet

Enable the checkbox to allow system administrators to login from the Internet. By default, it is not allowed.

Disable PING from the Internet

Check the checkbox to reject all PING packets from the Internet. For security issue, this function is enabled by default.

Access List

You could specify that the system administrator can only login from a specific host or network defined in the list. A maximum of three IPs/subnet masks is allowed.

List IP - Indicate an IP address allowed to login to the router.

Subnet Mask - Represent a subnet mask allowed to login to the router.

Default Ports

Check to use standard port numbers for the Telnet and HTTP servers.

User Defined Ports

Check to specify user-defined port numbers for the Telnet and HTTP servers.

Enable SNMP Agent

Check it to enable this function.

Get Community

Set the name for getting community by typing a proper character. The default setting is **public**.

Set Community

Set community by typing a proper name. The default setting is **private**.

Manager Host IP	Set one host as the manager to execute SNMP function. Please type in IP address to specify certain host.
Trap Community	Set trap community by typing a proper name. The default setting is public .
Notification Host IP	Set the IP address of the host that will receive the trap community.
Trap Timeout	The default setting is 10 seconds.

3.16.7 Reboot System

The Web Configurator may be used to restart your router. Click **Reboot System** from **System Maintenance** to open the following page.

System Maintenance >> Reboot System

Reboot System

Do You want to reboot your router ?

Using current configuration
 Using factory default configuration

If you want to reboot the router using the current configuration, check **Using current configuration** and click **OK**. To reset the router settings to default values, check **Using factory default configuration** and click **OK**. The router will take 5 seconds to reboot the system.

Note: When the system pops up Reboot System web page after you configure web settings, please click **OK** to reboot your router for ensuring normal operation and preventing unexpected errors of the router in the future.

3.16.8 Firmware Upgrade

Before upgrading your router firmware, you need to install the Router Tools. The **Firmware Upgrade Utility** is included in the tools. The following web page will guide you to upgrade firmware by using an example. Note that this example is running over Windows OS (Operating System).

Download the newest firmware from DrayTek's web site or FTP site. The DrayTek web site is www.draytek.com (or local DrayTek's web site) and FTP site is <ftp.draytek.com>.

Click **System Maintenance>> Firmware Upgrade** to launch the Firmware Upgrade Utility.

System Maintenance >> Firmware Upgrade

Web Firmware Upgrade

Select a firmware file.

Click Upgrade to upload the file.

TFTP Firmware Upgrade from LAN

Current Firmware Version: 3.2.0_RC1a

Firmware Upgrade Procedures:

1. Click "OK" to start the TFTP server.
2. Open the Firmware Upgrade Utility or other 3-party TFTP client software.
3. Check that the firmware filename is correct.
4. Click "Upgrade" on the Firmware Upgrade Utility to start the upgrade.
5. After the upgrade is complete, the TFTP server will automatically stop running.

Do you want to upgrade firmware ?

Click **OK**. The following screen will appear. Please execute the firmware upgrade utility first.

System Maintenance >> Firmware Upgrade

 TFTP server is running. Please execute a Firmware Upgrade Utility software to upgrade router's firmware. This server will be closed by itself when the firmware upgrading finished.

For the detailed information about firmware update, please go to Chapter 5.

3.16.9 Signature Upgrade

You can get the most updated signature from DrayTek's server if the license key of anti-virus/anti-intrusion for the VigorPro5500 is not expired. Before you upgrade the signature, please check the validation information either from WEB user interface of VigorPro5500 or account information from www.vigorpro.com.

System Maintenance >> Signature Upgrade

License [Status : **Not Activated**]

Service Activation	Activate
---------------------------	--------------------------

Signature Upgrade Setting [Signature Version : **basic**]
 [Signature Build Date : **Tue Aug 12 9:16:25.0 2006**]

Setup download server	auto-selected	find more
Setup query server	auto-selected	find more
Signature authentication/download message: <div style="border: 1px solid gray; height: 40px; width: 100%;"></div>		

Upgrade Manually	Import	Backup	Download Now !!!
-------------------------	------------------------	------------------------	----------------------------------

Upgrade Automatically			
<input type="checkbox"/> Scheduled Update			
<input checked="" type="radio"/> Every:	1	(hour)	00 (minutes after the hour)
<input type="radio"/> Daily:	0	(hour)	00 (minute)
<input type="radio"/> Weekly:	Sunday	(day)	0 (hour) 00 (minute)
OK		Cancel	

License

This field will show the status for the license, start date and expire date. If your account or router is still not activated, the word **Not Activated** will be displayed here to inform you. Below is a sample page with valid license.

System Maintenance >> Signature Upgrade

License [Status : **DT-DT**] [Start Date: **2006-08-16** Expire Date: **2007-08-15**]

Service Activation	Activate
---------------------------	--------------------------

Signature Upgrade Setting [Signature Version : **basic**]
 [Signature Build Date : **Tue Aug 12 9:16:25.0 2006**]

Setup download server	auto-selected	find more
Setup query server	auto-selected	find more

Service Activate

The Activate link brings you accessing into www.vigorpro.com to finish the activation of the account and the router.

Signature Upgrade Setting

It displays the signature version for your reference. There are three levels for the signature:

basic – If you did not register and activate your account, you can just own the default 200 (or more) anti-intrusion and anti-virus

rules for your router.

DT-DT/DT-KL_XXXXXX – If you have registered and activated your AI/AV account, and downloaded the newest rules from www.vigorpro.com, you can see DT-DT/DT-KL in this field that means you have obtained the latest signature information.

Setup download server/Setup query server

The default setting is auto-selected. You can change the setting if it is required to be. Click the **find more** link to get more information. [Please choose a download server / query server of the continent that your router is located.](#)

Zone Name	Download Server	Query Server
Africa	www.vigorpro.com	www.vigorpro.com
America	www.vigorpro.com	www.vigorpro.com
Asia	www.vigorpro.com	www.vigorpro.com
Europe	www.vigorpro.com	www.vigorpro.com
Oceania	www.vigorpro.com	www.vigorpro.com
The Antarctic	www.vigorpro.com	www.vigorpro.com

Signature authentication/download message

It displays the message of signature authentication or download procedure.

Upgrade Manually

The buttons in this field are only available when you finished the registration and activation for new account and your router. If not, these buttons do not have any effect even if you click them.

Import – You can import a saved file to manually upgrade the signature. Click **Browse** to choose the right file with **.sig** file format. Next, click **Upgrade**.

System Maintenance >> Signature Upgrade

Signature Upgrade Manually [Signature Version : basic]

Upgrade Signature

Select a signature file.

Click Upgrade to upload the file.

Backup - You can backup current signature information with the filename vigorpro.sig.

Download Now!!! – This button will download newly update anti-intrusion and anti-virus from VigorPro website. While downloading the file, a progress bar will be shown as follows.

Signature Upgrade Setting [Signature Version : basic]
[Signature Build Date : Tue Aug 12 9:16:25.0 2006]

Setup download server auto-selected [find more](#)

Setup query server auto-selected [find more](#)

Signature download progress: 24% 

Signature authentication/download message:

Start downloading signature, 2006-09-06 07:10:54

Upgrade Manually

After downloading is finished, the signature version will be

upgraded and displayed on the web page.

Signature Upgrade Setting [Signature Version : DT-DT_1_61_5_4]
[Signature Build Date : Tue Aug 12 9:16:25.0 2006]

Setup download server: auto-selected [find more](#)

Setup query server: auto-selected [find more](#)

Signature authentication/download message:
Load signature successful, 2006-09-06 07:13:43

Upgrade Manually: Import Backup Download Now !!!

Upgrade Automatically

Specify certain time for executing the upgrade automatically. Remember to check the **Schedule Update** box to activate the time settings.

Every – It means the downloading procedure will be executed automatically whenever passing through the time (hours and minutes) that you set here.

Daily - It means the downloading procedure will be automatically executed every day at the time (hours and minutes) that you set here.

Weekly - It means the downloading procedure will be automatically executed at the time (hours and minutes) that you set here every week.

Upgrade Automatically

Scheduled Update

Every: 1 (hour) 00 (minutes after the hour)

Daily: 0 (hour) 00 (minute)

Weekly: Sunday (day) 0 (hour) 00 (minute)

OK Cancel

3.17 Diagnostics

Diagnostic Tools provide a useful way to **view** or **diagnose** the status of your Vigor router.

Below shows the menu items for Diagnostics.

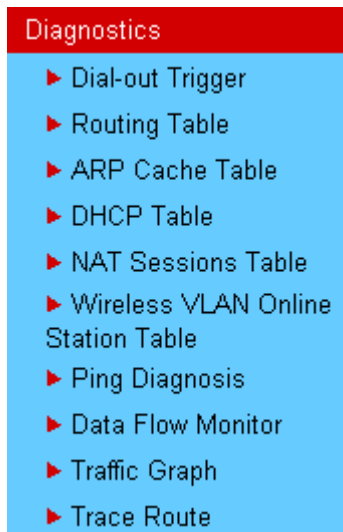

3.17.1 Dial-out Trigger

Click **Diagnostics** and click **Dial-out Trigger** to open the web page. The internet connection (e.g., ISDN, PPPoE, PPPoA, etc) is triggered by a package sending from the source IP address.

Diagnostics >> Dial-out Trigger

Dial-out Triggered Packet Header

| [Refresh](#) |

HEX Format:

```
00 00 00 00 00 00 00-00 00 00 00 00 00-00 00
```

```
00 00 00 00 00 00 00 00-00 00 00 00 00 00 00 00
00 00 00 00 00 00 00 00-00 00 00 00 00 00 00 00
00 00 00 00 00 00 00 00-00 00 00 00 00 00 00 00
00 00 00 00 00 00 00 00-00 00 00 00 00 00 00 00
00 00 00 00 00 00 00 00-00 00 00 00 00 00 00 00
```

Decoded Format:

```
0.0.0.0 -> 0.0.0.0
Pr 0 len 0 (0)
```

Decoded Format

It shows the source IP address (local), destination IP (remote) address, the protocol and length of the package.

Refresh

Click it to reload the page.

3.17.2 Routing Table

Click **Diagnostics** and click **Routing Table** to open the web page.

Diagnostics >> View Routing Table

Current Running Routing Table | Refresh |

Key: C - connected, S - static, R - RIP, * - default, ~ - private			
*	0.0.0.0/	0.0.0.0 via 172.16.3.1,	WAN1
C~	192.168.1.0/	255.255.255.0 is directly connected,	LAN
C	172.16.3.0/	255.255.255.0 is directly connected,	WAN1

Refresh

Click it to reload the page.

3.17.3 ARP Cache Table

Click **Diagnostics** and click **ARP Cache Table** to view the content of the ARP (Address Resolution Protocol) cache held in the router. The table shows a mapping between an Ethernet hardware address (MAC Address) and an IP address.

Diagnostics >> View ARP Cache Table

Ethernet ARP Cache Table | Clear | Refresh |

IP Address	MAC Address
192.168.1.10	00-0E-A6-2A-D5-A1
172.16.3.19	00-0D-60-6F-89-CA
172.16.3.163	00-50-7F-1A-58-89
172.16.3.156	00-50-7F-1A-56-0E
172.16.3.153	00-50-7F-1A-57-07
172.16.3.131	00-07-40-82-14-EF
172.16.3.112	00-40-CA-6B-56-BA
172.16.3.114	00-0E-A6-4F-10-C4
172.16.3.8	00-11-25-22-66-22
172.16.3.181	00-50-7F-1A-58-CF
172.16.3.198	00-50-7F-1A-57-AE
172.16.3.174	00-0C-6E-5E-C8-60
172.16.3.160	00-0E-A6-5C-5C-D9
172.16.3.188	00-E0-18-72-AE-11
172.16.3.20	00-0D-60-6F-83-BC

Refresh

Click it to reload the page.

Clear

Click it to clear the whole table.

3.17.4 DHCP Table

The facility provides information on IP address assignments. This information is helpful in diagnosing network problems, such as IP address conflicts, etc.

Click **Diagnostics** and click **DHCP Table** to open the web page.

Diagnostics >> View DHCP Assigned IP Addresses

Index	IP Address	MAC Address	Leased Time	HOST ID
1	192.168.1.10	00-0E-A6-2A-D5-A1	0:00:02.630	ok-lccgjyiy075u

Index	It displays the connection item number.
IP Address	It displays the IP address assigned by this router for specified PC.
MAC Address	It displays the MAC address for the specified PC that DHCP assigned IP address for it.
Leased Time	It displays the leased time of the specified PC.
HOST ID	It displays the host ID name of the specified PC.
Refresh	Click it to reload the page.

3.17.5 NAT Sessions Table

Click **Diagnostics** and click **NAT Sessions Table** to open the setup page.

Diagnostics >> NAT Sessions Table

Private IP :Port	#Pseudo Port	Peer IP :Port	Interface
192.168.1.10 2461	52047	207.46.3.12 80	WAN1

Private IP:Port	It indicates the source IP address and port of local PC.
#Pseudo Port	It indicates the temporary port of the router used for NAT.
Peer IP :Port	It indicates the destination IP address and port of remote host.

Interface It indicates the interface of the WAN connection.

Refresh Click it to reload the page.

3.17.6 Wireless VLAN Online Station Table

Click **Diagnostics** and click **Wireless VLAN Online Station Table** to open the web page. It will display the IP address, MAC address and Login ID information for all the Wireless VLAN stations.

Diagnostics >> Wireless VLAN Online Station

Wireless VLAN Online Station Table			Refresh
IP Address	MAC Address	Login ID	
192.168.1.15	00-14-85-26-00-8C	City	
192.168.1.16	00-0E-35-A8-A4-E7	Home	

IP Address Display the IP address of the wireless station.

MAC Address Display the MAC address of the wireless station.

Login ID Display the login ID that the wireless station belongs to.

Note: This menu is available for G models only.

3.17.7 Ping Diagnosis

Click **Diagnostics** and click **Ping Diagnosis** to pen the web page.

Diagnostics >> Ping Diagnosis

Ping Diagnosis

Note: If you want to ping a LAN PC or you don't want to specify which WAN to ping through, please select "Unspecified".

Ping through:

Ping to: IP Address:

Result [Clear](#)

Ping through

Use the drop down list to choose the WAN interface that you want to ping through or choose **Unspecified** to be determined by the router automatically.

Ping through:

- Unspecified
- WAN1
- WAN2

Ping to

Use the drop down list to choose the destination that you want to ping.

Ping to:

- Host / IP
- GateWay1
- GateWay2
- DNS

IP Address

Type in the IP address of the Host/IP that you want to ping.

Run

Click this button to start the ping work. The result will be displayed on the screen.

Clear

Click this link to remove the result on the window.

Refresh	Click this link to refresh this page manually.
Index	Display the number of the data flow.
IP Address	Display the IP address of the monitored device.
TX rate (kbps)	Display the transmission speed of the monitored device.
RX rate (kbps)	Display the receiving speed of the monitored device.
Sessions	Display the session number that you specified in Limit Session web page.
Action	Block - can prevent specified PC accessing into Internet within 5 minutes.

Page: 1 | Refresh |

bps)	Sessions	Action
	1 / 100	Block

Unblock – the device with the IP address will be blocked in five minutes. The remaining time will be shown on the session column.

Page: 1 | Refresh |

Sessions	Action
blocked / 299	Unblock

3.17.9 Traffic Graph

Click **Diagnostics** and click **Traffic Graph** to pen the web page. Choose WAN1 Bandwidth/WAN2 Bandwidth or Sessions for viewing different traffic graph. Click **Refresh** to renew the graph at any time.

Diagnostics >> Traffic Graph

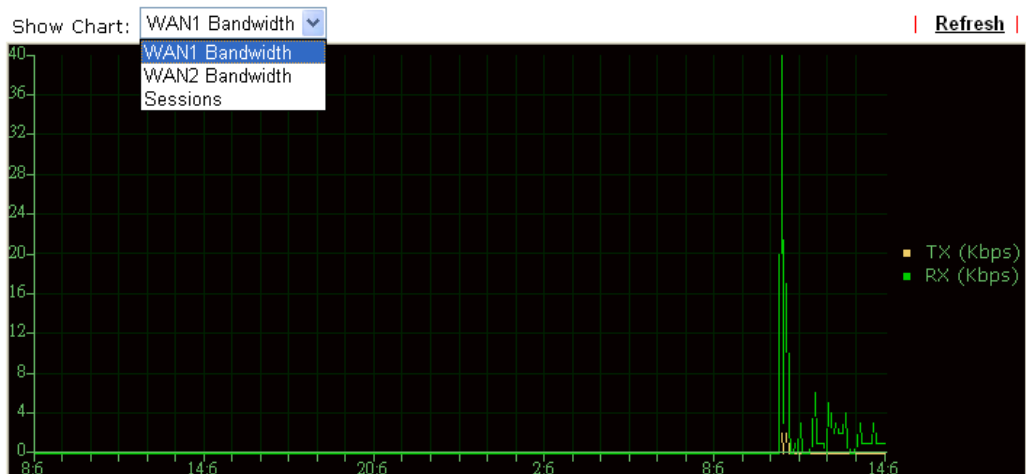

The horizontal axis represents time. Yet the vertical axis has different meanings. For WAN1/WAN2 Bandwidth chart, the numbers displayed on vertical axis represent the numbers of the transmitted and received packets in the past.

For Sessions chart, the numbers displayed on vertical axis represent the numbers of the NAT sessions during the past.

3.17.10 Trace Route

Click **Diagnostics** and click **Trace Route** to open the web page. This page allows you to trace the routes from router to the host. Simply type the IP address of the host in the box and click **Run**. The result of route trace will be shown on the screen.

Diagnostics >> Trace Route

Trace Route

Trace through:

Host / IP Address:

Result [Clear](#)

```
Trace through WAN1.
traceroute to 192.168.1.1, 30 hops max
 1 Request timed out.    *
 2 Request timed out.    *
Trace complete.
```

Trace through

Use the drop down list to choose the WAN interface that you want to ping through or choose **Unspecified** to be determined by the router automatically.

Trace through:

- Unspecified
- WAN1
- WAN2

Host/IP Address

It indicates the IP address of the host.

Run

Click this button to start route tracing work.

Clear

Click this link to remove the result on the window.

4

Registration for the Router

To use the anti-intrusion, anti-virus and anti-spam features of VigorPro series router, you have to create a new account, finish the registration for that account by using the router and complete the registration for the Vigor router. After finishing the registration of the router, you can download the newly update types and rules of anti-intrusion and anti-virus during the valid time of the license key you purchased.

There are two ways to create and activate new account. One is created by accessing www.vigorpro.com (refer to section 4.1), the other is from router's web configurator (refer to section 4.2).

After activating the new account, you have to register your router from router's web configurator (refer to section 4.3). Follow the steps listed below to finish the registration and activation.

4.1 Creating and Activating an Account from VigorPro Website

To activate anti-virus/anti-intrusion/anti-spam function, you need to register an account on www.vigorpro.com firstly. Please follow the steps below to create a new account.

1. Open your browser with URL: www.vigorpro.com. Find the line of **Not registered yet?**. Then, click the link **Click here!** to access into next page.

The screenshot shows the VigorPro website interface. On the left is a red navigation menu with links: Home, About Us, Product, My Information, Security Information, Downloads, Technical Support, Submit Virus Sample, and Close. The main content area features a 'Unified Security Firewall' advertisement with a woman working on a laptop. Below this is a 'SECURITY INFORMATION' section with a table of security alerts:

Virus/Attack Name	Severity	Action
Virus - Worm.Win32.RussoTuristo.a Nov 02, 2006	low	More Viruses
Virus - Trojan-Downloader.Win32.Small.ddy Nov 02, 2006	low	More Viruses
Virus - IM-Worm.Win32.Oucan.q Nov 02, 2006	low	More Viruses
Virus - Worm.Stration.MU Nov 02, 2006	low	More Viruses
Virus - Worm.Stration.MS Nov 02, 2006	low	More Viruses
Virus - Trojan.SdBot-2941 Nov 02, 2006	low	More Viruses
Attack - TIBCO RendezVous SSL expl Nov 02, 2006	low	More Attack
Attack - MSIE COM Daxctle.OCX expl Nov 02, 2006	low	More Attack
Attack - DNS query response TTL Nov 02, 2006	low	More Attack

On the right side, there is a 'LOGIN' form with fields for Username, Password, and AuthCode. Below the form is a CAPTCHA image showing the text 'VR8ca'. A red box highlights the text 'Not registered yet? Click here!' in the 'Contact DrayTek' section.

2. Check to confirm that you accept the Agreement and click **Accept**.

Register Search for this site

Create an account - Please enter personal profile.

- 1 Agreement
- 2 Personal Information
- 3 Preferences
- 4 Completion

===== VigorPro Agreement =====

1. Agreement
 Draytek provides Vigopro(www.vigopro.com) service according to this agreement. When you use vigopro service, it means that you have read, understand and agree to accept the items listed in this agreement. Draytek can modify or change the content of the items without any reasons. It is suggested for you to notice the medications or changes at any time. If you still use vigopro service after knowing the modifications and changes of this service, it means you have read, understand and agree to accept the modifications and changes. If you do not agree the content of this agreement, please stop using vigopro service.

2. Registration
 To use this service, you have to agree the following conditions:
 (a) Provide your complete and correct information according to the registration steps of this service.
 (b) If you provide any incorrect or fake information here, DrayTek has the right to pause or terminate

I have read and understand the above Agreement. (Use the scroll bar to view the entire agreement)

3. Type your personal information in this page and then click **Continue**.

Register Search for this site

Create an account - Please enter personal profile.

Fields marked by (*) are required

- 1 Agreement
- 2 Personal Information
- 3 Preferences
- 4 Completion

Account Information

UserName :*

(3 ~ 20 characters)

Password :*

(4 ~ 20 characters : Do not set the same as the username.)

Confirm Password :*

Personal Information

First Name :*

Last Name :*

Company Name :

Email Address :*

Please note that a valid E-mail address is required to receive the Subscription Code. You will need this code to activate your account.

Tel : -

Country :*

Career :*

4. Choose proper selection for your computer and click **Continue**.

The screenshot shows the registration process at step 3, 'Preferences'. The page header includes the word 'Register' and a search bar with a 'GO' button. Below the header, the instruction 'Create an account - Please enter personal profile.' is displayed. On the left, a vertical list of steps is shown: 1 Agreement, 2 Personal Information, 3 Preferences (highlighted in blue), and 4 Completion. The main content area contains the following questions and options:

- How did you find out about this website? (Dropdown menu: Internet)
- What kind of anti-virus do you use? (Dropdown menu: ClamAV)
- I would like to subscribe to the vigorpro e-letter. (Checkbox: checked)
- I would like to receive DrayTek product news. (Checkbox: checked)

At the bottom right, there are two buttons: '<< Back' and 'Continue >>'.

5. Now you have created an account successfully.

The screenshot shows the registration completion screen. The page header is identical to the previous screenshot. The instruction 'Create an account - Please enter personal profile.' is still present. The vertical list of steps on the left now shows step 4, 'Completion', highlighted in blue. A large red-bordered box with a white background is centered on the page. The box has a red header with the word 'Completion' in white. The text inside the box reads: 'A confirmation email has been sent to **carrie_ni@draytek.com**. Please click on the activation link in the email to activate your account.' Below this text, the word 'START' is written in large, bold, blue letters.

6. Check to see the confirmation email with the title of **New Account Confirmation Letter from www.vigorpro.com**.

***** This is an automated message from www.vigorpro.com.*****

Thank you (**carrie**) for creating an account.

Please click on the activation link below to activate your account

Link : [Activate my Account](#)

7. Click the **Activate my Account** link to enable the account that you created. The following screen will be shown to verify the register process is finished. Please click **Login**.

Register

Register Confirm

Thank for your register in VigorPro Web Site
The Register process is completed

Login

Close

8. When you see the following page, please type in the account and password (that you just created) in the fields of **UserName** and **Password**. Then type the code in the box of AuthCode according to the value displayed on the right side of it.

Relogin

Search for this site

This service is available for VigorPro member only. Please login to access VigorPro.
If you are not one of the members of VigorPro, please create an account first.

LOGIN

UserName :

Password :

Auth Code : 

If you cannot read the word, click here

Don't have a VigorPro Account ?

[Create an account now](#)

If you are having difficulty logging in, contact our customer service.
Customer Service : 886 3 597 2727 or
email to webmaster@dravtek.com

9. Now, click **Login**. Your account has been activated.

4.2 Creating and Activating an Account from Router Web Configurator

You, also can created and register a new account from the web configurator of the VigorPro router.

1. Open a web browser on your PC and type **http://192.168.1.1**. A pop-up window will open to ask for username and password. Do not type any word on the window and click **OK**.
2. From the router's web page, please open **System Maintenance >>Signature Upgrade**. You will see the following web page.

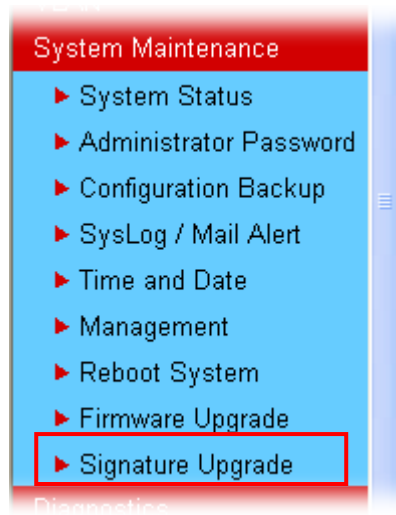

3. Click the **Activate** link from the **Signature Upgrade** web page.

System Maintenance >> Signature Upgrade

License [Status :Not Activated]

Service Activation	Activate
--------------------	-----------------

Signature Upgrade Setting [Signature Version : basic]
[Signature Build Date : Tue Aug 12 9:16:25.0 2006]

Setup download server	auto-selected	find more
Setup query server	auto-selected	find more

Signature authentication/download message:

Upgrade Manually

Upgrade Automatically

Scheduled Update

Every: 1 (hour) 00 (minutes after the hour)

Daily: 0 (hour) 00 (minute)

Weekly: Sunday (day) 0 (hour) 00 (minute)

4. A **Re-login** page will be shown on the screen.

Re-login Search for this site GO

This service is available for VigorPro member only. Please login to access VigorPro.
If you are not one of the members of VigorPro, please create an account first.

LOGIN

UserName :

Password :

Auth Code : 

If you cannot read the word, click here

Login

Don't have a VigorPro Account ?

[Create an account now](#)

If you are having difficulty logging in, contact our customer service.
Customer Service : 886 3 597 2727 or
email to :webmaster@draytek.com

5. Locate and click **Create an account now link** on the bottom of this page. You will access into the following page. Check the box below to confirm that you accept the Agreement and click **Accept**.

Register Search for this site GO

Create an account - Please enter personal profile.

1 Agreement

2 Personal Information

3 Preferences

4 Completion

===== VigorPro Agreement =====

1. Agreement
Draytek provides VigorPro(www.vigorpro.com) service according to this agreement. When you use vigorpro service, it means that you have read, understand and agree to accept the items listed in this agreement. Draytek can modify or change the content of the items without any reasons. It is suggested for you to notice the modifications or changes at any time. If you still use vigorpro service after knowing the modifications and changes of this service, it means you have read, understand and agree to accept the modifications and changes. If you do not agree the content of this agreement, please stop using vigorpro service.

2. Registration
To use this service, you have to agree the following conditions:
(a) Provide your complete and correct information according to the registration steps of this service.
(b) If you provide any incorrect or fake information here, DrayTek has the right to pause or terminate

I have read and understand the above Agreement. (Use the scroll bar to view the entire agreement)

<< Back Accept >>

6. Type your personal information in this page and then click **Continue**.

Register Search for this site

Create an account - Please enter personal profile.

Fields marked by (*) are required

1 Agreement

2 Personal Information

3 Preferences

4 Completion

Account Information

UserName :*
(3 ~ 20 characters)

Password :*
(4 ~ 20 characters : Do not set the same as the username.)

Confirm Password :*

Personal Information

First Name :*

Last Name :*

Company Name :

Email Address :*
Please note that a valid E-mail address is required to receive the Subscription Code. You will need this code to activate your account.

Tel : -

Country :*

Career :*

7. Choose proper selection for your computer and click **Continue**.

Register Search for this site

Create an account - Please enter personal profile.

1 Agreement

2 Personal Information

3 Preferences

4 Completion

How did you find out about this website?

What kind of anti-virus do you use?

I would like to subscribe to the vigorpro e-letter.

I would like to receive DrayTek product news.

8. Now you have created an account successfully.

The screenshot shows a web page with a blue header containing the word "Register" and a search bar with a "GO" button. Below the header, the text "Create an account - Please enter personal profile." is displayed. On the left, there is a vertical list of four steps: 1 Agreement, 2 Personal Information, 3 Preferences, and 4 Completion. The "4 Completion" step is highlighted with a blue background. To the right of this list is a red-bordered box with a red header that says "Completion". Inside this box, the text reads: "A confirmation email has been sent to **carrie_m@draytek.com**. Please click on the activation link in the email to activate your account." Below this text is a large blue button that says "START".

9. Check to see the confirmation email with the title of **New Account Confirmation Letter from www.vigorpro.com.**

***** This is an automated message from www.vigorpro.com. *****

Thank you (**carrie**) for creating an account.

Please click on the activation link below to activate your account

Link : [Activate my Account](#)

10. Click the **Activate my Account** link to enable the account that you created. The following screen will be shown to verify the register process is finished. Please click **Login**.

The screenshot shows a light blue header with the word "Register" in blue. Below the header, the text "Register Confirm" is displayed. In the center of the page, the text reads: "Thank for your register in VigorPro Web Site" and "The Register process is completed". At the bottom of the page, there are two buttons: "Login" and "Close".

11. When you see the following page, please type in the account and password (that you just created) in the fields of **UserName** and **Password**. Then type the code in the box of AuthCode according to the value displayed on the right side of it.

Re-login Search for this site

This service is available for VigorPro member only. Please login to access VigorPro.
If you are not one of the members of VigorPro, please create an account first.

LOGIN

UserName :

Password :

Auth Code : 

If you cannot read the word, click here

Don't have a VigorPro Account ?

[Create an account now](#)

If you are having difficulty logging in, contact our customer service.
Customer Service : 886 3 597 2727 or
email to : webmaster@draytek.com

12. Now, click **Login**. Your account has been activated. And the following page will be shown automatically.

My Product Search for this site

Device Registration

Welcome, carrie
Last Login Time : 2006-08-16 17:08:25
Last Login From : 218.174.234.195
Current Login Time : 2006-08-16 17:13:51
Current Login From : 218.174.234.195

RowNo : PageNo :



DrayTek will maintain a database of MAC address/serial number of shipped goods. Only products with shipping records can be registered. If your VigorPro 5500 cannot hook up to your account, please contact your reseller or DrayTek's technical support.

4.3 Registering Your Vigor Router

You have activated the new account for the router. Now, it is the time for you to register your vigor router. There are two ways to register your vigor router. One is to register by opening **System Maintenance >>Signature Upgrade**; the other is to register by using **Anti-Spam>>Profile Setting**. Registering Vigor router should be done just for once. **If the router has been registered previously, the system will not allow you to register the router again.** After finishing the router registration, you can activate Anti-Virus, Anti-Intrusion and Anti-Spam respectively.

From System Maintenance >>Signature Upgrade

1. Open a web browser on your PC and type **http://192.168.1.1**. A pop-up window will open to ask for username and password. Do not type any word on the window and click **OK**.
2. From the router's web page, please open **System Maintenance >>Signature Upgrade**. You will see the following web page.

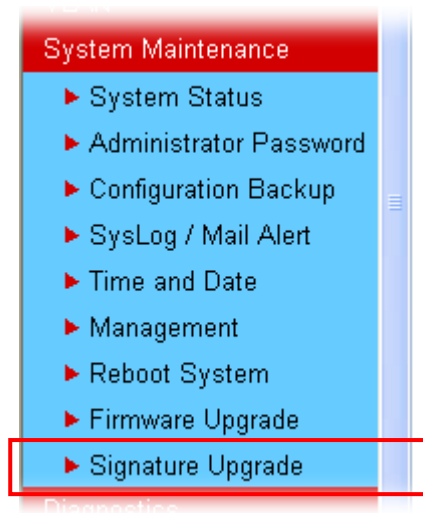

- Click the **Activate** link from the **Signature Upgrade** web page.

System Maintenance >> Signature Upgrade

License [Status :Not Activated]

Service Activation	Activate
--------------------	-----------------

Signature Upgrade Setting [Signature Version : basic]
[Signature Build Date : Tue Aug 12 9:16:25.0 2006]

Setup download server	auto-selected	find more
Setup query server	auto-selected	find more

Signature authentication/download message:

Upgrade Manually

<input type="button" value="Import"/>	<input type="button" value="Backup"/>	<input type="button" value="Download Now !!!"/>
---------------------------------------	---------------------------------------	---

Upgrade Automatically

Scheduled Update

<input checked="" type="radio"/> Every:	1 (hour)	00 (minutes after the hour)
<input type="radio"/> Daily:	0 (hour)	00 (minute)
<input type="radio"/> Weekly:	Sunday (day)	0 (hour) 00 (minute)

- A **Re-login** page will be shown on the screen. Please type the account and password that you created previously. And click **Login**.

Re-login Search for this site

**This service is available for VigorPro member only. Please login to access VigorPro.
If you are not one of the members of VigorPro, please create an account first.**

LOGIN

UserName :	<input type="text" value="carrie"/>
Password :	<input type="password" value="....."/>
Auth Code :	<input type="text" value="thmj"/> <i>thmj</i>

If you cannot read the word, click here

Don't have a VigorPro Account ?

[Create an account now](#)

If you are having difficulty logging in, contact our customer service.
Customer Service : 886 3 597 2727 or
email to :webmaster@dravtek.com

- The following page will be displayed after you logging in VigorPro server. From this page, please click **Add**.

My Product Search for this site

Device Registration

Welcome, carrie
Last Login Time : 2006-08-16 17:08:25
Last Login From : 218.174.234.195
Current Login Time : 2006-08-16 17:13:51
Current Login From : 218.174.234.195

RowNo : PageNo :

- When the following page appears, please type in Nick Name (for the router) and choose the right purchase date from the popup calendar (it appears when you click on the box of Purchase Date).

My Product Search for this site

Device Add

Serial number: 999999999990

Nick Name:

Purchase Date:

August 2006

Wk	Mon	Tue	Wed	Thu	Fri	Sat	Sun
31		1	2	3	4	5	6
32	7	8	9	10	11	12	13
33	14	15	16	17	18	19	20
34	21	22	23	24	25	26	27
35	28	29	30	31			

Today is Wed, 16 Aug 2006

- After adding the basic information for the router, please click **Submit**.

My Product Search for this site

Device Add

Serial number: 999999999990

Nick Name:

Purchase Date:

- Now, your router information has been added to the database. Click **OK** to leave this web page and return to **My Product** web page.

Your device has been successfully added to the database.



From Anti-Spam>>Profile Setting

- Open a web browser on your PC and type **http://192.168.1.1**. A pop-up window will open to ask for username and password.
- From the router's web page, please open **Anti-Spam>>Profile Setting**. You will see the following web page.



- Click the **Activate** link from the **Profile Setting** web page.

Anti-Spam >> Profile Setting

Anti-Spam Profile Table | [Set to Factory Default](#) |

Profile	Name	Profile	Name
1.		9.	
2.		10.	
3.		11.	
4.		12.	
5.		13.	
6.		14.	
7.		15.	
8.		16.	

License [Status :Not Activated]

Service Activation	Activate
--------------------	-----------------

Anti-Spam Authentication Message

Authenticate fail, 2000-01-01 00:01:23

Note: If you want to use email alert or syslog, please configure the [SysLog/Mail Alert Setup](#) page.

- A **Re-login** page will be shown on the screen. Please type the account and password that you created previously. And click **Login**.

Re-login Search for this site GO

This service is available for VigorPro member only. Please login to access VigorPro.
If you are not one of the members of VigorPro, please create an account first.

LOGIN

UserName :

Password :

Auth Code : *thmj*

If you cannot read the word, click here

Don't have a VigorPro Account ?

[Create an account now](#)

If you are having difficulty logging in, contact our customer service.
Customer Service : 886 3 597 2727 or
email to webmaster@dravtek.com

- The following page will be displayed after you logging in VigorPro server. From this page, please click **Add**.

My Product Search for this site GO

Device Registration

Welcome, carrie

Last Login Time : 2006-08-16 17:08:25

Last Login From : 218.174.234.195

Current Login Time : 2006-08-16 17:13:51

Current Login From : 218.174.234.195

RowNo : PageNo :

- When the following page appears, please type in Nick Name (for the router) and choose the right purchase date from the popup calendar (it appears when you click on the box of Purchase Date).

My Product Search for this site GO

Device Add

Serial number: 999999999990

Nick Name:

Purchase Date:

August 2006

Wk	Mon	Tue	Wed	Thu	Fri	Sat	Sun
31		1	2	3	4	5	6
32	7	8	9	10	11	12	13
33	14	15	16	17	18	19	20
34	21	22	23	24	25	26	27
35	28	29	30	31			

Today is Wed, 16 Aug 2006

7. After adding the basic information for the router, please click **Submit**.

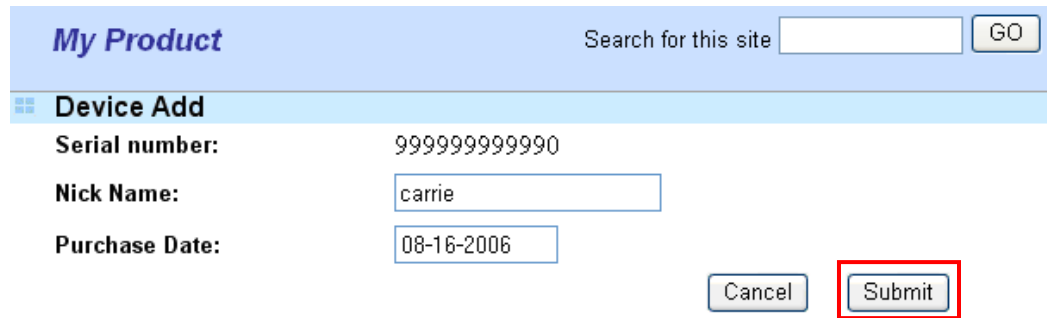

My Product Search for this site

Device Add

Serial number: 999999999990

Nick Name:

Purchase Date:

8. Now, your router information has been added to the database. Click **OK** to leave this web page and return to **My Product** web page.

Your device has been successfully added to the database.



4.4 Activating Anti-Virus/Anti-Intrusion/Anti-Spam Service

After registering your vigor router, you have to follow the steps listed below to activate anti-virus/anti-intrusion/anti-spam service to obtain full security for your computer.

4.4.1 For Anti-Virus and Anti-Intrusion Service

1. Open a web browser on your PC and type **http://192.168.1.1**. A pop-up window will open to ask for username and password.
2. From the router's web page, please open **System Maintenance >>Signature Upgrade**. You will see the following web page.

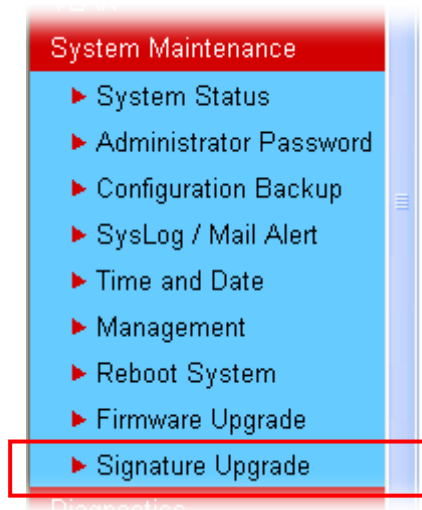

3. Click the **Activate** link from the **Signature Upgrade** web page.

System Maintenance >> Signature Upgrade

License [Status : **Not Activated**]

Service Activation	Activate
---------------------------	--------------------------

Signature Upgrade Setting [Signature Version : **basic**]
[Signature Build Date : **Tue Aug 12 9:16:25.0 2006**]

Setup download server	auto-selected	find more
Setup query server	auto-selected	find more
Signature authentication/download message: <div style="border: 1px solid gray; height: 40px; width: 100%;"></div>		

Upgrade Manually	Import	Backup	Download Now !!!
-------------------------	------------------------	------------------------	----------------------------------

Upgrade Automatically			
<input type="checkbox"/> Scheduled Update			
<input checked="" type="radio"/> Every:	1	(hour)	00 (minutes after the hour)
<input type="radio"/> Daily:	0	(hour)	00 (minute)
<input type="radio"/> Weekly:	Sunday	(day)	0 (hour) 00 (minute)

[OK](#) [Cancel](#)

- A **Re-login** page will be shown on the screen. Please type the account and password that you created previously. And click **Login**.

Re-login Search for this site

This service is available for VigorPro member only. Please login to access VigorPro.
If you are not one of the members of VigorPro, please create an account first.

LOGIN

UserName :

Password :

Auth Code : 

If you cannot read the word, click here

Don't have a VigorPro Account ?

[Create an account now](#)

If you are having difficulty logging in, contact our customer service.
Customer Service : 886 3 697 2727 or
email to : webmaster@dravtek.com

- On the web page of **My Product**, you can find a list of the devices that you add with the above steps. Currently, you just have added VigorPro 5500. Please click the serial number link.

My Product Search for this site

Device Registration

Welcome, carrie
Last Login Time : 2006-08-16 17:08:25
Last Login From : 218.174.234.195
Current Login Time : 2006-08-16 17:13:51
Current Login From : 218.174.234.195

RowNo : PageNo :

Your Devices

Serial Number	Device Name	Model	Note
8888888888990	carrie	VigorPro 5500	-

- From the **Device's Service** section, click the **Activate** buttons for AI-AV (Anti-Intrusion & Anti-Virus) service.

Device Information

Nick Name : [carrie](#)
 Serial : [999999999999](#)
 Model : [VigorPro 5500](#)

Device's Service

Service	Action	Status	Start Date	Expired Date	Provider
ALAV	<input type="button" value="Activate"/> <input type="button" value="Apply"/>	-	-	-	-
AS	<input type="button" value="Activate"/> <input type="button" value="Apply"/>	-	-	-	-

Action

Activate : It allows the user to activate the service provider (DT-DT and DT-KL) dedicated to the router. If the record of the license key exists, the button "Upgrade" will show up instead.

Apply : It allows the user to adopt the selected service provider on the router. It also enables the user to switch one key to the other.

Rename

It allows you to change the account name.

Delete

It allows you to delete account name used currently.

Transfer

It allows you to transfer the VigorPro device together with applied license to someone who has already registered another account in www.vigorpro.com. Be sure to press this button to transfer the product to whom you want to give. Otherwise he/she might not be able to maintain the license hooked up to the VigorPro device.

Back

It allows you to return to the previous account.

- In the following page, check the box of **"I have read and accept the above Agreement"**. The system will find out the date for you to activate this version of service. Then, click **Register**.

My Product Search for this site

Try DrayTek's AV-AI application 30 days free of charge

STEP 1

Service Provider:

STEP 2

Join it!!

STEP 3

 License Agreement PDF Format

DrayTek VigorPro Series End-User License Agreement

IMPORTANT :
 DrayTek IS WILLING TO LICENSE THE ENCLOSED SOFTWARE TO YOU ONLY UPON THE CONDITION THAT YOU ACCEPT ALL OF THE TERMS CONTAINED IN THIS LICENSE AGREEMENT. PLEASE READ THE TERMS CAREFULLY BEFORE COMPLETING THE INSTALLATION PROCESS AS INSTALLING THE SOFTWARE WILL INDICATE YOUR ASSENT TO THEM. IF YOU DO NOT AGREE TO THESE TERMS, THEN DrayTek IS UNWILLING TO LICENSE THE SOFTWARE TO YOU, IN WHICH EVENT YOU SHOULD RETURN THE

I have read and accept the above Agreement. (Please check this box).

STEP 4

Activation Date(MM-DD-YYYY):

Tip : The above information will not be shown after you added and registered both types of license numbers to the database.

Note: DT-DT means you can acquire the anti-intrusion and anti-virus services from DrayTek Corporation.

8. Next, the DrayTek Service Activation screen will be shown as the following:

DrayTek Service Activation

Service Name	Start Date	Expire Date	Status
Anti-Virus	2006-08-16	2006-09-15	DT-DT
Anti-Spam	---	---	Not Activated

Please check if the license fits with the service provider of your signature. To ensure normal operation for your router, update your signature again is recommended.

Copyright © DrayTek Corp. All Rights Reserved.

(Above figure supposes you have not activated Anti-Spam yet.)

9. Click **Close**.

- Return to **Signature Upgrade** page of the router's web configurator. The start date and expire date for the license are shown in this page.

System Maintenance >> Signature Upgrade

License [Status : DT-DT] [Start Date: 2006-08-16 Expire Date: 2006-09-15]

Service Activation **Activate**

Signature Upgrade Setting [Signature Version : basic]
[Signature Build Date : Tue Aug 12 9:16:25.0 2006]

Setup download server auto-selected [find more](#)

Setup query server auto-selected [find more](#)

Now, you have finished all the procedure for registering your router.

If you want to select DT-KL service additionally, repeat step 11 to step 14. Both services will be added into your router. You can apply any one of them for your router through the webpage.

Note: You are allowed to use this version (with anti-intrusion and anti-virus features) for 30 days after you register for your router. In addition, you will be informed with an e-mail before the expiry of this version.

4.4.2 For Anti-Spam Service

Please follow the steps below to activate Anti-Spam Service for your system.

Getting 30 Days of Free Charge

- Open a web browser on your PC and type **http://192.168.1.1**. A pop-up window will open to ask for username and password.
- From the router's web page, please open **Anti-Spam>>Profile Setting**. You will see the following web page.



- Click the **Activate** link from the **Profile Setting** web page.

Anti-Spam >> Profile Setting

Anti-Spam Profile Table [Set to Factory Default](#)

Profile	Name	Profile	Name
1.		9.	
2.		10.	
3.		11.	
4.		12.	
5.		13.	
6.		14.	
7.		15.	
8.		16.	

License [Status :Not Activated]

Service Activation **Activate**

Anti-Spam Authentication Message

```
Authenticate fail, 2000-01-01 00:01:23
```

Note: If you want to use email alert or syslog, please configure the [SysLog/Mail Alert Setup](#) page.

- A **Re-login** page will be shown on the screen. Please type the account and password that you created previously. And click **Login**.

Re-login Search for this site

This service is available for VigorPro member only. Please login to access VigorPro.
If you are not one of the members of VigorPro, please create an account first.

LOGIN

UserName :

Password :

Auth Code : 

If you cannot read the word, [click here](#)

Don't have a VigorPro Account ?

[Create an account now](#)

If you are having difficulty logging in, contact our customer service.
Customer Service : 886 3 597 2727 or
email to webmaster@dravtek.com

- On the web page of **My Product**, you can find a list of the devices that you add with the above steps. Currently, you just have added VigorPro 5500. Please click the serial number link.

My Product Search for this site

Device Registration

Welcome, carrie

Last Login Time : 2006-08-16 17:08:25
Last Login From : 218.174.234.195
Current Login Time : 2006-08-16 17:13:51
Current Login From : 218.174.234.195

RowNo : PageNo :

Your Devices

Serial Number	Device Name	Model	Note
999999999999	carrie	VigorPro 5500	-

- From the **Device's Service** section, click the **Activate** buttons for AS (Anti-Spam) service.

My Product Search for this site

Device Information

Nick Name : [carrie](#)
 Serial : [999999999990](#)
 Model : [VigorPro 5500](#)

Device's Service

Service	Action	Status	Start Date	Expired Date	Provider
AI-AV	<input type="button" value="Activate"/> <input type="button" value="Apply"/>	-	-	-	-
AS	<input type="button" value="Activate"/> <input type="button" value="Apply"/>	-	-	-	-

Action

Activate : It allows the user to activate the service provider (DT-DT and DT-KL) dedicated to the router. If the record of the license key exists, the button "Upgrade" will show up instead.

Apply : It allows the user to adopt the selected service provider on the router. It also enables the user to switch one key to the other.

- In this page, check the box of **"I have read and accept the above Agreement"**. The system will find out the date for you to activate this version of service. Then, click **Register**.

My Product Search for this site

Try DrayTek's Service application 30 days free of charge

STEP 1
Service Provider: CTCH

STEP 2
 Join !!! Join the **Draytek promotion plan**

STEP 3

 License Agreement PDF Format

End User License Agreement
for Anti-Spam service on VigorPro router

Ver 1.0

PLEASE READ THIS SOFTWARE LICENSE AGREEMENT ("LICENSE") CAREFULLY BEFORE DOWNLOADING OR OTHERWISE USING THE SOFTWARE. BY DOWNLOADING, INSTALLING OR USING THE SOFTWARE, YOU ARE AGREEING TO BE BOUND BY THE TERMS OF THIS LICENSE. IF YOU DO NOT AGREE TO THE TERMS OF THIS

I have read and accept the above Agreement. (Please check this box).

STEP 4
Activation Date(MM-DD-YYYY):

Tip : The above information will not be shown after you added and registered both types of license numbers to the database.

Note: CTCH means you can acquire anti-spam service from Commtouch.

- Next, the DrayTek Service Activation screen will be shown as the following.

DrayTek Service Activation

Service Name	Start Date	Expire Date	Status
Anti-Virus	---	---	Not Activated
Anti-Spam	2007-04-14	2007-05-15	CTCH

Please check if the license fits with the service provider of your signature. To ensure normal operation for your router, update your signature again is recommended.

Copyright © DrayTek Corp. All Rights Reserved.

Close

(Above figure supposes you have not activated Anti-Virus yet.)

9. Click **Close**.

Now, you have finished all the procedure for activating Anti-Spam service for your router.

Note: You are allowed to use this version (with anti-spam features) for 30 days after registration for your router. In addition, you will be informed with an e-mail before the expiry of this version.

Upgrade License for Anti-Spam

When thirty days for free of charge expires, you can apply for a new license by following the steps below:

1. Open a web browser on your PC and type **http://192.168.1.1**. A pop-up window will open to ask for username and password.
2. From the router's web page, please open **Anti-Spam>>Profile Setting**. You will see the following web page.



3. Click the **Activate** link from the **Profile Setting** web page.

Anti-Spam >> Profile Setting

Anti-Spam Profile Table | [Set to Factory Default](#) |

Profile	Name	Profile	Name
1.		9.	
2.		10.	
3.		11.	
4.		12.	
5.		13.	
6.		14.	
7.		15.	
8.		16.	

License [Status :CTCH] [Start Date:2007-05-02 Expire Date:2007-06-02]

Service Activation	Activate
---------------------------	-----------------

Anti-Spam Authentication Message

Get new license successful, 2007-05-02 03:53:42

Note: If you want to use email alert or syslog, please configure the [SysLog/Mail Alert Setup](#) page.

4. A **Re-login** page will be shown on the screen. Please type the account and password that you created previously. And click **Login**.

This service is available for VigorPro member only. Please login to access VigorPro.
If you are not one of the members of VigorPro, please create an account first.

LOGIN

UserName :

Password :

Auth Code : *thmj*

If you cannot read the word, click here

Don't have a VigorPro Account ?

[Create an account now](#)

If you are having difficulty logging in, contact our customer service.
Customer Service : 988 3 597 2727 or
email to webmaster@draytek.com

- On the web page of **My Product**, you can find a list of the devices that you add with the above steps. Currently, you just have added VigorPro 5500. Please click the serial number link.

Welcome, carrie
Last Login Time : 2006-08-16 17:08:25
Last Login From : 218.174.234.195
Current Login Time : 2006-08-16 17:13:51
Current Login From : 218.174.234.195

RowNo : PageNo :

Your Devices

Serial Number	Device Name	Model	Note
999999999999	carrie	VigorPro 5500	-

- From the **Device's Service** section, click the **Upgrade** buttons for AS (Anti-Spam) service.

My Product

Search for this site

Device Information

Nick Name : [carrie](#)
Serial : [999999999990](#)
Model : [VigorPro 5500](#)

Device's Service

Service	Action	Status	Start Date	Expired Date	Provider
AI-AV	<input type="button" value="Activate"/> <input type="button" value="Apply"/>	-	-	-	-
AS	<input type="button" value="Upgrade"/> <input type="button" value="Apply"/>	Installed	2007-05-02	2007-06-02	CTCH

Action

Activate : It allows the user to activate the service provider (DT-DT and DT-KL) dedicated to the router. If the record of the license key exists, the button "Upgrade" will show up instead.

Apply : It allows the user to adopt the selected service provider on the router. It also enables the user to switch one key to the other.

- In this page, type the License Number stated on the Anti-Spam license card in the field of **License Number**. Then, click **Add License**.

My Product Search for this site

Apply For A License Number

Service Name: **AS**

STEP 1

License Number :

Tip : To add a new License Number, be aware that it should come from the same Service Provider to avoid conflict.

STEP 2

Join it!! Join the **DrayTek promotion plan**

STEP 3

Activation Date (MM-DD-YYYY):

- Now, the license number will be displayed on the page immediately. Click **Apply**.

My Product Search for this site

Apply For A License Number

Service Name: **AS**

STEP 1

License Number :

Tip : To add a new License Number, be aware that it should come from the same Service Provider to avoid conflict.

Flag	License	Provider	Status
<input type="button" value="del"/>	OCA90-4081A-5E89D-01120	CTCH	valid

STEP 2

Join it!! Join the **DrayTek promotion plan**

STEP 3

Activation Date (MM-DD-YYYY):

- In this page, check the box of “**I have read and accept the above Agreement**”. The system will find out the date for you to activate this version of service. Then, click **Confirm**.

Confirm Message

User Name : carrie
Serial Number : 200705011001
Activate Date : 2007-06-03
Expired Date : 2008-06-02

License Number	Service Provider	Status
OCA90-4081A-5E89D-01120	CTCH	valid

End User License Agreement
for Anti-Spam service on VigorPro router

Ver 1.0

PLEASE READ THIS SOFTWARE LICENSE AGREEMENT ("LICENSE") CAREFULLY BEFORE DOWNLOADING OR OTHERWISE USING THE SOFTWARE. BY DOWNLOADING, INSTALLING OR USING THE SOFTWARE, YOU ARE AGREEING TO BE BOUND BY THE TERMS OF THIS LICENSE. IF YOU DO NOT AGREE TO THE TERMS OF THIS LICENSE, YOU ARE NOT AUTHORIZED TO DOWNLOAD OR USE THIS

I have read and accept the above Agreement. (Please check this box).

- Next, the DrayTek Service Activation screen will be shown as the following.

DrayTek Service Activation

Service Name	Start Date	Expire Date	Status
Anti-Virus	---	---	Not Activated
Anti-Spam	2007-06-03	2008-06-02	CTCH

Please check if the license fits with the service provider of your signature. To ensure normal operation for your router, update your signature again is recommended.

Copyright © DrayTek Corp. All Rights Reserved.

(Above figure supposes you have not activated Anti-Virus yet.)

- Click **Close** to exit.

4.5 Applying a New License for Anti-Intrusion/Anti-Virus

When thirty days for free of charge expires, you can apply for a new license by following the steps below:

1. Open a web browser on your PC and type **http://192.168.1.1**. A pop-up window will open to ask for username and password. Do not type any word on the window and click **OK**.
2. From the router's web page, please open **System Maintenance >>Signature Upgrade**. You will see the following web page.

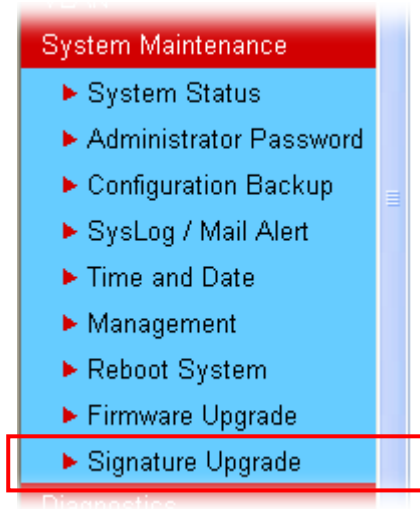

3. Click the **Activate** link from the **Signature Upgrade** web page.

System Maintenance >> Signature Upgrade

License [Status :Not Activated]

Service Activation	Activate
--------------------	-----------------

Signature Upgrade Setting [Signature Version : **basic**]
 [Signature Build Date : **Tue Aug 12 9:16:25.0 2006**]

Setup download server	auto-selected	find more
Setup query server	auto-selected	find more

Signature authentication/download message:

Upgrade Manually

Upgrade Automatically

Scheduled Update

<input checked="" type="radio"/> Every:	1	(hour)	00	(minutes after the hour)
<input type="radio"/> Daily:	0	(hour)	00	(minute)
<input type="radio"/> Weekly:	Sunday	(day)	0	(hour) 00 (minute)

4. A **Re-login** page will be shown on the screen. Please type the account and password that you created previously. And click **Login**.

Re-login Search for this site

This service is available for VigorPro member only. Please login to access VigorPro.
If you are not one of the members of VigorPro, please create an account first.

LOGIN

UserName :

Password :

Auth Code :

If you cannot read the word, click here

Don't have a VigorPro Account ?

[Create an account now](#)

If you are having difficulty logging in, contact our customer service.
Customer Service : 886 3 597 2727 or
email to : webmaster@draytek.com

5. The following page will be displayed after you logging in VigorPro server. From this page, please click **Add**.

My Product Search for this site

Device Registration

Welcome, carrie

Last Login Time : 2006-08-16 17:08:25

Last Login From : 218.174.234.195

Current Login Time : 2006-08-16 17:13:51

Current Login From : 218.174.234.195

RowNo : 1 PageNo :

- When the following page appears, please type in Nick Name (for the router) and choose the right purchase date from the popup calendar (it appears when you click on the box of Purchase Date).

My Product Search for this site

Device Add

Serial number: 999999999990

Nick Name:

Purchase Date:

Wk	Mon	Tue	Wed	Thu	Fri	Sat	Sun
31		1	2	3	4	5	6
32	7	8	9	10	11	12	13
33	14	15	16	17	18	19	20
34	21	22	23	24	25	26	27
35	28	29	30	31			

Today is Wed, 16 Aug 2006

- After adding the basic information for the router, please click **Submit**.

My Product Search for this site

Device Add

Serial number: 999999999990

Nick Name:

Purchase Date:

- Now, your router information has been added to the database. Click **OK** to leave this web page and return to **My Product** web page.

Your device has been successfully added to the database.

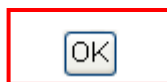

- On the web page of **My Product**, you can find a list of the devices that you add with the above steps. Currently, you just have added VigorPro 5500. Please click the serial number link.

My Product Search for this site

Device Registration

Welcome, **carrie**
 Last Login Time : 2006-08-16 17:08:25
 Last Login From : 218.174.234.195
 Current Login Time : 2006-08-16 17:13:51
 Current Login From : 218.174.234.195

RowNo : PageNo :

Your Devices

Serial Number	Device Name	Model	Note
9999999999990	carrie	VigorPro 5500	-

- From the **Device's Service** section, click the **Activate** button for AI-AV (Anti-Intrusion & Anti-Virus) service.

My Product Search for this site

Device Information

Nick Name : [carrie](#)
 Serial : [9999999999990](#)
 Model : [VigorPro 5500](#)

Device's Service

Service	Action	Status	Start Date	Expired Date	Provider
AI-AV	<input type="button" value="Activate"/> <input type="button" value="Apply"/>	-	-	-	-

Action

Activate : It allows users to add service provider (DT-DT and DT-KL) to the router.

Apply : It allows users to adopt the selected service provider to the router.

- In the following page, please type in license number shown on the License Key card. There are two numbers for your selection, DT-DT (service from Draytek) or DT-KL (service from Kaspersky Lab). Simply enter the one that you want to apply and click **Add License**.

Apply For A License Number

Service Name: Cancel

STEP 1

License Number: Add License

Tip : To add a new License Number, be aware that it should come from the same Service Provider to avoid conflict.

STEP 2

Join It!! Join the **DrayTek promotion plan**

STEP 3

Activation Date (MM-DD-YYYY): Apply

Note: DT-KL allows you to acquire the anti-intrusion service from DrayTek and anti-virus service from Kaspersky. DT-DT allows you to acquire the anti-intrusion and anti-virus services from DrayTek Corporation.

- After typing the license key, click **Add License**. The basic information for the one you selected will be shown on the following page.

Apply For A License Number

Service Name: **AI-AV** Cancel

STEP 1

License Number: Add License

Tip : To add a new License Number, be aware that it should come from the same Service Provider to avoid conflict.

Flag	License Number	Provider	Status
del	DA2D0-C443A-XXXXX-XXXXX	DT-DT	valid

- Next, enter the activation date. Move the mouse to the inserting box and click it. The system will find out the date for you to activate this version of service.

Flag	License	Provider	Status
del	DA2D0-C443A-XXXXX-XXXXX	DT-DT	valid

STEP 2

Join It!! Join the **DrayTek promotion plan**

STEP 3

Activation Date (MM-DD-YYYY): Apply

- Click **Apply** when you finish choosing the date. The following page will be shown to ask your confirmation.

My Product
Search for this site

☰ **Confirm Message**

User Name : carrie

Serial Number : 999999999990

Activate Date : 2006-08-16

Expired Date : 2007-08-15

License Number	Service Provider	Status
DA2D0-C443A-XXXX-XXXX	DT-DT	valid

DrayTek VigorPro Series End-User License Agreement

IMPORTANT :

DrayTek IS WILLING TO LICENSE THE ENCLOSED SOFTWARE TO YOU ONLY UPON THE CONDITION THAT YOU ACCEPT ALL OF THE TERMS CONTAINED IN THIS LICENSE AGREEMENT. PLEASE READ THE TERMS CAREFULLY BEFORE COMPLETING THE INSTALLATION PROCESS AS INSTALLING THE SOFTWARE WILL INDICATE YOUR ASSENT TO THEM. IF YOU DO NOT AGREE TO THESE TERMS, THEN DrayTek IS UNWILLING TO LICENSE THE SOFTWARE TO YOU, IN WHICH EVENT YOU SHOULD RETURN THE

I have read and accept the above Agreement. (Please check this box).

- Check the box of **I have read and accept the above Agreement** and click **Confirm**. The Service Activation screen will be shown as the following.

DrayTek Service Activation

Service Name	Start Date	Expire Date	Status
Anti-Virus	2006-08- 16	2007-08- 15	DT-DT

Copyright © DrayTek Corp. All Rights Reserved.

- Click **Close**.

Return to **Signature Upgrade** page of the router's web configurator. The start date and expire date for the license will be shown in this page.

4.6 Backup and Upgrade Signature for Anti-Intrusion/Anti-Virus

You can get the most updated signature from DrayTek's server if the license key of anti-virus/anti-intrusion for the VigorPro 5500 is not expired. Before you upgrade the signature, please check the validation information either from WEB user interface of VigorPro 5500 or account information from www.vigorpro.com.

1. Open a web browser on your PC and type **http://192.168.1.1**. A pop-up window will open to ask for username and password. Do not type any word on the window and click **OK**.
2. From the router's web page, please open **System Maintenance >>Signature Upgrade**. You will see the following web page.

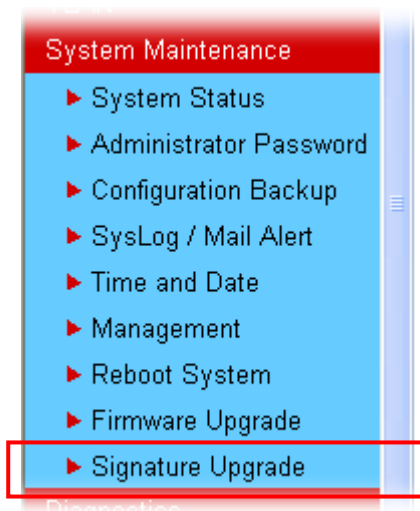

3. On Signature Upgrade web page, locate Backup and Download Now!!!.

System Maintenance >> Signature Upgrade

License [Status : DT-DT] [Start Date : 2006-08-16 Expire Date : 2007-08-15]

Service Activation [Activate](#)

Signature Upgrade Setting [Signature Version : basic]
[Signature Build Date : Tue Aug 12 9:16:25.0 2006]

Setup download server auto-selected [find more](#)
Setup query server auto-selected [find more](#)

Signature authentication/download message:

Upgrade Manually

Upgrade Automatically
 Scheduled Update

Every: 1 (hour) 00 (minutes after the hour)
 Daily: 0 (hour) 00 (minute)
 Weekly: Sunday (day) 0 (hour) 00 (minute)

Time for Backup

Before changing other license, it is suggested for you to backup the original signature first. To backup current signature information with the filename vigorpro.sig, click **Backup**.

Time for Download

After changing other license, it is suggested for you to download newly update signature for your router. To download newly update anti-intrusion and anti-virus from VigorPro website, please click **Download Now!!!**.

Time for Import

Backup files can be imported whenever you want. To use a saved signature information, please click **Import**.

In addition, users can specify certain time for executing the upgrade automatically by the router. Remember to check the **Schedule Update** box and click **OK** to activate the time settings.

4.7 Switching between DT-DT and DT-KL

You can change anti-virus and anti-intrusion service between DT-DT and DT-KL service provider whenever you want. Simply follow the steps below:

1. Open a web browser on your PC and type **http://192.168.1.1**. A pop-up window will open to ask for username and password. Do not type any word on the window and click **OK**.
2. From the router's web page, please open **System Maintenance >>Signature Upgrade**. You will see the following web page.

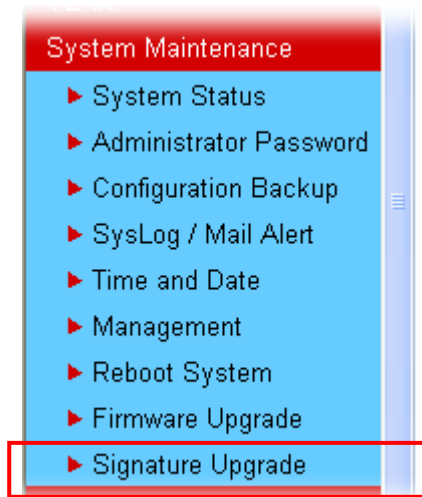

3. Click the **Activate** link from the **Signature Upgrade** web page. Remember that the license currently selected is DT-DT. Therefore, you can switch into DT-KL if you want.

System Maintenance >> Signature Upgrade

License [Status : DT-DT] [Start Date: 2006-08-16 Expire Date: 2007-08-15]

Service Activation	Activate
--------------------	-----------------

Signature Upgrade Setting [Signature Version : DT-DT_1_61_5_4]
[Signature Build Date : Tue Aug 12 9:16:25.0 2006]

Setup download server	auto-selected	find more
Setup query server	auto-selected	find more

4. A **Re-login** page will be shown on the screen. Please type new account and password that you created previously. And click **Login**.

Re-login Search for this site

This service is available for VigorPro member only. Please login to access VigorPro.
If you are not one of the members of VigorPro, please create an account first.

LOGIN

UserName :

Password :

Auth Code : 

If you cannot read the word, click here

Don't have a VigorPro Account ?

[Create an account now](#)

If you are having difficulty logging in, contact our customer service.
Customer Service : 886 3 597 2727 or
email to : webmaster@draytek.com

The following page will be shown automatically. You will find there are two devices service added to your router. If you activated only one service before, it must be only one service displayed here. In this case, DT-DT and DT-KL services are registered on the VirgorPro website. However, DT-DT service is installed into the router at present.

My Product
Search for this site

Device Information

Nick Name : [carrieni](#)

Serial : [999999999999](#)

Model : [VigorPro 5500](#)

Device's Service

Service	Action	Status	Start Date	Expired Date	Provider
AI-AV	<input type="button" value="Upgrade"/> <input type="button" value="Apply"/>	Installed	2006-06-26	2007-06-26	DT-DT
AI-AV	<input type="button" value="Upgrade"/> <input type="button" value="Apply"/>	Registered	2006-06-29	2007-06-29	DT-KL

Action

Upgrade : It allows user to update a new license for the specified service provider.

Apply : It allows users to adopt the selected service provider to the router.

Status

Installed : It means the service provider has been added to your router and is the one used currently.

Registered : It means the service provider has been added to your router and waits for applying.

Upgrade allows you to upgrade a new license for specified service provider (DT-DT or DT-KL). Click the **Upgrade** button according to the license of provider (DT-DT or DT-KL) you purchased to update a new license.

Apply allows you to adopt the anti-virus and anti-intrusion service that provided by the selected service provider for your router. You can apply only one Provider with AI-AV at one time.

5. Click **Apply** on the line with DT-KL service to activate that service.
6. Now, you have successfully switched the service provider for your router.

4.8 Enabling Anti-Virus/Anti-Intrusion/Anti-Spam

After applying an account, registering your account and router, you have to access into the web page of Vigor router to enable Anti-Virus/Anti-Intrusion function. There are two ways to enable it.

- A. For the default rule of firewall, please open **Firewall>>General Setup** page. Check the box of **Enable** for Anti-Intrusion and choose proper action (profile) from the drop down list of Anti-Virus and Anti-Spam. Next, click **OK** to finish the procedure of activation.

Firewall >> General Setup

General Setup

Call Filter	<input checked="" type="radio"/> Enable	Start Filter Set
	<input type="radio"/> Disable	
Data Filter	<input checked="" type="radio"/> Enable	Start Filter Set
	<input type="radio"/> Disable	

Actions for default rule:

Application Filter	Action/Profile
Content Security Management	None
Anti-Virus	None
Anti-Intrusion:	<input checked="" type="checkbox"/> Enable
Anti-Spam	None

- B. For specified filter rule (there are twelve filter sets in Firewall, and each set is allowed to set seven filter rules), please check the box of **Enable** for Anti-Intrusion and choose proper action (profile) from the drop down list of Anti-Virus/Anti-Spam. Next, click **OK** to finish the procedure of activation.

Firewall >> Edit Filter Set >> Edit Filter Rule

Filter Set 1 Rule 1

<input checked="" type="checkbox"/> Check to enable the Filter Rule		
Comments:	Block NetBios	
Index(1-15) in Schedule Setup:	, , ,	
Direction:	LAN -> WAN	
Source IP:	Any	<input type="button" value="Edit"/>
Destination IP:	Any	<input type="button" value="Edit"/>
Service Type:	TCP/UDP, Port: from 137~139 to any	<input type="button" value="Edit"/>
Fragments:	Don't Care	
Application	Action/Profile	Syslog
Filter:	Pass If No Further Match	<input type="checkbox"/>
Branch to Other Filter Set:	None	
Content Security Management:	None	<input type="checkbox"/>
Anti-Virus:	None	<input type="checkbox"/>
Anti-Intrusion:	<input type="checkbox"/> Enable	<input type="checkbox"/>
Anti-Spam:	None	<input type="checkbox"/>

If you **did not** check the Anti-Intrusion box and choose a proper profile for Anti-Virus/Anti-Spam, you still **cannot use** the Anti-Intrusion/Anti-Virus/Anti-Spam function even if you finished all the relational profiles.

5

Application and Examples

5.1 Create a LAN-to-LAN Connection Between Remote Office and Headquarter

The most common case is that you may want to connect to network securely, such as the remote branch office and headquarter. According to the network structure as shown in the below illustration, you may follow the steps to create a LAN-to-LAN profile. These two networks (LANs) should NOT have the same network address.

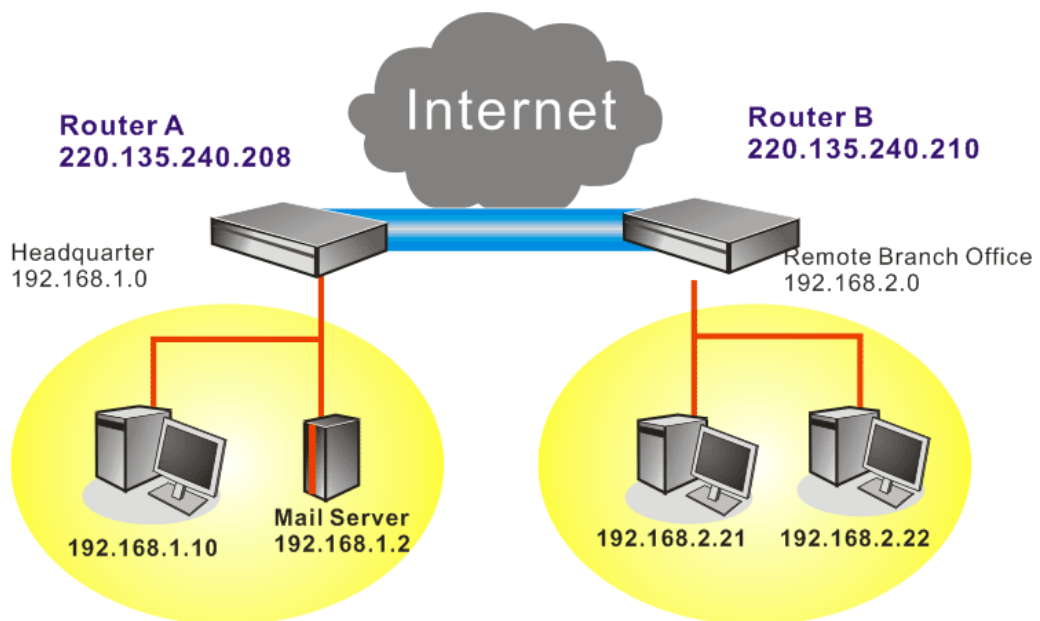

Settings in Router A in headquarter:

1. Go to **VPN and Remote Access** and select **Remote Access Control** to enable the necessary VPN service and click **OK**.
2. Then,
For using **PPP** based services, such as PPTP, L2TP, you have to set general settings in **PPP General Setup**.

VPN and Remote Access >> PPP General Setup

PPP General Setup	
PPP/MP Protocol	
Dial-In PPP Authentication	PAP or CHAP
Dial-In PPP Encryption (MPPE)	Optional MPPE
Mutual Authentication (PAP)	<input type="radio"/> Yes <input checked="" type="radio"/> No
Username	<input type="text"/>
Password	<input type="text"/>

IP Address Assignment for Dial-In Users	
Start IP Address	192.168.1.200

OK

For using **IPSec**-based service, such as IPSec or L2TP with IPSec Policy, you have to set general settings in **IPSec General Setup**, such as the pre-shared key that both parties have known.

VPN and Remote Access >> IPSec General Setup

VPN IKE/IPSec General Setup
Dial-in Set up for Remote Dial-in users and Dynamic IP Client (LAN to LAN).

IKE Authentication Method	
Pre-Shared Key	•••••
Re-type Pre-Shared Key	•••••
IPSec Security Method	
<input checked="" type="checkbox"/> Medium (AH)	Data will be authentic, but will not be encrypted.
High (ESP)	<input checked="" type="checkbox"/> DES <input checked="" type="checkbox"/> 3DES <input checked="" type="checkbox"/> AES
Data will be encrypted and authentic.	

OK Cancel

3. Go to **LAN-to-LAN**. Click on one index number to edit a profile.
4. Set **Common Settings** as shown below. You should enable both of VPN connections because any one of the parties may start the VPN connection.

VPN and Remote Access >> LAN to LAN

Profile Index : 1
1. Common Settings

Profile Name	Branch1	Call Direction	<input checked="" type="radio"/> Both <input type="radio"/> Dial-Out <input type="radio"/> Dial-In
<input checked="" type="checkbox"/> Enable this profile		<input type="checkbox"/> Always on	
VPN Connection Through:	WAN1 First	Idle Timeout	300 second(s)
		<input type="checkbox"/> Enable PING to keep alive	
		PING to the IP	<input type="text"/>

5. Set **Dial-Out Settings** as shown below to dial to connect to Router B aggressively with the selected Dial-Out method.
If an **IPSec-based** service is selected, you should further specify the remote peer IP Address, IKE Authentication Method and IPSec Security Method for this Dial-Out connection.

2. Dial-Out Settings

Type of Server I am calling <input type="radio"/> ISDN <input type="radio"/> PPTP <input checked="" type="radio"/> IPsec Tunnel <input type="radio"/> L2TP with IPsec Policy None	Link Type 64k bps Username ??? Password PPP Authentication PAP/CHAP VJ Compression <input checked="" type="radio"/> On <input type="radio"/> Off
Dial Number for ISDN or Server IP/Host Name for VPN. (such as 5551234, draytek.com or 123.45.67.89) 220.135.240.210	IKE Authentication Method <input checked="" type="radio"/> Pre-Shared Key IKE Pre-Shared Key <input type="radio"/> Digital Signature(X.509) None
	IPsec Security Method <input checked="" type="radio"/> Medium(AH) <input type="radio"/> High(ESP) DES without Authentication Advanced
	Index(1-15) in Schedule Setup:
	Callback Function (CBCP) <input type="checkbox"/> Require Remote to Callback <input type="checkbox"/> Provide ISDN Number to Remote

If a **PPP-based service** is selected, you should further specify the remote peer IP Address, Username, Password, PPP Authentication and VJ Compression for this Dial-Out connection.

2. Dial-Out Settings

Type of Server I am calling <input type="radio"/> ISDN <input checked="" type="radio"/> PPTP <input type="radio"/> IPsec Tunnel <input type="radio"/> L2TP with IPsec Policy None	Link Type 64k bps Username draytek Password ***** PPP Authentication PAP/CHAP VJ Compression <input checked="" type="radio"/> On <input type="radio"/> Off
Dial Number for ISDN or Server IP/Host Name for VPN. (such as 5551234, draytek.com or 123.45.67.89) 220.135.240.210	IKE Authentication Method <input checked="" type="radio"/> Pre-Shared Key IKE Pre-Shared Key <input type="radio"/> Digital Signature(X.509) None
	IPsec Security Method <input checked="" type="radio"/> Medium(AH) <input type="radio"/> High(ESP) DES without Authentication Advanced
	Index(1-15) in Schedule Setup:
	Callback Function (CBCP) <input type="checkbox"/> Require Remote to Callback <input type="checkbox"/> Provide ISDN Number to Remote

- Set **Dial-In settings** to as shown below to allow Router B dial-in to build VPN connection.

If an **IPsec-based** service is selected, you may further specify the remote peer IP Address, IKE Authentication Method and IPsec Security Method for this Dial-In connection. Otherwise, it will apply the settings defined in **IPsec General Setup** above.

3. Dial-In Settings

Allowed Dial-In Type <input type="checkbox"/> ISDN <input type="checkbox"/> PPTP <input checked="" type="checkbox"/> IPsec Tunnel <input type="checkbox"/> L2TP with IPsec Policy None <input checked="" type="checkbox"/> Specify ISDN CLID or Remote VPN Gateway Peer ISDN Number or Peer VPN Server IP <input type="text" value="220.135.240.210"/> or Peer ID <input type="text"/>	Username <input type="text" value="???"/> Password <input type="text"/> VJ Compression <input checked="" type="radio"/> On <input type="radio"/> Off IKE Authentication Method <input checked="" type="checkbox"/> Pre-Shared Key <input type="text" value="IKE Pre-Shared Key"/> <input type="checkbox"/> Digital Signature(X.509) None IPsec Security Method <input checked="" type="checkbox"/> Medium (AH) High (ESP) <input checked="" type="checkbox"/> DES <input checked="" type="checkbox"/> 3DES <input checked="" type="checkbox"/> AES Callback Function (CBCP) <input type="checkbox"/> Enable Callback Function <input type="checkbox"/> Use the Following Number to Callback Callback Number <input type="text"/> Callback Budget <input type="text" value="0"/> minute(s)
--	---

If a **PPP-based service** is selected, you should further specify the remote peer IP Address, Username, Password, and VJ Compression for this Dial-In connection.

3. Dial-In Settings

Allowed Dial-In Type <input type="checkbox"/> ISDN <input checked="" type="checkbox"/> PPTP <input type="checkbox"/> IPsec Tunnel <input type="checkbox"/> L2TP with IPsec Policy None <input checked="" type="checkbox"/> Specify ISDN CLID or Remote VPN Gateway Peer ISDN Number or Peer VPN Server IP <input type="text" value="220.135.240.210"/> or Peer ID <input type="text"/>	Username <input type="text" value="draytek"/> Password <input type="text" value="*****"/> VJ Compression <input checked="" type="radio"/> On <input type="radio"/> Off IKE Authentication Method <input checked="" type="checkbox"/> Pre-Shared Key <input type="text" value="IKE Pre-Shared Key"/> <input type="checkbox"/> Digital Signature(X.509) None IPsec Security Method <input checked="" type="checkbox"/> Medium (AH) High (ESP) <input checked="" type="checkbox"/> DES <input checked="" type="checkbox"/> 3DES <input checked="" type="checkbox"/> AES Callback Function (CBCP) <input type="checkbox"/> Enable Callback Function <input type="checkbox"/> Use the Following Number to Callback Callback Number <input type="text"/> Callback Budget <input type="text" value="0"/> minute(s)
--	---

- At last, set the remote network IP/subnet in **TCP/IP Network Settings** so that Router A can direct the packets destined to the remote network to Router B via the VPN connection.

4. TCP/IP Network Settings

My WAN IP <input type="text" value="0.0.0.0"/> Remote Gateway IP <input type="text" value="0.0.0.0"/> Remote Network IP <input type="text" value="192.168.2.0"/> Remote Network Mask <input type="text" value="255.255.255.0"/> <input type="button" value="More"/>	RIP Direction Disable For NAT operation, treat remote subnet as Private IP <input type="checkbox"/> Change default route to this VPN tunnel
---	---

Settings in Router B in the remote office:

- Go to **VPN and Remote Access** and select **Remote Access Control** to enable the necessary VPN service and click **OK**.

- Then, for using **PPP based** services, such as PPTP, L2TP, you have to set general settings in **PPP General Setup**.

VPN and Remote Access >> PPP General Setup

PPP General Setup

<p>PPP/MP Protocol</p> <p>Dial-In PPP Authentication <input type="text" value="PAP or CHAP"/></p> <p>Dial-In PPP Encryption (MPPE) <input type="text" value="Optional MPPE"/></p> <p>Mutual Authentication (PAP) <input type="radio"/> Yes <input checked="" type="radio"/> No</p> <p>Username <input type="text"/></p> <p>Password <input type="text"/></p>	<p>IP Address Assignment for Dial-In Users</p> <p>Start IP Address <input type="text" value="192.168.2.200"/></p>
---	--

For using **IPSec-based** service, such as IPSec or L2TP with IPSec Policy, you have to set general settings in **IPSec General Setup**, such as the pre-shared key that both parties have known.

VPN and Remote Access >> IPSec General Setup

VPN IKE/IPSec General Setup

Dial-in Set up for Remote Dial-in users and Dynamic IP Client (LAN to LAN).

<p>IKE Authentication Method</p> <p>Pre-Shared Key <input type="text" value="....."/></p> <p>Re-type Pre-Shared Key <input type="text" value="....."/></p> <p>IPSec Security Method</p> <p><input checked="" type="checkbox"/> Medium (AH) Data will be authentic, but will not be encrypted.</p> <p>High (ESP) <input checked="" type="checkbox"/> DES <input checked="" type="checkbox"/> 3DES <input checked="" type="checkbox"/> AES Data will be encrypted and authentic.</p>
--

- Go to **LAN-to-LAN**. Click on one index number to edit a profile.
- Set **Common Settings** as shown below. You should enable both of VPN connections because any one of the parties may start the VPN connection.

VPN and Remote Access >> LAN to LAN

Profile Index : 1

1. Common Settings

<p>Profile Name <input type="text" value="Branch1"/></p> <p><input checked="" type="checkbox"/> Enable this profile</p> <p>VPN Connection Through: <input type="text" value="WAN1 First"/></p>	<p>Call Direction <input checked="" type="radio"/> Both <input type="radio"/> Dial-Out <input type="radio"/> Dial-In</p> <p><input type="checkbox"/> Always on</p> <p>Idle Timeout <input type="text" value="300"/> second(s)</p> <p><input type="checkbox"/> Enable PING to keep alive</p> <p>PING to the IP <input type="text"/></p>
--	--

- Set **Dial-Out Settings** as shown below to dial to connect to Router B aggressively with the selected Dial-Out method.

If an **IPSec-based** service is selected, you should further specify the remote peer IP Address, IKE Authentication Method and IPSec Security Method for this Dial-Out

connection.

2. Dial-Out Settings

Type of Server I am calling <input type="radio"/> ISDN <input type="radio"/> PPTP <input checked="" type="radio"/> IPsec Tunnel <input type="radio"/> L2TP with IPsec Policy None	Link Type 64k bps Username ??? Password PPP Authentication PAP/CHAP VJ Compression <input checked="" type="radio"/> On <input type="radio"/> Off
Dial Number for ISDN or Server IP/Host Name for VPN. (such as 5551234, draytek.com or 123.45.67.89) 220.135.240.208	IKE Authentication Method <input checked="" type="radio"/> Pre-Shared Key IKE Pre-Shared Key <input type="radio"/> Digital Signature(X.509) None
	IPsec Security Method <input checked="" type="radio"/> Medium(AH) <input type="radio"/> High(ESP) DES without Authentication Advanced
	Index(1-15) in Schedule Setup:
	Callback Function (CBCP) <input type="checkbox"/> Require Remote to Callback <input type="checkbox"/> Provide ISDN Number to Remote

If a **PPP-based** service is selected, you should further specify the remote peer IP Address, Username, Password, PPP Authentication and VJ Compression for this Dial-Out connection.

2. Dial-Out Settings

Type of Server I am calling <input type="radio"/> ISDN <input checked="" type="radio"/> PPTP <input type="radio"/> IPsec Tunnel <input type="radio"/> L2TP with IPsec Policy None	Link Type 64k bps Username draytek Password ••••• PPP Authentication PAP/CHAP VJ Compression <input checked="" type="radio"/> On <input type="radio"/> Off
Dial Number for ISDN or Server IP/Host Name for VPN. (such as 5551234, draytek.com or 123.45.67.89) 220.135.240.208	IKE Authentication Method <input checked="" type="radio"/> Pre-Shared Key IKE Pre-Shared Key <input type="radio"/> Digital Signature(X.509) None
	IPsec Security Method <input checked="" type="radio"/> Medium(AH) <input type="radio"/> High(ESP) DES without Authentication Advanced
	Index(1-15) in Schedule Setup:
	Callback Function (CBCP) <input type="checkbox"/> Require Remote to Callback <input type="checkbox"/> Provide ISDN Number to Remote

6. Set **Dial-In settings** to as shown below to allow Router A dial-in to build VPN connection.

If an **IPsec-based** service is selected, you may further specify the remote peer IP Address, IKE Authentication Method and IPsec Security Method for this Dial-In connection. Otherwise, it will apply the settings defined in **IPsec General Setup** above.

3. Dial-In Settings

Allowed Dial-In Type <input type="checkbox"/> ISDN <input type="checkbox"/> pPTP <input checked="" type="checkbox"/> IPsec Tunnel <input type="checkbox"/> L2TP with IPsec Policy None <input checked="" type="checkbox"/> Specify ISDN CLID or Remote VPN Gateway Peer ISDN Number or Peer VPN Server IP <input type="text" value="220.135.240.208"/> or Peer ID <input type="text"/>	Username <input type="text" value="???"/> Password <input type="text"/> VJ Compression <input checked="" type="radio"/> On <input type="radio"/> Off IKE Authentication Method <input checked="" type="checkbox"/> Pre-Shared Key <input type="text" value="IKE Pre-Shared Key"/> <input type="checkbox"/> Digital Signature(X.509) None IPsec Security Method <input checked="" type="checkbox"/> Medium (AH) High (ESP) <input checked="" type="checkbox"/> DES <input checked="" type="checkbox"/> 3DES <input checked="" type="checkbox"/> AES Callback Function (CBCP) <input type="checkbox"/> Enable Callback Function <input type="checkbox"/> Use the Following Number to Callback Callback Number <input type="text"/> Callback Budget <input type="text" value="0"/> minute(s)
--	---

If a **PPP-based** service is selected, you should further specify the remote peer IP Address, Username, Password, and VJ Compression for this Dial-In connection.

3. Dial-In Settings

Allowed Dial-In Type <input type="checkbox"/> ISDN <input checked="" type="checkbox"/> pPTP <input type="checkbox"/> IPsec Tunnel <input type="checkbox"/> L2TP with IPsec Policy None <input checked="" type="checkbox"/> Specify ISDN CLID or Remote VPN Gateway Peer ISDN Number or Peer VPN Server IP <input type="text" value="220.135.240.208"/> or Peer ID <input type="text"/>	Username <input type="text" value="draytek"/> Password <input type="text" value="*****"/> VJ Compression <input checked="" type="radio"/> On <input type="radio"/> Off IKE Authentication Method <input checked="" type="checkbox"/> Pre-Shared Key <input type="text" value="IKE Pre-Shared Key"/> <input type="checkbox"/> Digital Signature(X.509) None IPsec Security Method <input checked="" type="checkbox"/> Medium (AH) High (ESP) <input checked="" type="checkbox"/> DES <input checked="" type="checkbox"/> 3DES <input checked="" type="checkbox"/> AES Callback Function (CBCP) <input type="checkbox"/> Enable Callback Function <input type="checkbox"/> Use the Following Number to Callback Callback Number <input type="text"/> Callback Budget <input type="text" value="0"/> minute(s)
--	---

- At last, set the remote network IP/subnet in **TCP/IP Network Settings** so that Router B can direct the packets destined to the remote network to Router A via the VPN connection.

4. TCP/IP Network Settings

My WAN IP <input type="text" value="0.0.0.0"/> Remote Gateway IP <input type="text" value="0.0.0.0"/> Remote Network IP <input type="text" value="192.168.1.0"/> Remote Network Mask <input type="text" value="255.255.255.0"/> <input type="button" value="More"/>	RIP Direction Disable For NAT operation, treat remote subnet as Private IP <input type="checkbox"/> Change default route to this VPN tunnel
---	---

5.2 Create a Remote Dial-in User Connection Between the Teleworker and Headquarter

The other common case is that you, as a teleworker, may want to connect to the enterprise network securely. According to the network structure as shown in the below illustration, you may follow the steps to create a Remote User Profile and install Smart VPN Client on the remote host.

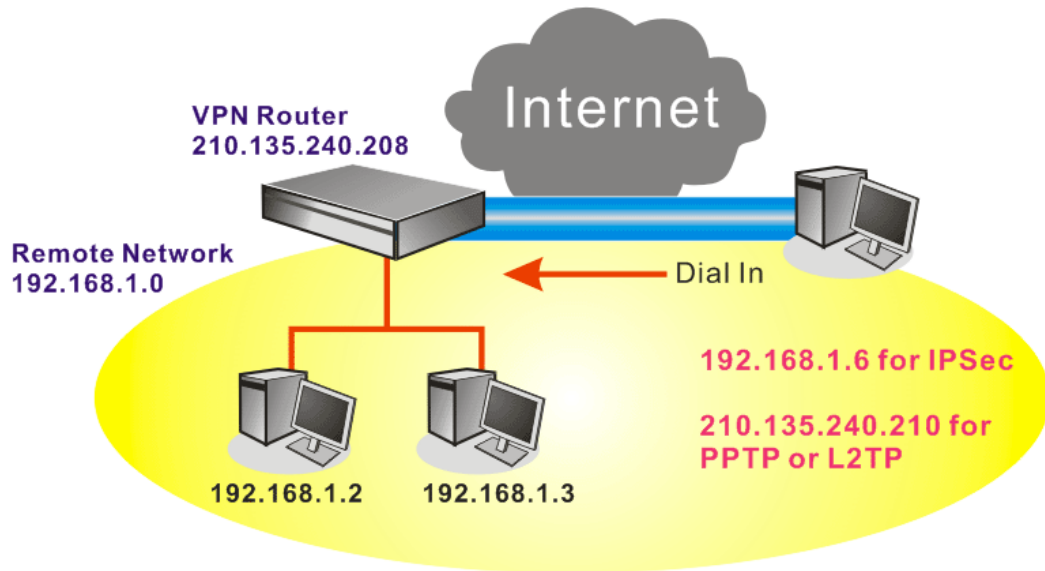

Settings in VPN Router in the enterprise office:

1. Go to **VPN and Remote Access** and select **Remote Access Control** to enable the necessary VPN service and click **OK**.
2. Then, for using PPP based services, such as PPTP, L2TP, you have to set general settings in **PPP General Setup**.

VPN and Remote Access >> PPP General Setup

PPP General Setup	
PPP/MP Protocol	
Dial-In PPP Authentication	PAP or CHAP
Dial-In PPP Encryption (MPPE)	Optional MPPE
Mutual Authentication (PAP)	<input type="radio"/> Yes <input checked="" type="radio"/> No
Username	<input type="text"/>
Password	<input type="text"/>
IP Address Assignment for Dial-In Users	
Start IP Address	192.168.1.200

For using IPSec-based service, such as IPSec or L2TP with IPSec Policy, you have to set general settings in **IKE/IPSec General Setup**, such as the pre-shared key that both parties have known.

VPN and Remote Access >> IPSec General Setup

VPN IKE/IPSec General Setup

Dial-in Set up for Remote Dial-in users and Dynamic IP Client (LAN to LAN).

IKE Authentication Method	
Pre-Shared Key
Re-type Pre-Shared Key
IPSec Security Method	
<input checked="" type="checkbox"/> Medium (AH)	Data will be authentic, but will not be encrypted.
High (ESP)	<input checked="" type="checkbox"/> DES <input checked="" type="checkbox"/> 3DES <input checked="" type="checkbox"/> AES
Data will be encrypted and authentic.	

OK Cancel

3. Go to **Remote Dial-In Users**. Click on one index number to edit a profile.
4. Set **Dial-In** settings to as shown below to allow the remote user dial-in to build VPN connection.

If an **IPSec** service is selected, you may further specify the remote peer IP Address, IKE Authentication Method and IPSec Security Method for this Dial-In connection. Otherwise, it will apply the settings defined in **IPSec General Setup** above.

VPN and Remote Access >> Remote Dial-in User

Index No. 1

User account and Authentication <input checked="" type="checkbox"/> Enable this account Idle Timeout: 300 second(s)	Username: ??? Password:
Allowed Dial-In Type <input type="checkbox"/> ISDN <input type="checkbox"/> PPTP <input checked="" type="checkbox"/> IPSec Tunnel <input type="checkbox"/> L2TP with IPSec Policy: None	IKE Authentication Method <input checked="" type="checkbox"/> Pre-Shared Key IKE Pre-Shared Key: <input type="checkbox"/> Digital Signature (X.509) None
<input checked="" type="checkbox"/> Specify Remote Node Remote Client IP or Peer ISDN Number: 210.135.240.210 or Peer ID:	IPSec Security Method <input checked="" type="checkbox"/> Medium (AH) High (ESP) <input checked="" type="checkbox"/> DES <input checked="" type="checkbox"/> 3DES <input checked="" type="checkbox"/> AES Local ID: (optional)
	Callback Function <input type="checkbox"/> Check to enable Callback function <input type="checkbox"/> Specify the callback number Callback Number: <input checked="" type="checkbox"/> Check to enable Callback Budget Control Callback Budget: 30 minute(s)

OK Clear Cancel

If a **PPTP** service is selected, you should further specify the remote peer IP Address, Username, Password, and VJ Compression for this Dial-In connection.

Index No. 1

User account and Authentication <input checked="" type="checkbox"/> Enable this account Idle Timeout: <input type="text" value="300"/> second(s)		Username: <input type="text" value="???"/> Password: <input type="password"/>
Allowed Dial-In Type <input type="checkbox"/> ISDN <input checked="" type="checkbox"/> PPTP <input type="checkbox"/> IPsec Tunnel <input type="checkbox"/> L2TP with IPsec Policy: <input type="text" value="None"/>		IKE Authentication Method <input checked="" type="checkbox"/> Pre-Shared Key IKE Pre-Shared Key: <input type="text"/> <input type="checkbox"/> Digital Signature (X.509) <input type="text" value="None"/>
<input checked="" type="checkbox"/> Specify Remote Node Remote Client IP or Peer ISDN Number: <input type="text" value="210.135.240.210"/> or Peer ID: <input type="text"/>		IPsec Security Method <input checked="" type="checkbox"/> Medium (AH) <input checked="" type="checkbox"/> High (ESP) <input checked="" type="checkbox"/> DES <input checked="" type="checkbox"/> 3DES <input checked="" type="checkbox"/> AES Local ID: <input type="text"/> (optional)
Callback Function <input type="checkbox"/> Check to enable Callback function <input type="checkbox"/> Specify the callback number Callback Number: <input type="text"/> <input checked="" type="checkbox"/> Check to enable Callback Budget Control Callback Budget: <input type="text" value="30"/> minute(s)		

Settings in the remote host:

- For Win98/ME, you may use "Dial-up Networking" to create the PPTP tunnel to Vigor router. For Win2000/XP, please use "Network and Dial-up connections" or "Smart VPN Client", complimentary software to help you create PPTP, L2TP, and L2TP over IPsec tunnel. You can find it in CD-ROM in the package or go to www.draytek.com download center. Install as instructed.
- After successful installation, for the first time user, you should click on the **Step 0. Configure** button. Reboot the host.



- In **Step 2. Connect to VPN Server**, click **Insert** button to add a new entry.

If an IPsec-based service is selected as shown below,

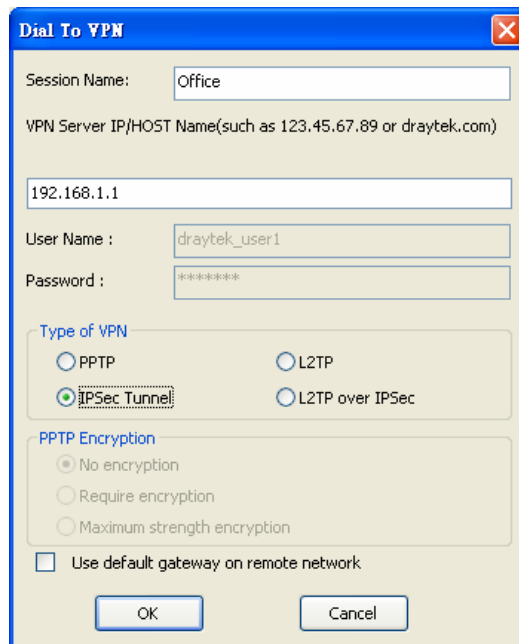

You may further specify the method you use to get IP, the security method, and authentication method. If the Pre-Shared Key is selected, it should be consistent with the one set in VPN router.

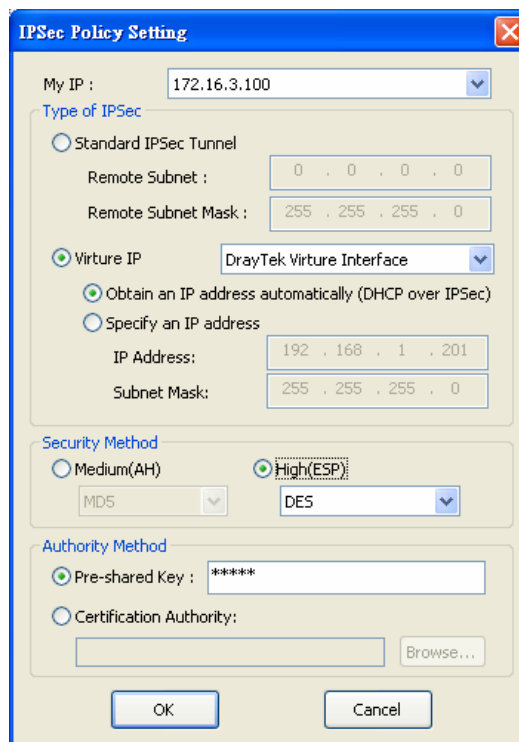

If a PPP-based service is selected, you should further specify the remote VPN server IP address, Username, Password, and encryption method. The User Name and Password should be consistent with the one set up in the VPN router. To use default gateway on remote network means that all the packets of remote host will be directed to VPN server then forwarded to Internet. This will make the remote host seem to be working in the enterprise network.

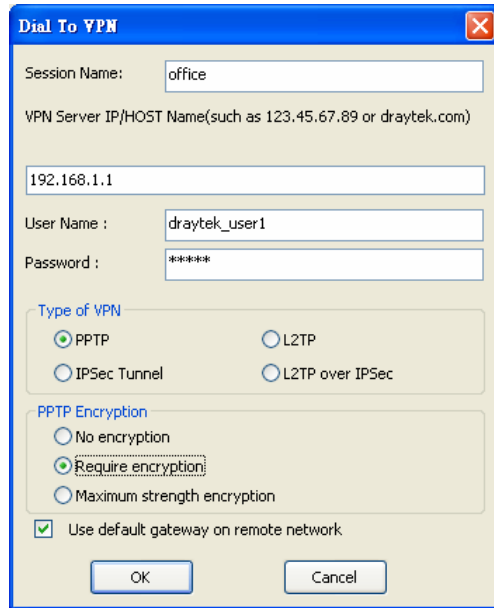

4. Click **Connect** button to build connection. When the connection is successful, you will find a green light on the right down corner.

5.3 QoS Setting Example

Assume a teleworker sometimes works at home and takes care of children. When working time, he would use Vigor router at home to connect to the server in the headquarter office downtown via either HTTPS or VPN to check email and access internal database. Meanwhile, children may chat on Skype in the restroom.

1. Go to **Bandwidth Management>>Quality of Service**.

Bandwidth Management >> Quality of Service

General Setup

Index	Status	Bandwidth	Direction	Class 1	Class 2	Class 3	Others	UDP Bandwidth Control	
WAN1	Disable	10000Kbps/10000Kbps		25%	25%	25%	25%	Inactive	Setup
WAN2	Disable	10000Kbps/10000Kbps		25%	25%	25%	25%	Inactive	Setup

Class Rule

Index	Name	Rule	Service Type
Class 1		Edit	Edit
Class 2		Edit	
Class 3		Edit	

2. Click **Setup** link for WAN1. Make sure the QoS Control on the left corner is checked. And select **BOTH** as the **Direction**.

WAN1 General Setup

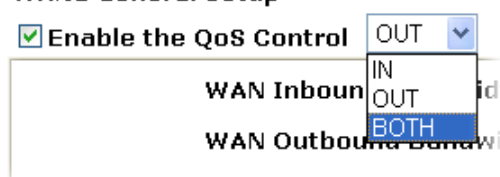

- Return to previous page. Enter the Name of Index Class 1 by clicking **Edit** link. Type the name “**E-mail**” for Class 1.

Bandwidth Management >> Quality of Service

Class Index # 1
 Name

NO	Status	Local Address	Remote Address	DiffServ CodePoint	Service Type
1	Active	Any	Any	IP precedence 2	SMTP(TCP:25)

- For this index, the user will set reserved bandwidth (e.g., 25%) for **Email** using protocol POP3 and SMTP.

Bandwidth Management >> Quality of Service

WAN1 General Setup

Enable the QoS Control OUT

WAN Inbound Bandwidth Kbps

WAN Outbound Bandwidth Kbps

Index	Class Name	Reserved_bandwidth Ratio
Class 1		<input style="border: 1px solid red;" type="text" value="25"/> %
Class 2		<input type="text" value="25"/> %
Class 3		<input type="text" value="25"/> %
	Others	<input type="text" value="25"/> %

Enable UDP Bandwidth Control Limited_bandwidth Ratio %

Outbound TCP ACK Prioritize

- Return to previous page. Enter the Name of Index Class 2 by clicking **Edit** link. In this index, the user will set reserved bandwidth (e.g., 25%) for **HTTP**.
- Click **Setup** link for WAN1.

Bandwidth Management >> Quality of Service

General Setup

Index	Status	Bandwidth	Directon	Class 1	Class 2	Class 3	Others	UDP Bandwidth Control	
WAN1	Disable	10000Kbps/10000Kbps		25%	25%	25%	25%	Inactive	Setup
WAN2	Disable	10000Kbps/10000Kbps		25%	25%	25%	25%	Inactive	Setup

Class Rule

Index	Name	Rule	Service Type
Class 1		Edit	
Class 2		Edit	Edit
Class 3		Edit	

- Check **Enable UDP Bandwidth Control** on the bottom to prevent enormous UDP traffic of VoIP influent other application, and click OK.

Bandwidth Management >> Quality of Service

WAN1 General Setup

Enable the QoS Control OUT

WAN Inbound Bandwidth 10000 Kbps

WAN Outbound Bandwidth 10000 Kbps

Index	Class Name	Reserved Bandwidth Ratio
Class 1		25 %
Class 2		25 %
Class 3		25 %
	Others	25 %

Enable UDP Bandwidth Control

Limited_bandwidth Ratio 25 %

Outbound TCP ACK Prioritize

OK Clear Cancel

- If the worker has connected to the headquarter using host to host VPN tunnel. (Please refer to Chapter 3 VPN for detail instruction), he may set up an index for it. Enter the Class Name of Index 3. In this index, he will set reserve bandwidth for 1 VPN tunnel.

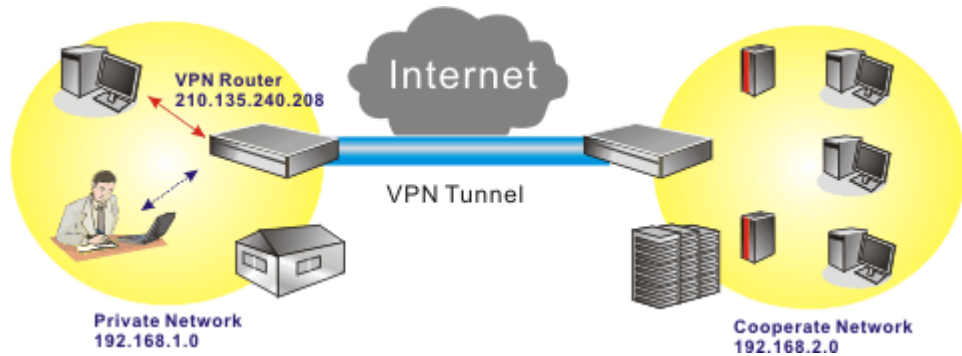

- Click edit to open a new window.

Bandwidth Management >> Quality of Service

Class Index #1

Name Test

NO	Status	Local Address	Remote Address	DiffServ CodePoint	Service Type
1	Empty	-	-	-	-

Add Edit Delete

OK Cancel

- First, check the **ACT** box. Then click **Edit** of **Local Address** to set a worker's subnet address. Click **Edit** of **Remote Address** to set headquarter's subnet address. Leave other fields and click **OK**.

Rule Edit

<input type="checkbox"/> ACT		
Local Address	<input type="text" value="Any"/>	<input type="button" value="Edit"/>
Remote Address	<input type="text" value="Any"/>	<input type="button" value="Edit"/>
DiffServ CodePoint	<input type="text" value="ANY"/>	
Service Type	<input type="text" value="ANY"/>	
Note: Please choose/setup the <u>Service Type</u> first.		
		<input type="button" value="OK"/> <input type="button" value="Cancel"/>

5.4 LAN – Created by Using NAT

An example of default setting and the corresponding deployment are shown below. The default Vigor router private IP address/Subnet Mask is 192.168.1.1/255.255.255.0. The built-in DHCP server is enabled so it assigns every local NATed host an IP address of 192.168.1.x starting from 192.168.1.10.

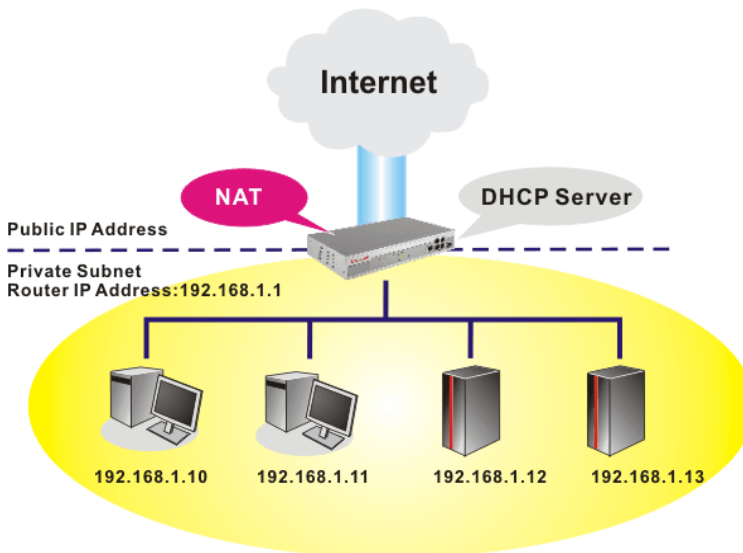

You can just set the settings wrapped inside the red rectangles to fit the request of NAT usage.

LAN >> General Setup

Ethernet TCP / IP and DHCP Setup

LAN IP Network Configuration		DHCP Server Configuration	
For NAT Usage		<input checked="" type="radio"/> Enable Server <input type="radio"/> Disable Server	
1st IP Address	<input type="text" value="192.168.1.1"/>	Relay Agent:	<input type="radio"/> 1st Subnet <input type="radio"/> 2nd Subnet
1st Subnet Mask	<input type="text" value="255.255.255.0"/>	Start IP Address	<input type="text" value="192.168.1.10"/>
For IP Routing Usage <input type="radio"/> Enable <input checked="" type="radio"/> Disable		IP Pool Counts	<input type="text" value="50"/>
2nd IP Address	<input type="text" value="192.168.2.1"/>	Gateway IP Address	<input type="text" value="192.168.1.1"/>
2nd Subnet Mask	<input type="text" value="255.255.255.0"/>	DHCP Server IP Address for Relay Agent	<input type="text"/>
<input type="button" value="2nd Subnet DHCP Server"/>		DNS Server IP Address	
RIP Protocol Control	<input type="text" value="Disable"/>	<input type="checkbox"/> Force DNS manual setting	
		Primary IP Address	<input type="text" value="168.95.1.1"/>
		Secondary IP Address	<input type="text"/>

To use another DHCP server in the network rather than the built-in one of Vigor Router, you have to change the settings as show below.

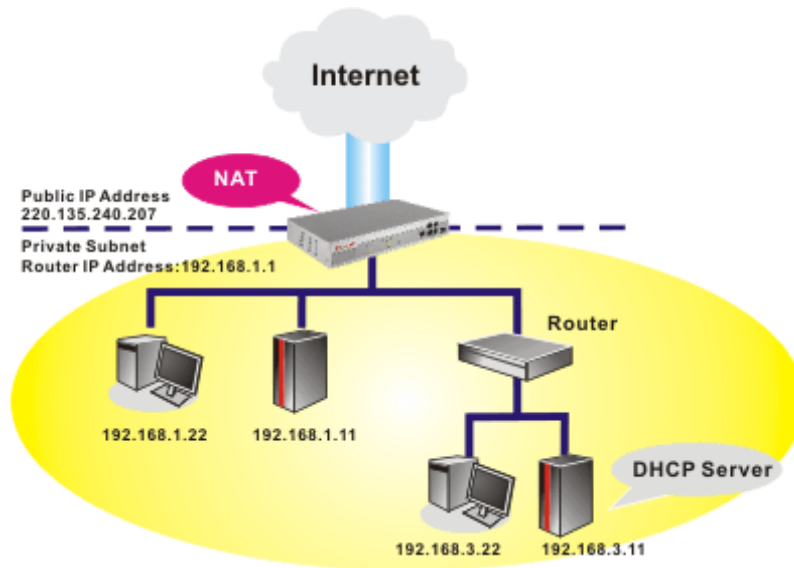

You can just set the settings wrapped inside the red rectangles to fit the request of NAT usage.

LAN >> General Setup

Ethernet TCP / IP and DHCP Setup

<p>LAN IP Network Configuration</p> <p>For NAT Usage</p> <p>1st IP Address <input type="text" value="192.168.1.1"/></p> <p>1st Subnet Mask <input type="text" value="255.255.255.0"/></p> <p>For IP Routing Usage <input type="radio"/> Enable <input checked="" type="radio"/> Disable</p> <p>2nd IP Address <input type="text" value="192.168.2.1"/></p> <p>2nd Subnet Mask <input type="text" value="255.255.255.0"/></p> <p style="text-align: center;"><input type="button" value="2nd Subnet DHCP Server"/></p> <p>RIP Protocol Control <input type="text" value="Disable"/></p>	<p>DHCP Server Configuration</p> <p><input type="radio"/> Enable Server <input checked="" type="radio"/> Disable Server</p> <p>Relay Agent: <input type="radio"/> 1st Subnet <input type="radio"/> 2nd Subnet</p> <p>Start IP Address <input type="text" value="192.168.1.10"/></p> <p>IP Pool Counts <input type="text" value="50"/></p> <p>Gateway IP Address <input type="text" value="192.168.1.1"/></p> <p>DHCP Server IP Address for Relay Agent <input type="text"/></p> <p>DNS Server IP Address</p> <p><input type="checkbox"/> Force DNS manual setting</p> <p>Primary IP Address <input type="text" value="168.95.1.1"/></p> <p>Secondary IP Address <input type="text"/></p>
---	--

OK

5.5 Upgrade Firmware for Your Router

Before upgrading your router firmware, you need to install the Router Tools. The **Firmware Upgrade Utility** is included in the tools.

1. Insert CD of the router to your CD ROM.
2. From the webpage, please find out **Utility** menu and click it.
3. On the webpage of Utility, click **Install Now!** (under Syslog description) to install the corresponding program.

Please remember to set as follows in your DrayTek Router :

- Server IP Address : IP address of the PC that runs the Syslog
- Port Number : Default value 514



4. The file **RTSxxx.exe** will be asked to copy onto your computer. Remember the place of storing the execution file.
5. Go to **www.draytek.com** to find out the newly update firmware for your router.
6. Access into **Support Center >> Downloads**. Find out the model name of the router and click the firmware link. The Tools of Vigor router will display as shown below.

Tools Name	Released Date	Version	OS	Support Model	Download
Router Tools	21/12/2006	3.5.1	MS-Windows	All Model	zip
Smart VPN Client	18/08/2006	3.2.6	MS-Windows	All Model	zip
LPR	27/06/2005	1.0	MS-Windows	For Print Function	zip
VTA	15/09/2005	2.8	Windows2000/XP	For ISDN Model	zip
DialPlan	26/01/2006	2.5_lite	MS-Windows	For VoIP Model	zip

7. Choose the one that matches with your operating system and click the corresponding link to download correct firmware (zip file).
8. Next, decompress the zip file.

9. Double click on the icon of router tool. The setup wizard will appear.

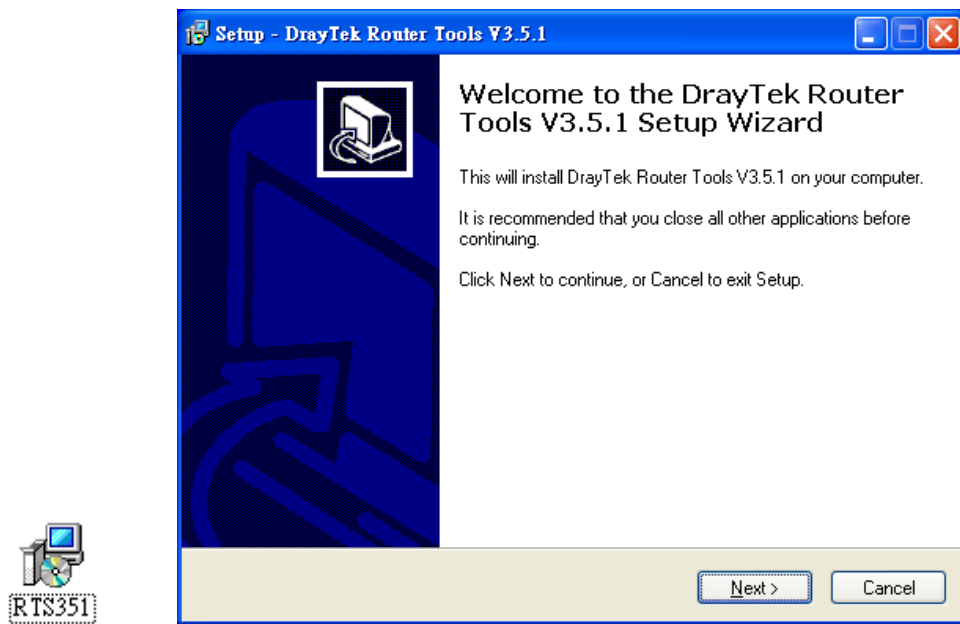

10. Follow the onscreen instructions to install the tool. Finally, click **Finish** to end the installation.
11. From the **Start** menu, open **Programs** and choose **Router Tools XXX >> Firmware Upgrade Utility**.

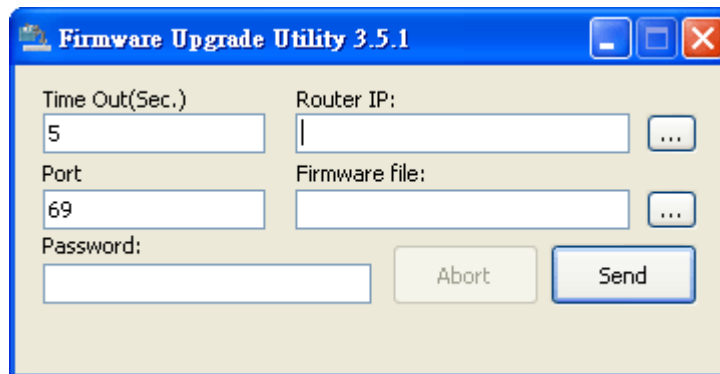

12. Type in your router IP, usually **192.168.1.1**.
13. Click the button to the right side of Firmware file typing box. Locate the files that you download from the company web sites. You will find out two files with different extension names, **xxxx.all** (keep the old custom settings) and **xxxx.rst** (reset all the custom settings to default settings). Choose any one of them that you need.

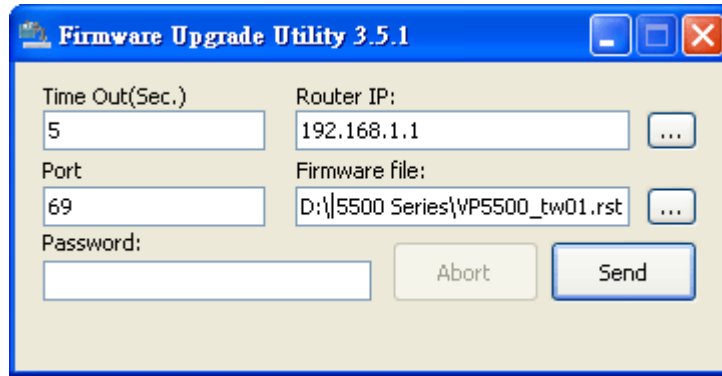

14. Click **Send**.

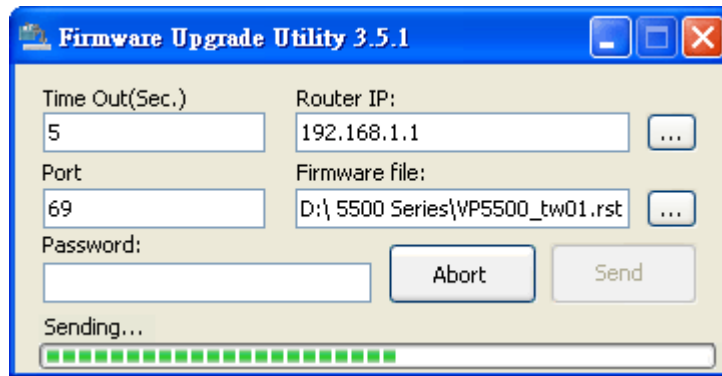

15. Now the firmware update is finished.

5.6 Request a certificate from a CA server on Windows CA Server

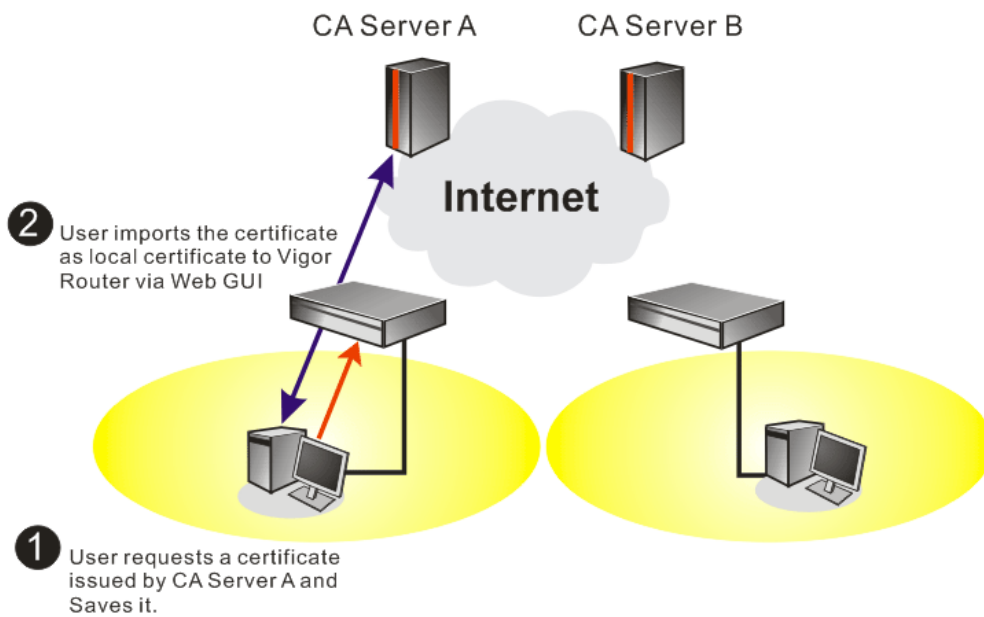

1. Go to **Certificate Management** and choose **Local Certificate**.

Certificate Management >> Local Certificate

X509 Local Certificate Configuration

Name	Subject	Status	Modify
Local	---	---	<input type="button" value="View"/> <input type="button" value="Delete"/>

X509 Local Certificate

2. You can click **GENERATE** button to start to edit a certificate request. Enter the information in the certificate request.

Certificate Management >> Local Certificate

Generate Certificate Request

Subject Alternative Name

Type:
 Domain Name:

Subject Name

Country (C):
 State (ST):
 Location (L):
 Organization (O):
 Organization Unit (OU):
 Common Name (CN):
 Email (E):

Key Type:
 Key Size:

3. Copy and save the X509 Local Certificate Request as a text file and save it for later use.

Certificate Management >> Local Certificate

X509 Local Certificate Configuration

Name	Subject	Status	Modify
Local	/C=TW/O=Draytek/emailAddress...	Requesting	<input type="button" value="View"/> <input type="button" value="Delete"/>

X509 Local Certificate Request

```

-----BEGIN CERTIFICATE REQUEST-----
MIIBjzCB+QIBADBQMqswCQYDVQQGEwJUVzEQMA4GA1UEChMHRHJheXR1azELMAkG
A1UECzMCUkQxIjAgBgkqhkiG9w0BCQEWES3N1cnZpY2VhZmJheXR1ay5jb20wgZSw
DQYJKoZIhvcNAQEBBQADgYQAMIGJAoGBAMemQ68+e0u+fS237c1TP51CRDFuxgxw
K89UJEeq11h7rUYhrfgFj07kZ0fQTpWjqu/w3vmwOEnkg16mntzq9tBmDF12dJG
cdIZQh7H9MOmpP0qrPu0cgA0Ete1oaLhgV1MovrojR6OXNPABq6kYr4NYLHh1bFH
MDkjEpdMQARpAgMBAAAGADANBgkqhkiG9w0BAQUFAAOBgQBWphus100n9rZ8y2C2
egi0n39FoAPathPmqHZoAYFGeDMCHGUY4vHdkQo7RObVtKkqs17D12hPHESHgS0
P/D4zKQiJLTXSm8+3gX3ZdRq+IjpruzZTTBPBMR93PhP3USUYTrBL01pNVQCGqb
jaquLF4Zpb0VVqOq8a4UbtXENw==
-----END CERTIFICATE REQUEST-----

```

4. Connect to CA server via web browser. Follow the instruction to submit the request. Below we take a Windows 2000 CA server for example. Select **Request a Certificate**.

The screenshot shows the 'Microsoft Certificate Services' website. The page title is 'Microsoft Certificate Services -- vigor' and there is a 'Home' link in the top right. The main heading is 'Welcome'. Below it, a paragraph explains the site's purpose: 'You use this web site to request a certificate for your web browser, e-mail client, or other secure program. Once you acquire a certificate, you will be able to securely identify yourself to other people over the web, sign your e-mail messages, encrypt your e-mail messages, and more depending upon the type of certificate you request.' Under the heading 'Select a task:', there are three radio button options: 'Retrieve the CA certificate or certificate revocation list', 'Request a certificate' (which is selected), and 'Check on a pending certificate'. A 'Next >' button is located at the bottom right of the page.

Select **Advanced request**.

The screenshot shows the 'Microsoft Certificate Services' website. The page title is 'Microsoft Certificate Services -- vigor' and there is a 'Home' link in the top right. The main heading is 'Choose Request Type'. Below it, a paragraph says: 'Please select the type of request you would like to make:'. There are two radio button options: 'User certificate request' and 'Advanced request' (which is selected). Under 'User certificate request', there is a button labeled 'User Certificate'. A 'Next >' button is located at the bottom right of the page.

Select **Submit a certificate request a base64 encoded PKCS #10 file or a renewal request using a base64 encoded PKCS #7 file**

The screenshot shows the 'Microsoft Certificate Services' website. The page title is 'Microsoft Certificate Services -- vigor' and there is a 'Home' link in the top right. The main heading is 'Advanced Certificate Requests'. Below it, a paragraph explains: 'You can request a certificate for yourself, another user, or a computer using one of the following methods. Note that the policy of the certification authority (CA) will determine the certificates that you can obtain.' There are three radio button options: 'Submit a certificate request to this CA using a form.', 'Submit a certificate request using a base64 encoded PKCS #10 file or a renewal request using a base64 encoded PKCS #7 file.' (which is selected), and 'Request a certificate for a smart card on behalf of another user using the Smart Card Enrollment Station. You must have an enrollment agent certificate to submit a request for another user.' A 'Next >' button is located at the bottom right of the page.

Import the X509 Local Certificate Request text file. Select **Router (Offline request)** or **IPSec (Offline request)** below.

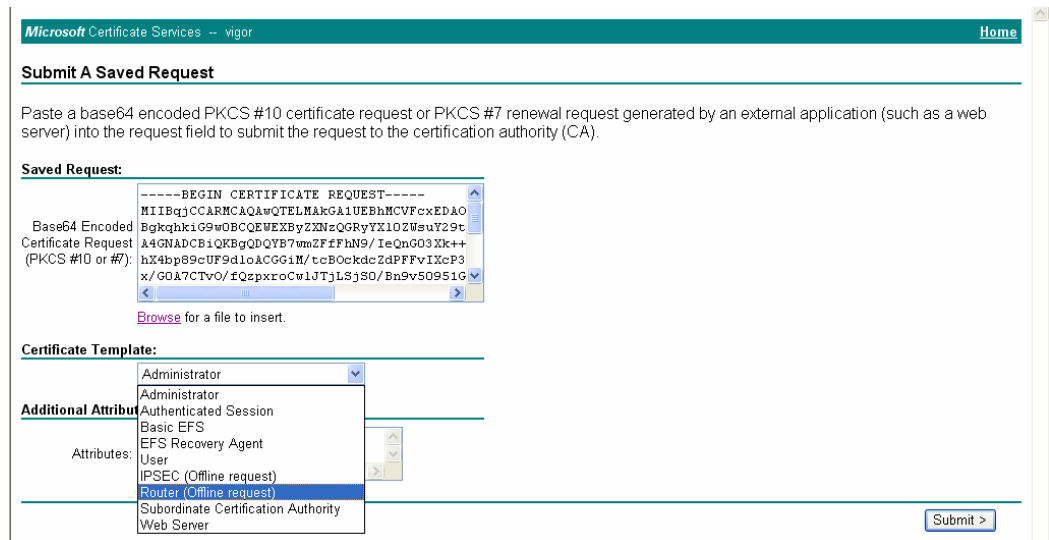

Then you have done the request and the server now issues you a certificate. Select **Base 64 encoded** certificate and **Download CA certificate**. Now you should get a certificate (.cer file) and save it.

- Back to Vigor router, go to **Local Certificate**. Click **IMPORT** button and browse the file to import the certificate (.cer file) into Vigor router. When finished, click refresh and you will find the below window showing “-----BEGIN CERTIFICATE-----.....”
Certificate Management >> Local Certificate

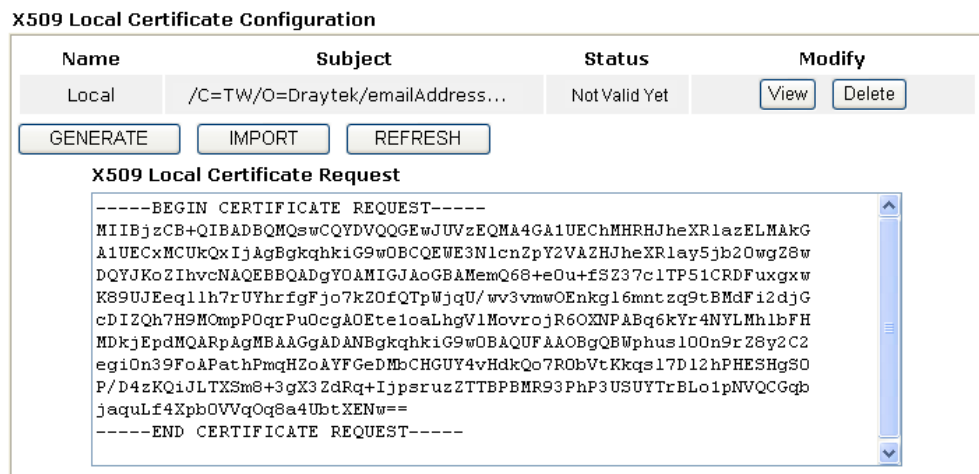

- You may review the detail information of the certificate by clicking **View** button.

Name :	Local
Issuer :	/C=US/CN=vigor
Subject :	/emailAddress=press@draytek.com/C=TW/O=Draytek
Subject Alternative Name :	DNS: draytek.com
Valid From :	Aug 30 23:08:43 2005 GMT
Valid To :	Aug 30 23:17:47 2007 GMT

5.7 Request a CA Certificate and Set as Trusted on Windows CA Server

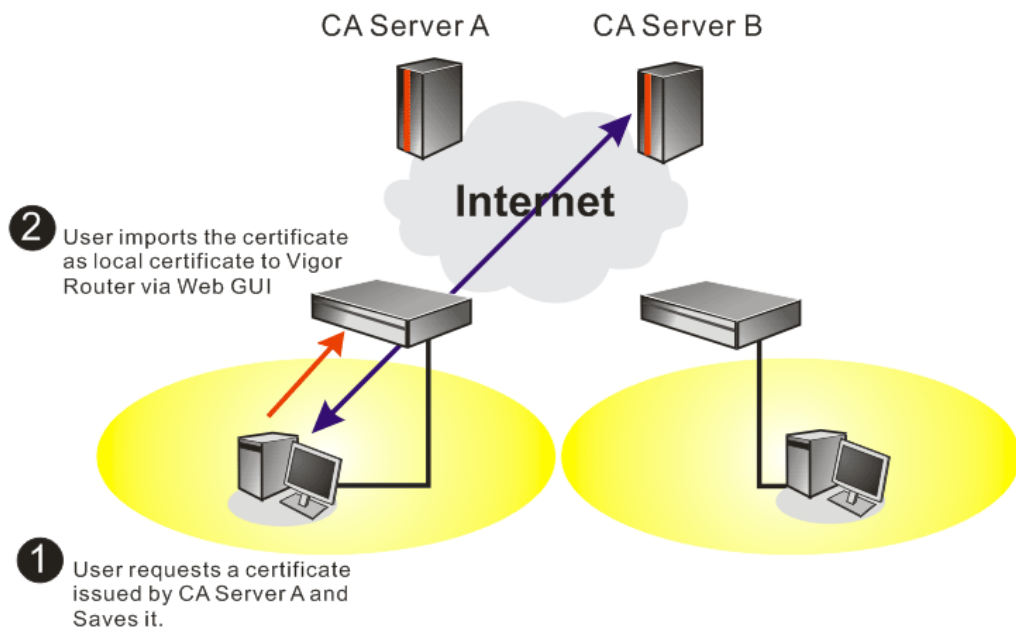

1. Use web browser connecting to the CA server that you would like to retrieve its CA certificate. Click **Retrieve the CA certificate or certificate recoring list**.

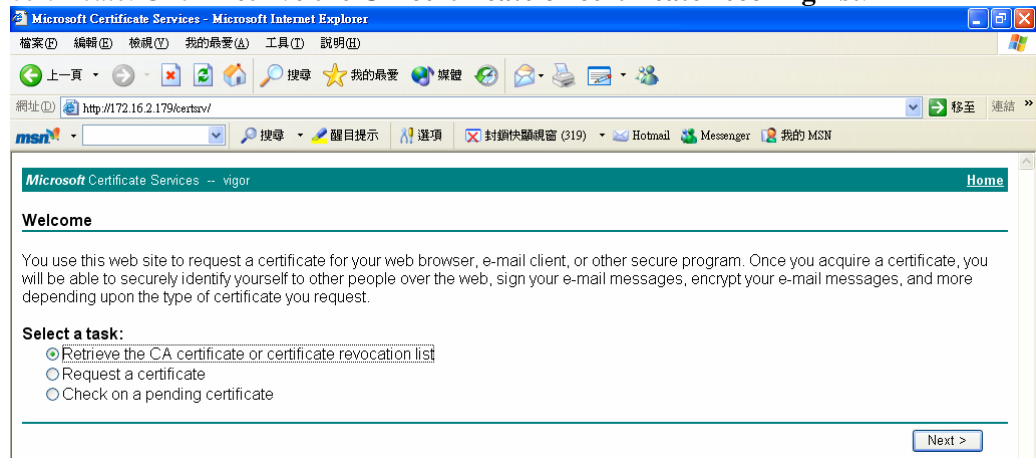

- In **Choose file to download**, click **CA Certificate Current** and **Base 64 encoded**, and **Download CA certificate** to save the .cer file.

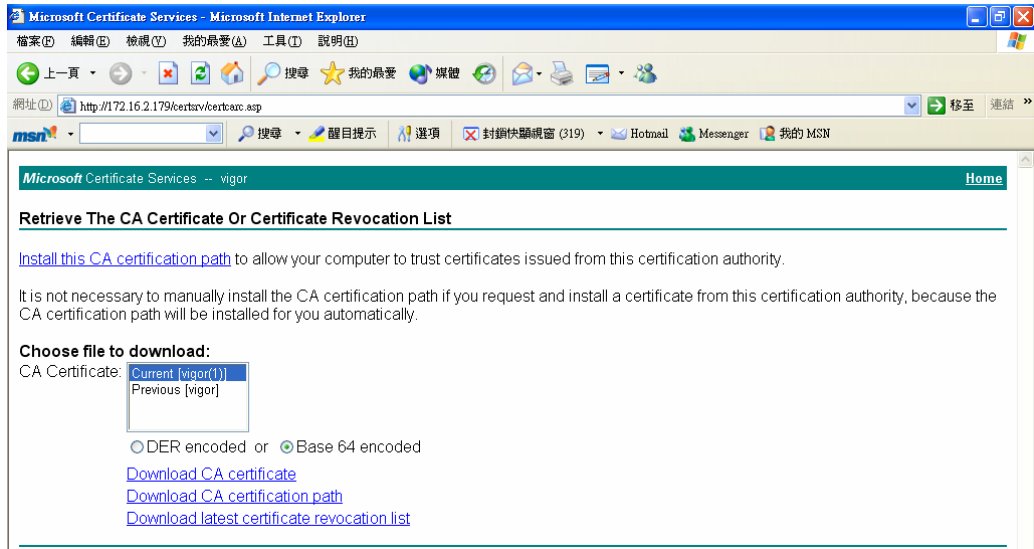

- Back to Vigor router, go to **Trusted CA Certificate**. Click **IMPORT** button and browse the file to import the certificate (.cer file) into Vigor router. When finished, click refresh and you will find the below illustration.

Certificate Management >> Trusted CA Certificate

X509 Trusted CA Certificate Configuration

Name	Subject	Status	Modify	
Trusted CA-1	---	---	View	Delete
Trusted CA-2	---	---	View	Delete
Trusted CA-3	---	---	View	Delete

IMPORT REFRESH

- You may review the detail information of the certificate by clicking **View** button.

Name :	Trusted CA-1
Issuer :	/C=US/CN=vigor
Subject :	/C=US/CN=vigor
Subject Alternative Name :	DNS:draytek.com
Valid From :	Aug 30 23:08:43 2005 GMT
Valid To :	Aug 30 23:17:47 2007 GMT

Close

Note: Before setting certificate configuration, please go to **System Maintenance >> Time and Date** to reset current time of the router first.

6

Trouble Shooting

This section will guide you to solve abnormal situations if you cannot access into the Internet after installing the router and finishing the web configuration. Please follow sections below to check your basic installation status stage by stage.

- Checking if the hardware status is OK or not.
- Checking if the network connection settings on your computer are OK or not.
- Pinging the router from your computer.
- Checking if the ISP settings are OK or not.
- Backing to factory default setting if necessary.

If all above stages are done and the router still cannot run normally, it is the time for you to contact your dealer for advanced help.

6.1 Checking If the Hardware Status Is OK or Not

Follow the steps below to verify the hardware status.

1. Check the power line and WLAN/LAN cable connections.
Refer to “**2.1 Hardware Installation**” for details.
2. Turn on the router. Make sure the **ACT LED** blink once per second and the correspondent **LAN LED** is bright.



3. If not, it means that there is something wrong with the hardware status. Simply back to “**2.1 Hardware Installation**” to execute the hardware installation again. And then, try again.

6.2 Checking If the Network Connection Settings on Your Computer Is OK or Not

Sometimes the link failure occurs due to the wrong network connection settings. After trying the above section, if the link is still failed, please do the steps listed below to make sure the network connection settings is OK.

For Windows



The example is based on Windows XP. As to the examples for other operation systems, please refer to the similar steps or find support notes in www.draytek.com.

1. Go to Control Panel and then double-click on Network Connections.



2. Right-click on Local Area Connection and click on Properties.

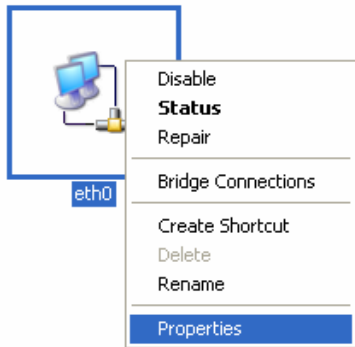

3. Select Internet Protocol (TCP/IP) and then click Properties.

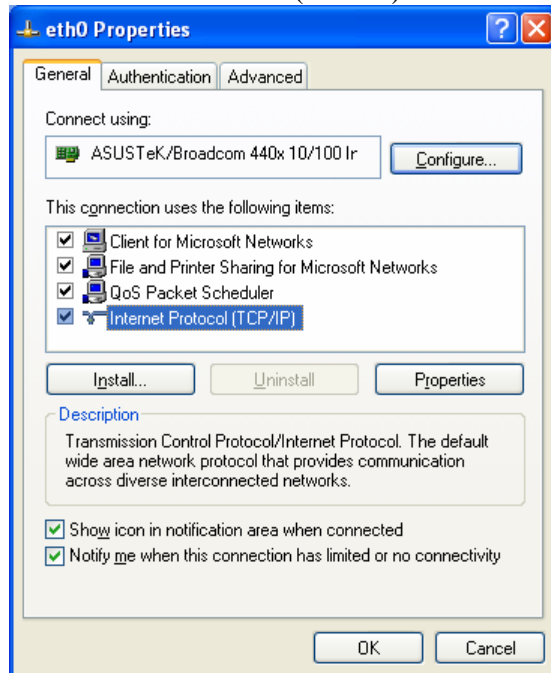

4. Select Obtain an IP address automatically and Obtain DNS server address automatically.

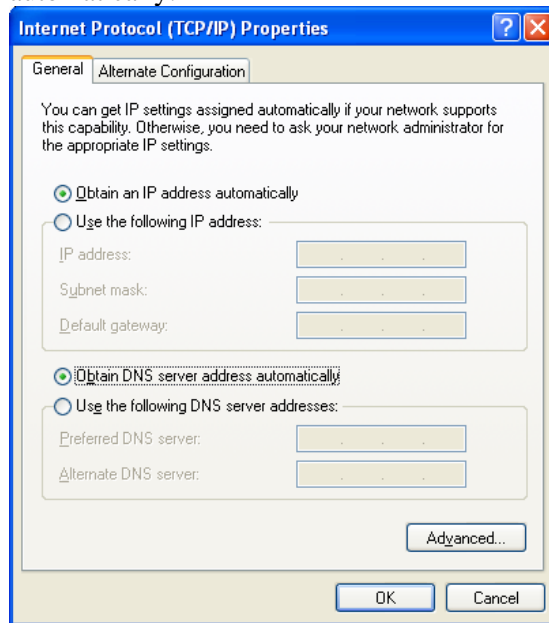

For MacOs

1. Double click on the current used MacOs on the desktop.
2. Open the **Application** folder and get into **Network**.
3. On the **Network** screen, select **Using DHCP** from the drop down list of Configure IPv4.

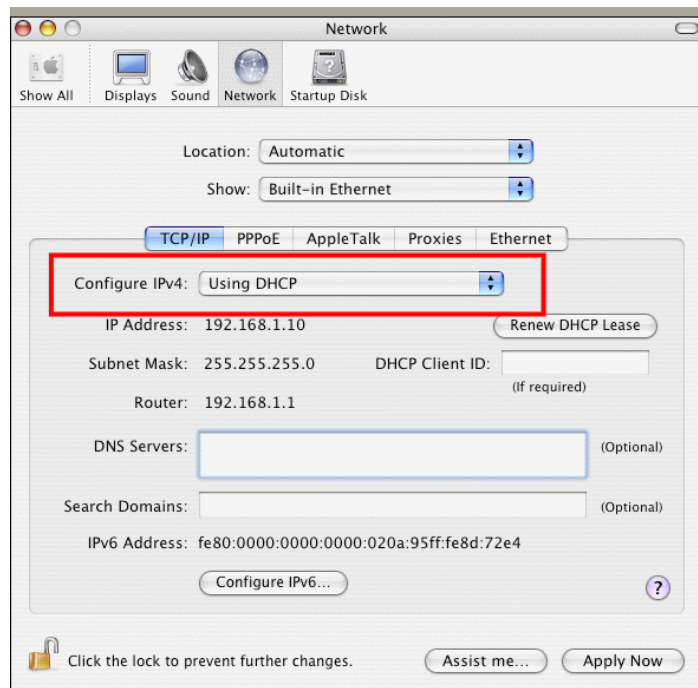

6.3 Pinging the Router from Your Computer

The default gateway IP address of the router is 192.168.1.1. For some reason, you might need to use “ping” command to check the link status of the router. **The most important thing is that the computer will receive a reply from 192.168.1.1.** If not, please check the IP address of your computer. We suggest you setting the network connection as **get IP automatically**. (Please refer to the section 4.2)

Please follow the steps below to ping the router correctly.

For Windows

1. Open the **Command Prompt** window (from **Start menu> Run**).
2. Type **command** (for Windows 95/98/ME) or **cmd** (for Windows NT/ 2000/XP). The DOS command dialog will appear.

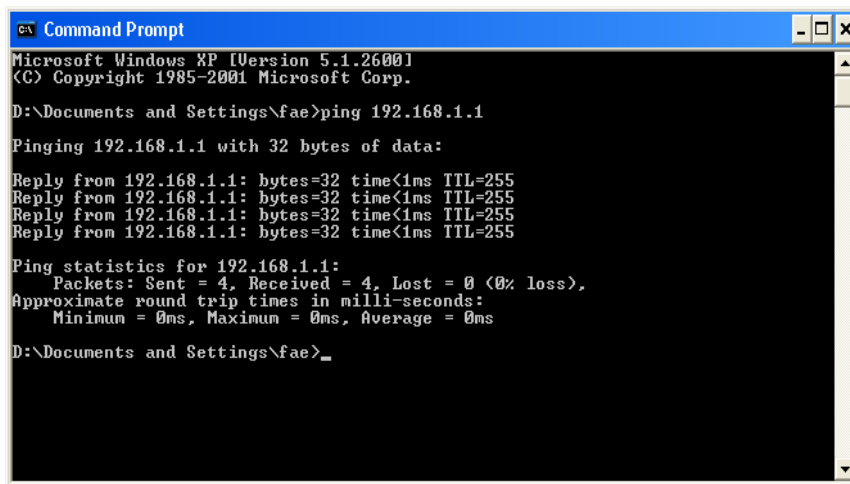

```
Microsoft Windows XP [Version 5.1.2600]
(C) Copyright 1985-2001 Microsoft Corp.

D:\Documents and Settings\fae>ping 192.168.1.1

Pinging 192.168.1.1 with 32 bytes of data:

Reply from 192.168.1.1: bytes=32 time<1ms TTL=255
Reply from 192.168.1.1: bytes=32 time<1ms TTL=255
Reply from 192.168.1.1: bytes=32 time<1ms TTL=255
Reply from 192.168.1.1: bytes=32 time<1ms TTL=255

Ping statistics for 192.168.1.1:
    Packets: Sent = 4, Received = 4, Lost = 0 (0% loss),
    Approximate round trip times in milli-seconds:
        Minimum = 0ms, Maximum = 0ms, Average = 0ms

D:\Documents and Settings\fae>_
```

3. Type ping 192.168.1.1 and press [Enter]. If the link is OK, the line of “**Reply from 192.168.1.1:bytes=32 time<1ms TTL=255**” will appear.
4. If the line does not appear, please check the IP address setting of your computer.

For MacOs (Terminal)

1. Double click on the current used MacOs on the desktop.
2. Open the **Application** folder and get into **Utilities**.
3. Double click **Terminal**. The Terminal window will appear.
4. Type **ping 192.168.1.1** and press [Enter]. If the link is OK, the line of “**64 bytes from 192.168.1.1: icmp_seq=0 ttl=255 time=xxxx ms**” will appear.

```

Terminal — bash — 80x24
Last login: Sat Jan  3 02:24:18 on ttys1
Welcome to Darwin!
Vigor10:~ draytek$ ping 192.168.1.1
PING 192.168.1.1 (192.168.1.1): 56 data bytes
64 bytes from 192.168.1.1: icmp_seq=0 ttl=255 time=0.755 ms
64 bytes from 192.168.1.1: icmp_seq=1 ttl=255 time=0.697 ms
64 bytes from 192.168.1.1: icmp_seq=2 ttl=255 time=0.716 ms
64 bytes from 192.168.1.1: icmp_seq=3 ttl=255 time=0.731 ms
64 bytes from 192.168.1.1: icmp_seq=4 ttl=255 time=0.72 ms
^C
--- 192.168.1.1 ping statistics ---
5 packets transmitted, 5 packets received, 0% packet loss
round-trip min/avg/max = 0.697/0.723/0.755 ms
Vigor10:~ draytek$

```

6.4 Checking If the ISP Settings are OK or Not

Click **WAN>> Internet Access** and then check whether the ISP settings are set correctly. Click **Details Page** of WAN1/WAN2 to review the settings that you configured previously.

WAN >> Internet Access

Internet Access

Index	Display Name	Physical Mode	Access Mode	
WAN1		Ethernet	Static or Dynamic IP	Details Page
WAN2		Ethernet	None	Details Page

Static or Dynamic IP

- None
- PPPoE
- Static or Dynamic IP
- PPTP

For PPPoE Users

1. Check if the **Enable** option is selected.
2. Check if **Username** and **Password** are entered with correct values that you **got from** your **ISP**.

WAN 1

<p>PPPoE Client Mode</p> <p><input checked="" type="radio"/> Enable <input type="radio"/> Disable</p> <hr/> <p>ISP Access Setup</p> <p>Username <input type="text" value="admin"/></p> <p>Password <input type="password" value="*****"/></p> <p>Index(1-15) in Schedule Setup: => <input type="text"/> , <input type="text"/> , <input type="text"/> , <input type="text"/></p> <p>ISDN Dial Backup Setup</p> <p>Dial Backup Mode <input type="text" value="None"/></p>	<p>PPP/MP Setup</p> <p>PPP Authentication <input type="text" value="PAP or CHAP"/></p> <p>Idle Timeout <input type="text" value="-1"/> second(s)</p> <p>IP Address Assignment Method (IPCP)</p> <p><input type="text" value="WAN IP Alias"/></p> <p>Fixed IP: <input type="radio"/> Yes <input checked="" type="radio"/> No (Dynamic IP)</p> <p>Fixed IP Address <input type="text"/></p> <hr/> <p><input checked="" type="radio"/> Default MAC Address</p> <p><input type="radio"/> Specify a MAC Address</p> <p>MAC Address: <input type="text" value="00"/> <input type="text" value=".50"/> <input type="text" value=".7F"/> <input type="text" value=":22"/> <input type="text" value="33"/> <input type="text" value=".45"/></p>
---	--

For Static/Dynamic IP Users

1. Check if the **Enable** option is selected.
2. Check if **IP address, Subnet Mask and Gateway** are entered with correct values that you **got from your ISP**.

WAN 1

<p>Static or Dynamic IP (DHCP Client)</p> <p><input checked="" type="radio"/> Enable <input type="radio"/> Disable</p> <hr/> <p>ISDN Dial Backup Setup</p> <p>Dial Backup Mode <input type="text" value="None"/></p> <hr/> <p>Keep WAN Connection</p> <p><input type="checkbox"/> Enable PING to keep alive</p> <p>PING to the IP <input type="text"/></p> <p>PING Interval <input type="text" value="0"/> minute(s)</p> <hr/> <p>RIP Protocol</p> <p><input type="checkbox"/> Enable RIP</p>	<p>WAN IP Network Settings <input type="text" value="WAN IP Alias"/></p> <p><input type="radio"/> Obtain an IP address automatically</p> <p>Router Name <input type="text"/> *</p> <p>Domain Name <input type="text"/> *</p> <p>* : Required for some ISPs</p> <p><input checked="" type="radio"/> Specify an IP address</p> <p>IP Address <input type="text" value="172.16.3.229"/></p> <p>Subnet Mask <input type="text" value="255.255.255.0"/></p> <p>Gateway IP Address <input type="text" value="172.16.3.1"/></p> <hr/> <p><input checked="" type="radio"/> Default MAC Address</p> <p><input type="radio"/> Specify a MAC Address</p> <p>MAC Address: <input type="text" value="00"/> <input type="text" value=".50"/> <input type="text" value=".7F"/> <input type="text" value=":22"/> <input type="text" value="33"/> <input type="text" value=".45"/></p> <hr/> <p>DNS Server IP Address</p> <p>Primary IP Address <input type="text"/></p> <p>Secondary IP Address <input type="text"/></p>
---	--

For PPTP Users

1. Check if the **Enable** option for **PPTP Link** is selected.

WAN >> Internet Access

WAN 1

PPTP Client Mode <input checked="" type="radio"/> Enable <input type="radio"/> Disable PPTP Server <input type="text" value="10.0.0.138"/>	PPP Setup PPP Authentication <input type="text" value="PAP or CHAP"/> Idle Timeout <input type="text" value="-1"/> second(s)
ISP Access Setup Username <input type="text"/> Password <input type="text"/> Index(1-15) in Schedule Setup: => <input type="text"/> , <input type="text"/> , <input type="text"/>	IP Address Assignment Method (IPCP) <input type="text" value="WAN IP Alias"/> Fixed IP: <input type="radio"/> Yes <input checked="" type="radio"/> No (Dynamic IP) Fixed IP Address <input type="text"/>
ISDN Dial Backup Setup Dial Backup Mode <input type="text" value="None"/>	WAN IP Network Settings <input type="radio"/> Obtain an IP address automatically <input checked="" type="radio"/> Specify an IP address IP Address <input type="text" value="10.0.0.150"/> Subnet Mask <input type="text" value="255.0.0.0"/>

2. Check if **PPTP Server**, **Username**, **Password** and **WAN IP address** are set correctly (must identify with the values from your ISP).

6.5 Backing to Factory Default Setting If Necessary

Sometimes, a wrong connection can be improved by returning to the default settings. Try to reset the router by software or hardware.



Warning: After pressing **factory default setting**, you will lose all settings you did before. Make sure you have recorded all useful settings before you pressing. The password of factory default is null.

Software Reset

You can reset the router to factory default via Web page.

Go to **System Maintenance** and choose **Reboot System** on the web page. The following screen will appear. Choose **Using factory default configuration** and click **OK**. After few seconds, the router will return all the settings to the factory settings.

System Maintenance >> Reboot System

Reboot System

Do You want to reboot your router ?

Using current configuration
 Using factory default configuration

Hardware Reset

While the router is running (ACT LED blinking), press the **Factory Reset** button and hold for more than 5 seconds. When you see the **ACT LED** blinks rapidly, please release the button. Then, the router will restart with the default configuration.

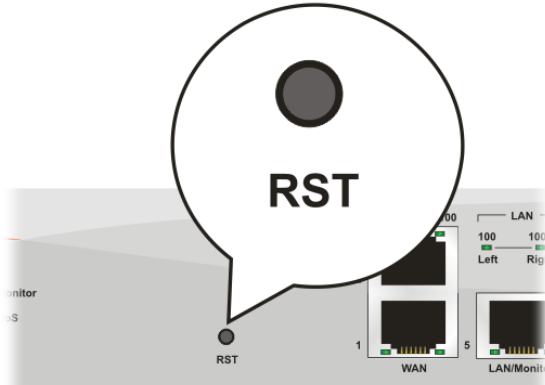

After restore the factory default setting, you can configure the settings for the router again to fit your personal request.

6.6 Contacting Your Dealer

If the router still cannot work correctly after trying many efforts, please contact your dealer for further help right away. For any questions, please feel free to send e-mail to support@draytek.com.