



# **DG-WA3002NP**

**300Mbps Wireless Access Point  
with PoE**

**User Manual**

**V1.0  
2012-06-28**

As our products undergo continuous development the specifications are subject to change without prior notice

## COPYRIGHT

Copyright © 2012 by this company. All rights reserved. No part of this publication may be reproduced, transmitted, transcribed, stored in a retrieval system, or translated into any language or computer language, in any form or by any means, electronic, mechanical, magnetic, optical, chemical, manual or otherwise, without the prior written permission of this company

This company makes no representations or warranties, either expressed or implied, with respect to the contents hereof and specifically disclaims any warranties, merchantability or fitness for any particular purpose. Any software described in this manual is sold or licensed "as is". Should the programs prove defective following their purchase, the buyer (and not this company, its distributor, or its dealer) assumes the entire cost of all necessary servicing, repair, and any incidental or consequential damages resulting from any defect in the software. Further, this company reserves the right to revise this publication and to make changes from time to time in the contents thereof without obligation to notify any person of such revision or changes.

## Trademarks:

DIGISOL™ is a trademark of Smartlink Network Systems Ltd. All other trademarks are the property of the respective manufacturers.

## Safety

This equipment is designed with the utmost care for the safety of those who install and use it. However, special attention must be paid to the dangers of electric shock and static electricity when working with electrical equipment. All guidelines of this and of the computer manufacturer must therefore be allowed at all times to ensure the safe use of the equipment.

# Federal Communication Commission Interference Statement

## FCC Part 15

This equipment has been tested and found to comply with the limits for a class B digital device, pursuant to Part 15 of the FCC Rules. These limitations are designed to provide reasonable protection against harmful interference in a residential installation. This equipment generates, uses and can radiate radio frequency energy and, if not installed and used in accordance with the instructions, may cause harmful interference to radio communications. However, there is no guarantee that interference will not occur in a particular installation. If this equipment does cause harmful interference to radio or television reception, which can be determined by turning the equipment off and on, the user is encouraged to try to correct the interference by one or more of the following measures:

- Reorient or relocate the receiving antenna.
- Increase the separation between the equipment and receiver.
- Connect the equipment into a different outlet from that to which the receiver is connected.
- Consult your local distributors or an experienced radio/TV technician for help.
- Shielded interface cables must be used in order to comply with emission limits

Changes or modifications to the equipment, which are not approved by the party responsible for compliance could affect the user's authority to operate the equipment.

## **FCC Caution**

This equipment must be installed and operated in accordance with provided instructions and a minimum 20 cm spacing must be provided between computer mounted antenna and person's body (excluding extremities of hands, wrist and feet) during wireless modes of operation.

This device complies with Part 15 of the FCC Rules. Operation is subject to the following two conditions: (1) this device may not cause harmful interference, and (2) this device must accept any interference received, including interference that may cause undesired operation.

Any changes or modifications not expressly approved by the party responsible for compliance could void the authority to operate equipment.

## **Federal Communication Commission (FCC) Radiation Exposure Statement**

This equipment complies with FCC radiation exposure set forth for an uncontrolled environment. In order to avoid the possibility of exceeding the FCC radio frequency exposure limits, human proximity to the antenna shall not be less than 20cm (8 inches) during normal operation.

The antenna(s) used for this transmitter must not be co-located or operating in conjunction with any other antenna or transmitter.

The equipment version marketed in US is restricted to usage of the channels 1-11 only.

---

## R&TTE Compliance Statement

This equipment complies with all the requirements of DIRECTIVE 1999/5/EC OF THE EUROPEAN PARLIAMENT AND THE COUNCIL of March 9, 1999 on Radio Equipment And Telecommunication Terminal Equipment and the mutual recognition of their conformity (R&TTE).

The R&TTE Directive repeals and replaces in the directive 98/13/EEC (Telecommunications Terminal Equipment and Satellite Earth Station Equipment) As of April 8, 2000.

### **EU Countries Intended for Use**

The ETSI version of this device is intended for home and office use in Austria, Belgium, Denmark, Finland, France, Germany, Greece, Ireland, Italy, Luxembourg, the Netherlands, Portugal, Spain, Sweden, and the United Kingdom.

The ETSI version of this device is also authorized for use in EFTA member states: Iceland, Liechtenstein, Norway, and Switzerland.

**EU Countries Not intended for use:** None.

---

# Index

<b>1. Product Information .....</b>	<b>8</b>
1-1 Product Introduction.....	8
1-2 Safety Information.....	9
1-3 System Requirements .....	10
1-4 Package Contents .....	10
1-5 Get familiar with your new wireless PoE Access Point .....	11
<b>2. System and Network Setup .....</b>	<b>13</b>
2-1 Hardware and Software Installation .....	13
2-2 Connecting to wireless Access Point using web browser.....	25
2-2-1 Windows 95/98 IP address setup .....	26
2-2-2 Windows 2000 IP address setup .....	28
2-2-3 Windows XP IP address setup .....	30
2-2-4 Windows Vista IP address setup .....	32
2-2-5 Connecting to Web Management Interface by web browser .....	34
2-3 View System Status and Information .....	36
2-4 Select an Operating Mode for Wireless Access Point .....	38
2-4-1 AP Mode .....	40
2-4-2 Station-Infrastructure .....	42
2-4-2-1 Wireless Site Survey.....	44
2-4-3 AP Bridge-Point to Point Mode .....	45
2-4-4 AP Bridge-Point to Multi-Point Mode.....	47
2-4-5 AP Bridge-WDS Mode .....	49
2-4-6 Universal Repeater.....	52
2-5 WPS Setting .....	55
2-6 Advanced Wireless Settings .....	58
2-7 Wireless Security .....	61
2-7-1 Disable Security.....	64
2-7-2 WEP .....	65
2-7-3 WPA Pre-shared Key .....	67
2-7-4 WPA RADIUS .....	68
2-7-5 802.1x Authentication.....	70
2-8 MAC Filtering .....	72
2-9 System Utility.....	75

---

2-9-1 LED On/Off .....	76
2-9-2 Change Password.....	77
2-9-3 IP Address of the Wireless Access Point.....	79
2-9-4 DHCP Server .....	81
<b>3. Advanced Configuration.....</b>	<b>83</b>
3-1 Configuration Backup and Restore .....	83
3-2 Firmware Upgrade.....	85
3-3 System Reboot.....	87
<b>4. Appendix.....</b>	<b>89</b>
4-1 Hardware Specification .....	89
4-2 Troubleshooting.....	90
4-3 Glossary.....	92

## 1. Product Information

### 1-1 Product Introduction

Thank you for purchasing DG-WA3002NP wireless LAN Access Point with PoE! With this high cost-efficiency wireless Access Point, computers and wireless devices which are compatible with IEEE 802.11n can connect to existing wired Ethernet network, at the speed of up to 300Mbps. DG-WA3002NP also supports power over ethernet which helps in easy installation, by eliminating the need of a dedicated power source for the access point.

With Quick Setup installation procedure, any computer user can setup a wireless network environment in very short time - within minutes, even inexperienced users. Just follow the instructions given in this user manual, you can complete the setup procedure.

*Other features of this Access Point include:*

- Complies with IEEE 802.11b/g/n wireless network standards - works with other 802.11b/g/n wireless devices.
- Complies with 802.3af PoE standard.
- High speed wireless network, six times faster than conventional 802.11g wireless network (up to 300Mbps).
- Allows wireless devices to connect to existing wired network and share network resources.
- Supports 64/128-bit WEP, WPA, and WPA2 wireless data encryption.
- Supports 802.1x authentications.
- Supports MAC address filtering (Only allows specific wireless device of your choice to connect to this Access Point).
- Supports DHCP server function.
- Supports point-to-point and point-to-multi point bridge function.
- Supports WDS (Wireless Distributed System) repeater mode.
- Supports Universal Repeater mode.
- Supports AP Client mode.



- Supports hidden SSID function.
- Supports WPS (Wi-Fi Protected Setup), simplifies wireless client setup procedures. Even inexperienced users can setup a wireless network without network technician's help.
- Easy to use web-based GUI (Graphical User Interface) for network configuration and management purposes.

## **1-2 Safety Information**

In order to keep the safety of users and your property, please follow the safety instructions mentioned below:

1. This Access Point is designed for indoor use only; **DO NOT** place this Access Point outdoor.
2. **DO NOT** place this Access Point close to a hot or humid area, like kitchen or bathroom. Also, do not leave this Access Point in the car during summer.
3. **DO NOT** pull any connected cable with force; disconnect it from the Access Point first.
4. If you want to place this Access Point at a height or mount on the wall, please make sure the Access Point is firmly secured. Falling from a height would damage the Access Point and its accessories and warranty will be void.
5. Accessories of this Access Point, like antenna and power supply, are dangerous to small children. They may put the small parts in their nose or mouth and it could cause serious damage to them. **KEEP THIS ACCESS POINT OUT OF THE REACH OF CHILDREN.**
6. The Access Point will get heated up when used for a long time (*This is normal and is not a malfunction*). **DO NOT** put this Access Point on paper, cloth, or other flammable materials.

7. There's no user-serviceable part inside the Access Point. If you find that the Access Point is not working properly, please contact your dealer of purchase and ask for help. **DO NOT** disassemble the Access Point, warranty will be void.
8. If the Access Point falls into water when it's powered, **DO NOT** use your hand to pick it up. Switch the electrical power off before you do anything, or contact an experienced electrical technician for help.
9. If you smell something strange or even see some smoke coming out from the Access Point or power supply, remove the power supply or switch the electrical power off immediately, and call the dealer of purchase for help.

### **1-3 System Requirements**

- Computer or network devices with wired or wireless network interface card.
- Web browser (Microsoft Internet Explorer 4.0 or above, Netscape Navigator 4.7 or above, Opera web browser, or Safari web browser).
- An available AC power socket (100 – 240 V, 50/60Hz)

### **1-4 Package Contents**

Before you start using this PoE Access Point, please check if there's anything missing in the package, and contact your dealer of purchase to claim for missing items:

- DG-WA3002NP Wireless Access Point with PoE
- Switching Power Adapter (5V DC, 2A)
- Quick Installation Guide
- Installation Guide CD (includes User Manual, QIG & Utility)
- Patch cord (1 No.)

## 1-5 Get familiar with your new wireless PoE Access Point

### Front Panel



LED Name	Light Status	Description
PWR	On	The Access Point is switched on and correctly powered.
	Slow Blinking	System is reset to factory default, at the same time WLAN LED is on.
	Off	The access point is switched off.
WLAN	On	Wireless WPS mode is enabled.
	Off	Wireless network is switched off.
	Flashing	Wireless LAN activity (transferring or receiving data).
LAN	On	LAN port is connected
	Off	LAN port is not connected
	Flashing	LAN activity (transferring or receiving data)

Item Name	Description
Reset / WPS	Reset the router to factory default settings (clear all settings) or start WPS function. Press this button and hold for 10 seconds to restore all settings to factory defaults, and press this button for less than 5 seconds to start WPS function.

### *Back panel*

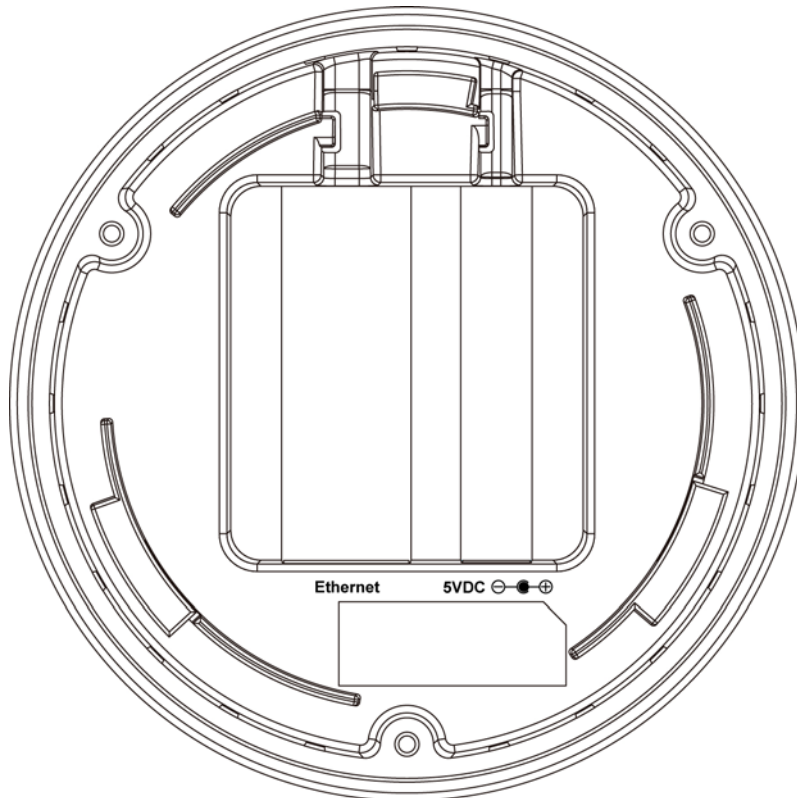

Interfaces	Description
Power	Power connector, connects to A/C power adapter.
Ethernet	Local Area Network (LAN) port.

## 2. System and Network Setup

### 2-1 Hardware and Software Installation

Please follow the below mentioned instructions to build the network connection between your new wireless access point and your computers, network devices:

#### Hardware Installation:-

1. Place the unit in an appropriate place after conducting a site survey.
2. Connect the access point to ADSL modem, router, or switch/hub in your network through the LAN port of the access point by Ethernet cable.
3. Connect the A/C power adapter to the wall socket, and then connect it to the 'Power' socket of the access point.
4. Please check all LEDs on the front panel. 'PWR' LED should be steadily ON, 'LAN' LED should be ON if the Access Point is correctly connected to the ADSL modem, router or switch/hub. If 'PWR' LED is not ON, or any LED you expected is not ON, please recheck the cabling, or jump to ['Section 4-2 Troubleshooting'](#) for possible reasons and solutions.

**Note: You must use the power adapter shipped along with the Access Point. DO NOT use any other power adapter from other sources.**

## Software Installation:-

- Insert the Setup CD into your CD-ROM drive of notebook/desktop computer.

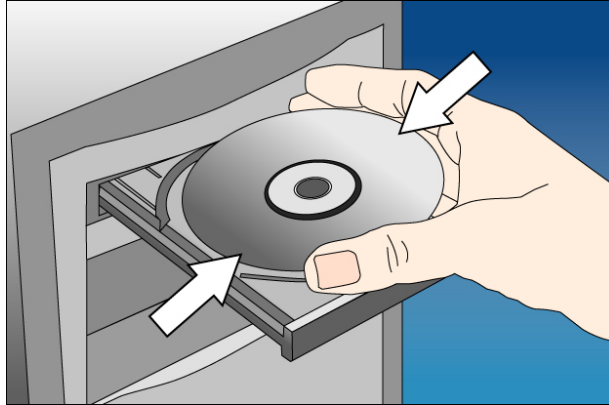

- Explore the CD and execute the “APWizard.exe” file. Screen given below will be displayed. Click ‘**Next**’ to continue.

A screenshot of the Digisol DG-WA3002NP Access Point Quick Install Utility software interface. The background is dark red. At the top, there is a navigation menu with buttons for 'Home', 'Wireless Name', 'Wireless Security', 'Firmware Upgrade', 'Quick Installation Guide', 'User Manual', and 'Exit'. The Digisol logo and 'digisol.com' are in the top right corner. The main heading reads 'Welcome to Digisol DG-WA3002NP Access Point Quick Install Utility'. Below this, a message states: 'This Setup Wizard will guide you through a few steps to configure your new Digisol Access Point.' A section titled 'You will finish the following steps with this wizard:' lists four steps: A) Connect the Access Point to your network, B) Configure the operation mode of your Access Point, C) Configure the wireless settings, and D) Save and reboot the Access Point. A 'Next' button is located in the bottom right corner. At the bottom left is the Digisol logo, and at the bottom right are the contact details: 'Service &amp; Support', 'Toll Free - 1800 209 3444', 'helpdesk@digisol.com', and the model number 'DG-WA3002NP'.

- Connect one end of the network cable to the LAN port on the Router and the other end to the PoE switch. From the PoE switch connect a cable to the AP. Power ON the router, the AP and the PoE switch. Ensure that all the LED's on the Access Point are ON. If not, try the above steps again else click '**Next**' to continue.

Home    Wireless Name    Wireless Security    Firmware Upgrade    Quick Installation Guide    User Manual    Exit     digisol.com

## Connect the AP to Your Network

**Connect DG-WA3002NP to the PoE Switch in the LAN.**



INTERNET

Broadband Router    PoE Switch    PoE Access Point

[Back](#)    [Next](#)

**DIGISOL™**    Service & Support  
Toll Free - 1800 209 3444  
helpdesk@digisol.com    **DG-WA3002NP**



- Enter the AP's password to log in to the AP. The default password is "1234". It is recommended to change the AP's password to protect it from being accessed by other users. If you do not wish to change the current password, you can leave "New Password" and "Confirm New Password" fields blank. Click **'Log in'** to continue.

Home | Wireless Name | Wireless Security | Firmware Upgrade | Quick Installation Guide | User Manual | Exit |  digisol.com

## Log in to the AP

Enter "1234" to the Current Password to log in to the AP. Please change the default login password (1234) to avoid unauthorized access to your network. If you forget the AP's password, you can reset it by pressing and holding the reset button on the AP for 10 seconds.

Current Password:

New Password:

Confirm New Password:

[Back](#) [Log in](#)

 Service & Support  
Toll Free - 1800 209 3444  
helpdesk@digisol.com **DG-WA3002NP**



- Configure the IP Address of AP for future management. Click **'Next'** to continue.

Home | Wireless Name | Wireless Security | Firmware Upgrade | Quick Installation Guide | User Manual | Exit | digisol.com

## Configure the IP Address

Please assign a valid IP address to the AP. If you need to configure more advanced settings for the AP in the future, you can enter this IP address in the address bar of the web browser to locate this device from your local area network.

IP Address:

Subnet Mask:

Default Gateway:

The IP address must match your network settings. For example: If your router's IP address is 192.168.2.1, the first 3 numbers of the AP's IP address should match with your router, which is "192.168.2". The last number you can assign from 2 to 254, but it must not conflict with other existing devices IP address on your network.

[Back](#) [Next](#)

**DIGISOL™** Service & Support  
Toll Free - 1800 209 3444  
helpdesk@digisol.com **DG-WA3002NP**

- Select an operation mode for your Access Point and click **'Next'**. The wizard will guide you to finish the following corresponding settings.

Home | Wireless Name | Wireless Security | Firmware Upgrade | Quick Installation Guide | User Manual | Exit | digisol.com

## Select AP Modes

Select an operation mode for your AP.

- Access Point** Add wireless capability to your current local area network.
- Universal Repeater** Extend the range of your current wireless network.
- AP Client** Connect your Ethernet-ready network device to your wireless network.
- Point to Point Bridge** Bridge 2 networks with wireless connection. (For example: 2 buildings or houses)
- Point to Multi-Point Bridge** Bridge multiple networks with wireless connection. (For example multiple buildings or houses)
- WDS Bridge** Connect multiple Access Points wirelessly without wired backbone.

[Back](#) [Next](#)

**DIGISOL™** Service & Support  
Toll Free - 1800 209 3444  
helpdesk@digisol.com **DG-WA3002NP**

- Configure the settings for the operation mode you have selected.

## Access Point

- Configure the SSID and Channel Number. Click **'Next'** to continue.

The screenshot shows a web interface with a dark red background. At the top, there is a navigation menu with buttons for Home, Wireless Name, Wireless Security, Firmware Upgrade, Quick Installation Guide, User Manual, and Exit. The Digisol logo and website URL (digisol.com) are in the top right corner. The main heading is "Configure Wireless Settings". Below this, there is a paragraph of instructions: "Configure the name (SSID) and channel for your wireless connection. The default SSID is 'Digisol', the default wireless channel is 6." There are two input fields: "Wireless Name (SSID):" with a text box containing "Digisol" and "(Example: myHome, john123,)" below it; and "Channel Number:" with a dropdown menu showing "6". At the bottom right, there are "Back" and "Next" buttons. The footer contains the Digisol logo, service and support contact information (Toll Free - 1800 209 3444, helpdesk@digisol.com), and the model number DG-WA3002NP.

## Universal Repeater

To configure Root AP's SSID Click on '**Site Survey**', a "Wireless Site Survey" window will appear. Select the wireless router or AP you wish to repeat and click '**Connect**'. Next, configure a network name and channel no in Main SSID and Channel Number for the repeater to be identified.

The screenshot shows the 'Site Survey' configuration page. At the top, there is a navigation menu with links: Home, Wireless Name, Wireless Security, Firmware Upgrade, Quick Installation Guide, User Manual, and Exit. The Digisol logo and website URL (digisol.com) are in the top right corner. The main heading is 'Site Survey'. Below it, a text block reads: 'Select the Wireless Router or AP you wish to connect or repeat by clicking on Site Survey. You can configure the Main SSID for your Repeater so you can recognize it. If you are not using the Repeater mode, you can leave it blank.' The form contains three input fields: 'Root AP's SSID' (empty), 'Main SSID' (containing 'Digisol'), and 'Channel Number' (a dropdown menu with '6' selected). A 'Site Survey' button is positioned to the right of the Root AP's SSID field. At the bottom of the form area, there are 'Back' and 'Next' buttons. The footer of the page includes the Digisol logo, service and support information (Toll Free - 1800 209 3444, helpdesk@digisol.com), and the model number DG-WA3002NP.

## AP Client

Click on **'Site Survey'**, "Wireless Site Survey" window will appear. Select the wireless router or AP you wish to connect and click **'Connect'**, or enter your wireless network's SSID manually. Click **'Next'** to continue.

The screenshot shows a web interface for configuring wireless settings. At the top, there is a navigation menu with links: Home, Wireless Name, Wireless Security, Firmware Upgrade, Quick Installation Guide, User Manual, Exit, and a Digisol logo with the URL digisol.com. The main heading is "Configure Wireless Settings". Below this, a text block explains: "Configure the name (SSID) and channel for your wireless connection. The default SSID is 'Digisol'." There are two input fields: "Wireless Name (SSID):" with a text box containing "Digisol" and a "Site Survey" button to its right; and "Channel Number:" with a dropdown menu showing "6". Below the inputs are "Back" and "Next" buttons. At the bottom left is the Digisol logo, and at the bottom right is the model number "DG-WA3002NP" and service & support information: "Service & Support", "Toll Free - 1800 209 3444", and "helpdesk@digisol.com".

## Point-to-Point / Point-to-MultiPoint / WDS Bridge

**Note: Same setup procedure applies to Point-to-Point Bridge, Point-to-MultiPoint Bridge and WDS Bridge modes.**

For bridge mode, you need at least **two** Access Points. We will use Point-to-Point Bridge as an example.

Select a channel number you wish to use and enter the MAC address of the other Access Point for the bridge. Click '**Next**'.

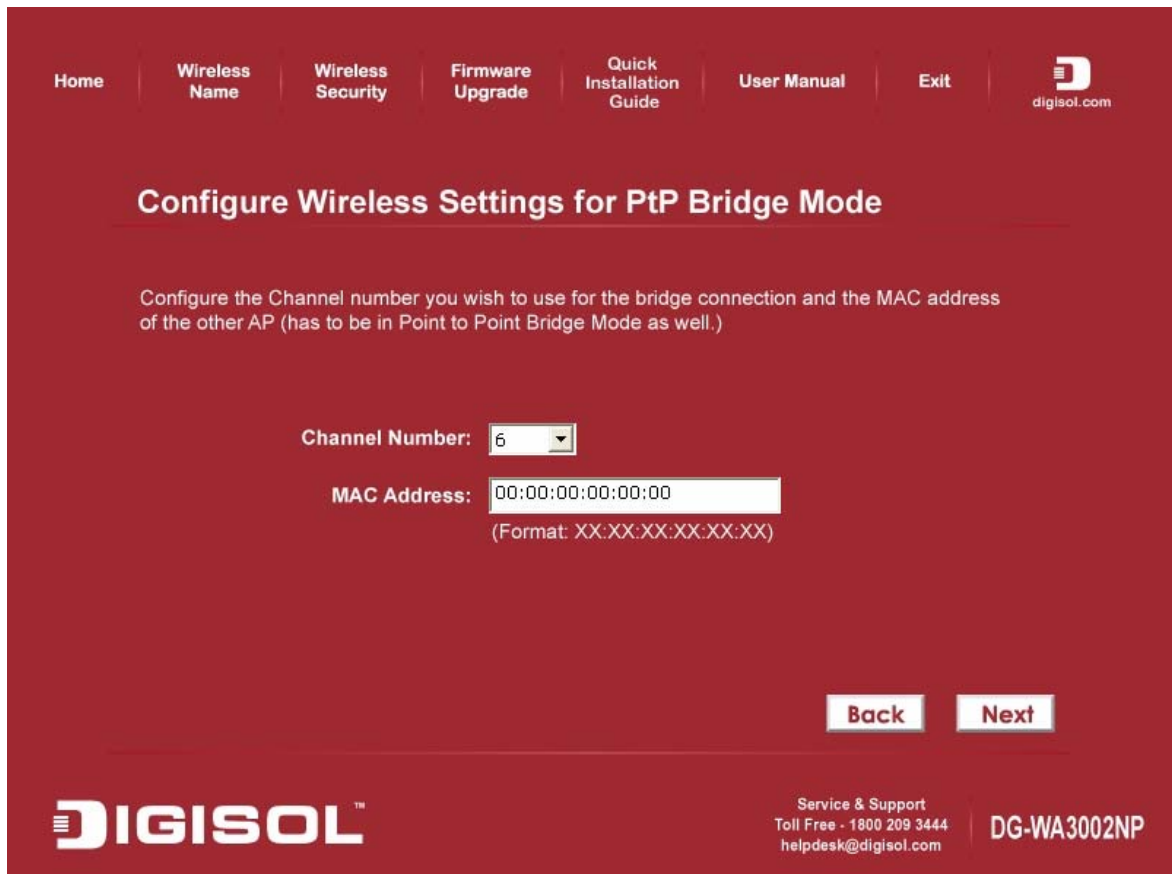

The screenshot shows a web interface with a dark red background. At the top, there is a navigation menu with links: Home, Wireless Name, Wireless Security, Firmware Upgrade, Quick Installation Guide, User Manual, and Exit. The Digisol logo and website URL (digisol.com) are in the top right corner. The main heading is "Configure Wireless Settings for PtP Bridge Mode". Below this, there is a sub-heading: "Configure the Channel number you wish to use for the bridge connection and the MAC address of the other AP (has to be in Point to Point Bridge Mode as well.)". There are two input fields: "Channel Number:" with a dropdown menu showing "6", and "MAC Address:" with a text box containing "00:00:00:00:00:00". Below the MAC address field, there is a note: "(Format: XX:XX:XX:XX:XX:XX)". At the bottom right, there are two buttons: "Back" and "Next". The footer contains the Digisol logo, contact information for Service & Support (Toll Free - 1800 209 3444, helpdesk@digisol.com), and the model number DG-WA3002NP.

- Configure the wireless security settings. It is recommended to use WPA2-PSK (AES) which is the most secured encryption for general users.

Then Click '**Next**'.



Home Wireless Name Wireless Security Firmware Upgrade Quick Installation Guide User Manual Exit digisol.com

## Configure Wireless Security

Please enter the wireless security key setting that is configured on the wireless router or bridge(s) you wish to connect or repeat. You will not be able to connect to those devices if the security settings do not match.

Encryption:

Security key:

 Service & Support  
Toll Free - 1800 209 3444  
helpdesk@digisol.com DG-WA3002NP

- Verify the settings you have configured and click **'Restart'**.

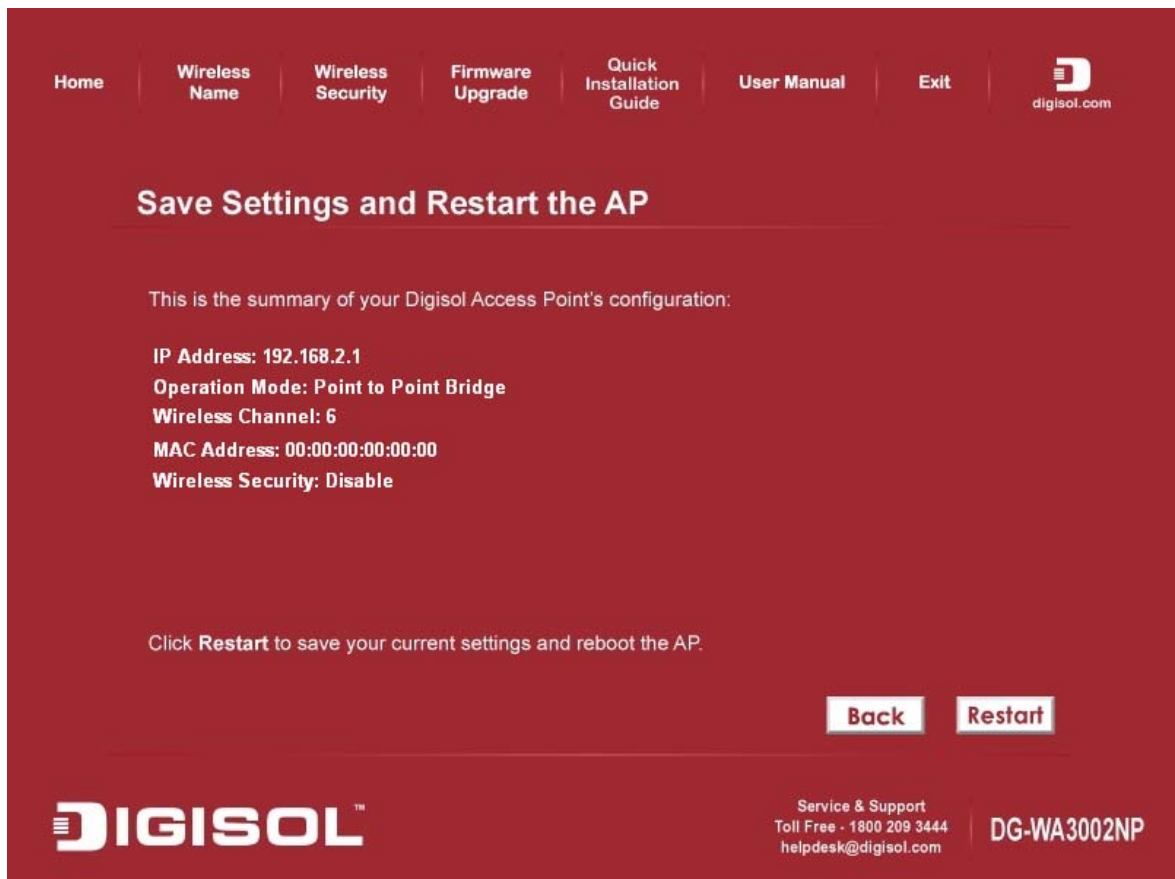

Home Wireless Name Wireless Security Firmware Upgrade Quick Installation Guide User Manual Exit digisol.com

## Save Settings and Restart the AP

This is the summary of your Digisol Access Point's configuration:

**IP Address:** 192.168.2.1  
**Operation Mode:** Point to Point Bridge  
**Wireless Channel:** 6  
**MAC Address:** 00:00:00:00:00:00  
**Wireless Security:** Disable

Click **Restart** to save your current settings and reboot the AP.

**Back** **Restart**

 Service & Support  
Toll Free - 1800 209 3444  
helpdesk@digisol.com **DG-WA3002NP**



- This will take 60 Seconds. Then Press **'OK'**

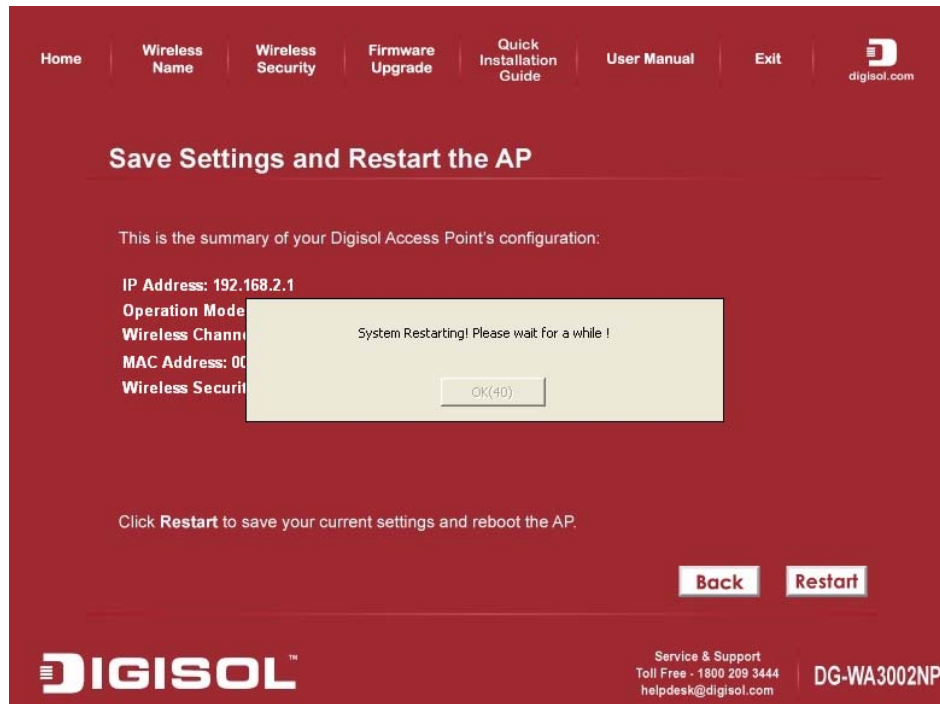

- Click **'Finish'** to complete the installation.

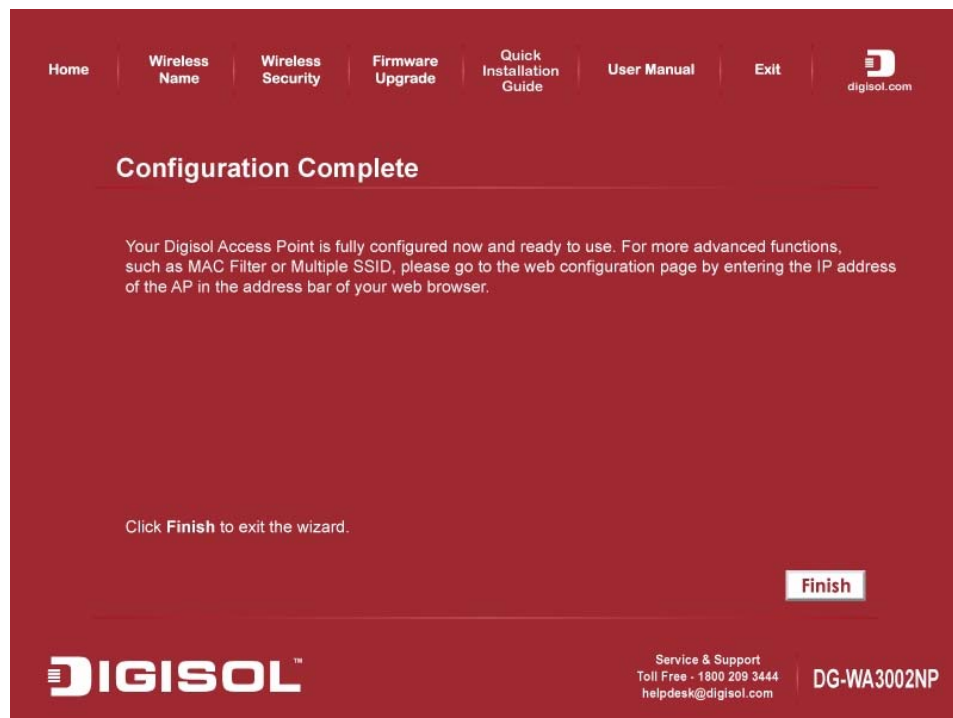

**Congratulations! Your Access Point Installation is now finished.**



## ***2-2 Connecting to wireless Access Point using web browser***

After the network connection is setup, next step is to setup the Access Point with proper network parameters, so it can work properly in your network environment.

Please use the web browser to configure the Access Point. A computer with wired Ethernet connection to the Access Point is required for this first-time configuration.

Before you start to configure the Access Point, please configure the IP address of the computer in the same network class as that of the Access Point.

***If the operating system of your computer is....***

- |                      |  |
|----------------------|--|
| <b>Windows 95/98</b> | - please go to <a href="#">section 2-2-1</a> |
| <b>Windows 2000</b>  | - please go to <a href="#">section 2-2-2</a> |
| <b>Windows XP</b>    | - please go to <a href="#">section 2-2-3</a> |
| <b>Windows Vista</b> | - please go to <a href="#">section 2-2-4</a> |

## 2-2-1 Windows 95/98 IP address setup

1. Click 'Start' button (it should be located at lower-left corner of your computer), then click control panel. Double-click '*Network*' icon, and *Network* window will appear. Select 'TCP/IP', then click '**Properties**'.

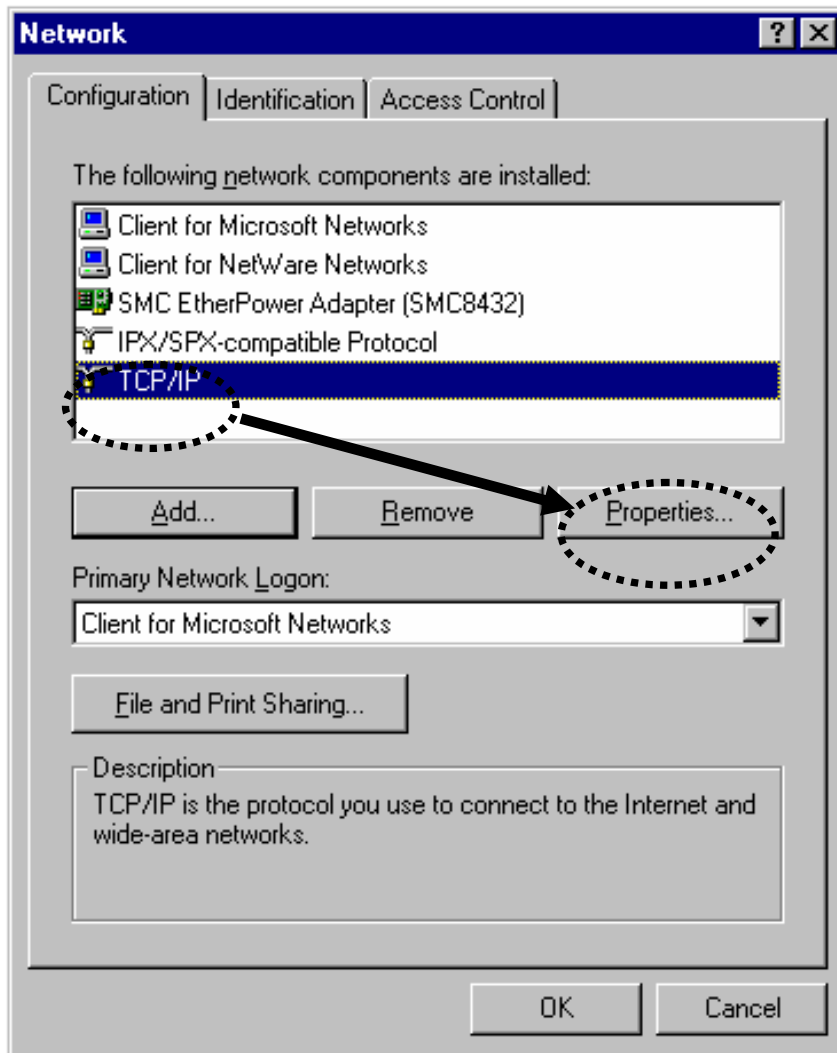

2. Select 'Specify an IP address', then input the following settings in the respective field:

IP address: 192.168.2.2

Subnet Mask: 255.255.255.0

Click 'OK' when finish.

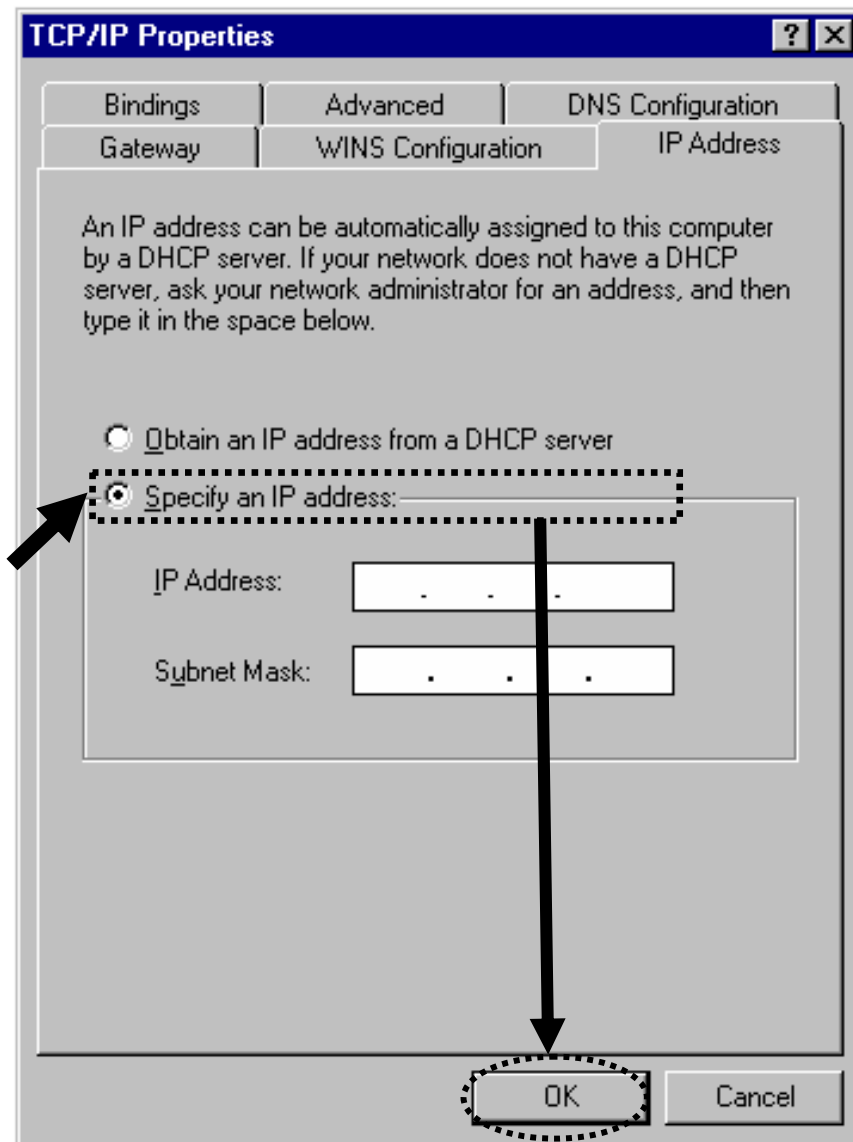

## 2-2-2 Windows 2000 IP address setup

1. Click 'Start' button (it should be located at lower-left corner of your computer), then click control panel. Double-click '*Network and Dial-up Connections*' icon, Right click on '*Local Area Connection*' and select '*Properties*', *Local Area Connection Properties* window will appear. Select '*Internet Protocol (TCP/IP)*', then click '**Properties**'

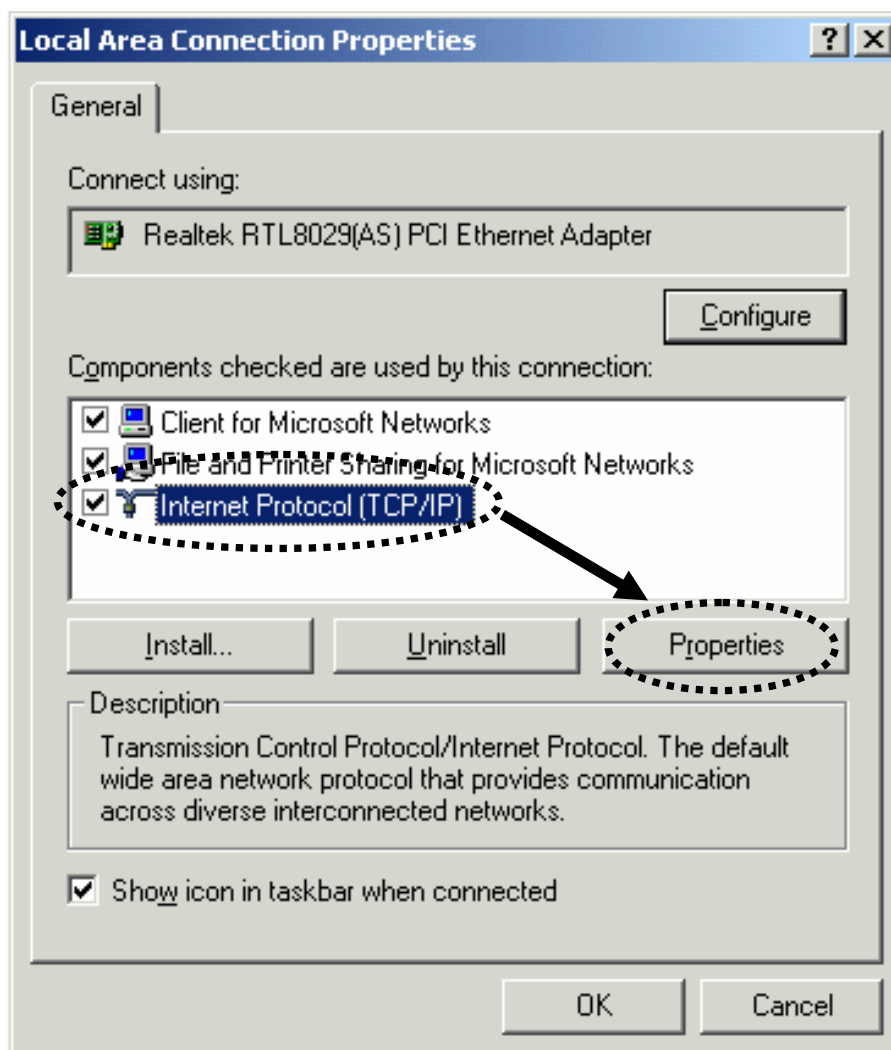

2. Select 'Use the following IP address', then input the following settings in the respective field:

IP address: 192.168.2.2

Subnet Mask: 255.255.255.0

Default gateway: 192.168.2.1

Click 'OK' when finish.

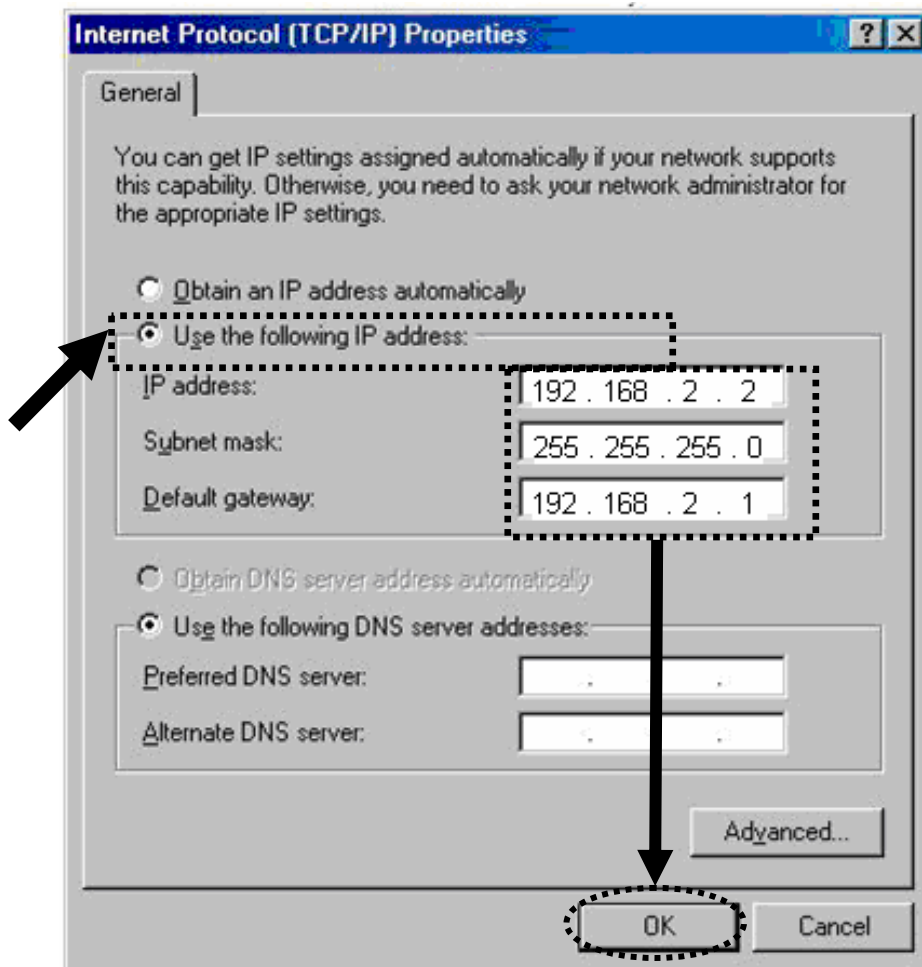

## 2-2-3 Windows XP IP address setup

1. Click 'Start' button (it should be located at lower-left corner of your computer), then click control panel. Click on '*Network Connections*', Right click on '*Local Area Connection*' and select *Properties*, *Local Area Connection Properties* window will appear. Select '*Internet Protocol (TCP/IP)*' and then click '*Properties*'.

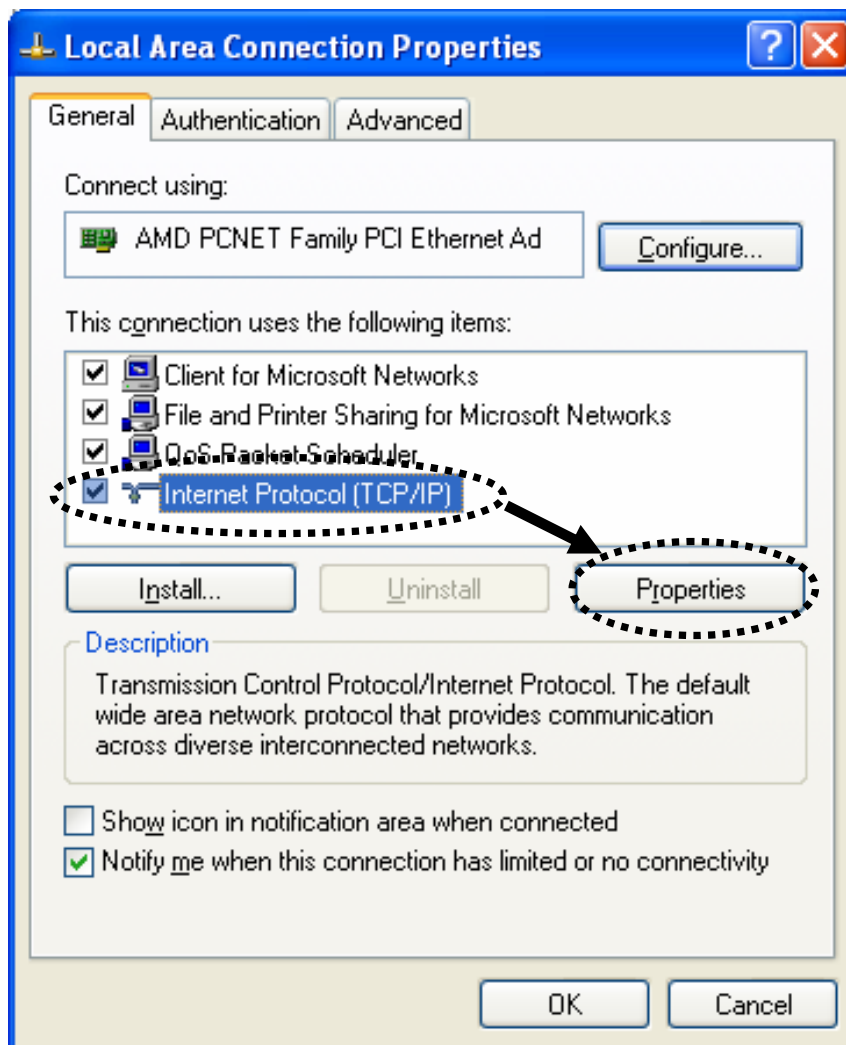

2. Select 'Use the following IP address', then input the following settings in the respective field:

IP address: 192.168.2.2

Subnet Mask: 255.255.255.0

Default gateway: 192.168.2.1

Click 'OK' when finish.

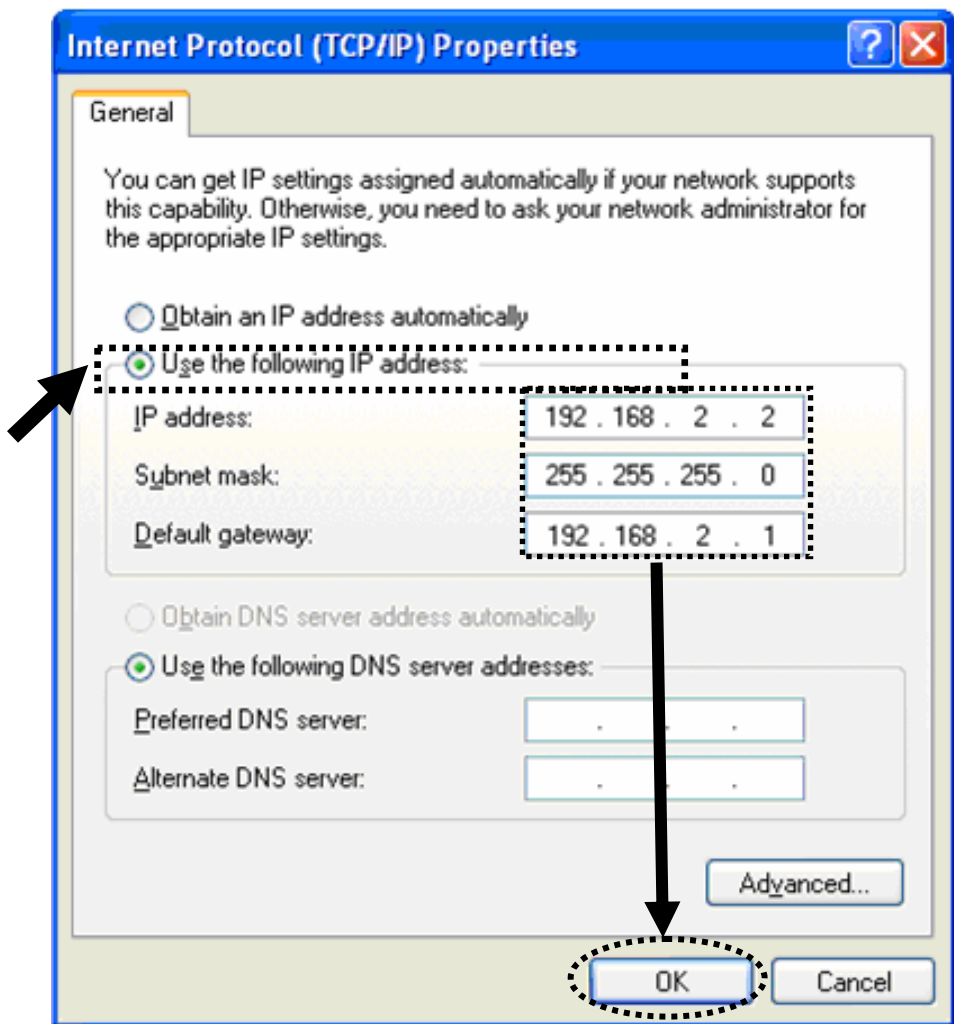

## 2-2-4 Windows Vista IP address setup

1. Click 'Start' button (it should be located at lower-left corner of your computer), then click control panel. Click on '*View Network Status and Tasks*', and then click on '*Manage Network Connections*'. Right-click '*Local Area Connection*', then select '*Properties*'. *Local Area Connection Properties* window will appear, select 'Internet Protocol Version 4 (TCP / IPv4)', and then click '**Properties**'

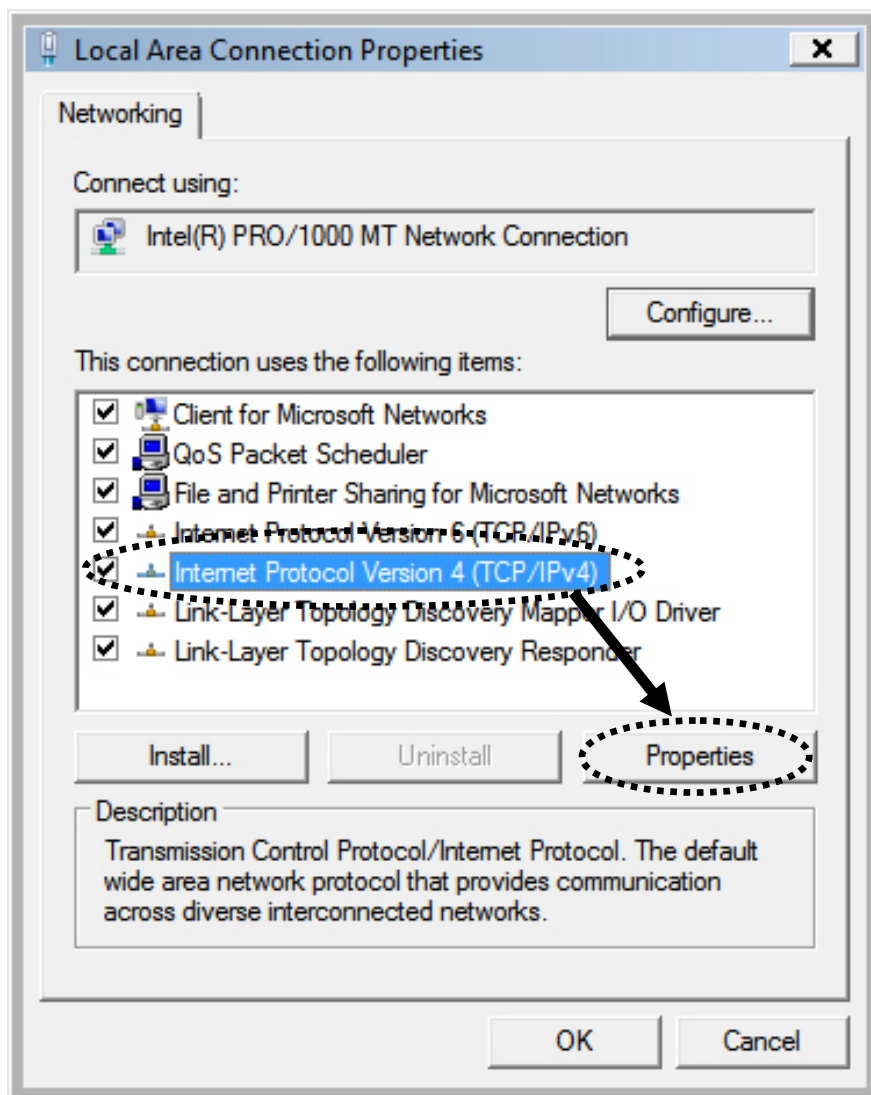



2. Select 'Use the following IP address', then input the following settings in the respective field:

IP address: 192.168.2.2

Subnet Mask: 255.255.255.0

Default gateway: 192.168.2.1

Click 'OK' when finish.

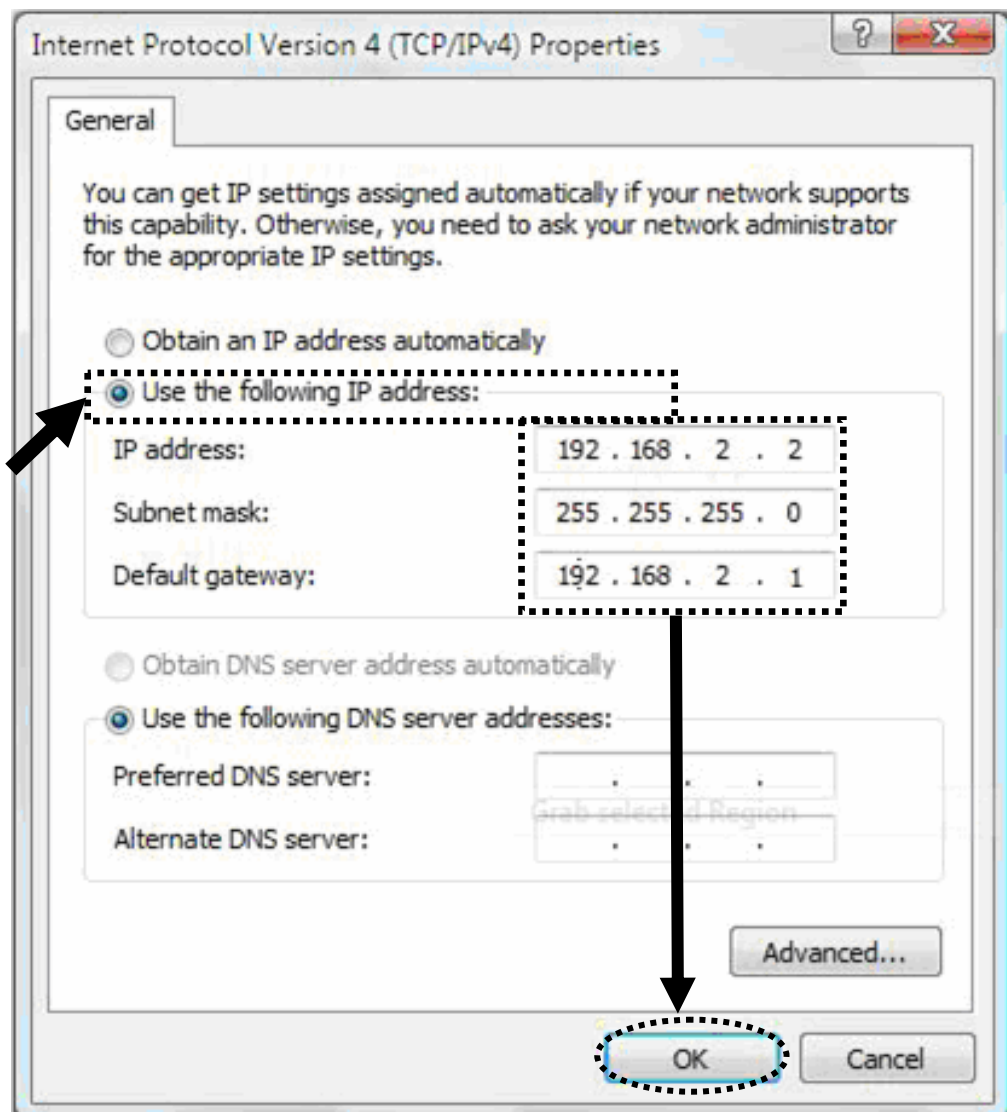

## 2-2-5 Connecting to Web Management Interface by web browser

All functions and settings of this Access Point must be configured via web management interface. Please start your web browser, and input '192.168.2.1' in the address bar, then press 'Enter' key. The following message should be shown:



Please input user name and password in the field respectively, default user name is ‘**admin**’, and default password is ‘**1234**’, then press ‘OK’ button, and you can see the web management interface of this Access Point:

**DIGISOL** DG-WA3002NP 300Mbps Wireless Access Point With PoE

- Home
- Basic Settings
- WPS Setting
- Advanced Settings
- Security
- MAC Filtering
- System Utility
- Configuration Tool
- Upgrade
- Reboot

### Status and Information

You can use the information to monitor the Access Point's MAC address, runtime code and hardware version.

System	
Uptime	0day:0h:4m:10s
Hardware Version	Rev. A
Runtime Code Version	1.02

Wireless Configuration	
Mode	AP
ESSID	Digisoltest
Channel Number	6
Security	WPA-shared key
BSSID	00:1f:1f:b1:0e:f1
Associated Clients	0

LAN Configuration	
IP Address	192.168.2.1
Subnet Mask	255.255.255.0
Default Gateway	0.0.0.0
MAC Address	00:1f:1f:b1:0e:f1

**NOTE:** If you can't see the web management interface, and you're being prompted to input user name and password again, it means you didn't input username and password correctly. Please retype user name and password again. If you're certain about the user name and password you typed, please go to [Section 4-2 Troubleshooting](#) to perform a factory reset, to set the password back to default value.

## 2-3 View System Status and Information

After you are connected to the Access Point by web browser, the first thing you see is 'Status and Information' page. All system and network related information of this Access Point will be displayed here. The information is very helpful when you want to know the detailed information of your Access Point, and when you try to fix the communication problem between this Access Point and other wired / wireless computer / devices.

You can click '**Home**' on the left, and the system status and Information will be displayed, as shown below:

**DIGISOL** DG-WA3002NP 300Mbps Wireless Access Point With PoE

**Home**  
Basic Settings  
WPS Setting  
Advanced Settings  
Security  
MAC Filtering  
System Utility  
Configuration Tool  
Upgrade  
Reboot

### Status and Information

You can use the information to monitor the Access Point's MAC address, runtime code and hardware version.

System	
Uptime	0day:0h:4m:10s
Hardware Version	Rev. A
Runtime Code Version	1.02

Wireless Configuration	
Mode	AP
ESSID	Digisoltest
Channel Number	6
Security	WPA-shared key
BSSID	00:1f:b1:0e:f1
Associated Clients	0

LAN Configuration	
IP Address	192.168.2.1
Subnet Mask	255.255.255.0
Default Gateway	0.0.0.0
MAC Address	00:1f:b1:0e:f1

The following screen shows all the parameters of Status Information.

<b>Status and Information</b>	
You can use the information to monitor the Access Point's MAC address, runtime code and hardware version.	
<b>System</b>	
Uptime	0day:0h:4m:10s
Hardware Version	Rev. A
Runtime Code Version	1.02
<b>Wireless Configuration</b>	
Mode	AP
ESSID	Digisoltest
Channel Number	6
Security	WPA-shared key
BSSID	00:1f:1f:b1:0e:f1
Associated Clients	0
<b>LAN Configuration</b>	
IP Address	192.168.2.1
Subnet Mask	255.255.255.0
Default Gateway	0.0.0.0
MAC Address	00:1f:1f:b1:0e:f1

Here is the description of every item:

<b>Parameter</b>	<b>Description</b>
Uptime	Displays the total passed time since the wireless Access Point is powered.
Hardware Version	Displays hardware version. This information is helpful when you need online help from the dealer of purchase.
Runtime Code Version	Displays current firmware version. If you want to perform firmware upgrade, this number will help you to determine if you need such upgrade.
Mode	Displays current wireless operating mode
ESSID	Displays the current wireless SSID. Default is "Digisol"

Channel Number	Displays current wireless channel number
Security	Displays current wireless security setting
BSSID	Displays current BSSID ( unique identification name of this Access Point, it can not be modified by user)
Associated Clients	Displays the number of connected wireless clients
IP Address	Displays the IP address of this wireless Access Point
Subnet Mask	Displays the net mask of IP address
Default Gateway	Displays the IP address of the default gateway
MAC address	Displays the MAC address of LAN interface

## 2-4 Select an Operating Mode for Wireless Access Point

This Access Point can be operated in different modes; you can click ‘**Basic Setting**’ on the left of web management interface to select an operating mode you want to meet for different needs:

The screenshot shows the web management interface for the DIGISOL DG-WA3002NP. The top header includes the DIGISOL logo, the model number DG-WA3002NP, and the product description '300Mbps Wireless Access Point With PoE'. The left sidebar contains a navigation menu with the following items: Home, Basic Settings (highlighted with a red dashed circle), WPS Setting, Advanced Settings, Security, MAC Filtering, System Utility, Configuration Tool, Upgrade, and Reboot. The main content area is titled 'Basic Settings' and contains the following text: 'This page allows you to define ESSID, and Channel for the wireless connection. These parameters are used for the wireless stations to connect to the Access Point.' Below this text are several configuration fields: Mode (dropdown menu set to AP), Band (dropdown menu set to 2.4 GHz (B+G+N)), MAIN ESSID (text input field containing Digisol), Channel Number (dropdown menu set to 6), and Associated Clients (button labeled Show Active Clients). At the bottom right of the configuration area are two buttons: Apply and Cancel.

You can click ‘**Mode**’ dropdown menu to select operating mode, and there are 6 operating modes available:

Below are the descriptions of different modes supported by Access Point.

<b>Modes</b>	<b>Description</b>
AP	Access Point mode, allows wireless clients to connect to Access Point and exchange data with the devices connected to the wired network.
Station-Infrastructure	Enables the Ethernet devices such as TV and Game player connected to the Access Point to a wireless client.
AP Bridge-Point to Point	Establishes wireless connection with another wireless Access Point using the same mode. It links the wired network which these two wireless Access Points are connected to. Only one Access Point can be connected in this mode.
AP Bridge-Point to Multi-Point	Establishes wireless connection with other wireless Access Points using the same mode. It links the wired network which these wireless Access Points are connected to. Up to four Access Points can be connected in this mode.
AP Bridge-WDS	This mode is similar to 'AP Bridge to Multi-Point', but the Access Point does not work only in a bridge-dedicated mode, but also will be able to accept wireless clients while the Access Point is working as a wireless bridge.
Universal Repeater	This product can act as a wireless range extender that will help you to extend the wireless network. The Access Point can act as Station and AP at the same time. It can use Station function to connect to a Root AP and use AP function to service all wireless clients within its coverage.

Please select one wireless operating mode. For detailed description of every operating mode; please refer to [Section 2-4-1](#) to [2-4-6](#) listed below.

## 2-4-1 AP Mode

This is the most common mode. When in AP mode, this Access Point acts as a bridge between 802.11b/g/n wireless devices and wired Ethernet network, and exchange data between them. When you select 'AP', the following options will be displayed:

**Basic Settings**

This page allows you to define ESSID, and Channel for the wireless connection. These parameters are used for the wireless stations to connect to the Access Point.

<b>Mode :</b>	AP
<b>Band :</b>	2.4 GHz (B+G+N)
<b>MAIN ESSID :</b>	Digisol
<b>Channel Number :</b>	6
<b>Associated Clients :</b>	Show Active Clients

Here is the description of every setup item:

Parameter	Description
Band	<p>Please select the wireless band you wish to use. By selecting different band setting, you'll be able to allow or deny the wireless client of a certain band.</p> <p>If you select 2.4GHz (B), 2.4GHz (N), or 2.4GHz (G), only wireless clients using the wireless band you select (802.11b, 802.11n, or 802.11g) will be able to connect to this Access Point.</p> <p>If you select 2.4GHz (B+G), then only wireless clients using 802.11b and 802.11g band will be able to connect to this Access Point.</p> <p>If you want to allow 802.11b, 802.11g, and 802.11n clients to connect to this Access Point, select 2.4GHz (B+G+N).</p>
Main ESSID	<p>Please input the ESSID (the name used to identify this wireless Access Point) here. You can input up to 32</p>



	alphanumeric characters. <b>PLEASE NOTE THAT ESSID IS CASE SENSITIVE.</b>
Channel Number	Please select a channel number you wish to use. If you know a certain channel number is being used by other wireless Access Points nearby, please refrain from using the same channel number
Associated Clients	Click 'Show Active Clients' button and a new popup window will appear which contains the information about all wireless clients connected to this Access Point. You can click 'Refresh' button in popup window to keep information up-to-date.

After you finish with the setting, please click 'Apply', and the following message will be displayed:

**Save settings successfully!**

You may press CONTINUE button to continue configuring other settings or press APPLY button to restart the system to make the changes take effect.

When you see this message, the settings you made are successfully saved. You can click on 'Continue' button to go back to previous page and continue with other settings, or click 'Apply' button to restart the wireless Access Point and the changes will take effect after about 30 seconds

## 2-4-2 Station-Infrastructure

In this mode, you can connect the Access Point to Ethernet devices such as TV and Game player to enable the Ethernet device to act as a wireless station and connect to a wireless network through an Access Point or AP router.

**Basic Settings**

This page allows you to define ESSID and Channel Number for the wireless connection. These parameters are used for the wireless stations to connect to the Access Point.

Mode :	Station-Infrastructure <span style="float: right;">▼</span>
Band :	2.4 GHz (B+G+N) <span style="float: right;">▼</span>
MAIN ESSID :	Digisol
Site Survey :	<input type="button" value="Select Site Survey"/>

Here is the description of every setup item:

Parameter	Description
Band	<p>Please select the wireless band you wish to use. By selecting different band settings, you'll be able to allow or deny the wireless client of a certain band.</p> <p>If you select 2.4GHz (B), 2.4GHz (N), or 2.4GHz (G), only wireless clients using the wireless band you select (802.11b, 802.11n or 802.11g) will be able to connect to this Access Point.</p> <p>If you select 2.4GHz (B+G), then only wireless clients using 802.11b and 802.11g bands will be able to connect to this Access Point.</p> <p>If you want to allow 802.11b, 802.11g, and 802.11n clients to connect to this Access Point, select 2.4GHz (B+G+N).</p>
Main ESSID	<p>Please input the ESSID (the name used to identify this wireless Access Point) here. You can input up to 32 alphanumerical characters. <b>PLEASE NOTE THAT ESSID IS CASE SENSITIVE.</b></p>

Site Survey	When you use this Access Point as a wireless station for Ethernet network device to have wireless capability, you have to associate it with a working Access Point. Click 'Select Site Survey' button, then a "Wireless Site Survey Table" will pop up. It will list all available Access Points near by. You can select one Access Point in the table and it will join wireless LAN through this Access Point. Please go to <a href="#">Section 2-4-2-1</a> for more information about the 'Wireless Site Survey Table'.
-------------	---

After you finish with setting, please click 'Apply', and the following message will be displayed:

**Save settings successfully!**

You may press CONTINUE button to continue configuring other settings or press APPLY button to restart the system to make the changes take effect.

When you see this message, the settings you made are successfully saved. You can click on 'Continue' button to go back to previous page and continue with other settings, or click 'Apply' button to restart the wireless Access Point and the changes will take effect after about 30 seconds

## 2-4-2-1 Wireless Site Survey

The table will list the Access Points nearby, as the Access Point is set to Station mode; you can select one of the Access Points to associate.

**Wireless Site Survey**

This page provides tool to scan the wireless network. If any Access Point or IBSS is found, you could choose to connect it manually when client mode is enabled.

Select	SSID	BSSID	Band	Channel	Type	Encryption	Signal
<input type="radio"/>	WPS00003200a3	00:0b:2b:40:00:a3	(B+G+N)	1	AP	WPA2-PSK	90
<input type="radio"/>	DIGISOLtest	80:1f:02:1a:d8:38	(B+G+N)	11	AP	WPA2-PSK	74

Here is the description of every setup item:

Parameter	Description
Select	Click the radio button to select the Access Point.
SSID	Displays the SSID name of the Access Point.
BSSID	Displays the BSSID (MAC Address) of the Access Point.
Band	Displays current radio band of the access point.
Channel	Displays current wireless channel number of the access point.
Type	Display the wireless modes include 11b, 11b/g or 11b/g/n or 11n only of the access points.
Encryption	Displays the encryption setting of the Access Points. If you have selected the Access Point with security setting, you have to go to <a href="#">section '2-7 Wireless Security'</a> to set the same security with the Access Point you want to associate.
Signal	The signal strength of each Access Point will be displayed here. Stronger the signal strength, better is the connection quality.
Refresh	Click this button to refresh the table.
Done	Select an access point and click this button to choose the network. The SSID name of the access point you have selected will be displayed in the Main SSID in the Basic

	Setting page.
Close	Click this button to close this pop up window.

### 2-4-3 AP Bridge-Point to Point Mode

In this mode, this wireless Access Point will connect to another wireless Access Point which uses the same mode, and all wired Ethernet clients of both wireless Access Points will be connected together. You can use this mode to connect a network to another network which is physically isolated.

Please note that when you set your Access Point to this mode, it will not accept regular wireless clients anymore.

When you select 'AP Bridge-Point to Point', the following options will be displayed:

**Basic Settings**

This page allows you to define ESSID and Channel Number for the wireless connection. These parameters are used for the wireless stations to connect to the Access Point.

Mode :	AP Bridge-Point to Point <input type="button" value="v"/>
Band :	2.4 GHz (B+G+N) <input type="button" value="v"/>
Channel Number :	11 <input type="button" value="v"/>
MAC address 1 :	000000000000
Set Security :	<input type="button" value="Set Security"/>

Here is the description of every setup item:

Parameter	Description
Band	<p>Please select the wireless band you wish to use. By selecting different band settings, you'll be able to allow or deny the wireless client of a certain band.</p> <p>If you select 2.4GHz (B), 2.4GHz (N), or 2.4GHz (G), only wireless clients using the wireless band you select (802.11b, 802.11n or 802.11g) will be able to connect to this Access Point.</p>

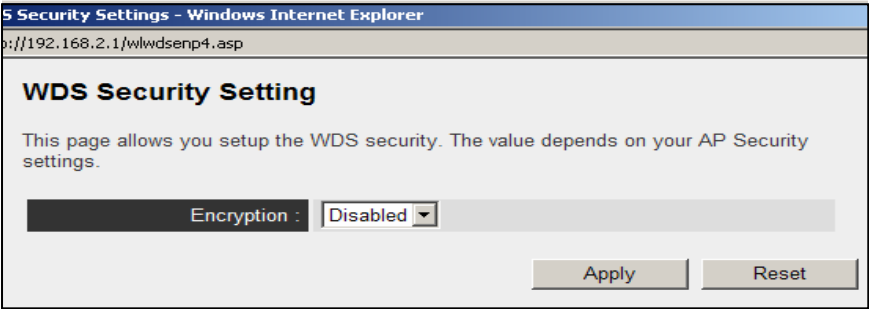
	<p>If you select 2.4GHz (B+G), then only wireless clients using 802.11b and 802.11g band will be able to connect to this Access Point.</p> <p>If you want to allow 802.11b, 802.11g, and 802.11n clients to connect to this Access Point, select 2.4GHz (B+G+N).</p>
Channel Number	Please select a channel number you wish to use. This channel number must be same as the other wireless Access Point you wish to connect.
MAC address 1	Please input the MAC address of the wireless Access Point you wish to connect.
Set Security	<p>Click this button to select an encryption mode for this wireless link, a new popup window will appear, as shown below. For detailed description of encryption modes please refer to <a href="#">Section 2-7</a></p>  <p>The screenshot shows a web browser window titled '5 Security Settings - Windows Internet Explorer' with the URL 'http://192.168.2.1/wlwdsemp4.asp'. The page content is 'WDS Security Setting' with a sub-header 'This page allows you setup the WDS security. The value depends on your AP Security settings.' Below this is a dropdown menu for 'Encryption' set to 'Disabled'. At the bottom right are 'Apply' and 'Reset' buttons.</p>

After you finish with setting, please click ‘Apply’, and the following message will be displayed:

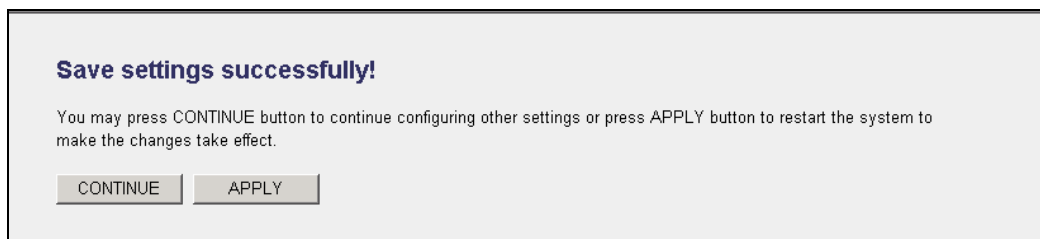

When you see this message, the settings you made are successfully saved. You can click on ‘Continue’ button to go back to previous page and continue with other settings, or click ‘Apply’ button to restart the wireless Access Point and the changes will take effect after about 30 seconds

## 2-4-4 AP Bridge-Point to Multi-Point Mode

In this mode, this wireless Access Point will connect up to four wireless Access Points which use the same mode, and all wired Ethernet clients of every wireless Access Point will be connected together. You can use this mode to connect a network to other networks which are physically isolated.

Please note that when you set your Access Point to this mode, it will not accept regular wireless clients anymore.

When you select 'AP Bridge-Point to Multi-Point', the following options will be displayed:

**Basic Settings**

This page allows you to define ESSID and Channel Number for the wireless connection. These parameters are used for the wireless stations to connect to the Access Point.

<b>Mode :</b>	AP Bridge-Point to Multi-Point
<b>Band :</b>	2.4 GHz (B+G+N)
<b>Channel Number :</b>	11
<b>MAC address 1 :</b>	000000000000
<b>MAC address 2 :</b>	000000000000
<b>MAC address 3 :</b>	000000000000
<b>MAC address 4 :</b>	000000000000
<b>Set Security :</b>	Set Security

Here is the description of every setup item:

Parameter	Description
Band	<p>Please select the wireless band you wish to use. By selecting different band settings, you'll be able to allow or deny the wireless client of a certain band.</p> <p>If you select 2.4GHz (B), 2.4GHz (N), or 2.4GHz (G), only wireless clients using the wireless band you select (802.11b, 802.11n, or 802.11g) will be able to connect to this Access Point.</p>

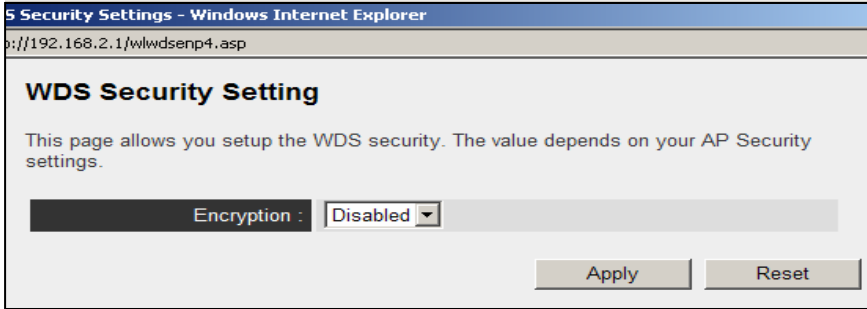
	<p>If you select 2.4GHz (B+G), then only wireless clients using 802.11b and 802.11g band will be able to connect to this Access Point.</p> <p>If you want to allow 802.11b, 802.11g, and 802.11n clients to connect to this Access Point, select 2.4GHz (B+G+N).</p>
Channel Number	Please select a channel number you wish to use. This channel number must be same as the other wireless Access Point you wish to connect.
MAC address 1-4	Please input the MAC address of the wireless Access Point you wish to connect.
Set Security	<p>Click this button to select an encryption mode for this wireless link, a new popup window will appear, as shown below. For detail description of encryption modes please refer to <a href="#">Section 2-7</a>.</p>  <p>The screenshot shows a web browser window titled "5 Security Settings - Windows Internet Explorer" with the address bar showing "http://192.168.2.1/wlwsenp4.asp". The main content area is titled "WDS Security Setting" and contains the text: "This page allows you setup the WDS security. The value depends on your AP Security settings." Below this text is a label "Encryption:" followed by a dropdown menu currently set to "Disabled". At the bottom right of the form are two buttons: "Apply" and "Reset".</p>

After you finish with setting, please click 'Apply', and the following message will be displayed:

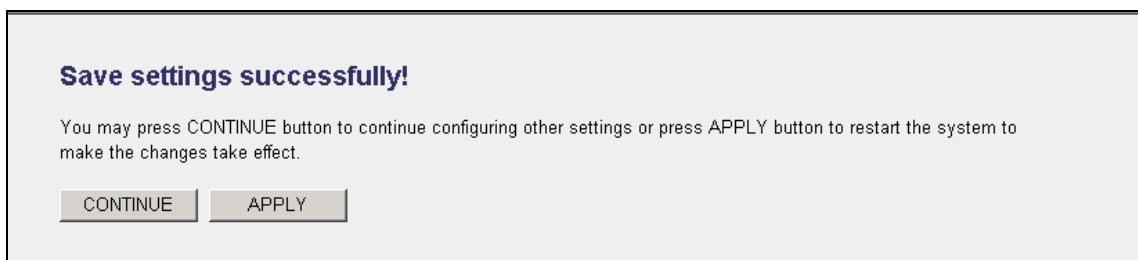

When you see this message, the settings you made are successfully saved. You can click on 'Continue' button to go back to previous page and continue with other settings, or click 'Apply' button to restart the wireless Access Point and the changes will take effect after about 30 seconds



## 2-4-5 AP Bridge-WDS Mode

In this mode, this wireless Access Point will connect to up to four wireless Access Points which use the same mode, and all wired Ethernet clients of every wireless Access Point will be connected together. You can use this mode to connect a network to other networks which are physically isolated.

When you use this mode, this Access Point is still able to accept wireless clients. When you select 'AP Bridge-WDS', the following options will be displayed:

**Basic Settings**

This page allows you to define ESSID, and Channel for the wireless connection. These parameters are used for the wireless stations to connect to the Access Point.

<b>Mode :</b>	AP Bridge-WDS
<b>Band :</b>	2.4 GHz (B+G+N)
<b>MAIN ESSID :</b>	Digisol
<b>Channel Number :</b>	6
<b>Associated Clients :</b>	Show Active Clients
<b>MAC address 1 :</b>	000000000000
<b>MAC address 2 :</b>	000000000000
<b>MAC address 3 :</b>	000000000000
<b>MAC address 4 :</b>	000000000000
<b>Set Security :</b>	Set Security

Here is the description of every setup item:

Parameter	Description
Band	<p>Please select the wireless band you wish to use. By selecting different band settings, you'll be able to allow or deny the wireless client of a certain band.</p> <p>If you select 2.4GHz (B), 2.4GHz (N), or 2.4GHz (G), only wireless clients using the wireless band you select (802.11b, 802.11n or 802.11g) will be able to connect to this Access Point.</p> <p>If you select 2.4GHz (B+G), then only wireless clients using</p>

	<p>802.11b and 802.11g band will be able to connect to this Access Point.</p> <p>If you want to allow 802.11b, 802.11g, and 802.11n clients to connect to this Access Point, select 2.4GHz (B+G+N).</p>														
MAIN ESSID	<p>Please input the ESSID (the name used to identify this wireless Access Point) here. You can input up to 32 alphanumerical characters. <b>PLEASE NOTE THAT ESSID IS CASE SENSITIVE.</b></p>														
Channel Number	<p>Please select a channel number you wish to use. The channel number must be same as the other wireless Access Point you wish to connect.</p>														
Associated Clients	<p>Click 'Show Active Clients' button and a new popup window will appear which contains the information about all wireless clients connected to this Access Point, as shown below. You can click 'Refresh' button in popup window to keep information up-to-date.</p> <div style="border: 1px solid black; padding: 5px; margin: 10px 0;"> <p><b>Active Wireless Client Table</b></p> <p>This table shows the MAC address, transmission, reception packet counters for each associated wireless client.</p> <table border="1" style="width: 100%; border-collapse: collapse; text-align: center;"> <thead> <tr> <th style="background-color: #333; color: white;">MAC Address</th> <th style="background-color: #333; color: white;">Mode</th> <th style="background-color: #333; color: white;">Tx Packet</th> <th style="background-color: #333; color: white;">Rx Packet</th> <th style="background-color: #333; color: white;">Tx Rate (Mbps)</th> <th style="background-color: #333; color: white;">Power Saving</th> <th style="background-color: #333; color: white;">Expired Time (s)</th> </tr> </thead> <tbody> <tr> <td>None</td> <td>---</td> <td>---</td> <td>---</td> <td>---</td> <td>---</td> <td>---</td> </tr> </tbody> </table> <p style="text-align: center;"> <input type="button" value="Refresh"/> <input type="button" value="Close"/> </p> </div>	MAC Address	Mode	Tx Packet	Rx Packet	Tx Rate (Mbps)	Power Saving	Expired Time (s)	None	---	---	---	---	---	---
MAC Address	Mode	Tx Packet	Rx Packet	Tx Rate (Mbps)	Power Saving	Expired Time (s)									
None	---	---	---	---	---	---									
MAC address 1-4	<p>Please input the MAC address of the wireless Access Point you wish to connect.</p>														
Set Security	<p>Click this button to select an encryption mode for this wireless link, a new popup window will appear, as shown below. For detailed description of encryption modes please refer to <a href="#">Section 2-7</a></p>														

### WDS Security Setting

This page allows you setup the WDS security. The value depends on your AP Security settings.

Encryption :	WPA pre-shared key
WPA Unicast Cipher Suite :	<input checked="" type="radio"/> WPA(TKIP) <input type="radio"/> WPA2(AES)
Pre-shared Key Format :	Passphrase
Pre-shared Key :	<input type="text"/>

After you finish with setting, please click ‘Apply’, and the following message will be displayed:

**Save settings successfully!**

You may press CONTINUE button to continue configuring other settings or press APPLY button to restart the system to make the changes take effect.

When you see this message, the settings you made are successfully saved. You can click on ‘Continue’ button to go back to previous page and continue with other settings, or click ‘Apply’ button to restart the wireless Access Point and the changes will take effect after about 30 seconds

## 2-4-6 Universal Repeater

In this mode, the Access Point can act as a wireless repeater; it can be Station and AP at the same time. It can use Station function to connect to a Root AP and use AP function to service all wireless stations within its coverage.

**NOTE: For Repeater Mode, this Access Point will demodulate the received signal and check if the signal is noise or valid data for the operating network. Once the Access Point validates the signal, then it will modulate and amplify the signal again.**

**Basic Settings**

This page allows you to define ESSID, and Channel for the wireless connection. These parameters are used for the wireless stations to connect to the Access Point.

<b>Mode :</b>	Universal Repeater
<b>Band :</b>	2.4 GHz (B+G+N)
<b>MAIN ESSID :</b>	Digisol
<b>Channel Number :</b>	6
<b>Associated Clients :</b>	Show Active Clients
<b>Root AP SSID :</b>	
<b>Select Site Survey</b>	Select Site Survey

Here is the description of every setup item:

Parameter	Description
Band	<p>Please select the wireless band you wish to use. By selecting different band settings, you'll be able to allow or deny the wireless client of a certain band.</p> <p>If you select 2.4GHz (B), 2.4GHz (N), or 2.4GHz (G), only wireless clients using the wireless band you select (802.11b, 802.11n or 802.11g) will be able to connect to this Access Point.</p>

	<p>If you select 2.4GHz (B+G), then only wireless clients using 802.11b and 802.11g band will be able to connect to this Access Point.</p> <p>If you want to allow 802.11b, 802.11g, and 802.11n clients to connect to this Access Point, select 2.4GHz (B+G+N).</p>														
MAIN ESSID	<p>Please input the ESSID (the name used to identify this wireless Access Point) here. You can input up to 32 alphanumerical characters. <b>PLEASE NOTE THAT ESSID IS CASE SENSITIVE.</b></p>														
Channel Number	<p>Please select a channel number you wish to use. The channel number must be same as the other wireless Access Points you wish to connect.</p>														
Associated Clients	<p>Click ‘Show Active Clients’ button and a new popup window will appear which contains the information about all wireless clients connected to this Access Point. You can click ‘Refresh’ button in popup window to keep information up-to-date.</p> <div data-bbox="544 1048 1430 1406" style="border: 1px solid black; padding: 10px; margin: 10px 0;"> <p><b>Active Wireless Client Table</b></p> <p>This table shows the MAC address, transmission, reception packet counters for each associated wireless client.</p> <table border="1" style="width: 100%; border-collapse: collapse; text-align: center;"> <thead> <tr> <th style="background-color: #333; color: white;">MAC Address</th> <th style="background-color: #333; color: white;">Mode</th> <th style="background-color: #333; color: white;">Tx Packet</th> <th style="background-color: #333; color: white;">Rx Packet</th> <th style="background-color: #333; color: white;">Tx Rate (Mbps)</th> <th style="background-color: #333; color: white;">Power Saving</th> <th style="background-color: #333; color: white;">Expired Time (s)</th> </tr> </thead> <tbody> <tr> <td>None</td> <td>---</td> <td>---</td> <td>---</td> <td>---</td> <td>---</td> <td>---</td> </tr> </tbody> </table> <p style="text-align: left; margin-top: 10px;"> <input type="button" value="Refresh"/> <input type="button" value="Close"/> </p> </div>	MAC Address	Mode	Tx Packet	Rx Packet	Tx Rate (Mbps)	Power Saving	Expired Time (s)	None	---	---	---	---	---	---
MAC Address	Mode	Tx Packet	Rx Packet	Tx Rate (Mbps)	Power Saving	Expired Time (s)									
None	---	---	---	---	---	---									
Root AP SSID	<p>In ‘Universal Repeater’ mode, this device can act as a station to connect to a Root AP. You should assign the SSID of the Root AP here or click ‘Select Site Survey’ button to choose a Root AP.</p>														
Select Site Survey	<p>Click ‘Select Site Survey’ button, then a “Wireless Site Survey Table” will pop up. It will list all available Access Points near by. You can select one Access Point in the table and the Access Point will join wireless LAN through this Access Point. Please go to <a href="#">Section 2-4-2-1</a> for more information about the ‘Wireless Site Survey Table’.</p>														

After you finish with setting, please click ‘Apply’, and the following message will be displayed:

**Save settings successfully!**

You may press CONTINUE button to continue configuring other settings or press APPLY button to restart the system to make the changes take effect.

When you see this message, the settings you made are successfully saved. You can click on ‘Continue’ button to go back to previous page and continue with other settings, or click ‘Apply’ button to restart the wireless Access Point and the changes will take effect after about 30 seconds

## **2-5 WPS Setting**

Wi-Fi Protected Setup (WPS) is the simplest way to build a connection between wireless network clients and this Access Point. You need not select encryption mode and input a long encryption passphrase every time you need to setup a wireless client. You only have to press a button on wireless client and this Access Point, and the WPS will do the setup for you.

This Access Point supports two types of WPS: Push-Button Configuration (PBC), and PIN code. If you want to use PBC, you have to switch this Access Point to WPS mode and push a specific button (hard/soft push button) on the wireless client to start WPS mode. You can push Reset/WPS button of this Access Point, or click 'Start PBC' button in the web configuration interface to do this. Press WPS button on wireless client (hard/soft push button) within 2 minutes to establish a secured wireless connection.

If you want to use PIN code, you have to provide the PIN code of the wireless client you wish to connect to this Access Point and then switch the wireless client to WPS mode. The detailed instructions are listed below:

**Note: WPS function of this Access Point will not work for those wireless clients which do not support WPS.**

To use WPS function to set encrypted connection between this Access Point and WPS-enabled wireless client by WPS, click ‘WPS Setting’ on the left of the web management menu, and the following information will be displayed.

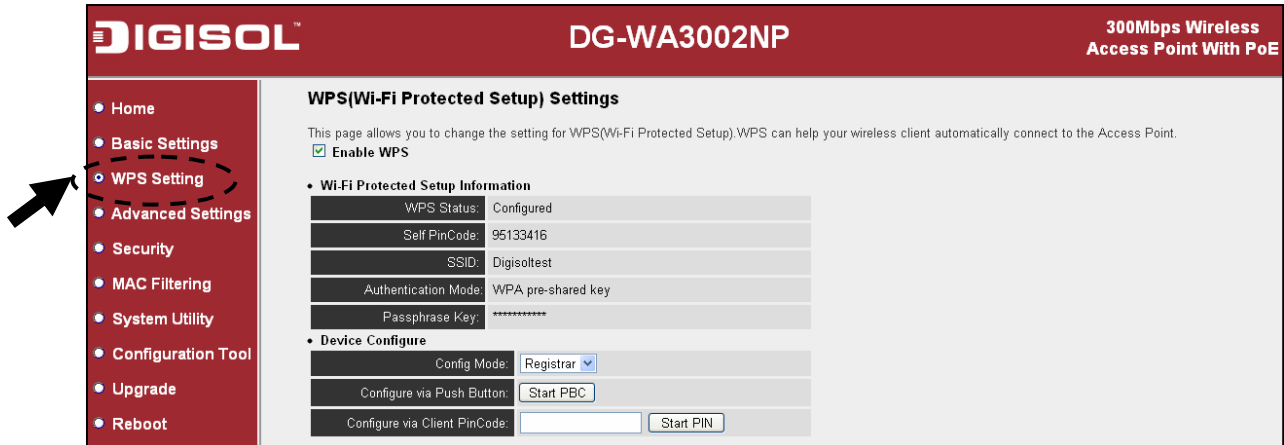

Here is the description of every setup item:

Parameter	Description
Enable WPS	Check this box to enable or disable WPS function. By default check box is enabled.
Wi-Fi Protected Setup Information	<p>All information related to WPS will be displayed here, they're helpful when you're setting up connections by WPS.</p> <p><i>WPS Status:</i> Displays WPS status. If data encryption settings of this Access Point has never been set, ‘unConfigured’ message will be displayed here. (See <a href="#">Section 2-7</a> for detailed information) If data encryption settings have been set before, ‘Configured’ message will be displayed here.</p> <p><i>Self PinCode:</i> This is the WPS PIN code of this Access Point. This code is useful when you need to build wireless connection by WPS with other WPS-enabled wireless devices.</p> <p><i>SSID:</i> Displays the SSID (ESSID) of this Access Point.</p>



	<p><i>Authentication Mode:</i> The wireless security authentication mode of this Access Point will be displayed here. If you don't enable security function of the Access Point before WPS is activated, the Access Point will auto set the security to WPA (AES) and generate a set of passphrase key for WPS connection.</p> <p><i>Passphrase Key:</i> Displays the WPA passphrase here, all characters will be replaced by asterisk for security reason. If encryption is not set on this Access Point, nothing will be displayed here.</p>
Config Mode	There are 'Registrar' and 'Enrollee' modes for the WPS connection. When 'Registrar' is enabled, the wireless clients will follow the Access Point's wireless settings for WPS connection. When 'Enrollee' mode is enabled, the Access Point will follow the wireless settings of wireless client for WPS connection.
Start PBC	Click 'Start PBC' to start Push-Button style WPS setup procedure. This Access Point will wait for WPS requests from wireless clients for 2 minutes. The 'WLAN' LED on the Access Point will be steady on for 2 minutes when this Access Point is waiting for incoming WPS request.
Start PIN	Please input the PIN code of the wireless client you wish to connect, and click 'Start PIN' button. The 'WLAN' LED on the Access Point will be steady on, when this Access Point is waiting for incoming WPS request.

**NOTE: When you're using PBC type WPS setup, you must press 'PBC' button (hardware or software) of wireless client within 120 seconds. If you didn't press PBC button of wireless client within this time period, please press 'PBC' button (hardware or software) of this Access Point again.**

## 2-6 Advanced Wireless Settings

This wireless Access Point has many advanced wireless features. Please note that all settings listed here are for experienced users only, if you're not sure about the meaning and function of these settings, please don't modify them, or the wireless performance will be reduced.

You can click 'Advanced Setting' on the left to enter advanced settings menu, and the following message will be displayed:

**Advanced Settings**

These settings are only for more technically advanced users who have sufficient knowledge about wireless LAN. These settings should not be changed unless you know what effect the changes will have on your wireless Access point.

<b>Fragment Threshold:</b>	2346	(256-2346)
<b>RTS Threshold:</b>	2347	(0-2347)
<b>Beacon Interval:</b>	100	(20- 1024 ms)
<b>DTIM Period:</b>	3	(1-10)
<b>Data Rate:</b>	Auto	
<b>N Data Rate:</b>	Auto	
<b>Channel Width:</b>	<input checked="" type="radio"/> Auto 20/40 MHZ <input type="radio"/> 20 MHZ	
<b>Preamble Type:</b>	<input checked="" type="radio"/> Short Preamble <input type="radio"/> Long Preamble	
<b>Broadcast ESSID:</b>	<input checked="" type="radio"/> Enable <input type="radio"/> Disable	
<b>WMM:</b>	<input type="radio"/> Enable <input checked="" type="radio"/> Disable	
<b>CTS Protect:</b>	<input checked="" type="radio"/> Auto <input type="radio"/> Always <input type="radio"/> None	
<b>TX Power:</b>	100 %	

Here is the description of every setup item:

Parameter	Description
Fragment Threshold	Set the Fragment threshold of wireless radio. Do not modify default value if you don't know what it is, default value is 2346
RTS Threshold	Set the RTS threshold of wireless radio. Do not modify default value if you don't know what it is, default value is 2347
Beacon Interval	Set the beacon interval of wireless radio. Do not modify default value if you don't know what it is, default value is 100

DTIM Period	Set the DTIM period of wireless radio. Do not modify default value if you don't know what it is, default value is 3
Data Rate	Set the wireless data transfer rate to a certain value. Since most of the wireless devices will negotiate with each other and pick a proper data transfer rate automatically, it's not necessary to change this value unless you know what will happen after modification.
N Data Rate	Set the data rate of 802.11n clients, available options are MCS 0 to MCS15, it's safe to set this option to 'Auto' and it's not necessary to change this value unless you know what will happen after modification.
Channel Width	Select wireless channel width (bandwidth taken by wireless signals of this Access Point). It is suggested to select 'Auto 20/40MHz'. Do not change to '20 MHz' unless you know what it is.
Preamble Type	Set the type of preamble of wireless radio. Do not modify default value if you don't know what it is, default setting is 'Short Preamble'.
Broadcast ESSID	Decides if the wireless Access Point will broadcast its own ESSID or not. You can hide the ESSID of your wireless Access Point (set the option to 'Disable'), so only people who know the ESSID of your wireless Access Point can get connected.
WMM	WMM (Wi-Fi Multimedia) technology, which can improve the performance of certain network applications, like audio/video streaming, network telephony (VoIP), and others. When you enable WMM function, the Access Point will define the priority of different kinds of data, to give higher priority to applications which require instant responding. Therefore you can improve the performance of such network applications.
CTS Protect	Enabling this setting will reduce the chance of radio signal collisions between 802.11b and 802.11g wireless Access Points. It is recommended to set this option to 'Auto'.
TX Power	You can set the output power of wireless radio. This value can be set to less than 100% if your wireless coverage area is small. This will enhance security (malicious / unknown users in distance will not be able to reach your wireless Access Point).

After you finish with setting, please click ‘Apply’, and the following message will be displayed:

**Save settings successfully!**

You may press CONTINUE button to continue configuring other settings or press APPLY button to restart the system to make the changes take effect.

When you see this message, the settings you made are successfully saved. You can click on ‘Continue’ button to go back to previous page and continue with other settings, or click ‘Apply’ button to restart the wireless Access Point and the changes will take effect after about 30 seconds

## 2-7 Wireless Security

This wireless Access Point provides many types of wireless security (wireless data encryption). When you use data encryption, data transferred by radio signals in the air will become unreadable for those people who don't know correct encryption key (encryption password).

Please remember it's very important to set wireless security settings properly! Without a proper setting, hackers and intruders may gain access to your local network and interfere with your computers and servers, which could cause serious problem.

There are two ways to set wireless security:

### A. Basic Settings:

1. Click 'Basic Settings' on the left of web management interface.



2. Click 'Set Security' button when the wireless operating mode you selected is 'AP Bridge-Point to Point', 'AP Bridge-Point to Multi-Point', or 'AP Bridge-WDS'.

Mode :	AP Bridge-Point to Point
Band :	2.4 GHz (B+G+N)
Channel Number :	11
MAC address 1 :	000000000000
Set Security :	<b>Set Security</b>

Apply Cancel

## B. Security:

1. Click 'Security' on the left of web management interface.

**DIGISOL** DG-WA3002NP 300Mbps Wireless Access Point With PoE

- Home
- Basic Settings
- WPS Setting
- Advanced Settings
- **Security**
- MAC Filtering
- System Utility
- Configuration Tool
- Upgrade
- Reboot

### Security

This page allows you setup the wireless security. Turn on WEP or WPA by using Encryption Keys to prevent any unauthorized access to your wireless network.

Encryption : Disable

Enable 802.1x Authentication

Apply Cancel

There are four types of security levels you can select: Disable (no security - data encryption disabled), WEP, WPA Pre-shared Key, and WPA Radius. Please refer to the following sections for detailed instructions.

There are several things you can do to improve wireless security:

1. Always enable data encryption. Only disable it when you want to open your wireless Access Point to the public.
2. Never use simple words as encryption password. Using a random combination of symbols, numbers, and alphabets will greatly improve security.
3. Use WPA when possible - it's much safer than WEP.
4. Change encryption password when you've used it for a longer period.

## 2-7-1 Disable Security

Select the SSID you wish to configure. When you select 'Disable', wireless encryption for the network is disabled.

**Security**

This page allows you setup the wireless security. Turn on WEP or WPA by using Encryption Keys to prevent any unauthorized access to your wireless network.

Encryption :

Enable 802.1x Authentication

After you finish with the setting, please click 'Apply', and the following message will be displayed:

**Save settings successfully!**

You may press CONTINUE button to continue configuring other settings or press APPLY button to restart the system to make the changes take effect.

When you see this message, the settings you made are successfully saved. You can click on 'Continue' button to go back to previous page and continue with other settings, or click 'Apply' button to restart the wireless Access Point and the changes will take effect after about 30 seconds



## 2-7-2 WEP

WEP (Wired Equivalent Privacy) is a common encryption mode, it's safe enough for home and personal use. But if you need higher level of security, please consider using WPA encryption (see next Section).

However, some wireless clients don't support WPA, but only support WEP, so WEP is still a good choice for you if you have such kind of clients in your network environment.

When you select 'WEP' as encryption type, the following fields will be displayed:

**Security**

This page allows you setup the wireless security. Turn on WEP or WPA by using Encryption Keys to prevent any unauthorized access to your wireless network.

<b>Encryption :</b>	WEP
<b>Key Length :</b>	64-bit
<b>Key Format :</b>	Hex (10 characters)
<b>Default Tx Key :</b>	Key 1
<b>Encryption Key 1 :</b>	*****

Enable 802.1x Authentication

Here is the description of every setup item:

Parameter	Description
Key Length	There are two types of WEP key length: 64-bit and 128-bit. Using '128-bit' is safer than '64-bit', but will reduce the data transfer performance to some extent.
Key Format	There are two types of key formats: ASCII and Hex. When you select a key format, the number of characters of the key will be displayed. For example, if you select '64-bit' as key length, and 'Hex' as key format, you'll see the message at the right of 'Key Format' is 'Hex (10 characters)', which means the length of WEP key is 10 characters.
Default Tx Key	By default key 1 is selected here.

Encryption Key 1	Input WEP key characters here, the number of characters must be the same as the number displayed at 'Key Format' field. You can use any alphanumerical characters (0-9, a-z, and A-Z) if you select 'ASCII' key format, and if you select 'Hex' as key format, you can use characters 0-9, a-f, and A-F. You must enter at least one encryption key here, and if you entered multiple WEP keys, they should not be the same.
Enable 802.1x Authentication	Check this box to enable 802.1x user authentication. Please refer to <a href="#">Section 2-7-5</a> for detailed instructions.

After you finish with the settings, please click 'Apply', and the following message will be displayed:

**Save settings successfully!**

You may press CONTINUE button to continue configuring other settings or press APPLY button to restart the system to make the changes take effect.

When you see this message, the settings you made are successfully saved. You can click on 'Continue' button to go back to previous page and continue with other settings, or click 'Apply' button to restart the wireless Access Point and the changes will take effect after about 30 seconds

### 2-7-3 WPA Pre-shared Key

WPA Pre-shared key is the safest encryption method currently, and it's recommended to use this encryption method to ensure the safety of your data.

When you select 'WPA pre-shared key' as encryption type, the following fields will be displayed:

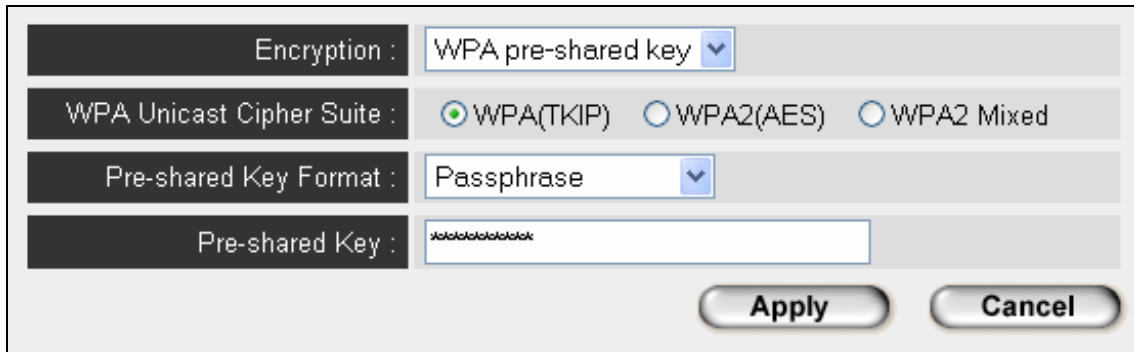

The screenshot shows a configuration dialog box with the following fields and options:

- Encryption :** WPA pre-shared key (dropdown menu)
- WPA Unicast Cipher Suite :** WPA(TKIP) (selected), WPA2(AES), WPA2 Mixed
- Pre-shared Key Format :** Passphrase (dropdown menu)
- Pre-shared Key :** \*XXXXXXXXXX (text input field)
- Buttons:** Apply, Cancel

Here is the description of every setup item:

Parameter	Description
WPA Unicast Cipher Suite	Available options are: WPA (TKIP), WPA2 (AES), and WPA2 Mixed. You can select one of them, but you have to make sure, your wireless client supports the cipher you selected.
Pre-shared Key Format	Please select the format of pre-shared key here, available options are 'Passphrase' (8 to 63 alphanumerical characters) and 'Hex' (64 hexadecimal characters – 0 to 9 and a to f).
Pre-shared Key	Please input pre-shared key according to the key format you selected here. For security reasons, don't use simple words.

After you finish with setting, please click ‘Apply’, and the following message will be displayed:

**Save settings successfully!**

You may press CONTINUE button to continue configuring other settings or press APPLY button to restart the system to make the changes take effect.

When you see this message, the settings you made are successfully saved. You can click on ‘Continue’ button to go back to previous page and continue with other settings, or click ‘Apply’ button to restart the wireless Access Point and the changes will take effect after about 30 seconds

#### 2-7-4 WPA RADIUS

WPA Radius is the combination of WPA encryption method and RADIUS user authentication. If you have a RADIUS authentication server, you can check the identity of every wireless client by user database.

When you select ‘WPA RADIUS’ as encryption type, the following fields will be displayed:

**Security**

This page allows you setup the wireless security. Turn on WEP or WPA by using Encryption Keys to prevent any unauthorized access to your wireless network.

Encryption :	WPA RADIUS
WPA Unicast Cipher Suite :	<input checked="" type="radio"/> WPA(TKIP) <input type="radio"/> WPA2(AES) <input type="radio"/> WPA2 Mixed
RADIUS Server IP address :	<input type="text"/>
RADIUS Server Port :	1812
RADIUS Server Password :	<input type="text"/>

Here is the description of every setup item:

<b>Parameter</b>	<b>Description</b>
WPA Unicast Cipher Suite	You can select WPA encryption type here. AES is safer than TKIP, but not every wireless client supports it. Please refer to the specification of your wireless client to decide which encryption type you should use.
RADIUS Server IP address	Please input the IP address of RADIUS authentication server here.
RADIUS Server Port	Please input the port number of RADIUS authentication server here. Default value is 1812.
RADIUS Server Password	Please input the password of RADIUS authentication server here.

After you finish with setting, please click ‘Apply’, and the following message will be displayed:

**Save settings successfully!**

You may press CONTINUE button to continue configuring other settings or press APPLY button to restart the system to make the changes take effect.

When you see this message, the settings you made are successfully saved. You can click on ‘Continue’ button to go back to previous page and continue with other settings, or click ‘Apply’ button to restart the wireless Access Point and the changes will take effect after about 30 seconds

## 2-7-5 802.1x Authentication

You can enable 802.1x user identification (based on RADIUS user authentication server) by checking 'Enable 802.1x Authentication' box when you select 'Disable' or 'WEP' as encryption type, and the following message will be displayed:

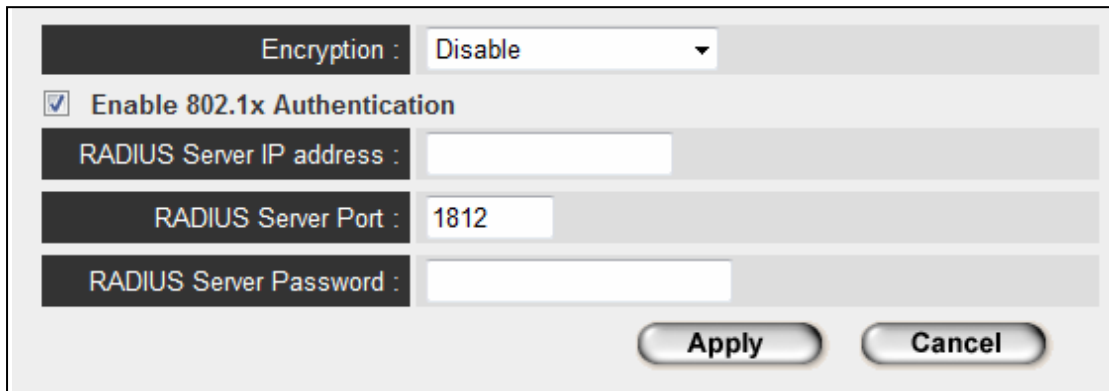

Encryption : Disable

Enable 802.1x Authentication

RADIUS Server IP address :

RADIUS Server Port : 1812

RADIUS Server Password :

Apply Cancel

Here is the description of every setup item:

Parameter	Description
Enable 802.1x Authentication	Enables or disables the use of 802.1x user authentication.
RADIUS Server IP address	Please input the IP address of RADIUS authentication server here.
RADIUS Server Port	Please input the port number of RADIUS authentication server here. Default value is 1812.
RADIUS Server Password	Please input the password of RADIUS authentication server here.

After you finish with setting, please click ‘Apply’, and the following message will be displayed:

**Save settings successfully!**

You may press CONTINUE button to continue configuring other settings or press APPLY button to restart the system to make the changes take effect.

When you see this message, the settings you made are successfully saved. You can click on ‘Continue’ button to go back to previous page and continue with other settings, or click ‘Apply’ button to restart the wireless Access Point and the changes will take effect after about 30 seconds

## 2-8 MAC Filtering

Another security measure you can use to keep hackers and intruders away is ‘MAC filtering’. You can pre-define a so-called ‘white-list’, which contains MAC addresses of the wireless clients you trust. All other wireless clients with MAC addresses which are not in your list will be denied by this wireless Access Point.

To setup MAC filtering, please click ‘MAC Filtering’ on the left of web management interface.

**DIGISOL** DG-WA3002NP 300Mbps Wireless Access Point With PoE

**MAC Address Filtering**

For security reason, use MAC Address Filtering so that Access point will allow only authorized MAC address to connect.

- **MAC Address Filtering Table**  
It allows to enter 20 sets of MAC Address only.

NO.	MAC Address	Comment	Select
-----	-------------	---------	--------

Delete Selected Delete All Reset

Enable Wireless Access Control

New MAC Address: Comment: Add Clear

Apply Cancel



The following messages will be displayed:

This page contains two parts of MAC filtering information. All allowed MAC addresses will be listed in upper part (1), and you can add new MAC addresses by components in lower part (2).

Here is the description of every setup item:

Parameter	Description
Select	Check this box to select one or more MAC address (es) to delete.
Delete Selected	Click this button to delete all selected MAC address (es).
Delete All	Delete all MAC address entries.
Reset	Uncheck all selected MAC address entries.
Enable Wireless Access Control	Check this box to enable MAC address restriction. If unchecked, no restriction will be enforced (any wireless client with proper encryption setting will be able to connect to this wireless Access Point).
MAC address	Input MAC address here, which this wireless Access Point will permit to access. You need not add colon (:) or hyphen (-), just input 0 to 9 and a to f here, like 112233445566 or aabbccddeeff.
Comment	You can input any text here as the comment of this MAC

	address, like 'ROOM 2A Computer' or anything. You can input up to 16 alphanumerical characters here. This is optional and you can leave it blank, however, it's recommended to use this field to write a comment for every MAC address as a memory aid.
Add	When you finish inputting MAC address and (optional) Comment, click this button to add the MAC address to the list.
Clear	Remove all characters in 'MAC address' and 'Comment' field.

After you finish with setting, please click 'Apply', and the following message will be displayed:

**Save settings successfully!**

You may press CONTINUE button to continue configuring other settings or press APPLY button to restart the system to make the changes take effect.

When you see this message, the settings you made are successfully saved. You can click on 'Continue' button to go back to previous page and continue with other settings, or click 'Apply' button to restart the wireless Access Point and the changes will take effect after about 30 seconds

## 2-9 System Utility

This Access Point provides some control functions, which include password, IP address management, and DHCP server function. Please click ‘System Utility’ on the left of web management interface to access these functions as shown below.

The screenshot shows the web management interface for the DIGISOL DG-WA3002NP. The top header includes the DIGISOL logo, the model number DG-WA3002NP, and the text '300Mbps Wireless Access Point With PoE'. On the left, a navigation menu lists: Home, Basic Settings, WPS Setting, Advanced Settings, Security, MAC Filtering, System Utility (highlighted with a dashed circle and an arrow), Configuration Tool, Upgrade, and Reboot. The main content area is titled 'System Utility' and contains the following sections:

- LED ON OFF**: A control for the LED status, currently set to 'On' (radio button selected).
- Password Settings**: Fields for 'Current Password', 'New Password', and 'Re-Enter Password'.
- Management IP**: Fields for 'IP Address' (192.168.2.1), 'Subnet Mask' (255.255.255.0), 'Gateway Address' (0.0.0.0), and a 'DHCP Server' dropdown menu set to 'Disabled'.
- DHCP Server**: Fields for 'Default Gateway IP' (0.0.0.0), 'Domain Name Server IP' (0.0.0.0), 'Start IP' (192.168.2.100), 'End IP' (192.168.2.200), 'Domain Name', and 'Lease Time' (Forever).

## 2-9-1 LED On/Off

You can turn on or off the LED of this wireless access point.

Please click 'System Utility' on the left, and the following message will be displayed:

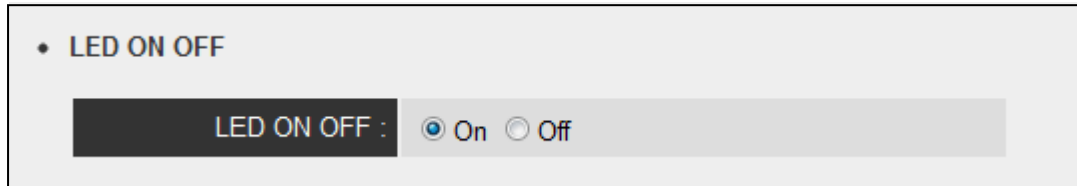

Please select the LED behavior you wish to use. After you finish, please go to the bottom of this page and click 'Apply', and the following message will be displayed:

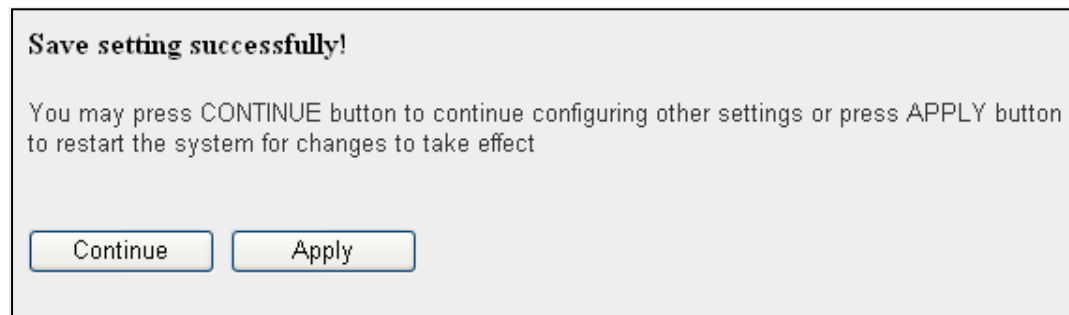

When you see this message, the settings you made are successfully saved. You can click on 'Continue' button to go back to previous page and continue with other settings, or click 'Apply' button to restart the wireless Access Point and the changes will take effect after about 30 seconds

## 2-9-2 Change Password

You can change the password used to enter the web configuration menu of this wireless Access Point.

Please click 'System Utility' on the left, and the following message will be displayed:

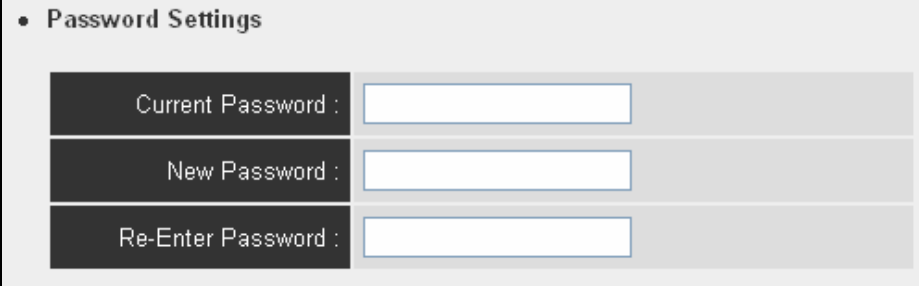

The screenshot shows a web form titled "Password Settings" with three input fields:

- Current Password :
- New Password :
- Re-Enter Password :

Please input current password in 'Current Password' field, then input new password in both 'New Password' and 'Re-Enter Password' fields. After you finish, please go to the bottom of this page and click 'Apply', and the following message will be displayed:

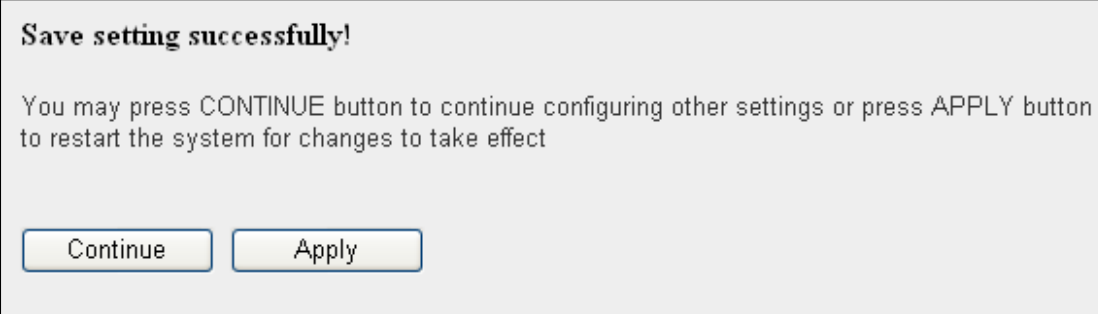

The screenshot shows a message box with the following text and buttons:

**Save setting successfully!**

You may press CONTINUE button to continue configuring other settings or press APPLY button to restart the system for changes to take effect

When you see this message, the settings you made are successfully saved. You can click on 'Continue' button to go back to previous page and continue with other settings, or click 'Apply' button to restart the wireless Access Point and the changes will take effect after about 30 seconds

Login screen will pop up, enter the newly configured password and press ok button.



### 2-9-3 IP Address of the Wireless Access Point

You can change the IP address of this wireless Access Point, so it can become a part of your local network. Please remember this address, or you will not be able to connect to the configuration menu of this wireless Access Point.

Default IP address is: 192.168.2.1 / Subnet Mask 255.255.255.0, you can press and hold 'Reset/WPS' button over 10 seconds to change the IP address back to default value if you forget the IP address you set.

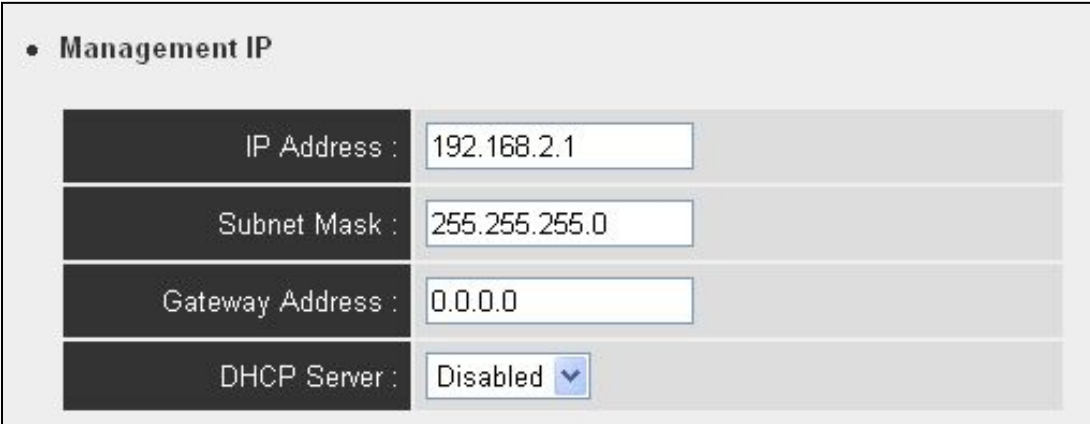

• Management IP

IP Address :	<input type="text" value="192.168.2.1"/>
Subnet Mask :	<input type="text" value="255.255.255.0"/>
Gateway Address :	<input type="text" value="0.0.0.0"/>
DHCP Server :	<input type="button" value="Disabled"/>

Please input IP address and Subnet Mask in corresponding fields. You can also input IP address of the gateway in 'Gateway Address' field, if you need to manage this wireless Access Point from other network (like Internet).

If you want to activate the DHCP server function of this wireless Access Point, please select 'Enabled' in 'DHCP Server' option, and see next Section for detailed instructions. If you don't want to use DHCP server function of this wireless Access Point, or there's another DHCP server on the network this Access Point connects to, please select 'Disabled'.

After you finish, please go to the bottom of this page and click ‘Apply’, and the following message will be displayed:

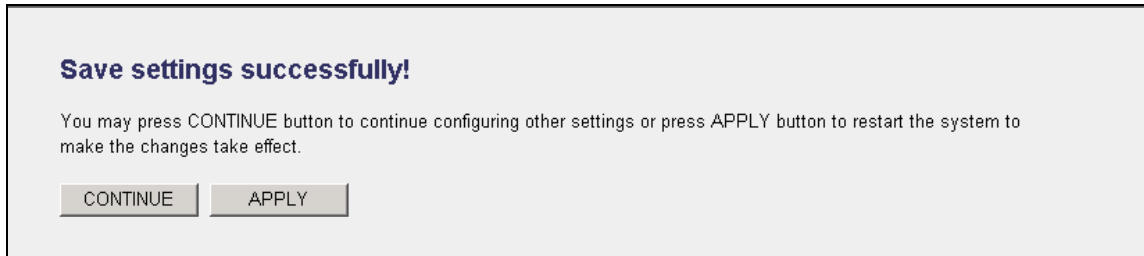

When you see this message, the settings you made are successfully saved. You can click on ‘Continue’ button to go back to previous page and continue with other settings, or click ‘Apply’ button to restart the wireless Access Point and the changes will take effect after about 30 seconds



## 2-9-4 DHCP Server

This wireless Access Point is capable to act as a DHCP server for your network, and it's disabled by default.

• DHCP Server

Default Gateway IP :	<input type="text" value="0.0.0.0"/>
Domain Name Server IP :	<input type="text" value="0.0.0.0"/>
Start IP :	<input type="text" value="192.168.2.100"/>
End IP :	<input type="text" value="192.168.2.200"/>
Domain Name :	<input type="text"/>
Lease Time :	<input type="text" value="Forever"/> <span style="font-size: small;">▼</span>

**NOTE: Please remember to select 'Enabled' in 'DHCP Server' option as described in last Section, or all DHCP-related fields will be grayed out, and you will not be able to input any DHCP parameter.**

Here is the description of every setup item:

Parameter	Description
Default Gateway IP	Please input the IP address of default gateway of your network here.
Domain Name Server IP	Please input the IP address of domain name server (DNS) here.
Start IP	Please input the start IP address of the IP range.
End IP	Please input the end IP address of the IP range.
Domain Name	If you wish, you can also input the domain name for your network. This is optional.
Lease Time	Please choose a lease time (the duration that every

	computer can keep a specific IP address) of every IP address assigned by this Access Point from dropdown menu.
--	--

After you finish, please click ‘Apply’, and the following message will be displayed:

**Save settings successfully!**

You may press CONTINUE button to continue configuring other settings or press APPLY button to restart the system to make the changes take effect.

When you see this message, the settings you made are successfully saved. You can click on ‘Continue’ button to go back to previous page and continue with other settings, or click ‘Apply’ button to restart the wireless Access Point and the changes will take effect after about 30 seconds

## 3. Advanced Configuration

### 3-1 Configuration Backup and Restore

You can backup all configurations of this Access Point to a file, so you can make several copies of the Access Point configuration for security reason.

To backup or restore Access Point configuration, please follow the instructions mentioned below:

Please click 'Configuration Tool' on the left of the web management interface.

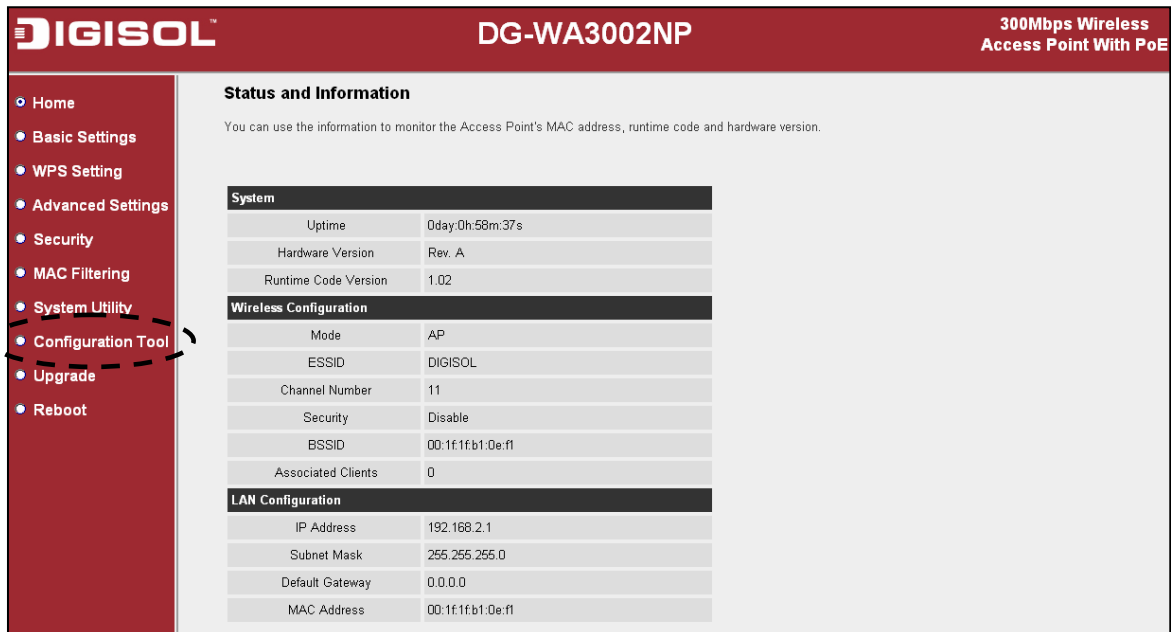

**DIGISOL™** DG-WA3002NP 300Mbps Wireless Access Point With PoE

**Status and Information**  
You can use the information to monitor the Access Point's MAC address, runtime code and hardware version.

System	
Uptime	0day:0h:58m:37s
Hardware Version	Rev. A
Runtime Code Version	1.02

Wireless Configuration	
Mode	AP
ESSID	DIGISOL
Channel Number	11
Security	Disable
BSSID	00:1f:1f:b1:0e:f1
Associated Clients	0

LAN Configuration	
IP Address	192.168.2.1
Subnet Mask	255.255.255.0
Default Gateway	0.0.0.0
MAC Address	00:1f:1f:b1:0e:f1

The following message will be displayed on your web browser.

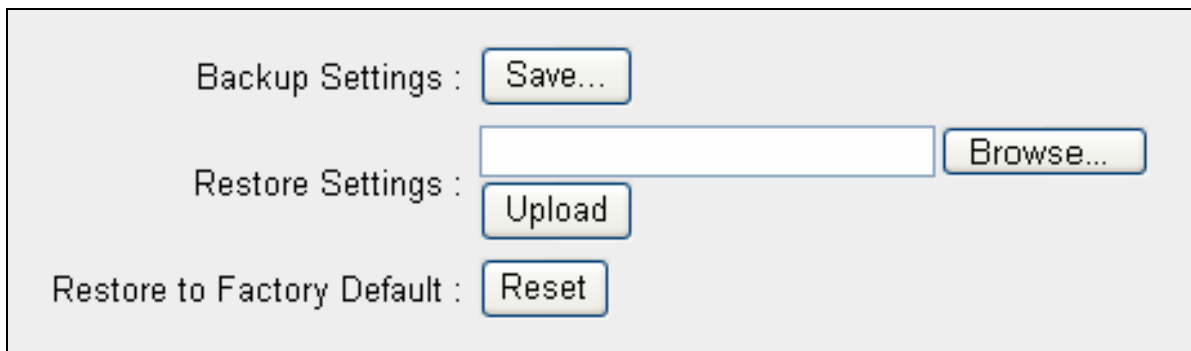

Backup Settings :

Restore Settings :

Restore to Factory Default :

Here is the description of every button:

Parameter	Description
Backup Settings	Press 'Save...' button, and you'll be prompted to download the configuration as a file, default filename is 'config.bin', you can save it as another filename for different versions, and keep it in a safe place.
Restore Settings	Press 'Browse...' to pick a previously-saved configuration file from your computer, and then click 'Upload' to transfer the configuration file to Access Point. After the configuration is uploaded, the Access Point's configuration will be replaced by the file you just uploaded.
Restore to Factory Default	Click this button to remove all settings you made, and restore the configuration of this Access Point back to factory default settings.

## 3-2 Firmware Upgrade

If there is a new firmware of this wireless Access Point, you can upload it which will change the firmware to the new one, to get extra functions or problem fix.

To perform firmware upgrade, please click 'Upgrade' on the left of web management interface

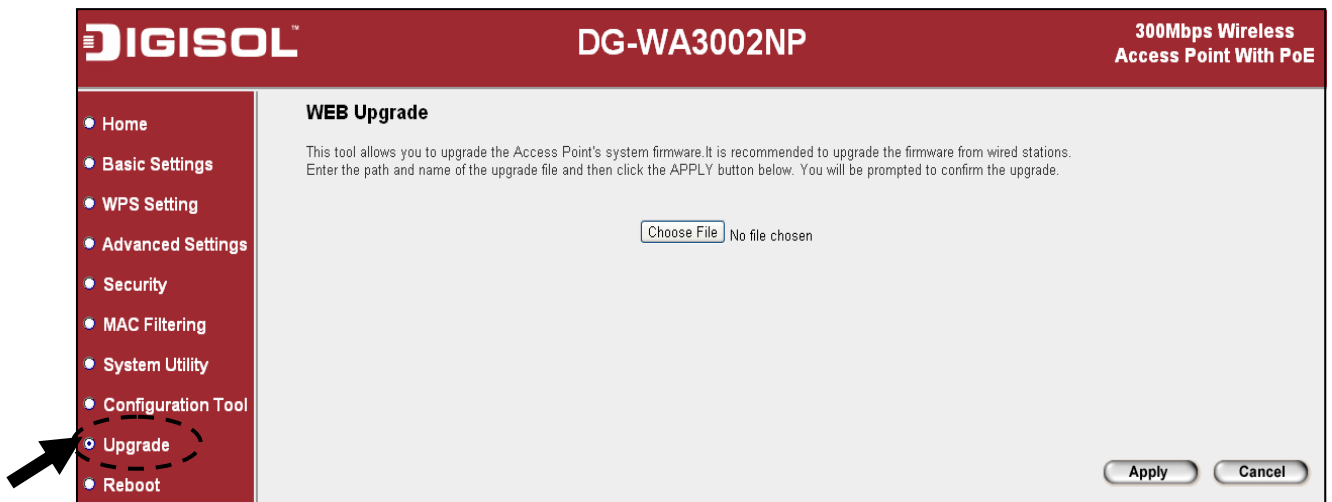

The following message will be displayed:

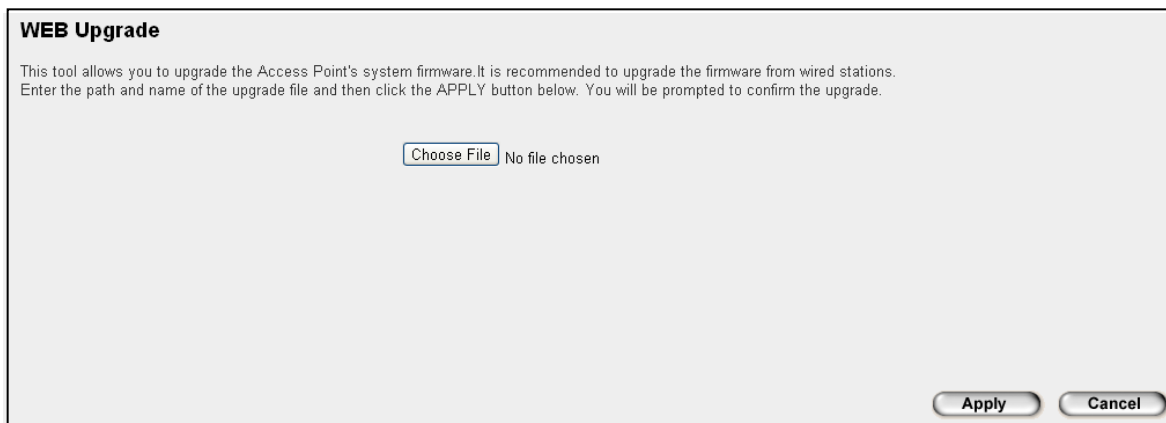

Click 'Browse...' button first, you'll be prompted to provide the filename of firmware upgrade file. Please download the latest firmware file from our website, and use it to upgrade your Access Point.

After a firmware upgrade file is selected, click 'Apply' button, and the Access Point will start the firmware upgrade procedure automatically. The procedure may take several minutes, please be patient.

***NOTE: Never interrupt the upgrade procedure by closing the web browser or physically disconnecting your computer from the Access Point. If the firmware you uploaded is corrupt, the firmware upgrade will fail, and you may have to return this Access Point to the dealer of purchase to ask for help. (Warranty voids if you interrupt the upgrade procedure).***

### 3-3 System Reboot

When you think the Access Point is not working properly, you can use this function to restart the Access Point; this may help and solve the problem.

This function is useful when the Access Point is far from you or unreachable. However, if the Access Point is not responding, you may have to switch it off by unplugging it from the power socket and plugging it back again after 10 seconds.

To reset your Access Point, please click ‘Reboot’ on the left of the web management interface.

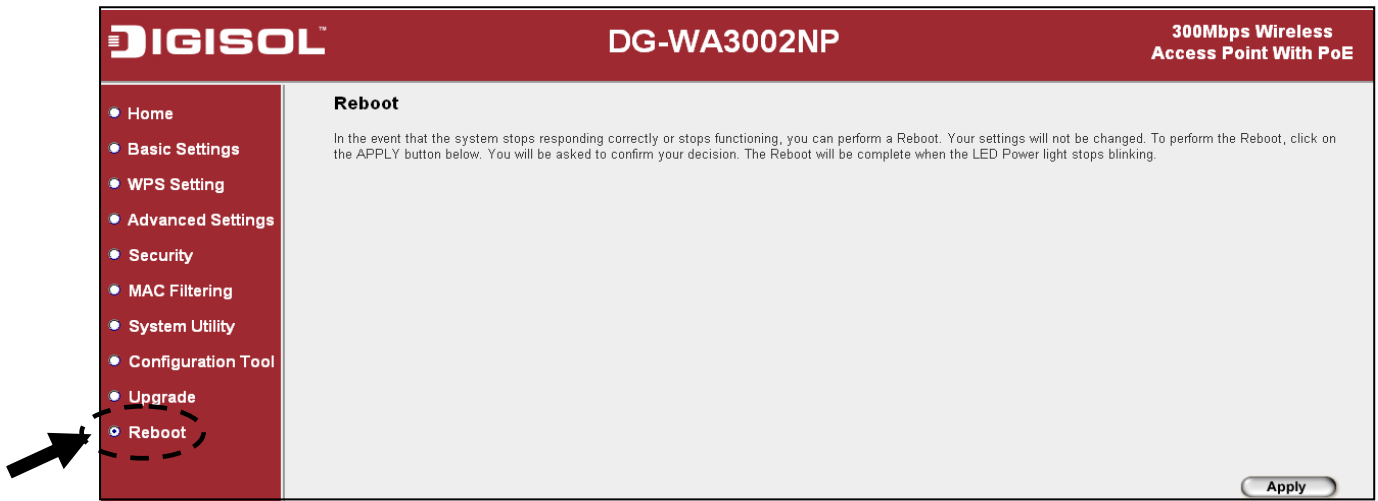

The following message will be displayed:

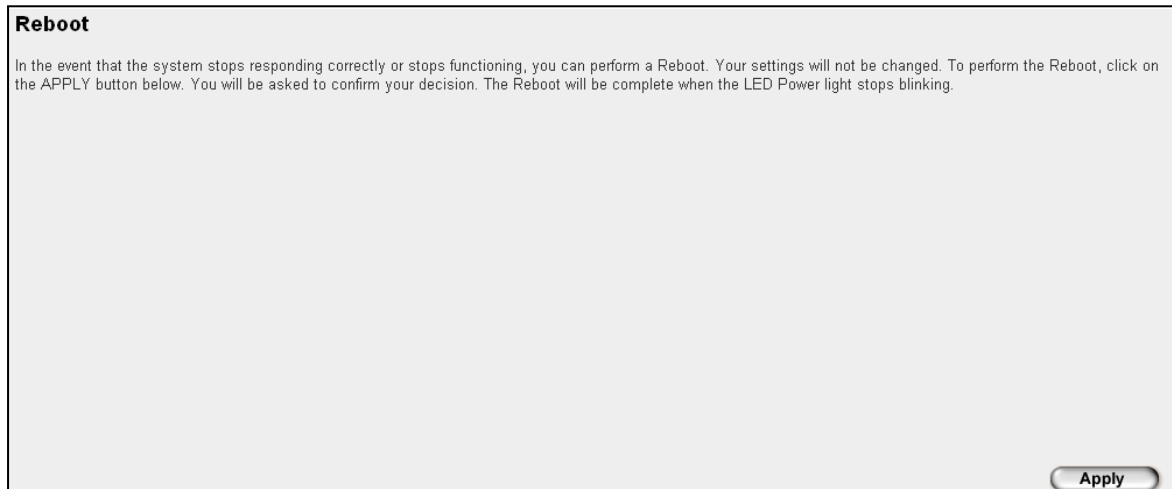

Please click 'Apply', and a popup message will appear asking you again, to make sure you really want to reset the Access Point:

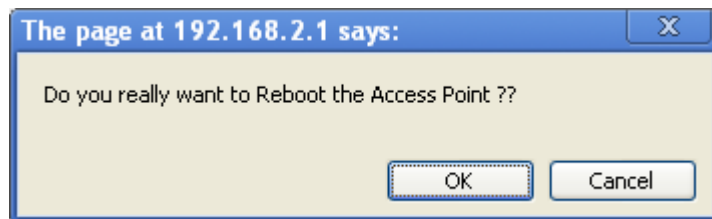

Click 'OK' to reset the Access Point, or click 'Cancel' to abort. Once you click on 'OK' the following screen will appear.

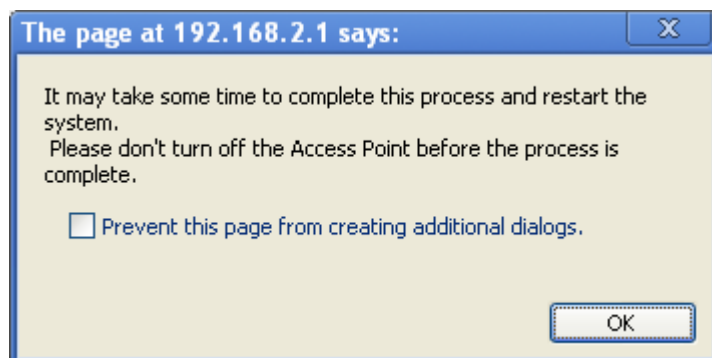

Then click 'OK'.

***NOTE:*** Please remember all connections between wireless client and this Access Point will be disconnected while the unit is rebooting.



## 4. Appendix

### 4-1 Hardware Specification

Flash: 2MB

SDRAM: 16MB

LAN Port: 10/100M UTP Port x 1

Antenna: PiFa antenna x 2 (2T2R MIMO technology)

Power: 5VDC, 2A Switching Power Adapter

Frequency Band: 2.4000 ~ 2.4835 GHz

Data Rate: IEEE 802.11b (1/2/5.5/11Mbps)

IEEE 802.11g (6/9/12/24/36/48/54Mbps)

IEEE 802.11n (20 MHz) MCS 0-15, up to 144 Mbps

IEEE 802.11n (40 MHz) MCS 0-15, up to 300 Mbps

Net Dimension: 105 (L) x 105 (W) x 46 (H) mm

Gross Dimension: 212(L) x 132 (W) x 65 (H) mm

Net Weight : 143gms

Gross Weight : 450gms

Transmit Power: 11n (20 MHz) @ MCS 15: 23 +/- 1.5 dBm

11n (40 MHz) @ MCS 15: 23 +/- 1.5 dBm

11g @ 54 Mbps : 24 +/- 1.5 dBm

11b @ 11Mbps : 26 +/- 1.5 dBm

Operating Temperature: 0 ~ 40°C

Storage Temperature: -20 ~ 60°C

Operating Humidity: 10-90% (Non-Condensing)

Storage Humidity: Max. 95% (Non-Condensing)

## 4-2 Troubleshooting

If you find that the Access Point is not working properly or stops responding, don't panic. Before you contact your dealer of purchase for help, please read this troubleshooting section first. Some problems can be solved by you within very short time.

Scenario	Solution
Access Point is not responding when I want to access it by web browser	<ol style="list-style-type: none"> <li>a. Please check the connection of power cord and network cable of this Access Point. All cords and cables should be correctly and firmly inserted to the Access Point.</li> <li>b. If all LEDs on this access point are out, please check the status of A/C power adapter, and make sure it's correctly powered.</li> <li>c. You must use the same IP address subnet which Access Point uses.</li> <li>d. Are you using MAC or IP address filter? Try to connect the Access Point by another computer and see if it works; if not, please perform a hard reset (pressing 'reset' button).</li> <li>e. Set your computer to obtain an IP address automatically (DHCP), and see if your computer can get an IP address.</li> <li>f. If you did a firmware upgrade and this happens, contact your dealer of purchase for help.</li> <li>g. If all above solutions don't work, contact the dealer of purchase for help.</li> </ol>
Can't get connected to wireless Access Point	<ol style="list-style-type: none"> <li>a. If encryption is enabled, please re-check WEP or WPA passphrase settings on your wireless client.</li> <li>b. Try to move closer to the wireless Access Point.</li> <li>c. Unplug the Access Point from the power socket, and plug it again after 10 seconds. If the access point is powered through PoE, then unplug the ethernet cable from the access point and plug it again after 10 seconds.</li> </ol>

Access Point cannot be located by my wireless client	<ol style="list-style-type: none"> <li>a. 'Broadcast ESSID' set to off?</li> <li>b. Is Antenna properly installed and secured?</li> <li>c. Are you too far from your Access Point? Try to get closer.</li> <li>d. Please remember that you have to input ESSID on your wireless client manually, if ESSID broadcast is disabled.</li> </ol>
File download is very slow or breaks frequently	<ol style="list-style-type: none"> <li>a. Try to reset the Access Point and see if it's better after that.</li> <li>b. Try to know what other clients do on your local network. If some clients are transferring files of big size, other clients will get an impression that Internet is slow.</li> <li>c. Change channel number and see if this works.</li> </ol>
I can't log onto web management interface: password is wrong	<ol style="list-style-type: none"> <li>a. Make sure you're connecting to the correct IP address of the access point.</li> <li>b. Password is case-sensitive. Make sure the 'Caps Lock' light is not illuminated.</li> <li>c. If you really forget the password, do a hard reset.</li> </ol>
Access Point gets heated up	<ol style="list-style-type: none"> <li>a. This is not a malfunction as long as you are able to touch the Access Point's case.</li> <li>b. If you smell something wrong or see smoke coming out from the Access Point or the power adapter, please disconnect the Access Point and power adapter from utility power (make sure it's safe before doing this), and call your dealer of purchase for help.</li> </ol>

### **4-3 Glossary**

**DEFAULT GATEWAY (ACCESS POINT):** Every non-Access Point IP device needs to configure default gateway's IP address. When the device sends out an IP packet and if the destination is not on the same network, the device has to send the packet to its default gateway, which will then send it to the destination.

**DHCP:** Dynamic Host Configuration Protocol. This protocol automatically gives every computer on your home network an IP address.

**DNS SERVER IP ADDRESS:** DNS stands for Domain Name System, which allows Internet servers to have a domain name (such as [www.BroadbandAccessPoint.com](http://www.BroadbandAccessPoint.com)) and one or more IP addresses (such as 192.34.45.8). A DNS server keeps a database of Internet servers and their respective domain names and IP addresses, so that when a domain name is requested (as in typing "BroadbandAccessPoint.com" into your Internet browser), the user is directed to the proper IP address. The DNS server IP address used by the computers on your home network is the location of the DNS server your ISP has assigned to you.

**DSL MODEM:** DSL stands for Digital Subscriber Line. A DSL modem uses your existing phone lines to transmit data at high speeds.

**ETHERNET:** A standard for computer networks. Ethernet networks are connected by special cables and hubs, and move data around at up to 10/100 million bits per second (Mbps).

**IDLE TIMEOUT:** Idle Timeout is designed so that when there is no traffic on the Internet for a pre-configured amount of time, the connection will be disconnected automatically.

**IP ADDRESS AND NETWORK (SUBNET) MASK:** IP stands for Internet Protocol. An IP address consists of a series of four numbers separated by periods that identifies a single, unique Internet computer host in an IP network. Example: 192.168.2.1. It consists of 2 portions: the IP network address, and the host identifier.

The IP address is a 32-bit binary pattern, which can be represented as four cascaded decimal numbers separated by ".": `aaa.aaa.aaa.aaa`, where each "aaa" can be anything from 000 to 255, or as four cascaded binary numbers separated by ".":

bbbbbbbb.bbbbbbbb.bbbbbbbb.bbbbbbbb, where each “b” can either be 0 or 1.

A network mask is also a 32-bit binary pattern, and consists of consecutive leading 1’s followed by consecutive trailing 0’s, such as 11111111.11111111.11111111.00000000. Therefore sometimes a network mask can also be described simply as “x” number of leading 1’s. When both are represented side by side in their binary forms, all bits in the IP address that correspond to 1’s in the network mask become part of the IP network address, and the remaining bits correspond to the host ID.

For example, if the IP address for a device is, in its binary form,

11011001.10110000.10010000.00000111, and if its network mask is,

11111111.11111111.11110000.00000000

It means the device’s network address is

11011001.10110000.10010000.00000000, and its host ID is,

00000000.00000000.00000000.00000111. This is a convenient and efficient method for Access Points to route IP packets to their destination.

**ISP GATEWAY ADDRESS:** (see ISP for definition). The ISP Gateway Address is an IP address for the Internet Access Point located at the ISP's office.

**ISP:** Internet Service Provider. An ISP is a business that provides connectivity to the Internet for individuals and other businesses or organizations.

**LAN:** Local Area Network. A LAN is a group of computers and devices connected together in a relatively small area (such as a home or office). Your home network is considered a LAN.

**MAC ADDRESS:** MAC stands for Media Access Control. A MAC address is the hardware address of a device connected to a network. The MAC address is a unique identifier for a device with an Ethernet interface. It is comprised of two parts: 3 bytes of data that corresponds to the Manufacturer ID (unique for each manufacturer), plus 3 bytes that are often used as the product’s serial number.

**NAT:** Network Address Translation. This process allows all of the computers on your home network to use one IP address. Using the broadband Access Point’s NAT capability, you can access the Internet from any computer on your home network without having to purchase more IP addresses from your ISP.

**PORT:** Network Clients (LAN PC) uses port numbers to distinguish one network application/protocol over another. Below is a list of common applications and protocol/port numbers:

Application	Protocol	Port Number
Telnet	TCP	23
FTP	TCP	21
SMTP	TCP	25
POP3	TCP	110
H.323	TCP	1720
SNMP	UCP	161
SNMP Trap	UDP	162
HTTP	TCP	80
PPTP	TCP	1723
PC Anywhere	TCP	5631
PC Anywhere	UDP	5632

**PPPOE:** Point-to-Point Protocol over Ethernet. Point-to-Point Protocol is a secure data transmission method originally created for dial-up connections; PPPoE is for Ethernet connections. PPPoE relies on two widely accepted standards, Ethernet and the Point-to-Point Protocol. It is a communication protocol for transmitting information over Ethernet between different manufacturers

**PROTOCOL:** A protocol is a set of rules for interaction agreed upon between multiple parties so that when they interface with each other based on such a protocol, the interpretation of their behavior is well defined and can be made objectively, without confusion or misunderstanding.

**ACCESS POINT:** An Access Point is an intelligent network device that forwards packets between different networks based on network layer address information such as IP addresses.

**SUBNET MASK:** A subnet mask, which may be a part of the TCP/IP information provided by your ISP, is a set of four numbers (e.g. 255.255.255.0) configured like an IP address. It is used to create IP address numbers used only within a particular network (as opposed to valid IP address numbers recognized by the Internet, which must be assigned by InterNIC).

**TCP/IP, UDP:** Transmission Control Protocol/Internet Protocol (TCP/IP) and Unreliable Datagram Protocol (UDP). TCP/IP is the standard protocol for data transmission over the Internet. Both TCP and UDP are transport layer protocols. TCP performs proper error detection and error recovery, and thus is reliable. UDP on the other hand is not reliable. They both run on top of the IP (Internet Protocol), a network layer protocol.

**WAN:** Wide Area Network. A network that connects computers located in geographically separate areas (e.g. different buildings, cities, countries). The Internet is a wide area network.

**WEB-BASED MANAGEMENT GRAPHICAL USER INTERFACE (GUI):** Many devices support a graphical user interface that are based on the web browser. This means the user can use the familiar Netscape or Microsoft Internet Explorer to Control/configure or monitor the device being managed.

**POE:** Power-over-Ethernet: It is a means for delivering power to a remote device using the same cable lines used to deliver Ethernet data.

**This product comes with Life time warranty. For further details about warranty policy and Product Registration, please visit support section of [www.digisol.com](http://www.digisol.com)**

