

DIGISOL™



DG-BR4313NG

300Mbps Wireless Green 3G Broadband Router

User Manual

V1.0

2012-11-12

As our products undergo continuous development the specifications are subject to change without prior notice

COPYRIGHT

Copyright © 2012 by this company. All rights reserved. No part of this publication may be reproduced, transmitted, transcribed, stored in a retrieval system, or translated into any language or computer language, in any form or by any means, electronic, mechanical, magnetic, optical, chemical, manual or otherwise, without the prior written permission of this company

This company makes no representations or warranties, either expressed or implied, with respect to the contents hereof and specifically disclaims any warranties, merchantability or fitness for any particular purpose. Any software described in this manual is sold or licensed "as is". Should the programs prove defective following their purchase, the buyer (and not this company, its distributor, or its dealer) assumes the entire cost of all necessary servicing, repair, and any incidental or consequential damages resulting from any defect in the software. Further, this company reserves the right to revise this publication and to make changes from time to time in the contents thereof without obligation to notify any person of such revision or changes.

Trademarks:

DIGISOL™ is a trademark of Smartlink Network Systems Ltd. All other trademarks are the property of the respective manufacturers.

Safety

This equipment is designed with the utmost care for the safety of those who install and use it. However, special attention must be paid to the dangers of electric shock and static electricity when working with electrical equipment. All guidelines of this and of the computer manufacturer must therefore be allowed at all times to ensure the safe use of the equipment.

Federal Communication Commission Interference Statement

FCC Part 15

This equipment has been tested and found to comply with the limits for a class B digital device, pursuant to Part 15 of the FCC Rules. These limitations are designed to provide reasonable protection against harmful interference in a residential installation. This equipment generates, uses and can radiate radio frequency energy and, if not installed and used in accordance with the instructions, may cause harmful interference to radio communications. However, there is no guarantee that interference will not occur in a particular installation. If this equipment does cause harmful interference to radio or television reception, which can be determined by turning the equipment off and on, the user is encouraged to try to correct the interference by one or more of the following measures:

- Reorient or relocate the receiving antenna.
- Increase the separation between the equipment and receiver.
- Connect the equipment into a different outlet from that to which the receiver is connected.
- Consult your local distributors or an experienced radio/TV technician for help.
- Shielded interface cables must be used in order to comply with emission limits

Changes or modifications to the equipment, which are not approved by the party responsible for compliance could affect the user's authority to operate the equipment.

FCC Caution

This equipment must be installed and operated in accordance with provided instructions and a minimum 20 cm spacing must be provided between computer mounted antenna and person's body (excluding extremities of hands, wrist and feet) during wireless modes of operation.

This device complies with Part 15 of the FCC Rules. Operation is subject to the following two conditions: (1) this device may not cause harmful interference, and (2) this device must accept any interference received, including interference that may cause undesired operation.

Any changes or modifications not expressly approved by the party responsible for compliance could void the authority to operate equipment.

Federal Communication Commission (FCC) Radiation Exposure Statement

This equipment complies with FCC radiation exposure set forth for an uncontrolled environment. In order to avoid the possibility of exceeding the FCC radio frequency exposure limits, human proximity to the antenna shall not be less than 20cm (8 inches) during normal operation.

The antenna(s) used for this transmitter must not be co-located or operating in conjunction with any other antenna or transmitter.

The equipment version marketed in US is restricted to usage of the channels 1-11 only.

R&TTE Compliance Statement

This equipment complies with all the requirements of DIRECTIVE 1999/5/EC OF THE EUROPEAN PARLIAMENT AND THE COUNCIL of March 9, 1999 on Radio Equipment and Telecommunication Terminal Equipment and the mutual recognition of their conformity (R&TTE).

The R&TTE Directive repeals and replaces in the directive 98/13/EEC (Telecommunications Terminal Equipment and Satellite Earth Station Equipment) As of April 8, 2000.

Safety

This equipment is designed with the utmost care for the safety of those who install and use it. However, special attention must be paid to the dangers of electric shock and static electricity when working with electrical equipment. All guidelines of this and of the computer manufacture must therefore be allowed at all times to ensure the safe use of the equipment.

EU Countries Intended for Use

The ETSI version of this device is intended for home and office use in Austria, Belgium, Denmark, Finland, France, Germany, Greece, Ireland, Italy, Luxembourg, the Netherlands, Portugal, Spain, Sweden, and the United Kingdom.

The ETSI version of this device is also authorized for use in EFTA member states: Iceland, Liechtenstein, Norway, and Switzerland.

EU Countries Not intended for use: None.

INDEX

1. PRODUCT INFORMATION	9
1-1 INTRODUCTION AND SAFETY INFORMATION	9
1-2 SAFETY INFORMATION	10
1-3 SYSTEM REQUIREMENTS	11
1-4 PACKAGE CONTENTS	11
1-5 GET FAMILIAR WITH YOUR NEW WIRELESS 3G BROADBAND ROUTER	12
2. SYSTEM AND NETWORK SETUP	14
2-1 HARDWARE AND SOFTWARE INSTALLATION	14
2-2 CONNECTING TO WIRELESS BROADBAND ROUTER BY WEB BROWSER	24
2-2-1 Windows 95/98 IP address setup:	25
2-2-2 Windows 2000 IP address setup:	27
2-2-3 Windows XP IP address setup:	29
2-2-4 Windows Vista IP address setup	31
2-2-5 Connecting the router's management interface by web browser	33
2-3 USING QUICK SETUP	35
2-3-1 Setup procedure for '3G/3.5G':	39
2-3-2 Setup procedure for 'Cable Modem':	40
2-3-3 Setup procedure for 'Fixed-IP xDSL':	41
2-3-4 Setup procedure for 'PPPoE xDSL':	42
2-3-5 Setup procedure for 'PPTP xDSL':	44
2-3-6 Setup procedure for 'L2TP xDSL':	46
2-3-7 Procedure for Saving the Settings	48
2-4 GENERAL SETUP	49
2-4-1 Time zone and time auto-synchronization	50
2-4-2 Change management password	51
2-4-3 Remote Management	53
2-5 SETUP INTERNET CONNECTION (WAN SETUP)	55
2-5-1 Setup procedure for '3G/3.5G'	56
2-5-2 Setup procedure for 'Dynamic IP'	57
2-5-3 Setup procedure for 'Static IP':	59
2-5-4 Setup procedure for 'PPPoE':	60

2-5-5 Setup procedure for 'PPTP':	62
2-5-6 Setup procedure for 'L2TP':	64
2-5-7 Setup procedure for 'DNS':	66
2-5-8 Setup procedure for 'DDNS':	68
2-6 WIRED LAN CONFIGURATIONS	70
2-6-1 LAN IP section:	71
2-6-2 DHCP Server:	72
2-6-3 Static DHCP Lease Table:	73
2-7 WIRELESS LAN CONFIGURATIONS	75
2-7-1 Basic Wireless Settings	76
2-7-2 Advanced Wireless Settings	78
2-7-3 Wireless Security	80
2-7-3-1 Disable wireless security	80
2-7-3-2 WEP - Wired Equivalent Privacy	81
2-7-3-3 Wi-Fi Protected Access (WPA)	84
2-7-3-4 WPA RADIUS	85
2-7-4 Wireless Access Control	87
2-7-5 Wi-Fi Protected Setup (WPS)	89
2-7-6 Security Tips for Wireless Network	91
3. ADVANCED FUNCTIONS	92
3-1 QUALITY OF SERVICE (QoS)	92
3-1-1 Basic QoS Settings	92
3-1-2 Add a new QoS rule	94
3-2 NETWORK ADDRESS TRANSLATION (NAT)	97
3-2-1 Basic NAT Settings (Enable or disable NAT function)	97
3-2-2 Port Forwarding	98
3-2-3 Virtual Server	100
3-2-4 Port Mapping for Special Applications	102
3-2-5 UPnP Setting	104
3-2-6 ALG Settings	105
3-2-7 Static Routing	106
3-3 FIREWALL	108
3-3-1 Access Control	109
3-3-1-1 Add PC	112

3-3-2 URL Blocking	114
3-3-3 DoS Attack Prevention	116
3-3-3-1 DoS - Advanced Settings	118
3-3-4 Demilitarized Zone (DMZ)	120
3-4 FAILOVER	122
3-4 SYSTEM STATUS	125
3-4-1 System information and firmware version	125
3-4-2 Internet Connection Status	126
3-4-3 Device Status	127
3-4-4 System Log	128
3-4-5 Security Log	129
3-4-6 Active DHCP client list	130
3-4-7 Statistics	130
3-4-8 Modem Info	131
3-5 TOOLS	132
3-5-1 Configuration Backup and Restore	132
3-5-2 Firmware Upgrade	133
3-5-3 Reboot	134
4 APPENDIX	135
4-1 HARDWARE SPECIFICATION	135
4-2 TROUBLESHOOTING	136
4-3 GLOSSARY	139

1. Product Information

1-1 Introduction and Safety Information

Thank you for purchasing DG-BR4313NG 300Mbps 802.11n Wireless Green 3G Broadband Router! DG-BR4313NG is an energy-efficient router which helps to save more power by using an embedded power amplifier. DG-BR4313NG is a power efficient router which saves host power by off-loading CPU when WLAN is idle. The Smart Tx Power Control mechanism in DG-BR4313NG transmits optimum power depending upon the distance of wireless clients from the router. DG-BR4313NG is the best choice for Small office / Home office users, all computers and network devices can share a single xDSL / cable modem internet connection at high speed. Easy install procedures allow computer users to setup a network environment in very short time - within minutes, even inexperienced users. When the number of your computers and network-enabled devices grow, you can also expand the number of network slots by simply connecting a hub or switch, to extend the scope of your network.

All computers and IEEE 802.11b/g/n wireless-enabled network devices (*including PDA, cellular phone, game console, and more*) can connect to this wireless router without additional cabling. With a compatible wireless card installed in your PC, you can transfer files up to 300Mbps (transfer data rate).

Other features of this router include:

- High Internet Access throughput.
- Wireless speed up to 300Mbps.
- Allows multiple users to share a single Internet line.
- Shares a single Cable or xDSL internet connection.
- Share 3G USB Cellular modem.
- Access private LAN servers from the internet.
- Four wired LAN ports (10/100M) and one WAN port (10/100M).
- Works with IEEE 802.11b/g/n wireless LAN devices.
- Supports DHCP (Server/Client) for easy IP-address setup.

- Advanced network and security features like: Special Applications, QoS, DMZ, Virtual Servers, Access Control, Firewall.
- Allows you to monitor the router's status like: DHCP Client Log, System Log, Security Log and Device/Connection Status.
- Easy to use Web-based GUI for network configuration and management purposes.
- Remote management function allows configuration and upgrades from a remote computer (over the Internet).
- Provides Auto MDI / MDI-X function for all wired Ethernet ports.
- Supports **Green WLAN** for smart Tx power saving, **Implicit Rx power saving** and **CPU offload**.

1-2 Safety Information

In order to keep the safety of users and your properties, please follow the safety instructions as mentioned below:

1. This router is designed for indoor use only; **DO NOT** place this router outdoor.
2. **DO NOT** place this router close to a hot or humid area, like kitchen or bathroom. Also, do not leave this router in the car during summer.
3. **DO NOT** pull any connected cable with force; disconnect it from the router first.
4. If you want to place this Router at a height or mount on the wall, please make sure it is firmly secured. Falling from a height would damage the router and its accessories and warranty will be void.
5. Accessories of this router, like antenna and power supply, are dangerous to small children. **KEEP THIS ROUTER OUT OF REACH OF CHILDREN.**
6. The Router will get heated up when used for long time (This is normal and is not a malfunction). **DO NOT** put this Access Point on paper, cloth, or other flammable materials.

7. There's no user-serviceable part inside the router. If you find that the router is not working properly, please contact your dealer of purchase and ask for help. **DO NOT** disassemble the router, warranty will be void.
8. If the router falls into water when it's powered, **DO NOT** use your hands to pick it up. Switch the electrical power off before you do anything, or contact an experienced electrical technician for help.
9. If you smell something strange, or even see some smoke coming out from the router or power supply, remove the power supply or switch the electrical power off immediately, and call the dealer of purchase for help.

1-3 System Requirements

- Notebook or desktop computer with network adapter (wired/wireless)
- Internet connection, provided by xDSL or cable modem with a RJ-45 Ethernet port.
- Web browser (*Microsoft Internet Explorer 6.0 or above, Netscape Navigator 4.7 or above, Opera / Safari / Firefox / Google Chrome web browser*).
- An available AC power socket (100 – 240V, 50/60Hz)

1-4 Package Contents

Before you start using this router, please check if there's anything missing in the package, and contact your dealer of purchase to claim for missing items:

- DG-BR4313NG Wireless Broadband Router
- Switching power adapter (5V DC, 2A)
- USB cable (1 No.)
- Quick Installation Guide
- Installation Guide CD (includes User Manual, QIG & Utility)
- Patch chord (1 No.)

1-5 Get Familiar with your new wireless 3G broadband router

Front Panel

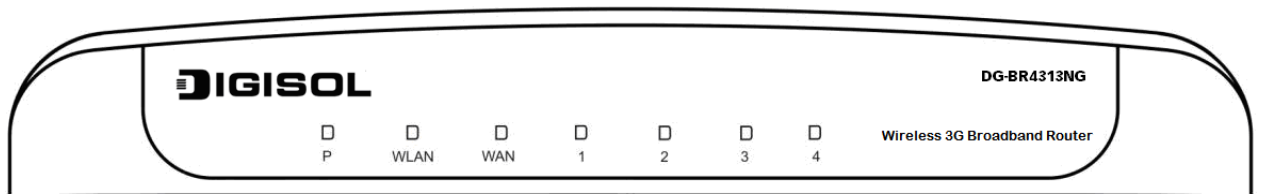

LED Name	LED Color	Light Status	Description
P (Power)	Green	On	Router is switched on and correctly powered.
WLAN	Amber	On	Wireless WPS function is enabled.
		Off	Wireless network is switched off.
		Flashing	Wireless LAN activity (transferring or receiving data).
WAN	Green	On	WAN port is connected.
		Off	WAN port is not connected.
		Flashing	WAN activity (transferring or receiving data).
LAN (1~4)	Green	On	LAN port is connected.
		Off	LAN port is not connected.
		Flashing	LAN activity (transferring or receiving data).

Back Panel

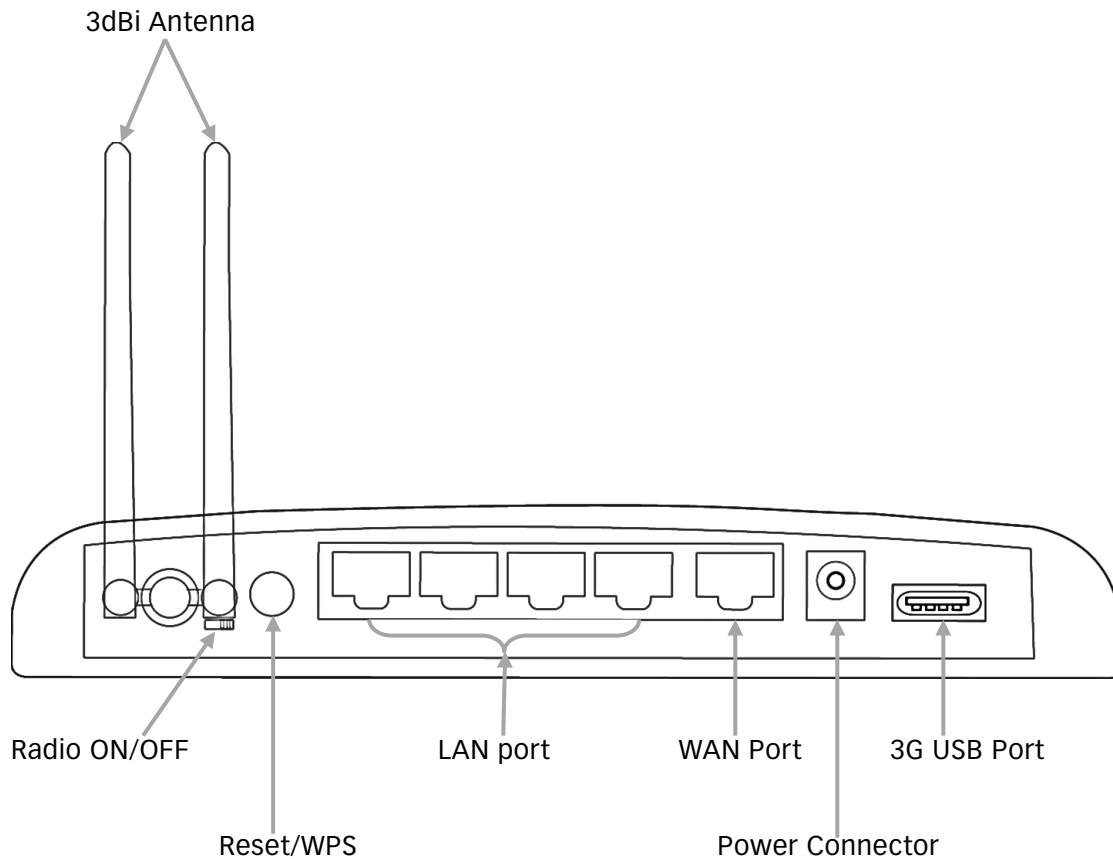

Interfaces	Description
Antennas	These antennas are 3dBi dipole antennas.
Radio ON/OFF	Switch the button to activate or deactivate the wireless functions.
Reset / WPS	Reset the router to factory default settings (clear all settings) or start WPS function. Press this button and hold for 10 seconds to restore all settings to factory defaults, and press this button for less than 5 seconds to start WPS function.
LAN (1 – 4)	Local Area Network (LAN) ports 1 to 4.
WAN	Wide Area Network (WAN / Internet) port.
Power	Power connector, connects to A/C power adapter.
USB Port	Connect 3G USB data card.

2. System and Network Setup

2-1 Hardware and Software Installation

Hardware Installation:-

Please follow the below mentioned instructions to build the network connection between your new WIRELESS router and your computers, network devices:

1. Connect your xDSL / cable modem to the WAN port of the router by an Ethernet cable.

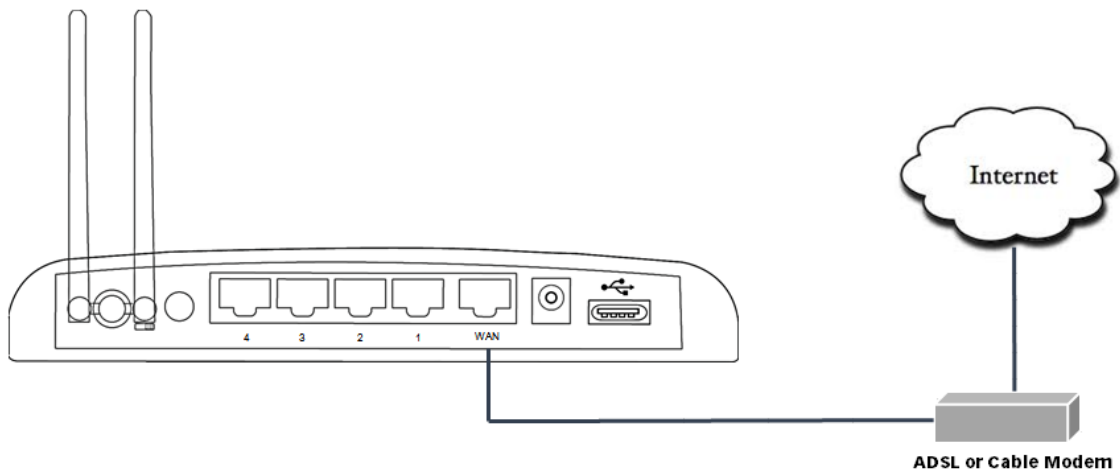

2. Connect all your computers, network devices (switch / hub) to the LAN port of the router.

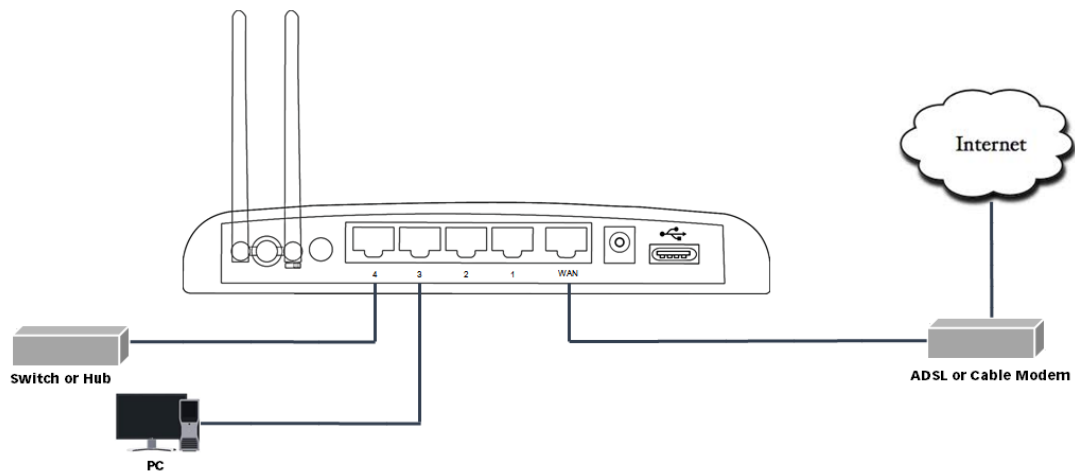

3. Connect the power adapter (5V DC / 2A) to the wall socket, and then connect it to the 'Power' socket of the router.

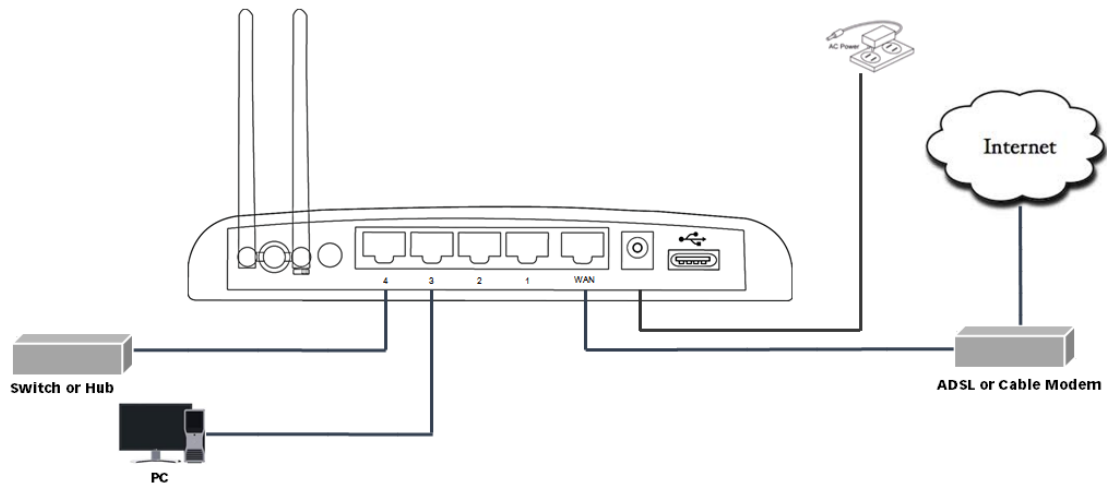

4. Please check all LEDs on the front panel. Power LED 'P' should be steadily ON, WAN and LAN LEDs should be ON. Check if the computer / network device connected to the respective port of the router is powered ON and correctly connected. If power LED 'P' is not ON, or any LED you expected is not ON, please recheck the cabling, or jump to ['4-2 Troubleshooting'](#) for possible reasons and solution.

Software Installation:-

- Insert the Setup CD into your CD-ROM drive of notebook/desktop computer.

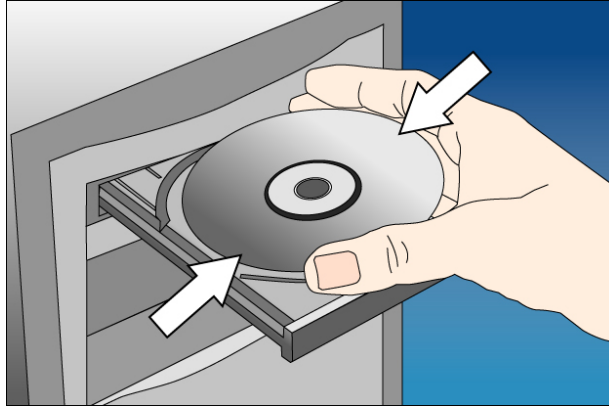

- Explore the CD and execute the “**RWizard.exe**” file. Below given screen will appear. Click '**Next**' to Continue.

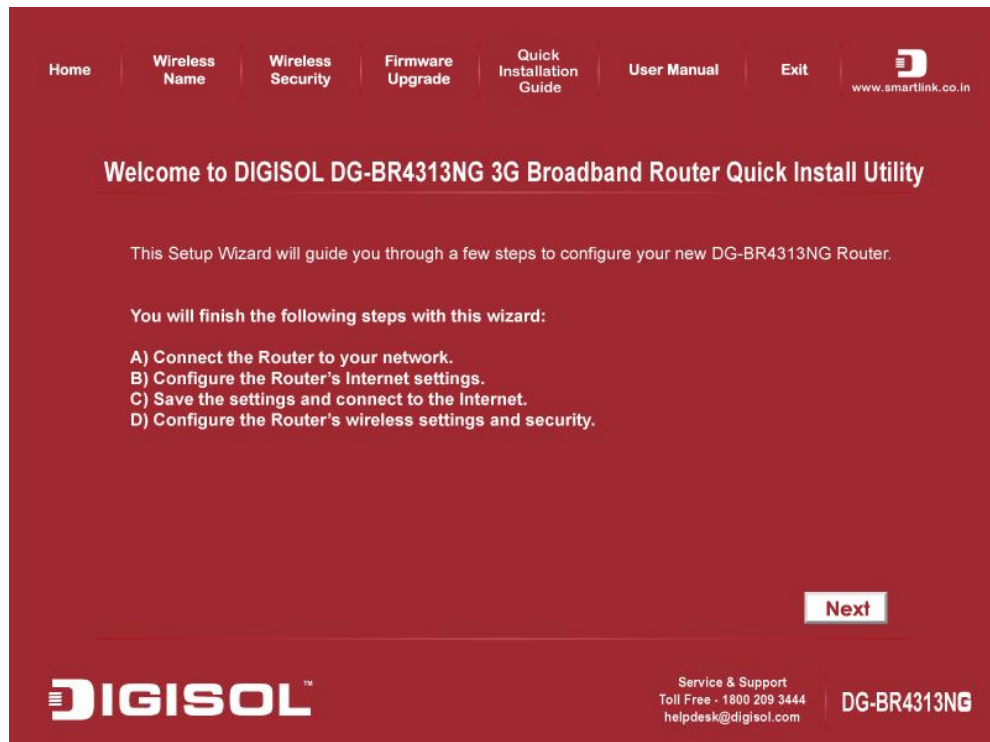

- Connect one end of a network cable to the WAN port of the router and the other end to the DSL/Cable modem. Click 'Next' to continue.

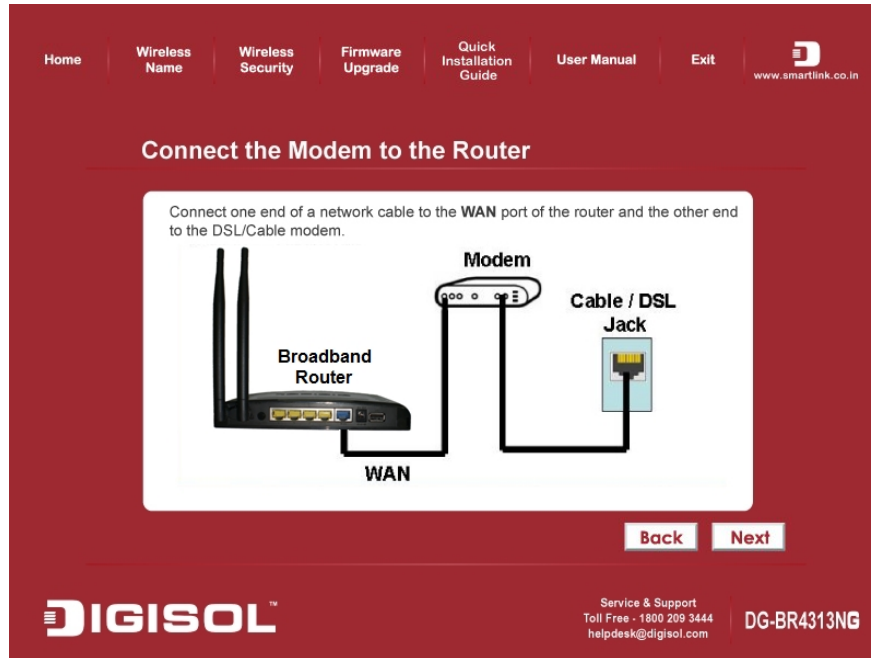

- Connect one end of the provided network cable to one of the LAN ports (1~4) of the router and the other end to your computer. Click 'Next' to continue with the installation.

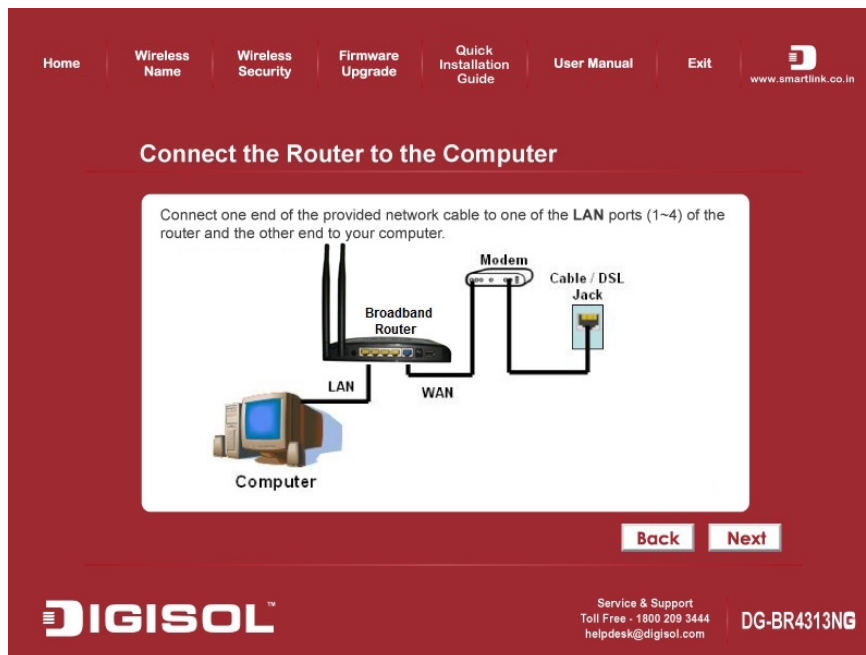

- Power on the Router. It will take approximately 55 seconds for the router to boot up completely. Ensure that all the LED's on the router are ON. If not, try the above steps again else click 'Next' to continue.

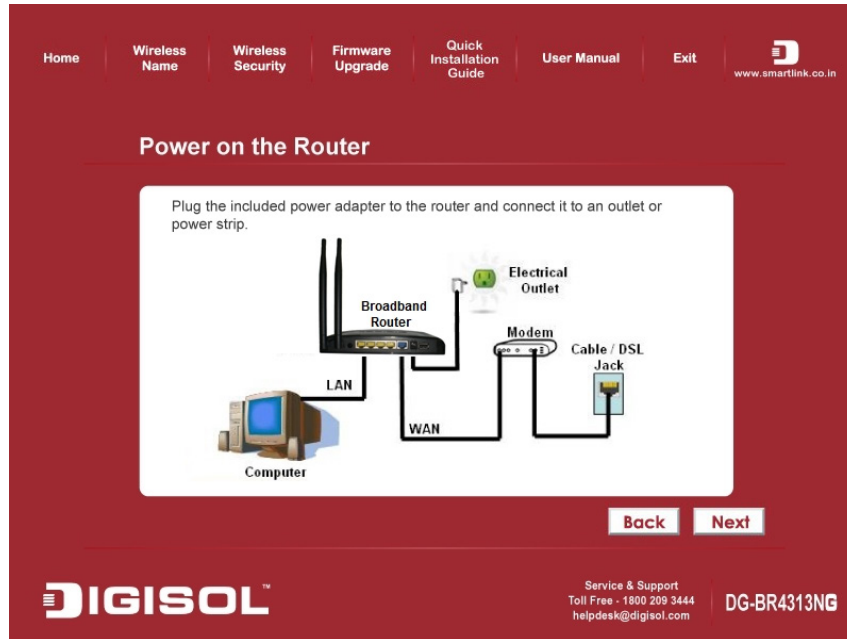

- Enter the Router's password to log in to the Router. The default password is "1234". It is recommended to change the router's password to protect it from being accessed by other users. If you do not wish to change the current password, you can leave "New Password" and "Confirm New Password" fields blank. Click 'Log in' to continue.

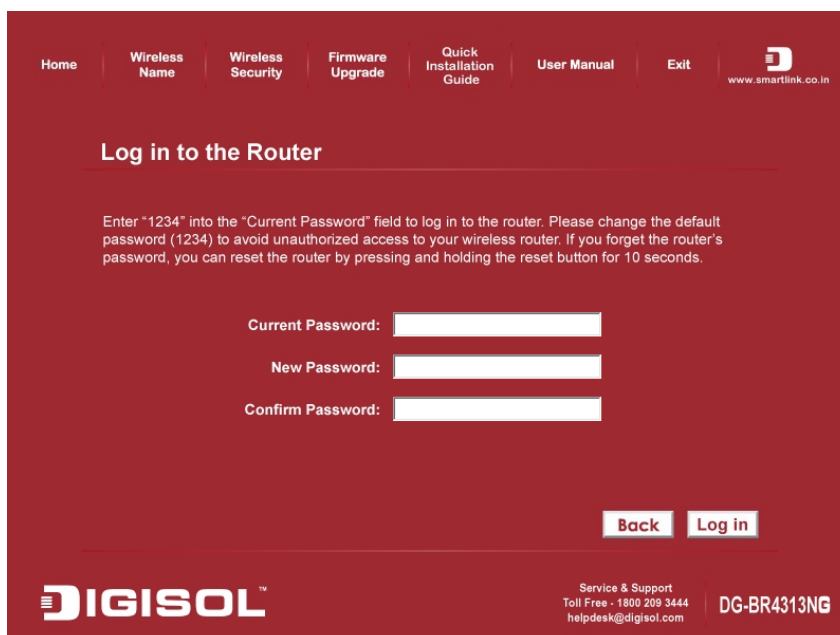

- Verify the Internet Connection Type the wizard has detected. If it is not correct, please configure it manually. Click ‘Next’ to continue.



Note: If you are not sure which Internet Connection Type you use, please contact your Internet Service Provider for this information.

Note: All the software utility installation steps mentioned above are the common steps to be followed for all the modes.

Below mentioned are the configuration steps for each of the modes.

- Enter the settings for your Internet Connection Type.

3G/3.5G

Select the Country and ISP from drop down list. Enter the APN, Username, Password and AT Dial Script, then click **'Next'** to continue.

Dynamic IP (Cable Modem users)

Click on **'Clone'** to clone the MAC address of your PC with the WAN port of the router, then click **'Next'** to continue.

PPPoE (DSL users)

Enter the user name and password provided by your ISP then click 'Next'.

Static IP

Enter the IP Address, Subnet Mask, Default Gateway and DNS address by your ISP, then click 'Next'.

Note: Once the parameters for each mode, as explained above are configured, following are the wireless configuration steps mentioned below.

- Please wait while the Wizard tries to connect to the Internet. If you see the window “Internet Connection Succeed”, your router has been successfully connected to the Internet. Please click ‘Next’ to configure the wireless settings.

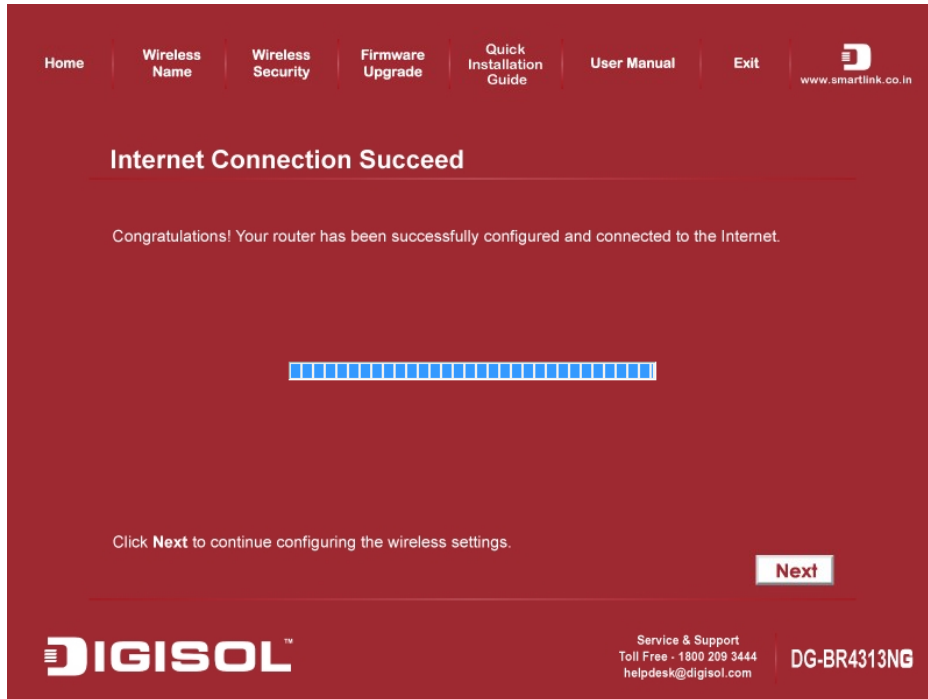

- Configure a name for your wireless network. Click ‘Next’ to continue.



- Configure the security key for your wireless network. Check ‘**Enable WPA Pre-Shared Key**’. Enter 8 to 63 characters into WPA-Pre-Shared Key. Click ‘**Next**’ to continue.

- Verify the settings you just configured for the Router. Click ‘**Finish**’ to restart the Router. This will take about 60 seconds.

Congratulations! Your router configuration is now finished.

2-2 Connecting to wireless broadband router by web browser

After the network connection is setup, next step is to setup the router with proper network parameters, so it can work properly in your network environment.

Please use the web browser to configure the router. A computer with wired Ethernet connection to the router is required for this first-time configuration.

Before you start to configure the router (default IP 192.168.2.1), please configure the IP address of the computer in the same network class as that of the router.

If the operating system of your computer is....

- Windows 95/98** - please go to [section 2-2-1](#)
- Windows 2000** - please go to [section 2-2-2](#)
- Windows XP** - please go to [section 2-2-3](#)
- Windows Vista** - please go to [section 2-2-4](#)

2-2-1 Windows 95/98 IP address setup:

1. Click 'Start' button (it should be located at lower-left corner of your computer), then click control panel. Double-click 'Network' icon, and Network window will appear. Select 'TCP/IP', then click 'Properties'.

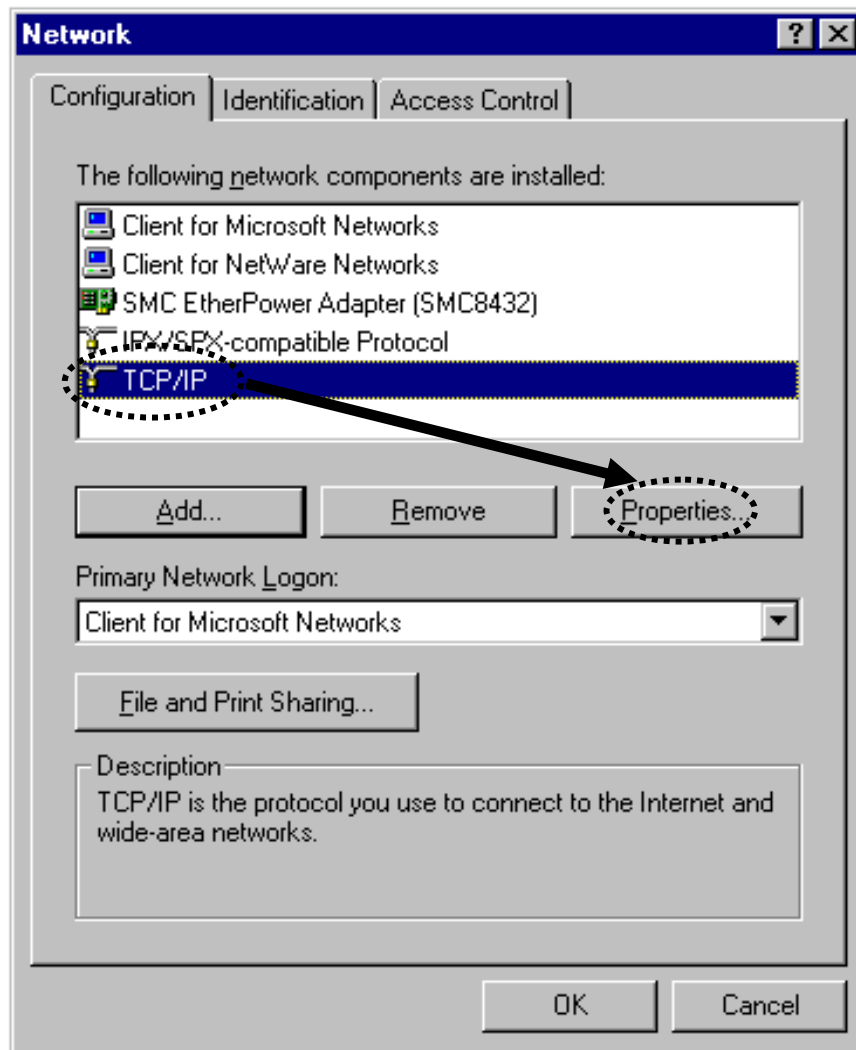

2. Select 'Specify an IP address', then input the following settings in respective field:

IP address: 192.168.2.2

Subnet Mask: 255.255.255.0

Gateway: 192.168.2.1

Click 'OK' when finish.

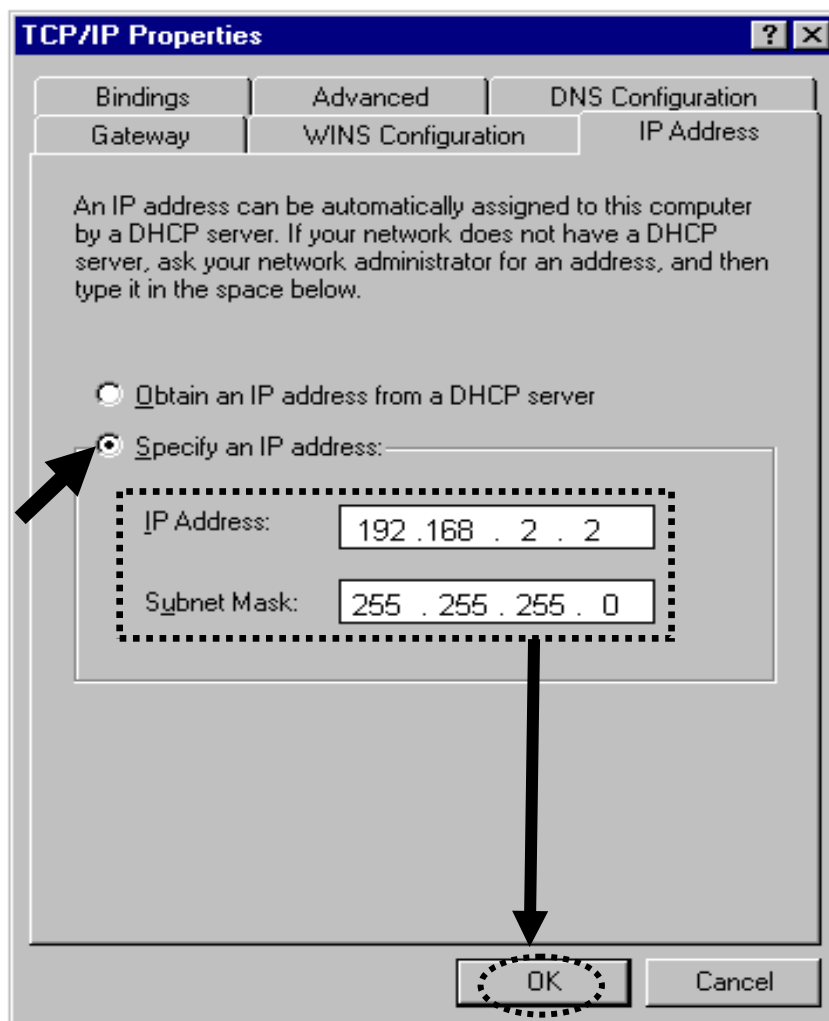

2-2-2 Windows 2000 IP address setup:

1. Click 'Start' button (it should be located at lower-left corner of your computer), then click control panel. Double-click 'Network and Dial-up Connections' icon, Right click on 'Local Area Connection' and select 'Properties', Local Area Connection Properties window will appear. Select 'Internet Protocol (TCP/IP)', then click 'Properties'

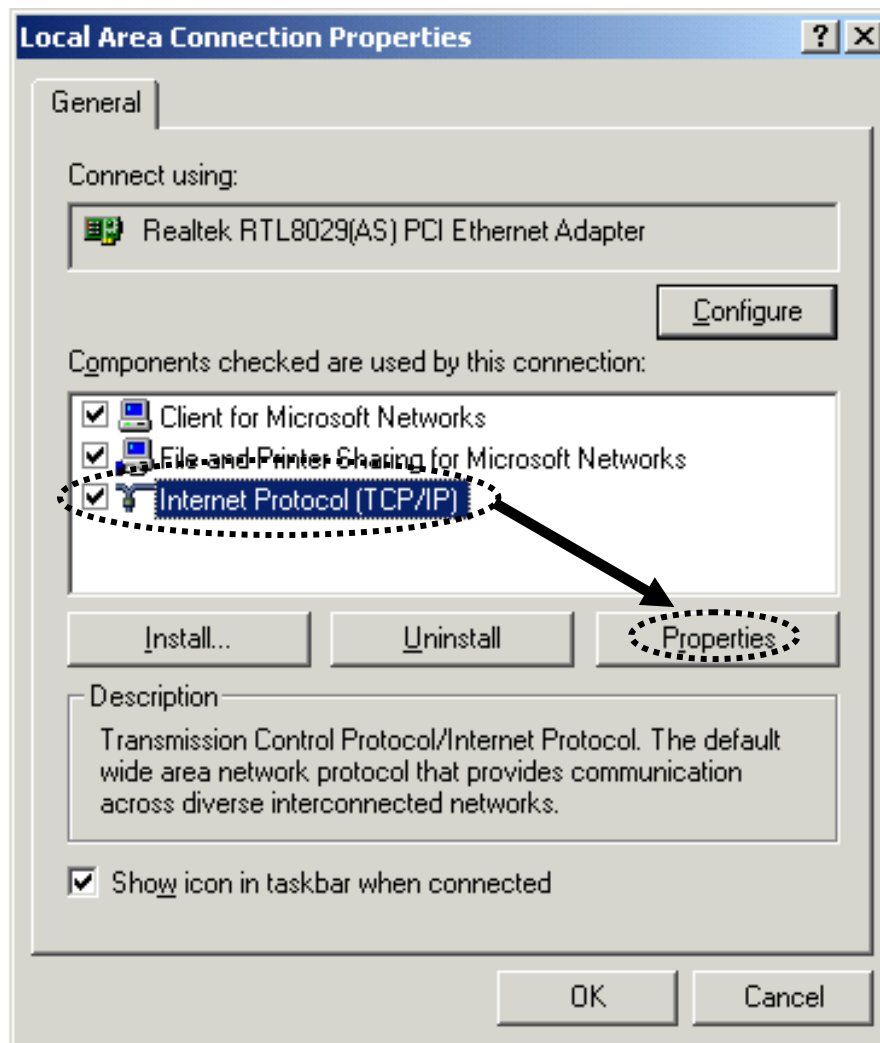

2. Select 'Use the following IP address', then input the following settings in the respective field:

IP address: 192.168.2.2

Subnet Mask: 255.255.255.0

Default gateway: 192.168.2.1

Click 'OK' when finish.

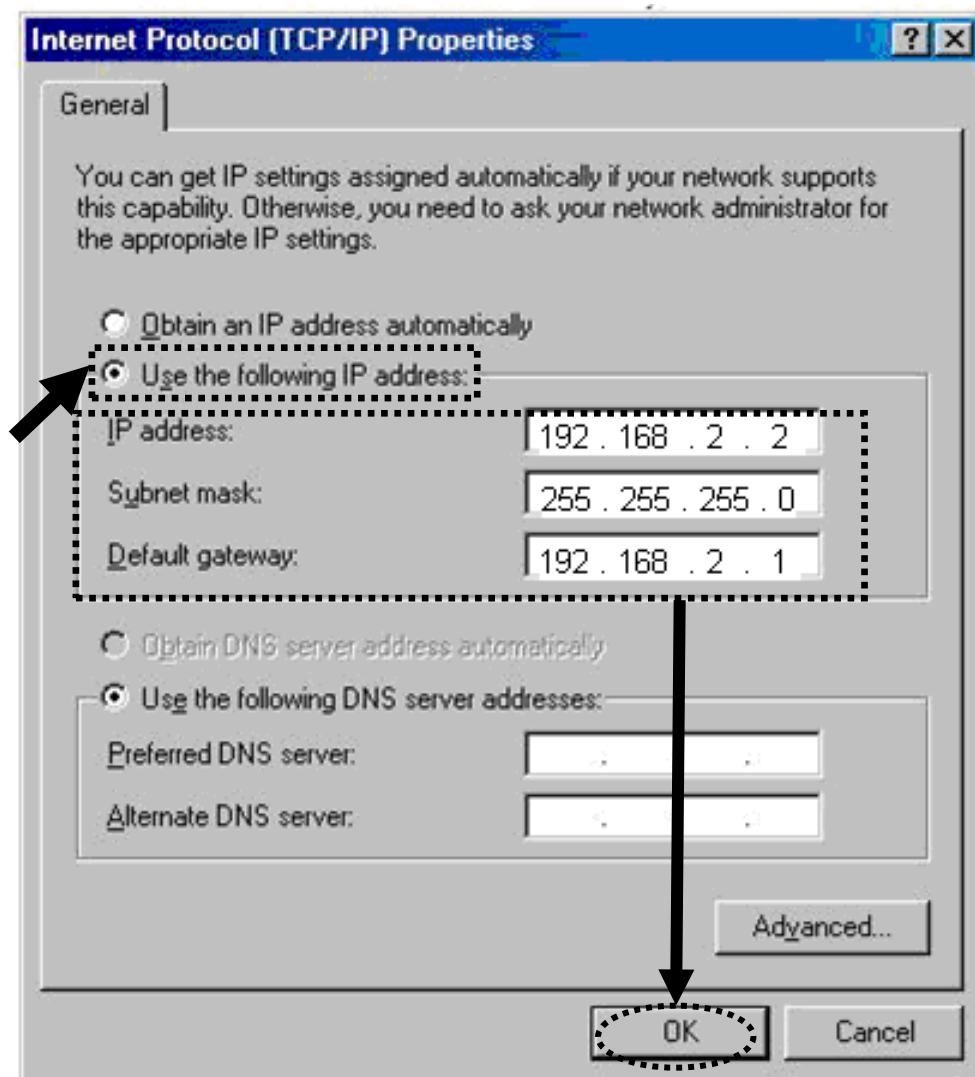

2-2-3 Windows XP IP address setup:

1. Click 'Start' button (it should be located at the lower-left corner of your computer), then click control panel. Click 'Network Connections', Right click on 'Local Area Connection' and select Properties, Local Area Connection Properties window will appear. Select 'Internet Protocol (TCP/IP)', and then click 'Properties'.

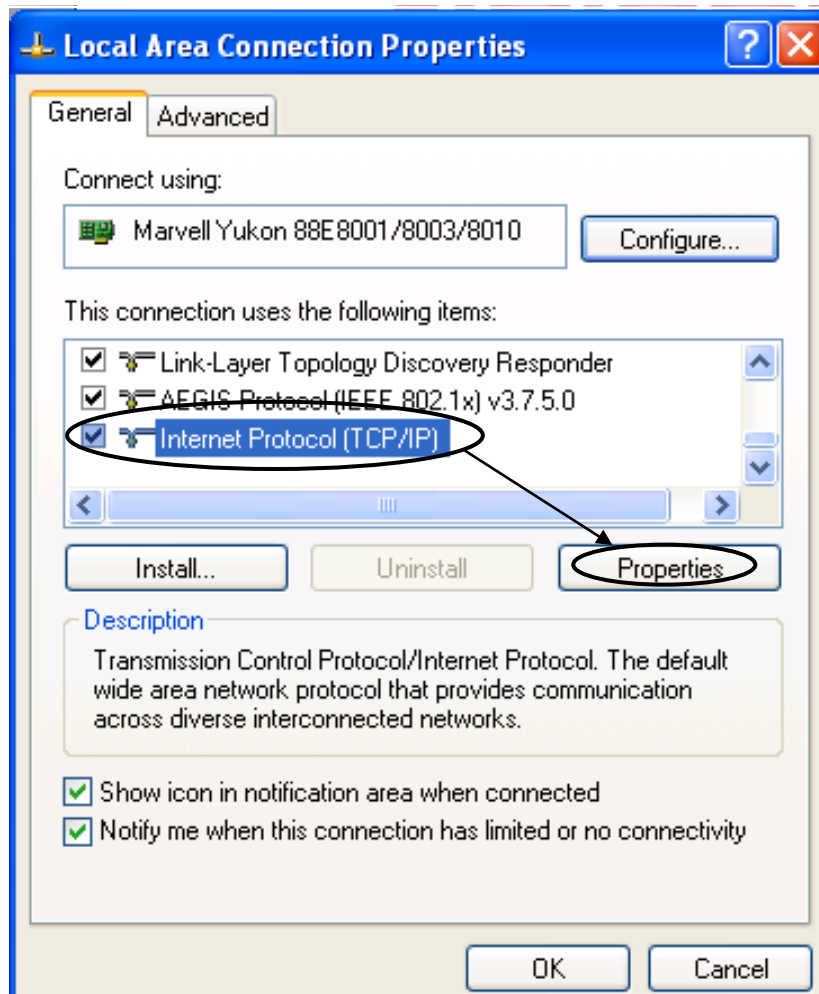

2. Select 'Use the following IP address', then input the following settings in the respective field:

IP address: 192.168.2.2

Subnet Mask: 255.255.255.0

Default gateway: 192.168.2.1

Click 'OK' when finish.

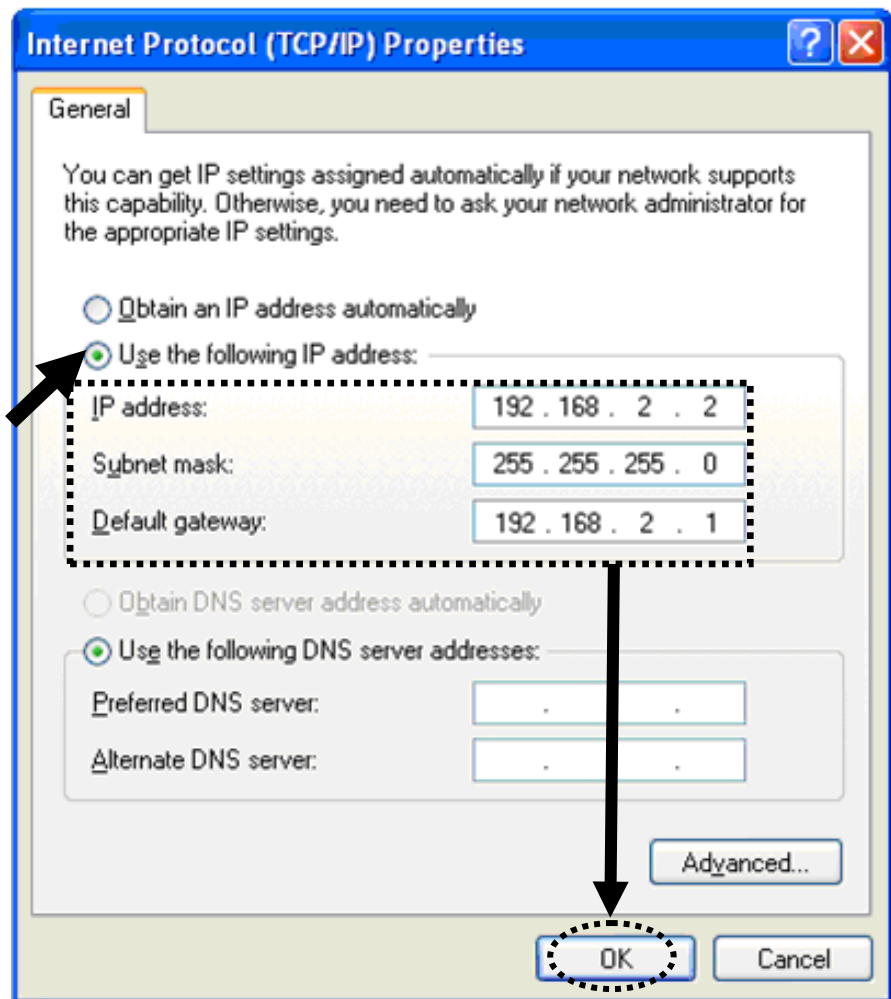

2-2-4 Windows Vista IP address setup

1. Click 'Start' button (it should be located at lower-left corner of your computer), then click control panel. Click on 'View Network Status and Tasks' and then click on 'Manage Network Connections'. Right-click 'Local Area Connection', then select 'Properties'. Local Area Connection Properties window will appear, select 'Internet Protocol Version 4 (TCP / IPv4)', and then click 'Properties'

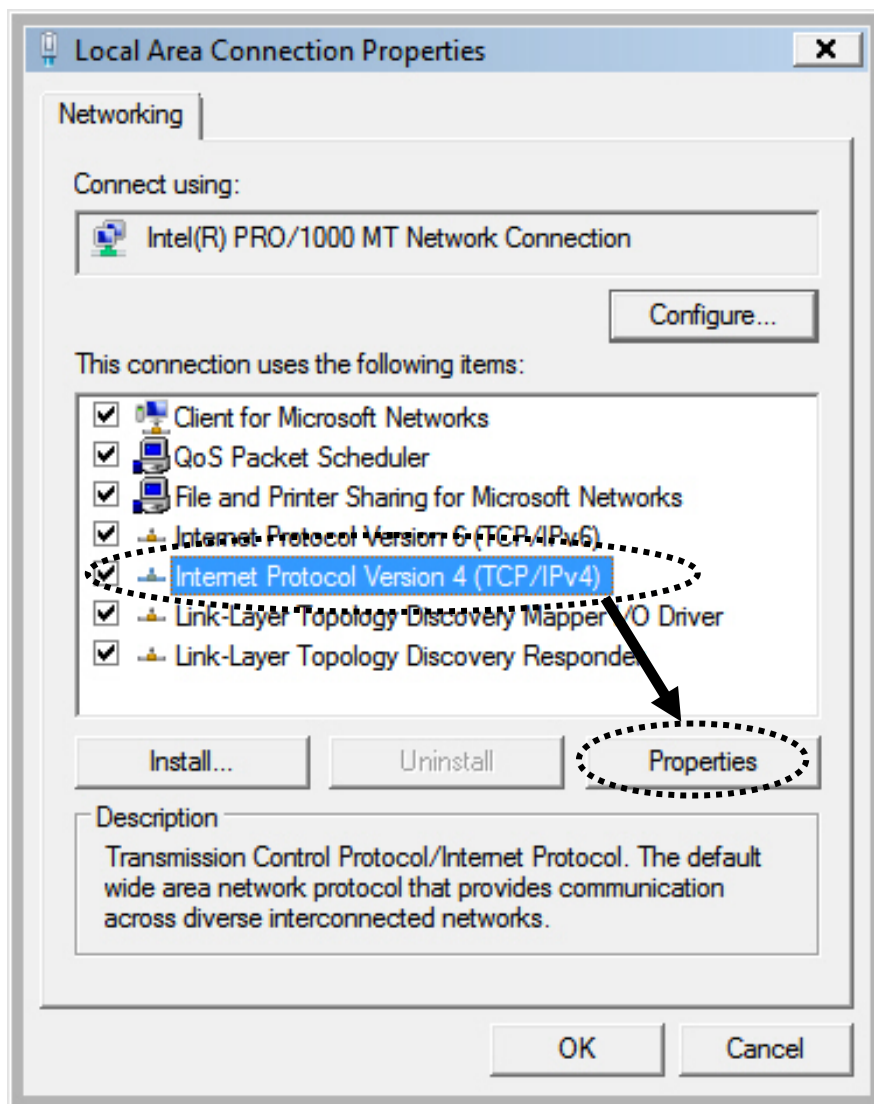

2. Select 'Use the following IP address', then input the following settings in the respective field:

IP address: 192.168.2.2

Subnet Mask: 255.255.255.0

Default gateway: 192.168.2.1

Click 'OK' when finish.

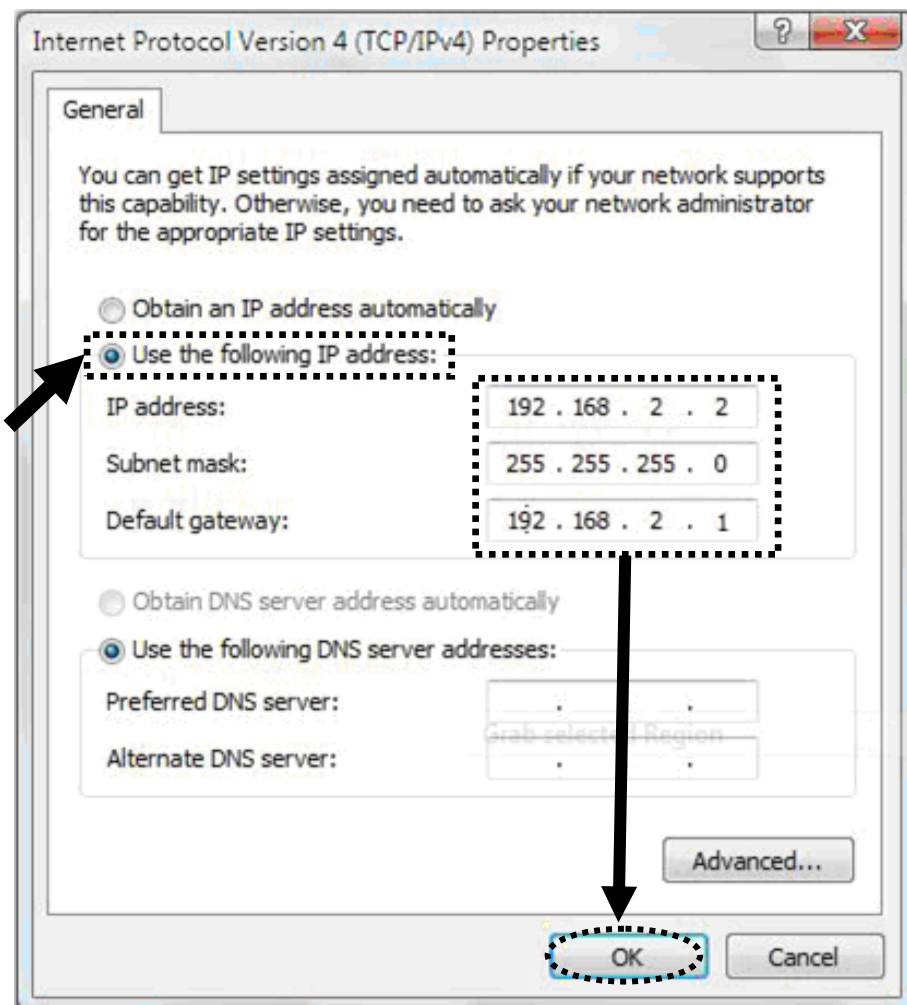

2-2-5 Connecting the router's management interface by web browser

After you assign an IP address to the computer, open the web browser, and type the IP address of the router in the address bar as 'http://192.168.2.1'.

The following message should be shown:



Please input user name and password in the field respectively, default user name is ‘**admin**’, and default password is ‘**1234**’, then press ‘OK’ button, and you can see the web management interface of this router:

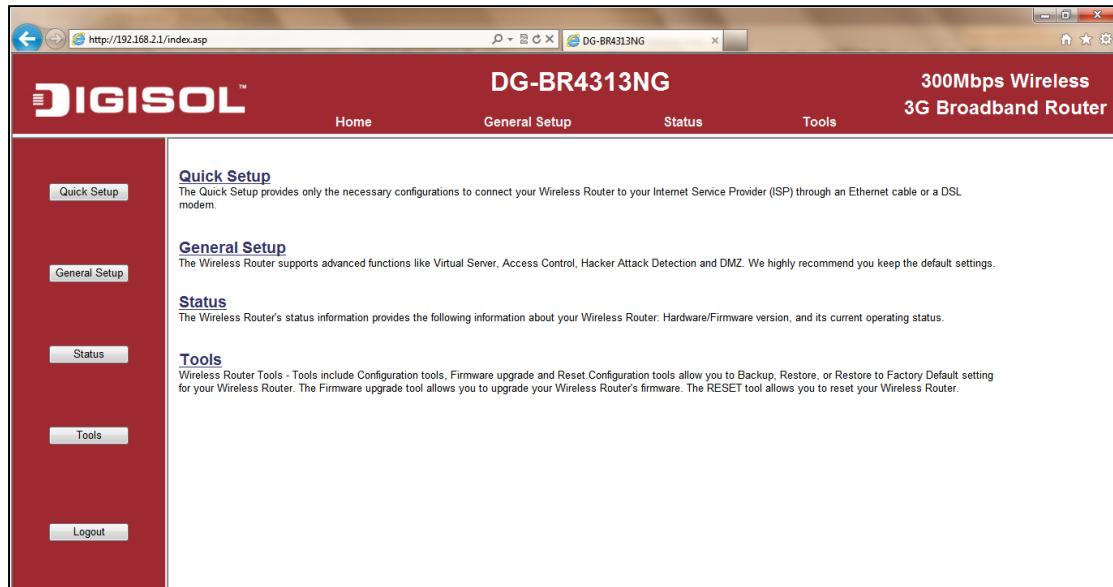

NOTE: If you can't see the web management interface, and you're being prompted to input user name and password again, it means you didn't input username and password correctly. Please retype user name and password again. If you're certain about the user name and password you typed please go to ['4-2 Troubleshooting'](#) to perform a factory reset, to set the password back to default value.

TIP: This page shows the four major setting categories: Quick Setup, General Setup, Status and Tools. You can find the shortcut which leads to these setting categories at the top of every page, and you can jump to another category directly by clicking the link, and don't have to go back to the first page.

2-3 Using Quick Setup

This router provides a ‘Quick Setup’ procedure, which will help you to complete all required settings you need to access the Internet in very short time. Please follow the instructions mentioned below to complete the ‘Quick Setup’:

Please go to Quick Setup menu by clicking ‘Quick Setup’ button.

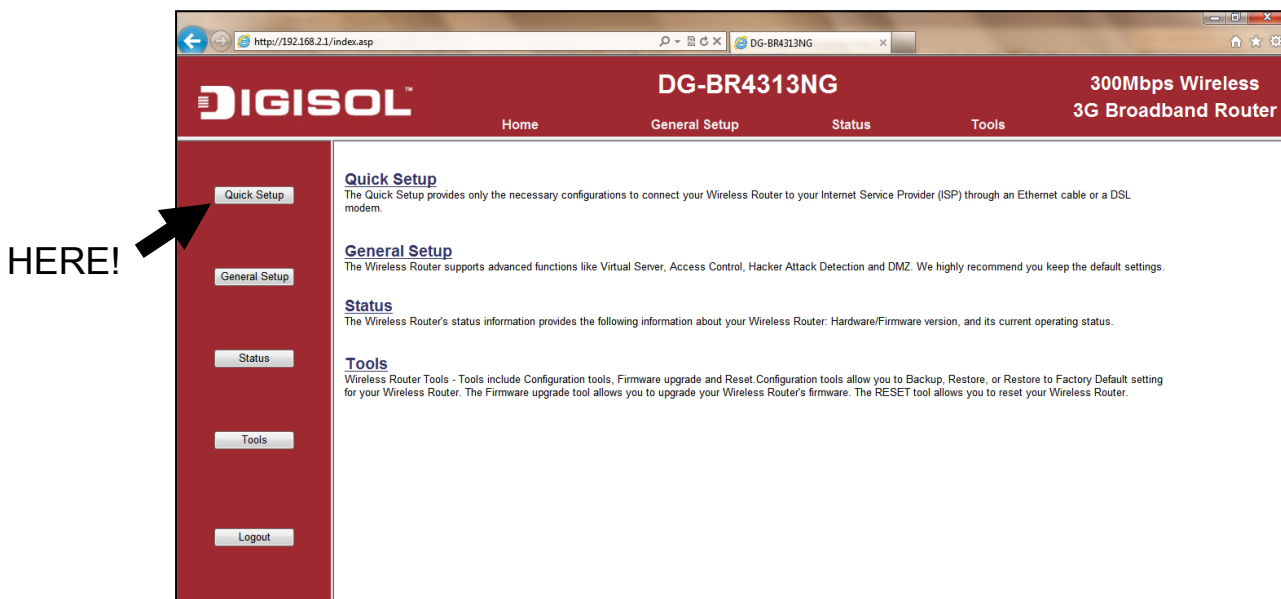

And the following message will be displayed:

Time Zone

Set the time zone of the Wireless Router. This information is used for log entries and firewall settings.

Time Zone :	(GMT+00:00)Greenwich Mean Time: Dublin, Edinburgh, Lisbon, London
Time Server Address :	192.43.244.18
Daylight Savings :	<input type="checkbox"/> Enable Time From January 1 To January 1

Here is the description of every setup item

Parameter	Description
Time Zone	Click the  button, drop-down menu will be shown, and you can choose a time zone of the location you live.
Time Server Address	Input the IP address of time server here.
Daylight Savings	If the country you live in uses daylight saving, please check 'Enable Function' box, and choose the duration of daylight saving.

NOTE: There are several time servers available on internet, few are listed below:

129.6.15.28 (time-a.nist.gov)

132.163.4.101 (time-a.timefreq.bldrdoc.gov)

131.107.1.10 (time-nw.nist.gov)

If you find that the time on the router is incorrect, try another time server.

After you finish with all the settings, please click ‘Next’ button.

Below given ‘WAN Type’ screen will appear.

[3G/3.5G](#)
If you connect to Internet using a 3G/3.5G handset or 3G/3.5G USB modem, then you should choose this option and enter the required information.

[Cable Modem](#)
A connection through a cable modem requires minimal configuration. When you set up an account with your Cable provider, the Cable provider and your Wireless Router will automatically establish a connection, so you probably do not need to enter anything more.

[Fixed-IP xDSL](#)
Some xDSL Internet Service Providers may assign a Fixed IP Address for your Wireless Router. If you have been provided with this information, choose this option and enter the assigned IP Address, Subnet Mask, Gateway IP Address and DNS IP Address for your Wireless Router.

[PPPoE xDSL](#)
If you connect to the Internet using an xDSL Modem and your ISP has provided you with a Password and a Service Name, then your ISP uses PPPoE to establish a connection. You must choose this option and enter the required information.

[PPTP xDSL](#)
If you connect to the Internet using an xDSL Modem and your ISP has provided you with a Password, Local IP Address, Remote IP Address and a Connection ID, then your ISP uses PPTP to establish a connection. You must choose this option and enter the required information.

[L2TP xDSL](#)
Layer Two Tunneling Protocol is a common connection method used in xDSL connections.

Please choose the broadband (Internet connection) type you’re using in this page. There are six types of Internet connection, they are:

- | | |
|----------------------|--|
| 3G/3.5G | - Please go to section 2-3-1 |
| Cable Modem | - Please go to section 2-3-2 |
| Fixed-IP xDSL | - Please go to section 2-3-3 |
| PPPoE xDSL | - Please go to section 2-3-4 |
| PPTP xDSL | - Please go to section 2-3-5 |
| L2TP xDSL | - Please go to section 2-3-6 |

If you're not sure, please contact your Internet service provider. A wrong Internet connection type will cause connection problem, and you will not be able to connect to the internet.

If you want to go back to previous step, please press 'Back' button at the bottom of this page.

NOTE: Some service providers use 'DHCP' (Dynamic Host Configuration Protocol) to assign IP address to your router. In this case, you can choose 'Cable Modem' as Internet connection type.

2-3-1 Setup procedure for '3G/3.5G':

Click on '3G/3.5G' on the 'WAN Type' screen. Below given screen will be displayed.

3G/3.5G
Enter the User Name, Password, APN, PIN Code and Dialed Number provided to you by your service provider in the appropriate fields.
• 3G/3.5G Settings :

Country :	India
ISP :	Other
PIN Code :	
APN :	www
User Name :	
Password :	
Verify Password :	
Service :	3G/3.5G Only (UMTS/HSPA/HSDPA)
AT Dial Script :	*99#

Here is the description of every setup item:

Parameter	Description
Country	Select the country from dropdown list.
ISP	Select the Service Provider from dropdown list.
PIN Code	Enter the pin code if required.
APN	Enter the APN for 3G connection.
Username	Enter Username for 3G connection.
Password	Enter the password for 3G connection.
Verify Password	Enter the password to verify.
Service	Select the service type whether 3G or CDMA.
AT Dial Script	Enter the dial script.

2-3-2 Setup procedure for 'Cable Modem':

Click on 'Cable Modem' on the 'WAN Type' screen. Below given screen will be displayed.

3. IP Address Info ?

Dynamic IP

Cable Modem

Host Name :

MAC Address :

Here is the description of every setup item:

Parameter	Description
Host Name	Please input the host name of your computer. This is optional, and is only required if your service provider asks you to do so.
MAC address	Please input MAC address of your computer here, if your service provider only permits computer with certain MAC address to access internet. If you're using the computer which is used to connect to Internet via cable modem, you can simply press 'Clone Mac' button to fill the MAC address field, with the MAC address of your computer.

After you finish with all settings, please click 'OK' button; if you want to go back to previous menu, click 'Back'.

2-3-3 Setup procedure for 'Fixed-IP xDSL':

Click on 'Fixed-IP xDSL' on the 'WAN Type' Screen. Below given screen will be displayed.

3. IP Address Info 

Static IP

Enter the IP Address, Subnet Mask, Gateway IP Address and DNS IP Address provided to you by your ISP in the appropriate fields

IP Address :	<input type="text" value="172.1.1.1"/>
Subnet Mask :	<input type="text" value="255.255.0.0"/>
DNS Address :	<input type="text"/>
Default Gateway :	<input type="text" value="172.1.1.254"/>

Here is the description of every setup item:

Parameter	Description
IP address	Please input the IP address assigned by your service provider.
Subnet Mask	Please input subnet mask assigned by your service provider
DNS address	Please input the IP address of DNS server provided by your service provider.
Default Gateway	Please input the default gateway assigned by your service provider.

NOTE: You must use the addresses provided by your Internet service provider, wrong setting value will cause connection problem.

NOTE: You can choose this Internet connection method if your service provider assigns a fixed IP address (also known as static address) to you, and not using DHCP or PPPoE protocol. Please contact your service provider for further information.

When you finish with all the settings, press 'OK'; if you want to go back to previous menu, click 'Back'.

2-3-4 Setup procedure for 'PPPoE xDSL':

Click on 'PPPoE' on the 'WAN Type' Screen. Below given screen will be displayed.

3. IP Address Info

PPPoE

Enter the User Name and Password required by your ISP in the appropriate fields. If your ISP has provided you with a "Service Name" enter it in the Service Name field, otherwise, leave it blank.

User Name :	<input type="text"/>
Password :	<input type="password"/>
Service Name :	<input type="text"/>
MTU :	<input type="text" value="1392"/> (512<=MTU<=1492)
Connection Type :	<input type="text" value="Continuous"/> <input type="button" value="Connect"/> <input type="button" value="Disconnect"/>
Idle Time Out :	<input type="text" value="10"/> (1-1000 Minute)

Here is the description of every setup item:

Parameter	Description
User Name	Please input the user name assigned by your Internet service provider here.
Password	Please input the password assigned by your Internet service provider here.
Service Name	Please give a name to this Internet service, this is optional.
MTU	Please input the MTU value of your network connection here. If you don't know, you can use default value.
Connection Type	Please select the connection type of Internet connection you wish to use (detailed explanation listed below).
Idle Time Out	Please input idle time out, (detailed explanation listed below).

When you finish with all settings, please click 'OK'; if you want to go back to previous menu, click 'Back'.

MTU – If you don't know the MTU Value, please use default value or ask your service provider for a proper value.

Connection Type - There are 3 options:

'Continuous' - Keep internet connection alive, do not disconnect.

'Connect on Demand' - Only connects to Internet when there's a connect attempt.

'Manual' - Only connects to Internet when 'Connect' button on this page is pressed, and disconnects when 'Disconnect' button is pressed.

Idle Time Out: Specify the time to shutdown internet connection after no internet activity is detected by specified minutes. This option is only available when connection type is 'Connect on Demand'.

2-3-5 Setup procedure for 'PPTP xDSL':

Click on 'PPTP' on the 'WAN Type' Screen. Below given screen will be displayed.

3. IP Address Info

PPTP

Point-to-Point Tunneling Protocol is a common connection method used in xDSL connections.

- WAN Interface Settings**
 - Obtain an IP Address Automatically

Host Name :	<input type="text"/>
MAC Address :	<input type="text" value="000000000000"/> <input type="button" value="Clone MAC"/>
 - Use The Following IP Address

IP Address :	<input type="text" value="0.0.0.0"/>
Subnet Mask :	<input type="text" value="0.0.0.0"/>
Default Gateway :	<input type="text" value="0.0.0.0"/>
- PPTP Settings**

User Name :	<input type="text"/>
Password :	<input type="password"/>
PPTP Gateway :	<input type="text" value="0.0.0.0"/>
Connection ID :	<input type="text"/> (Optional)
MTU :	<input type="text" value="1392"/> (512<=MTU<=1492)
BEZEQ-ISRAEL :	<input type="checkbox"/> Enable (For BEZEQ network in ISRAEL use only)
Connection Type :	<input type="text" value="Continuous"/> <input type="button" value="Connect"/> <input type="button" value="Disconnect"/>
Idle Time Out :	<input type="text" value="10"/> (1-1000 Minute)

PPTP xDSL requires two kinds of settings: WAN interface setting (setup IP address) and PPTP setting (PPTP user name and password).

Here we start from WAN interface setting:

Here you select the type of how to obtain the IP address from your service provider. You can choose 'Obtain an IP address automatically' (i.e. DHCP, please refer to 'Cable Modem' [Section 2-3-2](#)), or 'Use the following IP address' (i.e. static IP address, please refer to [Section 2-3-3](#)).

WAN interface settings must be correctly set, or the Internet connection will fail, even though settings of PPTP settings are correct. Please contact your Internet service provider if you don't know what you should fill in these fields.

Now please go to PPTP settings section:

Parameter	Description
User Name	Please input user ID (user name) assigned by your Internet service provider here.
Password	Please input the password assigned by your Internet service provider here.
PPTP Gateway	Please input the IP address assigned by your Internet service provider here
Connection ID	Please input the connection ID here, this is optional and you can leave it blank.
MTU	Please input the MTU value of your network connection here. If you don't know, you can use default value.
BEZEQ-ISRAEL	Setting item 'BEZEQ-ISRAEL' is only required to Enable if you're using the service provided by BEZEQ network in Israel.
Connection type	Please select the connection type of Internet connection you wish to use. Refer to Note given in Section 2-3-4 Setup procedure for 'PPPoE xDSL' for detailed descriptions.
Idle Time Out	Please input the idle time out of Internet connection you wish to use. Refer to Note given in Section 2-3-4 Setup procedure for 'PPPoE xDSL' for detailed descriptions.

When you finish with all settings, please click 'OK'; if you want to go back to previous menu, click 'Back'.

2-3-6 Setup procedure for 'L2TP xDSL':

L2TP is another popular connection method for xDSL and other Internet connection types, like PPTP, two kinds of settings are required, we'll start from 'WAN Interface Settings':

3. IP Address Info

L2TP

Layer Two Tunneling Protocol is a common connection method used in xDSL connections.

- WAN Interface Settings**
 - Obtain an IP Address Automatically

Host Name :	<input type="text"/>
MAC Address :	<input type="text" value="000000000000"/> <input type="button" value="Clone MAC"/>
 - Use The Following IP Address

IP Address :	<input type="text" value="0.0.0.0"/>
Subnet Mask :	<input type="text" value="0.0.0.0"/>
Default Gateway :	<input type="text" value="0.0.0.0"/>
- L2TP Settings**

User Name :	<input type="text"/>
Password :	<input type="text"/>
L2TP Gateway :	<input type="text"/>
MTU :	<input type="text" value="1392"/> (512<=MTU<=1492)
Connection Type :	<input type="text" value="Continuous"/> <input type="button" value="Connect"/> <input type="button" value="Disconnect"/>
Idle Time Out :	<input type="text" value="10"/> (1-1000 Minute)

Please select the type of how you obtain IP address from your service provider here. You can choose 'Obtain an IP address automatically' (i.e. DHCP, please refer to 'Cable Modem' [Section 2-3-2](#)), or 'Use the following IP address' (i.e. Static IP address, please refer to [Section 2-3-3](#)).

WAN interface settings must be correctly set, or the Internet connection will fail, even though L2TP settings are correct. Please contact your Internet service provider if you don't know what you should fill in these fields.

Now please go to L2TP settings section:

Here is the description of every setup item:

Parameter	Description
User Name	Please input user ID (user name) assigned by your Internet service provider here.
Password	Please input the password assigned by your Internet service provider here.
L2TP Gateway	Please input the IP address of L2TP gateway assigned by your Internet service provider here.
MTU	Please input the MTU value of your network connection here. If you don't know, you can use default value.
Connection type	Please select the connection type of Internet connection you wish to use. Refer to Note given in Section 2-3-4 Setup procedure for 'PPPoE xDSL' for detailed descriptions.
Idle Time Out	Please input the idle time out of Internet connection you wish to use. Refer to Note given in Section 2-3-4 Setup procedure for 'PPPoE xDSL' for detailed descriptions.

When you finish with all settings, please click 'OK'; if you want to go back to previous menu, click 'Back'.

2-3-7 Procedure for Saving the Settings

After completion of all the settings you need to save it.

Click 'OK' and the following message will be displayed on your web browser:

Save settings successfully!

Please press APPLY button to restart the system to make the changes take effect.

Click 'Apply' button to restart the router, and you'll see this message:

Wait for about 55 seconds, then click 'OK' button. You'll be back to router management interface again, and the router is ready with new settings.

System Restarting! Please wait for a while !

2-4 General Setup

In this chapter, you'll know how to change the time zone, password and remote management settings. Please start your web browser and log onto router web management interface, then click 'General Setup' button on the left, or click 'General Setup' link at the upper-right corner of web management interface.

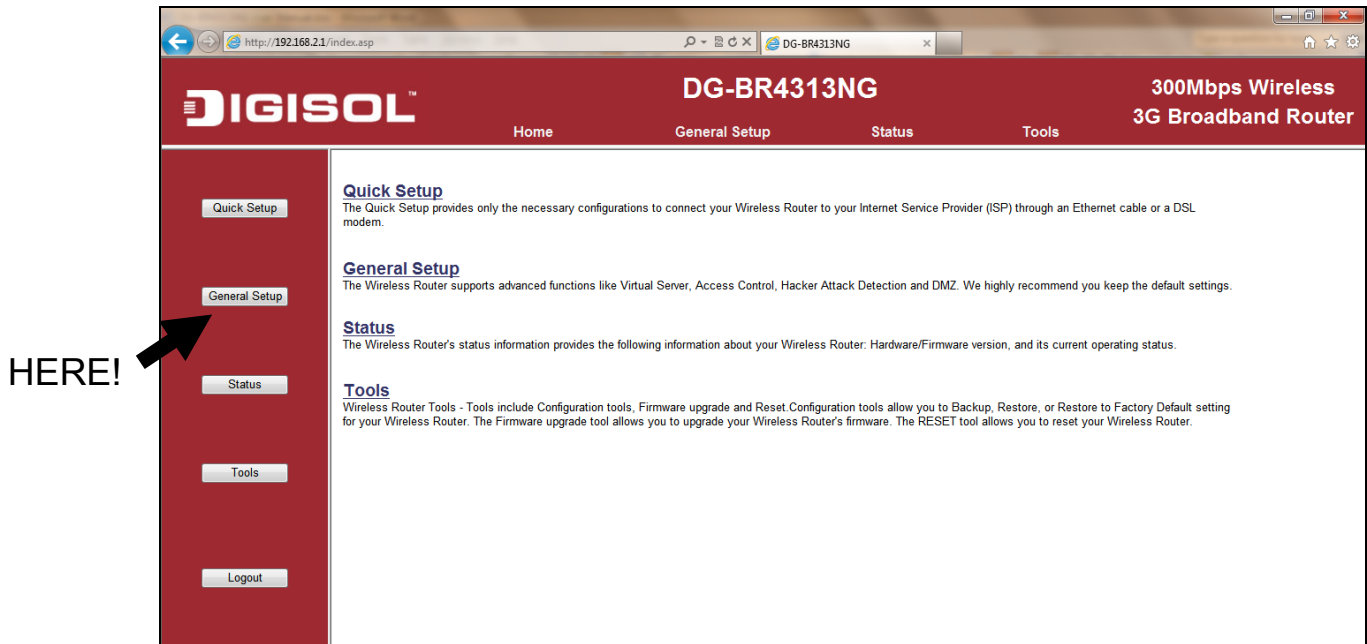

2-4-1 Time zone and time auto-synchronization

Please follow the instructions mentioned below to set time zone and time auto-synchronization parameters.

Please click ‘System’ menu on the left of web management interface, then click ‘Time Zone’, and the following screen will be displayed on your web browser. For setting of the Time Zone, Time Server Address and Daylight Savings parameters in this screen, please refer [section ‘2-3 Using Quick Setup’](#)

When you finish, click ‘Apply’. You’ll see the following message displayed on web browser:

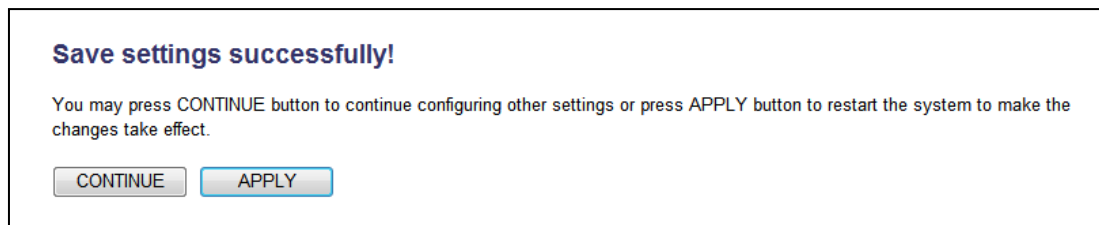

Press ‘Continue’ to save the settings made and go back to web management interface; press ‘Apply’ to save the settings made and restart the router so the settings will take effect after it reboots.

2-4-2 Change management password

Default password of this router is 1234, and it's displayed on the login prompt when accessed from web browser. There's a security risk if you don't change the default password, since everyone can see it. This is very important when you have wireless function enabled.

To change password, please follow the instructions mentioned below:

Please click '**System**' menu on the left of web management interface, then click '**Password Settings**', and the following screen will be displayed on your web browser

Password Settings ?

You can change the password required while logging into the wireless router's web-based management system. By default, the password is 1234. So please assign a password to the Administrator as soon as possible, and store it in a safe place. Passwords can contain 1 to 30 alphanumeric characters, and are case sensitive.

Current Password :	<input type="text"/>	<input type="text"/>
New Password :	<input type="text"/>	<input type="text"/>
Confirm Password :	<input type="text"/>	<input type="text"/>

Here is the description of every setup item:

Parameter	Description
Current Password	Please input current password here.
New Password	Please input new password here.
Confirm Password	Please input new password here again.

When you finish, click 'Apply'. If you want to keep original password unchanged, click 'Cancel'.

If the password you typed in 'New Password' and 'Confirm Password' fields do not match, you'll see the following message.



Please retype the new password again and click 'Apply'.

If the current and new passwords are correctly entered, after you click 'Apply', you'll be prompted to input your new password:

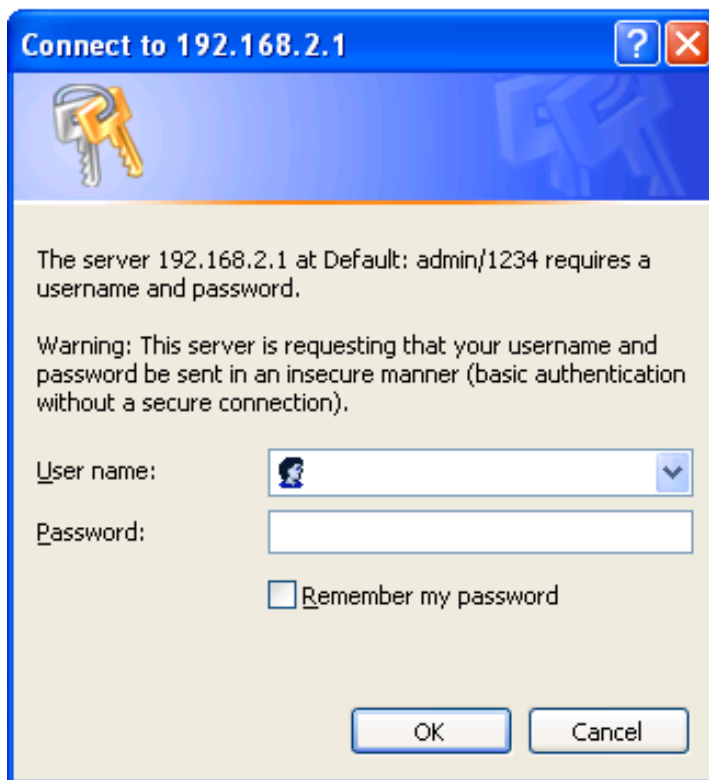

Please input user name as 'admin' and new password to enter web management interface again, and you should be able to login with new password.

2-4-3 Remote Management

This router does not allow management access from Internet, to prevent possible security risks (especially when you define a weak password or did not change default password). However, you can still manage this router from a specific IP address by enabling the 'Remote Management' function.

To do so, please follow the instructions mentioned below:

Please click 'System' menu on the left of web management interface, then click 'Remote Management', and the following screen will be displayed on your web browser:

Remote Management 

The remote management function allows you to designate a host in the Internet to have management/configuration access to the Wireless Router from a remote site. Enter the designated host IP Address in the Host IP Address field.

Host Address	Port	Enable
<input type="text" value="0.0.0.0"/>	<input type="text" value="8080"/>	<input type="checkbox"/>

Here is the description of every setup item:

Parameter	Description
Host Address	Input the IP address of the remote host you wish to initiate a management access.
Port	You can define the port number through which this router should expect an incoming request. If you're providing a web service (default port number is 80), you should try to use other port number. You can use the default port setting '8080' or something like '32245' or '1429'. (Any integer between 1 and 65535)
Enabled	Select this field to start the configuration.

When you finish, click 'Apply'. You'll see the following message displayed on web browser

Save settings successfully!

You may press CONTINUE button to continue configuring other settings or press APPLY button to restart the system to make the changes take effect.

Press 'Continue' to save the settings made and go back to web management interface; press 'Apply' to save the settings made and restart the router, so the settings will take effect after it reboots.

NOTE: When you want to manage this router from another computer on internet, you have to input the IP address and port number of this router in the address bar of the web browser manually. If your Internet service provider assigns you with a static IP address, it will not be a problem; but if the IP address your service provider assigns to you will vary every time you establish an internet connection, this will be a problem.

Please either ask your service provider to give you a static IP address, or use dynamic IP to host name mapping services like DDNS. Please refer to [chapter 2-5-8 'DDNS client'](#) for details.

NOTE: The default port number that the web browser will use is '80'. If the 'Port' setting in this page is not '80', you have to assign the port number in the address bar of web browser manually. For example, if the IP address of this router is 1.2.3.4, and the port number you set is 8888, you have to input following address in the address bar of web browser:

http://1.2.3.4:8888

2-5 Setup Internet Connection (WAN Setup)

Internet connections setup can be done by using ‘Quick Setup’ menu described in [chapter 2-3](#). However, you can setup WAN connections by using WAN configuration menu. You can also set advanced functions like DDNS (Dynamic DNS) here.

To start configuration, please follow the instructions mentioned below.

Click ‘General Setup’ menu on the left of web management interface, then click ‘WAN’ menu, and the following message will be displayed on your web browser:

Please select an Internet connection method depending on the type of connection you’re using. You can either click the connection method on the left or right of the web management interface. If you select the connection method on the right, please click ‘More Configuration’ tab after a method is selected.

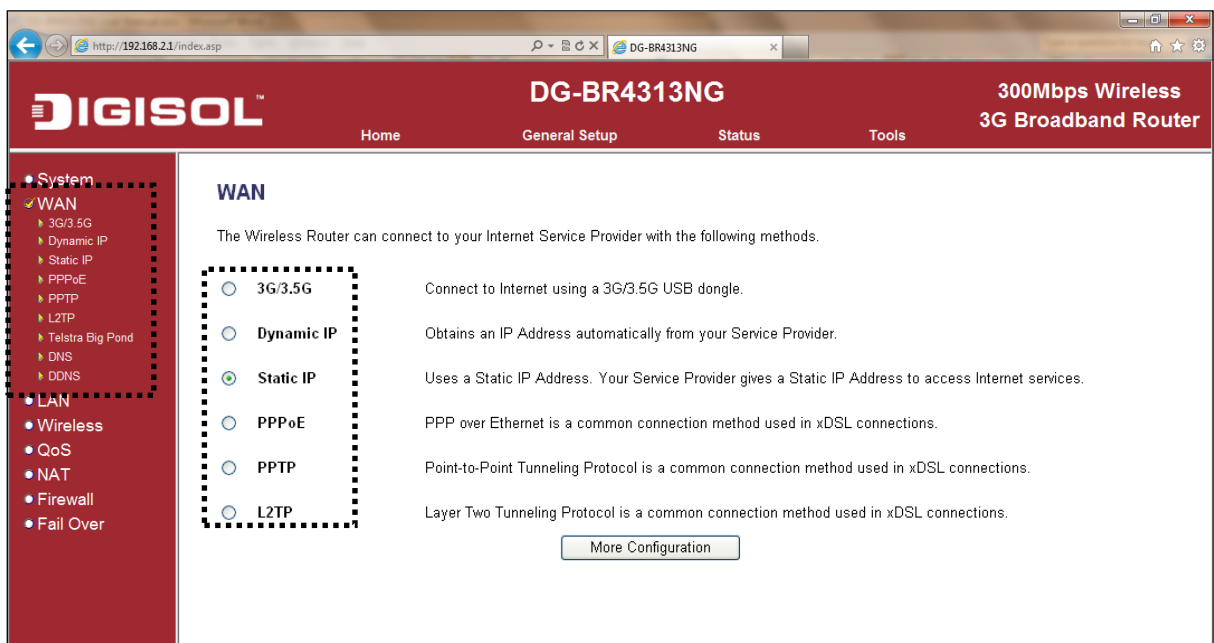

Following are the types of Internet connection:

- | | |
|------------|--|
| 3G/3.5G | - Please go to section 2-5-1 |
| Dynamic IP | - Please go to section 2-5-2 |
| Static IP | - Please go to section 2-5-3 |
| PPPoE | - Please go to section 2-5-4 |
| PPTP | - Please go to section 2-5-5 |
| L2TP | - Please go to section 2-5-6 |
| DNS | - Please go to section 2-5-7 |
| DDNS | - Please go to section 2-5-8 |

2-5-1 Setup procedure for '3G/3.5G'

3G/3.5G

Enter the User Name, Password, APN, PIN Code and Dialed Number provided to you by your service provider in the appropriate fields.

• 3G/3.5G Settings :

Country :	Select <input type="text"/>
ISP :	Select <input type="text"/>
PIN Code :	<input type="text"/>
APN :	<input type="text"/>
User Name :	<input type="text"/>
Password :	<input type="text"/>
Verify Password :	<input type="text"/>
Service :	3G/3.5G Only (UMTS/HSPA/HSDPA) <input type="text"/>
AT Dial Script :	*99# <input type="text"/>

Here is the description of every setup item.

Parameter	Description
Country	Select the country from dropdown list.
ISP	Select the Service Provider from dropdown list.
PIN Code	Enter the pin code if required.
APN	Enter the APN for 3G connection.
Username	Enter Username for 3G connection.

Password	Enter the password for 3G connection.
Verify Password	Enter the password to verify.
Service	Select the service type whether 3G or CDMA.
AT Dial Script	Enter the dial script.

2-5-2 Setup procedure for 'Dynamic IP'

Dynamic IP 

The Host Name is optional, but may be required by some Service Providers. The default MAC Address is set to the WAN physical interface on the Broadband router. If required by your Service Provider, you can use the 'Clone MAC Address' button to copy the MAC Address of the Network Interface Card installed in your PC and replace the WAN MAC Address with this MAC Address.

Host Name :	<input type="text"/>	
MAC address :	<input type="text" value="000000000000"/>	

Here is the description of every setup item:

Parameter	Description
Host Name	Please input host name of your computer. This is optional, and is only required if your service provider asks you to do so.
MAC Address	Please input MAC address of your computer, if your service provider only permits computer with certain MAC address to access internet. If you're using the computer which used to connect to Internet via cable modem, you can simply press 'Clone Mac address' button to fill the MAC address field with the MAC address of your computer.

After you finish with all settings, please click 'Apply'; if you want to remove any value you entered, please click 'Cancel'.

After you click 'Apply', the following message will be displayed on your web browser:

Save settings successfully!

You may press CONTINUE button to continue configuring other settings or press APPLY button to restart the system to make the changes take effect.

Please click 'Continue' to go back to previous setup menu; to continue on router setup, or click 'Apply' to reboot the router so the settings will take effect (Please wait for about 55 seconds while router is rebooting).

2-5-3 Setup procedure for 'Static IP':

Static IP 

If your Service Provider has assigned a Fixed IP address; enter the assigned IP Address, Subnet Mask and the Gateway IP Address provided.

IP Address :	<input type="text" value="172.1.1.1"/>
Subnet Mask :	<input type="text" value="255.255.0.0"/>
Default Gateway :	<input type="text" value="172.1.1.254"/>

Here is the description of every setup item:

Parameter	Description
IP Address	Please input the IP address assigned by your service provider.
Subnet Mask	Please input the subnet mask assigned by your service provider
Default Gateway	Please input the IP address of the gateway provided by your service provider.

After you finish with all the settings, please click 'Apply' button and the following message will be displayed on your web browser:

If you want to reset all settings in this page back to previously-saved value, please click 'Cancel' button.

Save settings successfully!

You may press CONTINUE button to continue configuring other settings or press APPLY button to restart the system to make the changes take effect.

Please click 'Continue' to go back to previous setup menu; to continue on other setup procedures, or click 'Apply' to reboot the router so the settings will take effect (Please wait for about 55 seconds while router is rebooting).

2-5-4 Setup procedure for 'PPPoE':

PPPoE 

Enter the PPPoE User Name and Password assigned by your Service Provider. The Service Name is normally optional, but may be required by some Service Providers. Enter a Idle Time (in minutes) to define a maximum period of time for which the Internet connection is maintained during inactivity. If the connection is inactive for longer than the Maximum Idle Time, then the connection will be dropped. You can enable the Connect on Demand option to automatically re-establish the connection as soon as you attempt to access the Internet again. If your Internet Service Provider requires the use of PPPoE, enter the information below.

User Name :	<input type="text"/>		
Password :	<input type="password"/>		
Service Name :	<input type="text"/>		
MTU :	<input type="text" value="1392"/>	(512<=MTU Value<=1492)	
Connection Type :	<input type="text" value="Continuous"/> ▼	<input type="button" value="Connect"/>	<input type="button" value="Disconnect"/>
Idle Time Out :	<input type="text" value="10"/>	(1-1000minutes)	

Here is the description of every setup item:

Parameter	Description
User Name	Please input user name assigned by your Internet service provider here.
Password	Please input the password assigned by your Internet service provider here.
Service Name	Please give a name to this Internet service, this is optional.
MTU	Please input the MTU value of your network connection here. If you don't know, you can use default value.
Connection Type	<p>Please select the connection type of Internet connection you wish to use.</p> <p>Continuous – The connection will be kept always On. If the connection is interrupted, the router will re-connect automatically.</p> <p>Connect On-Demand – Only connect when you want to surf the Internet. “Idle Time Out” is set to stop the connection when the network traffic is not sending or receiving after an idle time.</p>

	Manual – After you have selected this option, you will see the “Connect” button and “Disconnect” button, click “Connect” and the router will connect to the ISP. If you want to stop the connection, please click “Disconnect” button.
Idle Time Out	If you have selected the connection type to “Connect-On-Demand”, please input the idle time out.

After you finish with all settings, please click ‘Apply’ button and the following message will be displayed on your web browser.

If you want to reset all settings in this page back to previously-saved value, please click ‘Cancel’ button.

Save settings successfully!

You may press CONTINUE button to continue configuring other settings or press APPLY button to restart the system to make the changes take effect.

Please click ‘Continue’ to go back to previous setup menu; to continue on other setup procedures, or click ‘Apply’ to reboot the router so the settings will take effect (Please wait for about 55 seconds while router is rebooting).

2-5-5 Setup procedure for 'PPTP':

PPTP requires two kinds of settings: WAN interface setting (setup IP address) and PPTP setting (PPTP user name and password).

PPTP

Point-to-Point Tunneling Protocol is a common connection method used in xDSL connections.

- WAN Interface Settings**
 - Obtain an IP Address Automatically

Host Name :	<input type="text"/>
MAC Address :	<input type="text" value="000000000000"/> <input type="button" value="Clone MAC"/>

 - Use The Following IP Address

IP Address :	<input type="text" value="0.0.0.0"/>
Subnet Mask :	<input type="text" value="0.0.0.0"/>
Default Gateway :	<input type="text" value="0.0.0.0"/>
- PPTP Settings**

User Name :	<input type="text"/>
Password :	<input type="text"/>
PPTP Gateway :	<input type="text" value="0.0.0.0"/>
Connection ID :	<input type="text"/> (Optional)
MTU :	<input type="text" value="1392"/> (512<=MTU<=1492)
BEZEQ-ISRAEL :	<input type="checkbox"/> Enable (For BEZEQ network in ISRAEL use only)
Connection Type :	<input type="text" value="Continuous"/> <input type="button" value="Connect"/> <input type="button" value="Disconnect"/>
Idle Time Out :	<input type="text" value="10"/> (1-1000 Minute)

Here we start from WAN interface setting:

Here you select the type of how to obtain the IP address from your service provider. You can choose 'Obtain an IP address automatically' (i.e. DHCP, please refer to 'Cable Modem' [Section 2-3-2](#)), or 'Use the following IP address' (i.e. static IP address, please refer to [Section 2-3-3](#)).

WAN interface settings must be correctly set, or the Internet connection will fail, even though the PPTP settings are correct. Please contact your Internet service provider if you don't know what you should fill in these fields.

Now please go to PPTP settings section:

Parameter	Description
User Name	Please input user ID (user name) assigned by your Internet service provider here.
Password	Please input the password assigned by your Internet service provider here.
PPTP Gateway	Please input the IP address assigned by your Internet service provider here
Connection ID	Please input the connection ID here, this is optional and you can leave it blank.
MTU	Please input the MTU value of your network connection here. If you don't know, you can use default value.
BEZEQ-ISRAEL	Setting item 'BEZEQ-ISRAEL' is only required to be enabled if you're using the service provided by BEZEQ network in Israel.
Connection type	Please select the type of the Internet connection you wish to use. Refer to Note given in Section 2-3-4 Setup procedure for 'PPPoE xDSL' for detailed descriptions.
Idle Time Out	Please input the idle time out of Internet connection you wish to use. Refer to Note given in Section 2-3-4 Setup procedure for 'PPPoE xDSL' for detailed descriptions.

When you finish with all settings, please click 'Apply' button and the following message will be displayed on your web browser:

If you want to reset all settings in this page back to previously-saved value, please click 'Cancel' button.

Save settings successfully!

You may press CONTINUE button to continue configuring other settings or press APPLY button to restart the system to make the changes take effect.

Please click 'Continue' to go back to previous setup menu; to continue on other setup procedures, or click 'Apply' to reboot the router so the settings will take effect (Please wait for about 55 seconds while router is rebooting).

2-5-6 Setup procedure for 'L2TP':

L2TP is another popular connection method for xDSL and other Internet connection types, Like PPTP, two kinds of settings are required, we'll start from 'WAN Interface Settings':

L2TP

Layer Two Tunneling Protocol is a common connection method used in xDSL connections.

- WAN Interface Settings**
 - Obtain an IP Address Automatically

Host Name :	<input type="text"/>
MAC Address :	<input type="text" value="000000000000"/> <input type="button" value="Clone MAC"/>
 - Use The Following IP Address

IP Address :	<input type="text" value="0.0.0.0"/>
Subnet Mask :	<input type="text" value="0.0.0.0"/>
Default Gateway :	<input type="text" value="0.0.0.0"/>
- L2TP Settings**

User Name :	<input type="text"/>
Password :	<input type="text"/>
L2TP Gateway :	<input type="text"/>
MTU :	<input type="text" value="1392"/> (512<=MTU<=1492)
Connection Type :	<input type="text" value="Continuous"/> <input type="button" value="Connect"/> <input type="button" value="Disconnect"/>
Idle Time Out :	<input type="text" value="10"/> (1-1000 Minute)

Please select the type of how you obtain IP address from your service provider here. You can choose 'Obtain an IP address automatically' (i.e. DHCP, please refer to 'Cable Modem' [Section 2-3-2](#)), or 'Use the following IP address' (i.e. Static IP address, please refer to [Section 2-3-3](#)).

WAN interface settings must be correctly set, or the Internet connection will fail, even though L2TP settings are correct. Please contact your Internet service provider if you don't know what you should fill in these fields.

Now please go to L2TP settings section:

Here is the description of every setup item:

Parameter	Description
User Name	Please input user ID (user name) assigned by your Internet service provider here.
Password	Please input the password assigned by your Internet service provider here.
L2TP Gateway	Please input the IP address of L2TP gateway assigned by your Internet service provider here.
MTU	Please input the MTU value of your network connection here. If you don't know, you can use default value.
Connection type	Please select the connection type of Internet connection you wish to use. Refer to Note given in Section 2-3-4 Setup procedure for 'PPPoE xDSL' for detailed descriptions.
Idle Time Out	Please input the idle time out of Internet connection you wish to use. Refer to Note given in Section 2-3-4 Setup procedure for 'PPPoE xDSL' for detailed descriptions.

When you finish with all settings, please click 'OK' button and the following message will be displayed on your web browser:

If you want to reset all settings in this page back to previously-saved value, please click 'Cancel' button.

Save settings successfully!

You may press CONTINUE button to continue configuring other settings or press APPLY button to restart the system to make the changes take effect.

Please click 'Continue' to go back to previous setup menu; to continue on other setup procedures, or click 'Apply' to reboot the router so the settings will take effect (Please wait for about 55 seconds while router is rebooting).

2-5-7 Setup procedure for 'DNS':

If you select 'Dynamic IP' or 'PPPoE' as Internet connection method, at least one DNS server's IP address should be assigned automatically. However, if you have preferred DNS server, or your service provider didn't assign the IP address of DNS server because of any reason, you can input the IP address of DNS server here.

DNS ?

A DNS (Domain Name System) server is like an index of IP Addresses and Web Addresses. If you type a Web address into your browser, such as www.broadbandrouter.com, a DNS server will find that name in its index and find the matching IP address. Most ISPs provide a DNS server for speed and convenience. Since your Service Provider may connect you to the Internet through dynamic IP settings, it is likely that the DNS server IP Address is also provided dynamically. However, if there is a DNS server that you would rather use, you need to specify the IP Address of that DNS server. The primary DNS will be used for domain name access first, in case the primary DNS access failures, the secondary DNS will be used.

Primary DNS :

Secondary DNS :

Here is the description of every setup item:

Parameter	Description
Primary DNS	Please input the IP address of DNS server provided by your service provider.
Secondary DNS	Please input the IP address of another DNS server provided by your service provider, this is optional.

NOTE: Only IP address can be entered here; DO NOT use the hostname of DNS server! (i.e. only numeric characters and dots are accepted)

10.20.30.40..... Correct
dns.serviceprovider.com..... Incorrect

After you finish with all settings, please click ‘Apply’ button and the following message will be displayed on your web browser:

If you want to reset all settings in this page back to previously-saved value, please click ‘Cancel’ button.

Save settings successfully!

You may press CONTINUE button to continue configuring other settings or press APPLY button to restart the system to make the changes take effect.

Please click ‘Continue’ to go back to previous setup menu; to continue on other setup procedures, or click ‘Apply’ to reboot the router so the settings will take effect (Please wait for about 55 seconds while router is rebooting).

2-5-8 Setup procedure for 'DDNS':

DDNS (Dynamic DNS) is an IP-to-Hostname mapping service for those Internet users who don't have a static (fixed) IP address. It will be a problem when such users want to provide services to other users on Internet, because their IP address will vary every time when connected to Internet. Thus other users will not be able to know the IP address they're using at a certain time.

This router supports DDNS service of several service providers, for example:

DynDNS (<http://www.dyndns.org>)

TZO (<http://www.tzo.com>)

Please go to one of DDNS service provider's webpage listed above, and get a free DDNS account by the instructions given on their webpage.

DDNS ?

DDNS (DynamicDNS) allows users to map the static domain name to a dynamic IP address. You must get a account, password and your static domain name from the DDNS service providers. Our products have DDNS support for www.dyndns.org and www.tzo.com now.

Dynamic DNS :	<input type="radio"/> Enable <input checked="" type="radio"/> Disable
Provider :	DynDNS
Domain Name :	<input type="text"/>
Account :	<input type="text"/>
Password / Key :	<input type="text"/>

Here is the description of every setup item:

Parameter	Description
Dynamic DNS	If you want to enable DDNS function, please select 'Enabled'; otherwise please select 'Disabled'.
Provider	Select your DDNS service provider here.
Domain Name	Input the domain name you've obtained from DDNS service provider.
Account	Input username used for DDNS registration.
Password / Key	Input DDNS service password or key.

After you finish with all settings, please click ‘Apply’ button and the following message will be displayed on your web browser:

If you want to reset all settings in this page back to previously-saved value, please click ‘Cancel’ button

Save settings successfully!

You may press CONTINUE button to continue configuring other settings or press APPLY button to restart the system to make the changes take effect.

Please click ‘Continue’ to go back to previous setup menu; to continue on other setup procedures, or click ‘Apply’ to reboot the router so the settings will take effect (Please wait for about 55 seconds while router is rebooting).

2-6 Wired LAN Configurations

Before all computers using wired Ethernet connection (i.e. those computers connected to this router's LAN port 1 to 4 by Ethernet cable) can communicate with each other and access internet, they must have a valid IP address. There are two ways to assign IP addresses to computers: static IP address (set the IP address for every computer manually), and dynamic IP address (IP address of computers will be assigned by router automatically). It's recommended for most of computers to use dynamic IP address, it will save a lot of time on setting IP addresses for every computer, especially when there are a lot of computers in your network; for servers and network devices which will provide services to other computer and users that come from Internet, static IP address should be used, so that other computers can locate the server.

Suggestions on IP address numbering plan:

If you have no idea on how to define an IP address plan for your network, here are some suggestions.

- 1. A valid IP address has 4 fields: a.b.c.d, for most of home and company users, it's suggested to use 192.168.c.d, where c is an integer between 0 and 254, and d is an integer between 1 and 254. This router is capable to work with up to 253 clients, so you can set 'd' field of IP address of router as 1 or 254 (or any number between 1 and 254), and pick a number between 0 and 254 for field 'c'.**
- 2. In most cases, you should use '255.255.255.0' as subnet mask, which allows up to 253 clients (this also meets router's capability of working with up to 253 clients).**
- 3. For all servers and network devices which will provide services to other people (like Internet service, print service, and file service), they should use static IP address. Give each of them a unique number between 1 and 253, and maintain a list, so everyone can locate those servers easily.**
- 4. For computers which are not dedicated to provide specific service to others, they should use dynamic IP address.**

If you don't really understand the descriptions listed above, don't worry! We will provide recommended setup values below.

Please follow the instructions mentioned below to set wired LAN parameters:

Click 'General Setup' menu on the left of the web management interface, then click 'LAN' menu. There are three setup groups here: 'LAN IP', 'DHCP Server', and 'Static DHCP Lease Table'. Here are setup instructions for each of them:

2-6-1 LAN IP section:

LAN IP	
IP address	192.168.2.1
Subnet Mask	255.255.255.0
802.1d Spanning Tree	Disabled ▼
DHCP Server	Enabled ▼

Here is the description of every setup item:

Parameter	Description
IP address	Please input the IP address of this router.
Subnet Mask	Please input the subnet mask for this network.
802.1d Spanning Tree	If you wish to activate 802.1d spanning tree function, select 'Enabled' for setup item '802.1d Spanning Tree', or set it to 'Disabled'
DHCP Server	If you want to activate DHCP server function of this router, select 'Enabled', or set it to 'Disabled'.

Recommended Value if you don't know what to fill:

IP Address: 192.168.2.1
 Subnet Mask: 255.255.255.0
 802.1d Spanning Tree: Disabled
 DHCP Server: Enabled

2-6-2 DHCP Server:

• DHCP Server

Lease Time :	Forever <input type="button" value="v"/>
DHCP Client Start IP :	<input type="text" value="192.168.2.100"/>
DHCP Client End IP :	<input type="text" value="192.168.2.200"/>
Domain Name :	<input type="text"/>

These settings are only available when 'DHCP Server' in 'LAN IP' section is 'Enabled', and here are descriptions of every setup item

Parameter	Description
Lease Time	Please choose a lease time (the duration that every computer can keep a specific IP address) of every IP address assigned by this router from the dropdown menu.
Start IP	Please input the start IP address of the IP range.
End IP	Please input the end IP address of the IP range.
Domain Name	If you wish, you can also optionally input the domain name for your network. This is optional.

Recommended Value if you don't know what to fill:

Lease Time: Two Weeks (or 'Forever', if you have less than 20 computers)
 Start IP: 192.168.2.100
 End IP: 192.168.2.200
 Domain Name: (leave it blank)

NOTE:

- 1. The number of the last field (mentioned 'd' field) of 'End IP' must be greater than 'Start IP', and cannot be the same as router's IP address.**
- 2. The former three fields of IP address of 'Start IP', 'End IP', and 'IP Address of 'LAN IP' section (mentioned 'a', 'b', and 'c' field) should be the same.**
- 3. These settings will affect wireless clients too.**

2-6-3 Static DHCP Lease Table:

This function allows you to assign a static IP address to a specific computer forever, so you don't have to set the IP address for a computer, and still enjoy the benefit of using DHCP server. Maximum 16 static IP addresses can be assigned here.

(If you set 'Lease Time' to 'forever' in 'DHCP Server' section, you can also assign an IP address to a specific computer permanently, however, you will not be able to assign a specific IP address to a computer, since IP addresses will be assigned in random order by DHCP Server).

Enable Static DHCP Leases

MAC Address	IP Address
001122334455	192.168.2.100

Here is the description of every setup item:

Parameter	Description
Enable Static DHCP Leases	Check this box to enable this function, otherwise uncheck it to disable this function.
MAC Address	Input the MAC address of the computer or network device (total 12 characters, with character from 0 to 9, and from a to f, like '001122aabbcc')
IP address	Input the IP address you want to assign to this computer or network device.
'Add'	After you enter MAC address and IP address pair, click this button to add the pair to static DHCP leases table.

If you want to remove all characters you just entered, click 'Clear'.

After you clicked 'Add', the MAC address and IP address mapping will be added to 'Static DHCP Leases Table' section as shown below.

• **Static DHCP Lease Table** It allows 16 entries only.

NO.	MAC Address	IP Address	Select
1	00:11:22:33:44:55	192.168.2.100	<input type="checkbox"/>

If you want to delete a specific item, please check the 'Select' box of a MAC address and IP address mapping, then click 'Delete' button; if you want to delete all mappings, click 'Delete All'.

After you finish all LAN settings, please click 'Apply' button on this page. After you click 'Apply', the following message will be displayed on your web browser:

Save settings successfully!

You may press CONTINUE button to continue configuring other settings or press APPLY button to restart the system to make the changes take effect.

Please click 'Continue' to go back to previous setup menu; to continue on router setup, or click 'Apply' to reboot the router so the settings will take effect (Please wait for about 55 seconds while router is rebooting).

2-7 Wireless LAN Configurations

If your computer, PDA, game console, or other network devices are equipped with wireless network interface, you can use the wireless function of this router to let them connect to Internet and share resources with other computers with wired-LAN connection. You can also use the built-in security functions to protect your network from being intruded by malicious intruders.

Please follow the instructions mentioned below to set wireless parameters:

Ensure that Radio ON/OFF switch at the rear side of the router is in ON position. Next, click 'General Setup' menu on the left of web management interface, then click 'Wireless' menu on the left of web management interface, and the following message will be displayed on your web browser.

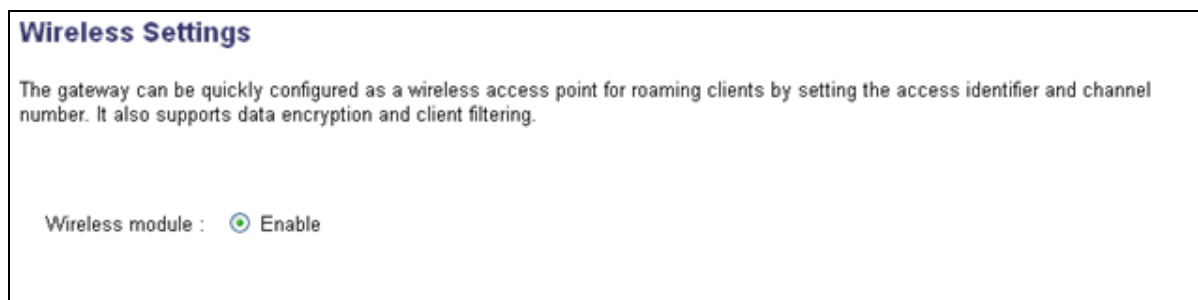

Note: If the Radio ON/OFF switch is in OFF position then the 'Wireless Module' will appear as 'Disable' in the above screen.

2-7-1 Basic Wireless Settings

Please click 'Basic Settings', and the following message will be displayed on your web browser:

Basic Settings ?

This page allows you to define ESSID, and Channel for the wireless connection. These parameters are used for the wireless stations to connect to the Access Point.

Wireless Module : Enabled

Band :	2.4 GHz (B+G+N) ▾
SSID :	DIGISOL
Channel Number :	11 ▾
Associated Clients :	<input type="button" value="Show Active Clients"/>

Here is the description of every setup item:

Parameter	Description
Band	<p>Please select the radio band from one of the following options:</p> <p>2.4 GHz (B) - This band, only allows 802.11b wireless network clients to connect to this router (maximum transfer rate 11Mbps).</p> <p>2.4 GHz (N) - This band, only allows 802.11n wireless network clients to connect to this router (maximum transfer rate 300Mbps).</p> <p>2.4 GHz (B+G) - This band, only allows 802.11b and 802.11g wireless network clients to connect to this router (maximum transfer rate 11Mbps for 802.11b clients, and maximum 54Mbps for 802.11g clients).</p> <p>2.4 GHz (G) - This band, only allows 802.11g wireless network clients to connect to this router (maximum transfer rate 54Mbps).</p>

	2.4 GHz (B+G+N) - This band, allows 802.11b, 802.11g, and 802.11n wireless network clients to connect to this router (maximum transfer rate 11Mbps for 802.11b clients, maximum 54Mbps for 802.11g clients and maximum 300Mbps for 802.11n clients).
SSID	This is the name of wireless router. You can type any alphanumerical characters here, maximum 32 characters. SSID is used to identify your own wireless router from others when there are other wireless routers in the same area. Default SSID is 'DIGISOL', it's recommended to change the default SSID value to the one which is meaningful to you, like myhome, office_room1, etc.
Channel Number	Please select a channel from the dropdown list of 'Channel Number', available channel numbers are 1 to 13 for European countries, 1 to 11 for USA. You can choose any channel number you want to use, and almost all wireless clients can locate the channel you're using automatically without any problem. However, it's still useful to remember the channel number you use, some wireless client supports manual channel number select, and this would help in certain scenario when there is some radio communication problem.
Associated Clients	Click 'Show Active Clients' button, then an "Active Wireless Client Table" will pop up. You can see the status of all active wireless stations that are connecting to the access point.

TIPS: You can try to change channel number to another one if you think the data transfer rate is too slow. There could be some other wireless routers using the same channel, which will disturb the radio communication between wireless client and the wireless router.

NOTE: If you don't have special reason to limit the type of allowed wireless client, it's recommended to choose '2.4 GHz (B+G+N)' to maximize wireless client compatibility.

2-7-2 Advanced Wireless Settings

This router provides some advanced control of wireless parameters, if you want to configure these settings, please click ‘Advanced Settings’ menu on the left of web management interface, under the ‘Wireless’ tab and the following message will be displayed on your web browser:

Advanced Settings

Set Advanced wireless settings to fine tune your wireless network.

Fragment Threshold :	2346	(256-2346)
RTS Threshold :	2347	(0-2347)
Beacon Interval :	100	(20-1024 ms)
DTIM Period :	3	(1-10)
Data Rate :	Auto ▼	
Channel Width :	<input checked="" type="radio"/> Auto 20/40 MHZ <input type="radio"/> 20 MHZ	
Preamble Type :	<input checked="" type="radio"/> Short Preamble <input type="radio"/> Long Preamble	
Broadcast ESSID :	<input checked="" type="radio"/> Enable <input type="radio"/> Disable	
CTS Protect :	<input type="radio"/> Auto <input type="radio"/> Always <input checked="" type="radio"/> None	
WMM:	<input type="radio"/> Enable <input type="radio"/> Disable	

Here is the description of every setup item

Parameter	Description
Fragment Threshold	Set the Fragment threshold of wireless radio. Do not modify default value if you don't know what it is, default value is 2346.
RTS Threshold	Set the RTS threshold of wireless radio. Do not modify default value if you don't know what it is, default value is 2347.
Beacon Interval	Set the beacon interval of wireless radio. Do not modify default value if you don't know what it is, default value is 100.

DTIM Period	Set the DTIM period of wireless radio. Do not modify default value if you don't know what it is, default value is 3.
Data Rate	Set the wireless data transfer rate to a certain value. Since most of wireless devices will negotiate with each other and pick a proper data transfer rate automatically, it's not necessary to change this value unless you know what will happen after modification.
Channel Width	Set channel width of wireless radio. Do not modify default value if you don't know what it is, default setting is 'Auto 20/40 MHz'.
Preamble Type	Set the type of preamble, do not modify default value if you don't know what it is, default setting is 'Short Preamble'.
Broadcast ESSID	Decide if the wireless router will broadcast its own ESSID or not. You can hide the ESSID of your wireless router (set the option to 'Disable'), so only people those who know the ESSID of your wireless router can get connected.
CTS Protect	Enabling this setting will reduce the chance of radio signal collisions between 802.11b and 802.11g/n wireless access points. It's recommended to set this option to 'Auto' or 'Always'. However, if you set to 'None', your wireless router should be able to work fine, too.
WMM	It is short for Wi-Fi Multimedia, it will enhance the data transfer performance of multimedia contents when they're being transferred over wireless network. If you don't know what it is / not sure if you need it, it's safe to set this option to 'Enable'. Default is "Enable".

After you finish these wireless settings, please click 'Apply' button and the following message will be displayed on your web browser:

Save settings successfully!

You may press CONTINUE button to continue configuring other settings or press APPLY button to restart the system to make the changes take effect.

Please click 'Continue' to go back to previous setup menu; to continue on router setup, or click 'Apply' to reboot the router so the settings will take effect (Please wait for about 55 seconds while router is rebooting).

2-7-3 Wireless Security

It's very important to set wireless security settings properly. If you don't, hackers and malicious users can reach your network and valuable data without your consent and this will cause serious security problem.

To set wireless security settings, Please click 'Security Settings' menu on the left of web management interface, under the 'Wireless' tab and then follow the instructions mentioned below to set wireless security settings:

Please select an encryption method from 'Encryption' dropdown menu. In this there are four options:

- | | |
|------------------------------|--|
| Disable | - Please go to section 2-7-3-1 |
| WEP | - Please go to section 2-7-3-2 |
| Wi-Fi Protected Access (WPA) | - Please go to section 2-7-3-3 |
| WPA RADIUS | - Please go to section 2-7-3-4 |

2-7-3-1 Disable wireless security

When you select this mode, data encryption is disabled, and every wireless device in proximity will be able to connect to your wireless router if no other security measure is enabled (like MAC address access control - see [section 2-7-4](#), or disable ESSID broadcast).

Only use this option when you really want to allow everyone to use your wireless router, and you don't care if there's someone reading the data you transfer over network without your consent.

2-7-3-2 WEP - Wired Equivalent Privacy

When you select this mode, the wireless router will use WEP encryption, and the following setup menu will be shown on your web browser:

Security Settings 

This page allows to setup the wireless security. Turn on WEP or WPA by using Encryption Keys to prevent any unauthorized access to your wireless network.

Encryption :	WEP
Key Length :	64-bit
Key Format :	Hex (10 Characters)
Default Tx Key :	Key 1
Encryption Key 1 :	*****
Encryption Key 2 :	*****
Encryption Key 3 :	*****
Encryption Key 4 :	*****

Enable 802.1x Authentication

Here is the description of every setup item

Parameter	Description
Key Length	There are two types of WEP key length: 64-bit and 128-bit. Using '128-bit' is safer than '64-bit', but will reduce some data transfer performance.
Key Format	There are two types of key formats: ASCII and Hex. When you select a key format, the number of characters of key will be displayed. For example, if you select '64-bit' as key length, and 'Hex' as key format, you'll see the message at the right of 'Key Format' is 'Hex (10 characters)', which means the length of WEP key is 10 characters.
Default Tx Key	When 'WEP' Encryption is enabled then 'Key 1' will appear in this field.
Encryption Key 1	Input WEP key characters here, the number of characters must be the same as the number displayed at 'Key Format' field. You can use any alphanumerical characters (0-9, a-z and A-Z) if you select 'ASCII' key format, and if you select 'Hex' as key format, you can use characters 0-9, a-f and A-F. You must enter at least one encryption key

	<p>here, and if you have entered multiple WEP keys, they should not be the same.</p>
<p>Enable 802.1x Authentication</p>	<p>IEEE 802.1x is an authentication protocol. Every user must use a valid account to login to this wireless router before accessing the wireless LAN. The authentication is processed by a RADIUS server. This mode only authenticates user by IEEE 802.1x, but it does not encrypt the data during communication. If there are RADIUS servers in your environment, please enable this function. Check this box and another sub-menu will appear:</p> <div style="border: 1px solid black; padding: 5px; margin: 10px 0;"> <p><input checked="" type="checkbox"/> Enable 802.1x Authentication</p> <p>RADIUS Server IP address : <input type="text"/></p> <p>RADIUS Server Port : <input type="text" value="1812"/></p> <p>RADIUS Server Password : <input type="text"/></p> </div>
<p>RADIUS Server IP address</p>	<p>Please input the IP address of radius server here.</p>
<p>RADIUS Server Port</p>	<p>Please input the port number of radius server here.</p>
<p>RADIUS Server Password</p>	<p>Please input the Password of the radius server here.</p>

TIPS: Some examples of WEP key

ASCII (5 characters): pilot, phone, 23561, 2Hyux

ASCII (13 characters): digitalFAMILY, 82Jh26xHy3mIn

Hex (10 characters): 287d2aa732, 1152dabc85

Hex (26 characters): 9284bcda8427c9e036f7abcd84

To improve security level, do not use those words which can be found in a dictionary or too easy to remember. ('pilot' and 'phone' listed above are bad examples; just intended to show you how a WEP key looks like). Wireless clients will remember the WEP key, so you only have to input the WEP key on wireless client once, and it's worth using complicated WEP key to improve security level.

After you finish WEP setting, please click 'Apply' button and the following message will be displayed on your web browser:

Save settings successfully!

You may press CONTINUE button to continue configuring other settings or press APPLY button to restart the system to make the changes take effect.



Please click 'Continue' to go back to previous setup menu; to continue on other setup procedures, or click 'Apply' to reboot the router so the settings will take effect (Please wait for about 55 seconds while router is rebooting).

2-7-3-3 Wi-Fi Protected Access (WPA)

When you select this mode, the wireless router will use WPA encryption, and the following setup menu will be shown on your web browser:

Security Settings 

This page allows you setup the wireless security. Turn on WEP or WPA by using Encryption Keys could prevent any unauthorized access to your wireless network.

Encryption :	WPA pre-shared key 
WPA Unicast Cipher Suite :	<input checked="" type="radio"/> WPA(TKIP) <input type="radio"/> WPA2(AES) <input type="radio"/> WPA2 Mixed
Pre-shared Key Format :	Passphrase 
Pre-shared Key :	<input style="width: 100%;" type="text"/>

Here is the description of every setup item:

Parameter	Description
WPA Unicast Cipher Suite	Please select a type of WPA cipher suite. Available options are: WPA (TKIP), WPA2 (AES) and WPA2 Mixed. You can select one of them, but you have to make sure your wireless client supports the cipher you selected.
Pre-shared Key Format	Select the type of pre-shared key, you can select Passphrase (8 or more alphanumerical characters, up to 63), or Hex (64 characters of 0-9, and a-f).
Pre-shared Key	Please input the WPA Pre-shared key here.

After you finish WPA Pre-shared key setting, please click ‘Apply’ button and the following message will be displayed on your web browser:

Save settings successfully!

You may press CONTINUE button to continue configuring other settings or press APPLY button to restart the system to make the changes take effect.

Please click ‘Continue’ to go back to previous setup menu; to continue on other setup procedures, or click ‘Apply’ to reboot the router so the settings will take effect (Please wait for about 55 seconds while router is rebooting).

NOTE: Some wireless clients (especially those manufactured before year 2003) only support WEP or WPA (TKIP) cipher. A driver upgrade would be needed for those clients to use WPA and WPA2 encryption.

2-7-3-4 WPA RADIUS

If you have a RADIUS server, this router can work with it and provide safer wireless authentication.

Security Settings

This page allows to setup the wireless security. Turn on WEP or WPA by using Encryption Keys to prevent any unauthorized access to your wireless network.

Encryption :	<input type="text" value="WPA RADIUS"/>
WPA Unicast Cipher Suite :	<input checked="" type="radio"/> WPA(TKIP) <input type="radio"/> WPA2(AES) <input type="radio"/> WPA2 Mixed
RADIUS Server IP Address :	<input type="text"/>
RADIUS Server Port :	<input type="text" value="1812"/>
RADIUS Server Password :	<input type="password"/>

Here is the description of every setup item:

Parameter	Description
WPA Unicast Cipher Suite	Please select a type of WPA cipher suite. Available options are: WPA (TKIP), WPA2 (AES) and WPA2 Mixed. You can select one of them, but you have to make sure your wireless client supports the cipher you selected.
RADIUS Server IP address	Please input the IP address of your Radius authentication server here.
RADIUS Server Port	Please input the port number of your Radius authentication server here. Default setting is 1812.
RADIUS Server Password	Please input the password of your Radius authentication server here.

After you finish with all settings, please click ‘Apply’ button and the following message will be displayed on your web browser:

Save settings successfully!

You may press CONTINUE button to continue configuring other settings or press APPLY button to restart the system to make the changes take effect.

Please click ‘Continue’ to go back to previous setup menu; to continue on other setup procedures, or click ‘Apply’ to reboot the router so the settings will take effect (Please wait for about 55 seconds while router is rebooting).

2-7-4 Wireless Access Control

This function will help you to prevent unauthorized users from connecting to your wireless router; only those wireless devices who have the MAC address you assigned here can gain access to your wireless router. You can use this function with other security measures described in previous section, to create a safer wireless environment. Up to 20 MAC addresses can be assigned by using this function. Please click 'Access Control' menu on the left of web management interface, under the 'Wireless' tab and the following message will be displayed on your web browser:

• **MAC Address Filtering Table**
It allows 20 entries only.

NO.	MAC Address	Comment	Select
1	11:22:33:44:55:66		<input type="checkbox"/>

Enable Access Control

MAC Address	Comment	
<input style="width: 95%;" type="text"/>	<input style="width: 95%;" type="text"/>	<input type="button" value="Add"/> <input type="button" value="Clear"/>

All allowed MAC addresses will be displayed in 'MAC Address Filtering Table'.

Here is the description of every setup item:

Parameter	Description
Delete	If you want to delete a specific MAC address entry, check the 'select' box of the MAC address you want to delete, then click 'Delete' button. (You can select more than one MAC address).
Delete All	If you want to delete all MAC addresses listed here, please click 'Delete All' button.
Enable Access Control	To enforce MAC address filtering, you have to check 'Enable Wireless Access Control'. When this item is unchecked, wireless router will not enforce MAC address filtering of wireless clients.
MAC Address	Input the MAC address of your wireless devices here, dash (-) or colon (:) are not required. (i.e. If the MAC address label of your wireless device indicates 'aa-bb-cc-dd-ee-ff' or 'aa:bb:cc:dd:ee:ff', just input 'aabbccddeeff').

Comment	You can input any text here as the comment of this MAC address, like 'ROOM 2A Computer' or anything. This is optional and you can leave it blank, however, it's recommended to use this field to write a comment for every MAC address as a memory aid.
Add	Click 'Add' button to add the MAC address and associated comment to the MAC address filtering table.
Clear	Click 'Clear' to remove the value you inputted in MAC address and comment field.

After you finish with all settings, please click 'Apply' button and the following message will be displayed on your web browser:

Save settings successfully!

You may press **CONTINUE** button to continue configuring other settings or press **APPLY** button to restart the system to make the changes take effect.

Please click 'Continue' to go back to previous setup menu; to continue on other setup procedures, or click 'Apply' to reboot the router so the settings will take effect (Please wait for about 55 seconds while router is rebooting).

If you want to reset all settings in this page back to previously-saved value, please click 'Cancel' button.

2-7-5 Wi-Fi Protected Setup (WPS)

Wi-Fi Protected Setup (WPS) is the simplest way to build secure connection between wireless network clients and this wireless router. You don't have to select encryption mode and input a long encryption passphrase every time when you need to setup a wireless client, you only have to press a button on wireless client and this wireless router, and the WPS will do the rest for you.

This wireless router supports two types of WPS: Push-Button Configuration (PBC) and PIN code. If you want to use PBC, you have to push a specific button on the wireless client to start WPS mode, and switch this wireless router to WPS mode too. You can push Reset/WPS button of this wireless router, or click 'Start PBC' button in the web configuration interface to do this; if you want to use PIN code, you have to know the PIN code of wireless client and switch it to WPS mode, then provide the PIN code of the wireless client you wish to connect to this wireless router. The detailed instructions are listed follow:

Please click 'WPS' menu on the left of web management interface, under the 'Wireless' tab, and the following message will be displayed on your web browser:

WPS

This page allows you to change the setting for WPS (Wi-Fi Protected Setup). WPS can help your wireless client automatically connect to the Wireless Router.

Enable WPS

- WPS Information

WPS Status :	Unconfigured
PinCode Self :	77971869
SSID :	DIGISOL
Authentication Mode :	Disable
Passphrase Key :	N/A
- Device Configure

Config Mode :	Registrar ▾
Configure by Push Button :	<input type="button" value="Start PBC"/>
Configure by Client PinCode :	<input type="text"/> <input type="button" value="Start PIN"/>

Here is the description of every setup item:

Parameter	Description
Enable WPS	Check this box to enable WPS function, uncheck it to disable WPS.
WPS Information	<p>WPS related system information will be displayed here:</p> <p>WPS Status: If the wireless security (encryption) function of this wireless router is properly set, you'll see 'Configured' message here. If wireless security function has not been set, you'll see 'unConfigured'.</p> <p>PinCode Self: This is the WPS PIN code of this wireless router. This code is useful when you need to build wireless connection by WPS with other WPS-enabled wireless devices.</p> <p>SSID: The SSID of this wireless router will be displayed here.</p> <p>Authentication Mode: The wireless security authentication mode of this wireless router will be displayed here. If you don't enable security function of the wireless router before WPS is activated, the router will auto set the security to WPA (AES) and generate a set of passphrase key for WPS connection.</p> <p>Passphrase Key: The wireless security key of the router will be displayed here.</p>
Device Configure	<p>Config Mode: There are 'Registrar' and 'Enrollee' modes for the WPS connection. When 'Registrar' is enabled, the wireless clients will follow the router's wireless settings for WPS connection. When 'Enrollee' mode is enabled, the router will follow the wireless settings of wireless client for WPS connection.</p>

	<p>Configure by Push Button: Click ‘Start PBC’ to start Push-Button style WPS setup procedure. This wireless router will wait for WPS requests from wireless clients for 2 minutes. The ‘WLAN’ LED on the wireless router will be steady on for 2 minutes when this wireless router is waiting for incoming WPS request.</p> <p>Configure by client Pin Code: Please input the PIN code of the wireless client you wish to connect, and click ‘Start PIN’ button. The ‘WLAN’ LED on the wireless router will be steady on when this wireless router is waiting for incoming WPS request</p>
--	---

2-7-6 Security Tips for Wireless Network

Here are some quick tips to help you improve the security level of your wireless network:

1. Never use simple words (like school, apple and computer) as WEP encryption or WPA passphrase.
2. A complicated (the combination of number, alphabet, even symbol and long enough) WEP key and WPA passphrase is much safer than simple and short ones. Remember that the wireless client is capable to keep the key or passphrase for you, so you only have to input the complicated key or passphrase once. It’s not too tedious and will greatly improve security level.
3. You can hide the ESSID of this router by setting ‘Broadcast ESSID’ option to ‘Disable’. Your wireless router will not be found by other people in proximity if they’re just using the AP scanning function of their wireless client, and this can reduce the chance of being intruded.
4. Use ‘Access Control’ function described in [section 2-7-4](#), so those MAC address which are not in your list will not be able to connect to your network.

3. Advanced Functions

3-1 Quality of Service (QoS)

Quality of service provides an efficient way for computers on the network to share the internet bandwidth with a promised quality of internet service. Without QoS, all computers and devices on the network will compete with each other to get internet bandwidth, and some applications which require guaranteed bandwidth (like video streaming and network telephone) will be affected, therefore an unpleasing result will occur, like the interruption of video / audio transfer.

With this function, you can limit the maximum bandwidth or give a guaranteed bandwidth for a specific computer, to avoid said unpleasing result from happening.

3-1-1 Basic QoS Settings

Please follow the instructions mentioned below to set QoS parameters:

Please click ‘General Setup’ menu on the left of web management interface, then click ‘QoS’ menu on the left of web management interface, and the following message will be displayed on your web browser:

QoS ?

QoS (Quality of Service) refers to the capability of a network to provide better service to selected network traffic. The primary goal of QoS is to provide priority including dedicated bandwidth, controlled jitter and latency (required by some real-time and interactive traffic), and improved loss characteristics. Also important is making sure that providing priority for one or more flows does not make other flows fail.

Enable QoS

Total Download Bandwidth : --Select-- >> 0 kbits

Total Upload Bandwidth : --Select-- >> 0 kbits

Current QoS Table

Priority	Rule Name	Upload Bandwidth	Download Bandwidth	Select
1	FTP	0	2048	<input type="checkbox"/>

Add
Edit
Delete
Delete All
Move Up
Move Down

APPLY
CANCEL

Here is the description of every setup item:

Parameter	Description
Enable QoS	Check this box to enable QoS function, unselect this box if you don't want to enforce QoS bandwidth limitations.
Total Download Bandwidth	You can set the limit of total download bandwidth in kbits. To disable download bandwidth limitation, input '0' here.
Total Upload Bandwidth	You can set the limit of total upload bandwidth in kbits. To disable upload bandwidth limitation, input '0' here.
Current QoS Table	All existing QoS rules will be displayed here.
Add	Click 'add' button to add a new QoS rule, see section 3-1-2 'Add a new QoS rule' below.
Edit	If you want to modify the content of a specific rule, please check the 'select' box of the rule you want to edit, then click 'Edit' button. Only one rule should be selected at a time. If you didn't select a rule before clicking 'Edit' button, you'll be prompted to add a new rule.
Delete	You can delete selected rules by clicking this button. You can select one or more rules to delete by checking the 'select' box of the rule(s) you want to delete at a time. If the QoS table is empty, this button will be grayed out and can not be clicked.
Delete All	By clicking this button, you can delete all rules currently in the QoS table. If the QoS table is empty, this button will be grayed out and can not be clicked.
Move Up	You can increase the priority of the QoS rule you selected, by clicking this button.
Move Down	You can lower the priority of the QoS rule you selected, by clicking this button.

After you finish with all settings, please click ‘Apply’ button and the following message will be displayed on your web browser:

If you want to reset all settings in this page back to previously-saved value, please click ‘Cancel’ button.

Save settings successfully!

You may press CONTINUE button to continue configuring other settings or press APPLY button to restart the system to make the changes take effect.

Please click ‘Continue’ to go back to previous setup menu; to continue on other setup procedures, or click ‘Apply’ to reboot the router so the settings will take effect (Please wait for about 55 seconds while router is rebooting).

3-1-2 Add a new QoS rule

After you click ‘Add’ button in QoS menu, the following message will appear:

Rule Name :	<input type="text"/>
Bandwidth :	Download <input type="button" value="v"/> <input type="text"/> Kbps Guarantee <input type="button" value="v"/>
Local IP Address :	<input type="text"/> - <input type="text"/>
Local Port Range :	<input type="text"/>
Remote IP Address :	<input type="text"/> - <input type="text"/>
Remote Port Range :	<input type="text"/>
Traffic Type :	None <input type="button" value="v"/>
Protocol :	TCP <input type="button" value="v"/>
<input type="button" value="Save"/> <input type="button" value="Reset"/>	

Here is the description of every setup item:

Parameter	Description
Rule Name	Please give a name to this QoS rule (upto 15 alphanumerical characters)
Bandwidth	Set the bandwidth limitation of this QoS rule. You have to select the data direction of this rule (Upload or Download), and the speed of bandwidth limitation in Kbps, then select the type of QoS: 'guarantee' (guaranteed usable bandwidth for this rule) or 'max' (set the maximum bandwidth for the application allowed by this rule).
Local IP Address	Specify the local (source) IP address that will be affected by this rule. Please input the starting IP address in the left field, and input the end IP address in the right field to define a range of IP addresses, or just input the IP address in the left field to define a single IP address.
Local Port Range	Please input the range of local (source) port number that will be affected by this rule. If you want to apply this rule on port 80 to 90, please input '80-90'; if you want to apply this rule on a single port, just input the port number, like '80'.
Remote IP Address:	Specify the remote (destination) IP address that will be affected by this rule. Please input the starting IP address in the left field, and input the end IP address in the right field to define a range of IP addresses, or just input the IP address in the left field to define a single IP address.
Remote Port Range	Please input the range of remote (destination) port number that will be affected by this rule. If you want to apply this rule on port 80 to 90, please input '80-90'; if you want to apply this rule on a single port, just input the port number, like '80'. If the remote (destination) IP address and /or port number is universal, just leave it blank.
Traffic Type	Please select the traffic type of this rule, available options are None, SMTP, HTTP, POP3 and FTP. You can select a specific traffic type for this rule, if you want to make this rule as an IP address based rule (Apply the limitation on all

	traffics from / to the specified IP address / port number), select 'None'.
Protocol	Please select the protocol type of this rule, available options are TCP and UDP. If you don't know what protocol your application uses, please try 'TCP' first, and switch to 'UDP' if this rule doesn't seem to work.

After you finish with all settings, please click 'Save' button , you'll be brought back to previous menu, and the rule you just set will appear in current QoS table; if you did anything wrong, you'll get an error message when you click 'Save' button, please correct your input by the instructions given by the error message.

If you want to erase all values you just entered. Click 'Reset'

3-2 Network Address Translation (NAT)

Network addresses translations means sharing a single IP address to multiple computers in a network. Without NAT, all computers must be assigned with a valid Internet IP address to get connected to Internet, but Internet service providers only provide very few IP addresses to every user. Therefore it's necessary to use NAT technology to share a single Internet IP address to multiple computers on local network, so everyone can get connected to Internet.

Please follow the instructions mentioned below to set NAT parameters:

3-2-1 Basic NAT Settings (Enable or disable NAT function)

Please click 'General Setup' menu on the left of web management interface, then click 'NAT' menu on the left of web management interface, and the following message will be displayed on your web browser

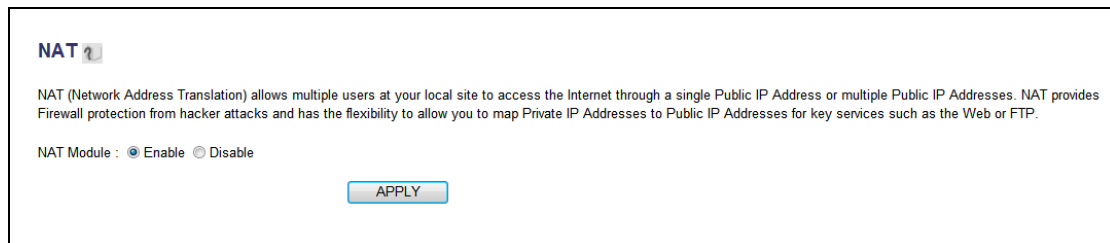

To enable NAT function, please select 'Enable' for 'NAT Module'; to disable the module, please select 'Disable'.

After you make the selection, please click 'Apply' button and the following message will be displayed on your web browser:

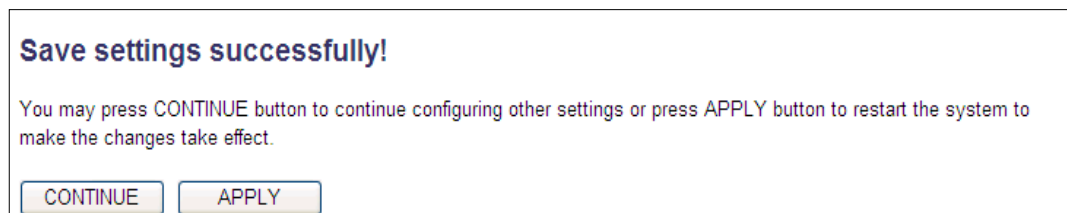

Please click 'Continue' to go back to previous setup menu; to continue on other setup procedures, or click 'Apply' to reboot the router so the settings will take effect (Please wait for about 55 seconds while router is rebooting).

3-2-2 Port Forwarding

This function allows you to redirect a single port or consecutive ports of Internet IP address to the same port of the IP address on a local network. The port number(s) of Internet IP address and private IP address (the IP address on local network) must be the same. If the port number of Internet IP address and private IP address is different, please use 'Virtual Server' function, described in next section.

Please click 'Port Forwarding' menu on the left of web management interface, under the 'NAT' tab and the following message will be displayed on your web browser

Port Forwarding 

Entries in this table allow you to automatically redirect common network services to a specific machine behind the NAT firewall. These settings are only necessary if you wish to host some sort of server like a web server or mail server on the private local network behind your Gateway's NAT firewall.

Enable Port Forwarding

Private IP	Computer Name	Type	Port Range	Comment
<input style="width: 90%;" type="text"/>	<< -----Select-----	Both	<input style="width: 80%;" type="text"/>	<input style="width: 90%;" type="text"/>

• **Current Port Forwarding Table**

NO.	Computer Name	Private IP	Type	Port Range	Comment	Select
<input type="button" value="Delete"/> <input type="button" value="Delete All"/> <input type="button" value="Reset"/>						

Here is the description of every setup item:

Parameter	Description
Enable Port Forwarding	Check this box to enable port mapping, and uncheck it to disable port mapping.
Private IP	Input the IP address of the computer on local network which provides internet service.
Computer Name	Pull down the menu and all the computers connected to the router will be listed here. You can easily select the computer name without checking the IP address of the computer.
Type	Select the type of connection, TCP or UDP. If you're not sure, please select 'Both'.

Port Range	Input the starting port number in the upper field, and input the ending port number in the bottom field. If you only want to redirect a single port number, just fill the port number in the upper field.
Comment	Please input any text to describe this mapping, up to 16 alphanumerical characters.
Add	Add the mapping to port forwarding table.
Reset	Remove all inputted values.
Current Port Forwarding Table	All existing port forwarding mappings will be displayed here.
Delete	Please select a port forwarding mapping by clicking the 'Select' box of the mapping, then click 'Delete' button to remove the mapping. If there's no existing mapping, this button will be grayed out.
Delete All	Deletes all mappings existing in the current port forwarding table.
Reset	Unselect all mappings.

After you finish with all settings, please click 'Apply' button and the following message will be displayed on your web browser:

If you want to reset all settings in this page back to previously-saved value, please click 'Cancel' button.

Save settings successfully!

You may press CONTINUE button to continue configuring other settings or press APPLY button to restart the system to make the changes take effect.

Please click 'Continue' to go back to previous setup menu; to continue on other setup procedures, or click 'Apply' to reboot the router so the settings will take effect (Please wait for about 55 seconds while router is rebooting).

3-2-3 Virtual Server

This function allows you to redirect a port on Internet IP address (on WAN port) to a specified port of an IP address on local network, so you can setup an Internet service on the computer on local network, without exposing it on Internet directly. You can also build many sets of port redirection, to provide many different Internet services on different local computers via a single Internet IP address.

Please click ‘Virtual Server’ menu on the left of web management interface, under the ‘NAT’ tab and the following message will be displayed on your web browser.

Enable Virtual Server

Private IP	Computer Name	Private Port	Type	Public Port	Comment
<input type="text"/>	<input type="button" value="<<"/> <input type="text" value="-----Select-----"/> <input type="button" value="v"/>	<input type="text"/>	Both <input type="button" value="v"/>	<input type="text"/>	<input type="text"/>

• Current Virtual Server Table

NO.	Computer Name	Private IP	Private Port	Type	Public Port	Comment	Select
							<input type="button" value="Delete"/> <input type="button" value="Delete All"/> <input type="button" value="Reset"/>
							<input type="button" value="APPLY"/> <input type="button" value="CANCEL"/>

Here is the description of every setup item:

Parameter	Description
Enable Virtual Server	Check this box to enable virtual server, and uncheck this box to disable virtual server.
Private IP	Input the IP address of the computer which provides Internet service.
Computer Name	Pull down the menu and all the computers connected to the router will be listed here. You can easily select the computer name without checking the IP address of the computer.
Private Port	Input the port number of the IP address that provides Internet service.
Type	Select the type of connection, TCP or UDP. If you’re not sure, please select ‘Both’.
Public Port	Please select the port number of Internet IP address which will be redirected to the port number of local IP address defined

	above.
Comment	Please input any text to describe this mapping, up to 16 alphanumeric characters.
Add	Add the mapping to virtual server table.
Reset	Remove all inputted values.
Current Virtual Server Table	All existing virtual server mappings will be displayed here.
Delete	Please select a virtual server mapping by clicking the 'Select' box of the mapping, then click 'Delete' button to remove the mapping. If there's no existing mapping, this button will be grayed out.
Delete All	Deletes all mappings existing in the current port forwarding table.
Reset	Unselect all mappings.

After you finish with all settings, please click 'Apply' button and the following message will be displayed on your web browser:

If you want to reset all settings in this page back to previously-saved value, please click 'Cancel' button.

Save settings successfully!

You may press CONTINUE button to continue configuring other settings or press APPLY button to restart the system to make the changes take effect.

Please click 'Continue' to go back to previous setup menu; to continue on other setup procedures, or click 'Apply' to reboot the router so the settings will take effect (Please wait for about 55 seconds while router is rebooting).

3-2-4 Port Mapping for Special Applications

Some applications like Internet gaming, Video conferencing, Internet telephony etc require multiple connections at a time; these applications won't work with simple NAT rules. In order to make these applications work, you can use this function.

Please click 'Special Applications' menu on the left of web management interface, under the 'NAT' tab and the following message will be displayed on your web browser.

Enable Special Applications

IP Address	Computer Name	TCP Port to Open	UDP Port to Open	Comment
<input type="text" value="0.0.0.0"/>	<< -----Select----- >>	<input type="text"/>	<input type="text"/>	<input type="text"/>

Popular Applications :

• Current Trigger-Port Table

NO.	Computer Name	IP Address	TCP Port to Open	UDP Port to Open	Comment	Select

Here is the description of every setup item:

Parameter	Description
Enable special Applications	Check this box to enable special applications and uncheck this box to disable Special Applications.
IP Address	Input the IP address of the computer on which you need to open the ports.
Computer Name	Click on the menu and all the computers connected to the router will be listed here. You can easily select the computer name without checking the IP address of the computer.
TCP Port to Open	This is the out going (Outbound) range of TCP port numbers for this particular application.
UDP Port to Open	This is the out going (Outbound) range of UDP port numbers for this particular application.
Comment	Please input any text to describe this setting, up to 16 alphanumerical characters.
Popular Applications	This section lists the more popular applications that require multiple connections. Select an application from the Popular

	Applications selection and click 'Add' to auto fill the TCP/UDP Ports and Comment.
Add	Add the setting to the 'Current Trigger-Port Table.'
Reset	Click 'Reset'. This will clear all above settings and you will have to reconfigure the unit again.
Current Trigger-Port Table	All the settings for the special applications will be listed here.
Delete	Please select a special application by clicking the 'Select' box of the mapping, then click 'Delete' button to remove the setting. If there's no setting here, this button will be grayed out.
Delete All	Delete all settings existed in Current trigger port table.
Reset	Unselect all settings.

NOTE: Only one LAN client can use a particular special application at a time.

After you finish with all settings, please click 'Apply' button and the following message will be displayed on your web browser:

If you want to reset all settings in this page back to previously-saved value, please click 'Cancel' button

Save settings successfully!

You may press CONTINUE button to continue configuring other settings or press APPLY button to restart the system to make the changes take effect.

Please click 'Continue' to go back to previous setup menu; to continue on other setup procedures, or click 'Apply' to reboot the router so the settings will take effect (Please wait for about 55 seconds while the router is rebooting).

3-2-5 UPnP Setting

This function enables network auto-configuration for peer-to-peer communications, with this function, network devices will be able to communicate with other devices directly, and learn information about other devices. Many network devices and applications rely on UPnP function nowadays.

Please click 'UPnP', menu on the left of web management interface, under the 'NAT' tab and the following message will be displayed on your web browser.

UPnP Settings

UPnP is more than just a simple extension of the Plug and Play peripheral model. It is designed to support zero-configuration, "invisible" networking, and automatic discovery for a breadth of device categories from a wide range of vendors. With UPnP, a device can dynamically join a network, obtain an IP address, convey its capabilities, and learn about the presence and capabilities of other devices-all automatically; truly enabling zero configuration networks. Devices can subsequently communicate with each other directly; thereby further enabling peer to peer networking.

UPnP Module : Enable Disable

There are two options in this page, please select 'Enable' or 'Disable' to enable or disable UPnP function, then click 'Apply' button, and the following message will be displayed on your web browser:

If you want to reset all settings in this page back to previously-saved value, please click 'Cancel' button

Save settings successfully!

You may press CONTINUE button to continue configuring other settings or press APPLY button to restart the system to make the changes take effect.

Please click 'Continue' to go back to previous setup menu; to continue on other setup procedures, or click 'Apply' to reboot the router so the settings will take effect (Please wait for about 55 seconds while router is rebooting).

3-2-6 ALG Settings

Application Layer Gateway (ALG) is a special function of this router. It includes many preset routing rules for numerous applications which require special support. With these routing rules, those applications which required special support will be able to work with NAT architecture.

Please click 'ALG' menu on the left of web management interface, under the 'NAT' tab and the following message will be displayed on your web browser.

ALG Settings

Below are applications that need router's special support to make them work under the NAT. You can select applications that you are using.

Enable	Name	Comment
<input checked="" type="checkbox"/>	FTP	Support for FTP.
<input checked="" type="checkbox"/>	H323	Support for H323/netmeeting.
<input checked="" type="checkbox"/>	IPsec	Support for IPsec passthrough.
<input checked="" type="checkbox"/>	PPTP	Support for PPTP passthrough.
<input checked="" type="checkbox"/>	L2TP	Support for L2TP passthrough.
<input checked="" type="checkbox"/>	SIP	Support for SIP.

There are many applications listed here. Please check the box of the special support for applications you need, and then click 'Apply' button and the following message will be displayed on your web browser:

If you want to reset all settings in this page back to previously-saved value, please click 'Cancel' button.

Save settings successfully!

You may press CONTINUE button to continue configuring other settings or press APPLY button to restart the system to make the changes take effect.

Please click 'Continue' to go back to previous setup menu; to continue on other setup procedures, or click 'Apply' to reboot the router so the settings will take effect (Please wait for about 55 seconds while router is rebooting).

3-2-7 Static Routing

NOTE: If NAT is 'Disable' then the following page will appear.

Static routing is used to configure the static routes in the router. The routes define how the LAN networks are interconnected.

Please click 'Static Routing' menu on the left of web management interface, under the 'NAT' tab and the following message will be displayed on your web browser

Static Routing

You can enable Static Routing to turn off NAT function of this router and let this router forward packets by your routing policy.

Enable Static Routing

Destination LAN IP	Subnet Mask	Default Gateway	Hop Count	Interface
<input type="text"/>	<input type="text"/>	<input type="text"/>	<input type="text"/>	LAN ▼
			<input type="button" value="Add"/>	<input type="button" value="Reset"/>

Current Static Routing Table

NO.	Destination LAN IP	Subnet Mask	Default Gateway	Hop Count	Interface	Select
			<input type="button" value="Delete"/>	<input type="button" value="Delete All"/>	<input type="button" value="Reset"/>	
			<input type="button" value="APPLY"/>		<input type="button" value="CANCEL"/>	

Here is the description of every setup item.

Parameter	Description
Enable Static Routing	Check this box to enable static routing on the router.
Destination LAN IP	Enter the remote destination LAN IP.
Subnet Mask	Enter the remote LAN subnet mask.
Default Gateway	Enter the default gateway.
Hop Count	Enter the Hop count.
Interface	Select the Interface either LAN or WAN.
Add	Click “Add” to Add the route in Current Static Routing Table.
Reset	Remove all inputted values

3-2-8 IGMP Settings

The Internet Group Management Protocol (IGMP) is a communications protocol used to manage the membership of Internet Protocol multicast groups. IGMP is used by IP hosts and adjacent multicast routers to establish multicast group memberships. It is an integral part of the IP multicast specification, like ICMP for unicast connections. IGMP can be used for online video and gaming, and allows more efficient use of resources when supporting these uses.

IGMP Settings

The Internet Group Management Protocol (IGMP) is a communications protocol used to manage the membership of Internet Protocol multicast groups. IGMP is used by IP hosts and adjacent multicast routers to establish multicast group memberships. It is an integral part of the IP multicast specification, like ICMP for unicast connections. IGMP can be used for online video and gaming, and allows more efficient use of resources when supporting these uses.

IGMP Module : Enable Disable

Enable: Select enable to allow multicast traffic to pass through the router

Disable: Select disable to stop multicast traffic to pass through router.

3-3 Firewall

Except NAT, this router also provides firewall function to block malicious intruders from accessing your computers on local network. These functions include inbound attack prevention and block outbound traffics, like block URLs which have pre-defined keywords.

Please follow the instructions mentioned below to enable or disable firewall function:

Please click 'General Setup' menu on the left of web management interface, then click 'Firewall' menu on the left of web management interface, and the following message will be displayed on your web browser

Firewall ?

The Wireless Router provides extensive firewall protection by restricting connection parameters, thus limiting the risk of hacker attack, and defending against a wide array of common attacks. However, for applications that require unrestricted access to the Internet, you can configure a specific client/server as a Demilitarized Zone (DMZ).

Firewall Module : Enable Disable

Please select 'Enable' or 'Disable' to enable or disable firewall function of this router, then click 'Apply' button, and the following message will be displayed on your web browser:

Save settings successfully!

You may press CONTINUE button to continue configuring other settings or press APPLY button to restart the system to make the changes take effect.

Please click 'Continue' to go back to previous setup menu; to continue on other setup procedures, or click 'Apply' to reboot the router so the settings will take effect (Please wait for about 55 seconds while router is rebooting).

3-3-1 Access Control

This function allows or denies computers with specific MAC addresses from connecting to the network; it can also allow or deny computers with specific IP addresses, protocols, or ports. Please click 'Access Control' menu on the left of web management interface, under the 'Firewall' tab and the following message will be displayed on your web browser.

<input type="checkbox"/> Enable MAC Filtering <input checked="" type="radio"/> Deny <input type="radio"/> Allow						
Client PC MAC Address	Computer Name	Comment				
<input type="text"/>	<< -----Select----- >>	<input type="text"/>				
		<input type="button" value="Add"/>	<input type="button" value="Reset"/>			

Current MAC Filtering Table						
NO.	Computer Name	Client PC MAC Address	Comment	Select		
				<input type="button" value="Delete"/>		
			<input type="button" value="Delete All"/>	<input type="button" value="Reset"/>		

<input type="checkbox"/> Enable IP Filtering <input checked="" type="radio"/> Deny <input type="radio"/> Allow						
NO.	Client PC Description	Client PC IP Address	Client Service	Protocol	Port Range	Select
						<input type="button" value="Add PC"/>
			<input type="button" value="Delete"/>	<input type="button" value="Delete All"/>		
						<input type="button" value="APPLY"/>
						<input type="button" value="CANCEL"/>

Here is the description of every setup item:

Parameter	Description
Enable MAC Filtering	Check this box to enable MAC address based filtering, and please select 'Deny' or 'Allow' to decide the behavior of MAC filtering table. If you select 'Deny', all MAC addresses listed in filtering table will be denied from connecting to the network; if you select 'Allow', only MAC addresses listed in filtering table will be able to connect to the network, and rejecting all other network devices.
Client PC MAC address	Please input the MAC address of the computer or the network device here, dash (-) or colon (:) are not required. (i.e. If the MAC address label of your wireless device indicates 'aa-bb-cc-dd-ee-ff' or aa:bb:cc:dd:ee:ff', just input 'aabbccddeeff')
Computer Name	Click on the menu and all the computers connected to the router will be listed here. You can easily select the computer name without checking the IP address of the computer.
Comment	You can input any text here as the comment of this MAC

	address, like 'ROOM 2A Computer' or anything. You can input up to 16 alphanumeric characters here. This is optional and you can leave it blank, however, it's recommended to use this field to write a comment for every MAC address as a memory aid.
Add	Click 'Add' button to add the MAC address and associated comment to the MAC address filtering table.
Reset	Remove all inputted values.
Current MAC Filtering Table	All existing MAC addresses in filtering table will be listed here.
Delete	If you want to delete a specific MAC address entry, check the 'select' box of the MAC address you want to delete, then click 'Delete' button. (You can select more than one MAC address).
Delete All	If you want to delete all MAC addresses listed here, please click 'Delete All' button.
Reset	You can also click 'Reset' button to unselect all MAC addresses.
Enable IP Filtering	Check this box to enable IP address based filtering, and please select 'Deny' or 'Allow' to decide the behavior of IP filtering table. If you select 'Deny', all IP addresses listed in filtering table will be denied from connecting to the network; if you select 'Allow', only IP addresses listed in filtering table will be able to connect to the network, and rejecting all other network devices.
IP Filtering Table	All existing IP addresses in filtering table will be listed here.
Add PC	Click this button to add a new IP address to IP filtering table, up to 20 IP addresses can be added. Please refer to section 3-3-1-1 Add PC below.
Delete	If you want to delete a specific IP address entry, check the 'select' box of the IP address you want to delete, then click 'Delete' button. (You can select more than one IP address).
Delete All	If you want to delete all IP addresses listed here, please click 'Delete All' button.

After you finish with all settings, please click ‘Apply’ button and the following message will be displayed on your web browser:

Save settings successfully!

You may press CONTINUE button to continue configuring other settings or press APPLY button to restart the system to make the changes take effect.

If you want to reset all settings in this page back to previously-saved value, please click ‘Cancel’ button.

Please click ‘Continue’ to go back to previous setup menu; to continue on other setup procedures, or click ‘Apply’ to reboot the router so the settings will take effect (Please wait for about 55 seconds while router is rebooting).

3-3-1-1 Add PC

After 'Add PC' button is clicked, the following message will be displayed on your web browser:

Client PC Description :	<input type="text"/>	
Client PC IP address :	<input type="text"/> - <input type="text"/>	
Client PC Service :		
Service Name	Detail Description	Select
WWW	HTTP, TCP Port 80, 3128, 8000, 8080, 8081	<input type="checkbox"/>
E-mail Sending	SMTP, TCP Port 25	<input type="checkbox"/>
News Forums	NNTP, TCP Port 119	<input type="checkbox"/>
E-mail Receiving	POP3, TCP Port 110	<input type="checkbox"/>
Secure HTTP	HTTPS, TCP Port 443	<input type="checkbox"/>
File Transfer	FTP, TCP Port 21	<input type="checkbox"/>
MSN Messenger	TCP Port 1863	<input type="checkbox"/>
Telnet Service	TCP Port 23	<input type="checkbox"/>
AIM	AOL Instant Messenger, TCP Port 5190	<input type="checkbox"/>
NetMeeting	H.323, TCP Port 389,522,1503,1720,1731	<input type="checkbox"/>
DNS	UDP Port 53	<input type="checkbox"/>
SNMP	UDP Port 161, 162	<input type="checkbox"/>
VPN-PPTP	TCP Port 1723	<input type="checkbox"/>
VPN-L2TP	UDP Port 1701	<input type="checkbox"/>
TCP	All TCP Port	<input type="checkbox"/>
UDP	All UDP Port	<input type="checkbox"/>
User Define Service		
Protocol:	<input type="text" value="Both"/>	
Port Range:	<input type="text"/>	
<input type="button" value="Add"/>	<input type="button" value="Reset"/>	

Here is the description of every setup item:

Parameter	Description
Client PC Description	Please input any text to describe this IP address, up to 16 alphanumerical characters.
Client PC IP address	Please input the starting IP address in the left field, and input the end IP address in the right field to define a range of IP addresses, or just input the IP address in the left field to define a single IP address.
Client PC Service	Please check all services you want to allow or deny this IP address to use, you can check multiple services listed in the table
Protocol	If the service you need is not listed above, you can create a new service on your own. Please select TCP or UDP, if you're not sure, please select 'Both'.
Port Range	Please input the port range of new service here. If you want to specify port 80 to 90, please input '80-90'; if you want to apply this rule on a single port, just input the port number, like '80'.
Add	When you finish with all settings, please click 'Add' to save settings, you'll be brought back to previous menu, and the rule you just set will appear in current IP filtering table.
Reset	If you want to remove all settings in this page, click 'Reset' button.

3-3-2 URL Blocking

If you want to prevent computers in the local network from accessing certain websites (like pornography, violence, or anything you want to block), you can use this function.

This function is useful for parents and company managers.

Please follow the instructions mentioned below to set URL blocking parameters:

Click 'URL Blocking' menu on the left of web management interface, under the 'Firewall' tab and the following message will be displayed on your web browser.

URL Blocking 

You can block access to certain Web sites from a particular PC by entering either a full URL address or just a keyword of the Web site.

Enable URL Blocking

URL/Keyword :

Current URL Blocking Table

NO.	URL/Keyword	Select
Delete	Delete All	Reset

Here is the description of every setup item:

Parameter	Description
Enable URL Blocking	Check this box to enforce URL Blocking, uncheck it to disable URL Blocking.
URL/Keyword	Input the URL (host name or IP address of website, like http://www.blocked-site.com or http://11.22.33.44), or the keyword which is contained in URL (like pornography, cartoon, stock, or anything).
Add	Click 'Add' button to add the URL / keyword to the URL / Keyword filtering table.
Reset	Click 'Reset' to remove the value you inputted in URL/Keyword field.
Current URL Blocking Table	All existing URL/Keywords in filtering table will be listed here.

Delete	If you want to delete a specific URL/Keyword entry, check the 'Delete' button. (You can select more than one entry)
Delete All	If you want to delete all URL/Keyword listed here, please click 'Delete All' button.
Reset	You can also click 'Reset' button to unselect all URL/Keywords.

After you finish with all settings, please click 'Apply' button and the following message will be displayed on your web browser:

If you want to reset all settings in this page back to previously-saved value, please click 'Cancel' button

Save settings successfully!

You may press CONTINUE button to continue configuring other settings or press APPLY button to restart the system to make the changes take effect.

Please click 'Continue' to go back to previous setup menu; to continue on other setup procedures, or click 'Apply' to reboot the router so the settings will take effect (Please wait for about 55 seconds while router is rebooting).

3-3-3 DoS Attack Prevention

Denial of Service (DoS) is a common attack measure, by transmitting a great amount of data or request to your Internet IP address and server, the Internet connection will become very slow, and server may stop responding because it is not capable of handling too much traffic.

This router has a built-in DoS attack prevention mechanism; when you activate it, the router will stop the DoS attack for you.

Please follow the instructions mentioned below to set DoS prevention parameters:

Click 'DoS' menu on the left of web management interface, under the 'Firewall' tab and the following message will be displayed on your web browser.

DoS Module

Ping of Death :	<input type="checkbox"/>
Discard Ping from WAN :	<input type="checkbox"/>
Port Scan :	<input type="checkbox"/>
Sync Flood :	<input type="checkbox"/>

Advanced Settings

APPLY CANCEL

Here is the description of every setup item:

Parameter	Description
Ping of Death	Ping of Death is a special packet, and it will cause certain computers to stop responding. Check this box and the router will filter this kind of packet out.
Discard Ping From WAN	Ping is a common and useful tool to know the connection status of a specified remote network device but some malicious intruder will try to fill your network bandwidth with a lot of PING request data packet, to make your internet connection become very slow, even unusable. Check this box and the router will ignore all

	inbound PING request, but when you activate this function, you will not be able to ping your own router from internet, too.
Port Scan	Some malicious intruder will try to use a 'port scanner' to know how many ports of your Internet IP address are open, and they can collect a lot of valuable information by doing so. Check this box and the router will block all traffics which are trying to scan your Internet IP address.
Sync Flood	This is another kind of attack, which uses a lot of fake connection request to consume the memory of your server, and try to make your server become unusable. Check this box and the router will filter this kind of traffic out.
Advanced Settings	Click this button and you can set advanced settings of the DoS prevention method listed above, please see section 3-3-3-1 'DoS – Advanced Settings' below.

After you finish with all settings, please click 'Apply' button and the following message will be displayed on your web browser:

If you want to reset all settings in this page back to previously-saved value, please click 'Cancel' button.

Save settings successfully!

You may press CONTINUE button to continue configuring other settings or press APPLY button to restart the system to make the changes take effect.

Please click 'Continue' to go back to previous setup menu; to continue on other setup procedures, or click 'Apply' to reboot the router so the settings will take effect (Please wait for about 55 seconds while router is rebooting).

3-3-3-1 DoS - Advanced Settings

When you click 'Advanced' button in DoS menu, the following message will be displayed on your web browser:

DoS Module			
<input type="checkbox"/>	Ping of Death	5	Packet(s) per Second Burst 5
<input type="checkbox"/>	Discard Ping from WAN		
<input type="checkbox"/>	Port Scan	<input checked="" type="checkbox"/> NMAP FIN / URG / PSH <input checked="" type="checkbox"/> Xmas tree <input checked="" type="checkbox"/> Another Xmas tree <input checked="" type="checkbox"/> Null scan <input checked="" type="checkbox"/> SYN / RST <input checked="" type="checkbox"/> SYN / FIN <input checked="" type="checkbox"/> SYN (only unreachable port)	
<input type="checkbox"/>	Sync Flood	30	Packet(s) per Second Burst 30

Here is the description of every setup item:

Parameter	Description
Ping of Death	Set the threshold of, when this DoS prevention mechanism will be activated. Please check the box of Ping of Death, and input the frequency of threshold (how many packets per second, minute, or hour), you can also input the 'Burst' value which means when this number of 'Ping of Death' packet is received in very short time, this DoS prevention mechanism will be activated.
Discard Ping From WAN	Check the box to activate this DoS prevention mechanism.
Port Scan	Many kinds of port scan methods are listed here please check one or more DoS attack methods you want to prevent.
Sync Flood	Like Ping of Death, you can set when the DoS prevention mechanism will be activated.

After you finish with all the settings, please click ‘Apply’ button and the following message will be displayed on your web browser:

If you want to reset all settings in this page back to previously-saved value, please click ‘Cancel’ button.

Save settings successfully!

You may press CONTINUE button to continue configuring other settings or press APPLY button to restart the system to make the changes take effect.

Please click ‘Continue’ to go back to previous setup menu; to continue on other setup procedures, or click ‘Apply’ to reboot the router so the settings will take effect (Please wait for about 55 seconds while router is rebooting).

3-3-4 Demilitarized Zone (DMZ)

Demilitarized Zone (DMZ) refers to a special area in your local network. This area resides in local network, and all computers in this area use private IP address, too. But these private IP addresses are mapped to a certain Internet IP address, so other people on Internet can fully access those computers in DMZ.

Please follow the instructions mentioned below to set DMZ parameters:

Click 'DMZ', menu on the left of web management interface, under the 'Firewall' tab and the following message will be displayed on your web browser.

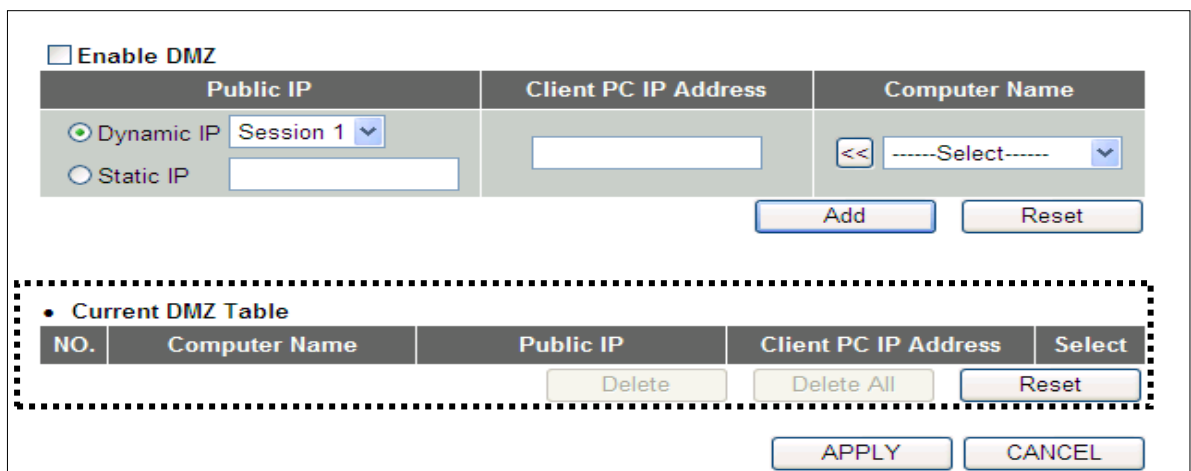

Here is the description of every setup item:

Parameter	Description
Enable DMZ	Check this box to enable DMZ function, uncheck this box to disable DMZ function.
Public IP address	You can select 'Dynamic IP' or 'Static IP' connection session from dropdown menu; if you select 'Dynamic IP' then select the session from the drop down box; if you select 'Static IP', please input the IP address that you want to map to a specific private IP address.
Client PC IP address	Please input the private IP address that Internet IP address will be mapped to.
Computer Name	Pull down the menu and all the computers connected to the router will be listed here. You can easily select the computer name without checking the IP address of the computer
Add	Click 'Add' button to add the public IP address and

	associated private IP address to the DMZ table.
Reset	Click 'Reset' to remove the value you inputted in Public IP address and Client PC IP address field.
Current DMZ Table	All existing public IP address and private IP address mapping will be displayed here.
Delete	If you want to delete a specific DMZ entry, check the 'select' box of the DMZ entry you want to delete, then click 'Delete' button. (You can select more than one DMZ entries).
Delete All	If you want to delete all DMZ entries listed here, please click 'Delete All' button.
Reset	You can also click 'Reset' button to unselect all DMZ entries.

After you finish with all settings, please click 'Apply' button and the following message will be displayed on your web browser:

If you want to reset all settings in this page back to previously-saved value, please click 'Cancel' button.

Save settings successfully!

You may press CONTINUE button to continue configuring other settings or press APPLY button to restart the system to make the changes take effect.

Please click 'Continue' to go back to previous setup menu; to continue on other setup procedures, or click 'Apply' to reboot the router so that the settings will take effect (Please wait for about 55 seconds while the router is rebooting).

3-4 Failover

WAN failure detection works by detecting the presence of traffic on the 3G modem link. If the link is idle for too long the router will attempt to ping a target IP address. If the ping does not reply, the router assumes the link is down and attempts to fail over to Ethernet WAN link and vice versa.

You can also setup Email notification, in case router triggers WAN Failover.

Please follow the instructions mentioned below to set Failover:

Click 'Failover', menu on the left of web management interface, and the following message will be displayed on your web browser.

Fail Over

Configure the priority of existing WAN connections and the rule for WAN fail over.

WAN FailOver :	<input type="radio"/> Enable <input checked="" type="radio"/> Disable
WAN Priority :	3G/3.5G ▾
Idle Timeout Detect :	0 (1-60 minutes)
Ping Target IP :	0.0.0.0

E-Mail Notification :	<input type="radio"/> Enable <input checked="" type="radio"/> Disable
Public Server :	----- ▾
SMTP Server :	
SMTP Port :	25
Sender E-Mail Address :	
Recipient E-Mail Address :	
SSL/TLS :	None ▾
SMTP Authentication :	<input type="radio"/> Enable <input checked="" type="radio"/> Disable
Account :	
Password :	

APPLY

Here, is the description of every setup item.

Parameter	Description
WAN Failover	Check this box to enable Fail Over function.
WAN Priority	Please select the WAN connection priority from the drop-down menu.
Idle Timeout Detect	Please input the idle time for detecting the Internet connection. If the major Internet connection is idle for this amount of time then the router will send a ping to the target IP Address you have assigned. If the ping gets a reply, the router will restart the idle timer, otherwise it will failover to the second priority of WAN connection.
Ping Target IP	Please input the target IP address you wish to ping out. If the major Internet connection is idle for too long the router will attempt to ping the target IP address.
Email Notification	If you enable E-Mail Notification function, when the WAN connection fails the router will automatically attempt to connect to the second priority of WAN connection and mail a notification to you.
Public Server	Select the Public server from dropdown list.
SMTP Server	Input the IP address or host name of the SMTP server (the server that delivers the Email). If you don't know, please refer to the SMTP server you're using in your Email software (like Outlook, Outlook Express etc.), or check with your network administrator or ISP.
SMTP Port	Input the mail server's SMTP port here. Most of the mail servers use port number 25.
Sender E-Mail Address	Input the Email address of mail sender.
Recipient E-Mail Address	Input the recipient's Email address here.
SSL/TLS	Please select the encryption supported by the SMTP mail server.

SMTP Authentication	Some SMTP servers require mail senders to be authenticated before they can send an Email. In such a case, please select 'Enable', or else select 'Disable'. If you don't know, please refer to the SMTP server you're using in your Email software (like Outlook, Outlook Express etc.), or check with your network administrator or ISP.
Account	Please input the user name of SMTP server here, if your SMTP server requires the use of authentication.
Password	Please input the password of SMTP server here, if your SMTP server requires the use of authentication.

After you finish with all settings, please click 'Apply' button and the following message will be displayed on your web browser:

Save settings successfully!

You may press **CONTINUE** button to continue configuring other settings or press **APPLY** button to restart the system to make the changes take effect.

Please click 'Continue' to go back to previous setup menu; to continue on other setup procedures, or click 'Apply' to reboot the router so that the settings will take effect (Please wait for about 55 seconds while the router is rebooting).

3-4 System Status

The functions described here will provide you with system related information.

3-4-1 System information and firmware version

You can use this function to know the system information and firmware version of this router.

Please click 'Status' link located at the upper-right corner of web management interface or the left side menu of the web management interface, and the following message will be displayed on your web browser

Status ?

The Wireless Router's status information provides the following information about your Wireless Router: Hardware/Firmware version, and its current operating status.

System

Model :	DG-BR4313NG
Up Time :	0day:1h:37m:57s
Hardware Version :	Rev. A
Boot Code Version :	1.0
Runtime Code Version :	1.03

3-4-2 Internet Connection Status

You can use this function to know the status of current Internet connection.

Please click 'Internet Connection' menu on the left of web management interface under the 'Status' tab, and the following message will be displayed on your web browser:

Internet Connection

View the current internet connection status and related information.

WAN Status

Attain IP Protocol :	Dynamic IP disconnect
IP Address :	
Subnet Mask :	
Default Gateway :	
MAC Address :	00:17:7C:40:BD:43
Primary DNS :	
Secondary DNS :	

3G/3.5G Status

WWAN Status:	Connected
IP Address:	115.246.58.12
Subnet Mask:	255.255.255.255
Gateway:	10.64.64.68

NOTE: This information will vary depending on the connection status.

3-4-3 Device Status

You can use this function to know the status of your router.

Please click 'Device Status' menu on the left of web management interface under the status tab and the following message will be displayed on your web browser:

Device Status

View the current setting status of this device.

Wireless Configuration

Mode :	Access Point
ESSID :	DIGISOL
Channel Number :	11
Security :	WPA pre-shared key

LAN Configuration

IP Address :	192.168.2.1
Subnet Mask :	255.255.255.0
DHCP Server :	Enable
MAC Address :	00:17:7C:40:bd:42

3-4-4 System Log

All important system events are logged. You can use this function to check the event log of your router.

Please click 'System Log' menu on the left of web management interface under the 'status' tab, and the following message will be displayed on your web browser:

System Log ?

View the system operation information. You can see the system start up time, connection process and etc., here.

```

Jan 1 00:00:01 (none) syslog.info syslogd started: BusyBox v1.11.1
Jan 1 00:00:35 (none) local2.info pppd[1635]: RP-PPPoE plugin version 3.3
Jan 1 00:00:35 (none) local2.notice pppd[1635]: pppd 2.4.4 started by root
Jan 1 00:01:10 (none) local2.warn pppd[1635]: Timeout waiting for PADO pac
Jan 1 00:01:10 (none) local2.err pppd[1635]: Unable to complete PPPoE Disc
Jan 1 00:02:15 (none) local2.warn pppd[1635]: Timeout waiting for PADO pac
Jan 1 00:02:15 (none) local2.err pppd[1635]: Unable to complete PPPoE Disc
Jan 1 00:03:21 (none) local2.warn pppd[1635]: Timeout waiting for PADO pac
Jan 1 00:03:21 (none) local2.err pppd[1635]: Unable to complete PPPoE Disc
                
```

The system events will be displayed in this page, and here are descriptions of every button:

Parameter	Description
Save	Save current event log to a text file.
Clear	Delete all event logs displayed here.
Refresh	Refresh the event log display.

3-4-5 Security Log

All information about network and system security is kept here, and you can use this function to check the security event log of your router.

Please click ‘Security Log’ menu on the left of web management interface below the ‘Status’ menu, and the following message will be displayed on your web browser:

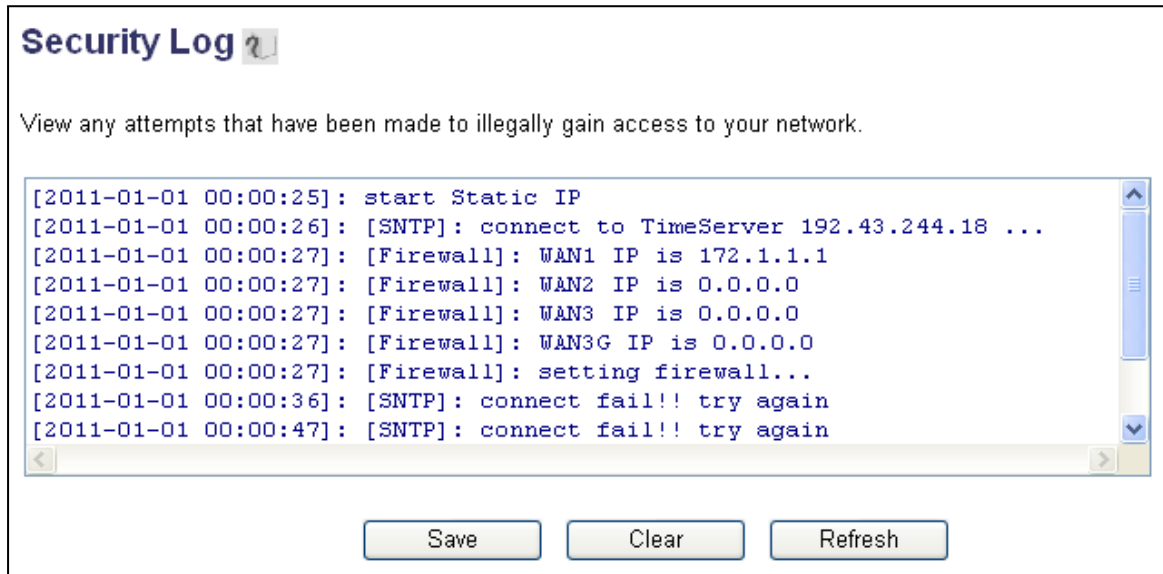

The system security events will be displayed in this page, and here is the description of every button:

Parameter	Description
Save	Save current event log to a text file.
Clear	Delete all event logs displayed here.
Refresh	Refresh the event log display.

3-4-6 Active DHCP client list

If you're using the DHCP server function of this router, you can use this function to check all active DHCP leases issued by this router.

Please click 'Active DHCP client' menu on the left of web management interface under the 'Status' tab, and the following message will be displayed on your web browser:

IP Address	MAC Address	Time Expired(s)
192.168.2.240	00:10:60:db:52:9d	58

All information about active DHCP leases issued by this router will be displayed here. You can click 'Refresh' button to display latest information.

3-4-7 Statistics

You can use this function to check the statistics of wireless, LAN, and WAN interface of this router.

Please click 'Statistics' menu on the left of web management interface under the 'Status' tab, and the following message will be displayed on your web browser:

Wireless LAN	Packets Sent	18204
	Packets Received	227409
Ethernet LAN	Packets Sent	1167
	Packets Received	1234
Ethernet WAN	Packets Sent	1083
	Packets Received	0

You can click 'Refresh' button to display latest information.

3-4-8 Modem Info

You can use this function to check the status of the 3G/3.5G data card.

Please click 'Modem Info' menu on the left of web management interface under the status tab and the following message will be displayed on your web browser:

Modem Info

Diagnostic 3G/3.5G modem information.

Manufacturer:	N/A
Product:	N/A
IMEI:	N/A
Signal:	N/A

3-5 Tools

The information provided here includes basic configuration tools, such as Save, Restore Configuration Settings and Upgrade System Firmware

3-5-1 Configuration Backup and Restore

You can backup all configurations of this router to a file, so you can make several copies of router configuration for security reasons.

To backup or restore router configuration, please follow the instructions mentioned below:

Please click 'Tools' located at the upper-right corner of web management interface or the left side menu of the home page on the web management interface, then click 'Configuration Tools' on the left of web management interface, then the following message will be displayed on your web browser:

Backup Settings :	<input type="button" value="Save"/>
Restore Settings :	<input type="text"/> <input type="button" value="Browse..."/> <input type="button" value="Upload"/>
Restore to Factory Default :	<input type="button" value="Reset"/>

Here is the description of every setup item:

Parameter	Description
Backup Settings	Press 'Save' button, and you'll be prompted to download the configuration as a file, default filename is 'config.bin', you can save it as another filename for different versions, and keep it in a safe place.
Restore Settings	Press 'Browse...' to pick a previously-saved configuration file from your computer, and then click 'Upload' to transfer the configuration file to the router. After the configuration is uploaded, the router's configuration will be replaced by the file you just uploaded.
Restore to Factory Default	Click this button to remove all settings you made, and restore the configuration of this router back to factory default settings.

3-5-2 Firmware Upgrade

The system software used by this router is called as ‘firmware’, just like any applications on your computer, when you replace the old application with a new one; your computer will be equipped with new function. You can also use this firmware upgrade function to add new functions to your router, even fix the bugs of this router.

To upgrade firmware, please follow the instructions:

Please click ‘Tools’ located at the upper-right corner of web management interface or on the left of the home page on the web management interface, then click ‘Firmware Upgrade’ on the left of web management interface, and the following message will be displayed on your web browser:

Firmware Upgrade ?

This tool allows you to upgrade the Wireless Router's system firmware. Enter the path and name of the upgrade file and then click the APPLY button below. You will be prompted to confirm the upgrade.

The system will automatically reboot the router after you finished the firmware upgrade process. If you don't complete the firmware upgrade process in the "next" step, you have to reboot the router.

Please click ‘Next’, and the following message will be displayed:

Firmware Upgrade ?

This tool allows you to upgrade the Wireless Router's system firmware. Enter the path and name of the upgrade file and then click the APPLY button below. You will be prompted to confirm the upgrade.

Click ‘Browse’ button first, you’ll be prompted to provide the filename of firmware upgrade file. Please download the latest firmware file from our website, and use it to upgrade your router.

After a firmware upgrade file is selected, click ‘Apply’ button, and the router will start firmware upgrade procedure automatically. The procedure may take several minutes, please be patient.

NOTE: Never interrupt the upgrade procedure by closing the web browser or physically disconnect your computer from router. If the firmware you uploaded is corrupt, the firmware upgrade will fail, and you may have to return this router to the dealer of purchase to ask for help. (Warranty voids if you interrupt the upgrade procedure).

3-5-3 Reboot

If you think the network performance is bad, or you find that the behavior of the router is strange, you can perform a router reboot, it may solve the problem.

To do so, please click ‘Tools’ located at the upper-right corner or the left of the home page on the web management interface, then click ‘Reboot’ on the left of web management interface, and the following message will be displayed on your web browser:

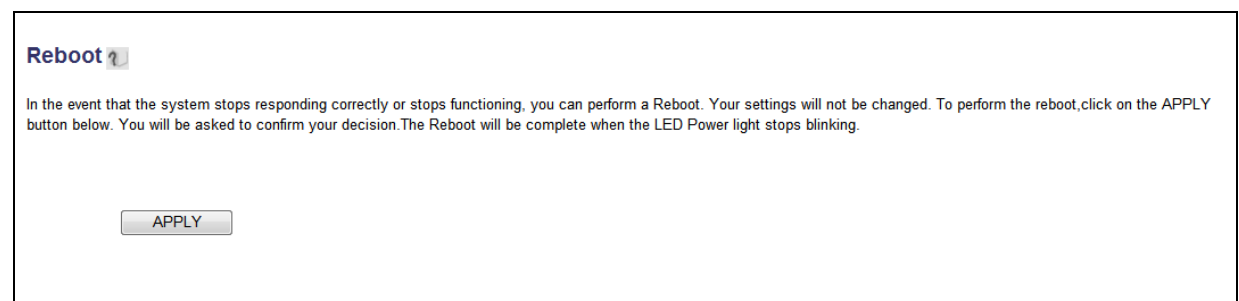

Please click ‘Apply’ to reboot your router, and it will be available again after few minutes, please be patient.

4 Appendix

4-1 Hardware Specification

- Flash: 8MB
- SDRAM: 32MB
- WAN Port: 10/100M UTP Port x 1
- LAN Ports: 10/100M UTP Port x 4
- USB Port : 1 USB Port for 3G modem
- Antenna: 3dBi fixed Dipole Antenna x 2 (2T2R ; These two antennas are for signal transmitting and receiving)
- Power: 5V DC, 2A Switching Power Adapter
- Net dimensions: (l x w x h) 181.4 x 121.9 x 28.17 mm
- Gross dimensions: (l x w x h) 262 x 188 x 68 mm
- Net Weight: 260 gms
- Gross Weight: 625 gms
- Transmit Power : 11n:15dBm±1.5dBm, 11g:15dBm±1.5dBm,
11b: 19dBm±1.5dBm
- Operating Temperature: 0 ~ 40°C
- Storage Temperature: -20 ~ 60°C
- Operating Humidity: 10-90% (Non Condensing)
- Storage Humidity: Max. 95% (Non Condensing)
- Certification: FCC, CE

4-2 Troubleshooting

If you find that the router is not working properly or stops responding don't panic! Before you contact your dealer of purchase for help, please read this troubleshooting first. Some problems can be solved by you within very short time.

Scenario	Solution
Unable to access the router through web page	<ol style="list-style-type: none">Please check the power cord connection and network cable of this router. All cords and cables should be correctly and firmly inserted into the router.If all LED's on the router are off, please check the status of A/C power adapter, and make sure it's correctly powered.You must use the same IP address subnet as the router uses.Are you using MAC or IP address filter? Try to connect the router by another computer and see if it works; if not, please restore your router to factory default settings (pressing 'reset' button for approximately 10 seconds).Set your computer to obtain an IP address automatically (DHCP) and see if your computer can get an IP address.If you did a firmware upgrade and this happens, contact your dealer of purchase for help.If all above solutions don't work, contact the dealer of purchase for help.
Can't get connected to Internet	<ol style="list-style-type: none">Go to 'Status' -> 'Internet Connection' menu, and check Internet connection status.Please be patient, sometimes Internet is just that slow.Bypass the router and verify whether you can get connected to internet as before.Check PPPoE / L2TP / PPTP user ID and password again.Call your Internet service provider and check if there's something wrong with their service.If you just can't connect to one or more websites, but

	<p>you can still use other internet services, please check URL/Keyword filter.</p> <p>g. Try to reset the router and try again.</p> <p>h. Reset the device provided by your Internet service provider too.</p> <p>i. Try to use IP address instead of hostname. If you can use IP address to communicate with a remote server, but can't use hostname, please check DNS settings.</p>
I can't locate my router by my wireless client	<p>a. 'Broadcast ESSID' set to off?</p> <p>b. Both the antennas are secure.</p> <p>c. Are you too far from your router? Try to get closer.</p> <p>d. Please remember that you have to input ESSID on your wireless client manually, if ESSID broadcast is disabled.</p>
File download is very slow or breaks frequently	<p>a. Are you using QoS function? Try to disable it and try again.</p> <p>b. Internet is slow sometimes, be patient.</p> <p>c. Try to reset the router and see if the download speed improves.</p> <p>d. Try to know what other clients do on your local network. If some clients are transferring files of big size, other clients will get an impression that Internet is slow.</p> <p>e. If this has never happened before, call you're Internet service provider to know if there is something wrong with their network.</p>
I can't log onto web management interface: password is wrong	<p>a. Make sure you're connecting to the correct IP address of the router.</p> <p>b. Password is case-sensitive. Make sure 'Caps lock' is not on.</p> <p>c. If you have forgotten the password, do a hard reset.</p>
Router gets heated up	<p>a. This is not a malfunction as long as you are able to touch the router's case.</p> <p>b. If you smell something wrong or see smoke coming out from the router or A/C power adapter, please disconnect the router and A/C power adapter from the utility power (make sure it's safe before you're doing this), and call</p>

	your dealer of purchase for help.
The date and time of all event logs are wrong	a. Adjust the time zone in 'System > Time Zone' settings of the router.

4-3 Glossary

Default Gateway (Router): Every non-router IP device needs to configure a default gateway IP address. When the device sends out an IP packet, if the destination is not on the same network, the device has to send the packet to its default gateway, which will then send it to the destination.

DHCP: Dynamic Host Configuration Protocol. This protocol automatically gives every computer on your home network an IP address.

DNS Server IP Address: DNS stands for Domain Name System, which allows Internet servers to have a domain name (such as www.Broadbandrouter.com) and one or more IP addresses (such as 192.34.45.8). A DNS server keeps a database of Internet servers and their respective domain names and IP addresses, so that when a domain name is requested (as in typing "Broadbandrouter.com" into your Internet browser), the user is sent to the proper IP address. The DNS server IP address used by the computers on your home network is the location of the DNS server your ISP has assigned to you.

DSL Modem: DSL stands for Digital Subscriber Line. A DSL modem uses your existing phone lines to transmit data at high speeds.

Ethernet: A standard for computer networks. Ethernet networks are connected by special cables and hubs, and move data around at up to 10/100 million bits per second (Mbps).

Idle Timeout: Idle Timeout is designed so that after there is no traffic on the Internet for a pre-configured amount of time, the connection will automatically get disconnected.

IP Address and Network (Subnet) Mask: IP stands for Internet Protocol. An IP address consists of a series of four numbers separated by periods, which identifies a single, unique Internet computer host in an IP network. Example: 192.168.2.1. It consists of 2 portions: the IP network address, and the host identifier.

The IP address is a 32-bit binary pattern, which can be represented as four cascaded decimal numbers separated by ".": `aaa.aaa.aaa.aaa`, where each "aaa" can be anything from 000 to 255, or as four cascaded binary numbers separated by ".": `bbbbbbbb.bbbbbbbb.bbbbbbbb.bbbbbbbb`, where each "b" can either be 0 or 1.

A network mask is also a 32-bit binary pattern, and consists of consecutive leading 1's followed by consecutive trailing 0's, such as 11111111.11111111.11111111.00000000. Therefore sometimes a network mask can also be described simply as "x" number of leading 1's.

When both are represented side by side in their binary forms, all bits in the IP address that correspond to 1's in the network mask become part of the IP network address, and the remaining bits correspond to the host ID.

For example, if the IP address for a device is, in its binary form, 11011001.10110000.10010000.00000111, and if its network mask is, 11111111.11111111.11110000.00000000

It means the device's network address is

11011001.10110000.10010000.00000000, and its host ID is, 00000000.00000000.00000000.00000111. This is a convenient and efficient method for routers to route IP packets to their destination.

ISP Gateway Address: (see ISP for definition). The ISP Gateway Address is an IP address for the Internet router located at the ISP's office.

ISP: Internet Service Provider. An ISP is a business that provides connectivity to the Internet for individuals and other businesses or organizations.

LAN: Local Area Network. A LAN is a group of computers and devices connected together in a relatively small area (such as home or office). Your home network is considered a LAN.

MAC Address: MAC stands for Media Access Control. A MAC address is the hardware address of a device connected to a network. MAC address is a unique identifier for a device with an Ethernet interface. It is comprised of two parts: 3 bytes of data that correspond to the Manufacturer ID (unique for each manufacturer), plus 3 bytes that are often used as the product's serial number.

NAT: Network Address Translation. This process allows all the computers on your home network to use one IP address. Using the broadband router's NAT capability, you can access Internet from any computer on your home network without having to purchase more IP addresses from your ISP.

Port: Network Clients (LAN PC) uses port numbers to distinguish one network application/protocol over another. Below is a list of common applications and protocol/port numbers:

Application	Protocol	Port Number
Telnet	TCP	23
FTP	TCP	21
SMTP	TCP	25
POP3	TCP	110
H.323	TCP	1720
SNMP	UDP	161
SNMP Trap	UDP	162
HTTP	TCP	80
PPTP	TCP	1723
PC Anywhere	TCP	5631
PC Anywhere	UDP	5632

PPPoE: (Point-to-Point Protocol over Ethernet.) Point-to-Point Protocol is a secure data transmission method originally created for dial-up connections; PPPoE is for Ethernet connections. PPPoE relies on two widely accepted standards, Ethernet and the Point-to-Point Protocol. It is a communication protocol for transmitting information over Ethernet between different manufacturers.

Protocol: A protocol is a set of rules for interaction agreed upon between multiple parties so that when they interface with each other based on such a protocol, the interpretation of their behavior is well defined and can be made objectively, without confusion or misunderstanding.

Router: A router is an intelligent network device that forwards packets between different networks based on network layer address information such as IP addresses.

Subnet Mask: A subnet mask, which may be a part of the TCP/IP information provided by your ISP, is a set of four numbers (e.g. 255.255.255.0) configured like an IP address. It is used to create IP address numbers used only within a particular network (as opposed to valid

IP address numbers recognized by the Internet, which must be assigned by InterNIC).

TCP/IP, UDP: Transmission Control Protocol/Internet Protocol (TCP/IP) and Unreliable Datagram Protocol (UDP). TCP/IP is the standard protocol for data transmission over the Internet. Both TCP and UDP are transport layer protocols. TCP performs proper error detection and error recovery, and thus is reliable. UDP on the other hand is not reliable. They both run on top of the IP (Internet Protocol), a network layer protocol.

WAN: Wide Area Network. A network that connects computers located in geographically separate areas (e.g. different buildings, cities, countries). The Internet is a wide area network.

Web-based management Graphical User Interface (GUI): Many devices support a graphical user interface that is based on the web browser. This means the user can use the familiar Netscape or Microsoft Internet Explorer to Control/configure or monitor the device being managed.

This product comes with lifetime warranty.
For further details about warranty policy and
product registration, please visit support
section of www.digisol.com

