



G.DUO

Dual 11g Access Point

User's Manual





## Copyright & Disclaimer

No part of this publication may be reproduced in any form or by any means, whether electronic, mechanical, photocopying, or recording without the written consent of OvisLink Corp.

OvisLink Corp. has made the best effort to ensure the accuracy of the information in this user's guide. However, we are not liable for the inaccuracies or errors in this guide. Please use with caution. All information is subject to change without notice

All Trademarks are properties of their respective holders.

This product contains some codes from GPL. In compliance with GPL agreement, AirLive will publish the GPL codes on our website. Please go to [www.airlive.com](http://www.airlive.com) and go to the "Support → GPL" menu to download source code.



© 2009 OvisLink Corporation, All Rights Reserved

# Table of Contents

<b>1. Introduction .....</b>	<b>1</b>
1.1 Overview .....	1
1.2 Firmware Upgrade and Tech Support .....	1
1.3 Features .....	2
1.4 Wireless Operation Modes.....	2
1.4.1 WISP + AP Mode.....	2
1.4.2 Client + AP mode.....	3
1.4.3 Dual AP Mode.....	3
1.4.4 Gateway + AP .....	3
1.4.5 WDS + AP.....	4
<b>2. Installing the G.DUO .....</b>	<b>5</b>
2.1 Before You Start .....	5
2.2 Package Content .....	5
2.3 Knowing your G.DUO.....	6
2.4 Hardware Installation .....	7
2.4.1 Passive PoE Installation.....	8
2.4.2 Wall Mount Installation .....	9
2.5 LED Table .....	10
2.6 Restore Settings to Default.....	10
<b>3. Configuring the G.DUO .....</b>	<b>11</b>
3.1 Important Information.....	11
3.2 Prepare your PC .....	12
3.3 Management Interface .....	12
Web Management (HTTP):.....	12
Secured Web Management (HTTPS):.....	13
Command Line Interface (Telnet):.....	13
Secure Shell (SSH, SSH2) .....	13
3.4 Introduction to Web Management.....	15
3.4.1 Getting into Web Management .....	15
3.4.2 Web Menu Structure .....	17
3.5 Initial Configurations .....	18
3.5.1 Choose the wireless Operation Modes.....	18
3.5.2 Change the Device's IP Address .....	19

3.5.3 Enable Password Protection.....	20
3.5.4 Enable Telnet or SSH.....	20
<b>4. WISP + AP Mode .....</b>	<b>22</b>
4.1 Application for WISP+AP Mode .....	22
4.2 Step-by-Step Example .....	23
4.2.1 Environment.....	23
4.2.2 Configuration Steps .....	24
4.3 Radio1: WISP Router Mode Settings.....	26
4.3.1 Basic Wireless Settings .....	26
4.3.2 Security Settings .....	27
4.3.3 Advance (Wireless Settings) .....	28
4.3.4 Site Survey .....	30
4.3.5 Signal Survey.....	31
4.3.6 WAN Port.....	31
4.3.7 Virtual Server Settings .....	32
4.3.8 DMZ.....	32
4.3.9 DDNS.....	33
4.3.10 DoS (Denial of Service).....	33
4.3.11 URL Filter .....	34
4.3.12 MAC Filter.....	34
4.3.13 IP Filter .....	35
4.3.14 Port Filter .....	35
4.3.15 Router (Static Route) .....	35
4.3.16 RIP (Routing Information Protocol).....	36
4.4 Radio2: AP Mode Settings .....	37
4.4.1 Basic Wireless Settings .....	37
4.4.2 Security Settings .....	37
4.4.3 Advance (Wireless Settings) .....	40
4.4.4 Access Control .....	41
4.4.5 Associated Clients.....	42
<b>5. Dual AP Mode.....</b>	<b>43</b>
5.1 Application for Dual AP Mode .....	43
5.2 Radio1 and 2: AP Mode Settings .....	44
5.2.1 Basic Wireless Settings .....	44
5.2.2 Security Settings .....	45
5.2.3 Advance (Wireless Settings) .....	47
5.2.4 Access Control .....	49
5.2.5 Associated Clients.....	49
<b>6. Client + AP Mode.....</b>	<b>51</b>
6.1 Application for Client + AP Mode.....	51
6.2 Radio1: Client Mode Settings .....	52

6.2.1 Basic Wireless Settings .....	52
6.2.2 Security Settings .....	53
6.2.3 Advance (Wireless Settings) .....	55
6.2.4 Site Survey .....	56
6.2.5 Signal Survey .....	57
6.2.6 Enable MAC Clone (Single Ethernet Client).....	57
<b>6.3 Radio2: AP Mode Settings .....</b>	<b>58</b>
6.3.1 Basic Wireless Settings .....	58
6.3.2 Security Settings .....	58
6.3.3 Advance (Wireless Settings) .....	61
6.3.4 Access Control .....	62
6.3.5 Associated Clients .....	63
<b>7. Gateway + AP Mode .....</b>	<b>64</b>
7.1 Application for Gateway +AP Mode .....	64
7.2 Radio1: WISP Router Mode Settings.....	65
7.2.1 Basic Wireless Settings .....	66
7.2.2 Security Settings .....	66
7.2.3 Advance (Wireless Settings) .....	68
7.2.4 Access Control .....	70
7.2.5 Associated Clients .....	70
7.2.6 Signal Survey .....	71
7.2.7 WAN Port.....	71
7.2.8 Virtual Server Settings .....	72
7.2.9 DMZ.....	73
7.2.10 DDNS.....	73
7.2.11 DoS (Denial of Service).....	74
7.2.12 URL Filter .....	74
7.2.13 MAC Filter.....	75
7.2.14 IP Filter .....	75
7.2.15 Port Filter .....	75
7.2.16 Router (Static Route) .....	76
7.2.17 RIP (Routing Information Protocol).....	76
7.3 Radio2: AP Mode Settings .....	77
7.3.1 Basic Wireless Settings .....	78
7.3.2 Security Settings .....	78
7.3.3 Advance (Wireless Settings) .....	80
7.3.4 Access Control .....	82
7.3.5 Associated Clients .....	82
<b>8. WDS + AP Mode .....</b>	<b>84</b>
8.1 Application for WDS + AP Mode .....	84
8.2 Radio1: WDS Bridge Settings.....	85
8.2.1 Basic Wireless Settings .....	85
8.2.2 WDS Security .....	86

8.2.3 Advance (Wireless Settings) .....	88
8.2.4 Site Survey .....	89
8.2.5 Signal Survey .....	90
8.2.6 WDS Settings .....	90
<b>8.3 Radio2: AP Mode Settings .....</b>	<b>91</b>
8.3.1 Basic Wireless Settings .....	91
8.3.2 Security Settings .....	91
8.3.3 Advance (Wireless Settings) .....	94
8.3.4 Access Control .....	95
8.3.5 Associated Clients .....	96
<b>9. System Configuration Menu .....</b>	<b>97</b>
9.1 Menu Structure .....	97
9.2 LAN Interface Setup .....	97
9.2.1 DHCP Settings .....	98
9.2.2 802.1d Spanning Tree .....	98
9.2.3 Clone MAC Address .....	98
9.2.4 Disable PING .....	98
9.2.5 Add DHCP Static Lease Client .....	99
9.3 Time Settings .....	99
9.4 Password Settings .....	100
9.5 System Management .....	100
9.6 SNMP Settings .....	101
9.7 Watchdog .....	102
9.7.1 Firmware Upgrade .....	102
9.7.2 Configuration Save and Restore .....	103
9.8 Factory Default .....	104
<b>10. Device Status Menu .....</b>	<b>105</b>
10.1 Menu Structure .....	105
10.2 Device Information .....	105
10.3 Statistic .....	106
10.4 Client Table (ARP Table) .....	107
10.5 Log .....	107
<b>11. Emergency Firmware Recovery .....</b>	<b>108</b>
<b>12. Frequent Asked Questions .....</b>	<b>110</b>
<b>13. Specifications .....</b>	<b>113</b>
13.1 Hardware Features .....	113

13.1.1 General Hardware Feature .....	113
13.2.1 Power Supply .....	113
13.2.2 Dimension and Weight.....	113
<b>13.2 Radio Specifications .....</b>	<b>114</b>
13.2.1 Frequency Band .....	114
13.2.3 Rate and Modulation.....	114
13.2.4 TX Output Power .....	114
13.2.5 Receiver Sensitivity .....	114
13.2.6 Supported WLAN Mode.....	115
13.3 Software Features.....	115
<b>14. Wireless Network Glossary.....</b>	<b>117</b>

# 1

## Introduction

### 1.1 Overview

The G.DUO is a dual radio wireless multi-function device based on IEEE 802.11g/b 2.4GHz radio technologies. It features 2 WiFi radios for WISP and other applications that can not be achieved using single radio. In addition, it features passive PoE port for installations in places that have no nearby access to electricity (DC Injector is not included). Finally, it also comes with a WAN port and Gateway+AP mode that can turn G.DUO into a wireless router with 2 radios.

*If you encounter any technical issues, we strongly recommend you read through Chapter 12: Frequent Asked Questions. The answers you need are very likely to be there.*

### 1.2 Firmware Upgrade and Tech Support

If you encounter a technical issue that can not be resolved by information on this guide, we recommend that you visit our comprehensive website support at [www.airlive.com](http://www.airlive.com). The tech support FAQ are frequently updated with latest information.

In addition, you might find new firmwares that either increase software functions or provide bug fixes for G.DUO. You can reach our on-line support center at the following link: [http://www.airlive.com/support/support\\_2.jsp](http://www.airlive.com/support/support_2.jsp)

Since 2009, AirLive has added the “Newsletter Instant Support System” on our website. AirLive Newsletter subscribers receives instant email notifications when there are new download or tech support FAQ updates for their subscribed airlive models. To become an AirLive newsletter member, please visit: [http://www.airlive.com/member/member\\_3.jsp](http://www.airlive.com/member/member_3.jsp)

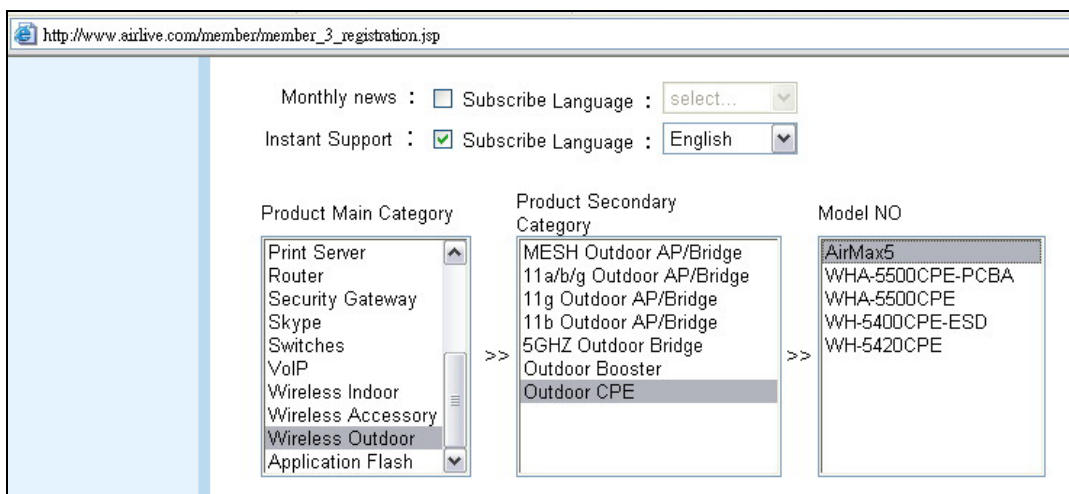



## 1.3 Features

- Dual 11g CPU with 2 x 11g/b Radios
- 4MB Flash and 32MB SDRAM
- 5 wireless multi-function modes: WISP+AP, Dual AP, Client + AP, WDS+AP, Gateway+AP
- 2 x R-SMA connectors for external antenna.
- Passive PoE Port for 12V Passive POE System. Passive DC Injector not included
- 1 x WAN port for xDSL and Cable Modem.
- Wall Mount holes included
- Bandwidth Control
- Site Survey and Signal Strength indicator for antenna alignment
- Emergency firmware recovery mode
- Web, HTTPS, SSH/SSH2, Telnet, and SNMP managements

## 1.4 Wireless Operation Modes

The G.DUO can perform as a multi-function wireless device. Through the AirLogic web interface, users can easily select which wireless mode they wish the G.DUO to perform.

The G.DUO can be configured to operate in the following wireless operation modes:

### 1.4.1 WISP + AP Mode

This mode is designed as 2-way wireless router for WISP subscriber. Radio1 acts as a client router to connect with outdoor AP; Radio1 works as a wireless AP for home. This combination allows WISP subscriber to share their Internet connection wirelessly.

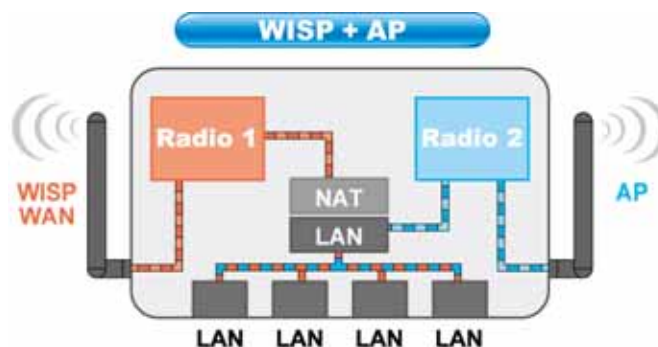

### 1.4.2 Client + AP mode

In this mode, Radio1 is working as a wireless client to connect with remote AP. Radio2 is working as an Access Point to redistribute the signal from Radio1. This combination creates a wireless repeater with 2 radios. It can be used to amplify the signal from remote AP.

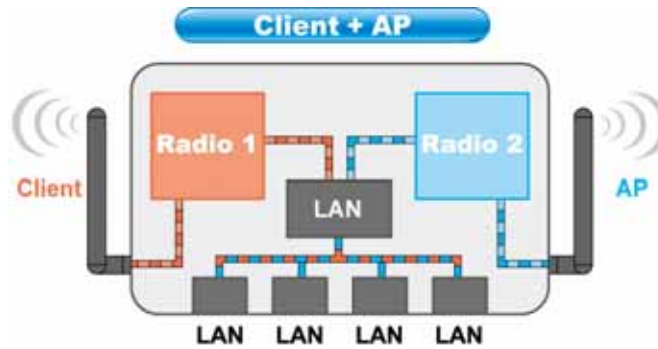

### 1.4.3 Dual AP Mode

In this mode, the G.DUO works as 2 Access Points. You can have both radios with directional antennas to create a larger coverage. *Please remember to set the channels of the radios as far apart as possible.*

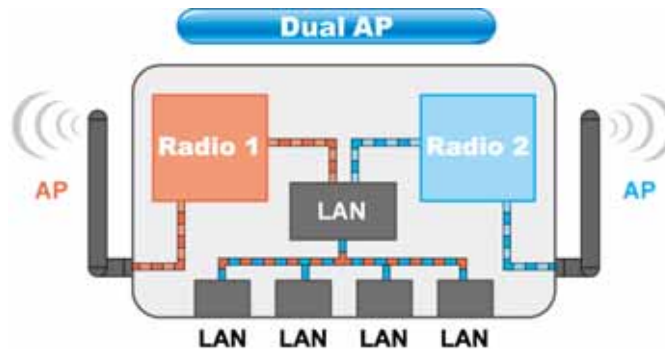

### 1.4.4 Gateway + AP

In this mode, both Radios are acting as wireless router. The WAN port is the LAN1 port. The application for this is to extend the wireless router's coverage. You can use 2 directional antennas to provide longer distance and wider coverage over large area, such as in the shopping center. When using this mode, it is recommended to use directional antennas for both radios to avoid mutual interference.

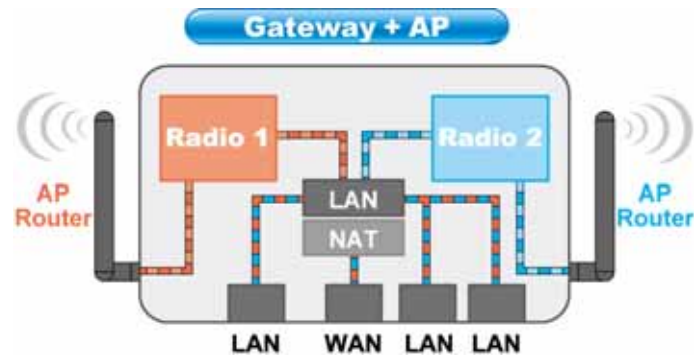

### 1.4.5 WDS + AP

In this mode, the Radio1 is working in WDS Bridge mode while Radio2 works as an Access Point. This mode is design to build a wireless backbone network while providing hotspot access through Radio2's AP network. It is ideal for Hotel Installation. When using this mode, please make sure that the channels are set apart between Radio1 and Radio2. Radio1 should install with directional antenna.

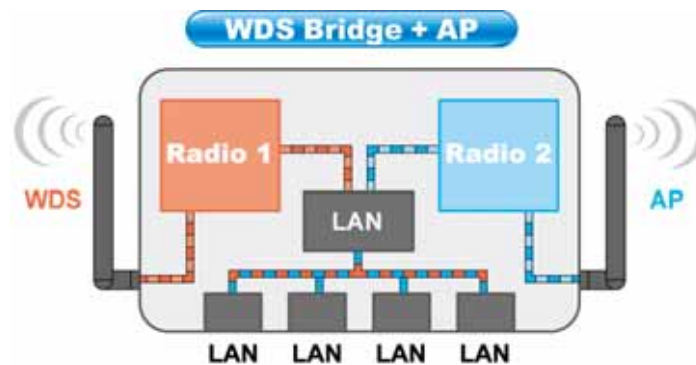

# 2

## Installing the G.DUO

This section describes the hardware features and the hardware installation procedure for the G.DUO. For software configuration, please go to chapter 3 for more details.

### 2.1 Before You Start

It is important to read through this section before you install the G.DUO

- It is recommended that you set the channels of the 2 radios as apart as possible to avoid mutual interference. For example, Radio1 at channel 1 and Radio2 at Channel 11
- It is recommended that you adjust the antenna angles to get the best performance. You can try to move the antenna outward as indicated on the diagram below if you encounter poor performance problem.



- The LAN1 port also work as the passive POE port and the WAN port(Gateway mode only)
- The passive PoE DC Injector is optional, it is not included with the package. Please use a 12V passive POE system with G.DUO's passive POE port. **Do not use 802.3af 48V system or PoE switch with the device.**

### 2.2 Package Content

The G.DUO package contains the following items:

- One G.DUO main unit
- One 12V 1A DC power adapter
- 2 x Antennas (subject to change without notice)
- User's Guide CD

■ Quick Start Guide



## 2.3 Knowing your G.DUO

Below are descriptions and diagrams of the product:

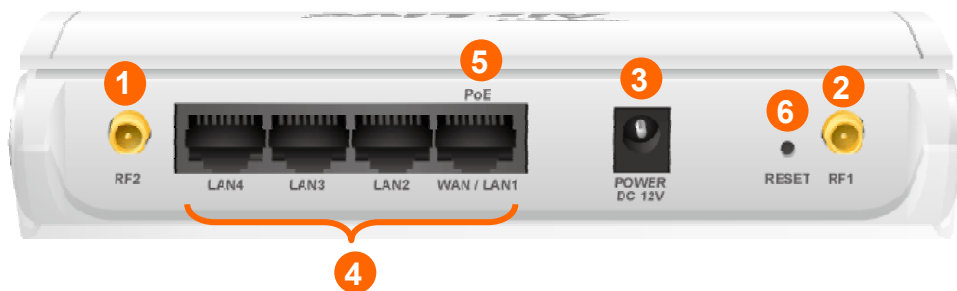

- 1 Radio 1 Antenna Connector
- 2 Radio 2 Antenna Connector
- 3 Power Adapter Connector
- 4 LAN Ports
- 5 WAN + Passive PoE Port
- 6 Reset Button



## 2.4 Hardware Installation

1. Please install the antennas by turning clock wise into the RF1 and RF2 antenna connectors



2. Now connect the power adapter to the G.DUO



3. Connect the Ethernet cable to one of the LAN port and the other end to your PC.



4. If you are using G.DUO in Gateway mode to share your xDSL or Cable modem connection, please connect the Internet cable to “WAN port”.

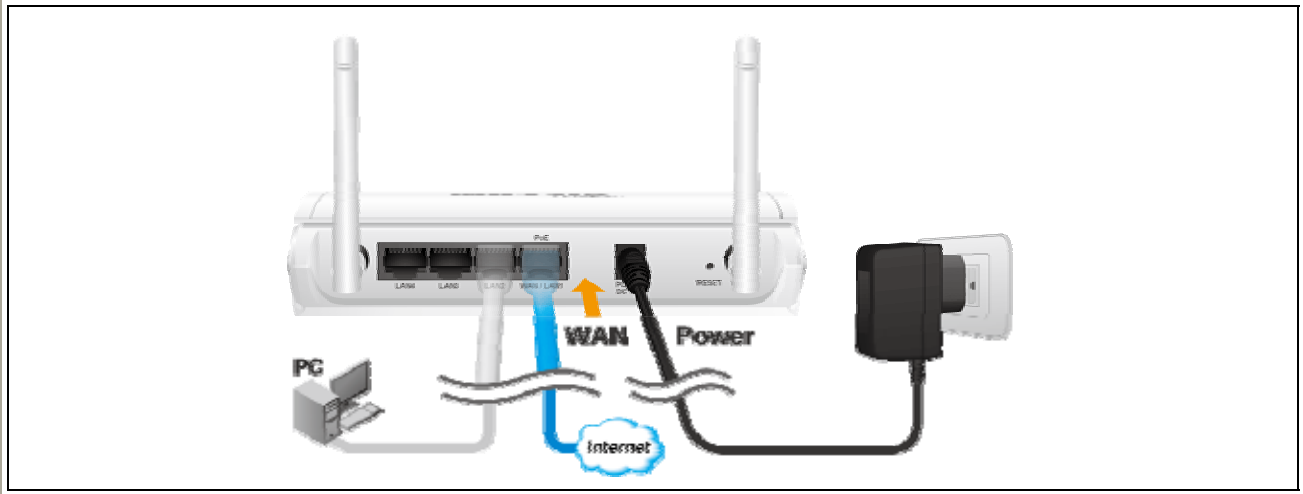

### 2.4.1 Passive PoE Installation

If you want to supply the power by using Passive PoE, please follow the installation diagram below. Please note that the passive DC Injector is not included with G.DUO, it needs to be purchased separately. G.DUO uses 12V passive PoE system.

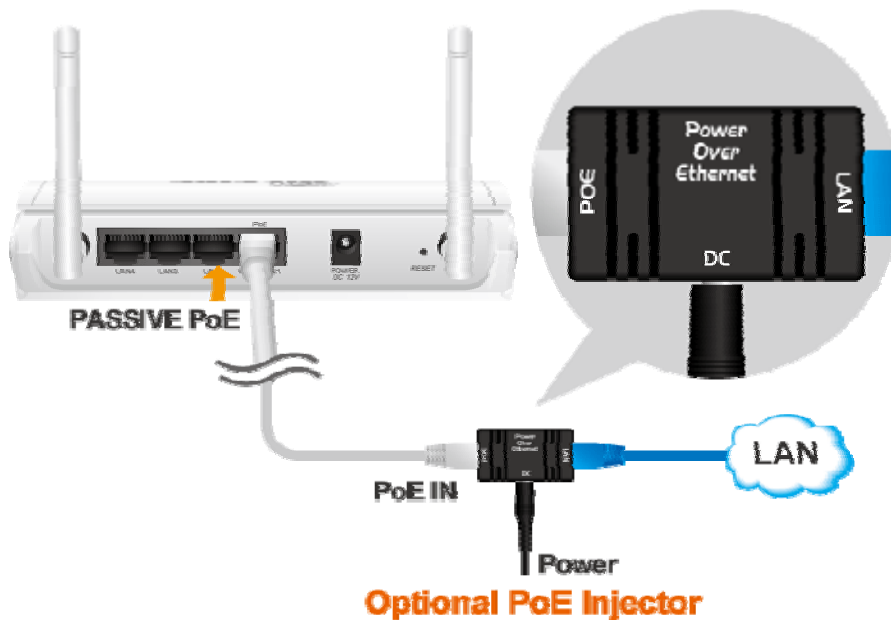

## 2.4.2 Wall Mount Installation

1. The holes for the wall mount screw are on the underside of the case. Please measure the distance between the holes. Then install 2 screws in the desire location with the measured distance apart from each other. Please do not screw all the way in, leave some space for mounting with the G.DUO



2. Now please hang the G.DUO on those 2 screws.





## 2.5 LED Table

This section describes the LED behavior of G.DUO. You can find the LED on the top side of the G.DUO.



### Power

- Steady Blue – Normal Operation
- OFF – No Power

### RF1, RF2

- Slow Flashing : Radio is active
- Fast Flashing: Transmitting Data
- OFF: Radio Disabled

### LAN1 ~4, WAN

- Steady Blue : Link established
- Fast Flashing: Transmitting Data
- OFF: No Link

## 2.6 Restore Settings to Default

If you have forgotten your G.DUO's IP address or password, you can restore your G.DUO to the default settings by pressing on the "reset button" for more than 5 seconds. You might need a pen or pencil for this operation. The reset button is inside the bottom case. Please see diagram below for details.

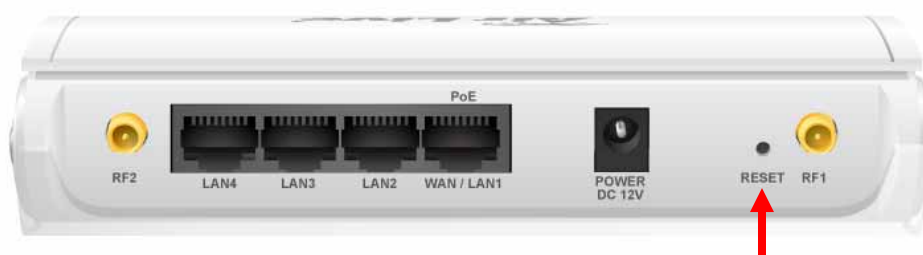

# 3

## Configuring the G.DUO

The G.DUO offers many different types of management interface. You can configure through standard web browser (http), secured web (https), command line (telnet), secured command shell (SSH), and SNMP management. In this chapter, we will explain G.DUO's available management interfaces and how to get into them.

### 3.1 Important Information

The following information will help you to get start quickly. However, we recommend you to read through the entire manual before you start. Please note the password and SSID are case sensitive.

- The default IP address is: 192.168.1.254 Subnet Mask: 255.255.255.0
- There is no password protection by default. To enable password protection, please go to "System Configuration -> Password Settings".
- The default SSID for Radio1 is "airlive1"
- The default SSID for Radio2 is "airlive2"
- The default wireless mode is : WISP + AP mode
- Please remember to "Apply Change" for settings to be saved and take effect.
- Please remember to "Reboot" the device after all settings are changed.
- Please keep the TX output power as low as possible for best performance.
- By default, the Telnet and SSH functions are turned off. To enable them, please go to "System Configuration" -> "System Management" menu.
- The Emergency Firmware Recovery only works when you connect to LAN2, LAN3, or LAN4 port. It will not work on LAN1
- By Default, the DHCP server is turned on in WISP+AP and Gateway+AP mode. The other modes' DHCP server are turned off.
- When you change the mode to WISP+AP or Gateway+AP mode, the GDUO's IP address might change to 192.168.1.254.

## 3.2 Prepare your PC

The G.DUO can be managed remotely by a PC through either the wired or wireless network. The default IP address of the G.DUO is **192.168.1.254** with a *subnet mask* of 255.255.255.0. This means the IP address of the PC should be in the range of 192.168.1.1` to 192.168.1.253.

To prepare your PC for management with the G.DUO, please do the following:

1. Connect your PC directly to the LAN port on the DC Injector of G.DUO
2. Set your PC's IP address to "Obtain an IP address Automatically". The G.DUO should provide your PC an valid IP address.
3. If you want to set your PC's IP address manually, please set to 192.168.1.50 (or other address in the same subnet)

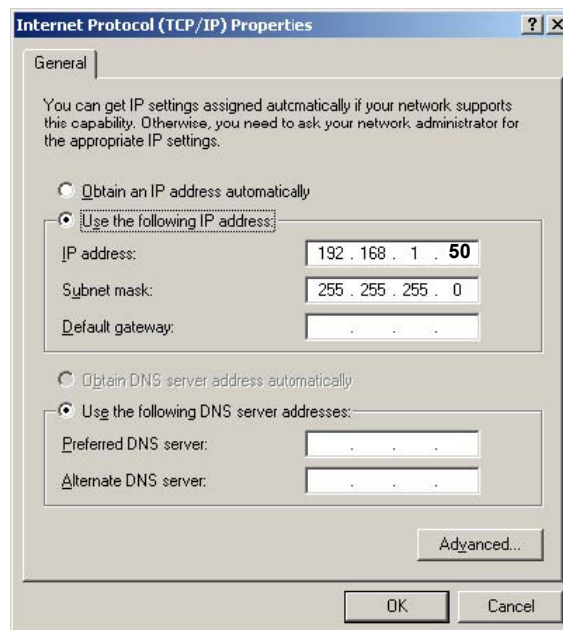

You are ready now to configure the G.DUO using your PC.

## 3.3 Management Interface

The G.DUO can be configured using one the management interfaces below:

- **Web Management (HTTP):** You can manage G.DUO by simply typing its IP address in the web browser. Most functions of G.DUO can be accessed by web management interface. We recommend using this interface for initial configurations. To begin, simply enter G.DUO's IP address (default is 192.168.1.254) on the web browser..

- **Secured Web Management (HTTPS):** HTTPS is also using web browser for configuration. But all the data transactions are securely encrypted using SSL encryption. Therefore, it is a safe and easy way to manage your G.DUO. We highly recommend WISP and service provider to use HTTPS for management.

To begin, simply enter <https://192.168.1.254> on your web browser. A security alert screen from your browser might pop up. Please grant all permission and get certificate to G.DUO.

- **Command Line Interface (Telnet):** G.DUO can be managed through the command line interface (CLI). Telnet does not encrypt its message. Therefore, it is not secure. The default Telnet management port is TCP port 23.

*By default, the G.DUO's Telnet interface is turned off.* To enable it, please go to "System Configuration -> System Management" menu and enable "Telnet".

To use the CLI, please open the command line window. Then type "telnet 192.168.1.254" to start.



```
C:\ Command Prompt
Microsoft Windows XP [Version 5.1.2600]
(C) Copyright 1985-2001 Microsoft Corp.

C:\Documents and Settings\Administrator> Telnet 192.168.1.254
```

To get a list of available command and their usage, please type "help" on the command prompt.

- **Secure Shell (SSH, SSH2):** SSH is an encrypted Command Line Interface that allow user to send text commands through SSL encryption. Therefore, it provides the added advantage of security comparing to Telnet. The default management port for SSH/SSH2 is TCP/UDP port 22.

*By default, the G.DUO's SSH/SSH2 interface is turned off.* To enable it, please go to "System Configuration -> System Management" menu and enable "SSH".

To manage via the SSH/SSH2 protocol, you would need a SSH client. Free SSH clients are widely available on the Internet. You can find where to download them by using Internet search engine such as Google. In this guide, we will use a popular SSH/Telnet utility call Putty.

Once you have download and install Putty. Please follow the figure below to make a connection with G.DUO:

1. Choose "SSH" as indicated in the diagram

2. Enter the IP address of G.DUO
3. Click on “Open” to start the SSH session.

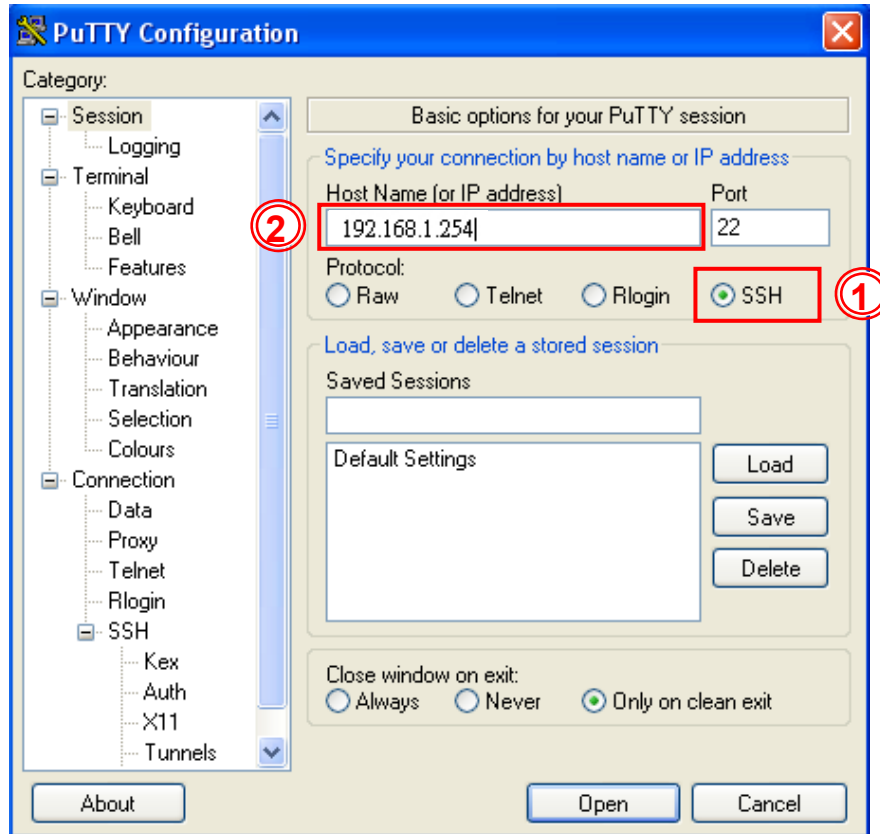

When the following screen appear, click on “Yes” to continue



If you have set up password, please enter your login and password. If not, you will enter the command prompt directly. Now you are ready to enter commands

To get a list of available command and their usage, please type “help” on the command prompt.

## 3.4 Introduction to Web Management

The G.DUO offers both normal (http) and secured (https) Web Management interfaces. Their share the same interface and functions, and they can both be accessed through web browsers. The only difference is HTTPS data are encrypted for extra security. Therefore, we will discuss them together as “Web Management” on this guide.

If you are placing the G.DUO behind router or firewall, you might need to open virtual server ports to G.DUO on your firewall/router

- HTTP: TCP Port 80
- HTTPS: TCP/UDP Port 443

This procedure is not necessary in most cases unless there is a router/firewall between your PC and G.DUO.

### 3.4.1 Getting into Web Management

#### Normal Web Management (HTTP)

To get into the Normal Web Management, simply type in the G.DUO’s IP address (default IP is 192.168.1.254) into the web browser’s address field.

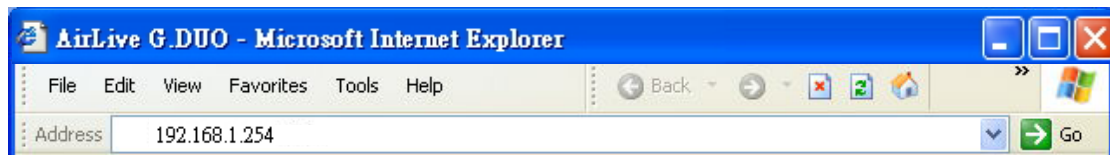

#### Secured Web Management (HTTPS)

To get into the Secured Web Management, just type “https://192.168.1.254 ” into the web browser’s address field. The “192.168.1.254” is G.DUO’s default IP address. If the IP address is changed, the address entered in the browser should change also.

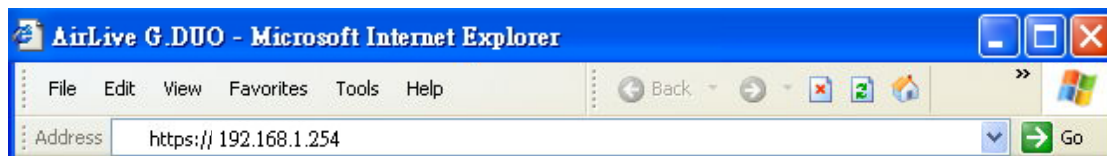

A security warning screen from your browser will then pop-up depending on the browser you use. Please follow step below to clear the security screen.

- Internet Explorer: Select “Yes” to proceed

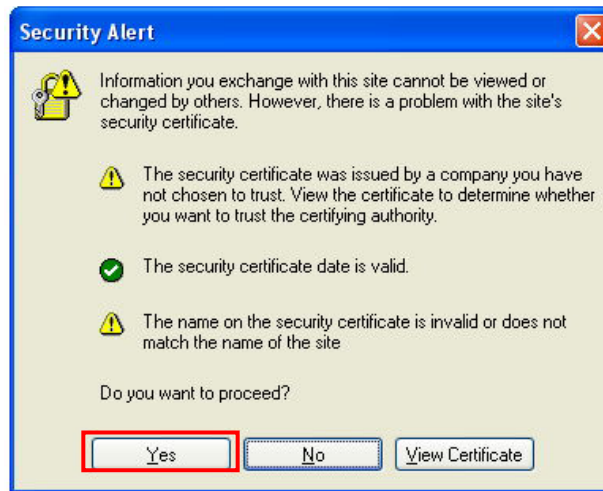

❑ Firefox:

1. Select “or you can add an exception”



2. Click on “Add Exception”





- Click on “Get Certificate”. Then, please enter G.DUO’s IP address. Finally, please click on “Confirm Security Exception.”



### 3.4.2 Web Menu Structure

After you enter the Web configuration, the following screen will appear:



- Wireless Settings:** The G.DUO’s wireless settings are different between wireless modes. Only functions that are applicable to the wireless mode will show to simplify configuration. For this reason, the first step to configure the G.DUO is to select the wireless mode. The router mode specific functions are also in this



menu category. For explanation of different wireless modes, please refer to Chapter 1.

- **System Configuration:** All non-wireless and router mode settings are in this category. The system configurations including changing password, upload firmware, backup configuration, settings PING watchdog, and setting management interface. We recommend you should enable password protection during the first time login.
- **Device Status:** This section for monitoring the status of G.DUO. It provides information on device status, Ethernet status, wireless status, wireless client table, and system log.
- **Language Selection:** You can change the language for the Web interface from here.

## 3.5 Initial Configurations

We recommend users to browse through G.DUO's web management interface to get an overall picture of the functions and interface. Below are the recommended initial configurations for first time login:

### 3.5.1 Choose the wireless Operation Modes

The wireless settings of G.DUO are dependant on the wireless operation mode you choose. Therefore, the first step is to choose the operation mode. For explanation on when to use what operation mode, please refer to Chapter 1

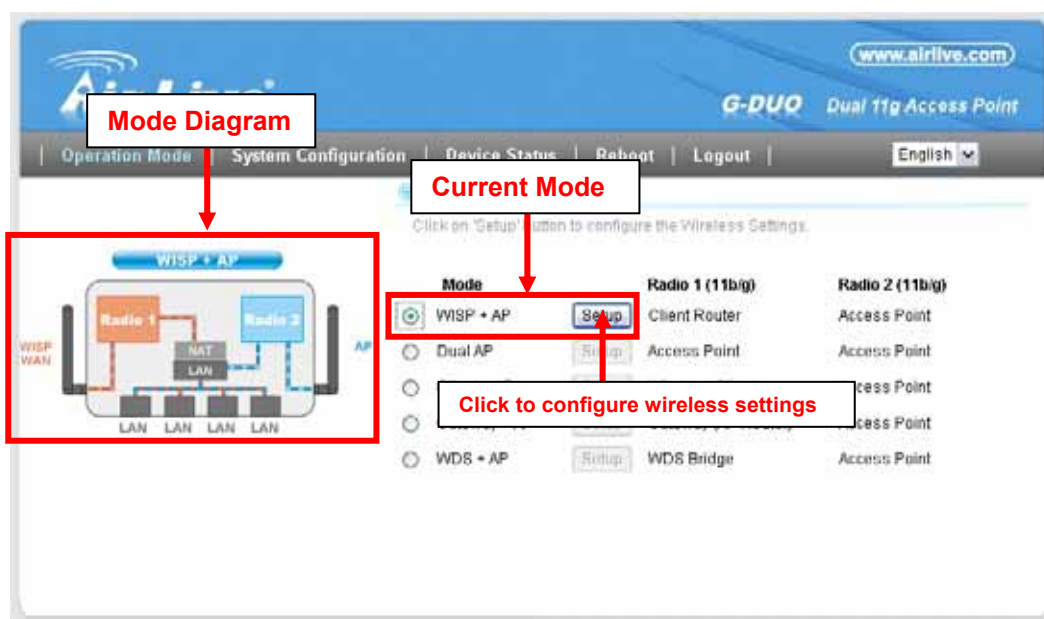

**Mode Diagram:** this shows you the operation flow between Radio1, Radio2, and the LAN/WAN ports. It helps you to understand how the mode works.

**Current Mode:** The active setup button indicates the current operation mode. When you press the “Setup Button”, it will bring you to the wireless setting page.

**Changing Mode:**

Follow the example below to change to “Gateway+AP” mode

1. Select “Gateway + AP” mode.
2. Click on “Setup Button” button
3. The AP might ask you to confirm the mode change. Once confirm, the AP will reboot to its new mode.

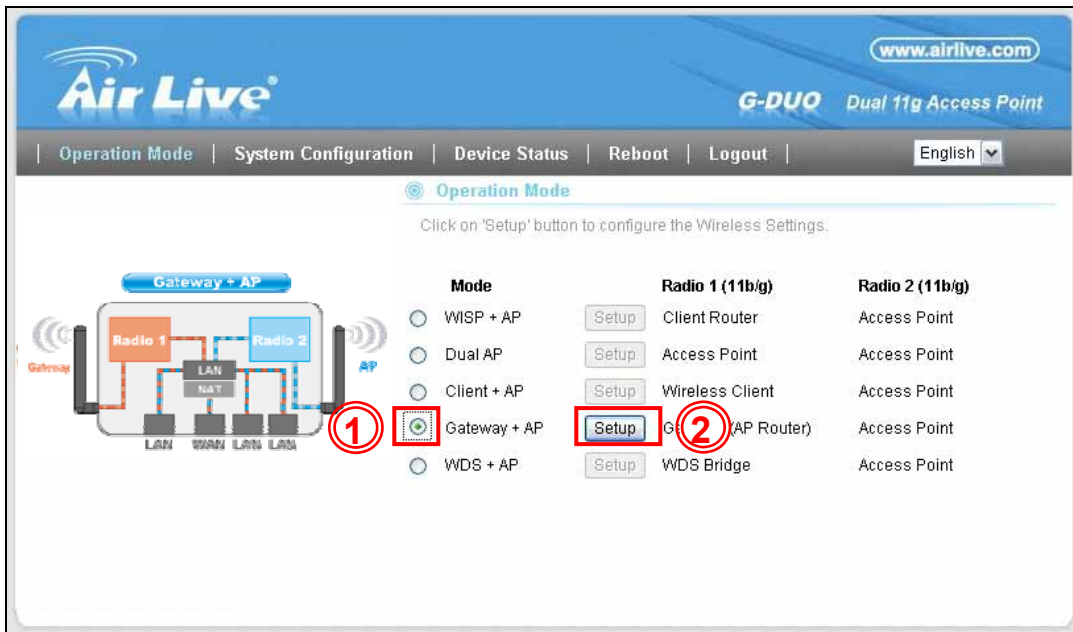

**3.5.2 Change the Device’s IP Address**

The default IP address is at 192.168.1.254. You should change it to the same subnet as your network. Also, if you want to manage G.DUO remotely, you have to set the Gateway and DNS server information.

To setup the IP settings for G.DUO, please select “System Configuration” -> LAN Interface Setup”. After entering the IP information, click on “Apply” to finish.

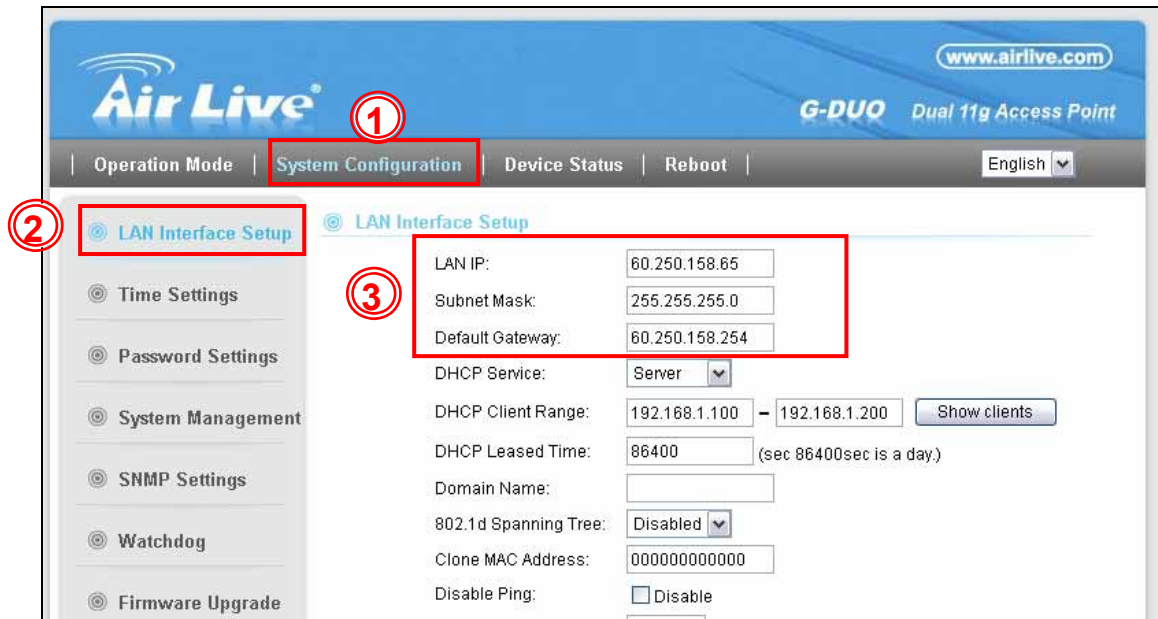

### 3.5.3 Enable Password Protection

The G.DUO's password protection is turned off by default. You should enable it and set your own password. To enable password protection, please go to "System Configuration" -> "Password Settings" menu. Then enter your username and password, and click on "Apply Change" button. You can also come to this menu to change your password in the future.



### 3.5.4 Enable Telnet or SSH

The Telnet and SSH management interface are turned off by default. If you wish to use them, please go to the "System Configuration -> System Management" menu. Check "Telnet" or "SSH", then click on "Apply Change" button.

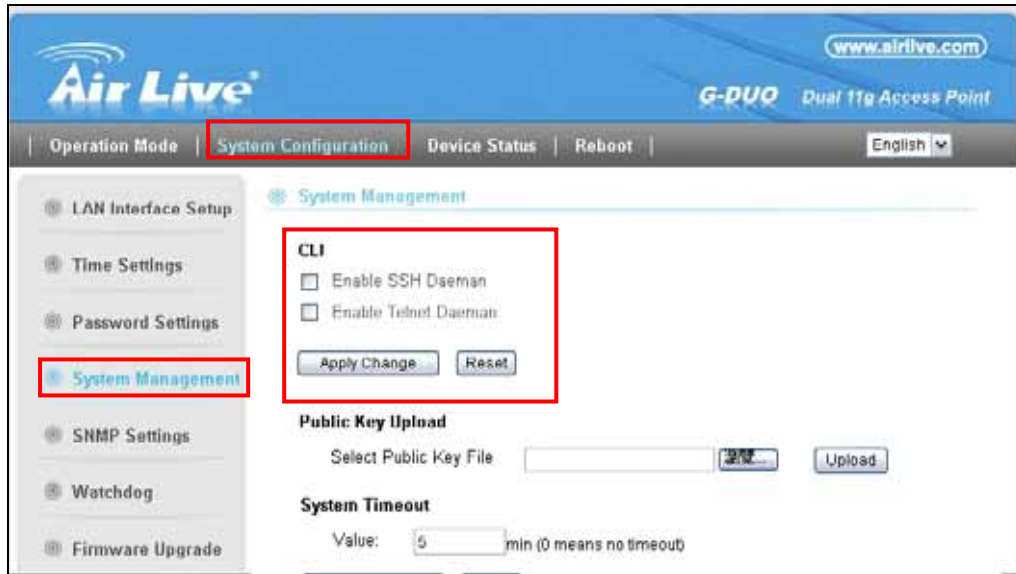

# 4

## WISP + AP Mode

In this chapter, we will explain about the wireless settings for WISP+AP Mode. Please be sure to read through Chapter 1.4 and Chapter 3's "Introduction to Web Management" and "Initial Configurations" first.

### 4.1 Application for WISP+AP Mode

This mode is designed for WISP subscriber to have both Internet connection to WISP AP and wireless network for home. Radio1 acts as a client router to connect with outdoor AP; Radio1 works as a wireless AP for home. This combination allows WISP subscriber to share their Internet connection wirelessly. In this mode, the WAN on the Radio1 side.

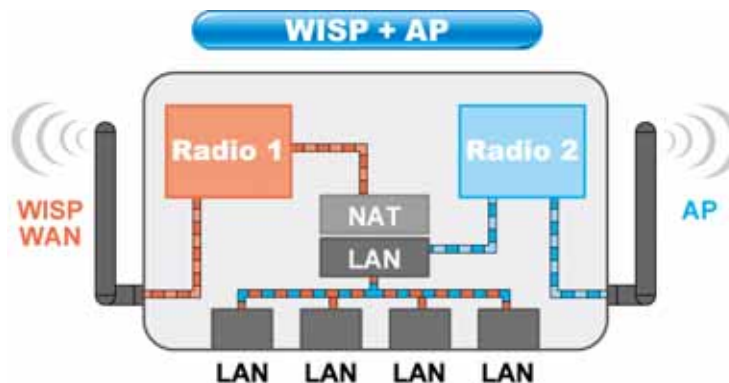
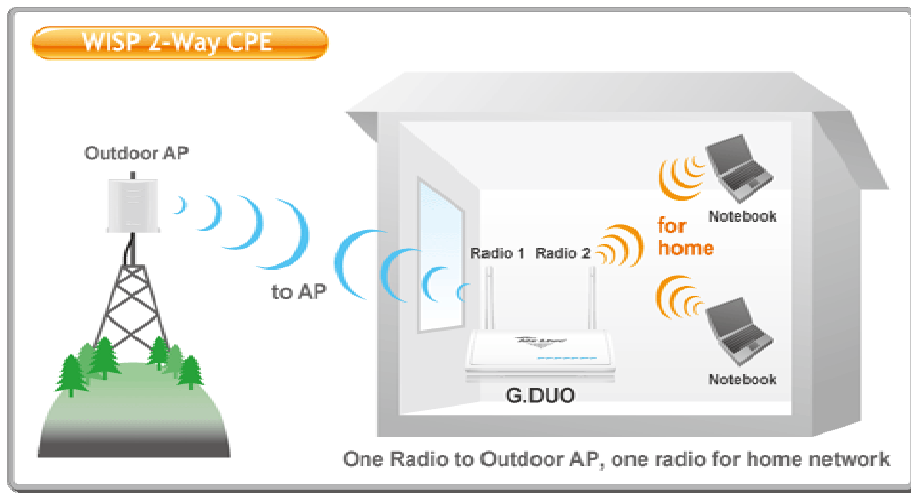

## 4.2 Step-by-Step Example

In this example, we will use a G.DUO to establish a connection service to the WISP outdoor AP



### 4.2.1 Environment

In this example, the G.DUO will be connecting to the Outdoor AP using Radio1. Radio1 will be running in WISP mode which is also known as “Client Router”. Radio 2 will be running in AP mode to share the WISP connection wirelessly to the notebook PC.

The configuration procedure should be as followed:

- 1. Configure Radio1 first.**
- Use “Site Survey” function to find the Outdoor AP and adjust antenna alignment using “Signal Survey” function
- Use “Site Survey” to establish connection and enter encryption key with Outdoor AP
- Configure the WAN type for the Radio1 to the Outdoor AP
- Enable the “Remote Management” so WISP operator can manage the AP from remote
- 6. Configure Radio2 now**
- You should be able to keep default settings for most of the Radio2’s function
- But you need to change the channel of Radio2 so it is as far apart from Radio1 as possible.
- Set Encryption for Radio2.
- You should be able to link the Notebook PC to “airlive2” SSID and enter the correct encryption key.

## 4.2.2 Configuration Steps

### Radio1

**Step1:** Click on the wireless settings on WISP+AP mode. It should bring you to the “Wireless Setting” Page.



**Step2:** Click on “Site Survey” Setup button. The following screen should appear with results of available APs in the area.

Radio 1 Site Survey							
SSID	BSSID	Channel	Type	Encrypt	Signal	Select	
airlive	00:4f:62:00:04:03	11 (B+G)	AP	no	43	<input type="radio"/>	
ggggway	00:4f:62:94:02:11	1 (B+G)	AP	WPA-PSK	40	<input type="radio"/>	
default	02:1b:77:00:8c:78	11 (B+G)	Ad hoc	no	21	<input type="radio"/>	
OutdoorAP	00:12:0e:b3:b2:b2	11 (B+G)	AP	WPA-PSK	10	<input checked="" type="radio"/>	

Refresh   Connect   Close   Signal Survey

**Step2:** Now select “Outdoor AP” on the list, then press “Signal Survey”. Adjust your antenna until the signal level is at the highest.

**Step3:** Now close the window and go back to the “Site Survey” page. Select the “Outdoor AP” and press the “Connect” button. The G.DUO will inform you “encryption type mismatch!” and ask if you want to configure the encryption setting. Select “Yes” to proceed.



**Step4:** Choose “WPA”->”Personal(Pre Shared Key)” -> “TKIP”. Then enter the correct encryption key. The wireless connection should establish after this.

**Step5:** Go to the wireless setting page and select “WAN Port”. Enter the WAN information (in this example is “Static IP”) and check the “Enable Web Access on WAN” for remote management.

**WAN Port**

---

WAN Access Type:

IP Address:

Subnet Mask:

Default Gateway:

MTU Size:  (1400-1500)

TTL:

TTL Value:  (1-255)

DNS 1:

DNS 2:

DNS 3:

Clone MAC Address:

Enable UPnP

Enable Ping Access on WAN

Enable Web Server Access on WAN

**Radio2**

**Step1:** Go to the wireless setting and change the interface to “Radio2”

**Step2:** Now we know the “Outdoor AP” is using Channel 11. Please set Radio2’s channel to as far as possible. In this case, it will be “Channel 1”.





**Step3:** Go to the “Security” setup and set your encryption as “WPA”->”Pre-Shared Key”->”TKIP”. Enter your encryption key. .

## 4.3 Radio1: WISP Router Mode Settings

The Radio1 is working in Client Mode with NAT routing function, it is also known as “Client Router”. The WAN is on the wireless side.

When you select “Radio1” as the interface, the following screen will appear.

<input type="checkbox"/>	Disable Wireless LAN Interface (1)
Band:	802.11 b/g
SSID:	airlive1
Channel:	Channel 1
Security:	Setup
Advance:	Setup
Access Control:	Setup
Associated Clients:	Show clients
WAN Port	Setup
Virtual Server	Setup
DMZ	Setup
DDNS	Setup
DoS	Setup
URL Filter	Setup
MAC Filter	Setup
IP Filter	Setup
Port Filter	Setup
Router	Setup
RIP	Setup
<input type="button" value="Apply Change"/> <input type="button" value="Reset"/>	

### 4.3.1 Basic Wireless Settings

- **Band:** You can choose between “802.11g/b”, “802.11g”, or “802.11b”. We recommend to leave the setting at “802.11g/b”.
- **SSID:** The SSID setting of the remote AP. If you are not sure, you can click on “Site Survey” button to scan for AP.
- **Channel:** Wireless Channel used. For EU, it is channel 1~13. For U.S.A., it is channel 1~11. For Client and WISP mode, this field is applicable only in Adhoc mode.

## 4.3.2 Security Settings

### Operation Mode -> Setup -> Security Settings

Security settings allow you to use encryption to secure your data from eavesdropping. You can select different security policy to provide association authentication and/or data encryption. The G.DUO features various security policies including WEP, 802.1x, WPA, WPA Personal, WPA2, WPA2 Personal, WPA Mixed.

## WEP

WEP Encryption is the oldest and most available encryption method. However, it is also the least secure.

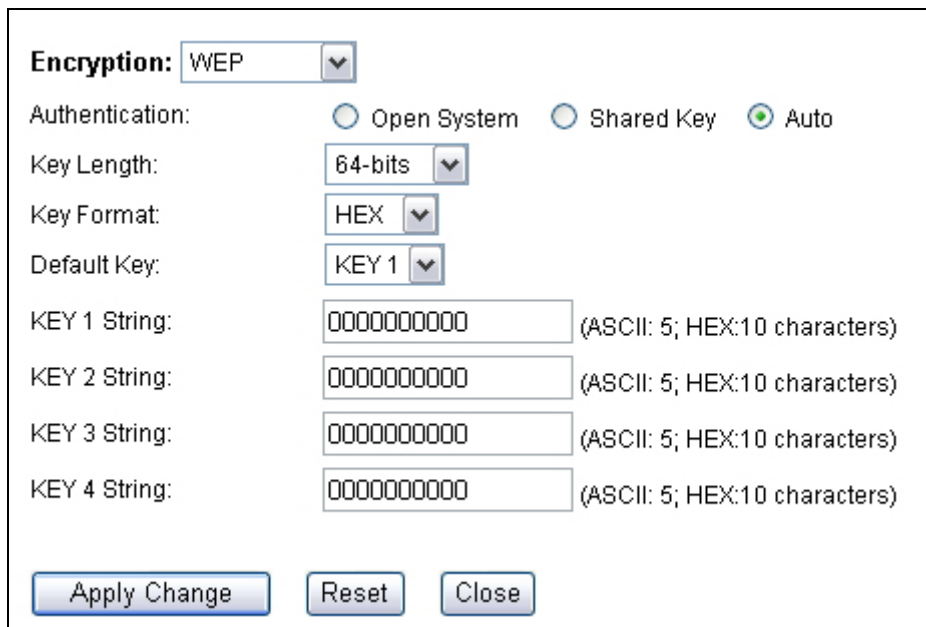

The screenshot shows a configuration window for WEP encryption. The 'Encryption' dropdown is set to 'WEP'. Under 'Authentication', the 'Auto' radio button is selected. 'Key Length' is set to '64-bits', 'Key Format' is 'HEX', and 'Default Key' is 'KEY 1'. There are four text input fields for 'KEY 1 String', 'KEY 2 String', 'KEY 3 String', and 'KEY 4 String', each containing '0000000000' and followed by the text '(ASCII: 5; HEX:10 characters)'. At the bottom, there are three buttons: 'Apply Change', 'Reset', and 'Close'.

- **Select one of the WEP key for wireless network:** There are total of 4 possible keys for WEP encryption. You need to choose which key will be used for encryption. All wireless devices on the same network have to use the same settings. We recommend using WEP Key 1 as in default setting.
- **Authentication:** 2 types of Authentication are offered. Open system and Shared key. If you are not sure which one to use, please select "Auto".
- **Key Length:** The G.DUO offers 64bit and 128 bit for WEP key length. The longer the Key Length, the more secure the encryption is.
- **Key Type:** 2 types are available: ASCII and HEX. ASCII is a string of ASCII code including alphabetical characters, space, signs and numbers (i.e. "airlivepass12"). HEX is a string of 16-bit hexadecimal digits (0..9, a, b, c, d, e, f). All wireless devices on the network must match the exact key length and Key type. Some Wireless clients only allow HEX type for WEP.
- **ASCII-64:** This is a key with 64-bit key length of ASCII type. Please enter **5**

ASCII Characters if you choose this option. For example, “passw”

- **HEX-64:** This is a key with 64-bit key length of HEX type. Please enter **10** Hexadecimal digits if you choose this option. For example, “12345abcdef”
- **ASCII-128:** This is a key with 64-bit key length of ASCII type. Please enter **13** ASCII Characters if you choose this option. For example, “airlivewepkey”
- **HEX-128:** This is a key with 128-bit key length of HEX type. Please enter **26** Hexadecimal digits if you choose this option. For example, “1234567890abcdef1234567890”

## WPA-PSK, WPA2-PSK, WPA-AUTO

Wi-Fi Protected Access (WPA) introduces the Temporal Key Integrity Protocol (TKIP) that provides added security. WPA2 adds full support for 802.11i standard and the CCMP (AES Encryption). The WPA Mixed tries to authenticate wireless clients using both WPA-PSK or WPA2-PSK.

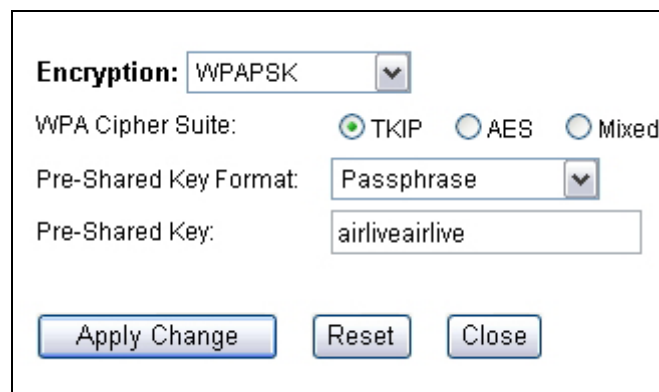

The screenshot shows a configuration window for WPA settings. It includes a dropdown menu for 'Encryption' set to 'WPAPSK', radio buttons for 'WPA Cipher Suite' with 'TKIP' selected, a dropdown for 'Pre-Shared Key Format' set to 'Passphrase', and a text input field for 'Pre-Shared Key' containing 'airliveairlive'. At the bottom are buttons for 'Apply Change', 'Reset', and 'Close'.

- **Encryption Type:** There are two encryption types **TKIP** and **CCMP (AES)**. While CCMP provides better security than TKIP, some wireless client stations may not be equipped with the hardware to support it. You can select **Mixed** to allow TKIP clients and CCMP clients to connect to the Access Point at the same time.
- **Pre-Shared Key Format:** You can select between Passphrase(ASCII) or HEX format. Please select Passphrase if you are not sure what to use.
- **Pre-Shared Key:** Enter the password key here..

### 4.3.3 Advance (Wireless Settings)

*Operation Mode -> Setup -> Advance*

Fragment Threshold:	<input type="text" value="2346"/>	(256-2346)
RTS Threshold:	<input type="text" value="2347"/>	(0-2347)
Beacon Interval:	<input type="text" value="100"/>	( 20-1024; unit 1ms)
Ack Timeout:	<input type="text" value="0"/>	(0-255; unit 4us) <input type="button" value="Calculation"/>
Preamble Type:	<input checked="" type="radio"/> Long Preamble: <input type="radio"/> Short Preamble:	
IAPP:	<input checked="" type="radio"/> Enable <input type="radio"/> Disable	
BG Protection:	<input checked="" type="radio"/> Enable <input type="radio"/> Disable	
Hide SSID:	<input type="checkbox"/> Enable	
Tx Power Level:	<input type="text" value="Level 12 (About 21.0dB)"/>	
LED Mode:	<input checked="" type="radio"/> Traffic Mode: <input type="radio"/> Signal Mode:	
<input type="button" value="Apply Change"/> <input type="button" value="Reset"/> <input type="button" value="Close"/>		

- **Fragmentation:** When the size of a unicast frame exceeds the fragmentation threshold, it will be fragmented before the transmission. It should have a value of 256-2346 bytes, with a default of 2346. If you experience a high packet error rate, you should slightly decrease the Fragmentation Threshold.
- **RTS Threshold:** RTS/CTS frames are used to gain control of the medium for transmission. Any unicast (data or control) frames larger than specified RTS threshold must be transmitted following the RTS/CTS handshake exchange mechanism. The RTS threshold should have a value between 256-2347 bytes, with a default of **2347**. It is recommended that this value does not deviate from the default too much.
- **Beacon Interval:** The device broadcasts beacon frames regularly to announce its existence. The beacon Interval specifies how often beacon frames are transmitted in time unit of milliseconds. The default value is **100**, and a valid value should be between 1 and 65,535.
- **AckTimeOut:** When a packet is sent out from one wireless station to the other, it will wait for an Acknowledgement frame from the remote station. The station will only wait for a certain amount of time, this time is called the ACK timeout. In most conditions, please put ACKtimeout value at zero(default value). The AP will calculate the ACKtimeout automatically when the value is zero. However, you can also enter the ACKtimeout manually.
- **Preamble Type:** A preamble is a signal used in wireless environment to synchronize the transmitting timing including Synchronization and Start frame delimiter. In a "noisy" network environment, the Preamble Type should be set to Long Preamble. The Short Preamble is intended for applications where minimum overhead and maximum

performance is desired. If in a "noisy" network environment, the performance will be decreased.

- **IAPP:** IAPP (Inter Access Point Protocol) is designed for the enforcement of unique association throughout a ESS (Extended Service Set) and a secure exchange of station's security context between current access point (AP) and new AP during handoff period.
  
- **BG Protection:** The 802.11g standard includes a protection mechanism to ensure mixed 802.11b and 802.11g operation. If there is no such kind of mechanism exists, the two kinds of standards may mutually interfere and decrease network's performance..
  
- **Hide SSID:** Enable Hide SSID will make the AP network's SSID invisible. A device can link with the AP only if correct SSID name is entered.
  
- **TX Power Level:** You can set your TX Output power level here. Please note the maximum allowable TX output power in EU is 20dBm. Please do not exceed your country's legal limit.

### 4.3.4 Site Survey

#### Operation Mode -> Setup -> Site Survey

You can scan for wireless networks around your location using the Site Survey function. From the site survey function, you can also perform antenna alignment and establish wireless connection

When you click on Site Survey, the following screen will appear. It might take awhile depending on number of available APs in the area.

SSID	BSSID	Channel	Type	Encrypt	Signal	Select
airlive	00:4f:62:00:04:03	11 (B+G)	AP	no	43	<input type="radio"/>
ggggway	00:4f:62:94:02:11	1 (B+G)	AP	WPA-PSK	40	<input type="radio"/>
default	02:1b:77:00:8c:78	11 (B+G)	Ad hoc	no	21	<input type="radio"/>
OutdoorAP	00:12:0e:b3:b2:b2	11 (B+G)	AP	WPA-PSK	10	<input checked="" type="radio"/>

Refresh

Connect

Close

Signal Survey

Click here to select SSID for Association or Signal Survey

To connect with the selected SSID. This function is available only in Client Infrastructure or Bridge Infrastructure

For antenna alignment. It will display and update the Signal Strength continuously

### 4.3.5 Signal Survey

**Operation Mode -> Setup -> Site Survey -> Signal Survey**

The Signal Survey will continuously display the SIGNAL STRENGTH value of the selected SSID for antenna alignment purpose. To use Signal Survey function, please enter the “Site Survey” function first; please refer to the instruction in the above section. Once you select the ESSID and click on the “Signal Survey” button, the following screen will appear.

Signal Survey					
SSID	BSSID	Channel	Type	Encrypt	Signal
airlive2	00:e0:4c:81:86:23	11 (B+G)	AP	no	24

- **BSSID:** This is the remote AP’s MAC address.
- **Channel:** The current scanned channel
- **Signal Strength:** This is signal strength number in percentage in 0 to 100 scale. The higher the number, the better signal.

### 4.3.6 WAN Port

**Operation Mode -> Setup -> WAN Port**

The G.DUO support different authentication and IP assignment standards for the WAN port. It includes fixed IP, DHCP, PPPoE, PPTP, L2TP, and Big Pond protocols. Please consult with your ISP about what authentication type is used for the WAN port connection.

**WAN Port**

---

WAN Access Type:

Host Name:

MTU Size:  (1400-1492)

TTL:

TTL Value:  (1-255)

Attain DNS Automatically  
 Set DNS Manually

DNS 1:

DNS 2:

DNS 3:

Clone MAC Address:

Enable UPnP  
 Enable Ping Access on WAN  
 Enable Web Server Access on WAN  
 Enable IPsec pass through on VPN connection  
 Enable PPTP pass through on VPN connection  
 Enable L2TP pass through on VPN connection

- **Clone MAC Address:** In this place, you can assign a MAC address for the WAN port. In case of WISP mode, it is Radio1's MAC address. For Gateway mode, it is the WAN/LAN1 MAC address.
- **Enable UPnP:** Check this field will enable Universal Plug n Play protocol
- **Enable Web Server Access on WAN:** Check this field will enable remote management from WAN side.

### 4.3.7 Virtual Server Settings

Virtual server allows you to specify one or more applications running on server computers on the LAN that may be accessed by any Internet user. Internet data destined for the specified public port will be directed to the specified private port number on the LAN client with the specified private IP address.

If you want to allow your web server, ftp server, or email server to be accessible from Internet, you would need to open specific port on the virtual server to your local IP address.

**Virtual Server**

---

Enable	Internal Server IP	Protocol	Incomming Port Range	Internal Port Range	Description
<input checked="" type="checkbox"/>	192.168.1.100	BOTH	80 - 80	80 - 80	Web server
<input type="checkbox"/>	0.0.0.0	TCP	0 - 0	0 - 0	
<input type="checkbox"/>	0.0.0.0	TCP	0 - 0	0 - 0	
<input type="checkbox"/>	0.0.0.0	TCP	0 - 0	0 - 0	
<input type="checkbox"/>	0.0.0.0	TCP	0 - 0	0 - 0	
<input type="checkbox"/>	0.0.0.0	TCP	0 - 0	0 - 0	
<input type="checkbox"/>	0.0.0.0	TCP	0 - 0	0 - 0	
<input type="checkbox"/>	0.0.0.0	TCP	0 - 0	0 - 0	

For a list of most frequent used TCP and UDP ports. Please visit [http://en.wikipedia.org/wiki/List\\_of\\_TCP\\_and\\_UDP\\_port\\_numbers](http://en.wikipedia.org/wiki/List_of_TCP_and_UDP_port_numbers)

### 4.3.8 DMZ

#### Advanced Settings >> Multiple DMZ

DMZ opens all TCP/UDP ports to particular IP address on the LAN side. It allows setting up servers behind the G.DUO.

### Demilitarized Zone

---

**Enable DMZ**

DMZ Host IP Address:

### 4.3.9 DDNS

Dynamic Domain Name System. An algorithm that allows the use of dynamic IP address for hosting Internet Server. A DDNS service provides each user account with a domain name. The G.DUO support “Dyndns” and “TZO” service.

### Dynamic DNS

---

**Eneable DDNS**

Service Provider:

Domain Name:

User Name/Email:

Password/Key:

Result:

*Note:*  
 For TZO, you can have a 30 days free trial [here](#) or manage your TZO account in [control panel](#)  
 For DynDNS, you can create your DynDNS account [here](#)

### 4.3.10 DoS (Denial of Service)

Denial of Service is a type of network attack that floods the network with useless traffic. Many DoS attacks, such as the Ping of Death and Teardrop attacks, exploit limitations in the TCP/IP protocols.

The G.DUO provides a list of Firewall grade DoS control that protect your network from hacker attack.



### 4.3.11 URL Filter

The G.DUO provide URL filter function to stop access to certain website. It is especially useful for parents to stop children from accessing some websites.

#### URL Filter

---

**Enable URL Filtering**

URL String

**Current Filter Table:**

URL String	Select
	<input type="button" value="Delete Selected"/> <input type="button" value="Delete All"/> <input type="button" value="Reset"/>

### 4.3.12 MAC Filter

MAC filter can filter out traffic from certain MAC addresses. It can prevent access to internet from certain station in the local LAN.

#### MAC Filtering

---

**Enable MAC Filtering**

MAC Address:

Comment:

**Current Filter Table:**

MAC Address	Comment:	Select
00:4f:55:11:55:33	Localdevice	<input type="checkbox"/>

### 4.3.13 IP Filter

IP filtering allows you to block certain IP addresses from accessing the network.

#### IP Filter

---

**Enable IP Filtering**

Local IP Address:

Protocol: Both ▼

Comment:

**Current Filter Table:**

Local IP Address	Protocol	Comment	Select
<input type="button" value="Delete Selected"/> <input type="button" value="Delete All"/> <input type="button" value="Reset"/>			

### 4.3.14 Port Filter

Port filtering allows you to block certain applications from accessing the network.

#### Port Filtering

---

**Enable Port Filtering**

Port Range:  -

Protocol: Both ▼

Comment:

**Current Filter Table:**

Port Range	Protocol	Comment	Select
<input type="button" value="Delete Selected"/> <input type="button" value="Delete All"/> <input type="button" value="Reset"/>			

### 4.3.15 Router (Static Route)

This allows you to manually configure static network routes. Static routes will override routes learned by standard routing protocol discover methods.

### Static Route

---

**Enable Routing rules**

Host Name:

Password:

Management Port:

**Static Route rule setup**

Destination Address:  (xxx.xxx.xxx.xxx)

Sub Mask:  (xxx.xxx.xxx.xxx)

Gateway:  (xxx.xxx.xxx.xxx)

### 4.3.16 RIP (Routing Information Protocol)

#### *Operation Mode -> Setup -> Access Control*

The Routing Information Protocol (RIP) is a dynamic routing protocol used in local and wide area networks

### RIP

---

**Enable RIP**

Host Name:

Password:

Management Port:

**Setup RIP Interface**

Wan Port

Lan Port

## 4.4 Radio2: AP Mode Settings

The Radio2 is working in Access Point Mode. The default SSID is “AirLive2”. When you select “Radio2” as the interface, the following screen will appear:



**Wireless Settings**

Interface: RADIO 2 (AP) ▼

Disable Wireless LAN Interface (2)

Band: 802.11 b/g ▼

SSID: airlive2

Channel: Channel 11 ▼

Security: Setup

Advance: Setup

Access Control: Setup

Associated Clients: Show clients

Apply Change    Reset

### 4.4.1 Basic Wireless Settings

- **Band:** You can choose between “802.11g/b”, “802.11g”, or “802.11b”. We recommend leaving the setting at “802.11g/b”.
- **SSID:** The SSID setting of the remote AP. If you are not sure, you can click on “Site Survey” button to scan for AP.
- **Channel:** Wireless Channel used. For EU, it is channel 1~13. For U.S.A., it is channel 1~11.

### 4.4.2 Security Settings

#### **Operation Mode -> Setup -> Security Settings**

Security settings allow you to use encryption to secure your data from eavesdropping. You can select different security policy to provide association authentication and/or data encryption. The G.DUO features various security policies including WEP, 802.1x, WPA, WPA Personal, WPA2, WPA2 Personal , WPA Mixed.

## WEP

WEP Encryption is the oldest and most available encryption method. However, it is also the least secure.

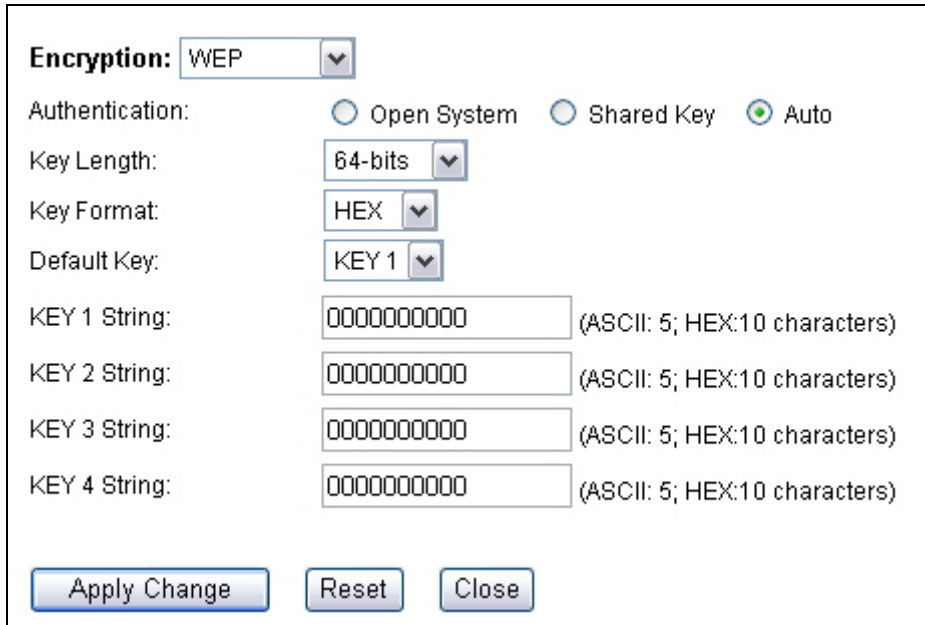

- **Select one of the WEP key for wireless network:** There are total of 4 possible keys for WEP encryption. You need to choose which key will be used for encryption. All wireless devices on the same network have to use the same settings. We recommend using WEP Key 1 as in default setting.
  
- **Authentication:** 2 types of Authentication are offered. Open system and Shared key. If you are not sure which one to use, please select “Auto”.
- **Key Length:** The G.DUO offers 64bit and 128 bit for WEP key length. The longer the Key Length, the more secure the encryption is.
- **Key Type:** 2 types are available: ASCII and HEX. ASCII is a string of ASCII code including alphabetical characters, space, signs and numbers (i.e. “airlivepass12”). HEX is a string of 16-bit hexadecimal digits (0..9, a, b, c, d, e, f). All wireless devices on the network must match the exact key length and Key type. Some Wireless clients only allow HEX type for WEP.
- **ASCII-64:** This is a key with 64-bit key length of ASCII type. Please enter **5** ASCII Characters if you choose this option. For example, “passw”
- **HEX-64:** This is a key with 64-bit key length of HEX type. Please enter **10** Hexadecimal digits if you choose this option. For example, “12345abcdef”
- **ASCII-128:** This is a key with 64-bit key length of ASCII type. Please enter **13** ASCII Characters if you choose this option. For example, “airlivewepkey”
- **HEX-128:** This is a key with 128-bit key length of HEX type. Please enter **26** Hexadecimal digits if you choose this option. For example,

“1234567890abcdef1234567890”

## WPA-Personal, WPA2-Personal, WPA-Mixed (Pre-Shared Key)

The WPA Personal is also known as “WPA-PSK” encryption. Wi-Fi Protected Access (WPA) introduces the Temporal Key Integrity Protocol (TKIP) that provides added security. WPA2 adds full support for 802.11i standard and the CCMP (AES Encryption). The WPA-Mixed tries to authenticate wireless clients using both WPA-PSK or WPA2-PSK.

### Radio 2 Security Setup

---

Encryption:

Authentication:

WPA Cipher Suite:  TKIP  AES  Mixed

Pre-Shared Key Format:

Pre-Shared Key:

- **Encryption Type:** There are two encryption types **TKIP** and **CCMP (AES)**. While CCMP provides better security than TKIP, some wireless client stations may not be equipped with the hardware to support it. You can select **Mixed** to allow TKIP clients and CCMP clients to connect to the Access Point at the same time.
- **Pre-Shared Key Format:** You can select between Passphrase(ASCII) or HEX format. Please select Passphrase if you are not sure what to use.
- **Pre-Shared Key:** Enter the password key here..

## WPA-Enterprise, WPA2-Enterprise, WPA-Mixed Enterprise (Radius)

Wi-Fi Protected Access (WPA) Enterprise uses Radius Server as the authenticator. WPA2 adds full support for 802.11i standard and the CCMP (AES Encryption). The WPA-Mixed tries to authenticate wireless clients using both WPA or WPA2.

Encryption:	WPA	▼
Authentication:	Enterprise(RADIUS) ▼	
WPA Cipher Suite:	<input checked="" type="radio"/> TKIP <input type="radio"/> AES <input type="radio"/> Mixed	
Server IP Address:	0.0.0.0	(xxx.xxx.xxx.xxx)
Server Port:	1812	(1024-65535)
Server Password:	<input type="text"/>	
<input type="button" value="Apply Change"/> <input type="button" value="Reset"/> <input type="button" value="Close"/>		

### 4.4.3 Advance (Wireless Settings)

**Operation Mode -> Setup -> Advance**

Fragment Threshold:	2346	(256-2346)
RTS Threshold:	2347	(0-2347)
Beacon Interval:	100	( 20-1024; unit 1ms)
Ack Timeout:	0	(0-255; unit 4us) <input type="button" value="Calculation"/>
Preamble Type:	<input checked="" type="radio"/> Long Preamble: <input type="radio"/> Short Preamble:	
IAPP:	<input checked="" type="radio"/> Enable <input type="radio"/> Disable	
BG Protection:	<input checked="" type="radio"/> Enable <input type="radio"/> Disable	
Hide SSID:	<input type="checkbox"/> Enable	
Isolation:	<input type="checkbox"/> Enable	
Tx Power Level:	Level 6 (About 14.4dB) ▼	
<input type="button" value="Apply Change"/> <input type="button" value="Reset"/> <input type="button" value="Close"/>		

- **Fragmentation:** When the size of a unicast frame exceeds the fragmentation threshold, it will be fragmented before the transmission. It should have a value of 256-2346 bytes, with a default of 2346. If you experience a high packet error rate, you should slightly decrease the Fragmentation Threshold.
- **RTS Threshold:** RTS/CTS frames are used to gain control of the medium for transmission. Any unicast (data or control) frames larger than specified RTS threshold must be transmitted following the RTS/CTS handshake exchange mechanism. The RTS threshold should have a value between 256-2347 bytes, with a default of **2347**. It is recommended that this value does not deviate from the default too much.

- **Beacon Interval:** The device broadcasts beacon frames regularly to announce its existence. The beacon Interval specifies how often beacon frames are transmitted in time unit of milliseconds. The default value is **100**, and a valid value should be between 1 and 65,535.
- **AckTimeOut:** When a packet is sent out from one wireless station to the other, it will wait for an Acknowledgement frame from the remote station. The station will only wait for a certain amount of time, this time is called the ACK timeout. In most conditions, please put ACKtimeout value at zero(default value). The AP will calculate the ACKtimeout automatically when the value is zero. However, you can also enter the ACKtimeout manually.
- **Preamble Type:** A preamble is a signal used in wireless environment to synchronize the transmitting timing including Synchronization and Start frame delimiter. In a "noisy" network environment, the Preamble Type should be set to Long Preamble. The Short Preamble is intended for applications where minimum overhead and maximum performance is desired. If in a "noisy" network environment, the performance will be decreased.
- **IAPP:** IAPP (Inter Access Point Protocol) is designed for the enforcement of unique association throughout a ESS (Extended Service Set) and a secure exchange of station's security context between current access point (AP) and new AP during handoff period.
- **BG Protection:** The 802.11g standard includes a protection mechanism to ensure mixed 802.11b and 802.11g operation. If there is no such kind of mechanism exists, the two kinds of standards may mutually interfere and decrease network's performance..
- **Hide SSID:** Enable Hide SSID will make the AP network's SSID invisible. A device can link with the AP only if correct SSID name is entered.
- **Isolation:** Enable Isolation will prevent wireless clients to see each other on the network.
- **TX Power Level:** You can set your TX Output power level here. Please note the maximum allowable TX output power in EU is 20dBm. Please do not exceed your country's legal limit.

#### 4.4.4 Access Control

##### ***Operation Mode -> Setup -> Access Control***

The G.DUO allows you to define a list of MAC addresses that are allowed or denied to



access the wireless network. This function is available only for Access Point and Gateway modes.

**Access Control Mode:** Disable

**Add Access Control Rule:**

MAC Address:  (xxxxxxxxxxxxxx)

Comment:

**Current Access Control List**

MAC Address:	Comment	Select
<input type="button" value="Delete Selected"/> <input type="button" value="Delete All"/>		

■ **Access Control List**

- **Disable:** When selected, no MAC address filtering will be performed.
- **Allow list:** When selected, data traffic from only the specified devices in the table will be allowed in the network.
- **Deny list:** When selected, data traffic from the devices specified in the table will be denied/discarded by the network.

### 4.4.5 Associated Clients

Click on this to show the current wireless clients associated to the AP. It will display MAC addresss, Trasmit packet, Tx rate, power saving, expire time, and signal strength.

MAC Address	Tx Packet	Tx Rate (Mbps)	Tx Rate (Mbps)	Power Saving	Expired Time (s)	RSSI
None	---	---	---	---	---	---

# 5

## Dual AP Mode

In this chapter, we will explain about the wireless settings for Dual Mode. Please be sure to read through Chapter 1.4 and Chapter 3's "Introduction to Web Management" and "Initial Configurations" first.

It is highly recommended that you use 2 directional antennas in this mode to achieve larger coverage and avoid mutual interference. If you need to use the supplied 2dBi omni antennas, please adjust them according to the diagram below:



### 5.1 Application for Dual AP Mode

The Dual AP mode is designed to extend the wireless coverage of the Hotspot network. Therefore, you should use directional antennas (like a 10dBi panel antenna) to let each radio cover separate areas.

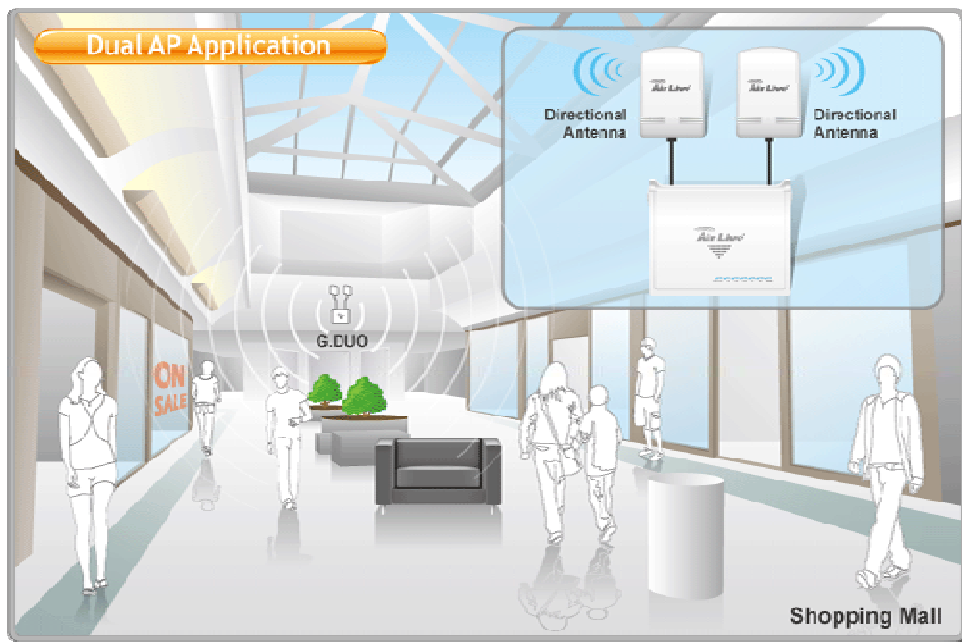

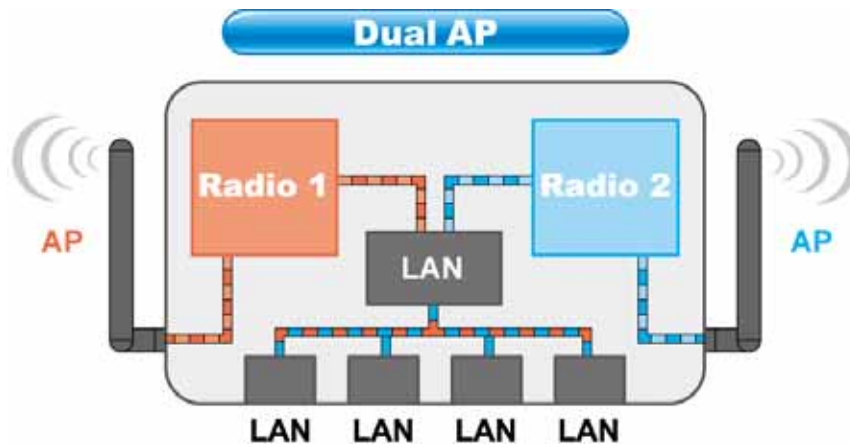

## 5.2 Radio1 and 2: AP Mode Settings

Since both Radio1 and Radio2 are Access Point mode. The configuration menu are the same. We will explain them together here. Radio1's default SSID is "airlive1", Radio2's default SSID is "airlive2".

**Wireless Settings**

Interface: RADIO 2 (AP) ▼

Disable Wireless LAN Interface (2)

Band: 802.11 b/g ▼

SSID: airlive2

Channel: Channel 11 ▼

Security: Setup

Advance: Setup

Access Control: Setup

Associated Clients: Show clients

Apply Change    Reset

### 5.2.1 Basic Wireless Settings

- **Band:** You can choose between "802.11g/b", "802.11g", or "802.11b". We recommend leaving the setting at "802.11g/b".

- **SSID:** The SSID setting of the remote AP. If you are not sure, you can click on “Site Survey” button to scan for AP.
- **Channel:** Wireless Channel used. For EU, it is channel 1~13. For U.S.A., it is channel 1~11.

## 5.2.2 Security Settings

### Operation Mode -> Setup -> Security Settings

Security settings allow you to use encryption to secure your data from eavesdropping. You can select different security policy to provide association authentication and/or data encryption. The G.DUO features various security policies including WEP, 802.1x, WPA, WPA Personal, WPA2, WPA2 Personal, WPA Mixed.

### WEP

WEP Encryption is the oldest and most available encryption method. However, it is also the least secure.

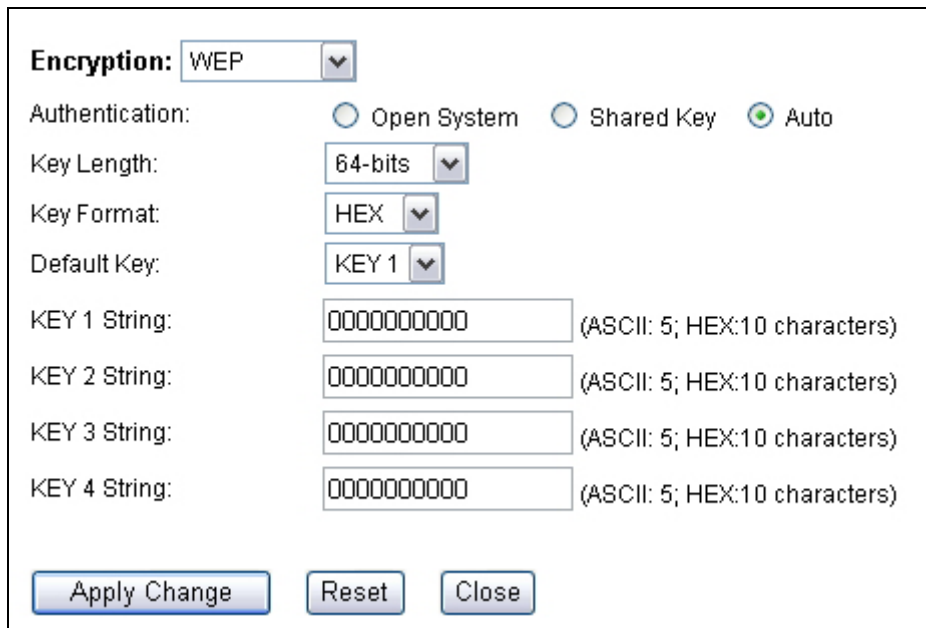

- **Select one of the WEP key for wireless network:** There are total of 4 possible keys for WEP encryption. You need to choose which key will be used for encryption. All wireless devices on the same network have to use the same settings. We recommend using WEP Key 1 as in default setting.
- **Authentication:** 2 types of Authentication are offered. Open system and Shared key. If you are not sure which one to use, please select “Auto”.
- **Key Length:** The G.DUO offers 64bit and 128 bit for WEP key length. The

longer the Key Length, the more secure the encryption is.

- **Key Type:** 2 types are available: ASCII and HEX. ASCII is a string of ASCII code including alphabetical characters, space, signs and numbers (i.e. “airlivepass12”). HEX is a string of 16-bit hexadecimal digits (0..9, a, b, c, d, e, f). All wireless devices on the network must match the exact key length and Key type. Some Wireless clients only allow HEX type for WEP.
- **ASCII-64:** This is a key with 64-bit key length of ASCII type. Please enter **5** ASCII Characters if you choose this option. For example, “passw”
- **HEX-64:** This is a key with 64-bit key length of HEX type. Please enter **10** Hexadecimal digits if you choose this option. For example, “12345abcdef”
- **ASCII-128:** This is a key with 64-bit key length of ASCII type. Please enter **13** ASCII Characters if you choose this option. For example, “airlivewepkey”
- **HEX-128:** This is a key with 128-bit key length of HEX type. Please enter **26** Hexadecimal digits if you choose this option. For example, “1234567890abcdef1234567890”

## WPA-Personal, WPA2-Personal, WPA-Mixed (Pre-Shared Key)

The WPA Personal is also known as “WPA-PSK” encryption. Wi-Fi Protected Access (WPA) introduces the Temporal Key Integrity Protocol (TKIP) that provides added security. WPA2 adds full support for 802.11i standard and the CCMP (AES Encryption). The WPA-Mixed tries to authenticate wireless clients using both WPA-PSK or WPA2-PSK.

### Radio 2 Security Setup

---

Encryption:

Authentication:

WPA Cipher Suite:  TKIP  AES  Mixed

Pre-Shared Key Format:

Pre-Shared Key:

- **Encryption Type:** There are two encryption types **TKIP** and **CCMP (AES)**. While CCMP provides better security than TKIP, some wireless client stations may not be equipped with the hardware to support it. You can select **Mixed** to allow TKIP clients and CCMP clients to connect to the Access Point at the same time.

- **Pre-Shared Key Format:** You can select between Passphrase(ASCII) or HEX format. Please select Passphrase if you are not sure what to use.
- **Pre-Shared Key:** Enter the password key here..

### WPA-Enterprise, WPA2-Enterprise, WPA-Mixed Enterprise (Radius)

Wi-Fi Protected Access (WPA) Enterprise uses Radius Server as the authenticator. WPA2 adds full support for 802.11i standard and the CCMP (AES Encryption). The WPA-Mixed tries to authenticate wireless clients using both WPA or WPA2.

**Encryption:**

**Authentication:**

**WPA Cipher Suite:**  TKIP  AES  Mixed

**Server IP Address:**  (xxx.xxx.xxx.xxx)

**Server Port:**  (1024-65535)

**Server Password:**

### 5.2.3 Advance (Wireless Settings)

**Operation Mode -> Setup -> Advance**

**Fragment Threshold:**  (256-2346)

**RTS Threshold:**  (0-2347)

**Beacon Interval:**  ( 20-1024; unit 1ms)

**Ack Timeout:**  (0-255; unit 4us)

**Preamble Type:**  Long Preamble:  Short Preamble:

**IAPP:**  Enable  Disable

**BG Protection:**  Enable  Disable

**Hide SSID:**  Enable

**Isolation:**  Enable

**Tx Power Level:**

- **Fragmentation:** When the size of a unicast frame exceeds the fragmentation threshold, it will be fragmented before the transmission. It should have a value of 256-2346 bytes, with a default of 2346. If you experience a high packet error rate, you should slightly decrease the Fragmentation Threshold.
- **RTS Threshold:** RTS/CTS frames are used to gain control of the medium for transmission. Any unicast (data or control) frames larger than specified RTS threshold must be transmitted following the RTS/CTS handshake exchange mechanism. The RTS threshold should have a value between 256-2347 bytes, with a default of **2347**. It is recommended that this value does not deviate from the default too much.
- **Beacon Interval:** The device broadcasts beacon frames regularly to announce its existence. The beacon Interval specifies how often beacon frames are transmitted in time unit of milliseconds. The default value is **100**, and a valid value should be between 1 and 65,535.
- **AckTimeOut:** When a packet is sent out from one wireless station to the other, it will wait for an Acknowledgement frame from the remote station. The station will only wait for a certain amount of time, this time is called the ACK timeout. In most conditions, please put ACKtimeout value at zero(default value). The AP will calculate the ACKtimeout automatically when the value is zero. However, you can also enter the ACKtimeout manually.
- **Preamble Type:** A preamble is a signal used in wireless environment to synchronize the transmitting timing including Synchronization and Start frame delimiter. In a "noisy" network environment, the Preamble Type should be set to Long Preamble. The Short Preamble is intended for applications where minimum overhead and maximum performance is desired. If in a "noisy" network environment, the performance will be decreased.
- **IAPP:** IAPP (Inter Access Point Protocol) is designed for the enforcement of unique association throughout a ESS (Extended Service Set) and a secure exchange of station's security context between current access point (AP) and new AP during handoff period.
- **BG Protection:** The 802.11g standard includes a protection mechanism to ensure mixed 802.11b and 802.11g operation. If there is no such kind of mechanism exists, the two kinds of standards may mutually interfere and decrease network's performance..
- **Hide SSID:** Enable Hide SSID will make the AP network's SSID invisible. A device can link with the AP only if correct SSID name is entered.
- **Isolation:** Enable Isolation will prevent wireless clients to see each other on the

network.

- **TX Power Level:** You can set your TX Output power level here. Please note the maximum allowable TX output power in EU is 20dBm. Please do not exceed your country's legal limit.

## 5.2.4 Access Control

### Operation Mode -> Setup -> Access Control

The G.DUO allows you to define a list of MAC addresses that are allowed or denied to access the wireless network. This function is available only for Access Point and Gateway modes.

**Access Control Mode:**

**Add Access Control Rule:**

MAC Address:  (xxxxxxxxxxxx)

Comment

**Current Access Control List**

MAC Address:	Comment	Select
<input type="button" value="Delete Selected"/> <input type="button" value="Delete All"/>		

- **Access Control List**

- **Disable:** When selected, no MAC address filtering will be performed.
- **Allow list:** When selected, data traffic from only the specified devices in the table will be allowed in the network.
- **Deny list:** When selected, data traffic from the devices specified in the table will be denied/discarded by the network.

## 5.2.5 Associated Clients

Click on this to show the current wireless clients associated to the AP. It will display MAC address, Transmit packet, Tx rate, power saving, expire time, and signal strength.



MAC Address	Tx Packet	Tx Rate (Mbps)	Tx Rate (Mbps)	Power Saving	Expired Time (s)	RSSI
None	---	---	---	---	---	---

# 6

## Client + AP Mode

In this chapter, we will explain about the wireless settings for Client + AP Mode. Please be sure to read through Chapter 1.4 and Chapter 3's "Introduction to Web Management" and "Initial Configurations" first.

It is highly recommended that you use directional antenna for Radio1 in this mode to achieve larger coverage and avoid mutual interference. If you need to use the supplied 2dBi omni antennas, please adjust them according to the diagram below:



### 6.1 Application for Client + AP Mode

In this mode, the Radio1 is acting as wireless client to remote AP. Radio2 is performing as an Access Point. This mode is best used as a wireless repeater to extend the signal from remote Wireless Router.

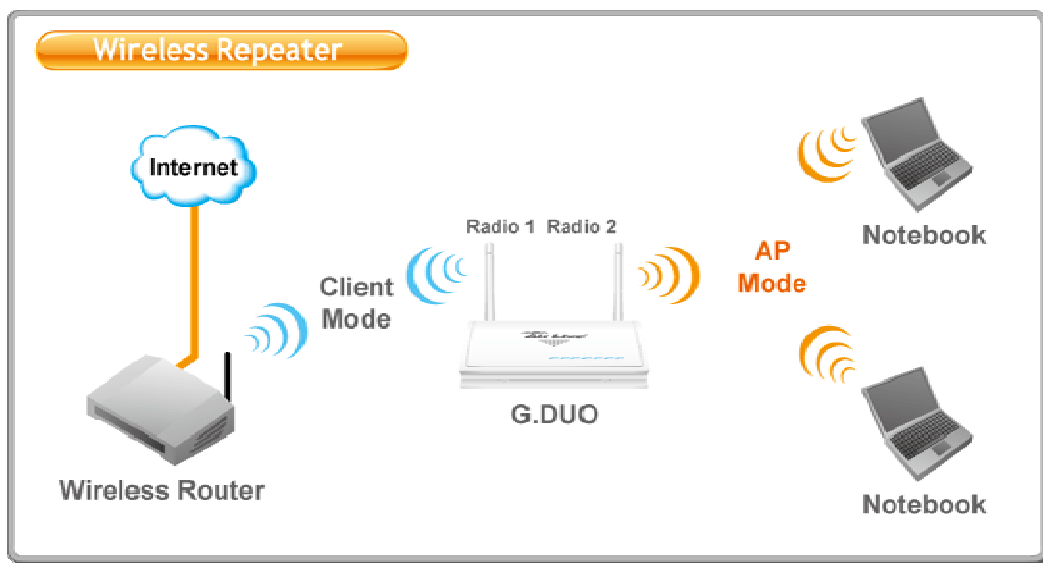

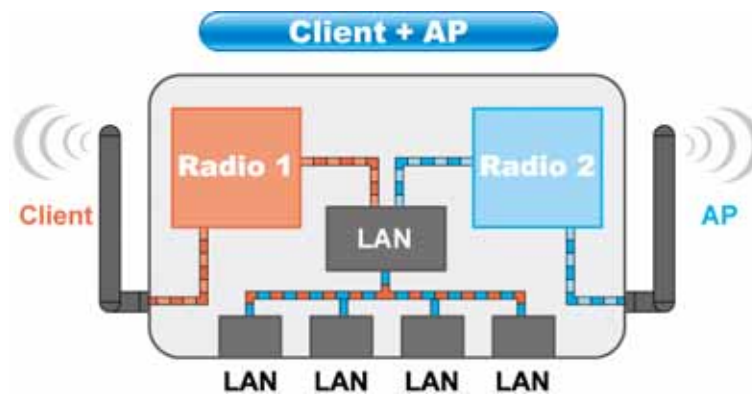

## 6.2 Radio1: Client Mode Settings

The Radio1 is working as wireless Client to Remote AP.

When you select "Radio1" as the interface, the following screen will appear.

**Wireless Settings**

Interface: RADIO 1 (Client) ▼

Disable Wireless LAN Interface (1)

Band: 802.11 b/g ▼

SSID: 123

Network Type: Infrastructure ▼

Channel: Channel 1 ▼

Security: Setup

Advance: Setup

Site Survey: Setup

Enable Mac Clone (Single Ethernet Client)

Apply Change    Reset

### 6.2.1 Basic Wireless Settings

- **Band:** You can choose between "802.11g/b", "802.11g", or "802.11b". We recommend to leave the setting at "802.11g/b".
- **SSID:** The SSID setting of the remote AP. If you are not sure, you can click on "Site Survey" button to scan for AP.
- **Channel:** Wireless Channel used. For EU, it is channel 1~13. For U.S.A., it is channel 1~11. For Client and WISP mode, this field is applicable only in Adhoc

mode.

## 6.2.2 Security Settings

### Operation Mode -> Setup -> Security Settings

Security settings allow you to use encryption to secure your data from eavesdropping. You can select different security policy to provide association authentication and/or data encryption. The G.DUO features various security policies including WEP, 802.1x, WPA, WPA Personal, WPA2, WPA2 Personal, WPA Mixed.

## WEP

WEP Encryption is the oldest and most available encryption method. However, it is also the least secure.

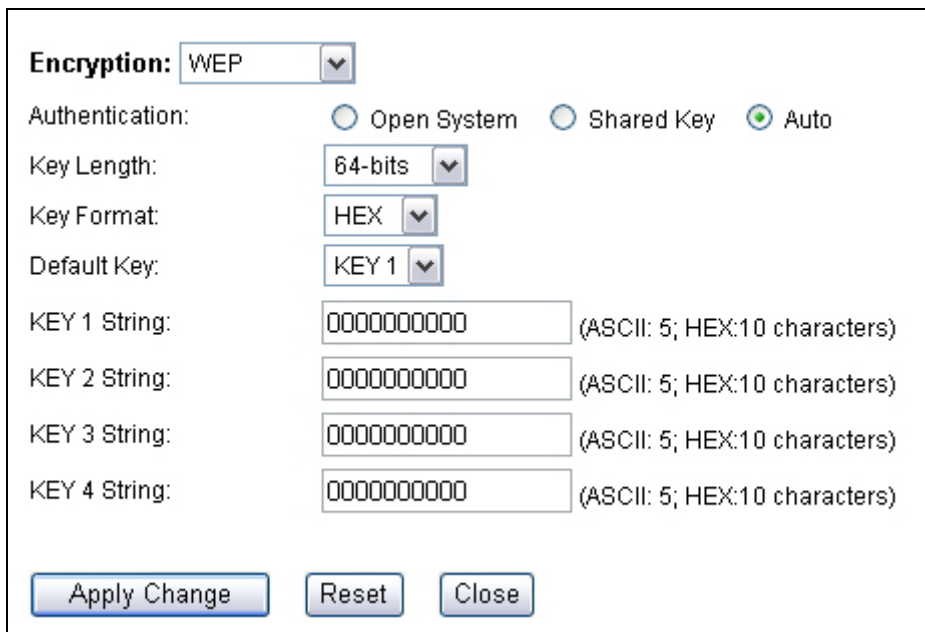

The screenshot shows a configuration window for WEP encryption. The 'Encryption' dropdown is set to 'WEP'. Under 'Authentication', the 'Auto' radio button is selected. 'Key Length' is set to '64-bits', 'Key Format' is 'HEX', and 'Default Key' is 'KEY 1'. There are four text input fields for 'KEY 1 String', 'KEY 2 String', 'KEY 3 String', and 'KEY 4 String', each containing '0000000000'. Each field has a note: '(ASCII: 5; HEX:10 characters)'. At the bottom, there are three buttons: 'Apply Change', 'Reset', and 'Close'.

- **Select one of the WEP key for wireless network:** There are total of 4 possible keys for WEP encryption. You need to choose which key will be used for encryption. All wireless devices on the same network have to use the same settings. We recommend using WEP Key 1 as in default setting.
- **Authentication:** 2 types of Authentication are offered. Open system and Shared key. If you are not sure which one to use, please select "Auto".
- **Key Length:** The G.DUO offers 64bit and 128 bit for WEP key length. The longer the Key Length, the more secure the encryption is.
- **Key Type:** 2 types are available: ASCII and HEX. ASCII is a string of ASCII code including alphabetical characters, space, signs and numbers (i.e. "airlivepass12"). HEX is a string of 16-bit hexadecimal digits (0..9, a, b, c, d, e, f).

All wireless devices on the network must match the exact key length and Key type. Some Wireless clients only allow HEX type for WEP.

- **ASCII-64:** This is a key with 64-bit key length of ASCII type. Please enter **5** ASCII Characters if you choose this option. For example, “passw”
- **HEX-64:** This is a key with 64-bit key length of HEX type. Please enter **10** Hexadecimal digits if you choose this option. For example, “12345abcdef”
- **ASCII-128:** This is a key with 64-bit key length of ASCII type. Please enter **13** ASCII Characters if you choose this option. For example, “airlivewepkey”
- **HEX-128:** This is a key with 128-bit key length of HEX type. Please enter **26** Hexadecimal digits if you choose this option. For example, “1234567890abcdef1234567890”

## WPA-PSK, WPA2-PSK, WPA-AUTO

Wi-Fi Protected Access (WPA) introduces the Temporal Key Integrity Protocol (TKIP) that provides added security. WPA2 adds full support for 802.11i standard and the CCMP (AES Encryption). The WPA Mixed tries to authenticate wireless clients using both WPA-PSK or WPA2-PSK.

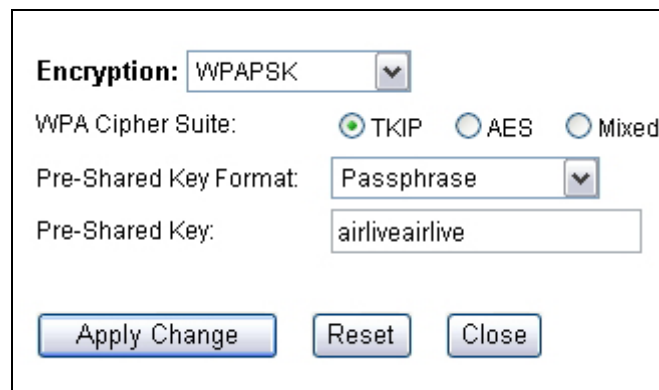

The screenshot shows a configuration window for WPA settings. It includes a dropdown menu for 'Encryption' set to 'WPAPSK', radio buttons for 'WPA Cipher Suite' with 'TKIP' selected, a dropdown for 'Pre-Shared Key Format' set to 'Passphrase', and a text input field for 'Pre-Shared Key' containing 'airliveairlive'. At the bottom are 'Apply Change', 'Reset', and 'Close' buttons.

- **Encryption Type:** There are two encryption types **TKIP** and **CCMP (AES)**. While CCMP provides better security than TKIP, some wireless client stations may not be equipped with the hardware to support it. You can select **Mixed** to allow TKIP clients and CCMP clients to connect to the Access Point at the same time.
- **Pre-Shared Key Format:** You can select between Passphrase(ASCII) or HEX format. Please select Passphrase if you are not sure what to use.
- **Pre-Shared Key:** Enter the password key here..

### 6.2.3 Advance (Wireless Settings)

Operation Mode -> Setup -> Advance

Fragment Threshold:	<input type="text" value="2346"/>	(256-2346)
RTS Threshold:	<input type="text" value="2347"/>	(0-2347)
Beacon Interval:	<input type="text" value="100"/>	( 20-1024; unit 1ms)
Ack Timeout:	<input type="text" value="0"/>	(0-255; unit 4us) <input type="button" value="Calculation"/>
Preamble Type:	<input checked="" type="radio"/> Long Preamble: <input type="radio"/> Short Preamble:	
IAPP:	<input checked="" type="radio"/> Enable <input type="radio"/> Disable	
BG Protection:	<input checked="" type="radio"/> Enable <input type="radio"/> Disable	
Hide SSID:	<input type="checkbox"/> Enable	
Tx Power Level:	<input type="text" value="Level 12 (About 21.0dB)"/>	
LED Mode:	<input checked="" type="radio"/> Traffic Mode: <input type="radio"/> Signal Mode:	
<input type="button" value="Apply Change"/> <input type="button" value="Reset"/> <input type="button" value="Close"/>		

- **Fragmentation:** When the size of a unicast frame exceeds the fragmentation threshold, it will be fragmented before the transmission. It should have a value of 256-2346 bytes, with a default of 2346. If you experience a high packet error rate, you should slightly decrease the Fragmentation Threshold.
- **RTS Threshold:** RTS/CTS frames are used to gain control of the medium for transmission. Any unicast (data or control) frames larger than specified RTS threshold must be transmitted following the RTS/CTS handshake exchange mechanism. The RTS threshold should have a value between 256-2347 bytes, with a default of **2347**. It is recommended that this value does not deviate from the default too much.
- **Beacon Interval:** The device broadcasts beacon frames regularly to announce its existence. The beacon Interval specifies how often beacon frames are transmitted in time unit of milliseconds. The default value is **100**, and a valid value should be between 1 and 65,535.
- **AckTimeOut:** When a packet is sent out from one wireless station to the other, it will wait for an Acknowledgement frame from the remote station. The station will only wait for a certain amount of time, this time is called the ACK timeout. In most conditions, please put ACKtimeout value at zero(default value). The AP will calculate the ACKtimeout automatically when the value is zero. However, you can also enter the ACKtimeout manually.
- **Preamble Type:** A preamble is a signal used in wireless environment to synchronize the transmitting timing including Synchronization and Start frame delimiter. In a "noisy" network environment, the Preamble Type should be set to Long Preamble. The Short

Preamble is intended for applications where minimum overhead and maximum performance is desired. If in a "noisy" network environment, the performance will be decreased.

- **IAPP:** IAPP (Inter Access Point Protocol) is designed for the enforcement of unique association throughout a ESS (Extended Service Set) and a secure exchange of station's security context between current access point (AP) and new AP during handoff period.
  
- **BG Protection:** The 802.11g standard includes a protection mechanism to ensure mixed 802.11b and 802.11g operation. If there is no such kind of mechanism exists, the two kinds of standards may mutually interfere and decrease network's performance..
  
- **Hide SSID:** Enable Hide SSID will make the AP network's SSID invisible. A device can link with the AP only if correct SSID name is entered.
  
- **TX Power Level:** You can set your TX Output power level here. Please note the maximum allowable TX output power in EU is 20dBm. Please do not exceed your country's legal limit.

## 6.2.4 Site Survey

### Operation Mode -> Setup -> Site Survey

You can scan for wireless networks around your location using the Site Survey function. From the site survey function, you can also perform antenna alignment and establish wireless connection

When you click on Site Survey, the following screen will appear. It might take awhile depending on number of available APs in the area.

SSID	BSSID	Channel	Type	Encrypt	Signal	Select
airlive	00:4f:62:00:04:03	11 (B+G)	AP	no	43	<input type="radio"/>
ggggway	00:4f:62:94:02:11	1 (B+G)	AP	WPA-PSK	40	<input type="radio"/>
default	02:1b:77:00:8c:78	11 (B+G)	Ad hoc	no	21	<input type="radio"/>
OutdoorAP	00:12:0e:b3:b2:b2	11 (B+G)	AP	WPA-PSK	10	<input checked="" type="radio"/>

Refresh

Connect

Close

Signal Survey

To connect with the selected SSID. This function is available only in Client Infrastructure or Bridge Infrastructure

For antenna alignment. It will display and update the Signal Strength continuously

Click here to select SSID for Association or Signal Survey

## 6.2.5 Signal Survey

### **Operation Mode -> Setup -> Site Survey -> Signal Survey**

The Signal Survey will continuously display the SIGNAL STRENGTH value of the selected SSID for antenna alignment purpose. To use Signal Survey function, please enter the “Site Survey” function first; please refer to the instruction in the above section. Once you select the ESSID and click on the “Signal Survey” button, the following screen will appear.

Signal Survey					
SSID	BSSID	Channel	Type	Encrypt	Signal
airlive2	00:e0:4c:81:86:23	11 (B+G)	AP	no	24

- **BSSID:** This is the remote AP’s MAC address.
- **Channel:** The current scanned channel
- **Signal Strength:** This is signal strength number in percentage in 0 to 100 scale. The higher the number, the better signal.

## 6.2.6 Enable MAC Clone (Single Ethernet Client)

When this function is enabled, G.DUO will replace the MAC address of Radio1 with the first PC’s MAC address caught from the LAN port. It will allow one single Ethernet client only. Please use this function only if you want to limit the Ethernet client to only one.



## 6.3 Radio2: AP Mode Settings

The Radio2 is working in Access Point Mode. The default SSID is “AirLive2”.

When you select “Radio2” as the interface, the following screen will appear:

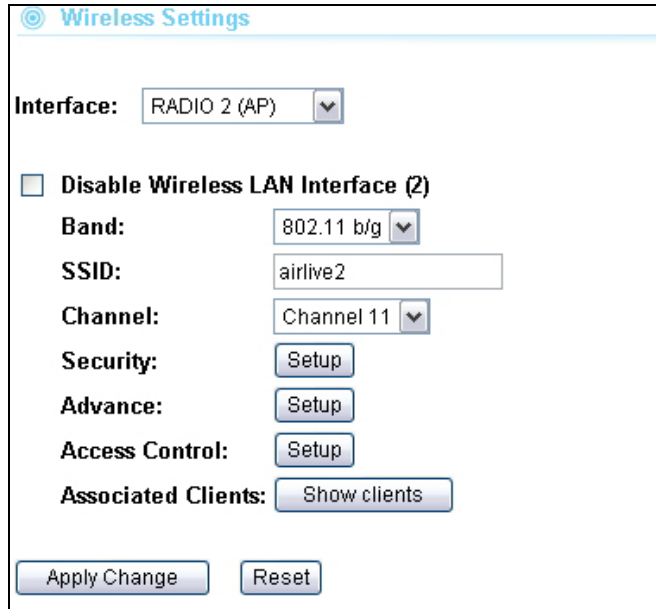

Wireless Settings

Interface: RADIO 2 (AP) ▼

Disable Wireless LAN Interface (2)

Band: 802.11 b/g ▼

SSID: airlive2

Channel: Channel 11 ▼

Security: Setup

Advance: Setup

Access Control: Setup

Associated Clients: Show clients

Apply Change    Reset

### 6.3.1 Basic Wireless Settings

- **Band:** You can choose between “802.11g/b”, “802.11g”, or “802.11b”. We recommend leaving the setting at “802.11g/b”.
- **SSID:** The SSID setting of the remote AP. If you are not sure, you can click on “Site Survey” button to scan for AP.
- **Channel:** Wireless Channel used. For EU, it is channel 1~13. For U.S.A., it is channel 1~11.

### 6.3.2 Security Settings

#### **Operation Mode -> Setup -> Security Settings**

Security settings allow you to use encryption to secure your data from eavesdropping. You can select different security policy to provide association authentication and/or data encryption. The G.DUO features various security policies including WEP, 802.1x, WPA, WPA Personal, WPA2, WPA2 Personal, WPA Mixed.

#### **WEP**

WEP Encryption is the oldest and most available encryption method. However, it is also the least secure.

**Encryption:** WEP ▼

Authentication:       Open System     Shared Key     Auto

Key Length:            64-bits ▼

Key Format:            HEX ▼

Default Key:          KEY 1 ▼

KEY 1 String:         (ASCII: 5; HEX:10 characters)

KEY 2 String:         (ASCII: 5; HEX:10 characters)

KEY 3 String:         (ASCII: 5; HEX:10 characters)

KEY 4 String:         (ASCII: 5; HEX:10 characters)

Apply Change
Reset
Close

- **Select one of the WEP key for wireless network:** There are total of 4 possible keys for WEP encryption. You need to choose which key will be used for encryption. All wireless devices on the same network have to use the same settings. We recommend using WEP Key 1 as in default setting.
  
- **Authentication:** 2 types of Authentication are offered. Open system and Shared key. If you are not sure which one to use, please select “Auto”.
- **Key Length:** The G.DUO offers 64bit and 128 bit for WEP key length. The longer the Key Length, the more secure the encryption is.
- **Key Type:** 2 types are available: ASCII and HEX. ASCII is a string of ASCII code including alphabetical characters, space, signs and numbers (i.e. “airlivepass12”). HEX is a string of 16-bit hexadecimal digits (0..9, a, b, c, d, e, f). All wireless devices on the network must match the exact key length and Key type. Some Wireless clients only allow HEX type for WEP.
- **ASCII-64:** This is a key with 64-bit key length of ASCII type. Please enter **5** ASCII Characters if you choose this option. For example, “passw”
- **HEX-64:** This is a key with 64-bit key length of HEX type. Please enter **10** Hexadecimal digits if you choose this option. For example, “12345abcdef”
- **ASCII-128:** This is a key with 64-bit key length of ASCII type. Please enter **13** ASCII Characters if you choose this option. For example, “airlivewepkey”
- **HEX-128:** This is a key with 128-bit key length of HEX type. Please enter **26** Hexadecimal digits if you choose this option. For example, “1234567890abcdef1234567890”

## WPA-Personal, WPA2-Personal, WPA-Mixed (Pre-Shared Key)

The WPA Personal is also known as “WPA-PSK” encryption. Wi-Fi Protected Access (WPA) introduces the Temporal Key Integrity Protocol (TKIP) that provides added security. WPA2 adds full support for 802.11i standard and the CCMP (AES Encryption). The WPA-Mixed tries to authenticate wireless clients using both WPA-PSK or WPA2-PSK.

### Radio 2 Security Setup

---

**Encryption:** WPA ▼

**Authentication:** Personal(Pre-Shared Key) ▼

**WPA Cipher Suite:**  TKIP  AES  Mixed

**Pre-Shared Key Format:** Passphrase ▼

**Pre-Shared Key:** airliveairlive

Apply Change
Reset
Close

- Encryption Type:** There are two encryption types **TKIP** and **CCMP (AES)**. While CCMP provides better security than TKIP, some wireless client stations may not be equipped with the hardware to support it. You can select **Mixed** to allow TKIP clients and CCMP clients to connect to the Access Point at the same time.
- Pre-Shared Key Format:** You can select between Passphrase(ASCII) or HEX format. Please select Passphrase if you are not sure what to use.
- Pre-Shared Key:** Enter the password key here..

## WPA-Enterprise, WPA2-Enterprise, WPA-Mixed Enterprise (Radius)

Wi-Fi Protected Access (WPA) Enterprise uses Radius Server as the authenticator. WPA2 adds full support for 802.11i standard and the CCMP (AES Encryption). The WPA-Mixed tries to authenticate wireless clients using both WPA or WPA2.

**Encryption:** WPA ▼

**Authentication:** Enterprise(RADIUS) ▼

**WPA Cipher Suite:**  TKIP  AES  Mixed

**Server IP Address:** 0.0.0.0 (xxx.xxx.xxx.xxx)

**Server Port:** 1812 (1024-65535)

**Server Password:**  

Apply Change
Reset
Close

### 6.3.3 Advance (Wireless Settings)

Operation Mode -> Setup -> Advance

Fragment Threshold:	<input type="text" value="2346"/>	(256-2346)
RTS Threshold:	<input type="text" value="2347"/>	(0-2347)
Beacon Interval:	<input type="text" value="100"/>	( 20-1024; unit 1ms)
Ack Timeout:	<input type="text" value="0"/>	(0-255; unit 4us) <input type="button" value="Calculation"/>
Preamble Type:	<input checked="" type="radio"/> Long Preamble: <input type="radio"/> Short Preamble:	
IAPP:	<input checked="" type="radio"/> Enable <input type="radio"/> Disable	
BG Protection:	<input checked="" type="radio"/> Enable <input type="radio"/> Disable	
Hide SSID:	<input type="checkbox"/> Enable	
Isolation:	<input type="checkbox"/> Enable	
Tx Power Level:	<input type="text" value="Level 6 (About 14.4dB)"/>	
<input type="button" value="Apply Change"/> <input type="button" value="Reset"/> <input type="button" value="Close"/>		

- **Fragmentation:** When the size of a unicast frame exceeds the fragmentation threshold, it will be fragmented before the transmission. It should have a value of 256-2346 bytes, with a default of 2346. If you experience a high packet error rate, you should slightly decrease the Fragmentation Threshold.
- **RTS Threshold:** RTS/CTS frames are used to gain control of the medium for transmission. Any unicast (data or control) frames larger than specified RTS threshold must be transmitted following the RTS/CTS handshake exchange mechanism. The RTS threshold should have a value between 256-2347 bytes, with a default of **2347**. It is recommended that this value does not deviate from the default too much.
- **Beacon Interval:** The device broadcasts beacon frames regularly to announce its existence. The beacon Interval specifies how often beacon frames are transmitted in time unit of milliseconds. The default value is **100**, and a valid value should be between 1 and 65,535.
- **AckTimeOut:** When a packet is sent out from one wireless station to the other, it will wait for an Acknowledgement frame from the remote station. The station will only wait for a certain amount of time, this time is called the ACK timeout. In most conditions, please put ACKtimeout value at zero(default value). The AP will calculate the ACKtimeout automatically when the value is zero. However, you can also enter

the ACKtimeout manually.

- **Preamble Type:** A preamble is a signal used in wireless environment to synchronize the transmitting timing including Synchronization and Start frame delimiter. In a "noisy" network environment, the Preamble Type should be set to Long Preamble. The Short Preamble is intended for applications where minimum overhead and maximum performance is desired. If in a "noisy" network environment, the performance will be decreased.
- **IAPP:** IAPP (Inter Access Point Protocol) is designed for the enforcement of unique association throughout a ESS (Extended Service Set) and a secure exchange of station's security context between current access point (AP) and new AP during handoff period.
- **BG Protection:** The 802.11g standard includes a protection mechanism to ensure mixed 802.11b and 802.11g operation. If there is no such kind of mechanism exists, the two kinds of standards may mutually interfere and decrease network's performance..
- **Hide SSID:** Enable Hide SSID will make the AP network's SSID invisible. A device can link with the AP only if correct SSID name is entered.
- **Isolation:** Enable Isolation will prevent wireless clients to see each other on the network.
- **TX Power Level:** You can set your TX Output power level here. Please note the maximum allowable TX output power in EU is 20dBm. Please do not exceed your country's legal limit.

### 6.3.4 Access Control

#### ***Operation Mode -> Setup -> Access Control***

The G.DUO allows you to define a list of MAC addresses that are allowed or denied to access the wireless network. This function is available only for Access Point and Gateway modes.

Access Control Mode:

**Add Access Control Rule:**

MAC Address:  (xxxxxxxxxxxxxx)

Comment

**Current Access Control List**

MAC Address:	Comment	Select
<input type="button" value="Delete Selected"/> <input type="button" value="Delete All"/>		

■ **Access Control List**

- **Disable:** When selected, no MAC address filtering will be performed.
- **Allow list:** When selected, data traffic from only the specified devices in the table will be allowed in the network.
- **Deny list:** When selected, data traffic from the devices specified in the table will be denied/discarded by the network.

### 6.3.5 Associated Clients

Click on this to show the current wireless clients associated to the AP. It will display MAC addresss, Trasmit packet, Tx rate, power saving, expire time, and signal strength.

MAC Address	Tx Packet	Tx Rate (Mbps)	Tx Rate (Mbps)	Power Saving	Expired Time (s)	RSSI
None	---	---	---	---	---	---

# 7

## Gateway + AP Mode

In this chapter, we will explain about the wireless settings for Gateway+AP Mode. Please be sure to read through Chapter 1.4 and Chapter 3's "Introduction to Web Management" and "Initial Configurations" first.

It is highly recommended that you use 2 directional antennas in this mode to achieve larger coverage and avoid mutual interference. If you need to use the supplied 2dBi Omni antennas, please adjust them according to the diagram below:



### 7.1 Application for Gateway +AP Mode

In this mode, both Radio1 and Radio2 are performing as AP Router. This is perfect for shopping mall or office where they can extend the coverage of the wireless IP sharing.

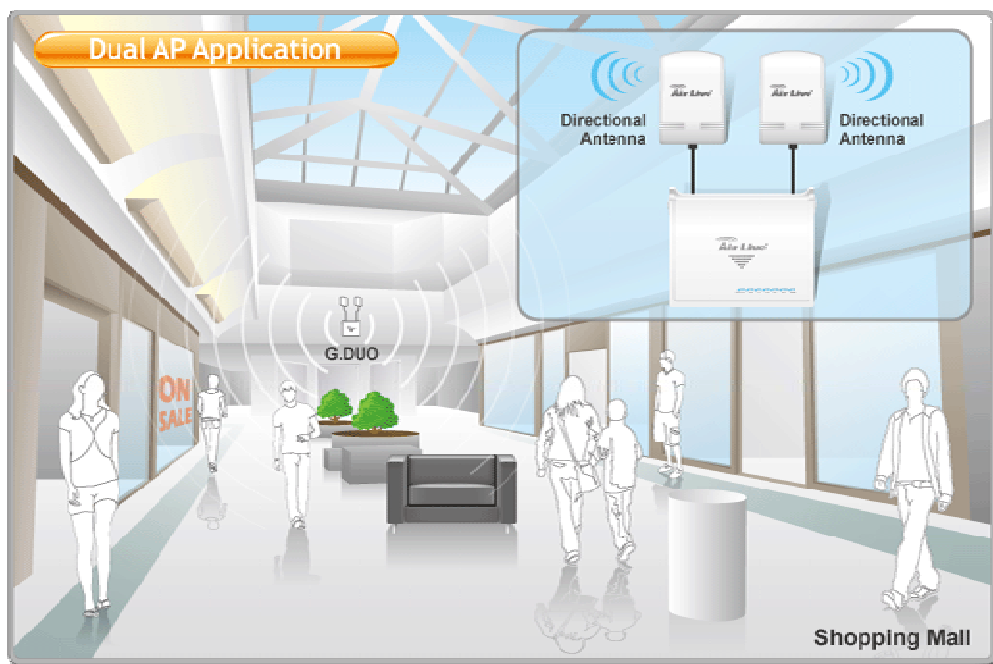

In this mode, the WAN port is in the LAN1. It can be seen as a wireless router with 2 radios.

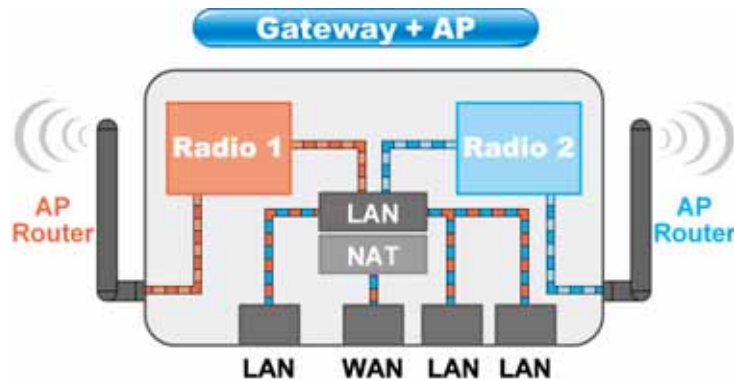

## 7.2 Radio1: WISP Router Mode Settings

Although both Radio1 and Radio2 are working as wireless router, the WAN configuration is on the Radio1 side..

When you select "Radio1" as the interface, the following screen will appear.

Interface: RADIO 1 (AP)

Disable Wireless LAN Interface (1)

Band: 802.11 b/g

SSID: 123

Channel: Channel 1

Security: Setup

Advance: Setup

Access Control: Setup

Associated Clients: Show clients

WAN Port Setup

Virtual Server Setup

DMZ Setup

DDNS Setup

DoS Setup

URL Filter Setup

MAC Filter Setup

IP Filter Setup

Port Filter Setup

Router Setup

RIP Setup

Apply Change
Reset



## 7.2.1 Basic Wireless Settings

- **Band:** You can choose between “802.11g/b”, “802.11g”, or “802.11b”. We recommend to leave the setting at “802.11g/b”.
- **SSID:** The SSID setting of the remote AP. If you are not sure, you can click on “Site Survey” button to scan for AP.
- **Channel:** Wireless Channel used. For EU, it is channel 1~13. For U.S.A., it is channel 1~11.

## 7.2.2 Security Settings

### **Operation Mode -> Setup -> Security Settings**

Security settings allow you to use encryption to secure your data from eavesdropping. You can select different security policy to provide association authentication and/or data encryption. The G.DUO features various security policies including WEP, 802.1x, WPA, WPA Personal, WPA2, WPA2 Personal , WPA Mixed.

## WEP

WEP Encryption is the oldest and most available encryption method. However, it is also the least secure.

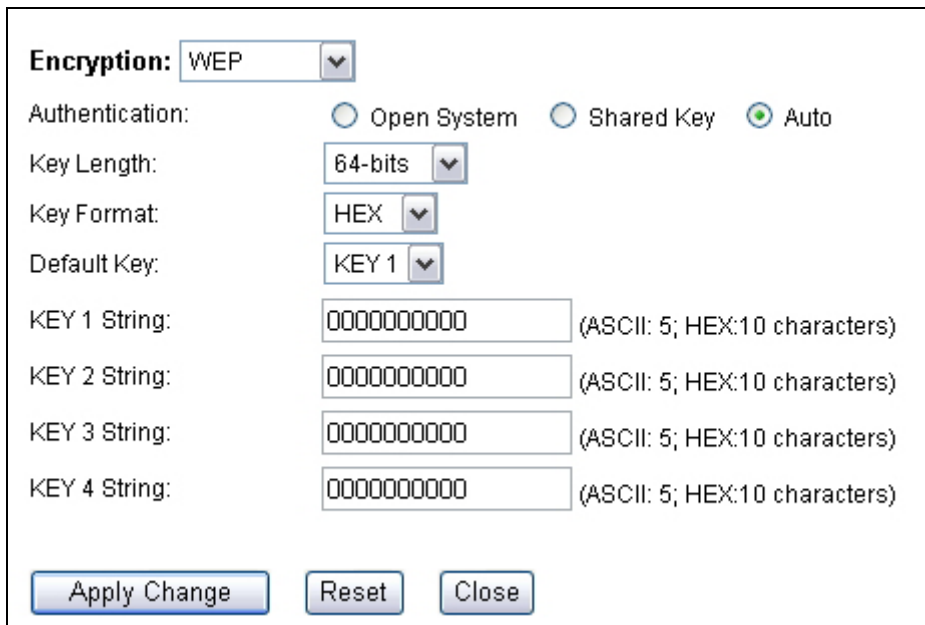

**Encryption:** WEP

Authentication:  Open System  Shared Key  Auto

Key Length: 64-bits

Key Format: HEX

Default Key: KEY 1

KEY 1 String: 0000000000 (ASCII: 5; HEX:10 characters)

KEY 2 String: 0000000000 (ASCII: 5; HEX:10 characters)

KEY 3 String: 0000000000 (ASCII: 5; HEX:10 characters)

KEY 4 String: 0000000000 (ASCII: 5; HEX:10 characters)

Apply Change Reset Close

- **Select one of the WEP key for wireless network:** There are total of 4 possible keys for WEP encryption. You need to choose which key will be used for encryption. All wireless devices on the same network have to use the same settings. We recommend using WEP Key 1 as in default setting.

- **Authentication:** 2 types of Authentication are offered. Open system and Shared key. If you are not sure which one to use, please select “Auto”.
- **Key Length:** The G.DUO offers 64bit and 128 bit for WEP key length. The longer the Key Length, the more secure the encryption is.
- **Key Type:** 2 types are available: ASCII and HEX. ASCII is a string of ASCII code including alphabetical characters, space, signs and numbers (i.e. “airlivepass12”). HEX is a string of 16-bit hexadecimal digits (0..9, a, b, c, d, e, f). All wireless devices on the network must match the exact key length and Key type. Some Wireless clients only allow HEX type for WEP.
- **ASCII-64:** This is a key with 64-bit key length of ASCII type. Please enter **5** ASCII Characters if you choose this option. For example, “passw”
- **HEX-64:** This is a key with 64-bit key length of HEX type. Please enter **10** Hexadecimal digits if you choose this option. For example, “12345abcdef”
- **ASCII-128:** This is a key with 64-bit key length of ASCII type. Please enter **13** ASCII Characters if you choose this option. For example, “airlivewepkey”
- **HEX-128:** This is a key with 128-bit key length of HEX type. Please enter **26** Hexadecimal digits if you choose this option. For example, “1234567890abcdef1234567890”

## WPA-Personal, WPA2-Personal, WPA-Mixed (Pre-Shared Key)

The WPA Personal is also known as “WPA-PSK” encryption. Wi-Fi Protected Access (WPA) introduces the Temporal Key Integrity Protocol (TKIP) that provides added security. WPA2 adds full support for 802.11i standard and the CCMP (AES Encryption). The WPA-Mixed tries to authenticate wireless clients using both WPA-PSK or WPA2-PSK.

### Radio 2 Security Setup

---

Encryption:

Authentication:

WPA Cipher Suite:  TKIP  AES  Mixed

Pre-Shared Key Format:

Pre-Shared Key:

- **Encryption Type:** There are two encryption types **TKIP** and **CCMP (AES)**. While

CCMP provides better security than TKIP, some wireless client stations may not be equipped with the hardware to support it. You can select **Mixed** to allow TKIP clients and CCMP clients to connect to the Access Point at the same time.

- **Pre-Shared Key Format:** You can select between Passphrase(ASCII) or HEX format. Please select Passphrase if you are not sure what to use.
- **Pre-Shared Key:** Enter the password key here..

## WPA-Enterprise, WPA2-Enterprise, WPA-Mixed Enterprise (Radius)

Wi-Fi Protected Access (WPA) Enterprise uses Radius Server as the authenticator. WPA2 adds full support for 802.11i standard and the CCMP (AES Encryption). The WPA-Mixed tries to authenticate wireless clients using both WPA or WPA2.

**Encryption:** WPA

Authentication: Enterprise(RADIUS)

WPA Cipher Suite:  TKIP  AES  Mixed

Server IP Address: 0.0.0.0 (xxx.xxx.xxx.xxx)

Server Port: 1812 (1024-65535)

Server Password:

### 7.2.3 Advance (Wireless Settings)

Fragment Threshold: 2346 (256-2346)

RTS Threshold: 2347 (0-2347)

Beacon Interval: 100 (20-1024; unit 1ms)

Ack Timeout: 0 (0-255; unit 4us)

Preamble Type:  Long Preamble:  Short Preamble:

IAPP:  Enable  Disable

BG Protection:  Enable  Disable

Hide SSID:  Enable

Isolation:  Enable

Tx Power Level: Level 6 (About 14.4dB)

- **Fragmentation:** When the size of a unicast frame exceeds the fragmentation threshold, it will be fragmented before the transmission. It should have a value of 256-2346 bytes, with a default of 2346. If you experience a high packet error rate, you should slightly decrease the Fragmentation Threshold.
- **RTS Threshold:** RTS/CTS frames are used to gain control of the medium for transmission. Any unicast (data or control) frames larger than specified RTS threshold must be transmitted following the RTS/CTS handshake exchange mechanism. The RTS threshold should have a value between 256-2347 bytes, with a default of **2347**. It is recommended that this value does not deviate from the default too much.
- **Beacon Interval:** The device broadcasts beacon frames regularly to announce its existence. The beacon Interval specifies how often beacon frames are transmitted in time unit of milliseconds. The default value is **100**, and a valid value should be between 1 and 65,535.
- **AckTimeOut:** When a packet is sent out from one wireless station to the other, it will wait for an Acknowledgement frame from the remote station. The station will only wait for a certain amount of time, this time is called the ACK timeout. In most conditions, please put ACKtimeout value at zero(default value). The AP will calculate the ACKtimeout automatically when the value is zero. However, you can also enter the ACKtimeout manually.
- **Preamble Type:** A preamble is a signal used in wireless environment to synchronize the transmitting timing including Synchronization and Start frame delimiter. In a "noisy" network environment, the Preamble Type should be set to Long Preamble. The Short Preamble is intended for applications where minimum overhead and maximum performance is desired. If in a "noisy" network environment, the performance will be decreased.
- **IAPP:** IAPP (Inter Access Point Protocol) is designed for the enforcement of unique association throughout a ESS (Extended Service Set) and a secure exchange of station's security context between current access point (AP) and new AP during handoff period.
- **BG Protection:** The 802.11g standard includes a protection mechanism to ensure mixed 802.11b and 802.11g operation. If there is no such kind of mechanism exists, the two kinds of standards may mutually interfere and decrease network's performance..
- **Hide SSID:** Enable Hide SSID will make the AP network's SSID invisible. A device can link with the AP only if correct SSID name is entered.
- **Isolation:** Enable Isolation will prevent wireless clients to see each other on the network.

- **TX Power Level:** You can set your TX Output power level here. Please note the maximum allowable TX output power in EU is 20dBm. Please do not exceed your country's legal limit.

## 7.2.4 Access Control

### *Operation Mode -> Setup -> Access Control*

The G.DUO allows you to define a list of MAC addresses that are allowed or denied to access the wireless network. This function is available only for Access Point and Gateway modes.

Access Control Mode: Disable ▼ Apply Change

**Add Access Control Rule:**

MAC Address:  (xxxxxxxxxxxxxx)

Comment

Add Rule Reset

**Current Access Control List**

MAC Address:	Comment	Select
<span style="border: 1px solid gray; padding: 2px 10px; margin-right: 10px;">Delete Selected</span> <span style="border: 1px solid gray; padding: 2px 10px;">Delete All</span>		

- **Access Control List**

- **Disable:** When selected, no MAC address filtering will be performed.
- **Allow list:** When selected, data traffic from only the specified devices in the table will be allowed in the network.
- **Deny list:** When selected, data traffic from the devices specified in the table will be denied/discarded by the network.

## 7.2.5 Associated Clients

Click on this to show the current wireless clients associated to the AP. It will display MAC addresss, Trasmit packet, Tx rate, power saving, expire time, and signal strength.

MAC Address	Tx Packet	Tx Rate (Mbps)	Tx Rate (Mbps)	Power Saving	Expired Time (s)	RSSI
None	---	---	---	---	---	---

Refresh Close

## 7.2.6 Signal Survey

**Operation Mode -> Setup -> Site Survey -> Signal Survey**

The Signal Survey will continuously display the SIGNAL STRENGTH value of the selected SSID for antenna alignment purpose. To use Signal Survey function, please enter the "Site Survey" function first; please refer to the instruction in the above section. Once you select the ESSID and click on the "Signal Survey" button, the following screen will appear.

Signal Survey						
SSID	BSSID	Channel	Type	Encrypt	Signal	
airlive2	00:e0:4c:81:86:23	11 (B+G)	AP	no	24	

- **BSSID:** This is the remote AP's MAC address.
- **Channel:** The current scanned channel
- **Signal Strength:** This is signal strength number in percentage in 0 to 100 scale. The higher the number, the better signal.

## 7.2.7 WAN Port

**Operation Mode -> Setup -> WAN Port**

The G.DUO support different authentication and IP assignment standards for the WAN port. It includes fixed IP, DHCP, PPPoE, PPTP, L2TP, and Big Pond protocols. Please consult with your ISP about what authentication type is used for the WAN port connection.

**WAN Port**

---

WAN Access Type:

Host Name:

MTU Size:  (1400-1492)

TTL:

TTL Value:  (1-255)

Attain DNS Automatically  
 Set DNS Manually

DNS 1:

DNS 2:

DNS 3:

Clone MAC Address:

Enable UPnP  
 Enable Ping Access on WAN  
 Enable Web Server Access on WAN  
 Enable IPsec pass through on VPN connection  
 Enable PPTP pass through on VPN connection  
 Enable L2TP pass through on VPN connection

- **Clone MAC Address:** In this place, you can assign a MAC address for the WAN port. In case of WISP mode, it is Radio1's MAC address. For Gateway mode, it is the WAN/LAN1 MAC address.
- **Enable UPnP:** Check this field will enable Universal Plug n Play protocol
- **Enable Web Server Access on WAN:** Check this field will enable remote management from WAN side.

## 7.2.8 Virtual Server Settings

Virtual server allows you to specify one or more applications running on server computers on the LAN that may be accessed by any Internet user. Internet data destined for the specified public port will be directed to the specified private port number on the LAN client with the specified private IP address.

If you want to allow your web server, ftp server, or email server to be accessible from Internet, you would need to open specific port on the virtual server to your local IP address.

### Virtual Server

---

Enable	Internal Server IP	Protocol	Incomming Port Range	Internal Port Range	Description
<input checked="" type="checkbox"/>	192.168.1.100	BOTH	80 - 80	80 - 80	Web server
<input type="checkbox"/>	0.0.0.0	TCP	0 - 0	0 - 0	
<input type="checkbox"/>	0.0.0.0	TCP	0 - 0	0 - 0	
<input type="checkbox"/>	0.0.0.0	TCP	0 - 0	0 - 0	
<input type="checkbox"/>	0.0.0.0	TCP	0 - 0	0 - 0	
<input type="checkbox"/>	0.0.0.0	TCP	0 - 0	0 - 0	
<input type="checkbox"/>	0.0.0.0	TCP	0 - 0	0 - 0	
<input type="checkbox"/>	0.0.0.0	TCP	0 - 0	0 - 0	

For a list of most frequent used TCP and UDP ports. Please visit [http://en.wikipedia.org/wiki/List\\_of\\_TCP\\_and\\_UDP\\_port\\_numbers](http://en.wikipedia.org/wiki/List_of_TCP_and_UDP_port_numbers)

## 7.2.9 DMZ

### **Advanced Settings >> Multiple DMZ**

DMZ opens all TCP/UDP ports to particular IP address on the LAN side. It allows setting up servers behind the G.DUO.

### Demilitarized Zone

---

**Enable DMZ**

DMZ Host IP Address:

## 7.2.10 DDNS

Dynamic Domain Name System. An algorithm that allows the use of dynamic IP address for hosting Internet Server. A DDNS service provides each user account with a domain name. The G.DUO support “Dyndns” and “TZO” service.



### Dynamic DNS

---

**Enable DDNS**

Service Provider:

Domain Name:

User Name/Email:

Password/Key:

Result:

*Note:*  
 For TZO, you can have a 30 days free trial [here](#) or manage your TZO account in [control panel](#)  
 For DynDNS, you can create your DynDNS account [here](#)

### 7.2.11 DoS (Denial of Service)

Denial of Service is a type of network attack that floods the network with useless traffic. Many DoS attacks, such as the Ping of Death and Teardrop attacks, exploit limitations in the TCP/IP protocols.

The G.DUO provides a list of Firewall grade DoS control that protect your network from hacker attack.

### 7.2.12 URL Filter

The G.DUO provide URL filter function to stop access to certain website. It is especially useful for parents to stop children from accessing some websites.

### URL Filter

---

**Enable URL Filtering**

URL String

**Current Filter Table:**

URL String	Select

### 7.2.13 MAC Filter

MAC filter can filter out traffic from certain MAC addresses. It can prevent access to internet from certain station in the local LAN.

#### MAC Filtering

---

**Enable MAC Filtering**

MAC Address:

Comment:

**Current Filter Table:**

MAC Address	Comment:	Select
00:4f:55:11:55:33	Localdevice	<input type="checkbox"/>

### 7.2.14 IP Filter

IP filtering allows you to block certain IP addresses from accessing the network.

#### IP Filter

---

**Enable IP Filtering**

Loal IP Address:

Protocol:

Comment:

**Current Filter Table:**

Loal IP Address	Protocol	Comment	Select
<input type="button" value="Delete Selected"/> <input type="button" value="Delete All"/> <input type="button" value="Reset"/>			

### 7.2.15 Port Filter

Port filtering allows you to block certain applications from accessing the network.

### Port Filtering

---

**Enable Port Filtering**

Port Range:  -

Protocol:

Comment:

**Current Filter Table:**

Port Range	Protocol	Comment	Select
<input type="button" value="Delete Selected"/> <input type="button" value="Delete All"/> <input type="button" value="Reset"/>			

## 7.2.16 Router (Static Route)

This allows you to manually configure static network routes. Static routes will override routes learned by standard routing protocol discover methods.

### Static Route

---

**Enable Routing rules**

Host Name:

Password:

Management Port:

**Static Route rule setup**

Destination Address:  (xxx.xxx.xxx.xxx)

Sub Mask:  (xxx.xxx.xxx.xxx)

Gateway:  (xxx.xxx.xxx.xxx)

## 7.2.17 RIP (Routing Information Protocol)

**Operation Mode -> Setup -> Access Control**

The Routing Information Protocol (RIP) is a dynamic routing protocol used in local and wide

area networks

### RIP

---

**Enable RIP**

**Host Name:**

**Password:**

**Management Port:**

**Setup RIP Interface**

**Wan Port**

**Lan Port**

## 7.3 Radio2: AP Mode Settings

The Radio2 is working in Access Point Mode. The default SSID is “AirLive2”.

When you select “Radio2” as the interface, the following screen will appear:

### Wireless Settings

**Interface:**  ▼

**Disable Wireless LAN Interface (2)**

**Band:**  ▼

**SSID:**

**Channel:**  ▼

**Security:**

**Advance:**

**Access Control:**

**Associated Clients:**

### 7.3.1 Basic Wireless Settings

- **Band:** You can choose between “802.11g/b”, “802.11g”, or “802.11b”. We recommend leaving the setting at “802.11g/b”.
- **SSID:** The SSID setting of the remote AP. If you are not sure, you can click on “Site Survey” button to scan for AP.
- **Channel:** Wireless Channel used. For EU, it is channel 1~13. For U.S.A., it is channel 1~11.

### 7.3.2 Security Settings

#### **Operation Mode -> Setup -> Security Settings**

Security settings allow you to use encryption to secure your data from eavesdropping. You can select different security policy to provide association authentication and/or data encryption. The G.DUO features various security policies including WEP, 802.1x, WPA, WPA Personal, WPA2, WPA2 Personal, WPA Mixed.

## WEP

WEP Encryption is the oldest and most available encryption method. However, it is also the least secure.

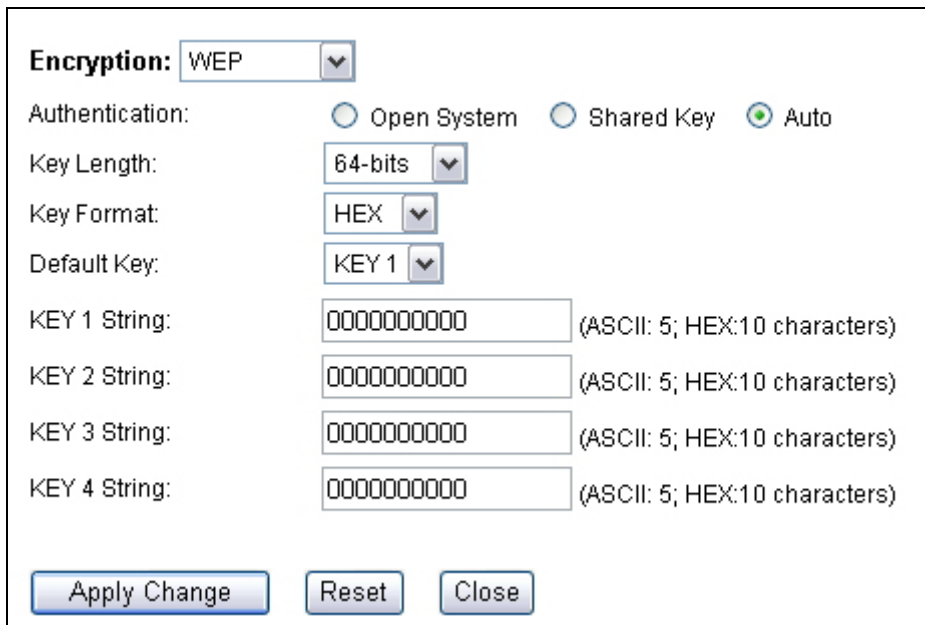

**Encryption:** WEP

Authentication:  Open System  Shared Key  Auto

Key Length: 64-bits

Key Format: HEX

Default Key: KEY 1

KEY 1 String: 0000000000 (ASCII: 5; HEX:10 characters)

KEY 2 String: 0000000000 (ASCII: 5; HEX:10 characters)

KEY 3 String: 0000000000 (ASCII: 5; HEX:10 characters)

KEY 4 String: 0000000000 (ASCII: 5; HEX:10 characters)

Apply Change Reset Close

- **Select one of the WEP key for wireless network:** There are total of 4 possible keys for WEP encryption. You need to choose which key will be used for encryption. All wireless devices on the same network have to use the same settings. We recommend using WEP Key 1 as in default setting.

- **Authentication:** 2 types of Authentication are offered. Open system and Shared key. If you are not sure which one to use, please select “Auto”.
- **Key Length:** The G.DUO offers 64bit and 128 bit for WEP key length. The longer the Key Length, the more secure the encryption is.
- **Key Type:** 2 types are available: ASCII and HEX. ASCII is a string of ASCII code including alphabetical characters, space, signs and numbers (i.e. “airlivepass12”). HEX is a string of 16-bit hexadecimal digits (0..9, a, b, c, d, e, f). All wireless devices on the network must match the exact key length and Key type. Some Wireless clients only allow HEX type for WEP.
- **ASCII-64:** This is a key with 64-bit key length of ASCII type. Please enter **5** ASCII Characters if you choose this option. For example, “passw”
- **HEX-64:** This is a key with 64-bit key length of HEX type. Please enter **10** Hexadecimal digits if you choose this option. For example, “12345abcdef”
- **ASCII-128:** This is a key with 64-bit key length of ASCII type. Please enter **13** ASCII Characters if you choose this option. For example, “airlivewepkey”
- **HEX-128:** This is a key with 128-bit key length of HEX type. Please enter **26** Hexadecimal digits if you choose this option. For example, “1234567890abcdef1234567890”

## WPA-Personal, WPA2-Personal, WPA-Mixed (Pre-Shared Key)

The WPA Personal is also known as “WPA-PSK” encryption. Wi-Fi Protected Access (WPA) introduces the Temporal Key Integrity Protocol (TKIP) that provides added security. WPA2 adds full support for 802.11i standard and the CCMP (AES Encryption). The WPA-Mixed tries to authenticate wireless clients using both WPA-PSK or WPA2-PSK.

### Radio 2 Security Setup

---

Encryption:  ▼

Authentication:  ▼

WPA Cipher Suite:  TKIP  AES  Mixed

Pre-Shared Key Format:  ▼

Pre-Shared Key:

- **Encryption Type:** There are two encryption types **TKIP** and **CCMP (AES)**. While

CCMP provides better security than TKIP, some wireless client stations may not be equipped with the hardware to support it. You can select **Mixed** to allow TKIP clients and CCMP clients to connect to the Access Point at the same time.

- **Pre-Shared Key Format:** You can select between Passphrase(ASCII) or HEX format. Please select Passphrase if you are not sure what to use.
- **Pre-Shared Key:** Enter the password key here..

### WPA-Enterprise, WPA2-Enterprise, WPA-Mixed Enterprise (Radius)

Wi-Fi Protected Access (WPA) Enterprise uses Radius Server as the authenticator. WPA2 adds full support for 802.11i standard and the CCMP (AES Encryption). The WPA-Mixed tries to authenticate wireless clients using both WPA or WPA2.

**Encryption:**

**Authentication:**

**WPA Cipher Suite:**  TKIP  AES  Mixed

**Server IP Address:**  (xxx.xxx.xxx.xxx)

**Server Port:**  (1024-65535)

**Server Password:**

### 7.3.3 Advance (Wireless Settings)

**Fragment Threshold:**  (256-2346)

**RTS Threshold:**  (0-2347)

**Beacon Interval:**  ( 20-1024; unit 1ms)

**Ack Timeout:**  (0-255; unit 4us)

**Preamble Type:**  Long Preamble:  Short Preamble:

**IAPP:**  Enable  Disable

**BG Protection:**  Enable  Disable

**Hide SSID:**  Enable

**Isolation:**  Enable

**Tx Power Level:**

- **Fragmentation:** When the size of a unicast frame exceeds the fragmentation threshold, it will be fragmented before the transmission. It should have a value of 256-2346 bytes, with a default of 2346. If you experience a high packet error rate, you should slightly decrease the Fragmentation Threshold.
- **RTS Threshold:** RTS/CTS frames are used to gain control of the medium for transmission. Any unicast (data or control) frames larger than specified RTS threshold must be transmitted following the RTS/CTS handshake exchange mechanism. The RTS threshold should have a value between 256-2347 bytes, with a default of **2347**. It is recommended that this value does not deviate from the default too much.
- **Beacon Interval:** The device broadcasts beacon frames regularly to announce its existence. The beacon Interval specifies how often beacon frames are transmitted in time unit of milliseconds. The default value is **100**, and a valid value should be between 1 and 65,535.
- **AckTimeOut:** When a packet is sent out from one wireless station to the other, it will wait for an Acknowledgement frame from the remote station. The station will only wait for a certain amount of time, this time is called the ACK timeout. In most conditions, please put ACKtimeout value at zero(default value). The AP will calculate the ACKtimeout automatically when the value is zero. However, you can also enter the ACKtimeout manually.
- **Preamble Type:** A preamble is a signal used in wireless environment to synchronize the transmitting timing including Synchronization and Start frame delimiter. In a "noisy" network environment, the Preamble Type should be set to Long Preamble. The Short Preamble is intended for applications where minimum overhead and maximum performance is desired. If in a "noisy" network environment, the performance will be decreased.
- **IAPP:** IAPP (Inter Access Point Protocol) is designed for the enforcement of unique association throughout a ESS (Extended Service Set) and a secure exchange of station's security context between current access point (AP) and new AP during handoff period.
- **BG Protection:** The 802.11g standard includes a protection mechanism to ensure mixed 802.11b and 802.11g operation. If there is no such kind of mechanism exists, the two kinds of standards may mutually interfere and decrease network's performance..
- **Hide SSID:** Enable Hide SSID will make the AP network's SSID invisible. A device can link with the AP only if correct SSID name is entered.



- **Isolation:** Enable Isolation will prevent wireless clients to see each other on the network.
- **TX Power Level:** You can set your TX Output power level here. Please note the maximum allowable TX output power in EU is 20dBm. Please do not exceed your country's legal limit.

### 7.3.4 Access Control

#### *Operation Mode -> Setup -> Access Control*

The G.DUO allows you to define a list of MAC addresses that are allowed or denied to access the wireless network. This function is available only for Access Point and Gateway modes.

**Access Control Mode:**

**Add Access Control Rule:**

MAC Address:  (xxxxxxxxxxxx)

Comment

**Current Access Control List**

MAC Address:	Comment	Select
<input type="button" value="Delete Selected"/> <input type="button" value="Delete All"/>		

#### ■ Access Control List

- **Disable:** When selected, no MAC address filtering will be performed.
- **Allow list:** When selected, data traffic from only the specified devices in the table will be allowed in the network.
- **Deny list:** When selected, data traffic from the devices specified in the table will be denied/discarded by the network.

### 7.3.5 Associated Clients

Click on this to show the current wireless clients associated to the AP. It will display MAC addresss, Transmit packet, Tx rate, power saving, expire time, and signal strength.

MAC Address	Tx Packet	Tx Rate (Mbps)	Tx Rate (Mbps)	Power Saving	Expired Time (s)	RSSI
None	---	---	---	---	---	---

# 8

## WDS + AP Mode

In this chapter, we will explain about the wireless settings for Client + AP Mode. Please be sure to read through Chapter 1.4 and Chapter 3's "Introduction to Web Management" and "Initial Configurations" first.

It is highly recommended that you use directional antenna for Radio1 in this mode to achieve larger coverage and avoid mutual interference. If you need to use the supplied 2dBi omni antennas, please adjust them according to the diagram below:



### 8.1 Application for WDS + AP Mode

In this mode, the Radio1 is working in Bridge mode to connect with another Remote Bridge. Radio2 is performing as an Access Point. The Radio1 can be used to build backbone connection in a hotel hotspot network. Radio2 can be used to provide hotspot service.

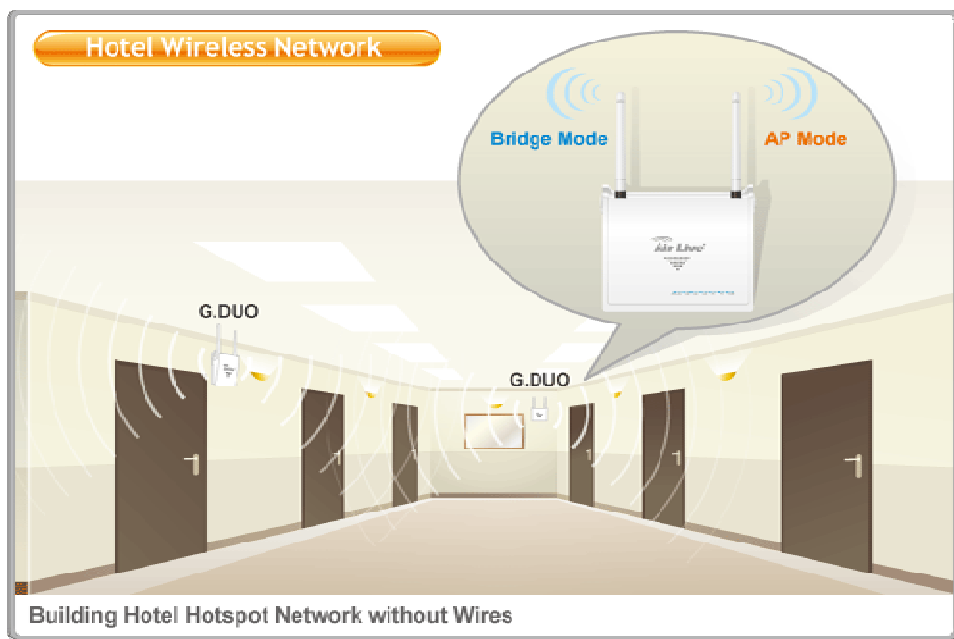

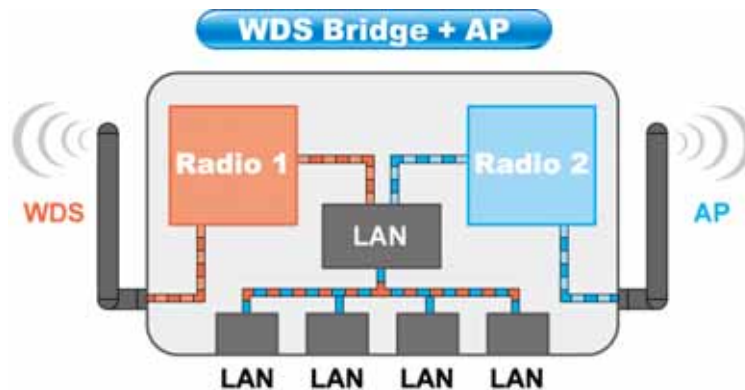

## 8.2 Radio1: WDS Bridge Settings

The Radio1 is working in WDS Bridge for connection to remote Bridge network. When you select “Radio1” as the interface, the following screen will appear.

**Wireless Settings**

Interface: RADIO 1 (WDS) ▼

Disable Wireless LAN Interface (1)

Band: 802.11 b/g ▼

Channel: Channel 1 ▼

WDS Security: [Setup](#)

Advance: [Setup](#)

MAC Address:  (xxxxxxxxxxxx) [Site survey](#)

Comment:  (WDS device information)

[Apply Change](#) [Reset](#) [Show Statistics](#)

**Current WDS Device List:**

MAC Address	Comment	Select
<a href="#">Delete Selected</a> <a href="#">Delete All</a> <a href="#">Reset</a>		

### 8.2.1 Basic Wireless Settings

- **Band:** You can choose between “802.11g/b”, “802.11g”, or “802.11b”. We recommend to leave the setting at “802.11g/b”.
- **Channel:** Wireless Channel used. For EU, it is channel 1~13. For U.S.A., it is

channel 1~11.

**802.11d Spanning Tree:** Enable this option to prevent network loop from forming. It is highly recommended to turn on this option if you have more than 2 entries in the WDS network. You can find this function in the “System Configuration”->”LAN Interface Setup” page.

## 8.2.2 WDS Security

### Operation Mode -> Setup -> Security Settings

Security settings allow you to use encryption to secure your data from eavesdropping. You can select different security policy to provide association authentication and/or data encryption. The G.DUO features various security policies including WEP, 802.1x, WPA, WPA Personal, WPA2, WPA2 Personal, WPA Mixed.

### WEP

WEP Encryption is the oldest and most available encryption method. However, it is also the least secure.

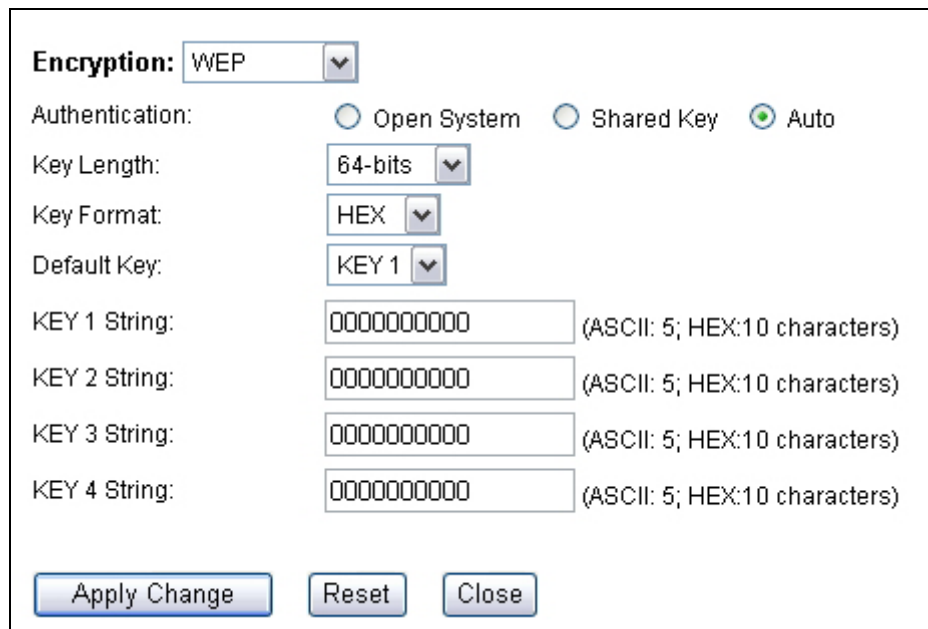

The screenshot shows a configuration window for WEP encryption. At the top, 'Encryption:' is set to 'WEP'. Below this, there are three radio buttons for 'Authentication': 'Open System', 'Shared Key', and 'Auto' (which is selected). The 'Key Length:' is set to '64-bits', and 'Key Format:' is set to 'HEX'. The 'Default Key:' is set to 'KEY 1'. There are four text input fields for 'KEY 1 String', 'KEY 2 String', 'KEY 3 String', and 'KEY 4 String', each containing '0000000000' and followed by '(ASCII: 5; HEX:10 characters)'. At the bottom, there are three buttons: 'Apply Change', 'Reset', and 'Close'.

- **Select one of the WEP key for wireless network:** There are total of 4 possible keys for WEP encryption. You need to choose which key will be used for encryption. All wireless devices on the same network have to use the same settings. We recommend using WEP Key 1 as in default setting.
- **Authentication:** 2 types of Authentication are offered. Open system and

Shared key. If you are not sure which one to use, please select “Auto”.

- **Key Length:** The G.DUO offers 64bit and 128 bit for WEP key length. The longer the Key Length, the more secure the encryption is.
- **Key Type:** 2 types are available: ASCII and HEX. ASCII is a string of ASCII code including alphabetical characters, space, signs and numbers (i.e. “airlivepass12”). HEX is a string of 16-bit hexadecimal digits (0..9, a, b, c, d, e, f). All wireless devices on the network must match the exact key length and Key type. Some Wireless clients only allow HEX type for WEP.
- **ASCII-64:** This is a key with 64-bit key length of ASCII type. Please enter **5** ASCII Characters if you choose this option. For example, “passw”
- **HEX-64:** This is a key with 64-bit key length of HEX type. Please enter **10** Hexadecimal digits if you choose this option. For example, “12345abcdef”
- **ASCII-128:** This is a key with 64-bit key length of ASCII type. Please enter **13** ASCII Characters if you choose this option. For example, “airlivewepkey”
- **HEX-128:** This is a key with 128-bit key length of HEX type. Please enter **26** Hexadecimal digits if you choose this option. For example, “1234567890abcdef1234567890”

## WPA-PSK, WPA2-PSK

Wi-Fi Protected Access (WPA) introduces the Temporal Key Integrity Protocol (TKIP) that provides added security. WPA2 adds full support for 802.11i standard and the CCMP (AES Encryption). The WPA Mixed tries to authenticate wireless clients using both WPA-PSK or WPA2-PSK.

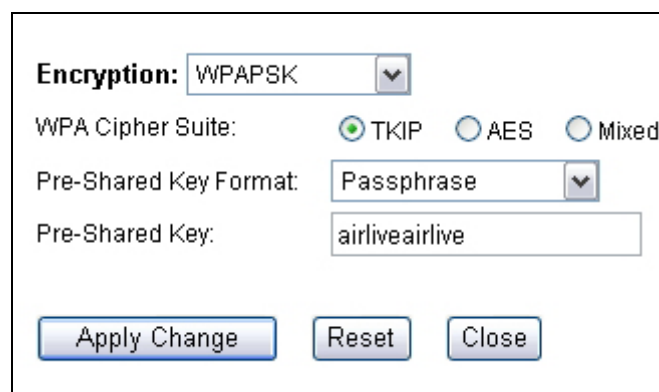

The screenshot shows a configuration window for WPA-PSK/WPA2-PSK. It includes the following fields and controls:

- Encryption:** A dropdown menu set to WPAPSK.
- WPA Cipher Suite:** Three radio buttons: TKIP (selected), AES, and Mixed.
- Pre-Shared Key Format:** A dropdown menu set to Passphrase.
- Pre-Shared Key:** A text input field containing the value "airliveairlive".
- Buttons:** "Apply Change", "Reset", and "Close".

- **Encryption Type:** There are two encryption types **TKIP** and **CCMP (AES)**. While CCMP provides better security than TKIP, some wireless client stations may not be equipped with the hardware to support it. You can select **Mixed** to allow TKIP clients and CCMP clients to connect to the Access Point at the same time.
- **Pre-Shared Key Format:** You can select between Passphrase(ASCII) or HEX format. Please select Passphrase if you are not sure what to use.

- **Pre-Shared Key:** Enter the password key here..

### 8.2.3 Advance (Wireless Settings)

*Operation Mode -> Setup -> Advance*

#### Radio 1 Advance Setup

---

Fragment Threshold:  (256-2346)

RTS Threshold:  (0-2347)

Beacon Interval:  (20-1024; unit 1ms)

Ack Timeout:  (0-255; unit 4us)

Preamble Type:  Long Preamble:  Short Preamble:

IAPP:  Enable  Disable

BG Protection:  Enable  Disable

Tx Power Level:  ▼

- **Fragmentation:** When the size of a unicast frame exceeds the fragmentation threshold, it will be fragmented before the transmission. It should have a value of 256-2346 bytes, with a default of 2346. If you experience a high packet error rate, you should slightly decrease the Fragmentation Threshold.
- **RTS Threshold:** RTS/CTS frames are used to gain control of the medium for transmission. Any unicast (data or control) frames larger than specified RTS threshold must be transmitted following the RTS/CTS handshake exchange mechanism. The RTS threshold should have a value between 256-2347 bytes, with a default of **2347**. It is recommended that this value does not deviate from the default too much.
- **Beacon Interval:** The device broadcasts beacon frames regularly to announce its existence. The beacon Interval specifies how often beacon frames are transmitted in time unit of milliseconds. The default value is **100**, and a valid value should be between 1 and 65,535.
- **AckTimeOut:** When a packet is sent out from one wireless station to the other, it will wait for an Acknowledgement frame from the remote station. The station will only wait for a certain amount of time, this time is called the ACK timeout. In most conditions, please put ACKtimeout value at zero(default value). The AP will calculate

the ACKtimeout automatically when the value is zero. However, you can also enter the ACKtimeout manually.

- **Preamble Type:** A preamble is a signal used in wireless environment to synchronize the transmitting timing including Synchronization and Start frame delimiter. In a "noisy" network environment, the Preamble Type should be set to Long Preamble. The Short Preamble is intended for applications where minimum overhead and maximum performance is desired. If in a "noisy" network environment, the performance will be decreased.
- **BG Protection:** The 802.11g standard includes a protection mechanism to ensure mixed 802.11b and 802.11g operation. If there is no such kind of mechanism exists, the two kinds of standards may mutually interfere and decrease network's performance..
- **TX Power Level:** You can set your TX Output power level here. Please note the maximum allowable TX output power in EU is 20dBm. Please do not exceed your country's legal limit.

### 8.2.4 Site Survey

**Operation Mode -> Setup -> Site Survey**

WDS requires you to enter the MAC addresses of other remote bridges in the network. You can scan for wireless networks around your location using the Site Survey function. Then copy the MAC address of the remote Bridge into WDS table.

When you click on Site Survey, the following screen will appear. It might take awhile depending on number of available Bridges in the area.

**Radio 1 Site Survey**

MAC Addresses

↓

SSID	BSSID	Channel	Type	Encrypt	Signal	Select
airlive	00:4f:62:00:04:03	11 (B+G)	AP	no	43	<input type="radio"/>
ggggway	00:4f:62:94:02:11	1 (B+G)	AP	WPA-PSK	40	<input type="radio"/>
default	02:1b:77:00:8c:78	11 (B+G)	Ad hoc	no	21	<input type="radio"/>
OutdoorAP	00:12:0e:b3:b2:b2	11 (B+G)	AP	WPA-PSK	10	<input checked="" type="radio"/>

↓

For antenna alignment. It will display and update the Signal Strength continuously



### 8.2.5 Signal Survey

**Operation Mode -> Setup -> Site Survey -> Signal Survey**

The Signal Survey will continuously display the Signal Strength of the selected SSID for antenna alignment purpose. To use Signal Survey function, please enter the “Site Survey” function first; please refer to the instruction in the above section. Once you select the ESSID and click on the “Signal Survey” button, the following screen will appear.

Signal Survey					
SSID	BSSID	Channel	Type	Encrypt	Signal
airlive2	00:e0:4c:81:86:23	11 (B+G)	AP	no	24

- **BSSID:** This is the remote AP’s MAC address.
- **Channel:** The current scanned channel
- **Signal:** This is signal strength number in percentage in 0 to 100 scale. The higher the number, the better signal.

### 8.2.6 WDS Settings

For Bridge network, it is required to enter the Wireless MAC address of all remote bridges that is connect directly to your G.DUO. The wireless MAC address is also known as BSSID that is display on your site survey result.

**Enable WDS**

**MAC Address:**  (xxxxxxxxxxxx)

**Comment:**  (WDS device information)

**Current WDS Device List:**

MAC Address	Comment	Select

- **MAC Address:** Please enter the Wireless MAC address or BSSID of the remote Bridge. You can usually find it at remote Bridge’s device label.
- **Comment:** If you input anything that will help remind you about which remote Bridge it is.

## 8.3 Radio2: AP Mode Settings

The Radio2 is working in Access Point Mode. The default SSID is “AirLive2”.

When you select “Radio2” as the interface, the following screen will appear:

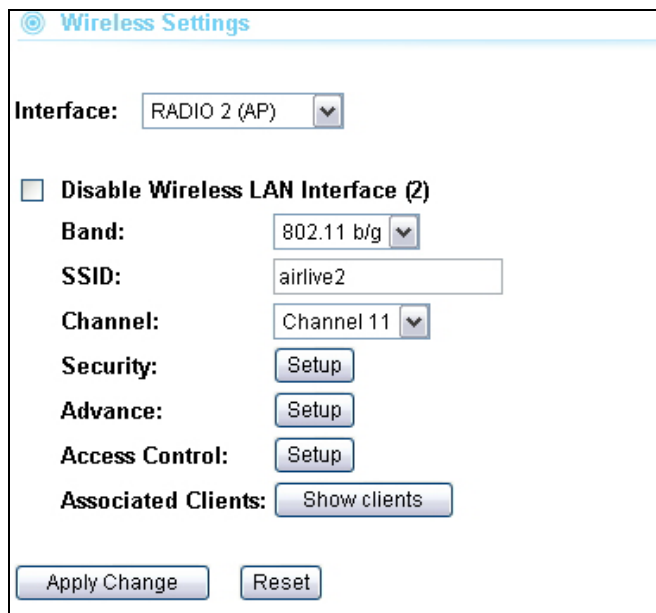

The screenshot shows the 'Wireless Settings' window for 'RADIO 2 (AP)'. It includes a checkbox for 'Disable Wireless LAN Interface (2)', and fields for 'Band' (802.11 b/g), 'SSID' (airlive2), and 'Channel' (Channel 11). There are 'Setup' buttons for Security, Advance, and Access Control, and a 'Show clients' button for Associated Clients. At the bottom are 'Apply Change' and 'Reset' buttons.

### 8.3.1 Basic Wireless Settings

- **Band:** You can choose between “802.11g/b”, “802.11g”, or “802.11b”. We recommend leaving the setting at “802.11g/b”.
- **SSID:** The SSID setting of the remote AP. If you are not sure, you can click on “Site Survey” button to scan for AP.
- **Channel:** Wireless Channel used. For EU, it is channel 1~13. For U.S.A., it is channel 1~11.

### 8.3.2 Security Settings

#### **Operation Mode -> Setup -> Security Settings**

Security settings allow you to use encryption to secure your data from eavesdropping. You can select different security policy to provide association authentication and/or data encryption. The G.DUO features various security policies including WEP, 802.1x, WPA,

WPA Personal, WPA2, WPA2 Personal , WPA Mixed.

## WEP

WEP Encryption is the oldest and most available encryption method. However, it is also the least secure.

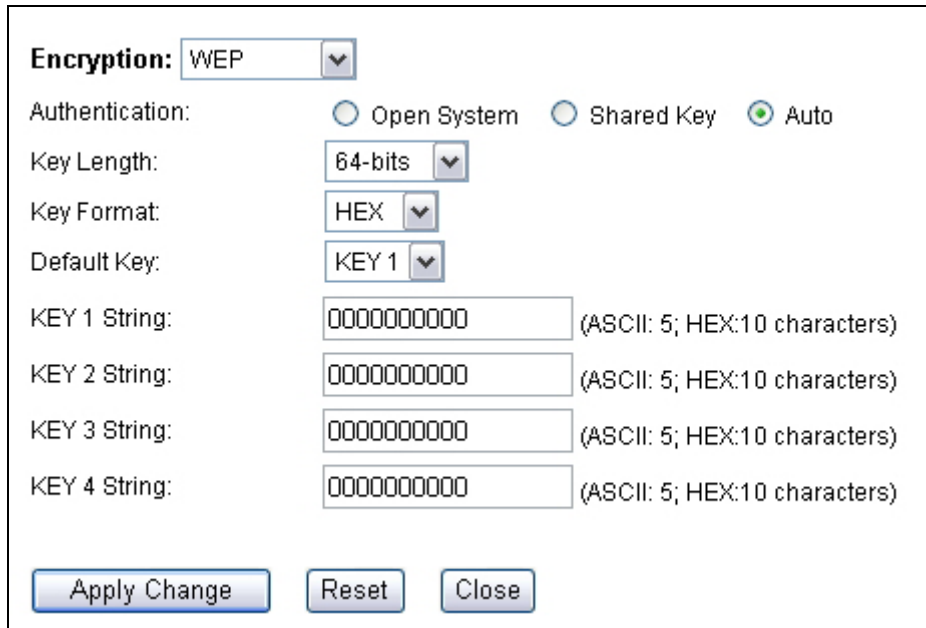

**Encryption:** WEP

Authentication:  Open System  Shared Key  Auto

Key Length: 64-bits

Key Format: HEX

Default Key: KEY 1

KEY 1 String: 0000000000 (ASCII: 5; HEX:10 characters)

KEY 2 String: 0000000000 (ASCII: 5; HEX:10 characters)

KEY 3 String: 0000000000 (ASCII: 5; HEX:10 characters)

KEY 4 String: 0000000000 (ASCII: 5; HEX:10 characters)

Apply Change Reset Close

- **Select one of the WEP key for wireless network:** There are total of 4 possible keys for WEP encryption. You need to choose which key will be used for encryption. All wireless devices on the same network have to use the same settings. We recommend using WEP Key 1 as in default setting.
- **Authentication:** 2 types of Authentication are offered. Open system and Shared key. If you are not sure which one to use, please select “Auto”.
- **Key Length:** The G.DUO offers 64bit and 128 bit for WEP key length. The longer the Key Length, the more secure the encryption is.
- **Key Type:** 2 types are available: ASCII and HEX. ASCII is a string of ASCII code including alphabetical characters, space, signs and numbers (i.e. “airlivepass12”). HEX is a string of 16-bit hexadecimal digits (0..9, a, b, c, d, e, f). All wireless devices on the network must match the exact key length and Key type. Some Wireless clients only allow HEX type for WEP.
- **ASCII-64:** This is a key with 64-bit key length of ASCII type. Please enter **5** ASCII Characters if you choose this option. For example, “passw”
- **HEX-64:** This is a key with 64-bit key length of HEX type. Please enter **10** Hexadecimal digits if you choose this option. For example, “12345abcdef”
- **ASCII-128:** This is a key with 64-bit key length of ASCII type. Please enter **13** ASCII Characters if you choose this option. For example, “airlivewepkey”

- **HEX-128:** This is a key with 128-bit key length of HEX type. Please enter **26** Hexadecimal digits if you choose this option. For example, "1234567890abcdef1234567890"

## WPA-Personal, WPA2-Personal, WPA-Mixed (Pre-Shared Key)

The WPA Personal is also known as "WPA-PSK" encryption. Wi-Fi Protected Access (WPA) introduces the Temporal Key Integrity Protocol (TKIP) that provides added security. WPA2 adds full support for 802.11i standard and the CCMP (AES Encryption). The WPA-Mixed tries to authenticate wireless clients using both WPA-PSK or WPA2-PSK.

### Radio 2 Security Setup

---

**Encryption:**

**Authentication:**

**WPA Cipher Suite:**
 TKIP
  AES
  Mixed

**Pre-Shared Key Format:**

**Pre-Shared Key:**

- **Encryption Type:** There are two encryption types **TKIP** and **CCMP (AES)**. While CCMP provides better security than TKIP, some wireless client stations may not be equipped with the hardware to support it. You can select **Mixed** to allow TKIP clients and CCMP clients to connect to the Access Point at the same time.
- **Pre-Shared Key Format:** You can select between Passphrase(ASCII) or HEX format. Please select Passphrase if you are not sure what to use.
- **Pre-Shared Key:** Enter the password key here..

## WPA-Enterprise, WPA2-Enterprise, WPA-Mixed Enterprise (Radius)

Wi-Fi Protected Access (WPA) Enterprise uses Radius Server as the authenticator. WPA2 adds full support for 802.11i standard and the CCMP (AES Encryption). The WPA-Mixed tries to authenticate wireless clients using both WPA or WPA2.

<b>Encryption:</b>	WPA	▼
Authentication:	Enterprise(RADIUS) ▼	
WPA Cipher Suite:	<input checked="" type="radio"/> TKIP <input type="radio"/> AES <input type="radio"/> Mixed	
Server IP Address:	0.0.0.0	(xxx.xxx.xxx.xxx)
Server Port:	1812	(1024-65535)
Server Password:	<input type="text"/>	
<input type="button" value="Apply Change"/> <input type="button" value="Reset"/> <input type="button" value="Close"/>		

### 8.3.3 Advance (Wireless Settings)

*Operation Mode -> Setup -> Advance*

Fragment Threshold:	2346	(256-2346)
RTS Threshold:	2347	(0-2347)
Beacon Interval:	100	( 20-1024; unit 1ms)
Ack Timeout:	0	(0-255; unit 4us) <input type="button" value="Calculation"/>
Preamble Type:	<input checked="" type="radio"/> Long Preamble: <input type="radio"/> Short Preamble:	
IAPP:	<input checked="" type="radio"/> Enable <input type="radio"/> Disable	
BG Protection:	<input checked="" type="radio"/> Enable <input type="radio"/> Disable	
Hide SSID:	<input type="checkbox"/> Enable	
Isolation:	<input type="checkbox"/> Enable	
Tx Power Level:	Level 6 (About 14.4dB) ▼	
<input type="button" value="Apply Change"/> <input type="button" value="Reset"/> <input type="button" value="Close"/>		

- **Fragmentation:** When the size of a unicast frame exceeds the fragmentation threshold, it will be fragmented before the transmission. It should have a value of 256-2346 bytes, with a default of 2346. If you experience a high packet error rate, you should slightly decrease the Fragmentation Threshold.
- **RTS Threshold:** RTS/CTS frames are used to gain control of the medium for transmission. Any unicast (data or control) frames larger than specified RTS threshold must be transmitted following the RTS/CTS handshake exchange mechanism. The RTS threshold should have a value between 256-2347 bytes, with a default of **2347**. It is recommended that this value does not deviate from the default too much.

- **Beacon Interval:** The device broadcasts beacon frames regularly to announce its existence. The beacon Interval specifies how often beacon frames are transmitted in time unit of milliseconds. The default value is **100**, and a valid value should be between 1 and 65,535.
- **AckTimeOut:** When a packet is sent out from one wireless station to the other, it will wait for an Acknowledgement frame from the remote station. The station will only wait for a certain amount of time, this time is called the ACK timeout. In most conditions, please put ACKtimeout value at zero(default value). The AP will calculate the ACKtimeout automatically when the value is zero. However, you can also enter the ACKtimeout manually.
- **Preamble Type:** A preamble is a signal used in wireless environment to synchronize the transmitting timing including Synchronization and Start frame delimiter. In a "noisy" network environment, the Preamble Type should be set to Long Preamble. The Short Preamble is intended for applications where minimum overhead and maximum performance is desired. If in a "noisy" network environment, the performance will be decreased.
- **IAPP:** IAPP (Inter Access Point Protocol) is designed for the enforcement of unique association throughout a ESS (Extended Service Set) and a secure exchange of station's security context between current access point (AP) and new AP during handoff period.
- **BG Protection:** The 802.11g standard includes a protection mechanism to ensure mixed 802.11b and 802.11g operation. If there is no such kind of mechanism exists, the two kinds of standards may mutually interfere and decrease network's performance..
- **Hide SSID:** Enable Hide SSID will make the AP network's SSID invisible. A device can link with the AP only if correct SSID name is entered.
- **Isolation:** Enable Isolation will prevent wireless clients to see each other on the network.
- **TX Power Level:** You can set your TX Output power level here. Please note the maximum allowable TX output power in EU is 20dBm. Please do not exceed your country's legal limit.

### 8.3.4 Access Control

#### ***Operation Mode -> Setup -> Access Control***

The G.DUO allows you to define a list of MAC addresses that are allowed or denied to

access the wireless network. This function is available only for Access Point and Gateway modes.

**Access Control Mode:** Disable

**Add Access Control Rule:**

MAC Address:  (xxxxxxxxxxxxxx)

Comment

**Current Access Control List**

MAC Address:	Comment	Select
<input type="button" value="Delete Selected"/> <input type="button" value="Delete All"/>		

■ **Access Control List**

- **Disable:** When selected, no MAC address filtering will be performed.
- **Allow list:** When selected, data traffic from only the specified devices in the table will be allowed in the network.
- **Deny list:** When selected, data traffic from the devices specified in the table will be denied/discarded by the network.

### 8.3.5 Associated Clients

Click on this to show the current wireless clients associated to the AP. It will display MAC addresss, Trasmit packet, Tx rate, power saving, expire time, and signal strength.

MAC Address	Tx Packet	Tx Rate (Mbps)	Tx Rate (Mbps)	Power Saving	Expired Time (s)	RSSI
None	---	---	---	---	---	---

# 9

## System Configuration Menu

In this chapter, we will explain about *System Configurations* in web management interface. Please be sure to read through Chapter 3's “*Introduction to Web Management*” and “*Initial Configurations*” first.

### 9.1 Menu Structure

When you click on the “System Configuration” menu on the top menu bar, the following screen will appear. The system configuration includes all non-wireless settings. We will explain their functions here.

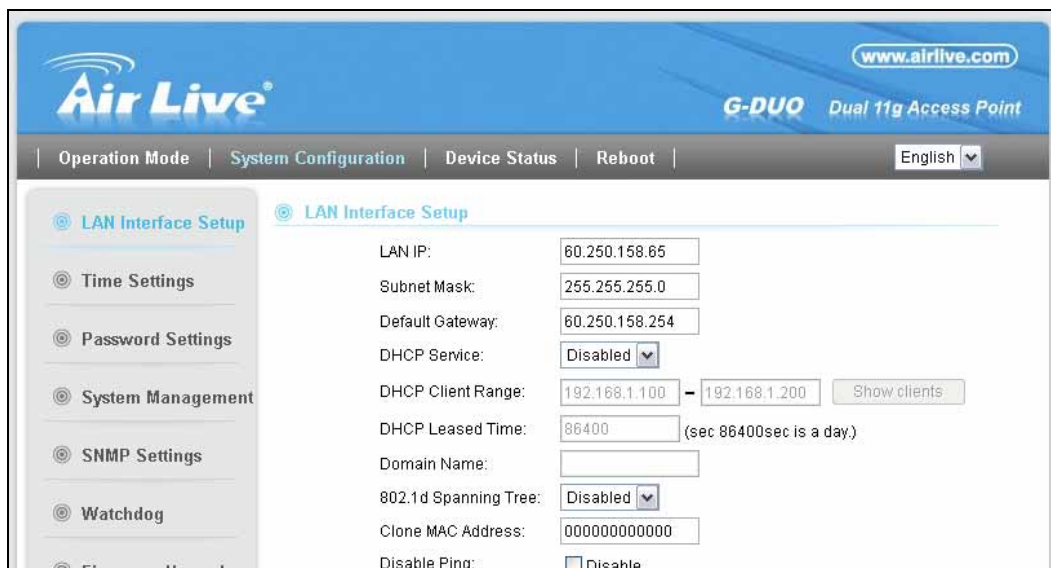

### 9.2 LAN Interface Setup

#### *System Configurations*>> *LAN Interface Setup*

This menu is where you can configuration all the aspect about LAN interface including IP address, DHCP server settings..etc.



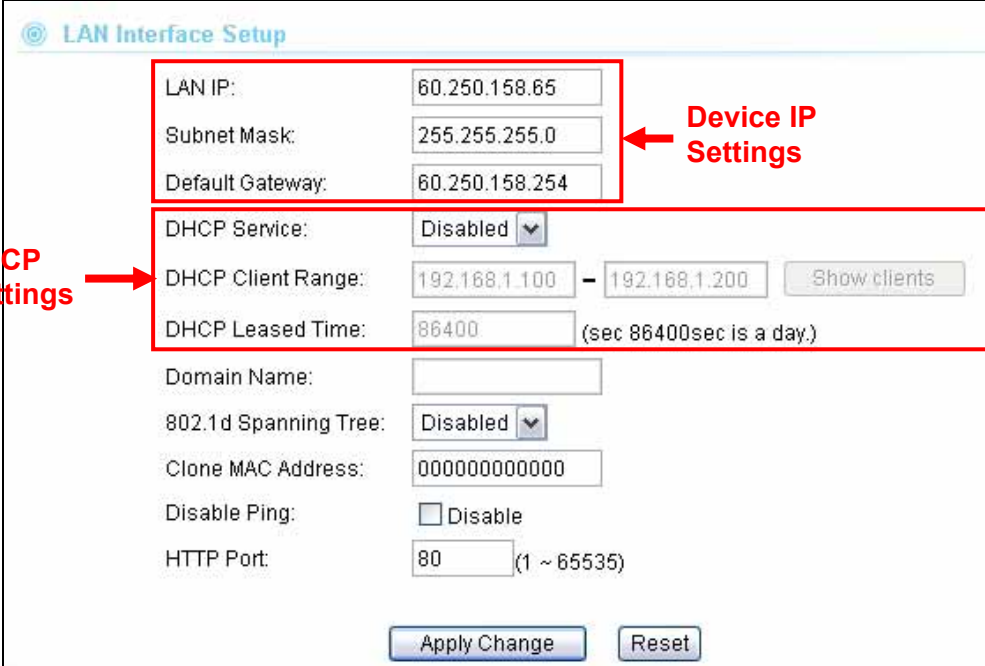

**LAN Interface Setup**

LAN IP: 60.250.158.65  
 Subnet Mask: 255.255.255.0  
 Default Gateway: 60.250.158.254

**Device IP Settings**

DHCP Service: Disabled  
 DHCP Client Range: 192.168.1.100 - 192.168.1.200 Show clients  
 DHCP Leased Time: 86400 (sec 86400sec is a day.)

**DHCP Settings**

Domain Name:   
 802.1d Spanning Tree: Disabled  
 Clone MAC Address: 000000000000  
 Disable Ping:  Disable  
 HTTP Port: 80 (1 ~ 65535)

Apply Change Reset

## 9.2.1 DHCP Settings

- **DHCP Service:** You can enable or disable DHCP server here.
  - **Disable:** Disable DHCP server
  - **Client:** The LAN interface will get IP address from DHCP server
  - **Server(default):** The G.DUO will act as DHCP server to provide IP addresses to the clients on the LAN/Wireless interface. By default, the DHCP server is on.
- **DHCP Client Range:** You can define the IP pool from which the DHCP clients can get IP address.. Click on “Show Clients” to see the current DHCP client table.
- **DHCP Release Time:** You can define how long the G.DUO will reserve IP address for a particular PC or Device here.

## 9.2.2 802.1d Spanning Tree

Enable this will prevent forming of network loop.

## 9.2.3 Clone MAC Address

You can change the MAC address of your LAN port to other value here.

## 9.2.4 Disable PING

If you do not wish the G.DUO to respond to remote PING command, please disable it here.

## 9.2.5 Add DHCP Static Lease Client

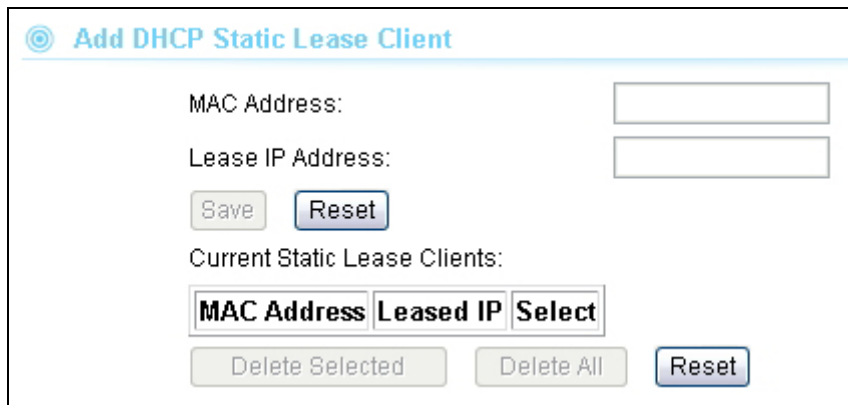

If you want to lock IP address to a MAC address, you should add DHCP clients to the “Static Lease Client”. Up to 40 entries can be entered. Below is the procedure for adding an entry:

1. Enter the MAC address of the device
2. Enter the IP address of the device
3. Click on the “Add” button

## 9.3 Time Settings

### System Configuration ->Time Settings

You can set the NTP Time Server for your G.DUO’s internal clock here. You can use NTP server function so your G.DUO will check with NTP to set time automatically upon each startup. Thus, it prevents the clock losing track of time during reboot or power outage.



Below is the procedure to set your NTP server

1. Check the “Enable NTP Client Update”

2. Select your time Zone
3. Select your NTP server
4. Click on “Apply Change”

## 9.4 Password Settings

### System Configuration -> Password Settings

The G.DUO’s password protection is turned off by default. To enable password protection or change password, just enter your username and password, and click on “Apply Change” button.



The screenshot shows the Air Live G-DUO web interface. The top navigation bar includes 'Operation Mode', 'System Configuration' (highlighted with a red box), 'Device Status', and 'Reboot'. A language dropdown is set to 'English'. The left sidebar contains menu items: LAN Interface Setup, Time Settings, Password Settings (highlighted with a red box), System Management, and SNMP Settings. The main content area is titled 'Password Settings' and contains three input fields: 'User Name:', 'New Password:', and 'Confirmed Password:'. Below these fields are two buttons: 'Apply Change' and 'Reset'.

## 9.5 System Management

### System Configuration -> System Management

In this page, administrator can change the management parameters and disable/enable management interface.



The screenshot shows the 'System Management' page. It is divided into three sections: 'CLI', 'Public Key Upload', and 'System Timeout'. The 'CLI' section has two checkboxes: 'Enable SSH Daeman' and 'Enable Telnet Daeman', both of which are unchecked. Below these are 'Apply Change' and 'Reset' buttons. The 'Public Key Upload' section has a text input field for 'Select Public Key File', a '浏览...' (Browse) button, and an 'Upload' button. The 'System Timeout' section has a 'Value:' label followed by a text input field containing '5' and the text 'min (0 means no timeout)'. Below this are 'Apply Change' and 'Reset' buttons.

### CLI (Command Line Interface):

You can enable or disable Telnet and SSH management interface from here.

**Public Key Upload:** You can upload your public for the SSH authentication here.

**System Timeout Value:** This is the time the AP will wait when there is no configuration activity, then it will log out the user. We strongly recommend to leave the value at zero.

## 9.6 SNMP Settings

### System Configuration -> SNMP Settings

The G.DUO's SNMP management is OFF by default. You should come to this page to enable the SNMP management. The G.DUO supports RFC-1213MIB and SNMPv2 MIB.

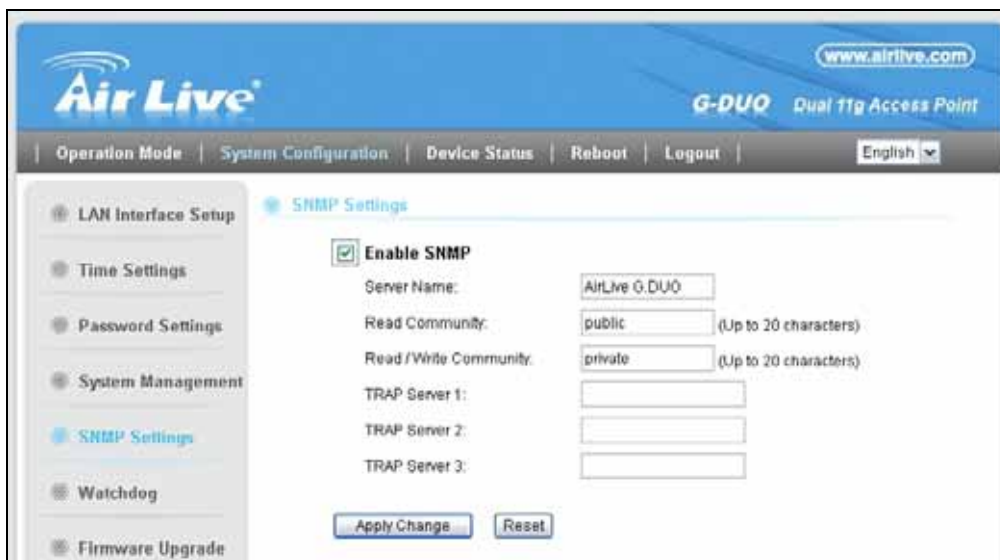

- **System Name:** A name that you assign to your G.DUO. It is an alphanumeric string of up to 30 characters.
- **Read Community:** If you intend the router to be managed from a remote SNMP management station, you need to configure a read-only “community string” for read-only operation. The community string is an alphanumeric string of up to 15 characters.
- **Read/Write Community:** For read-write operation, you need to configure a write “community string”.
- **Trap Server:**  
A trap server is a remote SNMP management station where special SNMP trap

messages are generated (by the router) and sent to in the network. You can define up to 3 trap servers in the system.

## 9.7 Watchdog

### System Configuration -> Watchdog

The Ping Watchdog will ping remote IP addresses to make sure the wireless connection is active, if not, it can either reconnect or reboot. To prevent the AP from power recycling, the PING watchdog will start 10 minutes after power up to prevent power recycle problem.



- **Watch Interval:** means: "How often the CPE will PING". For example, it will PING once every "1" minute.
- **Watch Host:** This is the IP address for which the Watchdog will ping.
- **Watchdog Actions:** if the Watch Host fail to respond to PING. Then one of the action below will be taken.
  - Reconnect: the G.DUO will attempt to re-establish the connection.
  - Reboot: the G.DUO will do a power recycle.

### 9.7.1 Firmware Upgrade

#### System Configuration -> Firmware Upgrade

You can upgrade the firmware of your G.DUO (the software that controls your G.DUO's operation). Normally, this is done when a new version of firmware offers new features that you want, or solves problems that you have encountered with the current version.



### ■ Upgrade Firmware:

To update the G.DUO firmware, first download the firmware from AirLive web site to your local disk. **Please do not use the firmware for Emergency Upgrade, it might damage your AP!** Then from the above screen enter the path and filename of the firmware file (or click **Browse** to locate the firmware file). Next, Click the **Upgrade** button to start.

The new firmware will be loaded to your G.DUO. After a message appears telling you that the operation is completed, you need to reset the system to have the new firmware take effect.



Do not power off the device while upgrading the firmware. It is recommended that you do not upgrade your G.DUO unless the new firmware has new features you need or if it has a fix to a problem that you've encountered.

## 9.7.2 Configuration Save and Restore

### *System Configuration -> Configuration Save and Restore*

The G.DUO can save and restore the settings to a file. In addition, it has the unique capability to restore only the network or wireless settings. This makes changes of wireless settings across the entire network of AP much easier.

You can save system configuration settings to a file, and later download it back to the G.DUO by following the steps.

**Step 1** Select *Configuration Save and Restore* from the *System Configurations* menu.

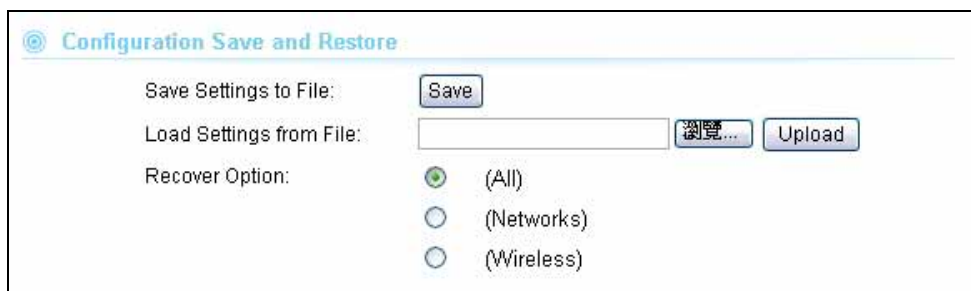

**Step 2** Click on “Save to” and Enter the path of the configuration file to save-to.

**Restore Setting:**

**Step 1:** Choose the Recovery Options

- ◆ All: Restore all settings
- ◆ Networks: Only restore the network parameters, not including wireless
- ◆ Wireless: Only restore the wireless settings.

**Step 2:** Enter the file name in the “Load Settings from File” field. Or click on “Browse” button to location the location of the file.

**Step3:** Click on “Upload” button to restore settings.

## 9.8 Factory Default

### *System Configuration -> Factory Default*

You can reset the configuration of your G.DUO to the factory default settings.

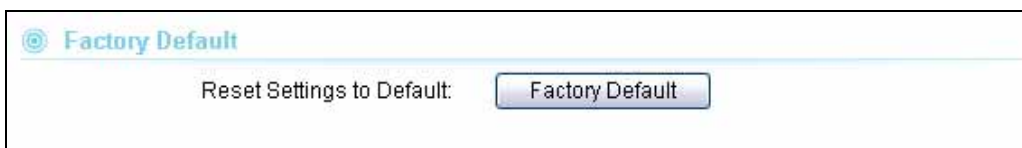



# 10

## Device Status Menu

In this chapter, we will explain the “Device Status” menu in the web management interface. Before you read this chapter, please make sure to read through chapter 3 on “Introduction to Web Management Interface.”

### 10.1 Menu Structure

When you click on the “Device Status” on the top menu bar, the sub menu for device status will appear.



### 10.2 Device Information

This page shows the general information about G.DUO such as Uptime, Firmware version, Wireless Interface...etc. Below are some additional explanations on some status information of this page:

- **Uptime** This displays the time since system last boot up. This is a good indication for how long the system has been alive.
- **Firmware version:** The first G.DUO firmware release is 1.00e10. In general, AirLive will refer to its firmware as exx (such as e10) version on the release note
- **Wireless Interface 1:** This page displays the current settings and status of the Radio 1. It include the BSSID and connection status. The BSSID is also the wireless MAC address that is needed for the WDS entry.
- **Wireless Interface 1:** This page displays the current settings and status of the Radio 2. It include the BSSID and connection status. It also indicates the number of wireless



clients in AP

- **WAN Configuration:** WAN configuration tells you the current status of WAN port such as IP address and connection status.

**Device Information**

Uptime: 0day:0h:19m:37s  
 Firmware Version: V20.3.0.3.3\_b7\_test

**Wireless Interface 1**

Mode: Infrastructure Client  
 Band: 2.4 GHz (B+G)  
 SSID: airlive1  
 Channel Number: 10  
 Encryption: Disabled  
 BSSID: 00:00:00:00:00:00  
 State: Scanning

**Wireless Interface 2**

Mode: AP  
 Band: 2.4 GHz (B+G)  
 SSID: airlive2  
 Channel Number: 11  
 Encryption: Disabled  
 BSSID: 00:12:0e:b3:b2:b2  
 Associated Clients: 0

**WAN Configuration**

Attain IP Protocol: Getting IP from DHCP server...  
 IP Address: 0.0.0.0

### 10.3 Statistic

This page shows the sent and received packet information for Radio1, Radio2, LAN, and WAN interface.

**Statistics**

Interface	Data Path	Packages
<b>Radio 0</b>	Sent Packets	6734
	Received Packets	4940
<b>Radio 1</b>	Sent Packets	36
	Received Packets	18704
<b>Ethernet 0</b>	Sent Packets	990
	Received Packets	971
<b>Ethernet 1</b>	Sent Packets	36
	Received Packets	18711

## 10.4 Client Table (ARP Table)

This table is also known as ARP table. It will show all wireless and wired device connected to the G.DUO. If you want to look at the wireless clients only, you can go to the “Wireless Settings” page in AP or Gateway mode for “Show Client” button.

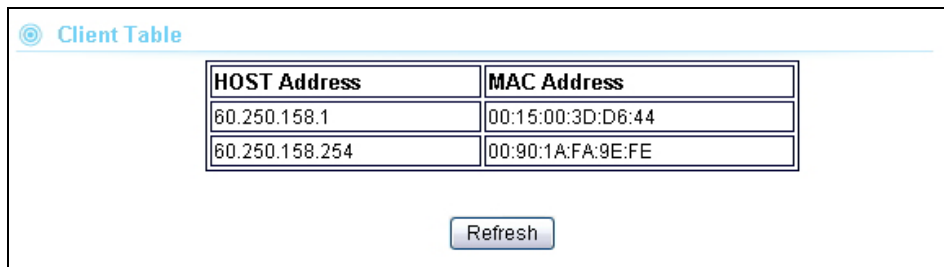

HOST Address	MAC Address
60.250.158.1	00:15:00:3D:D6:44
60.250.158.254	00:90:1A:FA:9E:FE

Refresh

## 10.5 Log

The log function is where you can check for error messages for diagnostic purpose.



Log

Enable Log

ALL  Wireless  DoS(Denial of Service)

Enable Remote Log

Apply Change

Refresh Clear

- **Enable Log:** Check this box to enable log function.
  - **All:** register all logs
  - **Wireless:** register wireless log only
  - **DoS:** register DoS attack log only
- **Enable Remote Log:** This will enable the Syslog function. All logs will be sent to the Syslog server
  - **Log Server IP address:** Enter the Syslog server IP address.

# 11

## Emergency Firmware Recovery

The G.DUO features emergency firmware upgrade function that can restore your AP from a firmware crashed. If you can't access your AP anymore, please first try to restore the setting to default by holding the RESET button (in the back) for more than 7 seconds. You should be able to find the AP at 192.168.1.254. If you can't find it, then please perform the emergency upgrade. **The Emergency Upgrade requires special G.DUO firmware**, please visit [www.airlive.com->support->download](http://www.airlive.com->support->download) and type "G.DUO" to the download page.

### How Emergency Upgrade Works?

G.DUO's flash memory is divided into "firmware" and "bootloader" area. The bootloader area is protected from writing and has a built-in emergency web server. Therefore, the AP can be recovered from emergency web server after a firmware crash. The emergency web server is enabled when AP is forced into emergency upgrade mode, its IP will be changed to **192.168.1.6**.

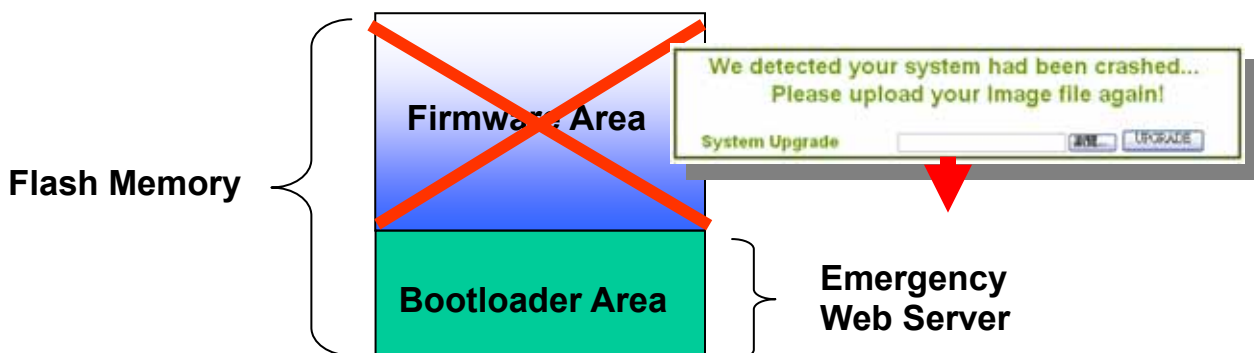

### Procedure to Restore the AP using Emergency Upgrade

1. Please connect your PC directly to the **LAN 2, LAN3, or LAN4 port** of the AP. Do not connect to LAN1.
2. set your PC's IP address to 192.168.1.50
3. Before connecting the power, please press and holding the "Reset" button(in the back of the AP). Then plug in the power. Keep press and hold the Reset button until the "Power" LED goes off(about10 seconds)



Fig 1-2 : Press and hold the reset button while plugging in the power.

6. Open a browser; type “192.168.1.6” for the website address. The following screen should show up

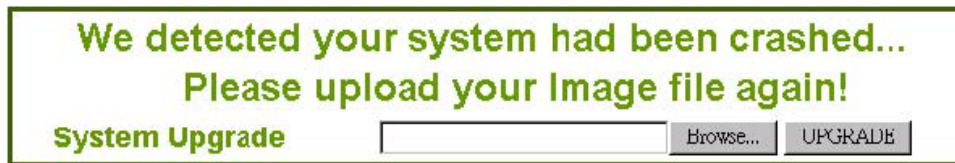

7. Click the “Browse” button, select and open the correct firmware file. This firmware file is different from the Web upgradeable firmware. Please go to [www.airlive.com](http://www.airlive.com) to G.DUO’s support page and download the special firmware for emergency upgrade.
8. Click on “UPGRADE” button. Do not touch the AP or PC until the upgrade is completed.
9. Wait for AP to finish reboot. Open the web browser, and type “192.168.1.254”. You should be able to login into the normal Web UI.

# 12

## Frequent Asked Questions

In this chapter, we will address some frequent asked questions about G.DUO

**Question:** Why is there no password protection for G.DUO?

**Answer:** By default, the password protection is turned off for G.DUO. Please go to “System Configuration -> Password Settings”, then enter a new set of username and password to turn it on.

=====

**Question:** I forgot my password or the IP address of G.DUO.

**Answer:** Please restore your settings to default by press the reset button for more than 7 seconds. You should be able to find your G.DUO at 192.168.1.254 with password “airlive”.

=====

**Question:** Why am I not getting good performance when I am running 2 radios at the same time?

**Answer:** G.DUO's 2 radios system require special attention in regards to mutual interference. It is recommended that you take the following steps to ensure best performance for a 2-radio system

1. Please make sure the 2 radios' channels are set as far apart as possible. For example, one at channel 1 and one at channel 11
2. Please adjust the angle of the antenna or the orientation of the AP to get the best performance. The best performance is about 30 degree from horizontal as indicated in the graph below.



3. Do not increase the TX output power unless one or both radio are using directional antenna.



=====

**Question:** When I want to use “Site Survey” tool to connect with a AP that has no encryption, why does the G.DUO report “encryption type mismatch!” and ask me to configure the wireless security settings?

**Answer:** When you press “Connect” from site survey, the G.DUO will first check if the current wireless encryption setting is correct. If not, it will ask you to modify the setting. Therefore, if your current wireless settings has encryption and the new AP you want to associate does not use encryption, then the G.DUO will report the mismatch. In this case, simply select “Disable” in the encryption field and press “Apply Change”.

=====

**Question:** When I change my wireless operation mode, why can't I find my AP anymore?

**Answer:** This situation can have 2 possibilities..

1. By Default, the DHCP server is turned on in WISP+AP and Gateway+AP mode. In other modes, the DHCP server is turned off. If you get your IP address automatically, then when you change to Dual AP, Client+AP, or WDS+AP modes. Your PC will not be able to get IP address from DHCP server anymore, therefore, you should set the IP address manually.
2. When you change the mode to WISP+AP or Gateway+AP mode, the GDUO's IP address might change to 192.168.1.254. Therefore; if you can't find the device's IP in these modes, please set your PC's IP address to automatically get from DHCP server, then you should find the G.DUO at 192.168.1.254.

=====

**Question:** Why can't I get Telnet or SSH access?

**Answer:** The Telnet or SSH interface are turned off by default. Please go to “System Configuration-> System Management” menu to enable them.

=====



**Question:** Why can't I get SNMP access?

**Answer:** The SNMP management interface is turned off by default. Please go to "System Configuration-> SNMP Management" menu to enable it.

=====

**Question:** Where is the POE port for G.DUO?

**Answer:** The PoE system used for G.DUO is 12V Passive PoE. LAN1 is also used as the passive PoE port.

=====

**Question:** Where is the signal survey function that displays the signal strength continuously for antenna alignment?

**Answer:** The "Signal Survey" function is inside the Site Survey function. After the site survey, please select a SSID and press the "Signal Survey" button. **The signal strength is indicated by percentage, not by SIGNAL STRENGTH.** The higher the number, the stronger the signal.

=====

**Question:** Why can't I perform emergency upgrade correctly?

**Answer:**

1. Please make sure you are connecting your PC to LAN2, LAN3, or LAN4. Do not connect to LAN 1.
2. You need special firmware for emergency upgrade. Please visit [www.airlive.com](http://www.airlive.com) to download the file.

# 13

## Specifications

The specification of G.DUO is subject to change without notice. Please use the information with caution.

### 13.1 Hardware Features

#### 13.1.1 General Hardware Feature

- Realtek Dual 11g/b Chipset
- 4MB Flash, 32MB SDRAM
- RoHS compliant
- 4 10/100 Mbps Ethernet Port with Auto MDI/MDI-X support
- 12V Passive PoE Port (LAN1)
- WAN Port (LAN1)
- Radio1: 26dBm(South America) or 20dBm(EU) TX output power
- Radio2: 24dBm(South America) or 20dBm(EU) TX output power
- 7 LED indicators
- Wall Mount Screw Holes
- Switching DC12V Power adapter
- Reset Button
- 2 x R-SMA antenna connectors

#### 13.2.1 Power Supply

- Power Adapter Voltage : input 100~240Vac/50~60Hz , output 12V/1A
- Advance Passive PoE (Accept 12 to 24 volts)

#### 13.2.2 Dimension and Weight

- Dimension: 154 x 130 x 316 mm
- AP Unit Weight(Approximate): 280g
- Package Weight(Approximate): 686g



## 13.2 Radio Specifications

### 13.2.1 Frequency Band

- USA (FCC) 11 Channels: 2.412GHz~2.462GHz
- Europe (ETSI) 13 Channels : 2.412GHz~2.472GHz d

### 13.2.3 Rate and Modulation

- Data Rate: 54, 48, 36, 24, 18,11, 5.5, 2, 1 Mbps
- Modulation
  - 11g Orthogonal Frequency Division Multiplexing (64QAM, 16QAM, QPSK, BPSK)
  - 11b Direct Sequence Spread Spectrum (CCK, DQPSK, DBPSK)

### 13.2.4 TX Output Power

#### Radio1:

- South America: 26dBm (11b)
- South America: 20dBm (11g)
- EU: 20dBm(11b)
- EU: 20dBm(11g)

#### Radio2:

- South America: 24dBm (11b)
- South America: 20dBm (11g)
- EU: 20dBm(11b)
- EU: 20dBm(11g)

### 13.2.5 Receiver Sensitivity

- RF1

Data Rate	SIGNAL STRENGTH (dB)
1 Mbps	-92
2 Mbps	-91
5.5 Mbps	-88
6 Mbps	-86

9 Mbps	-86
11 Mbps	-85
12 Mbps	-85
18 Mbps	-84
24 Mbps	-80
36 Mbps	-78
48 Mbps	-73
54 Mbps	-72

## ■ RF2

Data Rate	SIGNAL STRENGTH (dB)
1 Mbps	-90
2 Mbps	-88.5
5.5 Mbps	-88
6 Mbps	-83
9 Mbps	-83
11 Mbps	-84
12 Mbps	-83
18 Mbps	-82
24 Mbps	-81
36 Mbps	-77
48 Mbps	-74
54 Mbps	-71

### 13.2.6 Supported WLAN Mode

- WISP + AP Mode
- Dual AP Mode
- Client + AP Mode
- Gateway + AP Mode
- WDS + AP Mode

## 13.3 Software Features

### Operation Modes

- WISP + AP Mode
- Dual AP Mode
- Client + AP Mode

- Gateway + AP Mode
- WDS + AP Mode

### **Management Interface**

- Web HTTP
- Secured Web (HTTPS)
- Telnet (CLI)
- SSH/SSH2 (Secured Shell)
- SNMP v1/v2 Support
  - SNMP Read/Write Community String
  - SNMP Trap support
  - RFC-1213 MIB Support
  - SNMPv2 MIB

### **Advance Functions**

- Site Survey with Signal Strength Indicator
- Bandwidth Control / Traffic Shaping
- Wi-Fi, WPA compatible interoperability
- WPA with PSK/TKIP/AES support ,WPA2 support
- Privacy Separator support
- Hide SSID Support
- Support adjustable output power
- ACK Timeout Adjustment
- Bootloader Protection and Emergency Firmware Upload Code
- Radius Supported
- Up to 40 Static DHCP entries
- Firmware upgrade and configuration backup via Web
- Partial Configuration Backup and Restore



# 14

## Wireless Network Glossary

The wireless network glossary contains explanation or information about common terms used in wireless networking products. Some of information in this glossary might be outdated, please use with caution.

### **802.3ad**

802.3ad is an IEEE standard for bonding or aggregating multiple Ethernet ports into one virtual port (also known as trunking) to increase the bandwidth.

### **802.3af**

This is the PoE (Power over Ethernet) standard by IEEE committee. 803.af uses 48V POE standard that can deliver up to 100 meter distance over Ethernet cable.

### **802.11b**

International standard for wireless networking that operates in the 2.4 GHz frequency band (2.4 GHz to 2.4835 GHz) and provides a throughput up to 11 Mbps.

### **802.1d STP**

Spanning Tree Protocol. It is an algorithm to prevent network from forming. The STP protocol allows net work to provide a redundant link in the event of a link failure. It is advise to turn on this option for multi-link bridge network.

### **802.11d**

Also known as "Global Roaming". 802.11d is a standard for use in countries where systems using other standards in the 802.11 family are not allowed to operate.

### **802.11e**

The IEEE QoS standard for prioritizing traffic of the VoIP and multimedia applications. The WMM is based on a subset of the 802.11e.

**802.11g**

A standard provides a throughput up to 54 Mbps using OFDM technology. It also operates in the 2.4 GHz frequency band as 802.11b. 802.11g devices are backward compatible with 802.11b devices.

**802.11i**

The IEEE standard for wireless security. 802.11i standard includes TKIP, CCMP, and AES encryption to improve wireless security. It is also known as WPA2.

**802.1x**

802.1x is a security standard for wired and wireless LANs. In the 802.1x parlance, there are usually supplicants (client), authenticator (switch or AP), and authentication server (radius server) in the network. When a supplicant requests a service, the authenticator will pass the request and wait for the authentication server to grant access and register accounting. The 802.1x is the most widely used method of authentication by WISP.

**Adhoc**

A Peer-to-Peer wireless network. An Adhoc wireless network does not use wireless AP or router as the central hub of the network. Instead, wireless clients are connected directly to each other. The disadvantage of Adhoc network is the lack of wired interface to Internet connections. It is not recommended for network more than 2 nodes.

**Access Point (AP)**

The central hub of a wireless LAN network. Access Points have one or more Ethernet ports that can connect devices (such as Internet connection) for sharing. Multi-function Access Point can also function as an Ethernet client, wireless bridge, or repeat signals from other AP. Access Points typically have more wireless functions compared to wireless routers.

**ACK Timeout**

Acknowledgement Timeout Windows. When a packet is sent out from one wireless station to the other, it will wait for an Acknowledgement frame from the remote station. The station will only wait for a certain amount of time, this time is called the ACK timeout. If the ACK is NOT received within that timeout period then the packet will be re-transmitted resulting in reduced throughput. If the ACK setting is too high then throughput will be lost



due to waiting for the Ack Window to timeout on lost packets. If the ACK setting is too low then the ACK window will have expired and the returning packet will be dropped, greatly lowering throughput. By having the ability to adjust the ACK setting we can effectively optimize the throughput over long distance links. This is especially true for 802.11a and 802.11g networks. Setting the correct ACK timeout value need to consider 3 factors: distance, AP response time, and interference. The G.DUO provide ACK adjustment capability in form of either distance or direct input. When you enter the distance parameter, the G.DUO will automatically calculate the correct ACK timeout value.

### **Bandwidth Management (Traffic Control)**

Bandwidth Management controls the transmission speed of a port, user, IP address, and application. Router can use bandwidth control to limit the Internet connection speed of individual IP or Application. It can also guarantee the speed of certain special application or privileged IP address - a crucial feature of QoS (Quality of Service) function.

### **Bootloader**

Bootloader is the under layering program that will start at the power-up before the device loads firmware. It is similar to BIOS on a personal computer. When a firmware crashed, you might be able to recover your device from bootloader.

### **Bridge**

A product that connects 2 different networks that uses the same protocol. Wireless bridges are commonly used to link network across remote buildings. For wireless application, there are 2 types of Bridges. WDS Bridge can be used in Point-to-Point or Point-to-Multipoint topology. Bridge Infrastructure works with AP mode to form a star topology.

**Cable and Connector Loss:** During wireless design and deployment, it is important to factor in the cable and connector loss. Cable and connector loss will reduce the output power and receiver sensitivity of the radio at connector end. The longer the cable length is, the more the cable loss. Cable loss should be subtracted from the total output power during distance calculation. For example, if the cable and connector loss is 3dBm and the output power is 20dBm; the output power at the cable end is only 17dBm.

### **Client**

Client means a network device or utility that receives service from host or server. A client



device means end user device such as wireless cards or wireless CPE.

### **CPE Devices**

CPE stands for Customer Premises Equipment. A CPE is a device installed on the end user's side to receive network services. For example, on an ADSL network, the ADSL modem/router on the subscriber's home is the CPE device. Wireless CPE means a complete Wireless (usually an AP with built-in Antenna) that receive wireless broadband access from the WISP. The opposite of CPE is CO.

### **CTS**

Clear To Send. A signal sent by a device to indicate that it is ready to receive data.

### **DDNS**

Dynamic Domain Name System. An algorithm that allows the use of dynamic IP address for hosting Internet Server. A DDNS service provides each user account with a domain name. A router with DDNS capability has a built-in DDNS client that updates the IP address information to DDNS service provider whenever there is a change. Therefore, users can build website or other Internet servers even if they don't have fixed IP connection.

### **DHCP**

Dynamic Hosting Configuration Protocol. A protocol that enables a server to dynamically assign IP addresses. When DHCP is used, whenever a computer logs onto the network, it automatically gets an IP address assigned to it by DHCP server. A DHCP server can either be a designated PC on the network or another network device, such as a router.

### **DMZ**

Demilitarized Zone. When a router opens a DMZ port to an internal network device, it opens all the TCP/UDP service ports to this particular device. The feature is used commonly for setting up H.323 VoIP or Multi-Media servers.

### **DNS**

A program that translates URLs to IP addresses by accessing a database maintained on a collection of Internet servers.

**Domain Name**

The unique name that identifies an Internet site. Domain Names always have 2 or more parts, separated by dots. In [www.airlive.com](http://www.airlive.com), the "airlive.com" is the domain name.

**DoS Attack**

Denial of Service. A type of network attack that floods the network with useless traffic. Many DoS attacks, such as the Ping of Death and Teardrop attacks, exploit limitations in the TCP/IP protocols.

**Encryption**

Encoding data to prevent it from being read by unauthorized people. The common wireless encryption schemes are WEP, WPA, and WPA2.

**ESSID (SSID)**

The identification name of an 802.11 wireless network. Since wireless network has no physical boundary like wired Ethernet network, wireless LAN needs an identifier to distinguish one network from the other. Wireless clients must know the SSID in order to associate with a WLAN network. Hide SSID feature disables SSID broadcast, so users must know the correct SSID in order to join a wireless network.

**Firewall**

A system that secures a network and prevents access by unauthorized users. Firewalls can be software, router, or gateway. Firewalls can prevent unrestricted access into a network, as well as restricting data from flowing out of a network.

**Firmware**

The program that runs inside embedded device such as router or AP. Many network devices are firmware upgradeable through web interface or utility program.

**FTP**

File Transfer Protocol. A standard protocol for sending files between computers over a TCP/IP network and the Internet.





### **Fragment Threshold**

Frame Size larger than this will be divided into smaller fragment. If there are interferences in your area, lower this value can improve the performance. If there are not, keep this parameter at higher value. The default size is 2346. You can try 1500, 1000, or 500 when there are interference around your network.

### **Gateway**

In the global Internet network, the gateways are core routers that connect networks in different IP subnet together. In a LAN environment with an IP sharing router, the gateway is the router. In an office environment, gateway typically is a multi-function device that integrates NAT, firewall, bandwidth management, and other security functions.

### **Hotspot**

A place where you can access Wi-Fi service. The term hotspot has two meanings in wireless deployment. One is the wireless infrastructure deployment, the other is the Internet access billing system. In a hotspot system, a service provider typically need an authentication and account system for billing purposes, and a wireless AP network to provide access for customers.

### **IGMP Snooping**

Internet Group Management Protocol (IGMP) is a Layer 3 protocol to report IP multicast memberships to neighboring multicast switches and routers. IGMP snooping is a feature that allows an Ethernet switch to "listen in" on the IGMP conversation between hosts and routers. A switch support IGMP snooping has the possibility to avoid multicast traffic being treated as broadcast traffic; therefore, reducing the overall traffic on the network.

### **Infrastructure Mode**

A wireless network that is built around one or more access points to provide wireless clients access to wired LAN / Internet service. The opposite of Infrastructure mode is Adhoc mode.

### **IP address**

IP (Internet Protocol) is a layer-3 network protocol that is the basis of all Internet communication. An IP address is 32-bit number that identifies each sender or receiver of information that is sent across the Internet. An IP address has two parts: an identifier of a particular network on the Internet and an identifier of the particular device (which can be a



server or a workstation) within that network. The new IPv6 specification supports 128-bit IP address format.

### **IPsec**

IP Security. A set of protocols developed by the IETF to support secure exchange of packets at the IP layer. IPsec has been deployed widely to implement Virtual Private Networks (VPNs). IPsec supports two encryption modes: Transport and Tunnel. Transport mode encrypts only the data of each packet, but leaves the header untouched. The more secure Tunnel mode encrypts both the header and the payload. On the receiving side, an IPsec-compliant device decrypts each packet.

### **LACP (802.3ad) Trunking**

The 802.3ad Link Aggregation standard defines how to combine the several Ethernet ports into one high-bandwidth port to increase the transmission speed. It is also known as port trunking. Both device must set the trunking feature to work.

### **MAC**

Media Access Control. MAC address provides layer-2 identification for Networking Devices. Each Ethernet device has its own unique address. The first 6 digits are unique for each manufacturer. When a network device have MAC access control feature, only the devices with the approved MAC address can connect with the network.

### **Mbps**

Megabits Per Second. One million bits per second; a unit of measurement for data transmission

### **MESH**

Mesh is an outdoor wireless technology that uses Spanning Tree Protocol (STP) and Wireless Distribution system to achieve self-forming, self-healing, and self-configuring outdoor network. MESH network are able to take the shortest path to a destination that does not have to be in the line of site.

### **MIMO**

Multi In Multi Out. A Smart Antenna technology designed to increase the coverage and performance of a WLAN network. In a MIMO device, 2 or more antennas are used to



increase the receiver sensitivity and to focus available power at intended Rx.

### **NAT**

Network Address Translation. A network algorithm used by Routers to enables several PCs to share single IP address provided by the ISP. The IP that a router gets from the ISP side is called Real IP, the IP assigned to PC under the NAT environment is called Private IP.

### **Node**

A network connection end point, typically a computer.

### **Packet**

A unit of data sent over a network.

### **Passphrase**

Used much like a password, a passphrase simplifies the WEP encryption process by automatically generating the WEP encryption keys for the company products.

### **POE**

Power over Ethernet. A standard to deliver both power and data through one single Ethernet cable (UTP/STP). It allows network device to be installed far away from power ource. A POE system typically compose of 2 main component: DC Injector (Base Unit) and Splitter(Terminal Unit). The DC injector combines the power and data, and the splitter separates the data and power back. A PoE Access Point or CPE has the splitter built-in to the device. The IEEE 802.3af is a POE spec that uses 48 volt to deliver power up to 100 meter distance.

### **Port**

This word has 2 different meaning for networking.

- The hardware connection point on a computer or networking device used for plugging in a cable or an adapter.
- The virtual connection point through which a computer uses a specific application on a server.

**PPPoE**

Point-to-Point Protocol over Ethernet. PPPoE relies on two widely accepted standards: PPP and Ethernet. PPPoE is a specification for connecting the users on an Ethernet to the Internet through a common broadband medium, such as a single DSL line, wireless device or cable modem.

**PPTP**

Point-to-Point Tunneling Protocol: A VPN protocol developed by PPTP Forum. With PPTP, users can dial in to their corporate network via the Internet. If users require data encryption when using the Windows PPTP client, the remote VPN server must support MPPE (Microsoft Point-To-Point Encryption Protocol) encryption. PPTP is also used by some ISP for user authentication, particularly when pairing with legacy Alcatel / Thomson ADSL modem.

**Preamble Type**

Preamble are sent with each wireless packet transmit for transmission status. Use the long preamble type for better compatibility. Use the short preamble type for better performance

**Rate Control**

Ethernet switches' function to control the upstream and downstream speed of an individual port. Rate Control management uses "Flow Control" to limit the speed of a port. Therefore, the Ethernet adapter must also have the flow control enabled. One way to force the adapter's flow control on is to set a port to half-duplex mode.

**RADIUS**

Remote Authentication Dial-In User Service. An authentication and accounting system used by many Internet Service Providers (ISPs). When you dial in to the ISP, you must enter your username and password. This information is passed to a RADIUS server, which checks that the information is correct, and then authorizes access to the ISP system. Radius typically uses port 1812 and port 1813 for authentication and accounting port. Though not an official standard, the RADIUS specification is maintained by a working group of the IETF.

**Receiver Sensitivity**

Receiver sensitivity means how sensitive is the radio for receiving signal. In general; the



slower the transmission speed, the more sensitive the radio is. The unit for Receiver Sensitivity is in dB; the lower the absolute value is, the higher the signal strength. For example, -50dB is higher than -80dB.

### **RJ-45**

Standard connectors for Twisted Pair copper cable used in Ethernet networks. Although they look similar to standard RJ-11 telephone connectors, RJ-45 connectors can have up to eight wires, whereas telephone connectors have only four.

### **Router**

An IP sharing router is a device that allows multiple PCs to share one single broadband connection using NAT technology. A wireless router is a device that combines the functions of wireless Access Point and the IP sharing router.

### **SIGNAL STRENGTH**

Receiver Sensitivity Index. SIGNAL STRENGTH is a value to show the Receiver Sensitivity of the remote wireless device. In general, remote APs with stronger signal will display higher SIGNAL STRENGTH values. For SIGNAL STRENGTH value, the smaller the absolute value is, the stronger the signal. For example, "-50db" has stronger signal than "-80dB". For outdoor connection, signal stronger than -60dB is considered as a good connection.

### **RTS**

Request To Send. A packet sent when a computer has data to transmit. The computer will wait for a CTS (Clear To Send) message before sending data.

### **RTS Threshold**

RTS (Request to Send). The RTS/CTS(clear to send) packet will be send before a frame if the packet frame is larger than this value. Lower this value can improve the performance if there are many clients in your network. You can try 1500, 1000 or 500 when there are many clients in your AP's network.

### **SNMP**

Simple Network Management Protocol. A set of protocols for managing complex networks. The SNMP network contains 3 key elements: managed devices, agents, and network-management systems (NMSs). Managed devices are network devices that content SNMP agents. SNMP agents are programs that reside SNMP capable device's



firmware to provide SNMP configuration service. The NMS typically is a PC based software such as HP Openview that can view and manage SNMP network device remotely.

### **SSH**

Developed by SSH Communications Security Ltd., Secure Shell is a program to log into another computer over a network, to execute commands in a remote machine, and to move files from one machine to another. It provides strong authentication and secure communications over insecure channels. It is a replacement for rlogin, rsh, rcp, and rdist.

### **SSL**

Secure Sockets Layer. It is a popular encryption scheme used by many online retail and banking sites to protect the financial integrity of transactions. When an SSL session begins, the server sends its public key to the browser. The browser then sends a randomly generated secret key back to the server in order to have a secret key exchange for that session. SSL VPN is also known as Web VPN. The HTTPS and SSH management interface use SSL for data encryption.

### **Subnet Mask**

An address code mask that determines the size of the network. An IP subnet are determined by performing a BIT-wise AND operation between the IP address and the subnet mask. By changing the subnet mask, you can change the scope and size of a network.

### **Subnetwork or Subnet**

Found in larger networks, these smaller networks are used to simplify addressing between numerous computers. Subnets connect to the central network through a router, hub or gateway. Each individual wireless LAN will probably use the same subnet for all the local computers it talks to.

### **TCP**

A layer-4 protocol used along with the IP to send data between computers over the Internet. While IP takes care of handling the actual delivery of the data, TCP takes care of keeping track of the packets that a message is divided into for efficient routing through the Internet.

**TX Output Power**

Transmit Output Power. The TX output power means the transmission output power of the radio. Normally, the TX output power level limit for 2.4GHz 11g/b is 20dBm at the antenna end. The output power limit for 5GHz 802.11a is 30dBm at the antenna end..

**UDP**

User Datagram Protocol. A layer-4 network protocol for transmitting data that does not require acknowledgement from the recipient of the data.

**Upgrade**

To replace existing software or firmware with a newer version.

**Upload**

To send a file to the Internet or network device.

**URL**

Uniform Resource Locator. The address of a file located on the Internet.

**VPN**

Virtual Private Network. A type of technology designed to increase the security of information transferred over the Internet. VPN creates a private encrypted tunnel from the end user's computer, through the local wireless network, through the Internet, all the way to the corporate network.

**WAN**

Wide Area Network. A communication system of connecting PCs and other computing devices across a large local, regional, national or international geographic area. A WAN port on the network device means the port (or wireless connection) that is connected to the Internet side of the network topology.

**WEP**

Wired Equivalent Privacy. A wireless encryption protocol. WEP is available in 40-bit (64-bit), 108-bit (128-bit) or 152-bit (Atheros proprietary) encryption modes.

**Wi-Fi**

Wireless Fidelity. An interoperability certification for wireless local area network (LAN) products based on the IEEE 802.11 standards. The governing body for Wi-Fi is called Wi-Fi Alliance (also known as WECA).

**WiMAX**

Worldwide Interoperability for Microwave Access. A Wireless Metropolitan Network technology that complies with IEEE 802.16 and ETSI Hiperman standards. The original 802.16 standard call for operating frequency of 10 to 66Ghz spectrum. The 802.16a amendment extends the original standard into spectrum between 2 and 11 Ghz. 802.16d increase data rates to between 40 and 70 Mbps/s and add support for MIMO antennas, QoS, and multiple polling technologies. 802.16e adds mobility features, narrower bandwidth (a max of 5 mhz), slower speed and smaller antennas. Mobility is allowed up to 40 mph.

**WDS**

Wireless Distribution System. WDS defines how multiple wireless Access Point or Wireless Router can connect together to form one single wireless network without using wired uplinks. WDS associate each other by MAC address, each device

**WLAN**

Wireless Local Area Network. A type of local-area network that uses high-frequency radio waves rather than wires to communicate between nodes. The most popular standard for WLAN is the 802.11 standards.

**WMM**

Wi-Fi Multimedia (WMM) is a standard to prioritize traffic for multimedia applications. The WMM prioritize traffic\ on Voice-over-IP (VoIP), audio, video, and streaming media as well as traditional IP data over the AP.

**WMS**

Wireless Management System. An utility program to manage multiple wireless AP/Bridges.



**WPA**

Wi-Fi Protected Access. It is an encryption standard proposed by WiFi for advance protection by utilizing a password key (TKIP) or certificate. It is more secure than WEP encryption. The WPA-PSK utilizes pre-share key for encryption/authentication.

**WPA2**

Wi-Fi Protected Access 2. WPA2 is also known as 802.11i. It improves on the WPA security with CCMP and AES encryption. The WPA2 is backward compatible with WPA. WPA2-PSK utilizes pre-share key for encryption/authentication.