



at&t | U-verse

---

# Installation Manual for Cisco IPTV Receivers

for use with your AT&T U-verse TV service

Model ISB7005

---





# Contents

2-23-11 Draft

Notice for Installers.....	4
IMPORTANT SAFETY INSTRUCTIONS.....	4
Change the Way You Watch TV .....	6
What's In the Carton?.....	6
Safety First .....	6
Identify Your Receiver with the Serial Number .....	6
In This Manual.....	6
Questions About Your Service.....	6
Protecting You and the Environment.....	7
Front Panel.....	8
Back Panel .....	9
ISB7005 Wireless Network Connection.....	10
Connecting to the In-Home Network .....	11
Connections for a High-Definition TV (HDTV).....	12
Connections for a Standard-Definition TV (SDTV).....	13
Connections for a VCR or DVD Recorder .....	14
Connecting an Over-the-Air Converter Box.....	14
Connecting to an HDTV with an HDMI Connector .....	15
Connecting to an HDTV with a DVI Connector.....	16
Connecting to an HDTV with Component (YPbPr) Connectors .....	17
Connecting to an SDTV with Component (YPbPr) Connectors.....	18
Connecting to an SDTV with an S-Video Connector .....	19
Connecting to an SDTV with an RCA-Type Connector .....	20
Connecting to an SDTV with a Coaxial Cable .....	21
Connecting to a Home Theater System with Component (YPbPr) Connectors .....	22
Connecting to a Stereo VCR or DVD Recorder (optional).....	23
Troubleshooting.....	24
Avoid Screen Burn-In .....	24
Frequently Asked Questions.....	25
Picture Formats .....	26
Index.....	27
Compliance Information.....	29

# Notice for Installers

2-23-11 Draft

The servicing instructions in this notice are for use by qualified service personnel only. To reduce the risk of electric shock, do not perform any servicing other than that contained in the operating instructions, unless you are qualified to do so.

## Note to System Installer

For this apparatus, the cable shield/screen shall be grounded as close as practical to the point of entry of the cable into the building. For products sold in the US and Canada, this reminder is provided to call the system installer's attention to Article 800-93 and Article 800-100 of the NEC (or Canadian Electrical Code Part 1), which provides guidelines for proper grounding of the cable shield.



This symbol is intended to alert you that uninsulated voltage within this product may have sufficient magnitude to cause electric shock. Therefore, it is dangerous to make any kind of contact with any inside part of this product.

Ce symbole a pour but d'alerter toute personne qu'un contact avec une pièce interne de ce produit, sous tension et non isolée, pourrait être suffisant pour provoquer un choc électrique. Il est donc dangereux d'être en contact avec toute pièce interne de ce produit.



**CAUTION:** To reduce the risk of electric shock, do not remove cover (or back). No user-serviceable parts inside. Refer servicing to qualified service personnel.

**WARNING**  
**TO PREVENT FIRE OR ELECTRIC SHOCK, DO NOT EXPOSE THIS UNIT TO RAIN OR MOISTURE.**



This symbol is intended to alert you of the presence of important operating and maintenance (servicing) instructions in the literature accompanying this product.

Ce symbole a pour but de vous avertir qu'une documentation importante sur le fonctionnement et l'entretien accompagne ce produit.

20080814\_Installer800

## IMPORTANT SAFETY INSTRUCTIONS

- 1) Read these instructions.
- 2) Keep these instructions.
- 3) Heed all warnings.
- 4) Follow all instructions.
- 5) Do not use this apparatus near water.
- 6) Clean only with dry cloth.
- 7) Do not block any ventilation openings. Install in accordance with the manufacturer's instructions.
- 8) Do not install near any heat sources such as radiators, heat registers, stoves, or other apparatus (including amplifiers) that produce heat.
- 9) Do not defeat the safety purpose of the polarized or grounding-type plug. A polarized plug has two blades with one wider than the other. A grounding-type plug has two blades and a third grounding prong. The wide blade or the third prong are provided for your safety. If the provided plug does not fit into your outlet, consult an electrician for replacement of the obsolete outlet.
- 10) Protect the power cord from being walked on or pinched particularly at plugs, convenience receptacles, and the point where they exit from the apparatus.
- 11) Only use attachments/accessories specified by the manufacturer.
- 12)  Use only with the cart, stand, tripod, bracket, or table specified by the manufacturer, or sold with the apparatus. When a cart is used, use caution when moving the cart/apparatus combination to avoid injury from tip-over.
- 13) Unplug this apparatus during lightning storms or when unused for long periods of time.
- 14) Refer all servicing to qualified service personnel. Servicing is required when the apparatus has been damaged in any way, such as a power-supply cord or plug is damaged, liquid has been spilled or objects have fallen into the apparatus, the apparatus has been exposed to rain or moisture, does not operate normally, or has been dropped.

## Power Source Warning

A label on this product indicates the correct power source for this product. Operate this product only from an electrical outlet with the voltage and frequency indicated on the product label. If you are uncertain of the type of power supply to your home or business, consult your service provider or your local power company.

The AC inlet on the unit must remain accessible and operable at all times.

## Ground the Product



**WARNING:** Avoid electric shock and fire hazard! If this product connects to cable wiring, be sure the cable system is grounded (earthed). Grounding provides some protection against voltage surges and built-up static charges.

## Protect the Product from Lightning

In addition to disconnecting the AC power from the wall outlet, disconnect the signal inputs.

## Verify the Power Source from the On/Off Power Light

When the on/off power light is not illuminated, the apparatus may still be connected to the power source. The light may go out when the apparatus is turned off, regardless of whether it is still plugged into an AC power source.

## Eliminate AC Mains Overloads



**WARNING:** Avoid electric shock and fire hazard! Do not overload AC mains, outlets, extension cords, or integral convenience receptacles. For products that require battery power or other power sources to operate them, refer to the operating instructions for those products.

## Handling Disposable Batteries

This product may contain disposable batteries. Heed the following warning and follow the Battery Safety and Battery Disposal instructions below.

 **WARNING:** There is danger of explosion if the battery is mishandled or incorrectly replaced. Replace only with the same type of battery. Do not disassemble it or attempt to recharge it outside the system. Do not crush, puncture, dispose of in fire, short the external contacts, or expose to water or other liquids. Dispose of the battery in accordance with local regulations and instructions from your service provider.

### Battery Safety

- Insert batteries correctly. There may be a risk of explosion if the batteries are incorrectly inserted.
- Do not attempt to recharge 'disposable' or 'non-reusable' batteries.
- Please follow instructions provided for charging 'rechargeable' batteries.
- Replace batteries with the same or equivalent type that we recommend.
- Do not expose batteries to excessive heat (such as sunlight or fire).
- Do not expose batteries to temperatures above 100°C (212°F).

### Battery Disposal

- The batteries may contain substances that could be harmful to the environment.
- Recycle or dispose of batteries in accordance with the battery manufacturer's instructions and local/national disposal and recycling regulations.



廢電池請回收

- The batteries may contain perchlorate, a known hazardous substance, so special handling and disposal of this product might be necessary. For more information about perchlorate and best management practices for perchlorate-containing substance, see [www.dtsc.ca.gov/hazardouswaste/perchlorate](http://www.dtsc.ca.gov/hazardouswaste/perchlorate)

## Provide Ventilation and Select a Location

- Remove all packaging material before applying power to the product.
- Do not place this apparatus on a bed, sofa, rug, or similar surface.
- Do not place this apparatus on an unstable surface.
- Do not install this apparatus in an enclosure, such as a bookcase or rack, unless the installation provides proper ventilation.
- Do not place entertainment devices (such as VCRs or DVDs), lamps, books, vases with liquids, or other objects on top of this product.
- Do not block ventilation openings.

## Protect from Exposure to Moisture and Foreign Objects



**WARNING:** Avoid electric shock and fire hazard! Do not expose this product to dripping or splashing liquids, rain, or moisture. Objects filled with liquids, such as vases, should not be placed on this apparatus.



**WARNING:** Avoid electric shock and fire hazard! Unplug this product before cleaning. Do not use a liquid cleaner or an aerosol cleaner. Do not use a magnetic/static cleaning device (dust remover) to clean this product.



**WARNING:** Avoid electric shock and fire hazard! Never push objects through the openings in this product. Foreign objects can cause electrical shorts that can result in electric shock or fire.

## Service Warnings



**WARNING:** Avoid electric shock! Do not open the cover of this product. Opening or removing the cover may expose you to dangerous voltages. If you open the cover, your warranty will be void. This product contains no user-serviceable parts.

## Check Product Safety

Upon completion of any service or repairs to this product, the service technician must perform safety checks to determine that this product is in proper operating condition.

## Protect the Product When Moving It

Always disconnect the power source when moving the apparatus or connecting or disconnecting cables.

20090915\_IP\_NoTuner\_Safety



# Change the Way You Watch TV

2-23-11 Draft

Welcome to U-verse TV. The ISB7005 devices, known as U-verse receivers, bring a rich, new set of interactive services directly to you through your TV and your in-home IP network. The receiver uses wireless technology 802.11n to connect to the network.

The ISB7005 receiver allows for easy and secure connection to U-verse services. The signal strength indicator on the front panel of the receiver identifies the strength of the wireless connection and aids in the proper placement of the receiver.

## What's In the Carton?

In addition to this installation manual, the receiver carton contains the following items:

- An ISB7005 Receiver - A wireless receiver
- A power cord and power adapter

Other equipment may be required.

## Safety First

Before using the receiver, read the Important Safety Instructions section of this manual.

## Identify Your Receiver with the Serial Number

At times your service provider may ask for the serial number. To find the serial number for your receiver, look on the bottom of the receiver for the label. The serial number is a 9-digit numeric code to the right of the letters "S/N" on the label.

Use the space provided here to record the serial number: \_\_\_\_\_

## In This Manual

This manual covers the information you need to connect your receiver to both your in-home IP network and your entertainment system. The manual also outlines certain safeguards and installation information. The safety information contained in this manual was developed and provided solely by the receiver manufacturer, Cisco Systems, Inc.

## Questions About Your Service

For questions about how to operate your receiver, once installed, refer to your *Feature Guide* available for download at: [uverse.att.com/support](http://uverse.att.com/support). For all other questions about your TV service, contact your service provider.

## Protecting You and the Environment

Cisco addresses the environmental impact of networking products throughout their lifecycle, from product development, manufacturing, and use to service and end-of-life. Integrating environmental policies into Cisco engineering and manufacturing practices results in socially accountable business practices that help reduce the environmental impact associated with networking products.

# Front Panel

2-23-11 Draft

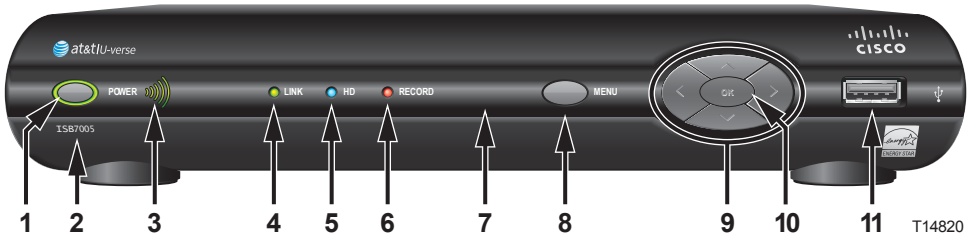

- |                                    |  |
|------------------------------------|--|
| <b>1 Power</b>                     | Turns the receiver on or places it in standby. To restart the receiver, press and hold the POWER button for 10 seconds. The LED is green |
| <b>2 Model Number</b>              | Identifies the model number of your receiver as ISB7005  |
| <b>3 Signal Strength Indicator</b> | Identifies the strength of the wireless connection   |
| <b>4 Link</b>                      | Indicates network link status. The LED is green  |
| <b>5 HD</b>                        | Indicates the set-top is set to a resolution of 720p, 1080i, or 1080p. The LED is blue   |
| <b>6 Record</b>                    | Indicates that a recording is in progress. The LED is red  |
| <b>7 IR Sensor</b>                 | Receives the infrared signal from the remote control. The sensor is behind the front panel   |
| <b>8 Menu</b>                      | Accesses the on-screen menu  |
| <b>9 Arrow Keys</b>                | Accesses on-screen services (such as the on-screen guide, video-on-demand, or pay-per-view) and navigates menus                          |
| <b>10 OK</b>                       | Selects the current item   |
| <b>11 USB Port</b>                 | USB connector. (Reserved for future use)   |

**Note:** This illustration may vary from the actual product.



# Back Panel

2-23-11 Draft

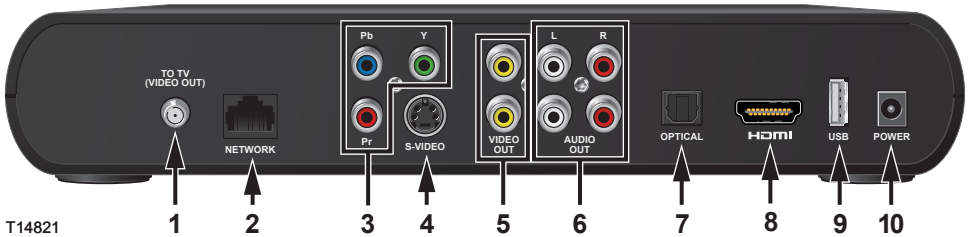

T14821

- 1 To TV (Video Out)** Connect to TV. You must set the channel on your TV to the channel designated by your service provider (usually channel 3). Contact your service provider for the channel information
- 2 Network** Connect to the Ethernet (CAT-5) network at your home, if applicable
- 3 YPbPr** Connect the receiver to the component video input (YPbPr) on the HDTV. **See pages 11 and 12** for more information
- 4 S-Video** Connect an S-Video cable to send an S-Video signal to your TV, VCR, or DVD recorder. This signal is standard-definition but higher quality than other standard-definition TV connections. **See page 12** for more information
- 5 Video Out** Connect to composite input on your HDTV or SDTV  
**Note:** Two video output connectors are provided. Typically, one output is connected to the TV, and the other output is used to connect to a home theater system, DVD recorder, or VCR
- 6 Audio Out (L/R)** Connect RCA-type cables to Audio Out to send analog audio signals (left and right) to a TV with stereo inputs or to a stereo amplifier  
**Note:** Two sets of audio out connectors are provided. Typically, one set of outputs is connected to the TV, and the other set is used to connect to a home theater system, DVD recorder, or VCR
- 7 Optical** Connect an optical cable to send a digital audio signal to a surround-sound receiver or other digital audio device
- 8 HDMI** Connect an HDTV HDMI™ (High-Definition Multimedia Interface) cable from the HDTV to the HDMI port. HDMI supports both digital audio and video. **See page 11** for more information
- 9 USB Port** USB connector. (Reserved for future use)
- 10 Power** Connect the DC output of the AC power adapter (provided) to deliver power to the receiver

**Note:** This illustration may vary from the actual product.

# Connecting the Receiver

2-23-11 Draft

To connect your receiver to your network and home entertainment devices, complete these steps.



Because the connections for a high-definition (HD) or standard-definition (SD) TV are different, you must determine if your TV is HD or SD. Your TV must receive HD signals for you to enjoy the benefits of HDTV. Refer to the manual that came with your TV for more information.

**See page 26** for more information on picture formats.

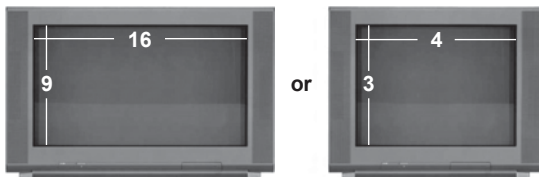

Make one of the following connections for your home network:

- If your home network uses coaxial cable, use the TO WALL connector on the receiver. **See page 11.**
- If your home network uses twisted pair cable (phoneline wiring), use the TO WALL connector on the receiver and an adapter that converts twisted pair to coaxial. **See page 11.**
- If your home network uses Ethernet (CAT-5) cable, use the NETWORK connector on the receiver. **See page 11.**



Make the connections for your TV, VCR, and DVD recorder as follows:

- If you are using an HDTV, **see page 12** and the connection diagrams in this manual.
- If you are using a standard-definition TV, **see page 13** and the connection diagrams in this manual.
- If you want to record some programs on VCR tape or DVD, **see page 14** and the connection diagrams in this manual.



Identify the additional consumer electronic devices you will connect to the receiver and TV. **See pages 15 through 23** and refer to the owner's manual for the device.

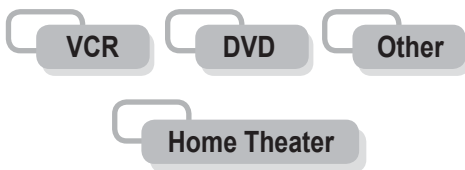

Plug the receiver and the TV into an AC power source that is not controlled by a switch. For further instructions on completing your setup, refer to the *Feature Guide* available from your service provider.

# ISB7005 Wireless Network Connection

2-23-11 Draft

The ISB7005 receiver allows for easy and secure connection to U-verse services. The signal strength indicator on the front panel of the receiver identifies the strength of the wireless connection and aids in the proper placement of the receiver.



**Signal Strength Indicator**

T14822

## Wireless LEDs

### Receiver Operational Status



This indicates the wireless signal is excellent. The video quality is good.



This indicates the wireless signal is very good. The video quality is good.



This indicates the wireless signal is good. The video quality is good. You must obtain three or more green bars at initial installation.



This indicates the wireless signal is fair. The video quality is good.



This indicates the wireless signal is weak. The video quality may be poor. The STB should be re-oriented to achieve a better wireless signal.



This indicates the wireless signal is very weak. No video can be displayed. The receiver must be re-oriented to achieve a better wireless signal.



This indicates the STB Ethernet port is connected with the residential gateway through the Ethernet cable.

# Connections for a High-Definition TV (HDTV)



















2-23-11 Draft

To use the receiver with an HDTV, you must make *one* of the following connections to view the HD content. Refer to the owner's manual for your TV and the cabling diagrams in this manual for more detailed connection information.

Although all connections provide you with quality service, we list the connections in our recommended order.

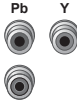
## Notes:

- The labeling on your receiver or HDTV may vary slightly from the illustrations shown below.
- Some cables shown in the connection diagrams may not be included with this receiver.
- Set the HD mode and select the output video format (480i, 720p, 1080i, or 1080p) on the receiver using the instructions provided in the *Feature Guide* available for download at: [uverse.att.com/support](http://uverse.att.com/support)

Use One of These Required Connections to an HDTV		Receiver Connections		HDTV Connections
HDMI	Some HDTVs have a High-Definition Multimedia Interface (HDMI) connector. The HDMI connector provides both a digital video and audio connection. See the connection diagram on <b>page 15</b> for an example.  <b>Note:</b> The HDMI port on the TV must support high-bandwidth digital content protection (HDCP).	 HDMI	Audio/Video	 HDMI
DVI	The HDMI connector can provide the connection to an HDTV with a DVI input. If your HDTV has a Digital Visual Interface (DVI) connector, you need an HDMI-to-DVI adapter, and a separate audio connection (either L/R or optical audio).  <b>Note:</b> The DVI port on the TV must support high-bandwidth digital content protection (HDCP).  See the connection diagram on <b>page 16</b> for an example.	 HDMI <b>Adapter Needed</b>	Video	 DVI
		 L R AUDIO OUT	Audio	 L R
		 OPTICAL	Audio	 OPTICAL INPUT
YPbPr	The YPbPr (red, blue, and green) connectors provide high-definition component video signals to an HDTV, and a separate audio connection (either L/R or optical audio).  See the connection diagram on <b>page 17</b> for an example.	 Pb Y	Video	 Y Pb Pr
		 L R AUDIO OUT	Audio	 L R
		 OPTICAL	Audio	 OPTICAL INPUT
RGB	Some HDTVs have only RGB or RGB-HV connectors. If you have one of these HDTVs, you need a Component-to-RGB adapter, and you need a separate audio connection.	 Pb Y <b>Adapter Needed</b>	Video	 R G B H V
		 L R AUDIO OUT	Audio	 L R

# Connections for a Standard-Definition TV (SDTV)











2-23-11 Draft

When using the receiver with an SDTV, you must make *one* of the following connections to view content. Some SDTVs may not have all these connections. Refer to the owner's manual for your TV and the cabling diagrams in this manual for more detailed information.

Although all connections provide you with quality service, we list the connections in our recommended order.

## Notes:

- The labeling on your receiver or SDTV may vary slightly from the illustrations shown below.
- Some cables shown in the connection diagrams may not be included with this receiver.

Use One of These Required Connections to an SDTV		Receiver Connections		SDTV Connections
YPbPr	The YPbPr (red, blue, and green) connectors can provide standard-definition component video signals to an SDTV. A separate audio connection is also needed.		Video	
				Audio
S-Video	The S-Video connection provides an optimal video connection to SDTVs. A separate audio connection is also needed. See the connection diagram on <b>page 19</b> for an example.		Video	
				Audio
Video Out	The Video Out connector provides a video connection to an SDTV. A separate audio connection is also needed. See the connection diagram on <b>page 20</b> for an example.		Video	
				Audio
To TV (Video Out)	The To TV (Video Out) connector provides both a video and audio connection to an SDTV. See the connection diagram on <b>page 21</b> for an example.		Audio/Video	

# Connections for a VCR or DVD Recorder









2-23-11 Draft

When using the receiver with a VCR or DVD recorder, you must make *one* of the following connections to view content.

Although all connections provide you with quality service, we list the connections in our recommended order.

**Notes:**

- The labeling on your receiver, VCR, or DVD recorder may vary slightly from the illustrations shown below.
- Some cables shown in the connection diagrams may not be included with this receiver.

Use One of These Optional Connections to a VCR or DVD Recorder		Receiver Connections		VCR/DVD Recorder Connections
VCR/DVD Recorder	For VCRs or DVD recorders with S-Video In and Left and Right audio connectors, use the S-Video and the Audio Out Left and Right connectors on the receiver.	 S-VIDEO	Video	 S-VIDEO IN
		 AUDIO OUT	Audio	 L R
	For VCRs or DVD recorders with Video In and Left and Right audio connectors, use the Video Out and the Audio Out connectors (Left and Right) on the receiver.  See the connection diagram on <b>page 23</b> for an example.	 VIDEO OUT	Video	 VIDEO IN
		 AUDIO OUT	Audio	 L R

## Connecting an Over-the-Air Converter Box

You can connect an over-the-air converter box directly to your TV to receive certain local channels, but do not connect the over-the-air converter box directly to your receiver.

# Connecting to an HDTV with an HDMI Connector

2-23-11 Draft

## Cable Used in this Configuration

- 1 HDMI Cable

### Notes:

- The HDMI port on the TV must support high-bandwidth digital content protection (HDCP).
- The HDMI interface supports Dolby™ Digital 5.1 audio.



### WARNING:

Electric shock hazard! Unplug all electronic devices before connecting or disconnecting any device cables to the receiver.

## Receiver

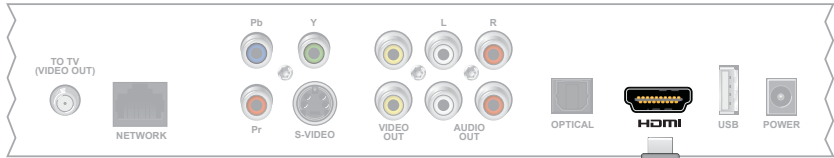

## Back of HDTV

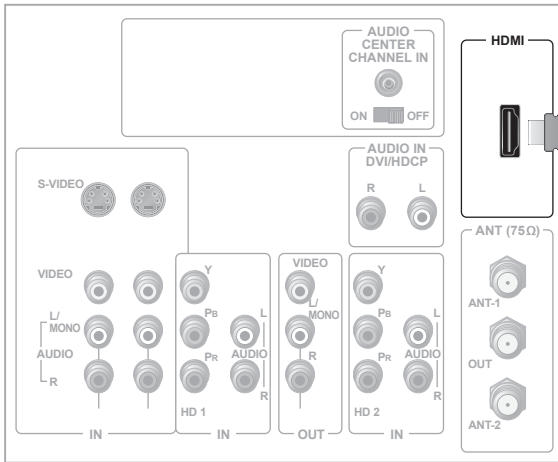

T14823

# Connecting to an HDTV with a DVI Connector

2-23-11 Draft

## Cables Used in this Configuration

- 1 HDMI-to-DVI Cable or 1 HDMI Cable and 1 HDMI-to-DVI Adapter
- 1 Audio Left/Right Cable (You can also use an optical cable [indicated by the dotted line] instead of the Audio Left/Right Cable as shown in the diagram, dependent upon your TV's capabilities.)

### Notes:

- The DVI port on the TV must support high-bandwidth digital content protection (HDCP).
- When you connect the HDMI connector to the DVI connector on your HDTV, you need an HDMI-to-DVI adapter and a separate audio connection.



### WARNING:

**Electric shock hazard! Unplug all electronic devices before connecting or disconnecting any device cables to the receiver.**

## Receiver

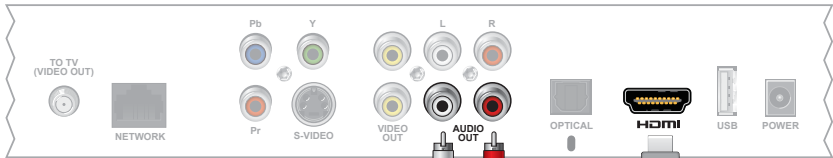

OR

## Back of HDTV

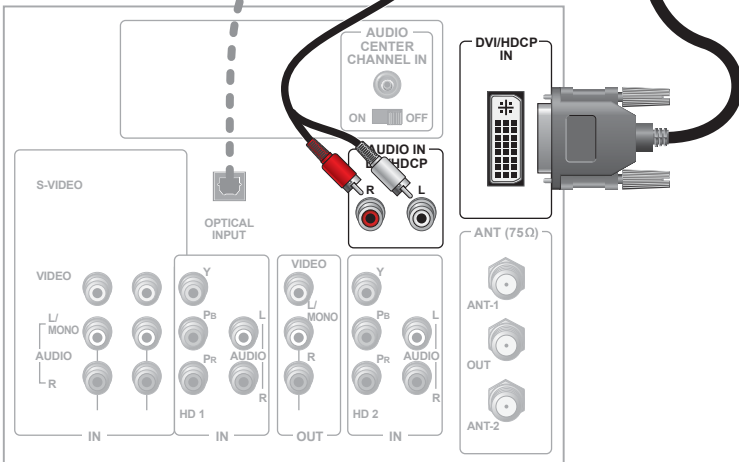

T14824



# Connecting to an HDTV with Component (YPbPr) Connectors

2-23-11 Draft

## Cables Used in this Configuration

- 1 Component Video Cable (YPbPr)
- 1 Audio Left/Right Cable (You can also use an optical cable [indicated by the dotted line] instead of the Audio Left/Right Cable as shown in the diagram, dependent upon your TV's capabilities.)



### WARNING:

Electric shock hazard! Unplug all electronic devices before connecting or disconnecting any device cables to the receiver.

## Receiver

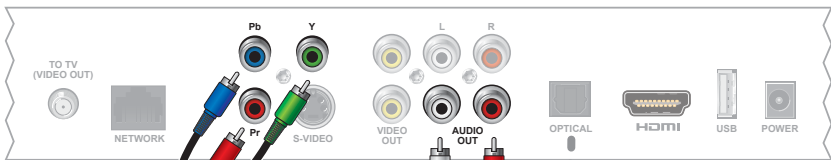

OR

## Back of HDTV

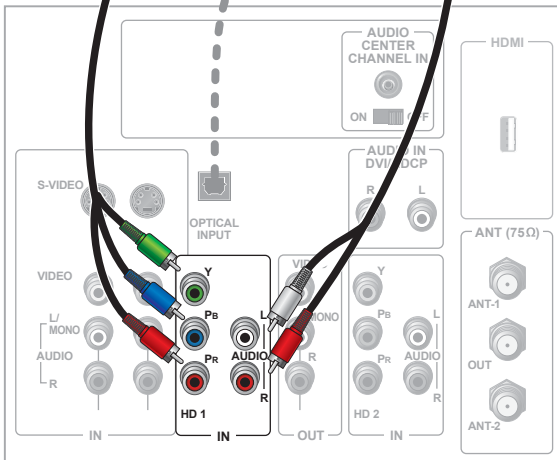

T14825

# Connecting to an SDTV with Component (YPbPr) Connectors

2-23-11 Draft

## Cables Used in this Configuration

- 1 Component Video Cable (YPbPr)
- 1 Audio Left/Right Cable

**Note:** The receiver must be set to the proper standard-definition mode.



### WARNING:

**Electric shock hazard! Unplug all electronic devices before connecting or disconnecting any device cables to the receiver.**

## Receiver

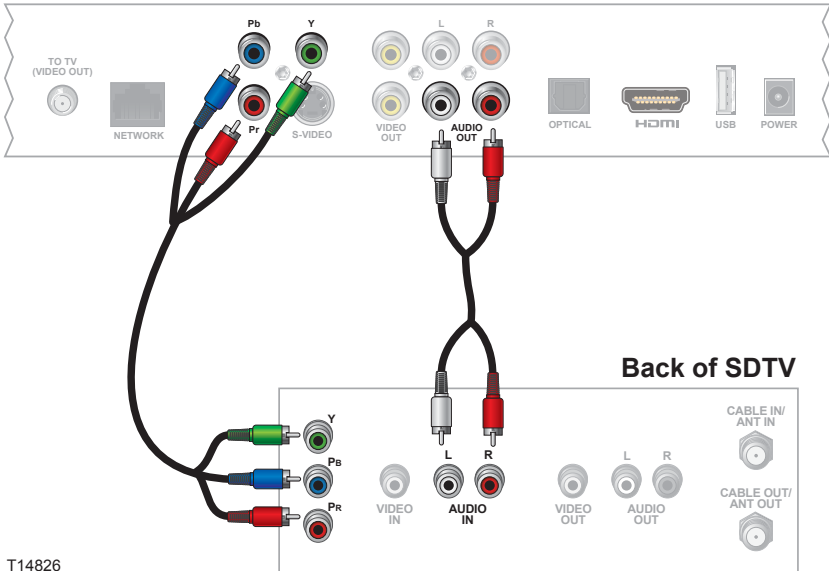

# Connecting to an SDTV with an S-Video Connector

2-23-11 Draft

## Cables Used in this Configuration

- 1 S-Video Cable
- 1 Audio Left/Right Cable



### WARNING:

Electric shock hazard! Unplug all electronic devices before connecting or disconnecting any device cables to the receiver.

## Receiver

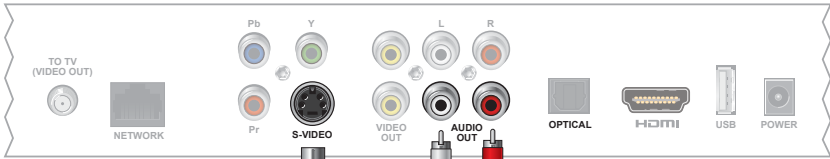

## Back of SDTV

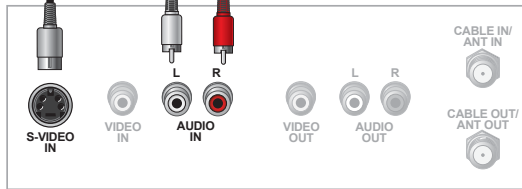

T14827

# Connecting to an SDTV with an RCA-Type Connector

2-23-11 Draft

## Cables Used in this Configuration

- 1 RCA-type Video Cable
- 1 Audio Left/Right Cable



### WARNING:

Electric shock hazard! Unplug all electronic devices before connecting or disconnecting any device cables to the receiver.

## Receiver

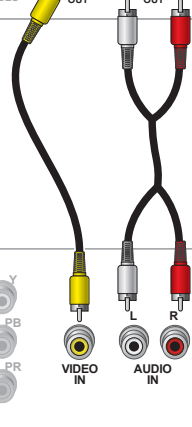
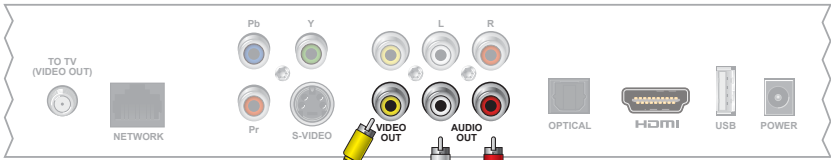

## Back of SDTV

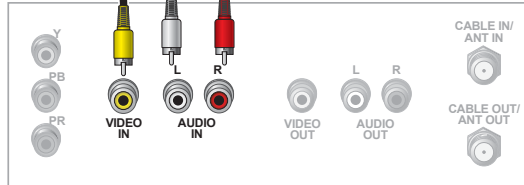

T14828

# Connecting to an SDTV with a Coaxial Cable

2-23-11 Draft

## Cable Used in this Configuration

- 1 Coaxial Cable

**Note:** You must set the channel on your TV to the channel designated by your service provider (usually channel 3). Contact your service provider for the channel information.



### WARNING:

**Electric shock hazard! Unplug all electronic devices before connecting or disconnecting any device cables to the receiver.**

## Receiver

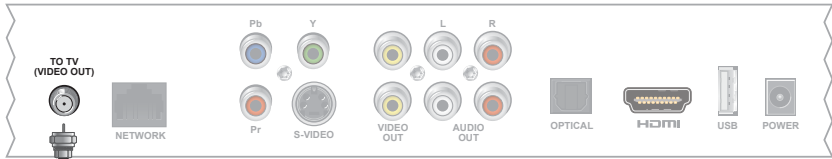

## Coaxial Cable

## Back of SDTV

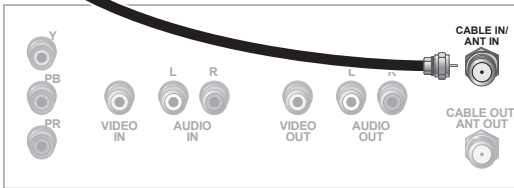

T14829

# Connecting to a Home Theater System with Component (YPbPr) Connectors

2-23-11 Draft

## Cables Used in this Configuration

- 1 Component Video Cable (YPbPr)
- 1 Audio Left/Right Cable (You can also use an optical cable [indicated by the dotted line] instead of the Audio Left/Right Cable as shown in the diagram.)

### Notes:

- This connection requires that audio is provided by the home theater system.
- Consult the user guide that came with your home theater system for information on connecting your other video and audio devices.

Contact AT&T ConnectTech® service to learn about affordable flat-rate home theater installation services. Call **(800) 344-1734** to speak with an AT&T ConnectTech Representative. (Not available in all areas; See offers and terms & conditions at [www.att.com/ConnectTech](http://www.att.com/ConnectTech)).



### WARNING:

**Electric shock hazard! Unplug all electronic devices before connecting or disconnecting any device cables to the receiver.**

## Receiver

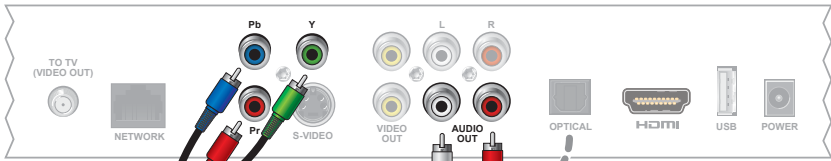

OR

## Back of Home Theater Receiver

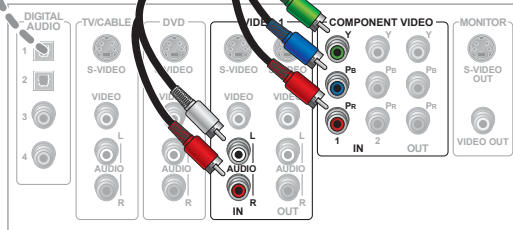

T14830

# Connecting to a Stereo VCR or DVD Recorder (optional)

2-23-11 Draft

The diagram below shows how to connect a recording device to your receiver. Although it is possible to watch TV using a connection through your VCR or DVD recorder to the TV, this connection may not provide the best picture, and HDTV users are restricted to an SD format. In addition, some content is copy protected and passing this content through the recording device may result in a picture that cannot be viewed.

For these reasons, the connection shown is best used to provide only video and audio to your recording device and not for normal TV viewing. The connection from the recording device to the TV (only used for playback of recorded material) depends on the type of device being used, the outputs that are supported, and the inputs that remain available for use on your TV.

Consult the owner's manuals provided with your TV and recording device for more details on connection options.

## Cables Used in this Configuration

- 1 RCA-type Video Cable
- 1 Set Audio Left/Right Cables



### WARNING:

**Electric shock hazard! Unplug all electronic devices before connecting or disconnecting any device cables to the receiver.**

**Connecting your TV directly to the Audio/Video output of your receiver will assure a more vivid picture and enhance your viewing enjoyment.**

## Receiver

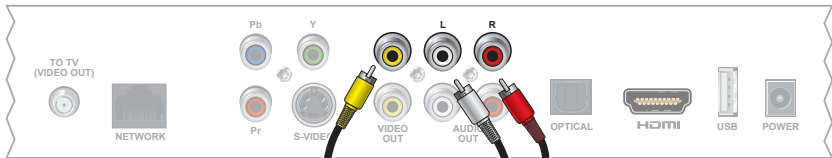

## Back of Stereo VCR or DVD Recorder

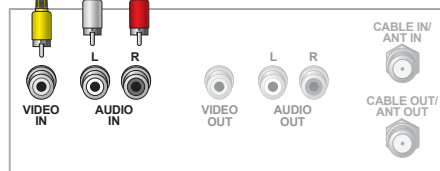

T14831

# Troubleshooting

2-23-11 Draft

If the receiver does not perform as expected, the following tips may help. If you need further assistance, contact your service provider.

## No Picture

- Verify that the power to your TV is turned on.
- If the receiver is plugged into a wall switch, verify that the switch is in the ON position.
- Verify that all cables are properly connected.
- If your system includes a VCR, DVD recorder, or stereo, verify that you have properly connected the device to the receiver.
- Verify that you are using the proper input selection to the home theater receiver or TV.
- Verify that the receiver is set to the proper screen type and resolution.
- If you are using coaxial cable to connect to your TV, verify that the TV is tuned to the channel designated by your service provider (usually channel 3). Contact your service provider for the channel information.

## No Color or Incorrect Color

- Verify that the current TV program is broadcast in color.
- Adjust the TV color controls.
- If you are using a component video connection (YPbPr), check that all connectors are completely and properly plugged into the receiver and TV.
- If you are using a component video connection (YPbPr) and your HDTV has only RGB or RGB-HV connectors, you must use an adapter. You can obtain the adapter through an electronic parts retailer.

## No Sound

- If your setup includes a VCR, DVD recorder, or stereo, verify that you have properly connected the device to the receiver.
- Verify that the volume is turned up.
- Verify that the mute function is not on.
- Verify the proper input selection to the home theater receiver or TV.
- If you are using coaxial cable to connect to your TV, verify that the TV is tuned to the correct channel.

## Avoid Screen Burn-In

Images such as letterbox bars or side bars, bright closed-captioning backgrounds, station logos, or any other stationary images may cause the display in your HDTV to age unevenly; this is known as screen burn-in. Refer to the owner's manual that came with your HDTV for more information.



### **CAUTION:**

**Avoid screen burn-in.**

**Do not display the same fixed images on your HDTV screen for extended periods of time.**



# Frequently Asked Questions

2-23-11 Draft

## What Is Digital Television?

Digital television (DTV) is a huge leap forward in television technology compared to analog television that has been widely available since the 1940s. DTV is delivered and displayed using digital encoding, similar to the way a PC operates. By using digital technology, there is no variation in picture and sound quality from the origination point until it is displayed on your television. You always receive a high-quality picture without the wavy lines or static you might sometimes get from a weak analog signal. Another feature of digital television is digital surround sound using Dolby Digital technology, which is the same technology used to produce the sound you hear in movie theaters.

## What Is Standard-Definition Television?

Standard-definition television (SDTV) is basic digital television programming delivered by your service provider. Typically, the SDTV screen is the same, nearly square shape as an analog television screen. Digital images on an SDTV set are crisp and clear—noticeably better than on a standard analog television set using an antenna to receive over-the-air signals.

## What Is High-Definition Television?

High-definition television (HDTV) is a completely new way to send and receive television broadcast signals. HDTV images are made up of pixels that are much smaller and closer together than those used in standard analog television, and there are millions of them. Thus, HDTV can display five to six times the detail of analog television to deliver picture quality that is much more realistic, dimensional, and precise. SDTV programs can be viewed on an HDTV.

## Are Local TV Stations or Other Programmers Broadcasting in HDTV?

Many local TV stations and programmers are transmitting digital signals. However, transmitting a digital signal does not mean transmitting an HDTV signal. Some stations are using the new bandwidth to broadcast several standard-definition channels. Most stations and programmers, once they begin broadcasting in digital, are offering HD content from their parent network (for example, CBS, ABC, NBC, Fox, and PBS). Contact your service provider for more information.

## Why Aren't All the Shows I Watch in High-Definition?

A high-definition program must originate in HD format and be broadcast in HD format. Having an HDTV system does not mean that everything you watch will be viewed in high-definition. Getting the signal from a digital source also does not mean it is high-definition.

## Why Are Some HDTVs 4:3 Aspect Ratio and Others 16:9?

The aspect ratios differ because television manufacturers build both standard-screen and wide-screen HDTVs to appeal to consumer viewing preferences. The two aspect ratios are as follows:

- On standard-screen (4:3) HDTVs, the programming is displayed in letterbox format in the middle of the screen. There are bars surrounding the picture.
- On wide-screen (16:9) HDTVs, the programming is displayed on the full screen.

## What Is HDMI and Does it Support Dolby Digital 5.1 Audio?

The High-Definition Multimedia Interface (HDMI) is an uncompressed, all-digital audio/video interface. The Dolby Digital audio format that provides up to 5.1 separate channels of surround sound, and is the standard used for DVD-Video. HDMI supports standard, enhanced, or high-definition video, plus multi-channel digital audio, such as Dolby Digital audio, on a single cable.

# Picture Formats

2-23-11 Draft

## What Is the Difference Between a Standard-Screen and a Wide-Screen HDTV?

The type of screen your HDTV has (wide-screen or standard-screen) determines how the receiver displays programs on the screen. The picture format for an HDTV is a combination of *aspect ratio* and *screen resolution* and is different for standard-screen and wide-screen HDTVs.

## What Is Aspect Ratio?

An aspect ratio is the ratio of the width to the height of the TV screen. The aspect ratios differ because the television industry manufactures both standard-screen and wide-screen HDTVs to appeal to consumer viewing preferences.

## What Is the Screen Resolution?

The screen resolution indicates the amount of detail that the picture displays. Resolution is identified by the number of display lines on the screen. The techniques that an HDTV uses to “paint” the picture on the screen are referred to as progressive and interlaced.

With the **progressive scanning** method, the lines are drawn on the screen one at a time in sequential order. Progressive scanning results in a more detailed image on the screen and is also less susceptible to the flicker commonly associated with interlaced scanning. The **interlaced method** involves refreshing pixels in alternation — first the odd lines and then the even lines.

For advanced setup, select the screen resolution that your TV can support. Refer to your *Feature Guide* and HDTV owner's manuals to choose the proper screen resolution (480i, 720p, 1080i, or 1080p) for your setup.

For example, a screen resolution of 1080i indicates that the screen shows 1080 lines in an interlaced display, and 720p indicates that the screens shows 720 lines in a progressive display.

A **standard-screen HDTV** has a 4x3 aspect ratio. The screen is 4 units wide for every 3 units tall.



A screen resolution of 480i fills the screen.

A **wide-screen HDTV** is one-third wider than a standard-screen HDTV. The screen is 16 units wide for every 9 units tall.

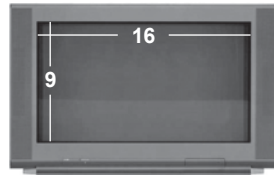

A screen resolution of 720p, 1080i, or 1080p fills the screen.

# Index

2-23-11 Draft

## A

- AC Power input 9
- Arrow keys 8
- Aspect ratio 26
- Audio Out 9, 12, 13, 14

## B

- Back panel 9
- Burn-in of screen 24
- Buttons See Front Panel

## C

- Cables 9, 10, 11, 15-23
- CAT-5 See Ethernet
- Coaxial Cable Input 9, 10, 11, 21
- Coaxial network connection 11
- Compliance, FCC 29
- Component video connection. See YPbPr

## Connectors

- See also Front panel; Back panel
- DVD recorder 14
- required for HDTV 12
- required for SDTV 13
- VCR 14

## Connecting the receiver to other devices

- DVD recorder 9, 14, 23
- HDTV with Component input (YPbPr) 17
- HDTV with DVI connector 12, 16
- HDTV with HDMI connector 12, 15
- Home Theater System with Component input (YPbPr) 22
- SDTV with Component input (YPbPr) 18
- SDTV with an S-Video connector 19
- SDTV with an RCA-type connector 20
- SDTV with Coaxial cable 21
- VCR 9, 14, 23

## Connection

- Coaxial Network 11
- Consumer electronic devices 10

Controls See Front panel

## D

- DC Power output 9
- Diagrams. See Connecting the receiver to other devices
- Digital Video Recorder. See DVR
- Digital TV, What is it 25
- DVD Connection 9, 14, 23
- DVI connector 12, 16
- DVR 6

## E

- Ethernet 9, 10, 11
- eSATA port 9

## F

- FAQs 25
- FCC compliance 29
- Formats, picture 26
- Frequently Asked Questions. See FAQs
- Front panel 8

## H

- Hard disk drive, Caution 8

## HD

- format 25
- HDTV broadcasting 25
- HDTV, what is it 25
- indicator 8

HDMI 9, 12, 15

High-definition See HD

Home theater system connection 22

## I

- Interlaced screen resolution 26
- IR sensor 8

# Index, continued

2-23-11 Draft

## K

Keys. *See* Front panel

## N

Network 9, 10, 11

## O

Optical Audio Output 9, 12, 16, 17, 22

Over-the-air converter box 14

## P

Picture formats 26

Ports. *See* Connectors

Power 8, 9

Programs, view 25

Progressive screen resolution 26

## R

Record programs 6

RGB connector 12, 24

## S

S-Video Out 9, 13, 14

S-Video In 13, 14

Safety 4, 5

Scan rates. *See* screen resolution

Screen

burn-in 24

resolution 26

size 26

SD

Connections 10, 13, 18, 19, 20, 21

TV, What is it 25

Serial number, locating 7

Sound, performance 24

Standard-definition TV 10, 13, 18, 19, 20, 21, 25

Standard-screen TV 26

## T

To Wall (Video In) connector 9, 10, 11

To TV (Video Out) connector 9, 13, 21

Troubleshooting 24

TV

digital, what is it 25

formats 26

HDTV, what is it 25

programming 25

recording 6

resolution 26

screen size. *See* aspect ratio

standard-screen 26

standard-definition 10, 13, 18, 19, 20, 21, 25

wide-screen 26

## U

USB port 8, 9

## V

VCR connection 9, 14, 23

Video In. *See* To Wall

Video Out. *See* To TV

View programs 25

## W

Wide-screen TV 26

## Y

YPbPr

connector 9, 12, 13, 17, 18, 22

HDTV connection 12, 17

home theater connection 22

SDTV connection 13, 18

# Compliance Information

## United States FCC Compliance

This device has been tested and found to comply with the limits for a Class B digital device, pursuant to part 15 of the FCC Rules. These limits are designed to provide reasonable protection against such interference in a residential installation. This equipment generates, uses, and can radiate radio frequency energy. If not installed and used in accordance with the instructions, it may cause harmful interference to radio communications. However, there is no guarantee that interference will not occur in a particular installation. If this equipment does cause harmful interference to radio or television reception, which can be determined by turning the equipment OFF and ON, the user is encouraged to try to correct the interference by one or more of the following measures:

- Increase the separation between the equipment and receiver.
- Connect the equipment into an outlet on a circuit different from that to which the receiver is connected.
- Consult the service provider or an experienced radio/television technician for help.

Any changes or modifications not expressly approved by Cisco Systems, Inc., could void the user's authority to operate the equipment.

The information shown in the FCC Declaration of Conformity paragraph below is a requirement of the FCC and is intended to supply you with information regarding the FCC approval of this device. *The phone numbers listed are for FCC-related questions only and not intended for questions regarding the connection or operation for this device. Please contact your service provider for any questions you may have regarding the operation or installation of this device.*

## FCC Declaration of Conformity

This device complies with Part 15 of FCC Rules. Operation is subject to the following two conditions: 1) the device may not cause harmful interference, and 2) the device must accept any interference received, including interference that may cause undesired operation.

ISB7005 Receiver

Models ISB7005

Manufactured by: Cisco Systems, Inc.

5030 Sugarloaf Parkway

Lawrenceville, Georgia 30044 USA

Telephone: 770 236-1077

## Canada EMI Regulation

This Class B digital apparatus complies with Canadian ICES-003. Cet appareil numérique de la class B est conforme à la norme NMB-003 du Canada.

20081121 FCC Standard

## AVC VIDEO LICENSE

2-23-11 Draft

With respect to each AVC/H.264 product, we are obligated to provide the following notice:

THIS PRODUCT IS LICENSED UNDER THE AVC PATENT PORTFOLIO LICENSE FOR THE PERSONAL USE OF A CONSUMER OR OTHER USES IN WHICH IT DOES NOT RECEIVE REMUNERATION TO (i) ENCODE VIDEO IN COMPLIANCE WITH THE AVC STANDARD ("AVC VIDEO") AND/OR (ii) DECODE AVC VIDEO THAT WAS ENCODED BY A CONSUMER ENGAGED IN A PERSONAL ACTIVITY AND/OR WAS OBTAINED FROM A VIDEO PROVIDER LICENSED TO PROVIDE AVC VIDEO. NO LICENSE IS GRANTED OR SHALL BE IMPLIED FOR ANY OTHER USE. ADDITIONAL INFORMATION MAY BE OBTAINED FROM MPEG LA, L.L.C. SEE [HTTP://WWW.MPEGLA.COM](http://www.mpegla.com).

Accordingly, please be advised that service providers, content providers, and broadcasters may be required to obtain a separate use license from MPEG LA prior to any use of AVC/H.264 encoders and/or decoders.

## ENERGY STAR® Notice

Cisco has tested and confirmed that the ISB7005 set-top models meet the Tier 1 Energy Efficiency and Power Management Criteria specified in the ENERGY STAR Program Requirements for Set-top Boxes Version 2.0.

## Macrovision Copyright Notice

This product incorporates copyright protection technology that is protected by U.S. patents and other intellectual property rights. Use of this copyright protection technology must be authorized by Macrovision, and is intended for home and other limited viewing uses only unless otherwise authorized by Macrovision. Reverse engineering or disassembly is prohibited.

## Trademarks

Cisco and the Cisco logo are trademarks or registered trademarks of Cisco and/or its affiliates in the U.S. and other countries. A listing of Cisco's trademarks can be found at [www.cisco.com/go/trademarks](http://www.cisco.com/go/trademarks).

AT&T, the AT&T logo, ConnectTech and U-verse are registered trademarks or trademarks of AT&T Knowledge Ventures.

Manufactured under license from Dolby Laboratories. Dolby and the double-D symbol are trademarks of Dolby Laboratories.

ENERGY STAR and the ENERGY STAR mark are registered trademarks of the U.S. government.

HDMI, the HDMI logo, and High-Definition Multimedia Interface are registered trademarks or trademarks of HDMI Licensing LLC in the United States and other countries.

Other third party trademarks mentioned are the property of their respective owners.

The use of the word partner does not imply a partnership relationship between Cisco and any other company. (1009R)

## Disclaimer

Cisco Systems, Inc. assumes no responsibility for errors or omissions that may appear in this manual. We reserve the right to change this manual at any time without notice.

## Federal Communication Commission Interference Statement

2-23-11 Draft

This equipment has been tested and found to comply with the limits for a Class B digital device, pursuant to Part 15 of the FCC Rules. These limits are designed to provide reasonable protection against harmful interference in a residential installation. This equipment generates, uses and can radiate radio frequency energy and, if not installed and used in accordance with the instructions, may cause harmful interference to radio communications. However, there is no guarantee that interference will not occur in a particular installation. If this equipment does cause harmful interference to radio or television reception, which can be determined by turning the equipment off and on, the user is encouraged to try to correct the interference by one of the following measures:

- Reorient or relocate the receiving antenna.
- Increase the separation between the equipment and receiver.
- Connect the equipment into an outlet on a circuit different from that to which the receiver is connected.
- Consult the dealer or an experienced radio/TV technician for help.

FCC Caution: Any changes or modifications not expressly approved by the party responsible for compliance could void the user's authority to operate this equipment.

For operation within 5150-5250MHz and 5470-5725MHz frequency range, it is restricted to indoor environment.

This device complies with Part 15 of the FCC Rules. Operation is subject to the following two conditions: (1) This device may not cause harmful interference, and (2) this device must accept any interference received, including interference that may cause undesired operation.

### IMPORTANT NOTE:

#### FCC RF Exposure Statement:

This equipment complies with FCC radiation exposure limits set forth for an uncontrolled environment. This equipment should be installed and operated with minimum distance 20cm between the radiator and your body.

This transmitter must not be co-located or operating in conjunction with any other antenna or transmitter.

The availability of some specific channels and/or operational frequency bands are country dependent and are firmware programmed at the factory to match the intended destination. The firmware setting is not accessible by the end user.

**ISB7005** with PCB antenna and max. antenna gain is 5.48 dBi in 5G.

#### Industry Canada Statement:

This device complies with RSS-210 of the Industry Canada Rules. Operation is subject to the following two conditions: (1) This device may not cause harmful interference, and (2) this device must accept any interference received, including interference that may cause undesired operation.

##### Caution:

The device for the band 5150-5250MHz and 5470-5725MHz is only for indoor usage to reduce potential for harmful interference to co-channel mobile satellite systems.

The maximum antenna gain permitted (for devices in the bands 5250-5725 MHz (**5.48** dBi) to comply with the e.i.r.p. limit; and

The maximum antenna gain permitted (for devices in the band 5725-5825 MHz (**5.48** dBi)) to comply with the e.i.r.p. limits specified for point-to-point and non point-to-point operation as appropriate, as stated in section A9.2(3).

High power radars are allocated as primary users (meaning they have priority) of 5250-5350 MHz and 5650-5850 MHz and these radars could cause interference and/or damage to LE-LAN devices.

### IMPORTANT NOTE:

#### Canada RF Exposure Statement:

This system has been evaluated for radiofrequency exposure for humans in reference to Canada Health Code 6 (2009) limits. The evaluation was based on evaluation per RSS-102 Rev 4. The minimum separation distance from the antenna to general bystander is 7.9 inches (20cm) to maintain compliance.

**Note: The ISB7005 has disabled the 5600-5650M band by S/W to avoid 5600-5650M band for IC certification.**





**Cisco Systems, Inc.**  
5030 Sugarloaf Parkway, Box 465447  
Lawrenceville, GA 30042

**678 277-1120**  
**800 722-2009**  
**[www.cisco.com](http://www.cisco.com)**