

NETGEAR Wireless Router Setup Manual

NETGEAR

NETGEAR, Inc.
4500 Great America Parkway
Santa Clara, CA 95054 USA

Version 1.0
August 2004

August 2004

Trademarks

NETGEAR is a trademark of Netgear, Inc.

Microsoft, Windows, and Windows NT are registered trademarks of Microsoft Corporation.

Other brand and product names are registered trademarks or trademarks of their respective holders.

Statement of Conditions

In the interest of improving internal design, operational function, and/or reliability, NETGEAR reserves the right to make changes to the products described in this document without notice.

NETGEAR does not assume any liability that may occur due to the use or application of the product(s) or circuit layout(s) described herein.

Federal Communications Commission (FCC) Compliance Notice: Radio Frequency Notice

This equipment has been tested and found to comply with the limits for a Class B digital device, pursuant to part 15 of the FCC Rules. These limits are designed to provide reasonable protection against harmful interference in a residential installation. This equipment generates, uses, and can radiate radio frequency energy and, if not installed and used in accordance with the instructions, may cause harmful interference to radio communications. However, there is no guarantee that interference will not occur in a particular installation. If this equipment does cause harmful interference to radio or television reception, which can be determined by turning the equipment off and on, the user is encouraged to try to correct the interference by one or more of the following measures:

- Reorient or relocate the receiving antenna.
- Increase the separation between the equipment and receiver.
- Connect the equipment into an outlet on a circuit different from that to which the receiver is connected.
- Consult the dealer or an experienced radio/TV technician for help.

EN 55 022 Declaration of Conformance

This is to certify that the Wireless Router is shielded against the generation of radio interference in accordance with the application of Council Directive 89/336/EEC, Article 4a. Conformity is declared by the application of EN 55 022 Class B (CISPR 22).

Bestätigung des Herstellers/Importeurs

Es wird hiermit bestätigt, daß das Wireless Router gemäß der im BMPT-AmtsblVfg 243/1991 und Vfg 46/1992 aufgeführten Bestimmungen entstört ist. Das vorschriftsmäßige Betreiben einiger Geräte (z.B. Testsender) kann jedoch gewissen Beschränkungen unterliegen. Lesen Sie dazu bitte die Anmerkungen in der Betriebsanleitung.

Das Bundesamt für Zulassungen in der Telekommunikation wurde davon unterrichtet, daß dieses Gerät auf den Markt gebracht wurde und es ist berechtigt, die Serie auf die Erfüllung der Vorschriften hin zu überprüfen.

Certificate of the Manufacturer/Importer

It is hereby certified that the Wireless Router has been suppressed in accordance with the conditions set out in the BMPT-AmtsblVfg 243/1991 and Vfg 46/1992. The operation of some equipment (for example, test transmitters) in accordance with the regulations may, however, be subject to certain restrictions. Please refer to the notes in the operating instructions.

Federal Office for Telecommunications Approvals has been notified of the placing of this equipment on the market and has been granted the right to test the series for compliance with the regulations.

Customer Support

Refer to the Support Information Card that shipped with your Wireless Router.

World Wide Web

NETGEAR maintains a World Wide Web home page that you can access at the universal resource locator (URL) <http://www.netgear.com>. A direct connection to the Internet and a Web browser such as Internet Explorer or Netscape are required.

Contents

Chapter 1

About This Guide

Audience, Conventions, and Formats	1-1
Tips for Printing This Manual	1-2

Chapter 2

Getting to Know Your NETGEAR Wireless Router

Package Contents	2-1
The Front Panel	2-2
The Rear Panel	2-3

Chapter 3

Connecting the Router to the Internet

Prepare to Install Your Wireless Router	3-1
First, Connect the Wireless Router to the Internet	3-1
Now, Set Up a Computer for Wireless Connectivity	3-6
Troubleshooting Tips	3-7
Overview of How to Access the Wireless Router	3-8
How to Log On to the Wireless Router After Configuration Settings Have Been Applied	3-9
How to Bypass the Configuration Assistant	3-10
How to Manually Configure Your Internet Connection	3-10
Using the Smart Setup Wizard	3-12
NETGEAR Product Registration, Support, and Documentation	3-13

Chapter 4

Optimizing Wireless Connectivity and Security

Observe Performance, Placement, and Range Guidelines	4-1
Implement Appropriate Wireless Security	4-2
Understanding Wireless Settings	4-3
Information to Gather Before Changing Basic Wireless Settings	4-6
Default Factory Settings	4-7

How to Set Up and Test Basic Wireless Connectivity	4-7
How to Configure WEP	4-9
How to Configure WPA-PSK Wireless Security	4-11
How to Restrict Wireless Access by MAC Address	4-11
Chapter 5	
Doing Basic Router Housekeeping	
Changing the Administrator Password	5-1
Configuration File Management	5-2
Restoring and Backing Up the Configuration	5-2
Erasing the Configuration	5-3
Upgrading the Wireless Router Software	5-3
Chapter 6	
Troubleshooting Common Problems	
Basic Functioning	6-1
Power Light Not On	6-1
Lights Never Turn Off	6-2
LAN or Internet (WAN) Port Lights Not On	6-2
Troubleshooting the Web Configuration Interface	6-2
Troubleshooting the ISP Connection	6-3
Troubleshooting a TCP/IP Network Using a Ping Utility	6-5
Testing the LAN Path to Your Router	6-5
Testing the Path from Your Computer to a Remote Device	6-6
Restoring the Default Configuration and Password	6-7
Appendix A	
Technical Specifications	
Glossary	
List of Glossary Terms	G-1

Chapter 1

About This Guide

This chapter describes the intended audience, scope, conventions, and formats of this manual.

Audience, Conventions, and Formats

This reference manual assumes that the reader has basic computer and Internet skills. However, basic computer network, Internet, and firewall technologies tutorial information is provided in the Appendices and on the Netgear Web site.

This guide uses the following typographical conventions:

Table 1-1. Typographical Conventions

<i>italics</i>	Emphasis, books, CDs, URL names
bold	User input
SMALL CAPS	Screen text, file and server names, extensions, commands, IP addresses

This guide uses the following format to highlight special messages:

	Note: This format is used to highlight information of importance or special interest.
---	--

This manual is written for NETGEAR wireless routers.

Table 1-2. Manual Publication Details

Product Version	Wireless Router
Manual Publication Date	August 2004

	Note: Product updates are available on the NETGEAR Web site at http://kbserver.netgear.com .
---	---

Chapter 2

Getting to Know Your NETGEAR Wireless Router

NETGEAR wireless routers provide connections for multiple computers to the Internet through an external broadband access device such as a cable modem or DSL modem that is normally intended for use by a single computer. This chapter introduces the NETGEAR Wireless Router.

Package Contents

The product package should contain the following items:

- Wireless Router.
- AC power adapter.
- Vertical stands.
- A Category 5 (CAT5) Ethernet cable.
- The Setup CD, including:
 - This guide.
 - Application Notes and other helpful information.
- Registration, Warranty Card, and Support Information Card.

If any of the parts are incorrect, missing, or damaged, contact your NETGEAR dealer. Keep the carton, including the original packing materials, in case you need to return the router for repair.

The Front Panel

The front panel of the wireless router includes these status lights.

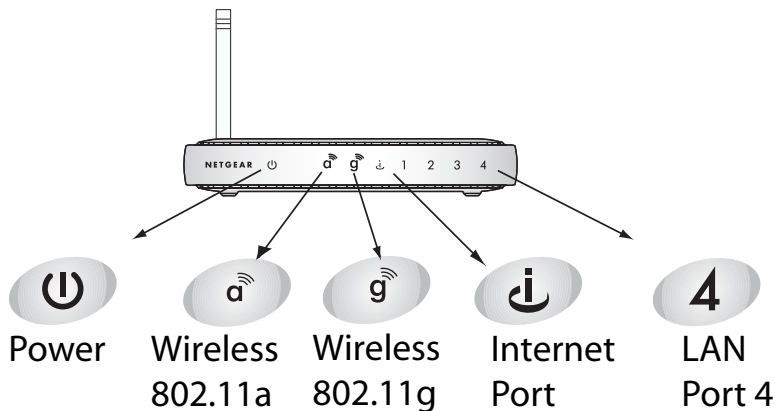

Figure 2-1: wireless router Front Panel

You can use the status lights to verify connections. Viewed from left to right, the table below describes the lights on the front panel of the router.

Table 2-1. Status Light Descriptions

Label	Activity	Description
Power	On Green Solid Amber Blink Off	Power is supplied to the router. Power is supplied to the router and it is performing its diagnostic test. Power is not supplied to the router.
Wireless 802.11a	On	The 802.11a wireless interface is enabled.
Wireless 802.11g	On	The 802.11g wireless interface is enabled.
Internet Port	On Blink	The Internet port has detected a link with an attached device. Data is being transmitted or received by the Internet port.
LAN	Green Amber	The LAN port has detected a 100 Mbps link with an attached device. The LAN port has detected a 100 Mbps link with an attached device.

The Rear Panel

The rear panel of the wireless router contains the items listed below.

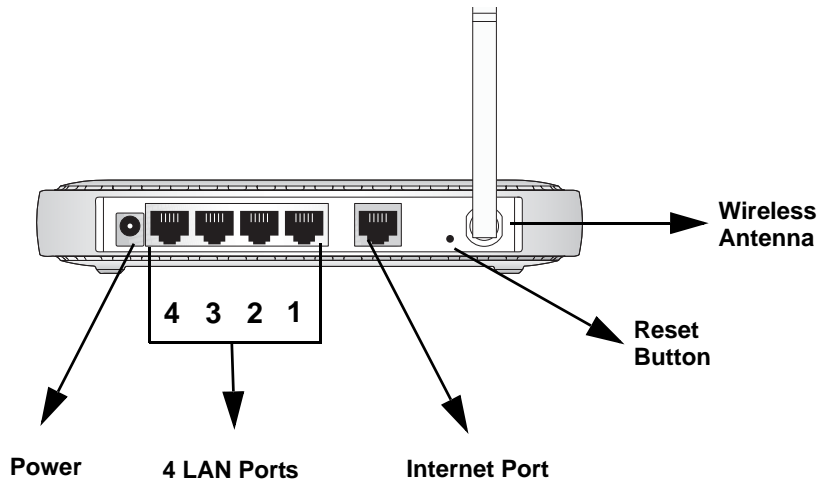

Figure 1-2: wireless router Rear Panel

Viewed from left to right, the rear panel contains the following features:

- AC power adapter outlet for [5V DC @ 2.8A output](#)
- Four LAN phone ports, the fourth for use with a DMZ server
- Internet (WAN) Ethernet port for connecting the router to a cable or DSL modem
- Factory default reset push button for [Restoring the Default Configuration and Password](#)
- Wireless antenna

Chapter 3

Connecting the Router to the Internet

This chapter describes how to set up the router on your local area network (LAN) and connect to the Internet. You will find out how to configure your wireless router for Internet access.

Follow these instructions to set up your router.

Prepare to Install Your Wireless Router

- *For Cable Modem Service:* When you perform the wireless router setup steps be sure to use the computer you first registered with your cable ISP.
- *For DSL Service:* You may need information such as the DSL login name/e-mail address and password in order to complete the wireless router setup.

Before proceeding with the wireless router installation, familiarize yourself with the contents of the Setup CD, especially this manual and the tutorials for configuring computers for networking.

First, Connect the Wireless Router to Your Network

1. CONNECT THE WIRELESS ROUTER, THE COMPUTER, AND THE MODEM
 - a. Turn off your computer.
 - b. Turn off the cable or DSL broadband modem.

- c. Locate the Ethernet cable (cable 1 in the diagram) that connects your PC to the modem.

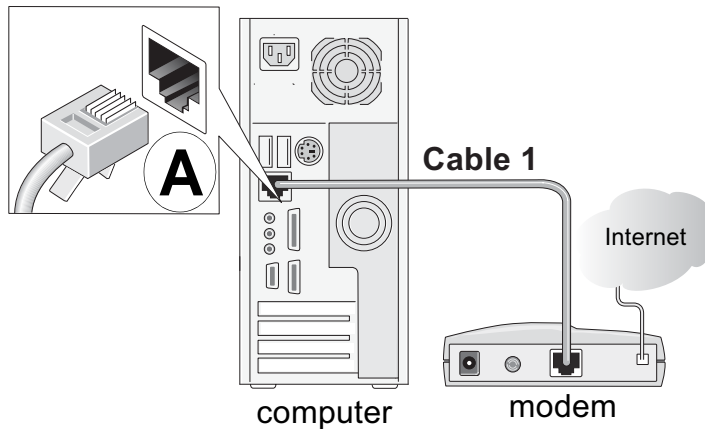

Figure 3-1: Disconnect the Ethernet cable from the computer

- d. Disconnect the cable at the computer end only, point **A** in the diagram above.
- e. Look at the label on the bottom of the wireless router. Locate the Internet port. Securely insert the Ethernet cable from your modem (cable 1 in the diagram below) into the Internet port of the wireless router as shown in point **B** of the diagram below.

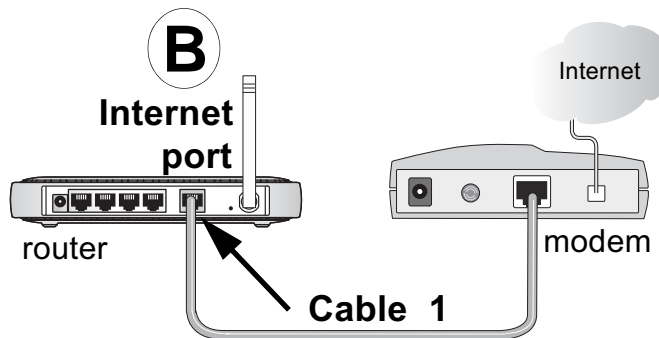

Figure 3-2: Connect the wireless router to the modem

Note: Place the wireless router in a location which conforms to the “[Observe Performance, Placement, and Range Guidelines](#)” on page 4-1. The stand provided with the wireless router provides a convenient, space-saving way of installing the wireless router. Avoid stacking it on other electronic equipment.

- f. Securely insert the blue cable that came with your wireless router (the blue NETGEAR cable in the diagram below) into a LAN port on the router such as LAN port 4 (point C in the diagram), and the other end into the Ethernet port of your computer (point D in the diagram).

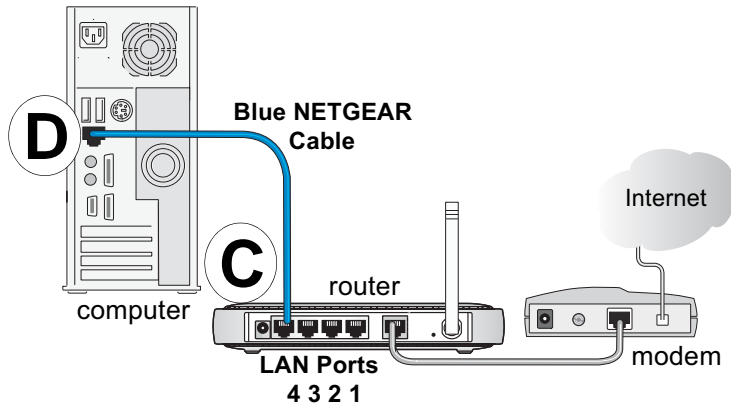

Figure 3-3: Connect the computer to the wireless router

Your network cables are connected and you are ready to restart your network.

2. RESTART YOUR NETWORK IN THE CORRECT SEQUENCE

Warning: Failure to restart your network in the correct sequence could prevent you from connecting to the Internet.

- a. First, turn on the broadband modem and wait 2 minutes.
- b. Now, plug in the power cord to your wireless router and wait 1 minute.
- c. Last, turn on your computer.

Note: For DSL customers, if software logs you in to the Internet, *do not* run that software. You may need to go to the Internet Explorer Tools menu, Internet Options, Connections tab page where you can select “Never dial a connection.”

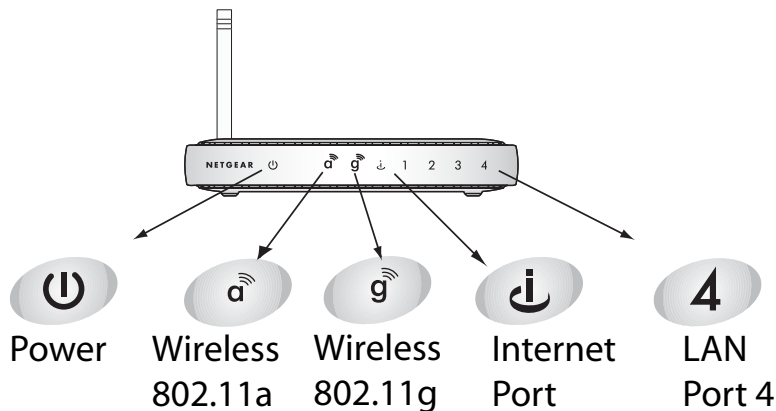

Figure 3-4: Verify the connections according to the status lights on the wireless router

- d. Check the wireless router status lights to verify the following:
 - *Power*: The power light should turn solid green. If it does not, see [“Troubleshooting Tips” on page 3-8](#).
 - *Internet*: The Internet port light should be lit. If not, make sure the Ethernet cable is securely attached to the wireless router Internet port and the modem, and the modem is powered on.
 - *Wireless*: The 802.11a and 802.11g wireless lights should be lit. If not, see [“Troubleshooting Tips” on page 3-8](#).
 - *LAN*: A LAN light should be lit. Green indicates your computer is communicating at 100 Mbps; yellow indicates 10 Mbps. If a LAN light is not lit, check that the Ethernet cable from the computer to the router is securely attached at both ends, and that the computer is turned on.

3. OPEN A BROWSER AND LOG IN TO THE ROUTER

For DSL customers, if your Internet service provider had you install software logs you in to the Internet, *do not* run that software. If such software automatically starts when you open a browser, you may need to go to the Internet Explorer Tools menu, Internet Options, Connections tab page where you can select “Never dial a connection.”

1. From the Ethernet connected computer you just set up, open a browser such as Internet Explorer or Netscape® Navigator.

Note: If your browser connects you to the Internet, you can skip this section and proceed to the [Now, Set Up a Computer for Wireless Connectivity](#) section below.

2. Connect to the wireless router by typing **http://192.168.1.1** in the address field of your browser, then click **Enter**.



3. For security reasons, the router has its own user name and password. When prompted, enter **admin** for the router user name and **password** for the router password, both in lower case letters.

Note: The router user name and password are not the same as any user name or password you may use to log in to your Internet connection.

A login window like the one shown below opens:



Figure 3-5: Login window

Note: If you cannot connect to the wireless router, verify your cables are connected correctly, that the router is powered on, and that the networking setup of your computer is set to obtain its settings automatically via DHCP. It should be set to obtain *both* IP and DNS server addresses automatically, which is usually so. For help with this, please see the tutorials on the CD.

After logging in to the router, you will see the Internet connection Smart Wizard on the settings main page.

Use the Smart Wizard to Configure Your Wireless Router



1. You are now connected to the router. If you do not see the menu above, click the Setup Wizard link on the upper left of the main menu.
2. Click **Next** to proceed. Input your ISP settings, as needed.

Note: If you choose not to use the Setup Smart Wizard, you can manually configure your Internet connection settings by following the procedures in the Setup Manual on the CD.

Unless your ISP automatically assigns your configuration automatically via DHCP, you will need the configuration parameters from your ISP.

3. When the router successfully detects an active Internet service, the router's Internet LED goes on. The Setup Smart Wizard reports which connection type it discovered, and displays the appropriate configuration menu. If the Setup Smart Wizard finds no connection, you will be prompted to check the physical connection between your router and the cable or DSL modem.
4. The Setup Smart Wizard will report the type of connection it finds and prompts you for the settings.
5. At the end of the Setup Wizard, click the **Test** button to verify your Internet connection and register your product. If you have trouble connecting to the Internet, use the Basic Setup Troubleshooting Tips below to correct basic problems, or refer to the Setup Manual on the CD.

You are now connected to the Internet and the wireless feature of the wireless router is enabled! Next, configure your wireless computer.

Now, Set Up a Computer for Wireless Connectivity



Wireless Adapter in a Notebook Computer

Configure the wireless adapter to match your wireless router settings exactly. If you changed the default Network Name (SSID), be sure to use what you set in the wireless router.

WIRELESS FEATURE	DEFAULT SETTING
802.11a Network Name (SSID)	NETGEAR_11a
802.11g Network Name (SSID)	NETGEAR_11g
WPA Security	Enabled
WPA-PSK Passphrase	NETGEAR-ULTRA-G

Warning: The Network Name (SSID) and WPA-PSK passphrase are case sensitive. Typing nETgear_11a for the 802.11a SSID will not work.

Note: If your wireless adapter does not support WPA, you must reconfigure the wireless router according to the options available on your wireless adapter.

If you need to verify the wireless settings of your wireless router, go to a computer that is connected via an Ethernet cable to the wireless router and simply open a browser. Enter **http://192.168.1.1** in your browser. Then, when prompted, enter **admin** as the user name and **password** for the password both in lower case letters.

You are now wirelessly connected to the Internet with strong security!

Troubleshooting Tips

Here are some tips for correcting simple problems you may have.

Be sure to restart your network in this sequence:

- 1) Turn off the modem, wireless router, and computer;
- 2) Turn on the modem, wait two minutes;
- 3) Turn on the wireless router and wait 1 minute;
- 4) Turn on the computer.

Make sure the Ethernet cables are securely plugged in.

- The Internet status light on the wireless router will be lit if the Ethernet cable to the wireless router from the modem is plugged in securely and the modem and wireless router are turned on.
- For each powered on computer connected to the wireless router with a securely plugged in Ethernet cable, the corresponding wireless router LAN port status light will be lit. The label on the bottom of the wireless router identifies the number of each LAN port.

Make sure the wireless settings in the computer and router match exactly.

The Wireless Network Name (SSID) and security settings of the router and wireless computer must match exactly.

Make sure the network settings of the computer are correct.

- LAN and wirelessly connected computers *must* be configured to obtain an IP address automatically via DHCP. Please see [Appendix C, “Preparing Your Network”](#) or the animated tutorials on the CD for help with this.
- Some cable modem ISPs require you to use the MAC address of the computer registered on the account. If so, in the Router MAC Address section of the Basic Settings menu, select “Use this Computer’s MAC Address.” The router will then capture and use the MAC address of the computer that you are now using. You must be using the computer that is registered with the ISP. Click **Apply** to save your settings. Restart the network in the correct sequence.

Check the router status lights to verify correct router operation.

- If the Power light does not turn solid green within 2 minutes after turning the router on, reset the router according to the instructions in [“Restoring the Default Configuration and Password” on page 6-7](#).
- If the Wireless light does not come on, verify that the wireless feature is turned on according to the instructions in [“Understanding Wireless Settings” on page 4-3](#).

How to Manually Configure Your Internet Connection

You can manually configure your router using the menu below, or you can allow the Setup Wizard to determine your configuration as described in the previous section.

ISP Does Not Require Login

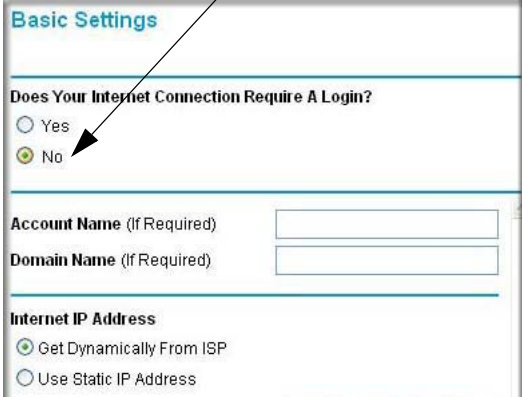

ISP Does Require Login

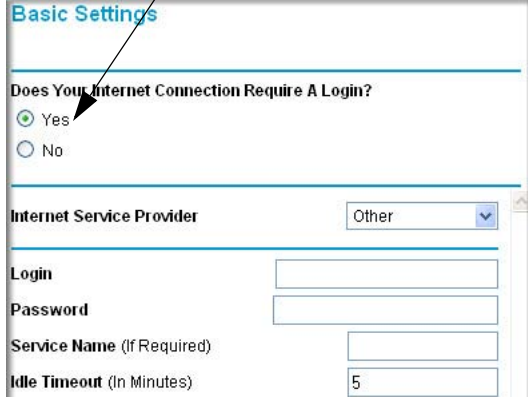

Figure 3-6: Browser-based configuration Basic Settings menus

You can manually configure the router using the Basic Settings menu shown in [Figure 3-6](#) using these steps:

1. Connect to the wireless router by typing **http://www.routerlogin.net** in the address field of your browser, then click **Enter**.
2. For security reasons, the wireless router has its own user name and password. When prompted, enter **admin** for the router user name and **password** for the router password, both in lower case letters.
3. Click **Basic Settings** on the Setup menu.
4. If your Internet connection does not require a login, click No at the top of the Basic Settings menu and fill in the settings according to the instructions below. If your Internet connection does require a login, click Yes, and skip to step 5.
 - a. Enter your Account Name (may also be called Host Name) and Domain Name. These parameters may be necessary to access your ISP's services such as mail or news servers.

b. Internet IP Address:

If your ISP has assigned you a permanent, fixed (static) IP address for your computer, select “Use static IP address”. Enter the IP address that your ISP assigned. Also enter the netmask and the Gateway IP address. The Gateway is the ISP’s router to which your router will connect.

c. Domain Name Server (DNS) Address:

If you know that your ISP does not automatically transmit DNS addresses to the router during login, select “Use these DNS servers” and enter the IP address of your ISP’s Primary DNS Server. If a Secondary DNS Server address is available, enter it also.

Note: If you enter an address here, restart the computers on your network so that these settings take effect.

d. Router’s MAC Address:

This section determines the Ethernet MAC address that will be used by the router on the Internet port. Some ISPs will register the Ethernet MAC address of the network interface card in your computer when your account is first opened. They will then only accept traffic from the MAC address of that computer. This feature allows your router to masquerade as that computer by “cloning” its MAC address.

To change the MAC address, select “**Use this Computer’s MAC address.**” The router will then capture and use the MAC address of the computer that you are now using. You must be using the one computer that is allowed by the ISP. Or, select “Use this MAC address” and type it in here.

e. Click **Apply** to save your settings.

5. If your Internet connection does require a login, fill in the settings according to the instructions below. Select Yes if you normally must launch a login program such as Enternet or WinPOET in order to access the Internet.

Note: After you finish setting up your router, you will no longer need to launch the ISP’s login program on your computer in order to access the Internet. When you start an Internet application, your router will automatically log you in.

- a. Select your Internet service provider from the drop-down list.

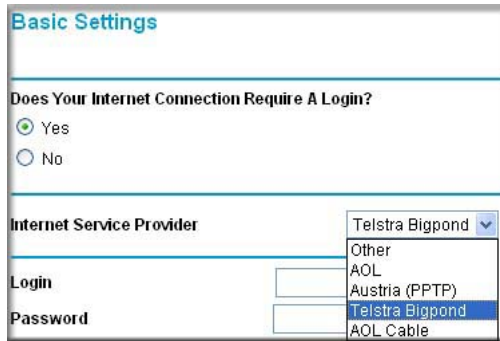

The screenshot shows a web interface titled "Basic Settings". It contains a section "Does Your Internet Connection Require A Login?" with radio buttons for "Yes" (selected) and "No". Below this is a section for "Internet Service Provider" with a dropdown menu currently showing "Telstra Bigpond". To the left of the dropdown are input fields for "Login" and "Password". The dropdown menu is open, showing a list of ISPs: "Other", "AOL", "Austria (PPTP)", "Telstra Bigpond" (highlighted), and "AOL Cable".

Figure 3-7: Basic Settings ISP list

Note: Not all ISPs are listed here. The ones on this list have special requirements.

- b. The screen will change according to the ISP settings requirements of the ISP you select.
- c. Fill in the parameters for your Internet service provider.
- d. Click **Apply** to save your settings. Click the Test button to verify you have Internet access.

NETGEAR Product Registration, Support, and Documentation

Register your product at <http://www.NETGEAR.com/register>. Registration is required before you can use our telephone support service.

Product updates and Web support are always available by going to:
<http://kbserver.netgear.com>.

When the wireless router is connected to the Internet, click the Knowledge Base or the Documentation link under the Web Support menu to view support information or the documentation for the wireless router.

Chapter 4

Optimizing Wireless Connectivity and Security

This chapter describes how to configure the wireless features of your wireless router. In planning your wireless network, you should consider the level of security required. You should also select the physical placement of your firewall in order to maximize the network speed.

The full manual with detailed how to instructions is available on line at <http://kbserver.netgear.com/documentation/wgu624.asp> and via the Documentation link in the configuration utility of the wireless router.

Observe Performance, Placement, and Range Guidelines

The operating distance or range of your wireless connection can vary significantly based on the physical placement of the wireless firewall. The latency, data throughput performance, and notebook power consumption of wireless adapters also vary depending on your configuration choices.



Note: Failure to follow these guidelines can result in significant performance degradation or inability to wirelessly connect to the router. For complete range/performance specifications, please see [Appendix A, “Technical Specifications.”](#)

For best results, place your firewall:

- Near the center of the area in which your computers will operate.
- In an elevated location such as a high shelf where the wirelessly connected computers have line-of-sight access (even if through walls).
- Away from sources of interference, such as computers, microwaves, and 2.4 GHz cordless phones.
- Away from large metal surfaces.

The time it takes to establish a wireless connection can vary depending on both your security settings and placement. WEP connections can take slightly longer to establish. Also, WEP encryption can consume more battery power on a notebook computer.

Implement Appropriate Wireless Security



Note: Indoors, computers can connect over 802.11b/g wireless networks at ranges of up to 300 feet. Such distances can allow for others outside of your immediate area to access your network.

Unlike wired network data, your wireless data transmissions can be received well beyond your walls by anyone with a compatible adapter. For this reason, use the security features of your wireless equipment. The wireless router provides highly effective security features which are covered in detail in this chapter. Deploy the security features appropriate to your needs.

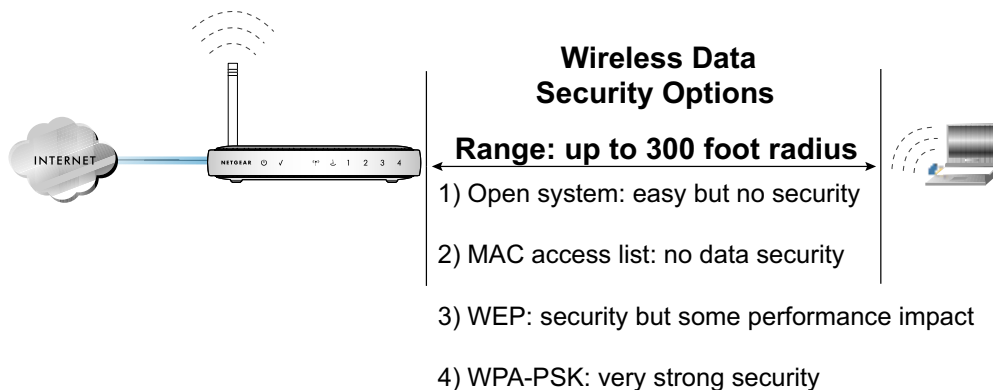

Figure 4-1: wireless router wireless data security options

There are several ways you can enhance the security of your wireless network.

- **Restrict Access Based on MAC Address.** You can restrict access to only trusted computers so that unknown computers cannot wirelessly connect to the wireless router. MAC address filtering adds an obstacle against unwanted access to your network, but the data broadcast over the wireless link is fully exposed.
- **Turn Off the Broadcast of the Wireless Network Name SSID.** If you disable broadcast of the SSID, only devices that have the correct SSID can connect. This nullifies the wireless network ‘discovery’ feature of some products such as Windows XP, but the data is still fully exposed to a determined snoop using specialized test equipment like wireless sniffers.
- **WEP.** Wired Equivalent Privacy (WEP) data encryption provides data security. WEP Shared Key authentication and WEP data encryption will block all but the most determined eavesdropper.

- **WPA-PSK.** Wi-Fi Protected Access (WPA) data encryption provides strong data security. WPA-PSK will block eavesdropping. Because this is a new standard, wireless device driver and software availability may be limited.
- **Turn Off the Wired LAN.** If you disable the wireless LAN, wireless devices cannot communicate with the router at all. You might choose to turn off the wireless the LAN when you are away and the others in the household all use wired connections.

Understanding Wireless Settings

To configure the Wireless settings of your firewall, click the Wireless link in the main menu of the browser interface.

- **Name (SSID).** The SSID is also known as the wireless network name. Enter a value of up to 32 alphanumeric characters. In a setting where there is more than one wireless network, different wireless network names provide a means for separating the traffic. Any device you want to participate in a particular wireless network will need to use this SSID for that network.
- **Region.** This field identifies the region where the wireless router can be used. It may not be legal to operate the wireless features of the wireless router in a region other than one of those identified in this field.
- **Channel.** This field determines which operating frequency will be used. It should not be necessary to change the wireless channel unless you notice interference problems with another nearby access point.
- **Mode.** This field determines which data communications protocol will be used.
- **Security Options.** These options are the wireless security features you can enable. The table below identifies the various basic wireless security options.
- **Allow Broadcast of Name (SSID).** If you disable broadcast of the SSID, only devices that have the correct SSID can connect. Disabling SSID broadcast nullifies the wireless network 'discovery' feature of some products such as Windows XP.
- **Enable Wireless Access Point.** If you disable the wireless access point, wireless devices cannot connect to the wireless router.
- **Wireless Card Access List.** When the Trusted PCs Only radio button is selected, the wireless router checks the MAC address of the wireless station and only allows connections to computers identified on the trusted computers list.

Table 4-1. Basic Wireless Security Options

Field	Description
Automatic	No wireless security.
WEP	<p>WEP offers the following options:</p> <ul style="list-style-type: none">• Open System With Open Network Authentication and 64- or 128-bit WEP Data Encryption, the wireless router <i>does</i> perform 64- or 128-bit data encryption but <i>does not</i> perform any authentication.• Shared Key Shared Key authentication encrypts the SSID and data. Choose the Encryption Strength (64- or 128-bit data encryption). Manually enter the key values or enter a word or group of printable characters in the Passphrase box. Manually entered keys <i>are</i> case sensitive but passphrase characters <i>are not</i> case sensitive. Note: Not all wireless adapter configuration utilities support passphrase key generation.• Auto
WPA-PSK	<p>WPA-Pre-shared Key <i>does</i> perform authentication, uses 128-bit data encryption and dynamically changes the encryption keys making it nearly impossible to circumvent. Enter a word or group of printable characters in the Password Phrase box. These characters <i>are</i> case sensitive.</p> <p>Note: Not all wireless adapter configuration utilities support WPA. Furthermore, client software is required on the client. Windows XP and Windows 2000 with Service Pack 3 do include the client software that supports WPA. Nevertheless, the wireless adapter hardware and driver must also support WPA.</p>

Information to Gather Before Changing Basic Wireless Settings

Before customizing your wireless settings, print this form and record the following information.

- **802.11a Wireless Network Name (SSID):** _____

802.11g Wireless Network Name (SSID): _____

The SSID, identifies the wireless network. You can use up to 32 alphanumeric characters. The SSID *is* case sensitive. The SSID in the wireless adapter card must match the SSID of the wireless router. In some configuration utilities (such as in Windows XP), the term “wireless network name” is used instead of SSID.

- **If WEP Authentication is Used.** Circle one: **Open System, Shared Key, or Auto.**

Note: If you select Shared Key, the other devices in the network will not connect unless they are set to Shared Key as well and are configured with the correct key.

- **WEP Encryption key size.** Choose one: **64-bit** or **128-bit**. Again, the encryption key size must be the same for the wireless adapters and the wireless router.

- **Data Encryption (WEP) Keys.** There are two methods for creating WEP data encryption keys. Whichever method you use, record the key values in the spaces below.

- **Passphrase method.** _____ These characters *are* case sensitive. Enter a word or group of printable characters and click the Generate Keys button. Not all wireless devices support the passphrase method.

- **Manual method.** These values *are not* case sensitive. For 64-bit WEP, enter 10 hex digits (any combination of 0-9 or a-f). For 128-bit WEP, enter 26 hex digits.

Key 1: _____

Key 2: _____

Key 3: _____

Key 4: _____

- **If WPA-PSK Authentication is Used.**

- **Passphrase:** _____ These characters *are* case sensitive. Enter a word or group of printable characters. When you use WPA-PSK, the other devices in the network will not connect unless they are set to WPA-PSK as well and are configured with the correct Passphrase.

Use the procedures described in the reference manual to configure the wireless router. The reference manual is available on line at <http://kbserver.netgear.com/documentation/wgu624.asp>.

Default Factory Settings

When you first receive your wireless router, the default factory settings are shown below. You can restore these defaults with the Factory Default Restore button on the rear panel. After you install the wireless router, use the procedures below to customize any of the settings to better meet your networking needs.

WIRELESS FEATURE	DEFAULT SETTING
Wireless Access Point	Enabled
Wireless Access List (MAC Filtering)	All wireless stations allowed
SSID broadcast	Enabled
802.11a Network Name (SSID)	NETGEAR_11a
802.11g Network Name (SSID)	NETGEAR_11g
WPA Security	Enabled
WPA Passphrase	NETGEAR-ULTRA-G

Warning: The Network Name (SSID) and passphrase are case sensitive. Typing nETgear_11a for the 802.11a SSID will not work.

Chapter 5

Doing Basic Router Housekeeping

This chapter describes how to use some of the maintenance features of your Wireless Router. These features can be found by clicking on the Maintenance heading in the Main Menu of the browser interface. Other maintenance features not presented in this chapter can be found accessed via links in the browser interface of the wireless router to the User Guide and in the help screens.

Changing the Administrator Password



Note: Before changing the wireless router password, follow the instructions under “[Configuration File Management](#)” on page 5-2 to save your configuration settings. If you forget the new password, you will have to reset the wireless router back to the factory defaults to be able to log in using the default password of password. This means you will have to restore all the wireless router configuration settings. If you ever have to reset the wireless router back to the factory defaults, you can restore your settings from the backup configuration file.

The default password for the wireless router’s Web Configuration Manager is **password**. Change this password to a more secure password.

From the Main Menu of the browser interface, under the Maintenance heading, select Set Password to bring up the menu shown below.

Change Password

Old password

New password

Repeat new password

Figure 5-1: Set Password menu

To change the password, first enter the old password, then enter the new password twice. Click Apply.

Configuration File Management

The configuration settings of the wireless router are stored within the wireless router in a configuration file. This file can be saved (backed up) to a user's PC, retrieved (restored) from the user's PC, or cleared to factory default settings.

From the Main Menu of the browser interface, under the Maintenance heading, select the Settings Backup heading to bring up the menu shown below.

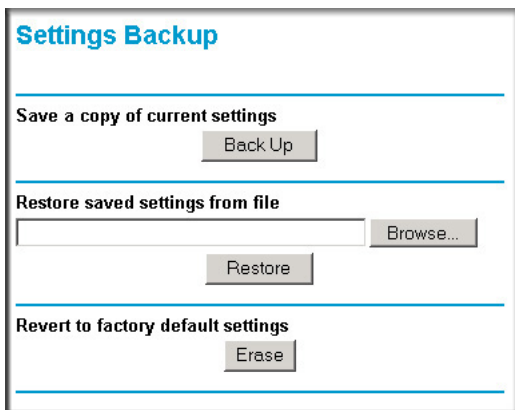

The screenshot shows a web browser window titled "Settings Backup". The page has a light blue header with the title. Below the header, there are three sections separated by horizontal lines. The first section is titled "Save a copy of current settings" and contains a single button labeled "Back Up". The second section is titled "Restore saved settings from file" and contains a text input field, a "Browse..." button to its right, and a "Restore" button below the input field. The third section is titled "Revert to factory default settings" and contains a single button labeled "Erase".

Figure 5-2: Settings Backup menu

Three options are available, and are described in the following sections.

Restoring and Backing Up the Configuration

The Restore and Backup options in the Settings Backup menu allow you to save and retrieve a file containing your wireless router's configuration settings.

To save your settings, click the Backup button. Your browser will extract the configuration file from the wireless router and will prompt you for a location on your PC to store the file. You can give the file a meaningful name at this time, such as pacbell.cfg.

To restore your settings from a saved configuration file, enter the full path to the file on your PC or click the Browse button to browse to the file. When you have located it, click the Restore button to send the file to the wireless router. The wireless router will then reboot automatically.

Warning: Do not interrupt the reboot process.

Erasing the Configuration

It is sometimes desirable to restore the wireless router to original default settings. This can be done by using the Erase function, which will restore all factory settings. After an erase, the wireless router's password will be **password**, the LAN IP address will be 192.168.1.1, and the wireless router's DHCP client will be enabled.

To erase the configuration, click the Erase button.

To restore the factory default configuration settings without knowing the login password or IP address, you must use the Default Reset button on the rear panel of the wireless router. See [“Restoring the Default Configuration and Password” on page 6-7](#).

Upgrading the Wireless Router Software



Note: Before upgrading the wireless router software, use the wireless router backup utility to save your configuration settings. Any wireless router upgrade will revert the wireless router settings back to the factory defaults. After completing the upgrade, you can restore your settings from the backup.

The routing software of the wireless router is stored in FLASH memory, and can be upgraded as new software is released by NETGEAR. Upgrade files can be downloaded from the NETGEAR Web site. If the upgrade file is compressed (.ZIP file), you must first extract the file before sending it to the wireless router. The upgrade file can be sent to the wireless router using your browser.

Note: The Web browser used to upload new firmware into the wireless router must support HTTP uploads. NETGEAR recommends using Microsoft Internet Explorer or Netscape Navigator 3.0 or above.

From the Main Menu of the browser interface, under the Maintenance heading, select the Router Upgrade link display the menu shown below.

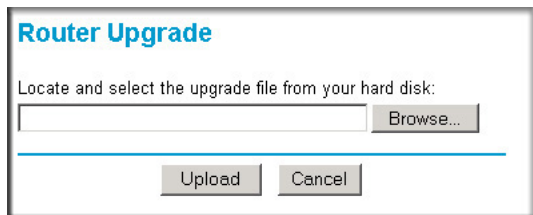

Figure 5-3: Router Upgrade menu

To upload new firmware:

1. Download and unzip the new software file from NETGEAR.
2. In the Router Upgrade menu, click the Browse button and browse to the location of the upgrade file
3. Click Upload.

Note: When uploading software to the wireless router, it is important not to interrupt the Web browser by closing the window, clicking a link, or loading a new page. If the browser is interrupted, it may corrupt the software. When the upload is complete, your wireless router will automatically restart. The upgrade process will typically take about one minute.

In some cases, you may need to reconfigure the wireless router after upgrading.

Chapter 6

Troubleshooting Common Problems

This chapter gives information about troubleshooting your Wireless Router. After each problem description, instructions are provided to help you diagnose and solve the problem.

Basic Functioning

After you turn on power to the router, the following sequence of events should occur:

1. When power is first applied, verify that the Power light  is on.
2. After approximately 10 seconds, verify that:
 - a. The power light is solid green.
 - b. The LAN port lights are lit for any local ports that are connected.
 - c. The Internet port light is lit.

If a port's light is lit, a link has been established to the connected device. If a LAN port is connected to a 100 Mbps device, verify that the port's light is green. If the port is 10 Mbps, the light will be amber.

If any of these conditions does not occur, refer to the appropriate following section.

Power Light Not On

If the Power and other lights are off when your router is turned on:

- Make sure that the power cord is properly connected to your router and that the power supply adapter is properly connected to a functioning power outlet.
- Check that you are using the [5V DC @ 2.8A output](#) power adapter supplied by NETGEAR for this product.

If the error persists, you have a hardware problem and should contact technical support.

Lights Never Turn Off

When the router is turned on, the lights turn on for about 10 seconds and then turn off. If all the lights stay on, there is a fault within the router.

If all lights are still on one minute after power up:

- Cycle the power to see if the router recovers.
- Clear the router's configuration to factory defaults. This will set the router's IP address to 192.168.1.1. This procedure is explained in [“Restoring the Default Configuration and Password” on page 6-7](#).

If the error persists, you might have a hardware problem and should contact technical support.

LAN or Internet (WAN) Port Lights Not On

If either the LAN lights or Internet light do not light when the Ethernet connection is made, check the following:

- Make sure that the Ethernet cable connections are secure at the router and at the hub or workstation.
- Make sure that power is turned on to the connected hub or workstation.
- Be sure you are using the correct cable:
 - When connecting the router's Internet port to a cable or DSL modem, use the cable that was supplied with the cable or DSL modem. This cable could be a standard straight-through Ethernet cable or an Ethernet crossover cable.

Troubleshooting the Web Configuration Interface

If you are unable to access the router's Web Configuration interface from a computer on your local network, check the following:

- Check the Ethernet connection between the computer and the router as described in the previous section.

- Make sure your computer's IP address is on the same subnet as the router. If you are using the default addressing schemes, your computer's address should be in the range of 192.168.1.2 to 192.168.1.254. Refer to “[Verifying TCP/IP Properties](#)” on page C-8 or “[Verifying TCP/IP Properties for Macintosh Computers](#)” on page C-19 to find your computer's IP address. Follow the instructions in [Appendix C](#) to configure your computer.

Note: If your computer's IP address is shown as 169.254.x.x, the computer is not configured correctly for your network. Recent versions of Windows and MacOS will generate and assign a 169.254.x.x IP address if the computer cannot reach a DHCP server. These auto-generated addresses are in the range of 169.254.x.x. If your IP address is in this range, check the connection from the computer to the router and reboot your computer.

- Make sure your browser has Java, JavaScript, or ActiveX enabled. If you are using Internet Explorer, click Refresh to be sure the Java applet is loaded.
- Try quitting the browser and launching it again.
- Make sure you are using the correct login information. The URL for the router is <http://www.routerlogin.net> or <http://www.routerlogin.com>. The factory default login name is **admin** and the password is **password**, both in lower case letters. Make sure that CAPS LOCK is off when entering this information.

If the router does not save changes you have made in the Web Configuration Interface, check the following:

- When entering configuration settings, be sure to click the APPLY button before moving to another menu or tab, or your changes are lost.
- Click the Refresh or Reload button in the Web browser. The changes may have occurred, but the Web browser may be caching the old configuration.

Troubleshooting the ISP Connection

If your router is unable to access the Internet, you should first determine whether the router is able to obtain a WAN IP address from the ISP. Unless you have been assigned a static IP address, your router must request an IP address from the ISP. You can determine whether the request was successful using the Web Configuration Manager.

To check the WAN IP address:

1. Launch your browser and select an external site such as www.netgear.com
2. Access the Main Menu of the router's configuration at <http://www.routerlogin.net>.

3. Under the Maintenance heading, select Router Status
4. Check that an IP address is shown for the WAN Port
If 0.0.0.0 is shown, your router has not obtained an IP address from your ISP.

If your router is unable to obtain an IP address from the ISP, you may need to force your cable or DSL modem to recognize your new router by performing the following procedure:

1. Turn off power to the cable or DSL modem.
2. Turn off power to your router.
3. Wait five minutes and reapply power to the cable or DSL modem.
4. When the modem's lights indicate that it has reacquired sync with the ISP, reapply power to your router.
5. Then restart your computer.

If your router is still unable to obtain an IP address from the ISP, the problem may be one of the following:

- Your ISP may require a login program.
Ask your ISP whether they require PPP over Ethernet (PPPoE) or some other type of login.
- If your ISP requires a login, you may have incorrectly set the login name and password in the router.
- Your ISP may check for your computer's host name.
Assign the computer Host Name of your ISP account as the Account Name in the Basic Settings menu.
- Your ISP only allows one Ethernet MAC address to connect to Internet, and may check for your computer's MAC address. In this case:
Inform your ISP that you have bought a new network device, and ask them to use the router's MAC address.

OR

Configure your router to spoof your computer's MAC address. This can be done in the Basic Settings menu.

If your router can obtain an IP address, but your computer is unable to load any Web pages from the Internet:

- Your computer may not recognize any DNS server addresses.

A DNS server is a host on the Internet that translates Internet names (such as www addresses) to numeric IP addresses. Typically your ISP will provide the addresses of one or two DNS servers for your use. If you entered a DNS address during the router's configuration, reboot your computer and verify the DNS address as described in [“Install or Verify Windows Networking Components” on page C-9](#). Alternatively, you may configure your computer manually with DNS addresses, as explained in your operating system documentation.

- Your computer may not have the router configured as its TCP/IP gateway.

If your computer obtains its information from the router by DHCP, reboot the computer and verify the gateway address as described in [“Install or Verify Windows Networking Components” on page C-9](#).

Troubleshooting a TCP/IP Network Using a Ping Utility

Most TCP/IP terminal devices and routers contain a ping utility that sends an echo request packet to the designated device. The device then responds with an echo reply. Troubleshooting a TCP/IP network is made very easy by using the ping utility in your computer or workstation.

Testing the LAN Path to Your Router

You can ping the router from your computer to verify that the LAN path to your router is set up correctly.

To ping the router from a running Windows 95 or later:

1. From the Windows toolbar, click on the Start button and select Run.
2. In the field provided, type Ping followed by the IP address of the router, as in this example:

```
ping 192.168.1.1
```

3. Click on OK.

You should see a message like this one:

```
Pinging <IP address> with 32 bytes of data
```

If the path is working, you see this message:

```
Reply from < IP address >: bytes=32 time=NN ms TTL=xxx
```

If the path is not working, you see this message:

```
Request timed out
```

If the path is not functioning correctly, you could have one of the following problems:

- Wrong physical connections
 - Make sure the LAN port LED is on. If the LED is off, follow the instructions in [“LAN or Internet \(WAN\) Port Lights Not On”](#) on page 6-2.
 - Check that the corresponding Link LEDs are on for your network interface card and for the hub ports (if any) that are connected to your workstation and router.
- Wrong network configuration
 - Verify that the Ethernet card driver software and TCP/IP software are both installed and configured on your computer or workstation.
 - Verify that the IP address for your router and your workstation are correct and that the addresses are on the same subnet.

Testing the Path from Your Computer to a Remote Device

After verifying that the LAN path works correctly, test the path from your computer to a remote device. From the Windows run menu, type:

```
PING -n 10 <IP address>
```

where *<IP address>* is the IP address of a remote device such as your ISP's DNS server.

If the path is functioning correctly, replies as in the previous section are displayed. If you do not receive replies:

- Check that your computer has the IP address of your router listed as the default gateway. If the IP configuration of your computer is assigned by DHCP, this information will not be visible in your computer's Network Control Panel. Verify that the IP address of the router is listed as the default gateway as described in [“Install or Verify Windows Networking Components”](#) on page C-9.
- Check to see that the network address of your computer (the portion of the IP address specified by the netmask) is different from the network address of the remote device.
- Check that your cable or DSL modem is connected and functioning.
- If your ISP assigned a host name to your computer, enter that host name as the Account Name in the Basic Settings menu.

- Your ISP could be rejecting the Ethernet MAC addresses of all but one of your computers. Many broadband ISPs restrict access by only allowing traffic from the MAC address of your broadband modem, but some ISPs additionally restrict access to the MAC address of a single computer connected to that modem. If this is the case, you must log in to the router and use the Basic Settings menu to configure your router to “clone” or “spoof” the MAC address from the authorized computer.

Restoring the Default Configuration and Password

This section explains how to restore the factory default configuration settings, changing the router’s administration password to **password**. You can erase the current configuration and restore factory defaults in two ways:

- Use the Erase function of the router (see [“Erasing the Configuration” on page 5-3](#)).
- Use the Default Reset button on the rear panel of the router. Use this method for cases when the administration password or IP address is not known.

To restore the factory default configuration settings without knowing the administration password or IP address, you must use the Default Reset button on the rear panel of the router.

1. Press and hold the Default Reset button until the power light blinks on (about 10 seconds).
2. Release the Default Reset button and wait for the router to reboot.

If the wireless router fails to restart or the power light continues to blink or turns solid amber, the unit may be defective. If the error persists, you might have a hardware problem and should contact technical support.

Appendix A

Technical Specifications

This appendix provides technical specifications for the Wireless Router.

Network Protocol and Standards Compatibility

Data and Routing Protocols: TCP/IP, RIP-1, RIP-2, DHCP
PPP over Ethernet (PPPoE)

Power Adapter

North America: 120V, 60 Hz, input
United Kingdom, Australia: 240V, 50 Hz, input
Europe: 230V, 50 Hz, input
Japan: 100V, 50/60 Hz, input
All regions (output): 5V DC @ 2.8A output

Physical Specifications

Dimensions: 28 x 175 x 119 mm (1.1 x 6.89 x 4.68 in.)
Weight: 0.3 kg (0.66 lb)

Environmental Specifications

Operating temperature: 0° to 40° C (32° to 104° F)
Operating humidity: 90% maximum relative humidity, noncondensing

Electromagnetic Emissions

Meets requirements of: FCC Part 15 Class B
EN 55 022 (CISPR 22), Class B
C-Tick N10947

Interface Specifications

The router incorporates Auto Uplink™ technology which eliminates the need for crossover cables.

LAN: 10BASE-T or 100BASE-Tx, RJ-45, autosensing and capable of full-duplex or half-duplex operation.

WAN: 10BASE-T or 100BASE-Tx, RJ-45, autosensing and capable of full-duplex or half-duplex operation.

Wireless

Radio Data Rates	1, 2, 5.5, 6, 9, 12, 18, 24, 36, 48, and 54 Mbps Auto Rate Sensing
Frequency	2.4-5Ghz
Data Encoding:	802.11b/g/2.4GHz to 2.5GHz CCK and OFDM Modulation 802.11a <ul style="list-style-type: none">• 5.15 ~ 5.25 GHz (lower band)• 5.25 ~ 5.35 GHz (middle band)• 5.725 ~ 5.825 GHz (hi-band)
Maximum Computers Per Wireless Network:	Limited by the amount of wireless network traffic generated by each node. Typically up to 30 nodes.
Operating Frequency Ranges:	2.412~2.462 GHz (US) 2.457~2.462 GHz (Spain) 2.412~2.484 GHz (Japan)2.457~2.472 GHz (France) 2.412~2.472 GHz (Europe ETSI)
802.11 Security:	40-bits (also called 64-bits) and 128-bits WEP and WPA

Glossary

Use the list below to find definitions for technical terms used in this manual.

List of Glossary Terms

802.11b

IEEE specification for wireless networking at 11 Mbps using direct-sequence spread-spectrum (DSSS) technology and operating in the unlicensed radio spectrum at 2.5GHz.

802.11g

A soon to be ratified IEEE specification for wireless networking at 54 Mbps using direct-sequence spread-spectrum (DSSS) technology and operating in the unlicensed radio spectrum at 2.5GHz. 802.11g is backwards compatible with 802.11b.

Cat 5

Category 5 unshielded twisted pair (UTP) cabling. An Ethernet network operating at 10 Mbits/second (10BASE-T) will often tolerate low quality cables, but at 100 Mbits/second (10BASE-Tx) the cable must be rated as Category 5, or Cat 5 or Cat V, by the Electronic Industry Association (EIA).

This rating will be printed on the cable jacket. Cat 5 cable contains eight conductors, arranged in four twisted pairs, and terminated with an RJ45 type connector. In addition, there are restrictions on maximum cable length for both 10 and 100 Mbits/second networks.

DHCP

An Ethernet protocol specifying how a centralized DHCP server can assign network configuration information to multiple DHCP clients. The assigned information includes IP addresses, DNS addresses, and gateway (router) addresses.

DNS

Short for Domain Name System (or Service), an Internet service that translates domain names into IP addresses.

Because domain names are alphabetic, they're easier to remember. The Internet however, is really based on IP addresses. Every time you use a domain name, therefore, a DNS service must translate the name into the corresponding IP address. For example, the domain name `www.example.com` might translate to `198.105.232.4`. The DNS system is, in fact, its own network. If one DNS server doesn't know how to translate a particular domain name, it asks another one, and so on, until the correct IP address is returned.

Domain Name

A descriptive name for an address or group of addresses on the Internet. Domain names are of the form of a registered entity name plus one of a number of predefined top level suffixes such as .com, .edu, .uk, etc. For example, in the address mail.NETGEAR.com, mail is a server name and NETGEAR.com is the domain.

DSL

Short for digital subscriber line, but is commonly used in reference to the asymmetric version of this technology (ADSL) that allows data to be sent over existing copper telephone lines at data rates of from 1.5 to 9 Mbps when receiving data (known as the downstream rate) and from 16 to 640 Kbps when sending data (known as the upstream rate).

ADSL requires a special ADSL modem. ADSL is growing in popularity as more areas around the world gain access.

Dynamic Host Configuration Protocol

DHCP. An Ethernet protocol specifying how a centralized DHCP server can assign network configuration information to multiple DHCP clients. The assigned information includes IP addresses, DNS addresses, and gateway (router) addresses.

Gateway

A local device, usually a router, that connects hosts on a local network to other networks.

IP

Internet Protocol is the main internetworking protocol used in the Internet. Used in conjunction with the Transfer Control Protocol (TCP) to form TCP/IP.

IP Address

A four-byte number uniquely defining each host on the Internet, usually written in dotted-decimal notation with periods separating the bytes (for example, 134.177.244.57).

Ranges of addresses are assigned by Internic, an organization formed for this purpose.

ISP

Internet service provider.

Internet Protocol

The main internetworking protocol used in the Internet. Used in conjunction with the Transfer Control Protocol (TCP) to form TCP/IP.

local area network

LAN. A communications network serving users within a limited area, such as one floor of a building. A LAN typically connects multiple personal computers and shared network devices such as storage and printers. Although many technologies exist to implement a LAN, Ethernet is the most common for connecting personal computers.

MAC address

The Media Access Control address is a unique 48-bit hardware address assigned to every network interface card. Usually written in the form 01:23:45:67:89:ab.

Mbps

Megabits per second.

Point-to-Point Protocol

PPP. A protocol allowing a computer using TCP/IP to connect directly to the Internet.

PPPoA

PPPoA. PPP over ATM is a protocol for connecting remote hosts to the Internet over an always-on connection by simulating a dial-up connection.

PPPoE

PPPoE. PPP over Ethernet is a protocol for connecting remote hosts to the Internet over an always-on connection by simulating a dial-up connection.

PPP over ATM

PPPoA. PPP over ATM is a protocol for connecting remote hosts to the Internet over an always-on connection by simulating a dial-up connection.

PPTP

Point-to-Point Tunneling Protocol. A method for establishing a virtual private network (VPN) by embedding Microsoft's network protocol into Internet packets.

router

A device that forwards data between networks. An IP router forwards data based on IP source and destination addresses.

SSID

A Service Set Identification is a thirty-two character (maximum) alphanumeric key identifying a wireless local area network. For the wireless devices in a network to communicate with each other, all devices must be configured with the same SSID.

This is typically the configuration parameter for a wireless PC card. It corresponds to the ESSID in the wireless Access Point and to the wireless network name. *See also* Wireless Network Name and ESSID.

Subnet Mask

A mask used to determine what subnet an IP address belongs to. Subnetting enables a network administrator to further divide an IP address into two or more subnets.

An IP address has two components, the network address and the host address. For example, consider the IP address 150.215.017.009. Assuming this is part of a Class B network, the first two numbers (150.215) represent the Class B network address, and the second two numbers (017.009) identify a particular host on this network.

Subnetting enables the network administrator to further divide the host part of the address into two or more subnets. In this case, a part of the host address is reserved to identify the particular subnet. This is easier to see if we show the IP address in binary format. The full address is: 10010110.11010111.00010001.00001001
The Class B network part is: 10010110.11010111
and the host address is 00010001.00001001

If this network is divided into 14 subnets, however, then the first 4 bits of the host address (0001) are reserved for identifying the subnet.

The subnet mask is the network address plus the bits reserved for identifying the subnetwork. (By convention, the bits for the network address are all set to 1, though it would also work if the bits were set exactly as in the network address.) In this case, therefore, the subnet mask would be 11111111.11111111.11110000.00000000. It's called a mask because it can be used to identify the subnet to which an IP address belongs by performing a bitwise AND operation on the mask and the IP address. The result is the subnetwork address: Subnet Mask 255.255.240.000 11111111.11111111.11110000.00000000
IP Address 150.215.017.009 10010110.11010111.00010001.00001001
Subnet Address 150.215.016.000 10010110.11010111.00010000.00000000

The subnet address, therefore, is 150.215.016.000.

TCP/IP

The main internetworking protocols used in the Internet. The Internet Protocol (IP) used in conjunction with the Transfer Control Protocol (TCP) form TCP/IP.

WAN

Wide Area Network. A long distance link used to extend or connect remotely located local area networks. The Internet is a large WAN.

WEP

Wired Equivalent Privacy is a data encryption protocol for 802.11b wireless networks. All wireless nodes and access points on the network are configured with a 64-bit or 128-bit Shared Key for data encryption.

Wi-Fi

A trade name for the 802.11b wireless networking standard, given by the Wireless Ethernet Compatibility Alliance (WECA, see <http://www.wi-fi.net>), an industry standards group promoting interoperability among 802.11b devices.

Wireless Network Name (SSID)

Wireless Network Name (SSID) is the name assigned to a wireless network. This is the same as the SSID or ESSID configuration parameter.

WPA

Wi-Fi Protected Access (WPA) is a specification of standards-based, interoperable security enhancements that increase the level of data protection and access control for existing and future wireless LAN systems.

Federal Communication Commission Interference Statement

This equipment has been tested and found to comply with the limits for a Class B digital device, pursuant to Part 15 of the FCC Rules. These limits are designed to provide reasonable protection against harmful interference in a residential installation. This equipment generates, uses and can radiate radio frequency energy and, if not installed and used in accordance with the instructions, may cause harmful interference to radio communications. However, there is no guarantee that interference will not occur in a particular installation. If this equipment does cause harmful interference to radio or television reception, which can be determined by turning the equipment off and on, the user is encouraged to try to correct the interference by one of the following measures:

- Reorient or relocate the receiving antenna.
- Increase the separation between the equipment and receiver.
- Connect the equipment into an outlet on a circuit different from that to which the receiver is connected.
- Consult the dealer or an experienced radio/TV technician for help.

This device complies with Part 15 of the FCC Rules. Operation is subject to the following two conditions: (1) This device may not cause harmful interference, and (2) this device must accept any interference received, including interference that may cause undesired operation.

FCC Caution: Any changes or modifications not expressly approved by the party responsible for compliance could void the user's authority to operate this equipment.

IMPORTANT NOTE:

FCC Radiation Exposure Statement:

This equipment complies with FCC radiation exposure limits set forth for an uncontrolled environment. This equipment should be installed and operated with minimum distance 20cm between the radiator & your body.

If this device is going to be operated in 5.15 ~ 5.25GHz frequency range, then it is restricted in indoor environment only.

This transmitter must not be co-located or operating in conjunction with any other antenna or transmitter.