

<b>Document Number</b>	<b>1.00.01</b>
<b>Created By</b>	<b>Martin Worth</b>

# Play Wireless Modem Router

## Product Requirements Document

### Purpose of a Product Requirements Document

The purpose this document is to describe:

1. The business case for the new function/product/feature
2. How the new function/product/feature fits strategically with company objectives
3. The competitive landscape and how this new function/product/feature compares to the competition
4. The functional requirements, including transition/upgrade requirements and customer usability requirements

The Product Requirements Document is intended for internal Belkin use only. A separate sanitized version may be needed for projects requiring customer use and approval.

### Product Description

The Belkin F7D4402 Play Wireless is a router with built-in ADSL2+ modem and access point (AP), which operates on 2.4GHz and 5GHz frequencies, conforms to the IEEE 802.11b/g/n wireless standards.

The modem is compatible with ADSL, ADSL2, and ADSL2+ lines for connecting to the Internet. The modem combines a NAT router for sharing and a firewall for security. The integrated Wireless N radio operates on 2.4GHz frequencies, which conforms to the IEEE 802.11b/g/n wireless standards.

### Reviewers

<b>Department</b>	<b>Name/Title</b>
Product Manager	
SW Engineering (if needed)	
HW Engineering (if needed)	
Mechanical Engineering	
Industrial Design	
User Experience	
Branding	



*A revision would be changes related to findings during the development process that may be caused by a number of factors – engineering changes, market shifts, customer requirements, etc.*

## Table of Contents

---

Play Wireless Router .....	1
Product Requirements Document .....	1
The Belkin F7D4402 Play Wireless is a router/access point (AP), which operates on 2.4GHz and 5GHz frequencies, conforms to the IEEE 802.11a/b/g wireless standards and IEEE 802.11n specification. Reviewers .....	1
Modification History.....	2
Table of Contents .....	4
1. Introduction .....	5
2. Product Overview.....	5
2.1 Features .....	5
2.2 System Requirements .....	7
2.3 EZ Install Wizard System Requirements: .....	7
3. Router Hardware Specification.....	9
3.3.2 Front panel - Network Status Display / LED Indicators / WPS PBC .....	16
3.3.3 “Fix-it” (TBC) Button.....	錯誤! 尚未定義書籤。
3.4 System Reset.....	17
4. Performance Requirements .....	20
5. Router Firmware Features .....	23
5.1 Overview .....	23
6.2 Firmware User Interface (FW UI).....	24
6.3 Protocol Supported.....	58
6.4 ISP Protocol Supported Regions (TBC) .....	59
6.5 VPN Pass-thru Support .....	66
6.6 Firewall .....	錯誤! 尚未定義書籤。
6.7 Virtual Servers.....	錯誤! 尚未定義書籤。
7. Package Contents (TBC) .....	66
8. Regulatory Certifications / Compliance.....	67
9. Intended Markets .....	71
10. Sample Requirements .....	71
11. Appendix .....	72

## 1. Introduction

---

This document covers the functional description and specification of this project.

## 2. Product Overview

---

The Belkin F7D4402 Play Wireless is a modem-router/access point (AP), which operates on 2.4GHz and 5GHz frequencies, conforms to the IEEE 802.11a/b/g/n wireless standards. It allows sharing of broadband connections up to 16 computers via the WLAN and 4 computers via the 4-port Fast Ethernet (10/100Base-T) switch.

The Router's new Easy Start installation software operates on Microsoft's Windows XP, Vista, Win7 and on Mac OS X. The Router can be configured through a web-browser interface. The product is designed for the home and small office and will be available through major retailers and online retailers.

### 2.1 Features

- Router with ADSL2+ modem and wireless Access Point (AP)
- Enables sharing of broadband Internet connection
- Works with both PCs and Mac computers
  
- Wireless network operates on 2.4GHz and 5GHz frequency bands
- Conforms to IEEE 802.11a/b/g/n standards
- Wireless security supports WPA2/WPA-Personal (PSK) & WEP 64/128-bit Encryption
- 802.11e / WMM Quality of Service
- IGMPv2 support (rolling change to v3)
- Self-healing
- Wi-Fi Protected Setup (WPS)
- Single USB ports for storage, print sharing, and backup

<b>Name</b>	<b>Wireless Technology</b>	<b>Technology</b>	<b>Features</b>
Basic	N150	1x1 N	24/7 customer support
		10/100 switch	Easy Start (out of box features)
			Pre-set security
			Self Healing
Surf	N	2x2 N	24/7 customer support
		10/100 switch	Easy Start (out of box features)
			Pre-set security
			Self Healing
Share	N	2x2 N	Memory Safe
		10/100 switch	Print Genie (wireless printing)
		1 USB port	Guest Access
			all "Surf " features
Play	Dual Band	Dual band 2x2 N	Video Max (Dual radio)
		10/100 switch	Music Labeler
		1USB port	Music Mover (DLNA server)
			Daily DJ
			all "Surf and Share" features
Play MAX	Dual Band	Dual band 2x2 N	Music Labeler
		Gigabit switch	Music Mover (DLNA server)
		2 USB ports	Daily DJ
		High Power Radio	Video Max HD (Dual radio + GE)
			Torrent Genie
			BitBoost QoS
	all "Surf and Share" features		

- Connects four computer/devices through the LAN ports
- Supports 16 wireless users and total of 253 users via LAN/WLAN
- Built-in DHCP server
- Firewalls includes NAT and SPI
- MAC address filtering
- DDNS service support
  
- VPN pass-through
- Web-based password-protected advanced user interface
- Universal Plug and Play (UPnP)
- Auto Firmware Update Notification with Pop-Up Window
- Works with Easy Start Installation Wizard
  
- Wi-Fi Alliance Wi-Fi 11a/b/g/n logo
- Wi-Fi Alliance WMM and WPS logo

## 2.2 System Requirements

- Broadband Internet connection, RJ11 ADSL
- At least one PC with:
  - Installed network card
  - TCP/IP networking protocol installed
  - Internet Browser installed (IE Safari, Opera, Firefox)

## 2.3 New Belkin Easy Start Wizard and Tray App System Requirements:

- At least one PC with:
  - Installed network card
  - TCP/IP networking protocol installed
  - Windows XP SP2 or later, Vista, Win7 or Mac 10.4 and 10.5
  - CD-ROM drive
  - Minimum of 256MB RAM

## 2.4 Key Project Priorities

### 2.4.1 QoS for Best User Experience

- The QoS feature will automatically allocate bandwidth to applications that are latency sensitive, video, voice, gaming. This will ensure that users have a seamless online experience. Advanced users will also have the ability to manually change the settings to suit their specific needs.

### 2.4.2 USB Port for Storage, Printing and Back-up

- One of the key differentiators of this router is the USB port that allows users to access a connected storage device (FAT, FAT32, NTFS) on their home network.
- Mac 10.4, 10.5 and 10.6 users will be able to see the USB device appear automatically in the network section.
- Vista/Win7 users will also be able to see the device automatically from the network section.
- See latest version of the 'Local Backup'.pdf document for the specifications

### 2.4.3 DLNA/UPnP AV Server for Streaming Media

- The UPnP server will automatically broadcast its media serving capabilities to the rest of the network, devices such as PS3, Xbox, Windows Media player, etc will pick up this broadcast and allow users to access the UPnP server.
- The server will serve photos, videos, and music that are on the USB storage device connected to the router's USB port.
- Must be DLNA certified

## 2.5 USB Storage installation procedure and usage

- See Affinegy tray app and Silex specification document

## 2.6 Requirements for USB Use Cases

All users on the local network (wired and wireless) should see the attached USB storage device as a folder in their "My Computer" folder once the device is plugged into the USB port and the Silex control center software is installed. All users will have read and write access to all files on the storage device. The following are special cases that the firmware must handle:

**2.6.1** All users will be able to navigate to the storage device through [\\192.168.2.1](http://192.168.2.1)

**2.6.2** If the device plugged into the USB port is not a storage device or if file system of the storage device is unsupported (FAT, FAT32, or NTFS), the USB LED will stay off

- Card readers will be accessible if they are formatted to a supported file system

**2.6.3** Router will support up to a 4 to 1 externally-powered USB hub

- At least one device must be a supported storage device. All others will be ignored

**2.6.4** File attributes (such as permissions) are maintained when accessed through the router's USB port

**2.6.5** User experience must be OS-independent: XP, Vista, Win7 and MAC

**2.6.6** Under no circumstances will the user's storage device be formatted

**2.6.7** If the user installs the Silex control center utility from the CD, the storage device will be mapped to a drive letter on the user's My Computer folder in their PC or the Finder in their MAC

- The drive letter order will be in reverse alphabetical order to match the networked drive handling in Windows OS
- Multiple partitions/multiple drives via USB hub will be mounted to separate drive letters
- The volume name of the storage device must be displayed
- The icon should be customized
  - The icon to change when a drive is plugged into the router



- If a new drive is plugged into the port, the same drive letter can be reused but with a new volume name
- Multiple users must have simultaneous access to the storage device

### 2.6.8 Silex control center functionality

- See separate Silex specification

## 3. Router Hardware Specification

---

### 3.1 Main Board

- CPU:
  - Model:
  - Speed:
  - Package:
  - Max temperature (tC): (125°)
- DSL CPU:
  - Model: [Amazon SE](#)
  - Speed: TBC
  - Package: TBC
  - Max temperature: 0 °C to +70 °C
- Flash:
  - Size:
  - Type: (TSOP-48)
  - Speed: (90ns)
  - Max temperature: (125°)
- Memory:
  - Size:
  - Type:
  - Speed:
  - Max temperature: (125°)
- 10/100 Switch:
  - Model: **BCM5325**
  - Ports: 4 LAN + 1 WAN Fast Ethernet
  - Interface: RMI
  - Package: **400 FBGA**
  - Max temperature (125°)
  - Must layout out to be able to populate the BCM53101 as well
- ADSL:

- ANSI T1.412 Issue II
  - G.DMT (ITU 992.1)
  - G.Lite (ITU 992.2)
  - G.DMT.bis (ITU 992.3)
  - G.Lite.bis (ITU 992.4)
  - G.992.5
  - Modem must auto-negotiate to the highest supported rate
  - Annex M (Option will be added to interface but off by default)
  - Dying Gasp (IP1149) support
  - Ability to support TR-069 (footprint on PCB)
- PCB:
    - Layers: 4 layers
    - Material: FR4
    - Size: 152x172mmx1.6mm

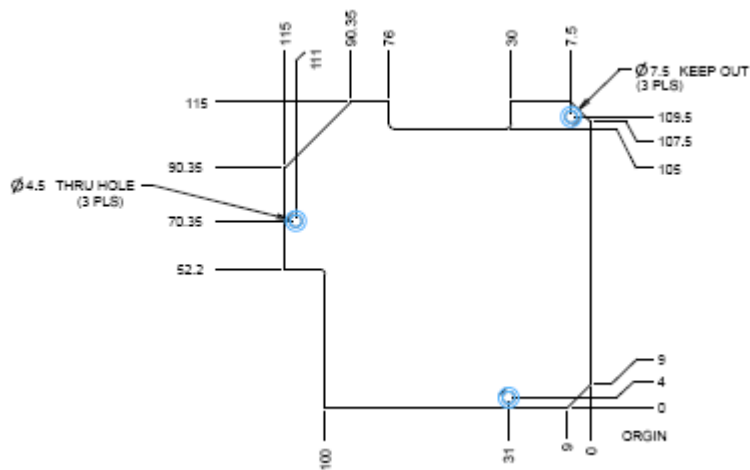

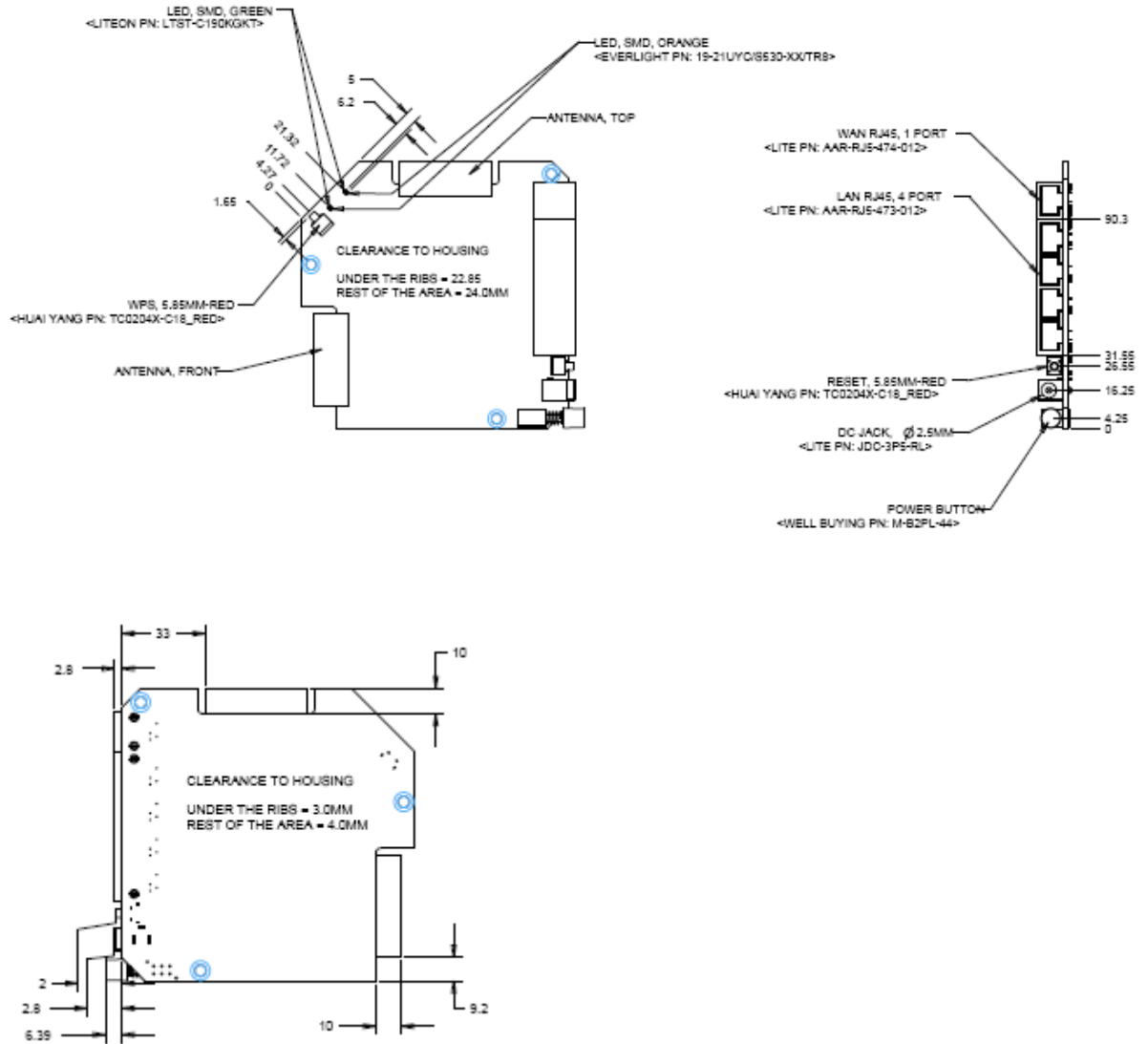

### 3.2 Wireless Radio

The Router is equipped with a dual IEEE 802.11x radio. The radio is onboard the PCB with a mPCI slot reserved for future upgrade.

- 2.4GHz Radio Specifications
  - Chipset:
    - MAC/BB: **Integrated to the BCM4718**
  - Memory:
    - Size: 8MB
  - RF Band
    - ISM Band 2.4GHz
  - Modulation
    - 802.11n

- OFDM (BPSK, QPSK, 16- and 64- QAM)
  - 802.11g
    - OFDM (BPSK, QPSK, 16- and 64- QAM)
  - 802.11b
    - CCK (11, 5.5 Mbps)
    - DQPSK (2 Mbps)
    - DBPSK (1 Mbps)
  - Data Rates
    - 802.11n
      - 40MHz: 300, 270, 243/240, 216, 180/162, 120/108 Mbps
      - 20MHz: 145, 130, 117, 104, 87 Mbps
    - 802.11g
      - 54, 48, 36, 24, 18, 12, 9, 6 Mbps
    - 802.11b
      - 11, 5.5, 2, 1 Mbps
  - Power Output
    - 802.11n draft
      - 12.5 +/- 2dBm
    - 802.11g
      - 13.5 +/- 2dBm
    - 802.11b
      - 15 +/- 2dBm
  - Antenna Connectors:
    - Antenna solder to the PCB; no connectors.
- 5GHz Radio Specifications
  - Chipset:
    - MAC/BB: BCM43224
  - Memory:
    - Size: N/A
  - RF Band
    - UNII-1 (5150~5250MHz) UNII-3 (5725~5825MHz)
  - Modulation
    - 802.11n
      - OFDM (BPSK, QPSK, 16- and 64- QAM)
    - 802.11a
      - OFDM (BPSK, QPSK, 16- and 64- QAM)
  - Data Rates
    - 802.11n
      - 40MHz: 300, 270, 243/240, 216, 180/162, 120/108 Mbps

modulation coding scheme (MCS) rates						
MCS index	Modulation	Spatial Streams	802.11n Data Rate			
			20MHz		40MHz	
			L-GI	S-GI	L-GI	S-GI
0	BPSK	1	6.5	7.2	13.5	15
1	QPSK	1	13	14.4	27	30
2	QPSK	1	19.5	21.7	40.5	45
3	16-QAM	1	26	28.9	54	60
4	16-QAM	1	39	43.3	81	90
5	64-QAM	1	52	57.8	108	120
6	64-QAM	1	58.5	65	121.5	135
7	64-QAM	1	65	72.2	135	150
8	BPSK	2	13	14.4	27	30
9	QPSK	2	26	28.9	54	60
10	QPSK	2	39	43.3	81	90
11	16-QAM	2	52	57.8	108	120
12	16-QAM	2	78	86.7	162	180
13	64-QAM	2	104	115.6	216	240
14	64-QAM	2	117	130	243	270
15	64-QAM	2	130	144.4	270	300

- 20MHz: 145, 130, 117, 104, 87 Mbps
  - 802.11a
    - 54, 48, 36, 24, 18, 12, 9, 6 Mbps
- Power Output[johnki1]
  - 802.11n
    - 11 +/- 2.5dBm

High power mode

Output Power Limits for 5GHz operation	
Common Name	Channel Characteristics
USA	36-48 @ power of 50mW (17dBm) peak conducted 149-165 @ power of 1000mW (30dBm) peak conducted
Canada, Panama & Mexico	36-48 @ power of 200mW (23dBm) EIRP 149-165 @ power of 1000mW (30dBm) peak conducted.
Europe	36-48 @ power of 200mW (23dBm) EIRP

APAC	36-48 @ power of 200mW (23dBm) EIRP 149-165 @ power of 1000mW (30dBm) EIRP
Brazil	36-48 @ power of 200mW (23dBm) EIRP 52-64 @ power of 200mW (23dBm) EIRP 100-140 @ power of 250mW (24dBm) EIRP 149-165 @ power of 1000mW (30dBm) EIRP
Peru	36-48 @ power of 100mW (20dBm) EIRP 149-165 @ power of 100mW (20dBm) EIRP
Chile	36-48 @ power of 100mW (20dBm) EIRP 52-64 @ power of 100mW (20dBm) EIRP 149-165 @ power of 100mW (20dBm) EIRP

- Antenna Connectors:
  - Antenna solder to the PCB; 2 piece antenna connector for 5GHz radio
- Antenna:
  - Two internal, 2.4/5GHz dual feed/dual-band PIFA antennas.
  - 2dBi (or better) excluding cable loss (TBD)
  - 1W admitted power (TBC)
  - Antenna Pattern: **omni-directional**
  - Material: (TBC)
  - Dimension:
    - Width: 0.8mm (TBC)
    - Height: 10mm (TBC)
    - Depth: 55mm (TBC)
  - Cable length: TBD

### 3.3 Enclosure

The large Router Enclosure is designed to be placed on a desk vertically. All the cables exit from the rear of the Router for better organization and utilization.

- Material and Colors
  - Front cover: Refer to latest version of IDG's CMF document
  - Back cover: Refer to latest version of IDG's CMF document  
[Note: material subject to change to PC+ABS pending temperature test]
  - Rubber feet: 2 pieces

- Screws:
  - PCB: 4 screws
  - Enclosure: 2 screws
- Push button #1 for WPS:
- LED label: Refer to latest version of IDG's CMF document
- ID label: Refer to latest version of IDG's CMF document
  
- Dimensions
  - Width: 155mm (TBC, needs to be the large enclosure)
  - Height: 215mm
  - Depth: 34mm (90mm w/ base)
  - Weight: 14.8 oz

[johnki2]

### 3.3.1 Rear Panel

#### **\*Note: Power is 12V2A (TBC)**

- ADSL line port (WAN) :
  - Spec: 1x RJ-11 for Annex A
  - Material: PA46
  - Color: Cool Gray 3U matte
  - Flame class: V-0
  
- to Wired Computers ports (LAN):
  - Spec: 4 x RJ-45, 10/100/1000 auto sensing
  - Material: (TBC)
  - Color: Yellow 114C
  - Temperature: (TBC)
  
- 1 x USB (white):
  - Power Spec:
    - Power pin must withstand 5V and 1A (in to the router)
    - All other pins only need to be protected for ESD
  - Support for FAT, FAT32 and NTFS file systems
  - Maximum supported USB drive size:
    - 1TB
  - Maximum steady-state current output
    - 500mA
  - Maximum peak current output
    - 1000mA at maximum 100mA/us slew rate
  - LED
    - See 'Back panel LEDs 2009 05 28.pdf' for spec

- Power jack:
  - Spec: 1x DC Input Jack
  - Plug size: Match PSU plug in section 3.5
  - Material: (TBC)
  - Color: Black
  - Temperature:
- Placement and Dimensions
  - See enclosure ME drawing (TBD)
- Reset button:
  - Spec: 1x Reset Button
  - Color: red
  - The Reset button is located on the side panel
  - See Reset section for operation details.
- Power switch:
  - Place holder for EMEA

### 3.3.2 Front panel - Network Status Display / LED Indicators / WPS PBC

The Router is designed to be placed on a desktop. All of the cables exit from the rear of the Router for better organization and utility. The innovative “Network Status” LED indicators are easily visible on the front panel of the Router to provide you with information about network status.

- Boot up time is less than 1 minute.(Not including ADSL Sync)

State	Big LED	Small LED
<b>Normal operation</b>		
Starting up	Blinking green	Off
On (no WPS)	Solid green	Off
<b>Trouble</b>		
No internet connection	Solid amber	N/A
No connection to modem	Blinking amber	N/A
WPS/client security failure	N/A	Solid amber
<b>Setup</b>		



Starting up	Blinking green	Off
No connection to modem	Blinking amber	Off
No internet connection	Solid amber	Off
OK, establishing WPS	Solid green	Blinking green
OK, WPS established	Solid green	Solid green

**Situation normal**



Starting up

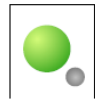

Working (no WPS)

**Trouble**

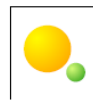

No Internet (ISP)



Can't see modem

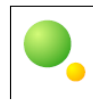

WPS/client security failure

**During setup**



Starting up



Can't see modem

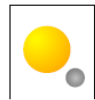

No Internet yet



OK, establishing WPS

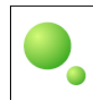

Everything OK, WPS established

[johnki3]

- WPS button:
  - Spec: 1x push button
  - Material: Refer to latest version of IDG's CMF document
  - Color: Refer to latest version of IDG's CMF document
  - The WPS push button located on the front cover is for user to set up wireless security via WPS.
  - See WPS section for operation details.

**3.4 System Reset**

- Via recessed reset button
- Reboot router: Push and release (1 second)
- Restore default settings: Push and hold 10 seconds

Router LED and GUI could take up to 1 minute to display the correct status of the feature. This also includes the web page update time required after a soft reboot. Soft reboots will be required for any config changes that need it, resets and restore to factory defaults.

### 3.5 Power Supply

- Type: External, AC/DC, Switching (must meet Energy Star)
- Label: Belkin Branded (if available, not a requirement)
- Output plug type / size: F)  $\Phi 5.5\text{mm} \pm 0.1\text{mm}$  X (G)  $\Phi 2.5\text{mm} \pm 0.1\text{mm}$  X (H)  $9.5\text{mm} \pm 0.5\text{mm}$  [L]

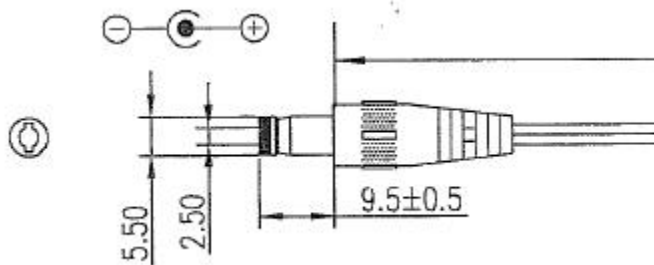

- US  
Model: (TBD)  
Input: 120V 60Hz 0.3A  
Output: 12V 2A  
(must meet Energy Star level V standard)\*\*\*
- UK/AK  
Model: (TBD)  
Input: 240V 50Hz 0.3A  
Output: 12V 2A  
(must meet Energy Star level V standard)\*\*\*  
(Must have PSB logo)
- EU  
Model: (TBD)  
Input: 240V 50Hz 0.3A  
Output: 12V 2A  
(must meet Energy Star level V standard)\*\*\*
- AU  
Model: (TBD)  
Input: 240V 50Hz 0.3A  
Output: 12V 2A

PSU should be MEPS compliant. info on MEPS  
<http://www.energyrating.gov.au/library/pubs/2008-factsheet-eps.pdf>

- APAC                      Model: (TBC)  
                                  Input: (TBC)  
                                  Output: 12V 2A
  
- Dimension:              no larger than 80 x 50 x 50mm (L x W x H) (TBC)
- Weight:                    less than 1.0 lb (TBC)

### 3.6 Environment Conditions

- Temperature:            Operating: 0~ 40C (32 ~ 131 F)  
                                  Storing: 20 ~ 65 C (-13 ~ 155 F)
  
- Humidity:                Operating – 10 ~ 85% non-condensing  
                                  Storing – 5 ~ 95% non-condensing

[Note: ODM to provide test report for Belkin approval]

### 3.7 Drop and Vibration Test

- Must pass Belkin drop and vibration tests (TBC)

[Note: ODM to provide test report for Belkin approval]

### 3.8 MTBF Test

- Minimum 5 years of MTBF (TBC)

[Note: ODM to provide test report for Belkin approval]

### 3.9 Power Consumption

Condition	Typical (mA)	Maximum (mA)
Standby: Router powered on and ready. No wired or wireless clients connected	TBC	TBC
Operating: 4 wired clients and 1 wireless N client connected and transmitting data	TBC	TBC
ECO standby:	TBC	TBC

\* Must meet EU CoC requirements

### 3.10 Standards Supported

- LAN: IEEE802.3 / 802.3u 10/100Base-TX, auto negotiation, auto MDIX
- ADSL: ANSI T1.412 Issue II,  
G.DMT (ITU 992.1), G.Lite (ITU 992.2),  
G.DMT.bis (ITU 992.3), G.Lite.bis (ITU 992.4),  
G.992.5.  
Modem must auto-negotiate to the highest supported rate,  
Annex M (Option will be added to interface but off by default)

## 4. Performance Requirements

---

### 4.1 Throughput

- Test in a cage or clean environment.
- Test run with Chariot console running on wired PC

#### 3.3.1.1 Routing Speed

- WAN to LAN Throughput via Broadband Internet Service
  - Range: 0-24Mbps
  - Typical: 22Mbps (TCP duplex)
  - Minimum Acceptance: 18Mbps (TCP duplex)

#### 3.3.1.2 Wired Speed

- LAN to LAN Throughput
  - Range: 0-660Mbps
  - Typical: 640Mbps (TCP duplex)
  - Minimum Acceptance: 620Mbps (TCP duplex)

#### 3.3.1.3 Wireless Speed

- WLAN to LAN Throughput – 2.4/5GHz Radio

Target typical / Average minimum throughput (Mbps) with Chariot TCP 1 pair

Bandwidth / Security Mode	20/40MHz Auto	20MHz Only	% change for UDP	With Protected Mode turned ON
Open	95 / 65	65 / 55	Equals to or better than TCP	85 / 55
WEP	N/A	20 / 18	Equals to or better than TCP	20 / 18

WPA-TKIP	N/A	20 / 18	Equals to or better than TCP	20 / 18
WPA2-AES	85 / 55	60 / 50	Equals to or better than TCP	75 / 50

Target typical / Average minimum throughput (Mbps) w/ Chariot TCP 2 pair (1Up+1Dn)

Bandwidth / Security Mode	20/40MHz Auto	20MHz Only	% change for UDP	With Protected Mode turned ON
Open	120 / 80	90 / 60	Equals to or better than TCP	110 / 70
WEP	N/A	20 / 18	Equals to or better than TCP	20 / 18
WPA-TKIP	N/A	20 / 18	Equals to or better than TCP	20 / 18
WPA2-AES	110 / 70	80 / 50	Equals to or better than TCP	100 / 60

### 3.3.2 Wireless Range

#### 3.3.2.1 Distance – 2.4GHz Radio

- Indoor Range / Typical: 0-250ft / 200ft (TBC)
- Outdoor Range / Typical: 0-600ft / 450ft (TBC)

#### 3.3.2.2 Distance – 5GHz Radio

- Indoor Range / Typical: 0-250ft / 200ft (TBC)
- Outdoor Range / Typical: 0-600ft / 450ft (TBC)

### 3.3.3 Interoperability for Radio

Router must be fully interoperable with other draft-n compliant chipsets with or without encryption.

Test in a clean environment using Chariot running high performance script

#### ➤ Throughput – 2.4/5GHz Radio

Target typical / Average minimum throughput (Mbps) with Chariot TCP 1 pair

Bandwidth / Security Mode	20/40MHz Auto	20MHz Only	% change for UDP	With Protected Mode turned ON
Open	85 / 50	60/50	Equals to or better than TCP	50 / 40
WEP	N/A	20/18	Equals to or better than TCP	17 / 13
WPA-TKIP	N/A	20/18	Equals to or	17 / 13

			better than TCP	
WPA2-AES	75 / 40	55/45	Equals to or better than TCP	50 / 40

**Target typical / Average minimum throughput (Mbps) w/ Chariot TCP 2 pair (1Up+1Dn)**

Bandwidth / Security Mode	20/40MHz Auto	20MHz Only	% change for UDP	With Protected Mode turned ON
Open	90 / 60	65/55	Equals to or better than TCP	60 / 50
WEP	N/A	20/18	Equals to or better than TCP	20 / 18
WPA-TKIP	N/A	20/18	Equals to or better than TCP	20 / 18
WPA2-AES	80 / 45	60/50	Equals to or better than TCP	60 / 50

- Client Cards to be tested (minimum 1 card per product SKU)
  - Must test
    - Belkin Basic/Surf/Play USB Client Card, version 1000
    - Belkin N+/N/N150/G Client Cards, latest version
  - Desirable Competitor clients
    - Linksys (TBC)
    - D-Link (TBC)
    - Netgear (TBC)
- Laptops with built-in 11n radio to be tested
  - Intel Centrino PC
    - IBM
    - Dell
  - Computer with Broadcom chipset
    - Dell
    - HP
    - Apple Macbook
  - Computer with Atheros chipset
    - Apple Macbook Pro

#### 4.4 Endurance

- Wireless Endurance
  - wireless must be able to run and stay connected over time
- Router Endurance
  - firewall must remain functional over time

- router must not drop WAN connection (unless caused by ISP)
- router must not lock up or lost access to FW GUI
- Duration
  - minimum 24 hours for basic data traffic
  - see Belkin Router Test Plan for more detail

## 4.5 USB throughput

All units are in megabits per second (Mbps) (TBC)

File system	Read/Write throughput (no wireless clients)	Read/Write throughput (wireless Chariot test in background)	Read/Write throughput (Wireless client to/from USB storage)
FAT / FAT32	30/50	20/10	15/10
NTFS	30/10	20/10	15/10

## 5. Router Firmware Features

---

### 5.1 Overview

The Router firmware must be designed to fit in the limited flash memory and run efficiently with the available system memory specified in Section 3.1. Code base should be minimized for space efficiency while without reduce performance and/or decrease usability.

- Operating system: Linux
- GPL source code and binary code required for posting (if using open source OS)
- Web-based advanced management (FW UI) configurable from client browsers
  - <http://router/> should redirect page to the router's default IP address
- Password protected user interface
- User upgradeable firmware via FW UI
- User selectable firmware updates notification
- Display progress bar when updating settings
- Limit the number of reboot require and shorten reboot time when setting up the router for best user experience
- Error checking for user input parameter with warning/confirmation messages
- FW UI with multiple language support. Asian languages displayed with "graphic text" on the Home/Status page
- Meets WFA Wifi Protected Setup (WPS) certification

- Compliant to latest version of the WFA WPS specification (v1.0h or later)
- Refer to latest version of the Belkin WPS Requirements Document (v0.01 or later) for implementation details
- Many allowable characters and field lengths are defined in 'ascii table v2.00.doc' The ascii table document takes precedence over any values in this PRD

## 6.2 Firmware User Interface (FW UI)

The firmware features an easy to read user interface. The FW UI is composed of three sections: top banner, left-pane menu, and center. Default setting is listed in ( xxx ). Please match F5D8233-4v3000 FW UI.

### 6.2.1 Top Banner

The banner is a horizontal bar located at the top of the firmware GUI. It contains the following items:

- Belkin Logo – Registered mark to stay in same ratio to “BELKIN”

**BELKIN®**

- Link to [www.belkin.com](http://www.belkin.com)
- Router Setup
  - Link to “www.belkin.com”
- Home
  - Link to Homepage
- Help
  - Opens help contents in new window
- Logout / Login
  - Changes to “Logout” after user has login with password
  - Changes to “Login” after user has logout or timed out
- Internet Status
  - Changes to “Connected” (in Blue) when Router has Internet access
  - Changes to “Not Connected”(in Red) when Router does not have Internet access
  - New Internet Check Algorithm v1.9 or later. Chart for reference only



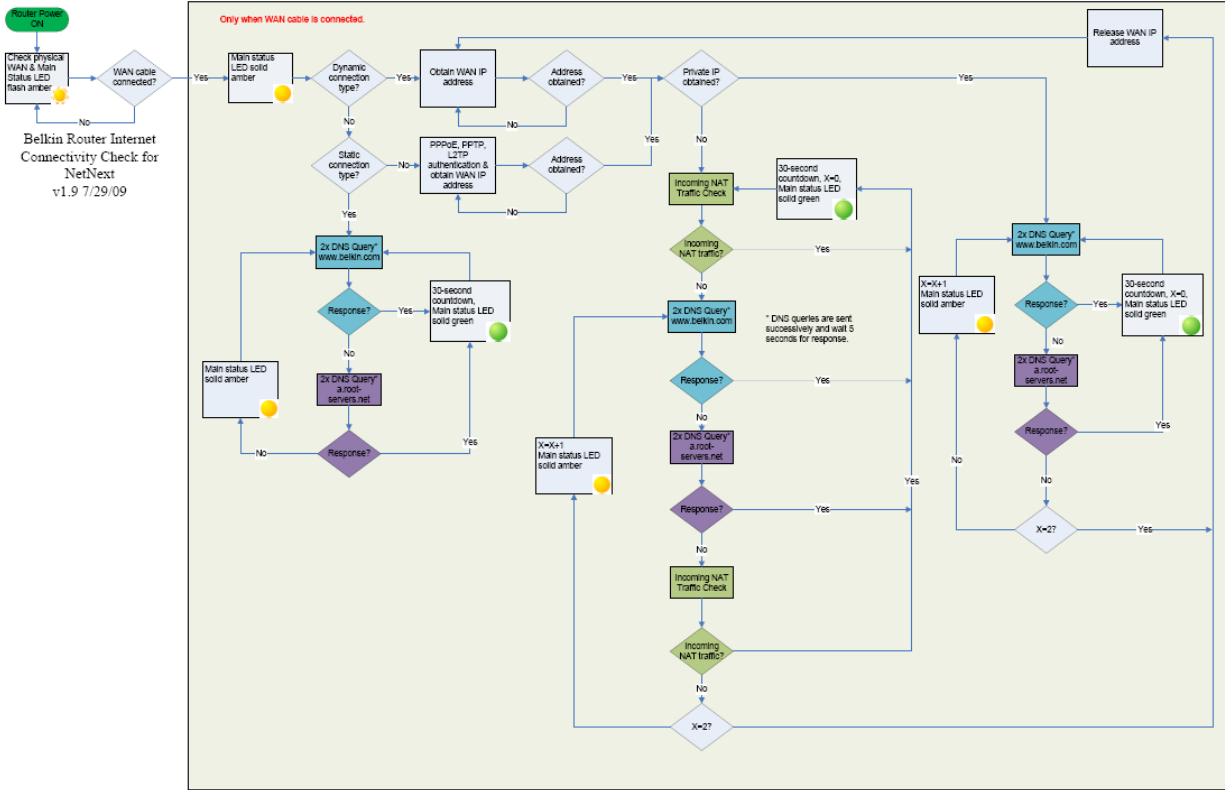

- Self-healing
  - Default: enable
  - Day: Tuesday
  - At Time: 3:30 AM

## Health > Regular Maintenance

**Automatically initialize  
my router weekly**

 ON

**On day(s)**

- Monday
- Tuesday
- Wednesday
- Thursday
- Friday
- Saturday
- Saturday

**At time**

Save

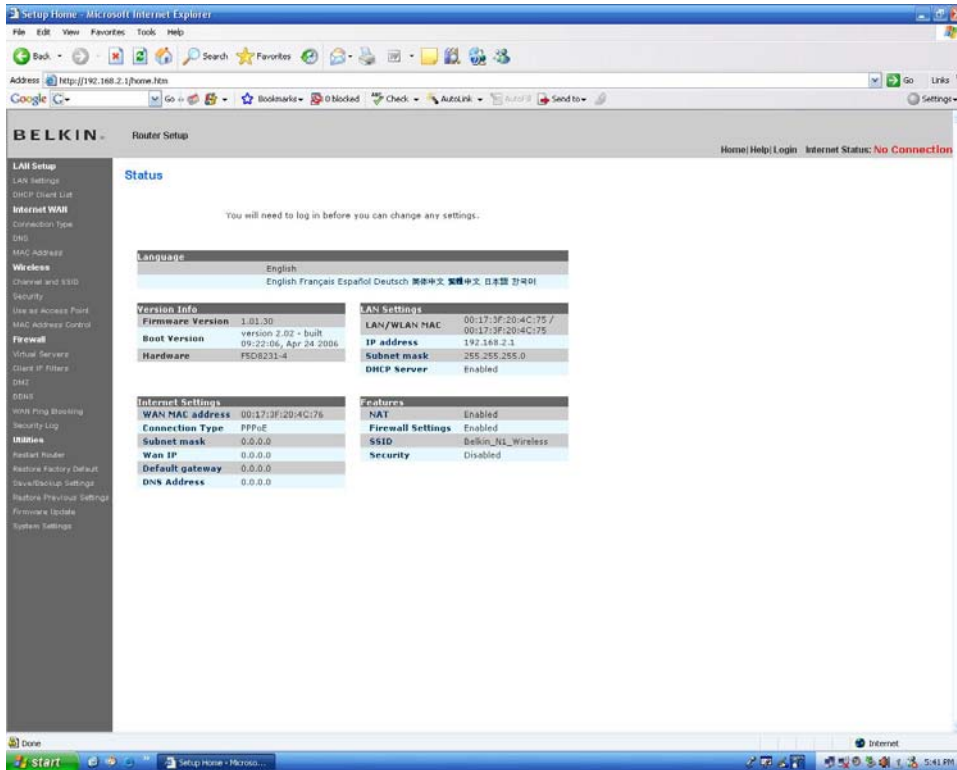

(For reference only)

### 6.2.2 Navigation Menu

The navigation menu is a vertical frame at the left of the firmware GUI. It consists of the following selections:

- LAN Setup
  - LAN Settings
  - DHCP Client List
  - Static Routing
- Internet WAN
  - Connection Type
  - DNS
  - Mac Address Cloning
- Wireless
  - Channel and SSID
  - Security
  - WiFi Protected Setup
  - Guest Access
  - Use as an Access Point
- BitTorrent
- QoS

- QoS Profiles
- Traffic statistics
- UPnP Media Server
  
- Firewall
  - Virtual Servers
  - MAC Address Filtering
  - Access Control
  - DMZ
  - DDNS
  - WAN Ping Blocking
  - Security Log
  
- Utilities
  - Restart Router
  - Restore Factory Default
  - Save/Backup Settings
  - Restore Previous Settings
  - Firmware Update
  - System Settings
  - Self Healing

### 6.2.3 Status Page = *Home page*

Status page shows the following items. Each item contains a direct link to individual feature page

- ◆ Language selection
  - List current default language (Default is English if not defined for the SKU version)

Countries – All

Languages – English, French, German, Dutch, Spanish and Italian.

- When user clicks on a new language, the language will change even if the user is not logged in.
- The language change is permanent until a factory default is performed either via FW GUI or the reset button, or the user selects another language in the GUI.

- ◆ Version info
  - Hardware (F7D4402 v1)
    - [Note: Okay to include ODM HW/PCB version after v3]
  - Firmware (1.xx.xx in Belkin standard format)

- Boot Loader (X.XX in ODM format)
- Serial number (per Belkin serial numbering rule)
- LAN settings
  - LAN/WLAN MAC address
  - IP address (default equals 192.168.2.1)
  - Subnet mask (default equals 255.255.255.0)
  - DHCP server (default equals enabled)
    - Number of wired/wireless client connected
- Internet settings
  - WAN MAC address
  - Connection type (default various by country) – Refer to the latest version of “Belkin\_SKU\_Default\_Settings\_1\_20\_20090216.xls”
  - WAN IP address
  - Subnet mask
  - Default gateway
  - DNS address
- Features
  - Firewall Settings (default equals Enabled)
  - SSID (Show current SSID)
  - Security (display current security setting, ie WPA-personal (PSK), etc)
  - UPnP (default equals Enabled)
  - Remote management (default equals disabled)
  - WPS (default equals enabled)
  - Guest Access (Enabled/Disabled)
    - SSID
    - Password/PSK

### 6.2.3 LAN Settings

#### LAN Settings

- IP address (default equals 192.168.2.1, allow non-routable IP only)
  - 1<sup>st</sup> octet: 10, 172, 192
  - 2<sup>nd</sup> octet:
    - if 1<sup>st</sup> octet = 10 then 0-255
    - if 1<sup>st</sup> octet = 172 then 16-31
    - if 1<sup>st</sup> octet = 192 then 168
  - 3<sup>rd</sup> octet:
    - if 1<sup>st</sup> octet = 10 then 0-255
    - if 1<sup>st</sup> octet = 172 then 0-255
    - if 1<sup>st</sup> octet = 192 then 0-255
  - 4<sup>th</sup> octet:
    - if 1<sup>st</sup> octet = 10 then 1-254

if 1<sup>st</sup> octet = 172 then 1-254  
if 1<sup>st</sup> octet = 192 then 1-254

- Subnet mask (default equals 255.255.255.0)
  - If LAN IP first octet = 10 then default equals 255.0.0.0
  - If LAN IP first octet = 172 then default equals 255.255.0.0
  - If LAN IP first octet = 192 then default equals 255.255.255.0
    - 1<sup>st</sup> octet: 255
    - 2<sup>nd</sup> octet: 0, 128, 192, 224, 240, 248, 252, 254, 255
    - 3<sup>rd</sup> octet: 0, 128, 192, 224, 240, 248, 252, 254, 255
    - 4<sup>th</sup> octet: 0, 128, 192, 224, 240, 248, 252
  
- DHCP server (default equals On)
  - IP Pool Starting Address (default is 2, 1-254 range)
  - IP Pool Ending Address (default is 100, 1-254 range)
  - All IP Addresses assigned in same Router subnet
  
- Lease time (default equals Forever – DHCP will reserve the IP indefinitely for each PC)
  - Available options: half hour/1 hour/2 hours/half day/one day/two days/one week/two weeks/forever
  - If router runs out of leases: will clean DHCP list that are not online currently.
  
- Local domain name (default equals “Belkin”, max. 60 characters, no special characters allowed except space)

#### **DHCP client list**

- Shows IP address, Host name and MAC address of DHCP clients.
  - Refresh button to refresh the list.
  - Displays DHCP client list that are currently online only.
- Static Routing
    - Network address
      - To define the local IP address or range
        - 1<sup>st</sup> octet: 1-254
        - 2<sup>nd</sup> octet: 0-255
        - 3<sup>rd</sup> octet: 0-255
        - 4<sup>th</sup> octet: 0-254
    - Subnet Mask
      - To define the subnet mask of the Network Address defined above

- 1<sup>st</sup> octet: 255
- 2<sup>nd</sup> octet: 0, 128, 192, 224, 240, 248, 252, 254, 255
- 3<sup>rd</sup> octet: 0, 128, 192, 224, 240, 248, 252, 254, 255
- 4<sup>th</sup> octet: 0, 128, 192, 224, 240, 248, 252, 254, 255
- Gateway
  - Gateway for the static route
    - 1<sup>st</sup> octet: 1-254
    - 2<sup>nd</sup> octet: 0-255
    - 3<sup>rd</sup> octet: 0-255
    - 4<sup>th</sup> octet: 1-254
- Add & Remove buttons
- To add or remove the route
- Clear and Apply Buttons at the bottom (Changes to the routes are temporary and not saved until Apply it click or removed if clear is clicked (The ones done during that session))
- Error message
  - “The address you entered is invalid”

### Static Route Parameter

Please Enter the Following Configuration Parameters:

Network Address	Subnet Mask	Geteway	
192.168.3.100	255.255.255.0	192.168.3.1	<input type="button" value="Remove"/>
<input type="text"/>	<input type="text"/>	<input type="text"/>	<input type="button" value="Add"/>

#### 6.2.4 Internet WAN

- Connection type (see ISP Protocol below)
  - For all connection types – refer to the 6.4 Protocol Supported Regions)
  - For regional default connection types – Refer to the latest version of “Belkin\_SKU\_Default\_Settings\_1 20\_20090216.xls”
- DNS address
  - primary and secondary (auto from ISP)
    - 1<sup>st</sup> octet: 1-223
    - 2<sup>nd</sup> octet: 0-255

- 3<sup>rd</sup> octet: 0-255
  - 4<sup>th</sup> octet: 1-254
- MAC address Cloning
    - List router's MAC address(Router's WAN Mac address, no list of default settings)
    - Clone computer's MAC address – clones the computer in use
      - 1) Manually enter Mac address or clone the Mac address of the client NIC's MAC address which is currently connected on.
      - 2) Restore to factory default settings
        - Type the default WAN MAC address by manually (user can refer to the ID label on the bottom of router for WAN MAC address info.)
        - Needs to restore the factory default settings.

**6.2.5 Wireless Channel and SSID**

2.4GHz radio

- Primary channel: 1-11 or 1-13 (default equals "6" )
- Extension Channel (20/40MHz auto mode)

US Channels	
Pimary 20MHz Channel	Extension 40MHz Channel
1	5
2	6
3	7
4	8
5	1 or 9
6	2 or 10
7	3 or 11
8	4
9	5
10	6
11	7

Europe Channels	
Pimary 20MHz Channel	Extension 40MHz Channel
1	5
2	6



3	7
4	8
5	1 or 9
6	2 or 10
7	3 or 11
8	4 or 12
9	5 or 13
10	6
11	7
12	8
13	9

• SSID

- Default: See SSID\_ID\_decoder\_11\_04\_09.pdf where XXX is the last three characters of WLAN MAC (max. characters: 32)

**7.3.2.1 SSID element**

The SSID element indicates the identity of an ESS or IBSS. See Figure 7-38.

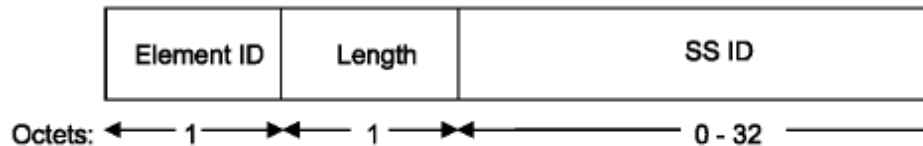

**Figure 7-38—SSID element format**

The length of the SSID information field is between 0 and 32 octets. A 0 length information field is used within Probe Request management frames to indicate the wildcard SSID.

[From IEEE 802.11 specification, 2007]

- Wireless Mode

- 1) OFF
- 2) 802.11g
- 3) 802.11n
- 4) 802.11b & 802.11g & 802.11n (=Default setting)

- Bandwidth

- 1) 20MHz (=Default setting)
- 2) 20/40MHz Auto

Region	Available Bandwidth	Default Bandwidth
NCSA	20MHz Only and 20/40MHz Auto	20MHz
EMEA	20MHz Only and	20MHz

	20/40MHz Auto	
ANZ	20MHz Only and 20/40MHz Auto	20MHz
APAC	20MHz Only and 20/40MHz Auto	20MHz

- Broadcast SSID  
Default: Checked
- Protected Mode  
Default: Off
- QoS (802.11e/WMM)  
Default: ON  
Note: Refer to spec “WMM\_Specification\_1-1.pdf”  
No tests required, just need certification.

5GHz radio

- A. Channel and SSID
  - Wireless Channel
    - Default: Auto

**5GHz**

<b>Output Power Limits for 5GHz operation</b>	
<b>Common Name</b>	<b>Channel Characteristics</b>
USA	36-48 @ power of 50mW (17dBm) peak conducted 149-165 @ power of 1000mW (30dBm) peak conducted
Canada, Panama & Mexico	36-48 @ power of 200mW (23dBm) EIRP 149-165 @ power of 1000mW (30dBm) peak conducted.

Europe	36-48 @ power of 200mW (23dBm) EIRP
Australia, Brunei, Singapore, India, Egypt, Vietnam, Malaysia	36-48 @ power of 200mW (23dBm) EIRP 52-64 @ power of 200mW (23dBm) EIRP 149-165 @ power of 1000mW (30dBm) EIRP
Australia with new band	36-48 @ power of 200mW (23dBm) EIRP 52-64 @ power of 200mW (23dBm) EIRP 100-116 @ power of 1000mW (30dBm) EIRP 132-140 @ power of 1000mW (30dBm) EIRP 149-165 @ power of 1000mW (30dBm) EIRP
Brazil Sri Lanka Philippines New Zealand Thailand	36-48 @ power of 200mW (23dBm) EIRP 52-64 @ power of 200mW (23dBm) EIRP 100-140 @ power of 250mW (24dBm) EIRP 149-165 @ power of 1000mW (30dBm) EIRP
Taiwan	56-64 @ power of 200mW (24dBm) peak conducted 149-165 @ power of 1000mW (30dBm) peak conducted.
Peru	36-48 @ power of 100mW (20dBm) EIRP 149-165 @ power of 100mW (20dBm) EIRP
Chile	36-48 @ power of 100mW (20dBm) EIRP 52-64 @ power of 100mW (20dBm) EIRP 149-165 @ power of 100mW (20dBm) EIRP
Maldives	36-48 @ power of 200mW (23dBm) EIRP 52-64 @ power of 200mW (23dBm) EIRP 149-165 @ power of 100mW (20dBm) EIRP
Japan	34, 38, 42, 46 @ power of 200mW (23dBm) EIRP 36-48 @ power of 200mW (23dBm) EIRP 52-64 @ power of 200mW (23dBm) EIRP 100-140 @ power of 1000mW (30dBm) EIRP
Korea	34, 38, 42, 46 @ power of 2.5mW/MHz EIRP 36-48 @ power of 2.5mW/MHz EIRP 52-64 @ power of 10mW/MHz EIRP 100-124 @ power of 10mW/MHz EIRP 149-161 @ power of 10mW/MHz EIRP

- SSID

- Default: Belkin.9XXX\_5GHz where =XXX corresponds to the appropriate four characters of 2.4GHz Radio MAC (max. characters: 32)
- Default: See SSID\_ID\_decoder\_11\_04\_09.pdf where XXX is the last three characters of WLAN MAC (max. characters: 32)
  - Only alphanumeric characters allowed (+ and \_ also allowed)
    - Wireless Mode
      - Default: 802.11a&802.11n
      - Option: 802.11a only, 802.11n only, 802.11a&802.11n, Off
    - Wireless Bandwidth
      - Default 20MHz
      - Option: 20/40MHz auto (extension channel should be 4 up or down from the main channel)
    - Broadcast SSID
      - Default: Checked
    - Protected Mode
      - Default: Off
      - Option: On
    - WMM (QoS) Parameters
      - Default enabled
      - Option: Disabled
      - Refer to the WiFi WMM spec version 1.1
- Wireless Security (Identical pages for 2.4GHz and 5GHz radios. Security is enabled by default)
  - Disabled
  - WPA/WPA2 - Personal (PSK) (Default)
    - Authentication / Encryption options:
      - WPA-PSK / TKIP (not supported when mode contains 802.11n)
      - WPA2 –PSK / AES
      - WPA-PSK+WPA2-PSK / TKIP+AES
      - WPA Default – WPA-PSK+WPA2-PSK/TKIP+AES
    - Mix mode is backward compatible with WPA-TKIP
    - 8 to 63 characters ASCII (including spaces and symbols) or 64 characters Hex
    - PSK to be randomly generated (not repeatable)
    - Obscure PSK – to hide PSK keys (default equals Checked)
  - 128-bit WEP
    - 13 hex digit pairs with optional Pass Phase
  - 64-bit WEP

- 5 hex digit pairs with optional Pass Phase
- WiFi Protected Setup (default is Enabled)
  - Personal Information Number (PIN) Method
    - Accepts client device PIN to enroll a client device
    - Generate new PIN for the Router
    - Restore default PIN for the Router
    - No 4 digit PIN support. Only 8 digit PIN support.
  - Push Button Configuration (PBC) Method
    - Start PBC with a client device or an external registrar.
  - Manual Configuration Method
    - Display current wireless security configuration
- Guest Access (2.4GHz radio only)
  - Guest Access allows access to the Internet thru the WAN port, but limits guests from accessing the internal network, LAN and WLAN.
  - Clients on the guest access SSID will NOT be isolated from each other
  - Guest Access clients may have access to the USB drive
  - See guest access 2009 07 29.pdf for detailed specification
- Use as an Access Point (default is disabled)
  - default Access Point IP address is 192.168.2.254
  - allow user to configure router IP address in AP mode (refer to 6.2.3 for non-routable IP address ranges)
  - warn user about new router IP address in AP mode
  - Disables NAT and DHCP server
  - WAN port will act as LAN port (5 LAN ports in total)
  - Internet Status as always ON regardless (Green LED and Tray APP)

## 6.6 QoS

- QoS Profiles (See screenshot below)
  - Enable or disable QoS module function
    - Default: Enable
  - Profile
    - Auto
    - User defined 1
    - User defined 2
    - Default: Auto
  - Bandwidth Management

- Auto
- User defined 1
- User defined 2
- Default: Auto

**QoS > QoS Profiles**

Enable or disable QoS module function >  Enable  Disable

Profile > User Defined 1

---

Bandwidth Management > User Defined 1 Edit

Classify Rules >

Name	Priority	Information	Action
Voice Device	Highest	---	
Online Games	High	<span>View Details</span>	
Video	Medium	---	
Default	Normal	For general data and background traffic.	

Add Rule

Clear Changes Apply Changes

- Bandwidth Management (sub-window opened upon clicking ‘Edit’ button)
  - Upstream
    - 128kbps
    - 256kbps
    - 384kbps
    - 512kbps
    - 768kbps
    - 1Mbps
    - 3Mbps
    - 10Mbps
    - 20Mbps
    - User defined
    - Default: 128kbps

## QoS &gt; QoS Profiles

Enable or disable QoS module function >  Enable  Disable

**Bandwidth Management**

Upstream >

Downstream >   kbps

**Bandwidth Allocation for Priority**

Level	Guarantee Minimal Bandwidth	Allow More
Highest	<input type="text" value="80"/> %	<input checked="" type="checkbox"/>
High	<input type="text" value="10"/> %	<input checked="" type="checkbox"/>
Medium	<input type="text" value="5"/> %	<input checked="" type="checkbox"/>
Normal	<input type="text" value="5"/> %	<input checked="" type="checkbox"/>

- Add as Classify Rule (sub-window opened upon clicking 'Add Rule' button)
  - Category
    - Applications,
    - MAC Address
    - IP Address
    - TCP/UDP
    - Default: Applications
  - Applications
    - Add a new application
    - MSN Messenger
    - Yahoo Messenger
    - Skype
    - FTP
    - Email
    - SNMP
    - Telnet
    - WWW
    - VPN
    - IGMP
    - Default: Add a new application
  - Enter a name
    - Open field
  - Port range
    - 1. From, To, TCP/UDP/Both (Default)
    - 2. From, To, TCP/UDP/Both (Default)
    - 3. From, To, TCP/UDP/Both (Default)
  - Priority

- Highest
- High
- Medium
- Normal
- Default: High
- Remark DSCP as (the first 6 bits of IP TOS field)
  - Don't remark
  - BE
  - AF1x
  - AF2x
  - AF3x
  - AF4x
  - EF
  - Default: Don't remark

QoS > QoS Profiles

Enable or disable QoS module function >  Enable  Disable

Profile >

Bandwidth Management >

Classify Rules >

Name	Priority	Information	Action
Voice Device	Highest	---	
Online Games	High	<input type="button" value="View Details"/>	
Video	Medium	---	
Default	Normal	For general data and background traffic.	

**Add a Classify Rule**

Category >

Applications >

Enter a Name >

Port Range >

1. From  To

2. From  To

3. From  To

Priority >

Remark DSCP as >  (the first 6 bits of IP TOS field)

- Skype
  - Priority defaults to Highest



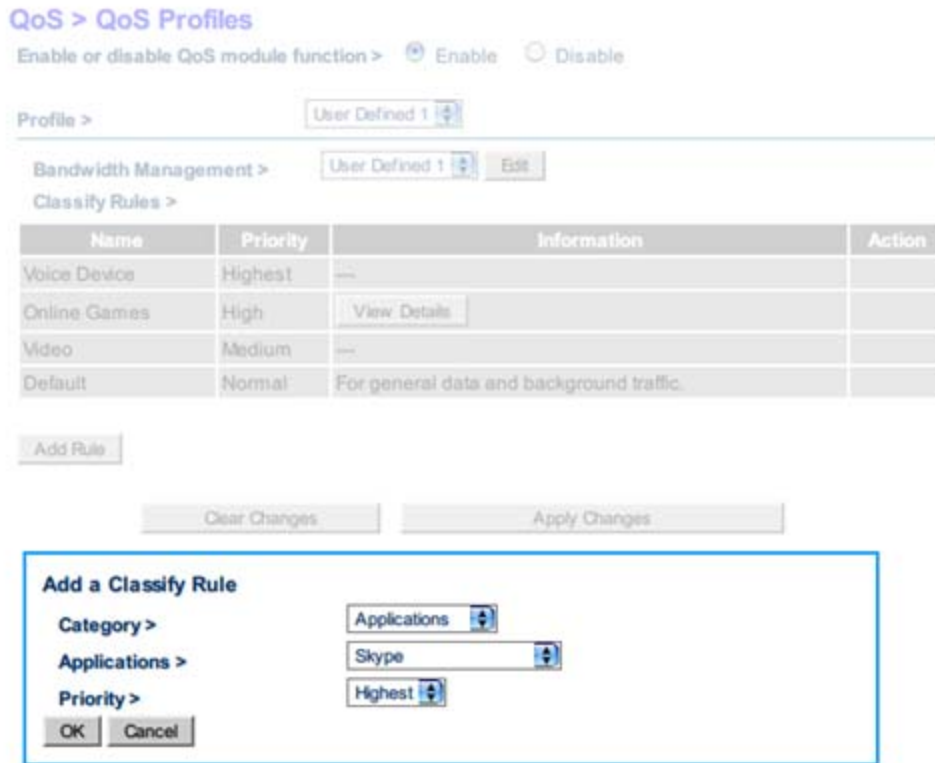

- MAC Address
  - Enter a Name
    - Open field
  - Source MAC address
    - 6 open fields
  - Priority defaults to High

### QoS > QoS Profiles

Enable or disable QoS module function >  Enable  Disable

Profile >

Bandwidth Management >

Classify Rules >

Name	Priority	Information	Action
Voice Device	Highest	---	
Online Games	High	<input type="button" value="View Details"/>	
Video	Medium	---	
Default	Normal	For general data and background traffic.	

**Add a Classify Rule**

Category >

Enter a Name >

Source Mac Address >  -  -  -  -  -

Priority >

- IP Address
  - Enter a name
    - Open field
  - IP range
    - Local address
      - IP address
        - 4 open fields
      - IP range
        - 5 open fields
      - Any
      - Default: Any
    - Remote address
      - ????
    - Priority
      - Highest
      - High
      - Medium
      - Normal
      - Default: High
    - Remark DSCP as (the first 6 bits of IP TOS field)
      - Don't remark

- BE
- AF1x
- AF2x
- AF3x
- AF4x
- EF
- Default: Don't remark

### QoS > QoS Profiles

Enable or disable QoS module function >  Enable  Disable

Profile >

User Defined 1

Bandwidth Management >

User Defined 1

Edit

Classify Rules >

Name	Priority	Information	Action
Voice Device	Highest	---	
Online Games	High	<a href="#">View Details</a>	
Video	Medium	---	
Default	Normal	For general data and background traffic.	

Add Rule

Clear Changes

Apply Changes

**Add a Classify Rule**

**Category >** IP address

**Enter a Name >**

**IP Range >**

**Local Address >** Any

**Remote Address >** Any

**Priority >** High

**Remark DSCP as >** Don't Remark (the first 6 bits of IP TOS field)

- TCP/UDP
  - Enter a name
    - Open field
  - Port range
    - 1. From, To, TCP/UDP/Both (Default)
    - 2. From, To, TCP/UDP/Both (Default)
    - 3. From, To, TCP/UDP/Both (Default)
  - Priority
    - Highest

- High
- Medium
- Normal
- Default: High

### QoS > QoS Profiles

Enable or disable QoS module function >  Enable  Disable

Profile >

Bandwidth Management >

Classify Rules >

Name	Priority	Information	Action
Voice Device	Highest	---	
Online Games	High	<input type="button" value="View Details"/>	
Video	Medium	---	
Default	Normal	For general data and background traffic.	

**Add a Classify Rule**

Category >

Enter a Name >

Port Range >

1. From  To

2. From  To

3. From  To

Priority >

- Supported Online Games (sub-window opened when clicking ‘View Details’ button)
  - See screenshot

**Supported Online Games >**

armagetron	battlefield2	<input type="button" value="OK"/>
counterstrike-source	dayofdefeat-source	
doom3	guildwars	
halflife2-deathmatch	quake1	
quake-halflife	teamfortress2	
worldofwarcraft		

## 6.8 UPnP Media Server

- Serve media files to compatible networked players
  - Default checked
- See separate document listing supported file types

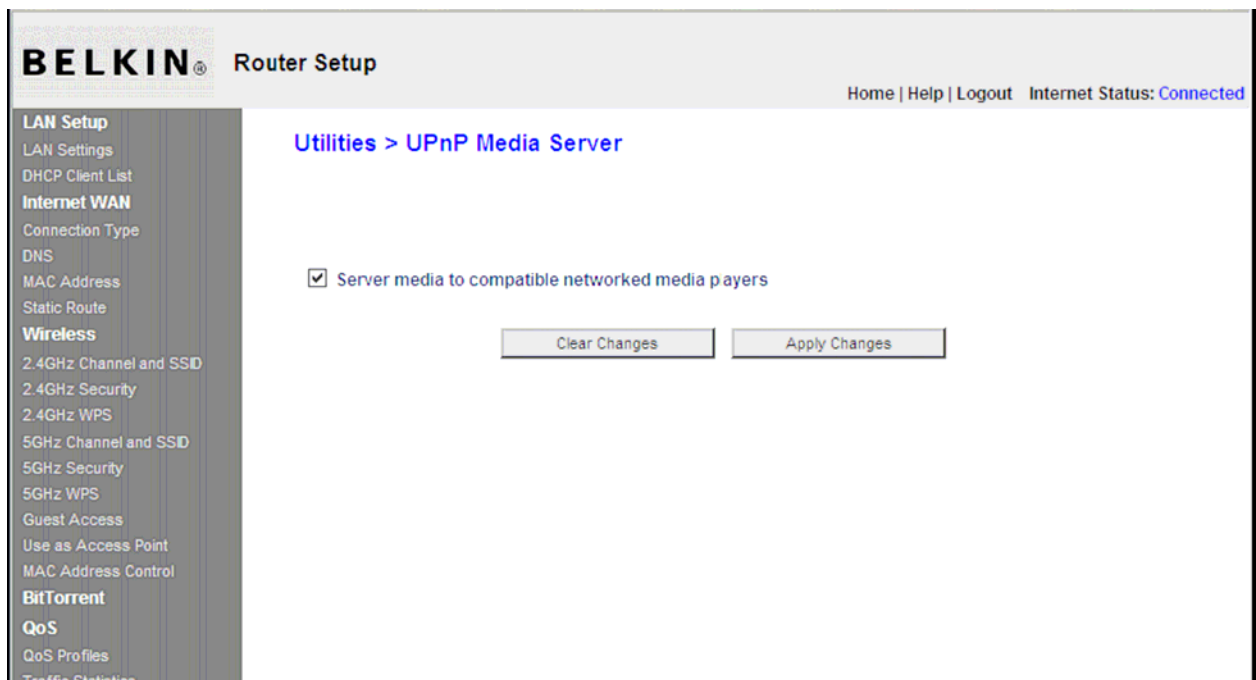

[johnki4]

## 6.2.6 Firewall

- Firewalls: NAT and SPI
- Firewall enable/disable (default is Enabled)
  - When it's enabled: DoS, SPI, ping to WAN, IP filter, and etc. will be blocked.
- Virtual servers (default equals Disabled)
  - Mapping of the private IP and port to public port, let wan side can access private service.
  - Port forwarding for preset services of popular applications such as web server (port 80) and FTP server (port 21).  
Note: application list, refer to the "Virtual\_Server\_List\_v1.0.doc".
  - Preset items can be added in the list with "Add" button
  - Previously added items can be removed with "Clear entry" and "Clear" button. (e.g. select the item entry number with pull-down box, and click on "Clear" button.

- Description: all characters(except " and \) can be used, 40 characters length.
  - IP range (1~254, Router's LAN IP excluded) - available and valid "Private IP address" means here, the client IP addresses that currently connected on the router
  - TCP/UDP port range(1~65535)
  - Able to set port forwarding for single port (such as port 5001)
  - Able to forward port ranges (such as port 1000-1100).
  - Up to 20 entries can be entered - Router will display the message " All entries are full Please remove some entries then try again" when user attempt to put more than 20 entries.
- Mac address Filtering (default equals blank)
  - allow access for MAC Addresses in the list (up to 32 entries)
  - This function only applies to wired clients. There is another function "MAC Address Control" for wireless clients.
  - This function will allow wired clients to access internet by MAC address. The clients whose MAC addresses not listed here with dynamic/static IP can not connect to the router.
  - Default: Disabled
    - Option: Enabled
  - MAC address list
    - Option: Blocked
    - Button: Add
      - Click button to add new entry
  - Button: Clear Changes
    - Clear all changes since the last save
  - Button: Apply Changes
    - Save changes that have been added
- Access Control
  - Default: Disabled
    - Option: Enabled
  - Member List
    - Button: Add
      - Click button to add new entry
      - Select from DHCP client list below the divider line
      - Click a client to add
    - Show added entry with computer name and MAC address
      - Status: Default Enabled
      - Restriction: Default Deny All
    - Button: Delete
      - Click button to deletes the selected entry
      - Popup message to confirm before deleting an entry
    - Maximum 20 members can be added

- Settings
  - Select an entry from the Member List to show configuration
  - Display two radio buttons for Allow or Deny
    - Default: Deny
    - Select Allow to grant access when matching the following settings
    - Select Deny to reject access when matching the following settings
  - Schedule
    - Day
      - Check appropriate box to select
        - Default: Everyday
      - Everyday (check box)
      - Sunday (check box)
      - Monday (check box)
      - Tuesday (check box)
      - Wednesday (check box)
      - Thursday (check box)
      - Friday (check box)
      - Saturday (check box)
    - Time
      - Check the box or select from drop down boxes
      - 24 hours (check box)
      - From (dropdown box)
      - To (dropdown box)
      - 1 hour increment for hour dropdown box
      - 5 min increment for minutes dropdown box
  - URL
    - Button: Add
      - Click button to add new entry
    - Button: Delete
      - Click button to deletes the selected entry
    - Maximum 10 entries per member
  - URL Keyword
    - Button: Add
      - Click button to add new entry
    - Button: Delete
      - Click button to deletes the selected entry
    - Maximum 10 entries per member
  - Services
    - List the following in dropdown boxes
      - Protocol
      - Port#
    - Select from five (5) dropdown boxes
  - Buttons
    - Apply Changes: Click button to save and activate settings

- Clear Changes: Click button to clear forms
- Logics:
  - When enabled, perform access control for computer/device added to the Member List. Determine access right from the Allow/Deny radio buttons, and validate against settings in Schedule, URL, URL Keyword or Services.
  - When validated, allow access and perform QoS when enabled.
  - When invalidated, display the following landing page in the web browser
  - Message:
    - Access denied. Enter Router password to temporarily allow access to the blocked page or services.
  - Text box:
    - for user to enter Router password
  - Button:
    - Click GO to proceed

To start off, the following screen is what is seen by the user the first time that he or she logs on.

## Internet Access Policy

### Member List

Member	Device	Mac Address	Status	Restriction	Action
					Add

Pressing the “Add” button adds opens up the following “Connected Client List” screen that automatically lists all the client list that have their MACs learned on the router. This list includes all the clients from the DHCP client list and reserved IP for MAC list as well.

This screen will show the Device host name under ‘Device’ column, IP address used by that device under ‘IP Address’ column and the associated device MAC address under the ‘MAC Address’ column. The ‘Action’ column shows the action that a user can take for that device. Device host name display is the actual name of the computer that a person assigns the OS when configuring the PC for the first time use. For head less devices like the Skype phones, the DNS host name will be displayed here. The device host name is added for ease of use so the user can easily identify the PCs in their home that they want to create access control rules for. Such names could be “Living room PC”, or “Tommy’s Bedroom PC” etc. If user wants to add a device in the access control list they can simply click in the “Add” button for that device. If the device already has access control configured for it then it will show ‘Added’ for the device under the “Action” column.



User can also add a particular MAC address of a device manually and press the “Add” button. User can also create a blanket rule for all the devices that are connecting via the Guest Access feature. Those devices might already be listed in the ‘Connected Client List’ and will show ‘Added’ under the action column once the Guest Access devices are added to the access control rule.

Device	IP Address	MAC Address	Action
PC 1	192.168.2.11	00-12-BF-00-00-01	Add
PC 2	192.168.2.12	00-12-BF-00-00-02	Add
belkin-test34	192.168.2.2	00-16-36-28-1E-FA	Add
	192.168.2.13	00-12-BF-00-00-03	Add
	192.168.2.14	00-12-BF-00-00-04	Add
	192.168.2.2	00-16-36-28-1e-fa	Add
All devices from Guest SSID			Add
		<input type="text"/> - <input type="text"/> - <input type="text"/> - <input type="text"/> - <input type="text"/>	Add

Cancel

Once a device is added, the main page will show this device added in. “Deny” is the default value for the main restriction and ‘Enable’ is the default status. User can delete an AC rule by clicking the ‘Delete’ button. Press the “Apply Changes” button to take the changes into effect. Pressing “Clear Changes” will not save the rule and revert back to the previously configured value.

Rename the ‘Restriction’ values as “Allow” and “Deny” only on the screen below.

### Internet Access Policy

#### Member List

Member	Device	Mac Address	Status	Restriction	Action
1	PC 1	00-12-BF-00-00-01	<input checked="" type="radio"/> Enable <input type="radio"/> Disable	<input checked="" type="radio"/> Allow All <input type="radio"/> Deny All	Delete
					Add

Clear Changes      Apply Changes

Pressing the button under “Member” column will open up the window displaying what is configured for that device.

There are 4 main configurations for Access Control lists. The first one is “Schedule” for that rule. The second is “Service” for the services to be blocked for that rule. The third is “URL Blocking”

for the URL access restrictions and the 4<sup>th</sup> is “URL Keyword Blocking” for certain keywords to be blocked in the URL address.

Everyday is the default for the days of the week that this rule will be implemented on the Schedule page. However user can select on their own if they want the policy to be enforced certain days of the week. 24 hours is the default time of the day value for this rule to be enforced however user can select certain time periods what they want this rule enforced. Time of day values are 24 hour clock for the ‘hour’ and 5 minutes increments for the ‘Minutes’.

If the main ‘Restriction’ for the rule is “Deny”, with ‘everyday’ and ‘24 hours’ checked, all the services, URL blocking and URL Keyword Blocking (whether configured for certain services, URLs or URL keywords or for all) will happen all the time. If certain days of the week and time of the day are specified here then those services, URLs and URL keywords will only be blocked during that time of access control rule enforcement and allowed through the rest of the time and days.

If the main ‘Restriction’ for the rule is “Allow”, with ‘everyday’ and ‘24 hours’ checked, all the services, URLs and URL Keywords will be allowed through all the time as if the rule was not even created for that device; this is if the user have the default “Allow All Services/URLs/URL Keywords” boxes checked in those particular tabs as described further below. If the user has specific Services, URLs or URL Keywords specified in those particular tabs with “Allow” as the main restriction, then with everyday and 24 hours checked on the schedule page will only allow those services, URLs and URL Keywords all the time while blocking all the rest. If certain days of the week and time of the day are specified on schedule page then those allowed services, URLs and URL keywords will only be allowed during that time of access control rule enforcement and blocked the rest of time and days. Hence “Allow” as the main restriction option is only reserved for advanced users and not the default selection.

## Internet Access Policy

### Member List

Member	Device	Mac Address	Status	Restriction	Action
1	PC 1	00-12-BF-00-00-01	<input checked="" type="radio"/> Enable <input type="radio"/> Disable	<input type="radio"/> Allow All <input checked="" type="radio"/> Deny All	Delete
					Add

### Exception of Control Rules for Memeber 1

Schedule	Service	URL Blocking	URL Keyword Blocking
<p><b>Schedule</b></p> <p>Days &gt;</p> <p><input checked="" type="checkbox"/> Everyday <input checked="" type="checkbox"/> Su <input checked="" type="checkbox"/> M <input checked="" type="checkbox"/> T <input checked="" type="checkbox"/> W <input checked="" type="checkbox"/> Th <input checked="" type="checkbox"/> F <input checked="" type="checkbox"/> Sa</p> <p>Time &gt;</p> <p><input checked="" type="radio"/> 24 Hours <input type="radio"/> From &gt; <input type="text" value="00"/> : <input type="text" value="00"/> : <input type="text" value="00"/> To &gt; <input type="text" value="00"/> : <input type="text" value="00"/> : <input type="text" value="00"/></p>			

The 2<sup>nd</sup> configuration for the access control list is the ‘Service’ that is to be blocked or allowed. There is one check box that could be titled as “Block All Services” or “Allow All Services” depending upon the main restriction defined for this AC rule. Default value is ‘checked’ for this check box named as “Block All Services” if the main restriction of the rule is “Deny”. Default value is ‘checked’ for this check box named as “Allow All Services” if the main restriction of the rule is “Allow”. Only one check box exist on this tab and only the name is changed accordingly based on the main restriction value for this AC rule. The rest of the indexes will be grayed out and until the user un-checks the block/allow all services box first.

User can also configure from a list of pre-defined popular services as seen below. All the port info for popular services are pre-configured. User can also define a service that is not in the list by specifying the TCP, UDP, TCP&UDP, IGMP etc and by defining the port ranges.

If the main restriction of the rule is ‘Deny’ and user configures for specific services to be blocked, then only those services will be blocked based on the schedule on the first tab while the rest of the services will be allowed through. If the main restriction of the rule is “Allow” and user configures for specific services to be allowed through, then only those services will be allowed through based on the schedule on the first tab while the rest of the services will be blocked.

Vendor: Please create one check box that is titled either “Block All Services” or “Allow All Services” and make the box checked by default. The name of the check box depends upon on the main restriction of the AC rule. If the main restriction is “Deny” then make the name “Block All Services”. But if the main restriction of the AC rule is “Allow” then show the name of this check

box as “Allow All Services”. The rest of the indexes will be grayed out until the user un-checks this box first. Please follow the functional behavior described above for feature implementation.

**Exception of Control Rules for Memeber 1**

Schedule Service URL Blocking URL Keyword Blocking

**Blocked Services**

Index	Service	Port Range List	
1	None	None	
2	None	None	
3	None	None	
4	Ping	None	
5	HTTPS	None	

**Exception of Control Rules for Memeber 1**

Schedule Service URL Blocking URL Keyword Blocking

**Blocked Services**

Index	Service	Port Range List	
1	Ping	ICMP	
2	HTTP	TCP	80
3	HTTPS	TCP	443
4	FTP	TCP	20-21
5	TFTP	TCP & UDP	69

**Blocked Services**

Index	Service	Port Range List	
1	User-Defined	TCP & UDP	1500-1600
2	User-Defined	None	
3	None	TCP	
4	None	UDP	
5	None	TCP & UDP	

The 3<sup>rd</sup> configuration for the access control list is the 'URL List' for the URL addresses that are to be blocked or allowed. There is one check box that could be titled as "Block All URLs" or "Allow All URLs" depending upon the main restriction defined for this AC rule. Default value is 'checked' for this check box named as "Block All URLs" if the main restriction of the rule is "Deny". Default value is 'checked' for this check box named as "Allow All URLs" if the main restriction of the rule is "Allow". Only one check box exist on this tab and only the name is changed accordingly based on the main restriction value for this AC rule. The rest of the indexes will be grayed out and until the user un-checks the block/allow all services box first.

User can also configure a list of URL Addresses as seen below. If the main restriction of the rule is 'Deny' and user configures for specific URL Addresses to be blocked, then only those URLs will be blocked based on the schedule on the first tab while the rest of the URLs will be allowed through. If the main restriction of the rule is "Allow" and user configures for specific URLs to be allowed through, then only those URLs will be allowed through based on the schedule on the first tab while the rest of the URLs will be blocked.

Vendor: Please rename this tab as "URL List". Please create one check box that is titled either "Block All URLs" or "Allow All URLs" and make the box checked by default. The name of the check box depends upon on the main restriction of the AC rule. If the main restriction is "Deny" then make the name "Block All URLs". But if the main restriction of the AC rule is "Allow" then show the name of this check box as "Allow All URLs". The rest of the indexes will be grayed out until the user un-checks this box first. Please follow the functional behavior described above for feature implementation.



The 4<sup>th</sup> configuration for the access control list is the 'URL Keyword List' for the URL addresses keywords that are to be blocked or allowed. Default value is blank for this list. User can configure a list of URL Address Keywords as seen below. If the main restriction of the rule is 'Deny' and user configures for specific URL Address Keywords to be blocked, then those URLs containing those keywords will be blocked based on the schedule on the first tab while the rest of the URLs will be allowed through. These could be URLs that would have been allowed through if not part of the user configured URL Block List specified in the 3<sup>rd</sup> tab, but will now be blocked due to the keywords specified here.

If the main restriction of the rule is “Allow” and user configures for specific URL Address Keywords to be allowed through, then those URLs will be allowed through based on the schedule on the first tab while the rest of the URLs will be blocked. These could be URLs that would have been blocked if not part of the user configured URL Allow List specified in the 3<sup>rd</sup> tab, but will now be allowed through due to the keywords specified here.

This tab is renamed to “URL Keyword List”.

Exception of Control Rules for Memeber 1

Schedule Service URL Blocking URL Keyword Blocking

Website Blocking by Keyword

Index	Keyword
1	game
2	ebay
3	shopping
4	
5	
6	

Clear Changes Apply Changes

- DMZ (default equals blank)
  - expose host and opens all ports
  - IP addresses accepted 1-254
- DDNS (default equals Disabled)
  - works with DynDNS.org (default is blank)
  - button for update Dynamic DNS
  - Username/password/Domain Name only allow alphanumeric characters
- WAN ping blocking (defaults is Enabled)
- Security log
  - log traffic and event (see Firewall section)
  - save log file (sys\_log.log) and clear log. IE7 is defaulting to open up notepad for .log files, which is acceptable.
  - Refresh button to refresh log
  - Minimum 20 entries, Reset on reboot
    - Date and Time
    - Hostname (none) represents current host
    - Service type

- Level
- Process[pid]
- Message

Content Filter blocked xxx URL : xxx

Message: xxx\r\n

Time: xxx\r\nMessage: xxx\r\n

Message: xxx\r\nSource: xxx\r\nDestination: xxx\r\n

Time: xxx\r\nMessage: xxx\r\nSource: xxx\r\nDestination:xxx\r\n

## 6.2.7 Utilities

- Restart Router
- Restore Factory Default
  - Icons will not change for a few seconds while the settings are being sent to the router. After settings are sent, the router will restart and the router icon will blink while it boots up.
- Save/Backup Settings
  - save current configuration as “user.conf”
- Restore Previous Settings
  - restore configuration from “user.conf”
  - Icons will not change for a few seconds while the settings are being sent to the router. After settings are sent, the router will restart and the router icon will blink while it boots up.
- Firmware update
  - auto firmware updates notifications (default is disabled, checks when f/w GUI is opened)
  - manual firmware check:
    - WW: <http://networking.belkin.com/update/files/F7D4402/v1/WW/version.html>
  - browse firmware file (.bin) to update
  - Firmware naming convention: F7D4402\_WW\_1.xx.xx.bin
  - Router should only update firmware designed for the SKU version
  - Router will not update or save corrupt firmware using checksum:
    - Utilize crc32 for system image checksum
    - Have special signature for different models to prevent the cross upgrading
    - Have the master flash image checksum
    - Will notify user the firmware image is incorrect if the firmware was modified by editors.
  - Router should allow backdate release from the same SKU version.
- System settings
  - Administrator Password



- one user can log in at a time; other users can get to homepage but can not login)
- Range: 0 or 3~12 characters. All characters are allowed.
- login timeout (default equals 10 minutes, 1-99 range)
- Time and Time Zone
  - select time zone (PST for US, other regions vary)
  - auto adjust for daylight saving (default equals On)
  - primary / secondary time (NTP) servers

Available NTP		
<b>North America</b>	192.43.244.18	132.163.4.102
<b>North America</b>	192.5.41.41	192.5.41.209
<b>North America</b>	207.200.81.113	208.184.49.9
<b>Europe</b>	129.132.2.21	130.149.17.8
<b>Australia &amp; NZ</b>	128.250.36.3	130.123.2.99
<b>Asia Pacific</b>	129.132.2.21	130.149.17.8

Note: NTP query will be sent when there is an IP address for WAN interface. After that NTP query will be sent every 6 hours.

- Remote management (default equals Off)
  - choose from any IP or specific IP
  - user selectable remote management port (8080)
- UPnP enabling (default equals Enable)
  - Device Type: Wireless Modem Router
  - Friendly Name: Belkin Play Max Wireless Modem Router (TBD)
  - Manufacturer: Belkin International
  - Manufacturer URL: [www.Belkin.com](http://www.Belkin.com)
  - Model Description: Wireless Modem Router with Ethernet Switch
  - Model Name: Play Wireless Modem Router (TBD)
  - Model Number: F7D4402 v1
  - Serial Number: (read serial number from EEPROM)
  - UDN: N/A
  - UPC: N/A
  - Device Address: (equals router IP address)
- auto update firmware enabling (default Disabled)
  - when Enabled, checks for newer firmware when FW GUI is opened
- ECO features {NEW}
  - Default: Disabled
    - Enable to dim all LED icons.



- Wireless Radio (check box):
  - Default: Unchecked
    - Select from the dropdown box for:
      - Start time
      - End time
    - Daily exceptions via checkboxes

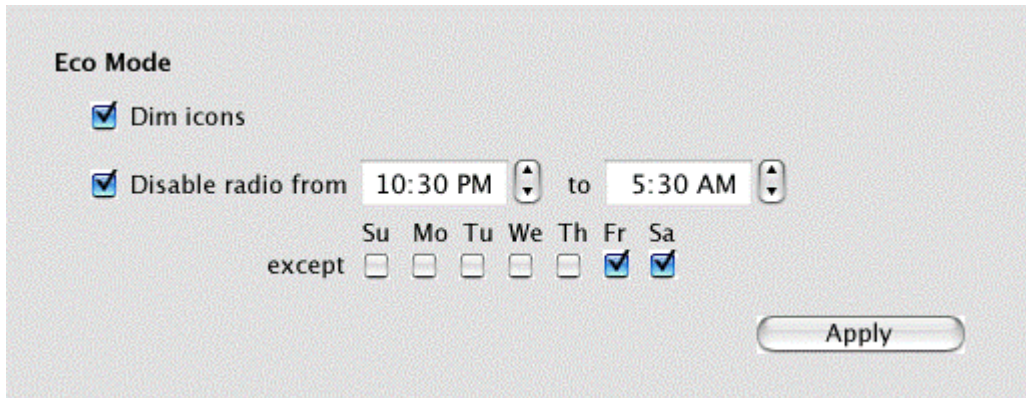

### 6.2.8 Advanced Wireless (adv\_wireless.html hidden page)

Screenshot for reference only, the page must have

1. Warning at top of the page - "This page is provided "as is" for special purposes. Using of this page is without any expressed or implied warranties and may destroy your settings."
2. Restore to default button which restores all settings on this page to default.
3. Apply button

All other aspects of the page are to be determined by the vendor.

**Wireless > Advanced Setting**

THIS PAGE IS PROVIDED "AS IS" FOR SPECIAL PURPOSE. USING OF THIS PAGE IS WITHOUT ANY EXPRESSED OR IMPLIED WARRANTIES AND MAY DESTROY YOUR SETTINGS.

Wireless Mode > 802.11b & 802.11g & 1x1 802.11n ▼

RTS Threshold > 2347 (range 1-2347, default 2347)

Beacon Interval > 100 ms (range 20-999, default 100)

DTIM Interval > 1 ms (range 1-255, default 1)

WPS testing > WPS UnConfigure ▼

Device's UUID > uuid:775b6680-bfde-11d3-8d2f-00173fc544a5

WMM(QoS) Paramters >

**AP**

	CWMin	CWMax	AIFS	TxOpLimit
AC_BE	3	6	3	0
AC_BK	3	10	7	0
AC_VI	2	3	1	94
AC_VO	2	3	1	47

**STA**

	CWMin	CWMax	AIFS	TxOpLimit
AC_BE	4	10	3	0
AC_BK	4	10	7	0
AC_VI	3	4	2	94
AC_VO	2	3	2	47

Manufacture Name > Belkin International  
 Firmware Build Time > Jan 13 2009 15:38:48  
 Wireless driver > 3100

- Advise end user that this page is for development use only.
- Wireless mode:
  - 1) OFF
  - 2) 802.11b
  - 3) 802.11g
  - 4) 802.11n
  - 5) 802.11b+g
  - 6) 802.11b+g+n (default)
  - 7) 802.11g+n
- RTS: range 1 -- 2347, default 2347
- Beacon Interval : range 20 - 999 ms, default 100ms
- DTIM interval: range 1 - 255 ms, default 1ms
- WPS testing: WPS Configured(default), WPS unconfigured

### 6.3 Protocol Supported

- TCP/IP v4, UDP, CSMA/CD, DHCP, LLTD (with Win7 logo)

### 6.4 ISP Protocol Supported Regions

- Connection Type

Region	ISP Connection Types
NCSA	Dynamic, PPPoE, Static, PPPoA, Modem only
EMEA	Dynamic, PPPoE, Static, PPPoA, Modem only
APAC	Dynamic, PPPoE, Static, PPPoA, Modem only
Australia	Dynamic, PPPoE, Static, PPPoA, Modem only

- **Dynamic/Fixed IP (1483 Bridge)**
  - IP assigned by ISP: use dynamic IP or fixed IP (default is Yes = dynamic IP)
  - For Dynamic IP
    - Option to use static default gateway (default=unchecked)
    - Default Gateway (enter manually by user)
      - 1<sup>st</sup> octet: 1-223
      - 2<sup>nd</sup> octet: 0-255
      - 3<sup>rd</sup> octet: 0-255
      - 4<sup>th</sup> octet: 1-254
    - VPI/VCI (default varies by region)
      - VPI range (0~255)
      - VCI range (0~65535)
    - Encapsulation: LLC or VC Mux (default varies by region)
  - For Fixed IP
    - IP Address (default is blank. This can be entered manually by user)
      - 1<sup>st</sup> octet: 1-223
      - 2<sup>nd</sup> octet: 0-255
      - 3<sup>rd</sup> octet: 0-255
      - 4<sup>th</sup> octet: 1-254
    - Subnet Mask (default is blank. This can be entered manually by user)
      - 1<sup>st</sup> octet: 255
      - 2<sup>nd</sup> octet: 0, 128, 192, 224, 240, 248, 252, 254, 255
      - 3<sup>rd</sup> octet: 0, 128, 192, 224, 240, 248, 252, 254, 255
      - 4<sup>th</sup> octet: 0, 128, 192, 224, 240, 248, 252
    - Default Gateway (enter manually by user)
      - 1<sup>st</sup> octet: 1-223

- 2<sup>nd</sup> octet: 0-255
- 3<sup>rd</sup> octet: 0-255
- 4<sup>th</sup> octet: 1-254
- VPI/VCI (default varies by region)
  - VPI range (0~255)
  - VCI range (0~65535)
- Encapsulation: LLC or VC Mux (default varies by region)

**WAN > Connection Type > Dynamic/Fixed IP (1483 Bridge)**

To enter your Dynamic IP settings, type in your information below and click "Apply changes".

**IP assigned by ISP >**

Use static Default Gateway:

**Default Gateway >**  .  .  .

**VPI/VCI >**  /

**Encapsulation >**

**WAN > Connection Type > Dynamic/Fixed IP (1483 Bridge)**

To enter your Dynamic IP settings, type in your information below and click "Apply changes".

<b>IP assigned by ISP &gt;</b>	<input type="text" value="No"/>
<b>IP Address</b>	<input type="text" value="0"/> . <input type="text" value="0"/> . <input type="text" value="0"/> . <input type="text" value="0"/>
<b>Subnet Mask</b>	<input type="text" value="0"/> . <input type="text" value="0"/> . <input type="text" value="0"/> . <input type="text" value="0"/>
<b>Default Gateway&gt;</b>	<input type="text" value="0"/> . <input type="text" value="0"/> . <input type="text" value="0"/> . <input type="text" value="0"/>
<b>VPI/VCI&gt;</b>	<input type="text" value="0"/> / <input type="text" value="38"/>
<b>Encapsulation&gt;</b>	<input type="text" value="VC MUX"/>

[Click here to enter your DNS Settings](#)

Clear Changes

Apply Changes

- **Static IP (IPoA)**
  - WAN IP Address (default is blank. This can be entered manually by user)
    - 1<sup>st</sup> octet: 1-223
    - 2<sup>nd</sup> octet: 0-255
    - 3<sup>rd</sup> octet: 0-255
    - 4<sup>th</sup> octet: 1-254
  - Subnet Mask (default is blank. This can be entered manually by user)
    - 1<sup>st</sup> octet: 255
    - 2<sup>nd</sup> octet: 0, 128, 192, 224, 240, 248, 252, 254, 255
    - 3<sup>rd</sup> octet: 0, 128, 192, 224, 240, 248, 252, 254, 255
    - 4<sup>th</sup> octet: 0, 128, 192, 224, 240, 248, 252
  - Option to use static default gateway (default=unchecked)
  - Default Gateway (Enter manually by user)
    - 1<sup>st</sup> octet: 1-223
    - 2<sup>nd</sup> octet: 0-255
    - 3<sup>rd</sup> octet: 0-255
    - 4<sup>th</sup> octet: 1-254
  - VPI/VCI (default varies by region)
    - VPI range (0~255)
    - VCI range (0~65535)

- Encapsulation: LLC or VC Mux (default varies by region)

**WAN > Connection Type > Static IP (IPoA)**

To enter your Static IP settings, type in your information below and click "Apply changes". [More Info](#)

**WAN IP Address >**  .  .  .

**Subnet Mask >**  .  .  .

Use static Default Gateway:

**Default Gateway >**  .  .  .

**VPI/VC I >**  /

**Encapsulation >**

[Click here to enter your DNS Settings](#)

- PPPoE (PPP over Ethernet, RFC2516)

**WAN > Connection Type > PPPoE**

To enter your PPPoE settings, type in your information below and click "Apply changes". [More Info](#)

<b>Username &gt;</b>	<input type="text"/>	
<b>Password &gt;</b>	<input type="text"/>	
<b>Re-type Password</b>	<input type="text"/>	
<b>Service Name (Optional)</b>	<input type="text"/>	
<b>IP assigned by ISP &gt;</b>	No ▾	
<b>IP Address</b>	<input type="text" value="0"/> . <input type="text" value="0"/> . <input type="text" value="0"/> . <input type="text" value="0"/>	Only Visible when "IP Assigned by ISP" set to "No".
<b>VPI / VCI</b>	<input type="text" value="0"/> / <input type="text" value="38"/>	
<b>Encapsulation</b>	LLC ▾	
<b>MTU(500-1500) &gt;</b>	<input type="text" value="1432"/>	

Do not make changes to the MTU setting unless your ISP specifically requires a different setting than 1432. [More Info](#)

Disconnect after:  minutes of no activity.

Clear Changes

Apply Changes

## Screenshot to be updated when FW complete

- User Name and Password
  - Default: Blank (Max. characters: 63)
  - All characters allowed
- Service Name
  - Default: Blank (Max. characters: 60)
- MTU (Maximum Transmission Unit)
  - Default: 1454 (Range: 500-1500)
- Connect on Demand
  - Disconnect after X minutes of no activity
  - Default: Varies by country
    - 0 for NCSA, 5 for EMEA (Range: 1-99)
  - Update status within 1 minute
    - In a controlled lab environment, it takes 5-10 seconds. In a life environment, it takes 10-20 seconds (depends on ISP). The router should reconnect within 30 seconds.
- IP Assigned by ISP(default: YES)

- YES: WAN IP address provided by ISP automatically.
- NO: IP Address field will be available for entering custom values by users.
- IP Address (default is the WAN IP address currently the router has or can be entered manually by user)
  - 1<sup>st</sup> octet: 1-223
  - 2<sup>nd</sup> octet: 0-255
  - 3<sup>rd</sup> octet: 0-255
  - 4<sup>th</sup> octet: 0-255

- **PPPoA (PPP over AAL5 ATM, RFC2364)**

- User Name and Password
  - Default: Blank (Max. characters: 63)
  - All characters are allowed(0-9a-zA-Z`~!@#\$\$%^&\*()-=+\_[]{};:'"\|,.<>?/)
- Service Name (Optional)
  - Optional / name of ISP
  - Default: Blank (Max. characters: 60)
  - All characters are allowed(0-9a-zA-Z`~!@#\$\$%^&\*()-=+\_[]{};:'"\|,.<>?/)
- VPI/VCI
  - Default: varies by region
  - VPI range (0~255)
  - VCI range (0~65535)
- Encapsulation:
  - LLC or VC Mux
  - Default: varies by region
- MTU (Maximum Transmission Unit)
  - Range: 500 to 1500
  - Default: varies by region
- Connect on Demand
  - Disconnect after X minutes of no activity
  - Default: Varies by country
    - Check box: Checked / Unchecked
    - Range: 1-99
  - Update status within 1 minute
  - In a controlled lab environment, it takes 5-10 seconds. If a life environment, it takes 10-20 seconds (depends on ISP). The router should reconnect within 30 seconds.
- IP Assigned by ISP(default: YES)
  - YES: WAN IP address provided by ISP automatically. IP address field is hidden.
  - NO: IP Address field will be available for entering custom values by users.



- IP Address (default is blank. This can be entered manually by user)
  - o 1<sup>st</sup> octet: 1-223
  - o 2<sup>nd</sup> octet: 0-255
  - o 3<sup>rd</sup> octet: 0-255
  - o 4<sup>th</sup> octet: 1-254

**WAN > Connection Type > PPPoA**

To enter your PPPoA settings, type in your information below and click "Apply changes". [More Info](#)

**Username >**

**Password >**

**Retype Password**

**Service Name (Optional)**

**IP assigned by ISP >**   *Yes / No*

**IP Address**     *- if YES, this section will be hidden.  
- if NO, this section will be available for entering values.*

**VPI/VCI**  /

**Encapsulation**

**MTU (576-1492) >**  *500-1500*

Do not make changes to the MTU setting unless your ISP specifically requires a different setting than 1454. [More Info](#)

Disconnect after  minutes of no activity. [More Info](#)

- o **Modem only (Disable Internet Sharing)**
  - VPI/VCI (default varies by region)
    - VPI range (0~255)
    - VCI range (0~65535)
  - Encapsulation: LLC or VC Mux (default varies by region)

**WAN > Connection Type > Modem only (Disable Internet Sharing)**

To enter your Modem settings, type in your information below and click "Apply changes".

VPI/VCI >  /

Encapsulation >

## 6.5 VPN Pass-thru Support

- PPTP, IPSEC, and L2TP VPN pass-thru
- Multiple tunnels to each VPN server (maximum 4 tunnels)
- Tunnel disconnect reset: 60 sec

## 6.9 Test Installer and Firmware with:

- Operating Systems:
  - Windows XP with SP2 or latest Service Pack
  - Windows Vista Basic (32 & 64) with latest Service Pack
  - Windows Vista Premium (32 & 64) with latest Service Pack
  - Windows 7 (32 & 64) with latest Service Pack
  - Mac OS10.4 or 10.5 or 10.6
- Web Browsers:
  - MS IE, 6, 7, 8
  - Mozilla Firefox
  - Apple Safari(one test of each latest version required)

## 7. Package Contents (TBC)

---

The product contains the following major items – listed in the order of placement (top to bottom) in the packaging. Actual packaging will be determined in the marketing BOM, which **vary according to regional requirements.**

- Quick Install Guide
- Play Wireless Modem-Router
  
- Installation software CD-ROM, included Affinegy Installer and User Manual PDFs
  
- Belkin-branded cables and ADSL filter
  - 1) Annex-A Type
    - a. RJ-11 Telephone cord (Gray)
    - b. RJ-45 Cat5 2 pair Ethernet cable (Yellow)
    - c. ADSL filter (vary by regions)

Wrapped in clear plastic bag with “Network Cable” sticker
  
- Power Adapter (see Section 3.7), packaged in it’s white box with “Power Supply” sticker
  
- Sample packaging BOM:
  - Case Pack = 2 units per CP
  - Shrink wrap
  - Retail color corrugated box
  
  - Inner tray
  - Misc. inserts and stickers (see marketing BOM)

## 8. Regulatory Certifications / Compliance

---

The Router is required to be compliant and certified under the following regulatory certifications. Certification must be completed and fees covered by ODM on Belkin’s behalf. And all necessary reports and certification should be transferred to Belkin’s Engineering Services as part of the FAS/PVT approval process, and should be prior to shipping of the first production.

### NCSA:

- US: FCC B ID (EMC & Wireless) K7SF7D4401V1
- Canada: ICES (EMC & Wireless) 3623A-F7D4401V1

### EMEA:

- Europe: CE, ETS 300 328, ETS 300 836 (Wireless)  
EN50081, 50082, 61000-3-2, 61000-3-3 (EMC)
- Russia: GOST-R

### ANZ:

- Australia & New Zealand: A-Tick (EMC)

## APAC:

- Japan: TELEC
- Korea: MIC
- Singapore: iDA
- Taiwan: NCC (Replaces DGT)
- China: SRRC
- Other: (TBD)

## Worldwide:

- WFA Wi-Fi 11a/b/g/n-draft
- WFA WMM and WPS
- Intel 11n Centrino Logo [design to pass, but certify as rolling change]
- RoHS – EU and China
- WEEE

## FCC Part 68 REQUIREMENTS

This equipment complies with Part 68 of the FCC rules and the requirements adopted by the ACTA. On the bottom of this equipment is a label that contains, among other information, a product identifier in the format US: BKCDL01BF7D4402V1. If requested, this number must be provided to the telephone company.

The REN is used to determine the number of devices that may be connected to a telephone line. Excessive RENs on a telephone line may result in the devices not ringing in response to an incoming call. In most but not all areas, the sum of RENs should not exceed five (5.0). To be certain of the number of devices that may be connected to a line, as determined by the total RENs, contact the local telephone company. For products approved after July 23, 2001, the REN for this product is part of the product identifier that has the format US: BKCDL01BF7D4402V1. The digits represented by 01 are the REN without a decimal point (e.g., 03 is a REN of 0.3). For earlier products, the REN is separately shown on the label.

A plug and jack used to connect this equipment to the premises wiring and telephone network must comply with the applicable FCC Part 68 rules and requirements adopted by the ACTA. A compliant telephone cord and modular plug is provided with this product. It is designed to be connected to a compatible modular jack that is also compliant. See installation instructions for details.

If your equipment causes harm to the telephone network, the telephone company may discontinue your service temporarily. If possible, they will notify you in advance. But if

advance notice is not practical, you will be notified as soon as possible. You will be informed of your right to file a complaint with the FCC. Your telephone company may make changes in its facilities, equipment, operations or procedures that could affect the proper functioning of your equipment. If they do, you will be notified in advance to give you an opportunity to maintain uninterrupted telephone service.

If you experience trouble with this telephone equipment, Please contact the following address and phone number for information on obtaining service or repairs.

The telephone company may ask that you disconnect this equipment from the network until the problem has been corrected or until you are sure that the equipment is not malfunctioning.

This equipment may not be used on coin service provided by the telephone company. Connection to party lines is subject to state tariffs.

**COMPANY:** Belkin International, Inc.

**ADDRESS:** 12045 East Waterfront Drive Playa Vista, CA 90094

**TEL NO:** 1-310-751-5100

**Federal Communication Commission Interference Statement**

This equipment has been tested and found to comply with the limits for a Class B digital device, pursuant to Part 15 of the FCC Rules. These limits are designed to provide reasonable protection against harmful interference in a residential installation. This equipment generates, uses and can radiate radio frequency energy and, if not installed and used in accordance with the instructions, may cause harmful interference to radio communications. However, there is no guarantee that interference will not occur in a particular installation. If this equipment does cause harmful interference to radio or television reception, which can be determined by turning the equipment off and on, the user is encouraged to try to correct the interference by one of the following measures:

- Reorient or relocate the receiving antenna.
- Increase the separation between the equipment and receiver.
- Connect the equipment into an outlet on a circuit different from that to which the receiver is connected.
- Consult the dealer or an experienced radio/TV technician for help.

FCC Caution: Any changes or modifications not expressly approved by the party responsible for compliance could void the user's authority to operate this equipment.

This device complies with Part 15 of the FCC Rules. Operation is subject to the following two conditions: (1) This device may not cause harmful interference, and (2) this device must accept any interference received, including interference that may cause undesired operation.

For product available in the USA/Canada market, only channel 1~11 can be operated. Selection of other channels is not possible.

This device and its antenna(s) must not be co-located or operation in conjunction with any other antenna or transmitter.

This device is going to be operated in 5.15~5.25GHz frequency range, it is restricted in indoor environment only.

**IMPORTANT NOTE:****FCC Radiation Exposure Statement:**

This equipment complies with FCC radiation exposure limits set forth for an uncontrolled environment. This equipment should be installed and operated with minimum distance 20cm between the radiator & your body.

## 9. Intended Markets

---

Below is a list of major markets:

NCSA: United States (for FCC purpose only), Canada, Mexico

EMEA: United Kingdom, France, Germany, Spain, Italy, Netherlands,  
Portuguese, Netherlands, Norway, Demark, Russia, Israel (TBC)

United Kingdom, and various Middle East countries (uk)  
France, Germany, Netherlands, Belgian, Austria, Sweden, Norway,  
Demark, Finland, Israel (ed)  
Spain, Portugal, Italy, Greece, Turkey (nt)  
Polish, Czech, Slovakian, Hungarian, Russian, Romanian,  
Bulgarian, Croatia and Slovenia (nv) (TBC)

ANZ/APAC: Australia and , New Zealand (au)

APAC: Singapore, Malaysia, Hong Kong (ak)  
Indonesia, Thailand, Philippines, Vietnam, India (sa) China, Taiwan,  
Japan, Korea, Singapore, and other South Eastern Asia countries (TBC)

## 10. Sample Requirements

---

Vendor is required to provide the following samples free-of-charges to Belkin for EVT, DVT and PVT according to the project schedule:

I) Prototype/Engineering Sample (ES) for EVT/DVT1:  
(If ES can be the FHS, see the next section for sample requirements)\*\*\*

:

For QA:

4 HW + US PSU to Compton

4 HW + US PSU to Future Tech

4 HW + US PSU to Lion Bridge

Plus 2 PSUs for each applicable regions (UK, EU, AU, etc.) **Will provide once sku kick-off**

For PM:

6 HW + US PSU to Compton

-----  
Total 18 sets [Note: HW could be just PCBA if enclosure is not ready]

II) Final Hardware Sample (FHS) for DVT:

**\*\*\*Each revision of HW automatically requires re-sampling to all regions\*\*\***

## For QA:

4 US + 4 EU HW to Compton  
 4 US + 4 EU HW to Future Tech  
 4 HW + US PSU to Lion Bridge  
 Plus 2 PSUs for each applicable regions "IF" not provided for EVT.  
 Reuse PSUs from EVT "IF" no changes needed

## For PM:

4 US + 4 EU to Compton  
 Will based on sku kick-off  
 4 EU to EU PM  
 3 AU to Australia PM  
 2 AK to HK PM

## For QC:

1 US + 1 EU HW/PSUs to Shenzhen

-----  
 Total 35 sets [Note: FHS HW must be in enclosure with final PSU]

## III) First Article Sample (FAS) for PVT:

**\*\*\*Vendor to test 30 FAS units per region and submit 6 FAS with full test report to Belkin QA for PVT verification.\*\*\***

## For QA:

2 US FAS to Compton

## For PM:

24 US FAS to Compton (includes the 6 FAS with full test report)  
 (Could move QA PVT testing to HK QC team. Please check with PM prior to PR/FAS production)\*\*\*

## For QC:

2 US + 1 EU FAS to Shenzhen

## For ES:

2 US FAS to Compton (Send to PM)

-----  
 Total 30 FAS

Plus 2 region-specific FAS to International PM and QA when approved

## 11. Appendix

---