

NETGEAR®

N300 Personal Router PR2000

User Manual



July 2013

CERTIFICATION DRAFT

Note: This draft is a certification document and there might be some differences between this user manual and the actual unit.

350 East Plumeria Drive
San Jose, CA 95134
USA



N300 Personal Router PR2000

Support

Thank you for selecting NETGEAR products.

After installing your device, locate the serial number on the label of your product and use it to register your product at <https://my.netgear.com>. You must register your product before you can use NETGEAR telephone support. NETGEAR recommends registering your product through the NETGEAR website. For product updates and web support, visit <http://support.netgear.com>.

Phone (US & Canada only): 1-888-NETGEAR.

Phone (Other Countries): Check the list of phone numbers at <http://support.netgear.com/general/contact/default.aspx>.

Trademarks

NETGEAR, the NETGEAR logo, and Connect with Innovation are trademarks and/or registered trademarks of NETGEAR, Inc. and/or its subsidiaries in the United States and/or other countries. Information is subject to change without notice. © NETGEAR, Inc. All rights reserved..

Contents

Chapter 1 Hardware Setup

Unpack Your Router	8
Position Your Router	8
Prepare the Router	9
Hardware Features	11
Internet Mode Switch	11
Indicator LEDs	12
Connection Ports and Reset Button	13
Power Inputs	14
Product Label	15
Get Started	16
Connect to the Internet with a Wired WAN Connection	16
Connect to the Internet with a Wireless WAN Connection	18
Use the PR2000 Unit as a Wireless Repeater	20
Use the PR2000 Unit as a Two-Port WiFi Adapter	21
Use the PR2000 Unit as a Mobile Broadband Router	22
Connect Wireless Devices to the PR2000 Unit	22

Chapter 2 Getting Started with NETGEAR genie

Router Setup Preparation	24
Use Standard TCP/IP Properties for DHCP	24
Gather ISP Information	24
Wireless Devices and Security Settings	24
Types of Logins and Access	24
NETGEAR genie Setup	25
Use NETGEAR genie after Installation	25
Upgrade Router Firmware	26
Router Dashboard (Basic Home Screen)	26
Add Wireless Devices or Computers to Your Network	27
Manual Method	28
Wi-Fi Protected Setup (WPS) Method	28

Chapter 3 genie Basic Settings

Internet Setup	30
Internet Setup Screen Fields	30
Attached Devices	32
Parental Controls	32
ReadySHARE USB Storage	35
Basic Wireless Settings	36

N300 Personal Router PR2000

Wireless Setup Screen Fields	37
Change WPA Security Option and Password	38
Guest Networks	39
Guest Network Wireless Security Options	40

Chapter 4 genie Advanced Home

Setup Wizard	43
WPS Wizard	44
Setup Menu	45
WAN Setup	46
Default DMZ Server	47
Change the MTU Size	47
LAN Setup	49
LAN Setup Screen Settings	50
Use the Router as a DHCP Server	50
Address Reservation	51
Quality of Service (QoS) Setup	52

Chapter 5 USB Storage

USB Drive Requirements	58
ReadySHARE Access	58
File-Sharing Scenarios	59
Basic Settings	60
Add or Edit a Network Folder	61
USB Storage Advanced Settings	62
Safely Remove a USB Drive	63
Specify Approved USB Devices	64
Connect to the USB Drive from a Remote Computer	65
Access the Router's USB Drive Remotely Using FTP	65

Chapter 6 Security

Keyword Blocking of HTTP Traffic	67
Block Services (Port Filtering)	67
Schedule Blocking	69
Security Event Email Notifications	70

Chapter 7 Administration

Upgrade the Router Firmware	73
View Router Status	74
Router Information	74
Internet Port	74
Wireless Settings (2.4 GHz and 5 GHz)	77
Guest Network (2.4 GHz and 5 GHz)	78
View Logs of Web Access or Attempted Web Access	78
Manage the Configuration File	79

N300 Personal Router PR2000

Back Up Settings	80
Restore Configuration Settings	80
Erase	80
Set Password	81
Password Recovery	81

Chapter 8 Advanced Settings

Advanced Wireless Settings	84
Wireless Repeating Function (WDS)	85
Wireless Repeating Function	86
Set Up the Base Station	87
Set Up a Repeater Unit	88
Port Forwarding and Port Triggering	89
Remote Computer Access Basics	89
Port Triggering to Open Incoming Ports	90
Port Forwarding to Permit External Host Communications	91
How Port Forwarding Differs from Port Triggering	92
Set Up Port Forwarding to Local Servers	93
Add a Custom Service	94
Edit or Delete a Port Forwarding Entry	95
Set Up Port Triggering	95
Dynamic DNS	97
Static Routes	98
Remote Management	100
USB Settings	101
Universal Plug and Play	101
IPv6	103
Traffic Meter	103

Chapter 9 Troubleshooting

Quick Tips	106
Sequence to Restart Your Network	106
Check Ethernet Cable Connections	106
Wireless Settings	106
Network Settings	106
Troubleshoot with the LEDs	107
Power/Test LED Is Off or Blinking	107
Power/Test LED Stays Amber	107
LEDs Never Turn Off	107
Internet or Ethernet Port LEDs Are Off	108
Wireless LEDs Are Off	108
The Push 'N' Connect (WPS) Button Blinks Green	108
Cannot Log In to the Router	108
Cannot Access the Internet	109
Troubleshoot PPPoE	110
Troubleshoot Internet Browsing	111
Changes Not Saved	111

N300 Personal Router PR2000

Incorrect Date or Time	112
Wireless Connectivity	112
Wireless Signal Strength	112
Restore the Factory Settings and Password	113
Troubleshoot Your Network Using the Ping Utility	113
Test the LAN Path to Your Router	113
Test the Path from Your Computer to a Remote Device	114

Appendix A Supplemental Information

Factory Settings	115
Technical Specifications	117

Appendix B Notification of Compliance

Index

Hardware Setup

1

Getting to know your router

The N300 Personal Router PR2000 provides you with an easy and secure way to set up a wireless home network with fast access to the Internet over a high-speed digital subscriber line (DSL) or a cable broadband service provider. It is compatible with all major DSL Internet service providers and cable broadband service providers, lets you block unsafe Internet content and applications, and protects the devices (computers, gaming consoles, and so on) that you connect to your home network.

Note: For more information about the topics covered in this manual, visit the support website at <http://support.netgear.com>.

If you have not already set up your new router using the installation guide that comes in the box, this chapter walks you through the hardware setup. *Chapter 3, genie Basic Settings*, explains how to set up your Internet connection.

This chapter contains the following sections:

- *Unpack Your Router*
- *Position Your Router*
- *Hardware Features*
- *Get Started*
- *Connect to the Internet with a Wired WAN Connection*
- *Connect to the Internet with a Wireless WAN Connection*
- *Connect Wireless Devices to the PR2000 Unit*

Unpack Your Router

Open the box and remove the router and installation guide.

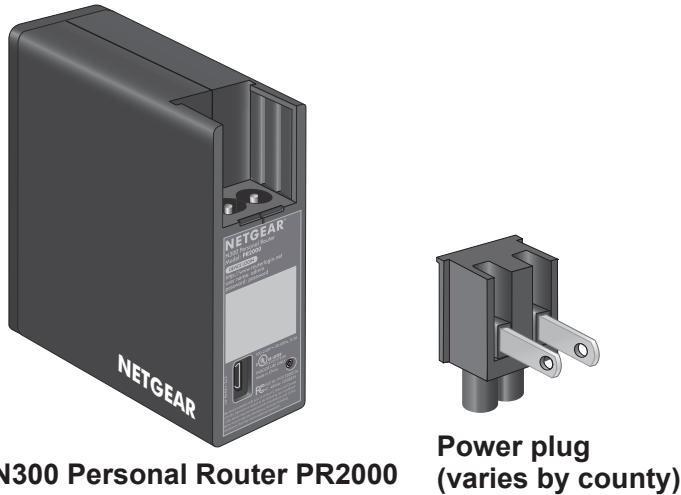

Figure 1. Package contents

Your box should contain the following items:

- N300 Personal Router PR2000
- Power plug (varies by country)
- Installation guide with cabling and router setup instructions

If any parts are incorrect, missing, or damaged, contact your NETGEAR dealer. Keep the carton and original packing materials, in case you need to return the product for repair.

Position Your Router

The router lets you access your network from anywhere within the operating range of your wireless network. However, the operating distance or range of your wireless connection can vary significantly depending on the physical placement of your router. For example, the thickness and number of walls the wireless signal passes through can limit the range. For best results, place your router:

- Near the center of the area where your computers and other devices operate and preferably within line of sight to your wireless devices.
- So it is accessible to an AC power outlet and near Ethernet cables for wired computers.
- In an elevated location such as a high shelf, keeping the number of walls and ceilings between the router and your other devices to a minimum.
- Away from electrical devices that are potential sources of interference, such as ceiling fans, home security systems, microwaves, computers, or the base of a cordless phone or 2.4 GHz or 5 GHz cordless phone.

N300 Personal Router PR2000

- Away from any large metal surfaces, such as a solid metal door or aluminum studs. Large expanses of other materials such as glass, insulated walls, fish tanks, mirrors, brick, and concrete can also affect your wireless signal.

When you use multiple access points, it is better if adjacent access points use different radio frequency channels to reduce interference. The recommended channel spacing between adjacent access points is 5 channels (for example, use Channels 1 and 6, or 6 and 11).

Prepare the Router

To ensure proper heat dissipation and for router stability, it is important that you connect the stand and place your router in an upright position.

➤ **To prepare your router for installation:**

1. Carefully peel off the protective film covering the end of your router.

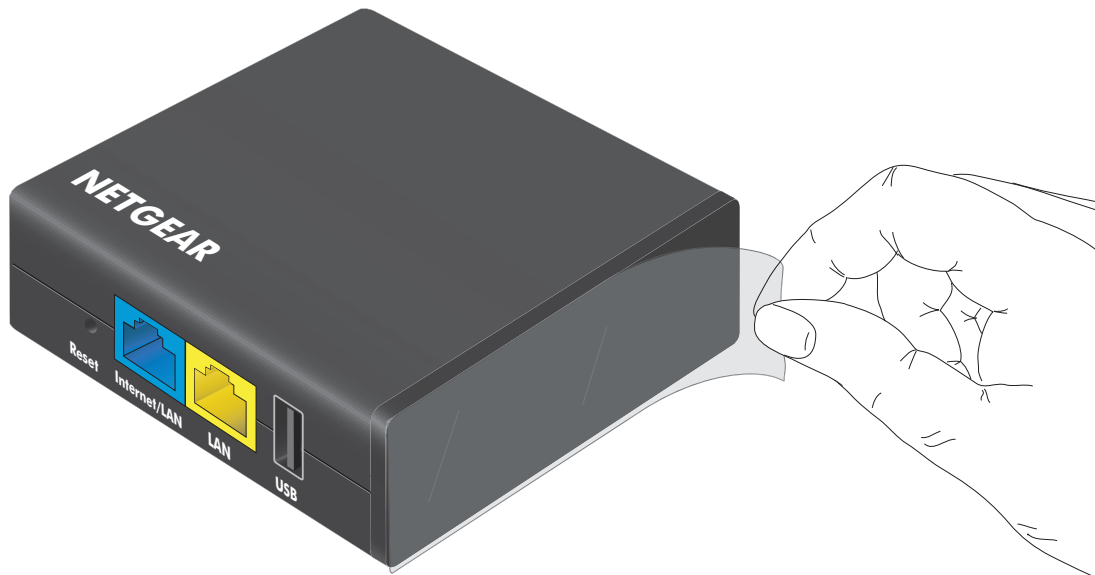

N300 Personal Router PR2000

2. If necessary, change the power plug to one that is compatible with the power outlets in your location.

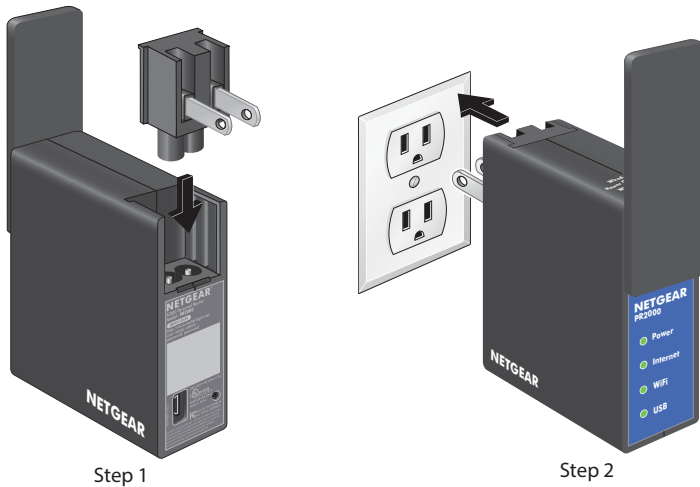
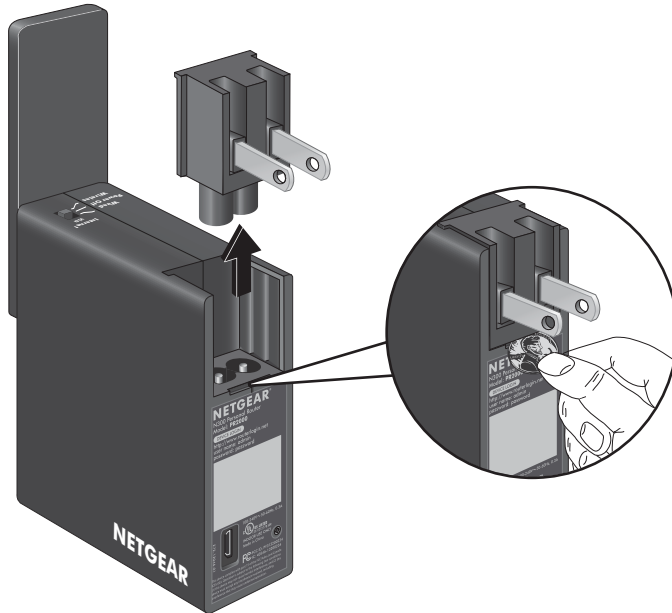

Step 1

Step 2

3. Place your router in an area suitable for installation (near an AC power outlet and accessible to the Ethernet cables for your wired computers).

Hardware Features

The PR2000 provides the following hardware features: Internet Mode switch, indicator LEDs, connection ports and reset button, power inputs, and product label.

Internet Mode Switch

Use the switch at the top of the PR2000 unit to set the PR2000 Internet mode.

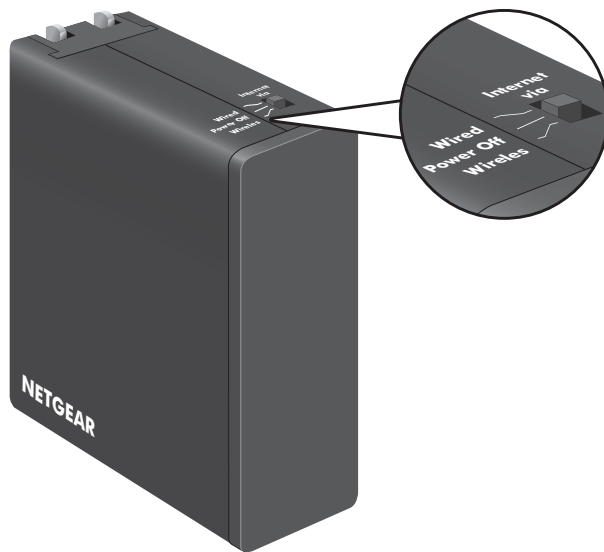

Figure 2. Internet Mode switch

The Internet Mode switch has the following settings:

- **Wired.** Establish an Internet connection with an Ethernet cable, including the Router and Access Point (AP) modes of the PR2000 unit.
- **Power off.** Turn the PR2000 unit off.
- **Wireless.** Establish an Internet connection with either WiFi or an ISP dongle, including the Repeater, Wireless WAN (hotspot), and ISP USB dongle modes of the PR2000 unit.

Indicator LEDs

Open the side cover to view the indicator LEDs.





Figure 3. Indicator LEDs

These LEDs show how the PR2000 unit is working.

LED	Description
Power	Solid green. The router is on.
 Power	Blinking green. The router is being reset to its factory defaults.
	Off. The router is off.

N300 Personal Router PR2000

LED	Description
	Green. The Internet is available from either WiFi, Ethernet, or an ISP USB dongle.
	Off. The Internet is not available.
	Green. A wireless device is connected to the router.
	Off. No device is attached to the router.
	Green. The USB drive is properly mounted.
	Off. No USB drive is detected.

Connection Ports and Reset Button

View the connection ports and reset button on the bottom of the PR2000 unit.

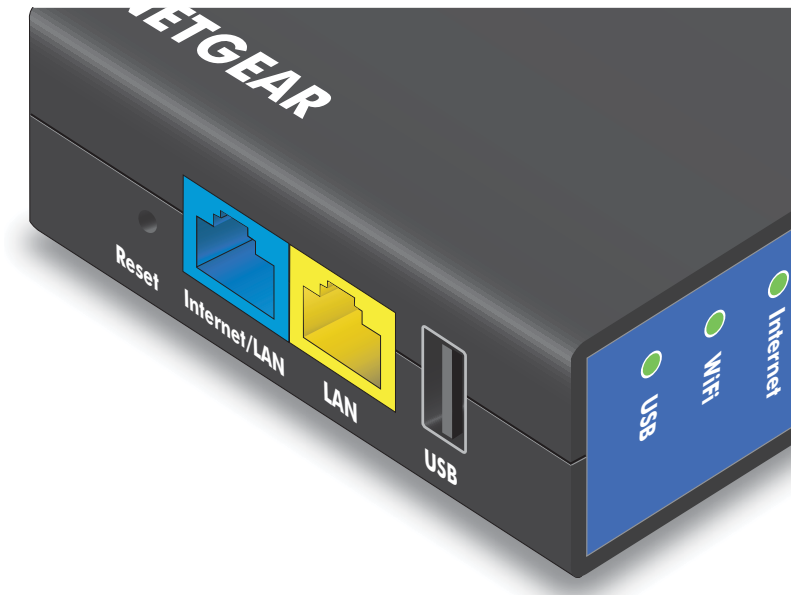

Figure 4. Connection ports and reset button

The connection ports and reset button perform the following functions:

- **Reset button.** To reset the PR2000 unit to its factory settings, insert a paper clip into the reset hole and hold it until the Power LED flashes.
See [Factory Settings](#) on page 115 for information about restoring factory settings.
- **Internet/LAN port.** Use the Ethernet port for an Internet connection in Router mode or Ethernet-enabled device in other modes.

N300 Personal Router PR2000

- **LAN port.** Use the LAN port for any Ethernet-enabled device.
- **USB port.** Use the USB port for USB storage or printer. When wall-plugged, the port can be used as a cell phone charger.

Power Inputs

You can power the PR2000 unit with either AC current from a wall socket or a micro USB connection.

AC Power Connection

Insert the power prongs into the PR2000 unit and then plug the unit into an AC wall plug.

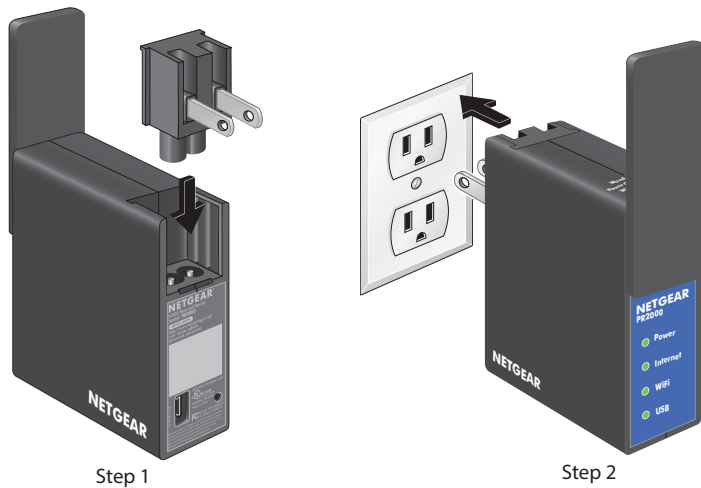

Figure 5. AC power connection

micro USB Connection

Connect a micro USB cable to the PR2000 unit and to a USB port on another device.

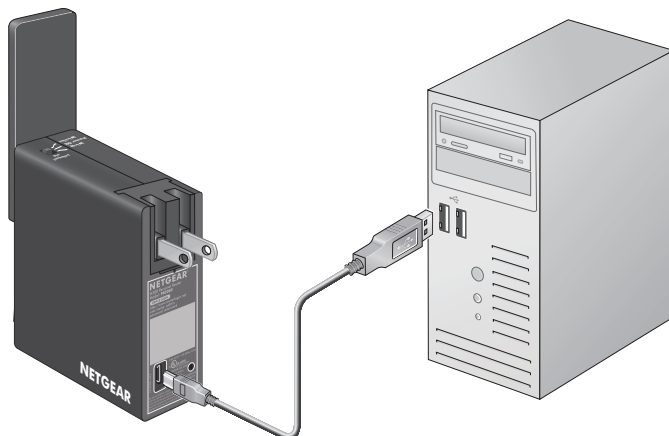

Figure 6. Micro USB power connection

Product Label

The device login information (URL, user name, and password), SSID, and wireless password are printed on the product label. The product label is on the side of the unit.

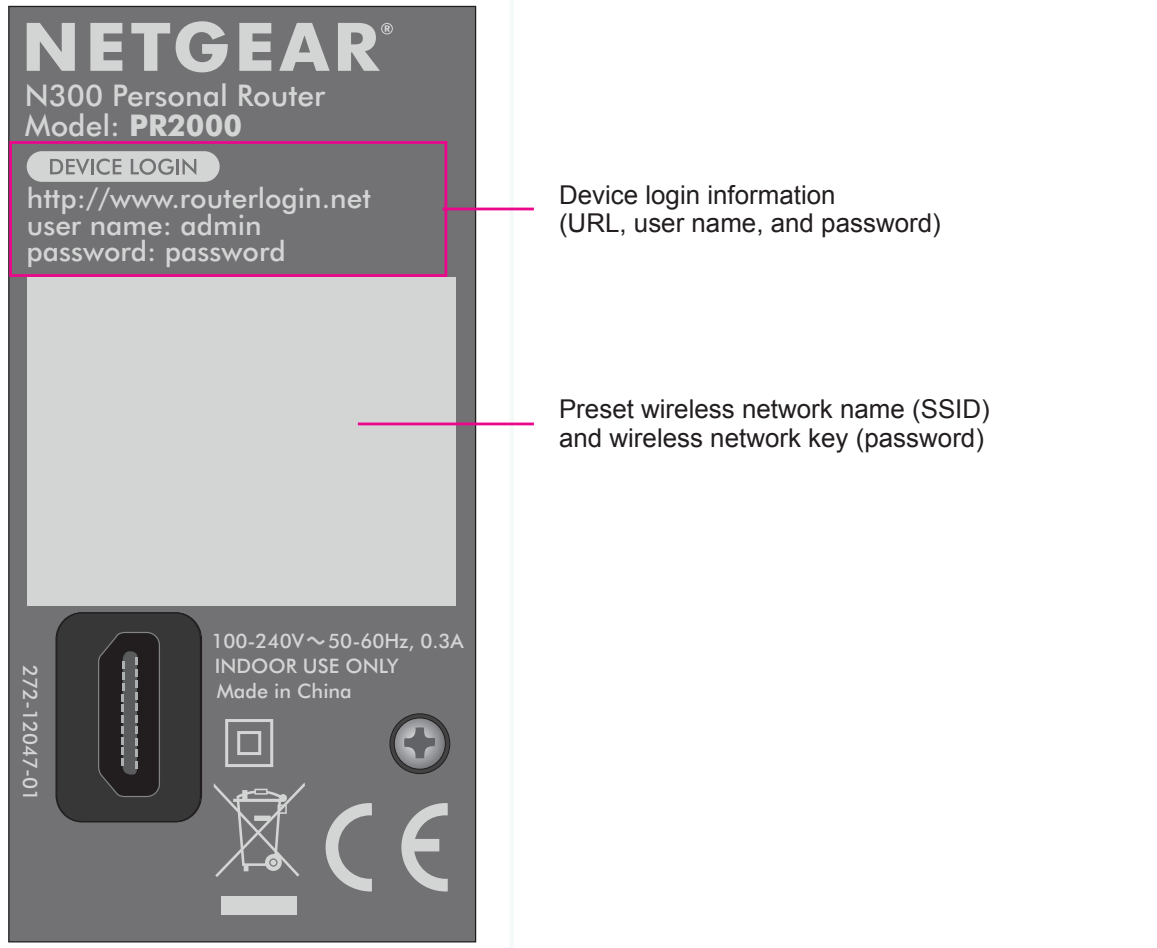

Figure 7. Product label

Get Started

You can connect the PR2000 unit to the Internet with either a wired or wireless WAN connection. You can connect wireless devices such as desktops, laptops, tablets, and cell phones to the PR2000 unit.

➤ **To set up connections with the PR2000 unit:**

1. Set up the Internet connection to the PR2000 unit.
 - **Wired WAN connection.** Set up a wired WAN connection to the Internet using the Ethernet WAN port.
For more information, see [Connect to the Internet with a Wired WAN Connection](#) on page 16.
 - **Wireless WAN connection.** Set up a wireless WAN connection to the Internet using either a WiFi or ISP mobile broadband link.
For more information, see [Connect to the Internet with a Wireless WAN Connection](#) on page 18.
2. (Optional) Connect your wireless devices to the PR2000 unit.
For more information, see [Connect Wireless Devices to the PR2000 Unit](#) on page 22.
3. (Optional) Connect a USB printer to the PR2000 USB port.
For more information, see the *N300 Personal Router PR2000 User Manual*.

Connect to the Internet with a Wired WAN Connection

You can connect to the Internet with a wired WAN connection.

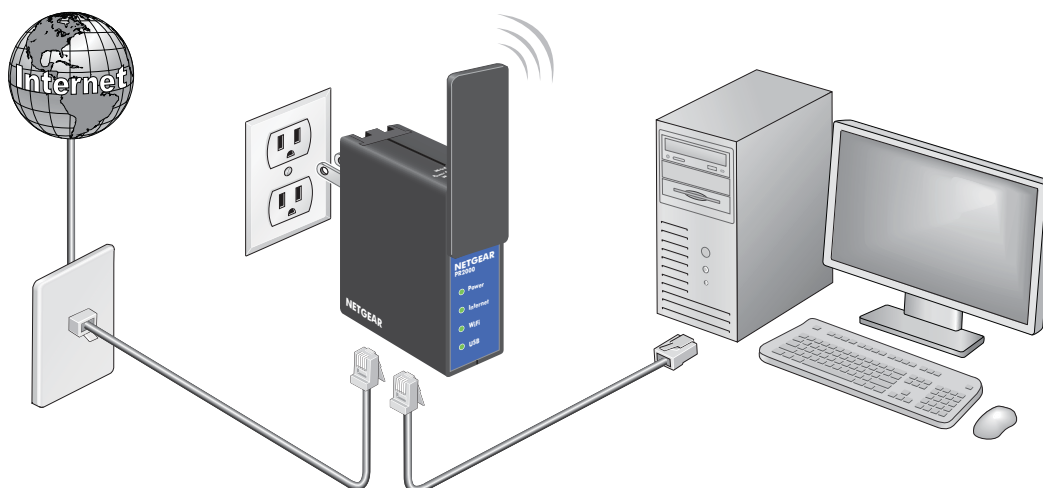

Figure 8. Wired WAN connection

N300 Personal Router PR2000

➤ To connect to the Internet with a wired WAN connection:

1. Use an Ethernet cable to connect the PR2000 Ethernet WAN port to the Ethernet port of your Internet service.
2. Use an Ethernet cable to connect the PR2000 Ethernet LAN port to the Ethernet port of your computer.
3. Connect the PR2000 unit to a power source.

You can connect the PR2000 unit either to an AC wall outlet or a micro USB power cable.

4. Turn on the power to the PR2000 unit.
Move the Internet Mode switch from the Off position to the Wired position.
5. Open a web browser, type **www.routerlogin.net** in the address field, and press the enter key.
6. In the resulting screen that displays, enter **admin** for your user name and **password** for your password.
7. Click **OK**.

A screen similar to the following one displays:

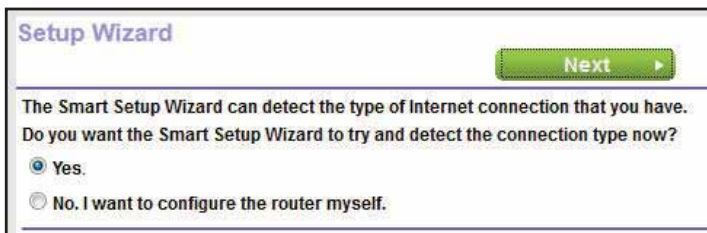

8. To use the Setup Wizard to configure your Internet connection, select **Yes** and click **Next**.

A screen similar to the following one displays when you are connected to the Internet:



9. (Optional) Connect your wireless devices to the PR2000 unit.

For more information, see [Connect Wireless Devices to the PR2000 Unit](#) on page 22.

Connect to the Internet with a Wireless WAN Connection

The wireless mode is exclusive from the wired mode because you move the Internet Mode switch from the off position to the Wireless position.

In wireless mode, you can use the PR2000 unit as a WiFi connection to a wireless network in a WiFi hot spot zone, a wireless repeater to extend the range of your personal wireless network, or an ISP mobile broadband link to your Internet service provider.



Figure 9. Wireless WAN connection

➤ **To connect to the Internet with a wireless WAN connection:**

1. Connect the PR2000 unit to a power source.
You can connect the PR2000 unit either to an AC wall outlet or a micro USB power cable.
2. Turn on the power to the PR2000 unit.
Move the Internet Mode switch from the Off position to the Wireless position.
3. Connect your wireless computer to the PR2000 unit.
Use the preset wireless network name (SSID) and wireless network key (password) on the product label.
4. Open a web browser, type **www.routerlogin.net** in the address field, and press the enter key.
5. In the resulting screen that displays, enter **admin** for your user name and **password** for your password.
6. Click **OK**.

N300 Personal Router PR2000

A screen similar to the following one displays that shows the available wireless networks:

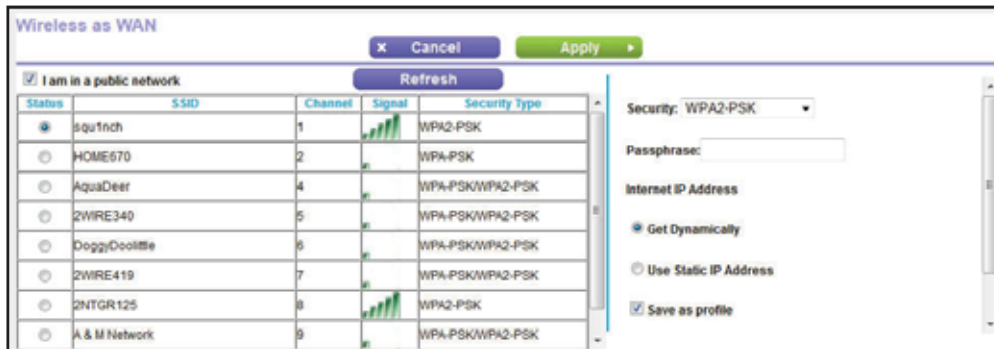

7. Select the wireless network that you want to connect to and enter the related security information for that wireless network.
8. Click **Apply**.

A screen similar to the following one displays when you are connected to the Internet:



9. You can connect to the Internet using any of the following wireless modes:
 - **Wireless WAN.** You can save money while sitting in a WiFi hot spot zone. Usually the Wireless Internet Service Provider (WISP) charges for WiFi usage at every single log-in. With the PR2000 Wireless WAN mode, your personal devices can connect to the Internet with the PR2000 unit for only a one-time charge.
 - **Wireless repeater.** You can extend the range of your personal wireless network.
 - Use the PR2000 unit to connect your wireless devices that are outside the range of your personal wireless network. For more information, see [Use the PR2000 Unit as a Wireless Repeater](#) on page 20.
 - Use the Ethernet ports on the PR2000 unit to connect up to two of your Ethernet-enabled devices wirelessly to your network. For more information, see [Use the PR2000 Unit as a Two-Port WiFi Adapter](#) on page 21.
 - **ISP USB dongle.** You can use the USB port on the PR2000 unit to make an ISP mobile broadband connection to your Internet service provider.

For more information, see [Use the PR2000 Unit as a Mobile Broadband Router](#) on page 22.

Use the PR2000 Unit as a Wireless Repeater

You can use the PR2000 unit as a repeater to connect your wireless devices that are outside the range of your personal wireless network.

NETGEAR recommends that you connect to the wireless network of the PR2000 unit only when a computer or wireless device is in a dead zone where the network connection to your existing router is very poor or nonexistent.

➤ **To use the PR2000 unit as a wireless repeater:**

1. Place the PR2000 unit at an equal distance between your wireless router and the wireless device that is located outside the range of your router.

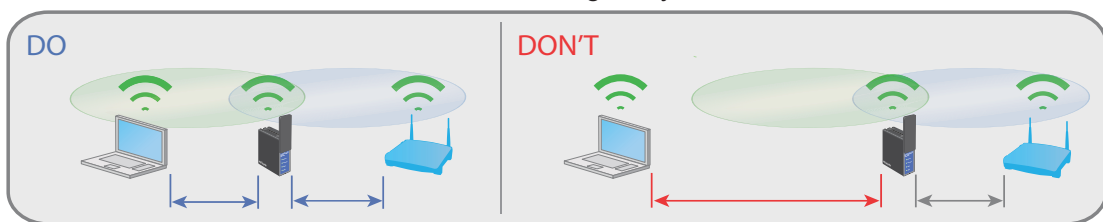

When possible, configure the PR2000 unit and router in the same room.

2. Open a web browser, type **www.routerlogin.net** in the address field, and press the enter key.
3. In the resulting screen that displays, enter **admin** for your user name and **password** for your password.
4. Click **OK**.

A screen similar to the following one displays that shows the available wireless networks:

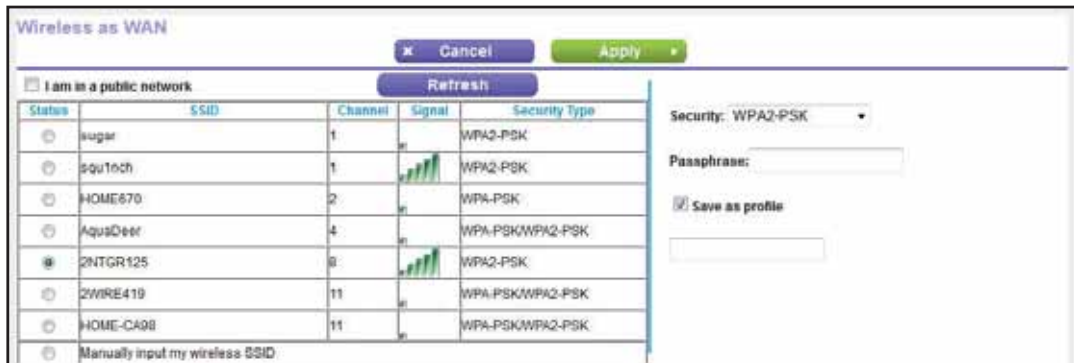

5. Make sure that the **I am in a public network** check box is not selected.
6. Select the wireless network that you want to connect to and enter the related security information for that wireless network.
7. Click **Apply**.

The PR2000 unit is configured as a wireless repeater.

8. (Optional) You can use the PR2000 unit as a two-port WiFi adapter.

For more information, see [Use the PR2000 Unit as a Two-Port WiFi Adapter](#) on page 21.

Use the PR2000 Unit as a Two-Port WiFi Adapter

Once the PR2000 unit is connected to your existing WiFi network as a wireless repeater, you can use the Ethernet ports on the PR2000 unit to connect up to two Ethernet-enabled devices wirelessly to your network.

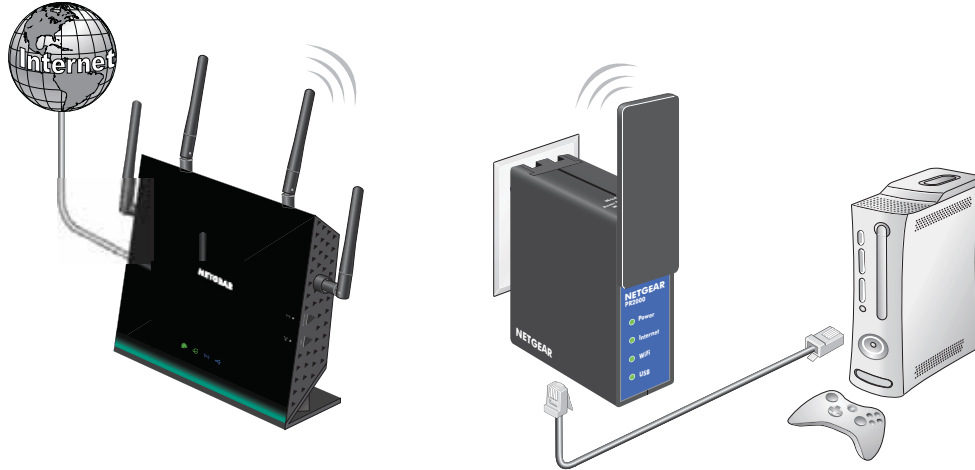

Figure 10. Two-port WiFi adapter

Simply plug the Ethernet cable from your Ethernet-enabled device (such as a connected TV, Blu-ray player, or a gaming console) to one of the Ethernet ports of the PR2000 unit and enjoy wireless connectivity.

Use the PR2000 Unit as a Mobile Broadband Router

You can make an ISP mobile broadband WAN connection to your Internet service provider. You must have a valid ISP USB dongle that is connected to the USB port of the PR2000 unit. Contact your Internet service provider for more information.

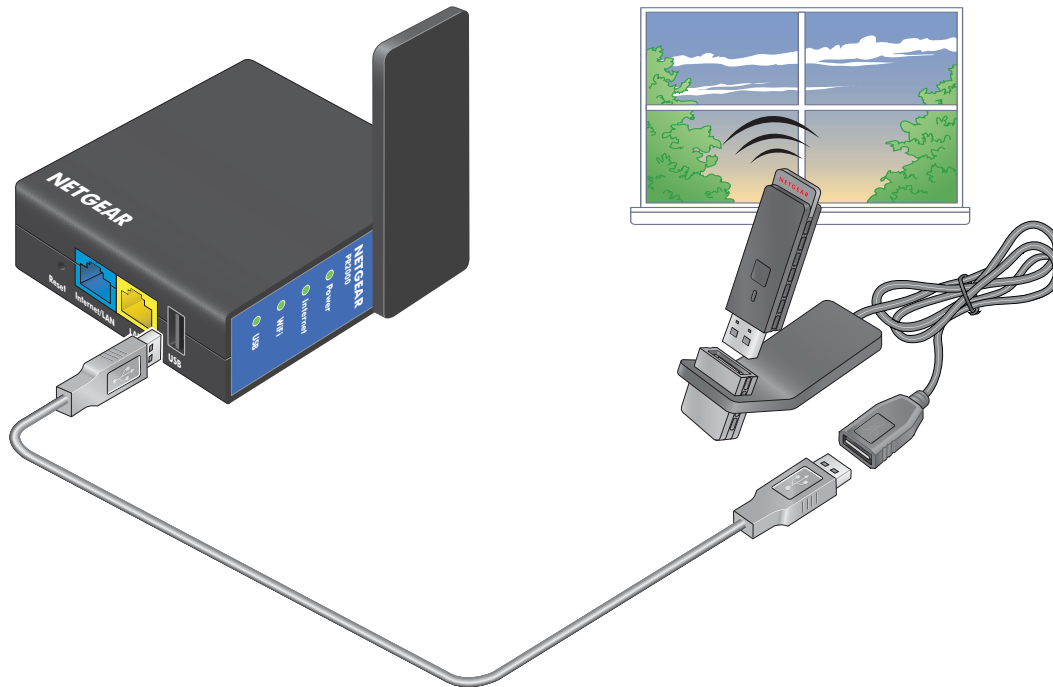

Figure 11. Mobile broadband connection

Connect Wireless Devices to the PR2000 Unit

Use the preset wireless network name (SSID) and wireless network key (password) to connect wireless devices such as desktop, laptops, cell phones, and tablets to the PR2000 unit. The SSID and password are on the product label.

2 Getting Started with NETGEAR genie

2

Connecting to the router

This chapter explains how to use NETGEAR genie to set up your router after you complete cabling as described in the installation guide and in the previous chapter in this book.

This chapter contains the following sections:

- *Router Setup Preparation*
- *Types of Logins and Access*
- *NETGEAR genie Setup*
- *Use NETGEAR genie after Installation*
- *Upgrade Router Firmware*
- *Router Dashboard (Basic Home Screen)*
- *Add Wireless Devices or Computers to Your Network*

Router Setup Preparation

You can set up your router with the NETGEAR genie automatically, or you can use the Genie menus and screens to set up your router manually. However, before you start the setup process, you need to have your ISP information on hand and make sure the laptops, PCs, and other devices in the network have the settings described here.

Use Standard TCP/IP Properties for DHCP

If you set up your computer to use a static IP address, you need to change the settings so that it uses Dynamic Host Configuration Protocol (DHCP).

Gather ISP Information

If you have DSL broadband service, you might need the following information to set up your router and to check that your Internet configuration is correct. Your Internet service provider (ISP) should have provided you with all of the information needed to connect to the Internet. If you cannot locate this information, ask your ISP to provide it. When your Internet connection is working, you no longer need to launch the ISP login program on your computer to access the Internet. When you start an Internet application, your router automatically logs you in.

- The ISP configuration information for your DSL account
- ISP login name and password
- Fixed or static IP address settings (special deployment by ISP)

Wireless Devices and Security Settings

Make sure that the wireless device or computer that you are using supports WPA or WPA2 wireless security, which is the wireless security supported by the router. See [Basic Wireless Settings](#) on page 36 for information about the router's preconfigured security settings.

Types of Logins and Access

There are two separate types of logins that have different purposes. It is important that you understand the difference so that you know which login to use when.

- **Router login** logs you in to the router interface from NETGEAR genie. See [Use NETGEAR genie after Installation](#) on page 25 for details about this login.
- **ISP login** logs you in to your Internet service. Your service provider provided you with this login information in a letter or some other way. If you cannot find this login information, contact your service provider.
- **Wireless network key or password.** Your router is preset with a unique wireless network name (SSID) and password for wireless access. This information is on the label at the bottom of your router.

NETGEAR genie Setup

NETGEAR genie runs on any device with a web browser. It is the easiest way to set up the router because it automates many of the steps and verifies that those steps have been successfully completed. It takes about 15 minutes to complete.

Using NETGEAR genie to set up your router:

1. Turn on the router by pressing the **On/Off** button.
2. Make sure that your device is connected with an Ethernet cable to your router.
3. Launch your Internet browser.
 - The first time you set up the Internet connection for your router, the browser automatically goes to **http://www.routerlogin.net**, and the NETGEAR genie screen displays.
 - If you already used the NETGEAR genie, type **http://www.routerlogin.net** in the address field for your browser to display the NETGEAR genie screen. See *Use NETGEAR genie after Installation* on page 25.
4. Follow the instructions on the screen to complete the NETGEAR genie setup. NETGEAR genie guides you through connecting the router to the Internet.

If the browser cannot display the web page:

- Make sure that the computer is connected to one of the four LAN Ethernet ports, or wirelessly to the router.
- Make sure that the router is up and running. Its Wireless LEDs should turn on.
- Close and reopen the browser to make sure that the browser does not cache the previous page.
- Browse to **http://www.routerlogin.net**.
- If the computer is set to a static or fixed IP address (this is uncommon), change it to obtain an IP address automatically from the router.

If the router does not connect to the Internet:

1. Review your settings to be sure that you have selected the correct options and typed everything correctly.
2. Contact your ISP to verify that you have the correct configuration information.
3. Read *Chapter 9, Troubleshooting*. If problems persist, register your NETGEAR product and contact NETGEAR technical support.

Use NETGEAR genie after Installation

When you first set up your router, NETGEAR genie automatically starts when you launch an Internet browser on a computer that is connected to the router. You can use NETGEAR Genie again to view or change settings for the router.

1. Launch your browser from a computer or wireless device that is connected to the router.
2. Type <http://www.routerlogin.net> or <http://www.routerlogin.com>.

The login window displays:



The screenshot shows a login dialog box with a light beige background. It contains two input fields: 'User name:' with a dropdown menu showing 'admin' and a 'Password:' field with asterisks. Below the password field is a checkbox labeled 'Remember my password'. At the bottom are 'OK' and 'Cancel' buttons.

3. Enter **admin** for the router user name and **password** for the router password, both in lowercase letters.

Note: *The router user name and password are different from the user name and password for logging in to your Internet connection. See [Types of Logins and Access](#) on page 24 for more information.*

Upgrade Router Firmware

When you set up your router and are connected to the Internet, the router automatically checks for you to see if newer firmware is available. If it is, a message is displayed on the top of the screen. See [Upgrade the Router Firmware](#) on page 73 for more information about upgrading firmware.

Click the message when it shows up, and click **Yes** to upgrade the router with the latest firmware. After the upgrade, the router restarts.



CAUTION:

Do not try to go online, turn off the router, shut down the computer, or do anything else to the router until the router finishes restarting and the Power LED has stopped blinking for several seconds.

Router Dashboard (Basic Home Screen)

The router Basic Home screen has a dashboard that lets you see the status of your Internet connection and network at a glance. You can click any of the six sections of the dashboard to

view more detailed information. The left column has the menus. At the top is an Advanced tab that is used to access more menus and screens.

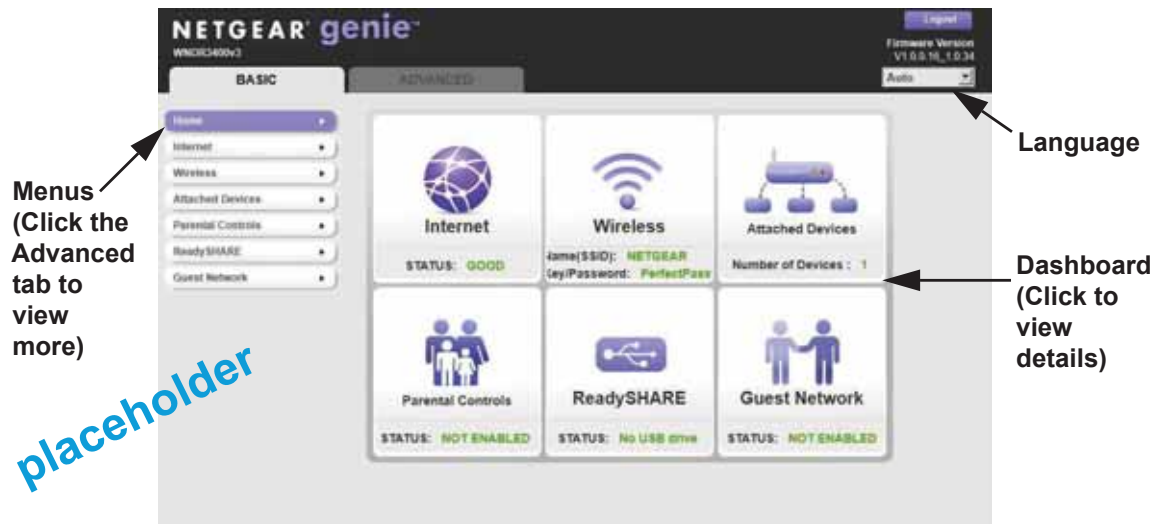

Figure 12. Router Basic Home screen with dashboard, language, and online help

- **Home.** This dashboard screen displays when you log in to the router.
- **Internet.** Set, update, and check the ISP settings of your router.
- **Wireless.** View or change the wireless settings for your router.
- **Attached Devices.** View the devices connected to your network.
- **Parental Controls.** Download and set up parental controls to prevent objectionable content from reaching your computers.
- **ReadySHARE.** If you connected a USB storage device to the router it is displayed here.
- **Guest Network.** Set up a guest network to allow visitors to use your router's Internet connection.
- **Advanced tab.** Set the router up for unique situations such as when remote access by IP or by domain name from the Internet is needed. See *Chapter 8, Advanced Settings*. Using this tab requires a solid understanding of networking concepts.
- **Help & Support.** Go to the NETGEAR support site for information, help, and product documentation. These links work once you have an Internet connection.

Add Wireless Devices or Computers to Your Network

Choose either the manual or the WPS method to add wireless devices and other equipment to your wireless network. For instructions on setting up a guest network, See *Guest Networks* on page 39.

Manual Method

➤ **To connect manually:**

1. Open the software that manages your wireless connections on the wireless device (laptop computer, gaming device, iPhone) that you want to connect to your router. The software scans for all wireless networks in your area.
2. Look for your network and select it. If you did not change the name of your network during the setup process, look for the default WiFi network name (SSID) and select it. The default SSID is on the product label on the bottom of the router.
3. Enter the router password and click **Connect**. The default router password is on the product label on the bottom of the router.
4. Repeat steps 1–3 to add other wireless devices.

Wi-Fi Protected Setup (WPS) Method

Wi-Fi Protected Setup (WPS) is a standard for easily adding computers and other devices to a home network while maintaining security. To use WPS, make sure that all wireless devices to be connected to the network are Wi-Fi certified and support WPS. During the connection process, the client gets the security settings from the router so that every device in the network has the same security settings.

➤ **To use WPS to join the wireless network:**

If your wireless device supports WPS (Push 'N' Connect), follow these steps:

1. Press the **WPS** button on the router  until the LED status changes.
2. Within 2 minutes, press the **WPS** button on your wireless device, or follow the WPS instructions that came with the device. The device is now connected to your router.
3. Repeat steps 1–2 to add other WPS wireless devices.

genie Basic Settings

3

Your Internet connection and network

This chapter explains the features available from the genie Basic Home screen, shown in the following figure:



This chapter contains the following sections:

- *Internet Setup*
- *Attached Devices*
- *Parental Controls*
- *ReadySHARE USB Storage*
- *Basic Wireless Settings*
- *Guest Networks*

Internet Setup

The Internet Setup screen is where you view or change ISP information.

1. From the Home screen, select **Internet**. The following screen displays:

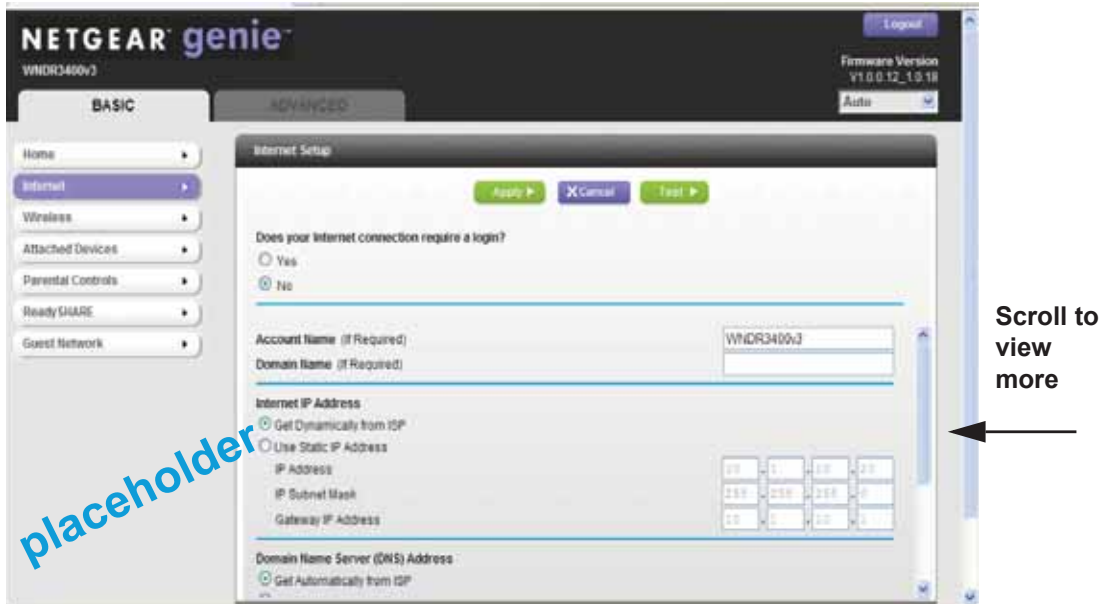

The fields that display in the Internet Setup screen depend on whether your Internet connection requires a login.

- **Yes.** Select the encapsulation method and enter the login name. If you want to change the login time-out, enter a new value in minutes.
 - **No.** Enter the account and domain names, only if needed.
2. Enter the settings for the IP address and DNS server. The default settings usually work fine. If you have problems with your connection, check the ISP settings.
 3. Click **Apply** to save your settings.
 4. Click **Test** to test your Internet connection. If the NETGEAR website does not display within 1 minute, see [Chapter 9, Troubleshooting](#).

Internet Setup Screen Fields

The following descriptions explain all of the possible fields in the Internet Setup screen. The fields which display in this screen depend on whether an ISP login is required.

Does Your ISP Require a Login? Answer either yes or no.

These fields display when no login is required:

- **Account Name (If required).** Enter the account name provided by your ISP. This might also be called the host name.
- **Domain Name (If required).** Enter the domain name provided by your ISP.

These fields display when your ISP requires a login:

- **Internet Service Provider Encapsulation.** ISP types. The choices are PPPoE, PPTP, or L2TP.
- **Login.** The login name provided by your ISP. The login name is usually an email address.
- **Password.** The password that you use to log in to your ISP.
- **Service Name (If Required).** If your ISP provided a service name, enter it here. Otherwise, you can leave this field blank.
- **Connection Mode.** This specifies when the router should establish the PPPoE connection. Currently the connection mode is *always on* to provide a steady IPv6 connection. The router never disconnects the connection, and in case the connection is broken (such as if the modem is turned off), the router establishes the connection right after the PPPoE connection is available.
- **Idle Timeout (In minutes).** If you want to change the login time-out, enter a new value in minutes. This value determines how long the router keeps the Internet connection active after there is no Internet activity from the LAN. Entering a value of 0 (zero) means never log out.

Internet IP Address.

- **Get Dynamically from ISP.** Your ISP uses DHCP to assign your IP address. Your ISP automatically assigns these addresses.
- **Use Static IP Address.** Enter the IP address, IP subnet mask, and the gateway IP address that your ISP assigned. The gateway is the ISP router to which your router connects.

Domain Name Server (DNS) Address. The DNS server is used to look up site addresses based on their names.

- **Get Automatically from ISP.** Your ISP uses DHCP to assign your DNS servers. Your ISP automatically assigns this address.
- **Use These DNS Servers.** If you know that your ISP does not automatically transmit DNS addresses to the router during login, select this option, and enter the IP address of your ISP primary DNS server. If a secondary DNS server address is available, enter it also.

Router MAC Address. The Ethernet MAC address used by the router on the Internet port. Some ISPs register the MAC address of the network interface card in your computer when your account is first opened. They accept traffic only from the MAC address of that computer. This feature allows your router to use your computer's MAC address (this is also called cloning).

- **Use Default Address.** Use the default MAC address.
- **Use Computer MAC Address.** The router captures and uses the MAC address of the computer that you are now using. You have to use the one computer allowed by the ISP.
- **Use This MAC Address.** Enter the MAC address that you want to use.

Attached Devices

You can view a list of all computers or devices that are currently connected to your network here. From the Basic Home screen, select **Attached Devices** to display the following screen:



Wired devices are connected to the router with Ethernet cables. Wireless devices have joined the wireless network.

- **#** (number). The order in which the device joined the network.
- **IP Address**. The IP address that the router assigned to this device when it joined the network. This number can change if a device is disconnected and rejoins the network.
- **Device Name**. If the device name is known, it is shown here.
- **MAC Address**. The unique MAC address for each device does not change. The MAC address is typically shown on the product label.

You can click **Refresh** to update this screen.

Parental Controls

The first time you select Parental Controls from the Basic Home screen, your browser goes to the Parental Controls website. You can learn more about Live Parental Controls or download the application.

➤ **To set up Live Parental Controls:**

1. Select **Parental Controls** on the Home (dashboard) screen:



placeholder

Live Parental Controls uses free OpenDNS accounts. If you do not have one, you can create one now.

2. Log in to manage Parental Controls settings..



placeholder

3. Click either the **Windows Users** or **Mac Users** button.
4. Follow the on screen instructions to download and install the NETGEAR Live Parental Controls Management utility.

N300 Personal Router PR2000

After installation, Live Parental Controls automatically starts.

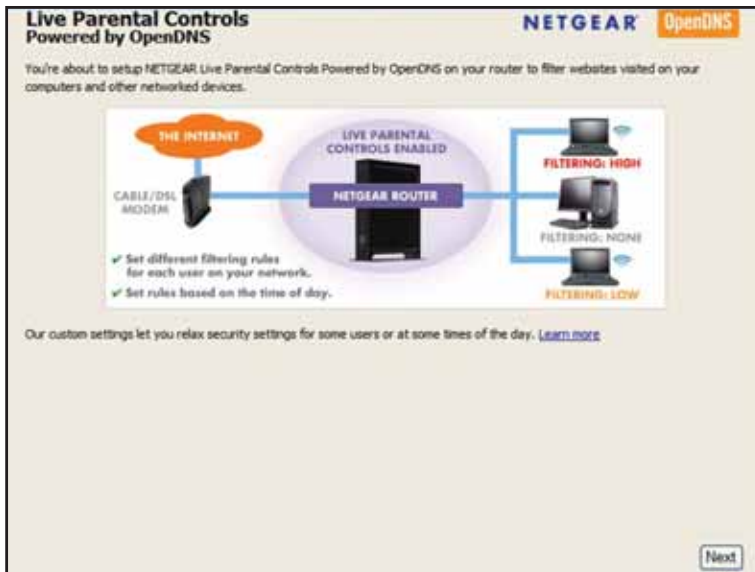

5. Click **Next**, read the note, and click **Next** again to proceed.

You are prompted to log in or create a free account..

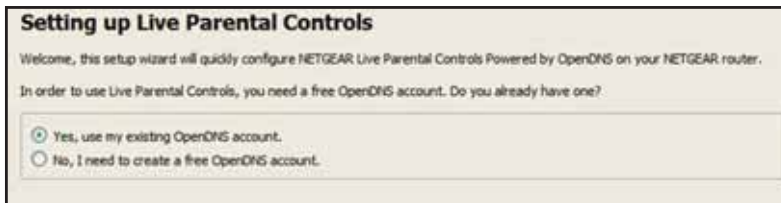

6. Select the radio button that applies to you and click **Next**.
 - If you already have an OpenDNS account, leave the **Yes** radio button selected.
 - If you do not have an OpenDNS account, select the **No** radio button.

After you log on or create your account, the filtering level screen displays:



7. Select the radio button for the filtering level that you want and click **Next**.



placeholder

8. Click the **Take me to the status screen** button.

Parental controls are now set up for the router. The dashboard shows Parental Controls as enabled.

ReadySHARE USB Storage

You can view information about a USB storage device that is connected to the router's USB port here. From the Basic Home screen, select **ReadySHARE** to display the USB Storage (Basic Settings) screen:

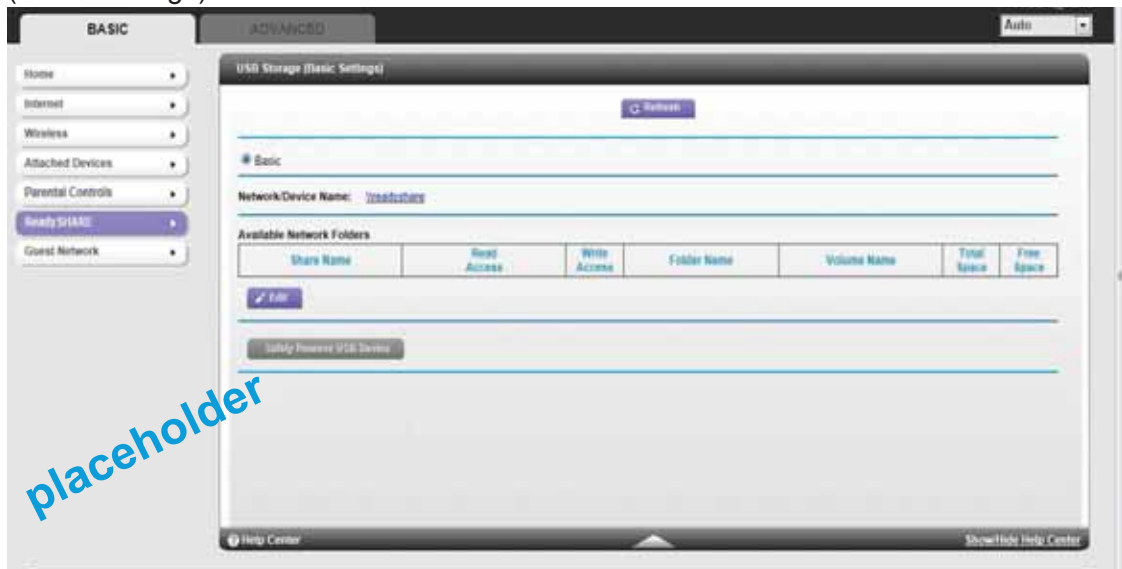

This screen displays the following:

- **Network/Device Name.** The name used to access the USB device connected to the router. The default is \\readyshare.
- **Available Network Folders.** The folders on the USB device.
 - Share Name.** If only one device is connected, the default share name is USB_Storage. You can click the name shown, or you can type it in the address field of your web browser.

If Not Shared is shown, the default share was deleted and no other share for the root folder exists. Click the link to change this setting.

Read Access and Write Access. Shows the permissions and access controls on the network folder: All – no password (the default) allows all users to access the network folder. The user name (account name) for All – no password is guest. The password for admin is the same one that you use to log in to the router. By default, it is password.

Folder Name. Full path used by the network folder.

Volume Name. Volume name from the storage device (either USB drive or HDD).

Total Space and Free Space. Shows the current utilization of the storage device.

- **Edit.** Click the **Edit** button to edit the Available Network Folders settings.
- **Safely Remove a USB Device.** Click to safely remove the USB device attached to your router.

You can click **Refresh** to update this screen.

For more information about USB storage, see [Chapter 5, USB Storage](#).

Basic Wireless Settings

The Wireless Setup screen lets you view or configure the wireless network setup.

The N300 Personal Router comes with preset security. This means that the WiFi network name (SSID), network key (password), and security option (encryption protocol) are preset in the factory. You can find the preset SSID and password on the bottom of the unit.

Note: The preset SSID and password are uniquely generated for every device to protect and maximize your wireless security.

NETGEAR recommends that you do not change your preset security settings. If you do decide to change your preset security settings, make a note of the new settings and store it in a safe place where you can easily find it.

If you use a wireless computer to change the wireless network name (SSID) or other wireless security settings, you are disconnected when you click Apply. To avoid this problem, use a computer with a wired connection to access the router.

➤ To view or change basic wireless settings:

1. On the Basic Home screen, select **Wireless** to display the Wireless Setup screen.

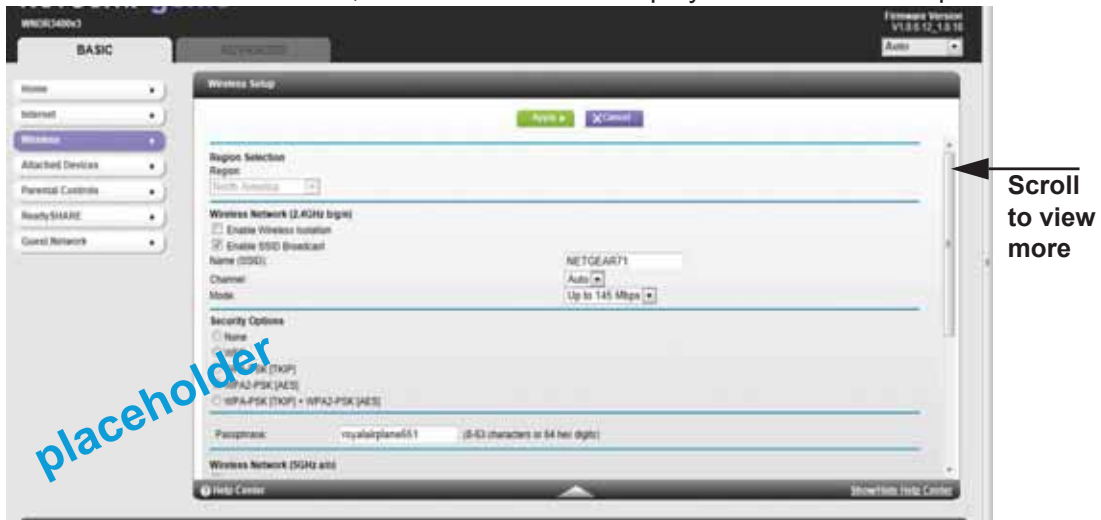

The screen sections, settings, and procedures are explained in the following sections.

2. Make any changes that are needed and click **Apply** to save your settings.
3. Set up and test your wireless devices and computers to make sure that they can connect wirelessly. If they do not, check the following:
 - Is your wireless device or computer connected to your network or another wireless network in your area? Some wireless devices automatically connect to the first open network (without wireless security) that they discover.
 - Does your wireless device or computer show up on the Attached Devices screen? If it does, it is connected to the network.
 - If you are not sure what the SSID or password is, look on the label on the bottom of your router.

Wireless Setup Screen Fields

Region. The location where the router is used. Select from the countries in the list. In the United States, the region is fixed to United States and is not changeable.

Wireless Network

Note: These settings apply separately to the 2.4 GHz b/g/n and 5 GHz a/n bands.

Enable Wireless Isolation. If this check box is selected, wireless clients (computers or wireless devices) that join the network can use the Internet, but cannot access each other or access Ethernet devices on the network.

Enable SSID Broadcast. This feature allows the router to broadcast its SSID so wireless stations can see this wireless name (SSID) in their scanned network lists. This check box is selected by default. To turn off the SSID broadcast, clear the check box, and click **Apply**.

Name (SSID). The SSID is also known as the wireless network name. Enter a 32-character (maximum) name in this field. This field is case-sensitive. The default SSID is randomly generated, and **NETGEAR strongly recommends that you do not change this.**

Channel. This setting is the wireless channel used by the gateway. Enter a value from 1 through 13. (For products in the North America market, only Channels 1 through 11 can be operated.) Do not change the channel unless you experience interference (shown by lost connections or slow data transfers). If this happens, experiment with different channels to see which is the best.

Mode. Up to 130 Mbps is the default and allows 802.11n and 802.11g wireless devices to join the network. g & b supports up to 54 Mbps. The 300 Mbps setting allows 802.11n devices to connect at this speed.

Security Options Settings

Note: These settings apply separately to the 2.4 GHz b/g/n and 5 GHz a/n bands.

The Security Options section of the Wireless Setup screen lets you change the security option and password. **NETGEAR recommends that you not change the security option or password**, but if you want to change these settings, this section explains how. **Do not disable security.**

Change WPA Security Option and Password

Note: These settings apply separately to the 2.4 GHz b/g/n and 5 GHz a/n bands.

1. Under Security Options, select the WPA option you want.

Security Options

None

WEP

WPA-PSK [TKIP]

WPA2-PSK [AES]

WPA-PSK [TKIP] + WPA2-PSK [AES]

Passphrase: (8-63 characters or 64 hex digits)

2. In the password field that displays when you select a WPA security option, enter the network key (password) that you want to use. It is a text string from 8 to 63 characters.

Guest Networks

Adding a guest network allows visitors at your home to use the Internet without using your wireless security key. You can add a guest network to each wireless network: 2.4 GHz b/g/n and 5.0 GHz a/n.

➤ **To set up a guest network:**

1. Select **Basic > Guest Network** to display the following screen:



2. Select any of the following wireless settings:

Note: These settings apply separately to the 2.4 GHz b/g/n and 5 GHz a/n bands.

Enable Guest Network. When this check box is selected, the guest network is enabled, and guests can connect to your network using the SSID of this profile.

Enable Wireless Isolation. If this check box is selected, wireless clients (computers or wireless devices) that join the network can use the Internet, but cannot access each other or access Ethernet devices on the network.

Enable SSID Broadcast. If this check box is selected, the wireless access point broadcasts its name (SSID) to all wireless stations. Stations with no SSID can adopt the correct SSID for connections to this access point.

Allow guest to access My Local Network. If this check box is selected, any user who connects to this SSID has access to your local network, not just Internet access.

3. Give the guest network a name.

The guest network name is case-sensitive and can be up to 32 characters. You then manually configure the wireless devices in your network to use the guest network name in addition to the main nonguest SSID.

4. Select a security option from the list. The security options are described in *Guest Network Wireless Security Options* on page 40.
5. Click **Apply** to save your selections.

Guest Network Wireless Security Options

A security option is the type of security protocol applied to your wireless network. The security protocol in force encrypts data transmissions and ensures that only trusted devices receive authorization to connect to your network.

This section presents an overview of the security options and provides guidance on when to use which option. Although it is possible to set up a guest network without wireless security, NETGEAR does *not* recommend it.

Wi-Fi Protected Access (WPA) encryption is built into all hardware that has the Wi-Fi-certified seal. This seal means that the product is authorized by the Wi-Fi Alliance (<http://www.wi-fi.org/>) because it complies with the worldwide single standard for high-speed wireless local area networking.

WPA-PSK uses a password to perform authentication and generate the initial data encryption keys. Then it dynamically varies the encryption key. WPA-PSK uses Temporal Key Integrity Protocol (TKIP) data encryption, implements most of the IEEE 802.11i standard, and is designed to work with all wireless network interface cards, but not all wireless access points. It is superseded by WPA2-PSK.

N300 Personal Router PR2000

WPA2-PSK is stronger than WPA. It is advertised to be theoretically indecipherable due to the greater degree of randomness in encryption keys that it generates. WPA2-PSK gets higher speed because it is implemented through hardware, while WPA-PSK is implemented through software. WPA2-PSK uses a password to authenticate and generate the initial data encryption keys. Then it dynamically varies the encryption key.

WPS-PSK + WPA2-PSK Mixed Mode can provide broader support for all wireless clients. WPA2-PSK clients get higher speed and security, and WPA-PSK clients get decent speed and security. The product documentation for your wireless adapter and WPA client software should have instructions about configuring their WPA settings.

genie Advanced Home

4

Specifying custom settings

This chapter explains the features available from the genie Advanced Home screen, shown in the following figure:

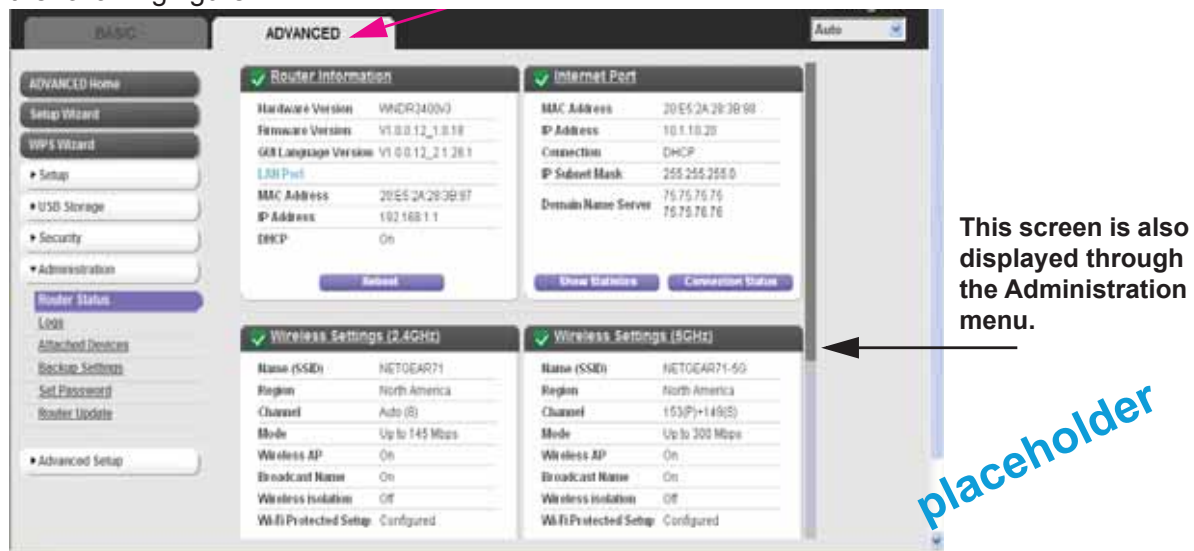

This chapter contains the following sections:

- *Setup Wizard*
- *WPS Wizard*
- *Setup Menu*
- *WAN Setup*
- *LAN Setup*
- *Quality of Service (QoS) Setup*

Some selections on the Advanced Home screen are described in separate chapters:

- **USB Storage.** See *Chapter 5, USB Storage.*
- **Security.** See *Chapter 6, Security.*
- **Administration.** See *Chapter 7, Administration.*
- **Advanced Setup.** See *Chapter 8, Advanced Settings.*

Setup Wizard

The NETGEAR genie installation process is launched the first time you set up the router. After setting up the router the first time, if you want to perform this task again, you can run Setup Wizard from the Advanced tab of NETGEAR genie.

1. Select **Setup Wizard** to display the following screen:



placeholder

2. Select either **Yes** or **No, I want to configure the router myself**. If you select No, you are taken to the Internet Setup screen (see [Internet Setup](#) on page 30).
3. If you selected Yes, click **Next**. The following screen displays:



placeholder

The Setup Wizard searches your Internet connection for servers and protocols to determine your ISP configuration. The following screen displays:

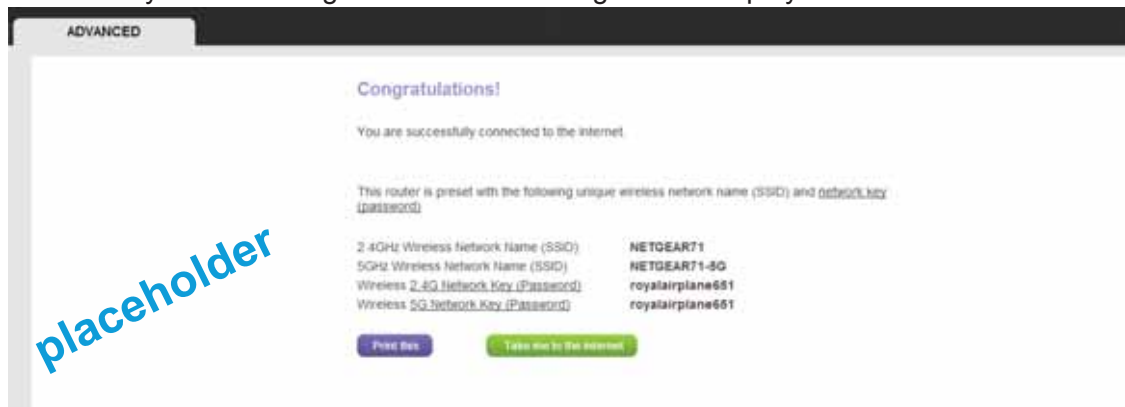

placeholder

WPS Wizard

The WPS Wizard helps you add a WPS-capable client device (a wireless device or computer) to your network. On the client device, you need to either press its WPS button or locate its WPS PIN.

➤ **To use the WPS Wizard:**

1. Select **Advanced > WPS Wizard**.
2. Click **Next**. The following screen lets you select the method for adding the WPS client (a wireless device or computer).



placeholder

You can use either the push button or PIN method.

3. Select either **Push Button** or **PIN Number**.
 - To use the push button method, either click the **WPS** button on this screen, or press the **WPS** button on the side of the router until the LED status changes. Within 2 minutes, go to the wireless client and press its **WPS** button to join the network without entering a password.
 - To use the PIN method, select the **PIN Number** radio button, enter the client security PIN, and click **Next**.



placeholder

Within 2 minutes, go to the client device and use its WPS software to join the network without entering a password.

The router attempts to add the WPS-capable device. The WPS LED  on the router blinks green. When the router establishes a WPS connection, the LED is solid green, and the router WPS screen displays a confirmation message.

4. Repeat Step 2 and Step 3 to add another WPS client to your network.

Setup Menu

Select **Advanced > Setup** to display the Setup menu. The following selections are available:

- **Internet Setup.** This is a shortcut to the same Internet Setup screen that you can access from the dashboard on the Basic Home screen. See [Internet Setup](#) on page 30.
- **Wireless Setup.** This is a shortcut to the same Wireless Setup screen that you can access from the dashboard on the Basic Home screen. See [Basic Wireless Settings](#) on page 36.
- **WAN Setup.** Internet (WAN) setup. See [WAN Setup](#) on page 46.
- **LAN Setup.** Local area network (LAN) setup. See [LAN Setup](#) on page 49.
- **QoS Setup.** Quality of Service (QoS) setup. See [Quality of Service \(QoS\) Setup](#) on page 52.
- **Guest Network.** This is a shortcut to the same Guest Network screen that you can access from the dashboard on the Basic Home screen. See [Guest Networks](#) on page 39.

WAN Setup

The WAN Setup screen lets you configure a DMZ (demilitarized zone) server, change the maximum transmit unit (MTU) size, and enable the router to respond to a ping on the WAN (Internet) port. Select **Advanced > Setup > WAN Setup** to view the following screen:



- **Disable Port Scan and DoS Protection.** DoS protection protects your LAN against denial of service attacks such as Syn flood, Smurf Attack, Ping of Death, Teardrop Attack, UDP Flood, ARP Attack, Spoofing ICMP, Null Scan, and many others. This should be disabled only in special circumstances.
- **Default DMZ Server.** This feature is sometimes helpful when you are playing online games or videoconferencing. Be careful when using this feature because it makes the firewall security less effective. See the following section, *Default DMZ Server*, for more details.
- **Respond to Ping on Internet Port.** If you want the router to respond to a ping from the Internet, select this check box. Use this only as a diagnostic tool because it allows your router to be discovered. Do not select this check box unless you have a specific reason.
- **Disable IGMP Proxying.** IGMP proxying allows a computer on the local area network (LAN) to receive the multicast traffic it is interested in from the Internet. If you do not need this feature, you can select this check box to disable it.
- **MTU Size (in bytes).** The normal MTU (maximum transmit unit) value for most Ethernet networks is 1500 bytes, or 1492 bytes for PPPoE connections. For some ISPs, you might need to reduce the MTU. This is rarely required, and should not be done unless you are sure that it is necessary for your ISP connection. See *Change the MTU Size* on page 47.
- **NAT Filtering.** Network Address Translation (NAT) determines how the router processes inbound traffic. Secured NAT provides a secured firewall to protect the computers on the LAN from attacks from the Internet, but might prevent some Internet games, point-to-point applications, or multimedia applications from functioning. Open NAT provides a much less secured firewall, but allows almost all Internet applications to function.

Default DMZ Server

The default DMZ server feature is helpful when you are using some online games and videoconferencing applications that are incompatible with Network Address Translation (NAT). The router is programmed to recognize some of these applications and to work correctly with them, but other applications might not function well. In some cases, one local computer can run the application correctly if that computer's IP address is entered as the default DMZ server.



WARNING:

DMZ servers pose a security risk. A computer designated as the default DMZ server loses much of the protection of the firewall and is exposed to exploits from the Internet. If compromised, the DMZ server computer can be used to attack other computers on your network.

Incoming traffic from the Internet is discarded by the router unless the traffic is a response to one of your local computers or a service that you have configured in the Port Forwarding/Port Triggering screen. Instead of discarding this traffic, you can forward it to one computer on your network. This computer is called the default DMZ server.

➤ **To set up a default DMZ server:**

1. On the WAN Setup screen, select the **Default DMZ Server** check box.
2. Type the IP address.
3. Click **Apply**.

Change the MTU Size

The maximum transmission unit (MTU) is the largest data packet a network device transmits. When one network device communicates across the Internet with another, the data packets travel through many devices along the way. If any device in the data path has a lower MTU setting than the other devices, the data packets have to be split or "fragmented" to accommodate the device with the smallest MTU.

The best MTU setting for NETGEAR equipment is often just the default value, and changing the value might fix one problem but cause another. Leave the MTU unchanged unless one of these situations occurs:

- You have problems connecting to your ISP or other Internet service, and the technical support of either the ISP or NETGEAR recommends changing the MTU setting. These web-based applications might require an MTU change:
 - A secure website that does not open, or displays only part of a web page
 - Yahoo email
 - MSN portal
 - America Online's DSL service

- You use VPN and have severe performance problems.
- You used a program to optimize MTU for performance reasons, and now you have connectivity or performance problems.

Note: An incorrect MTU setting can cause Internet communication problems such as the inability to access certain websites, frames within websites, secure login pages, or FTP or POP servers.

If you suspect an MTU problem, a common solution is to change the MTU to 1400. If you are willing to experiment, you can gradually reduce the MTU from the maximum value of 1500 until the problem goes away. The following table describes common MTU sizes and applications.

Table 1. Common MTU sizes

MTU	Application
1500	The largest Ethernet packet size and the default value. This is the typical setting for non-PPPoE, non-VPN connections, and is the default value for NETGEAR routers, adapters, and switches.
1492	Used in PPPoE environments.
1472	Maximum size to use for pinging. (Larger packets are fragmented.)
1468	Used in some DHCP environments.
1460	Usable by AOL if you do not have large email attachments, for example.
1436	Used in PPTP environments or with VPN.
1400	Maximum size for AOL DSL.
576	Typical value to connect to dial up ISPs.

➤ **To change the MTU size:**

1. Select **Advanced > Setup > WAN Setup**.
2. In the MTU Size field, enter a new size between 64 and 1500.
3. Click **Apply** to save the settings.

LAN Setup

The LAN Setup screen allows configuration of LAN IP services such as Dynamic Host Configuration Protocol (DHCP) and Routing Information Protocol (RIP).

The router is shipped preconfigured to use private IP addresses on the LAN side and to act as a DHCP server. The router's default LAN IP configuration is:

- LAN IP address: **192.168.1.1**
- Subnet mask: **255.255.255.0**

These addresses are part of the designated private address range for use in private networks and should be suitable for most applications. If your network requires a different IP addressing scheme, you can make the changes in the LAN Setup screen.

➤ **To change the LAN settings:**

Note: If you change the LAN IP address of the router while connected through the browser, you will be disconnected. Open a new connection to the new IP address and log in again.

1. Select **Advanced > Setup > LAN Setup** to display the following screen:



2. Enter the settings that you want to customize. These settings are described in the following section, [LAN Setup Screen Settings](#).
3. Click **Apply** to save your changes.

LAN Setup Screen Settings

LAN TCP/IP Setup

- **IP Address.** The LAN IP address of the router.
- **IP Subnet Mask.** The LAN subnet mask of the router. Combined with the IP address, the IP subnet mask allows a device to know which other addresses are local to it, and which have to be reached through a gateway or router.
- **RIP Direction.** Router Information Protocol (RIP) allows a router to exchange routing information with other routers. This setting controls how the router sends and receives RIP packets. Both is the default setting. With the Both or Out Only setting, the router broadcasts its routing table periodically. With the Both or In Only setting, the router incorporates the RIP information that it receives.
- **RIP Version.** Controls the format and the broadcasting method of the RIP packets that the router sends. It recognizes both formats when receiving. By default, the RIP function is disabled.

RIP-1 is universally supported. It is adequate for most networks, unless you have an unusual network setup.

RIP-2 carries more information. Both RIP-2B and RIP-2M send the routing data in RIP-2 format. RIP-2B uses subnet broadcasting. RIP-2M uses multicasting.

Use Router as a DHCP Server

This check box is selected so that the router functions as a Dynamic Host Configuration Protocol (DHCP) server.

- **Starting IP Address.** Specify the start of the range for the pool of IP addresses in the same subnet as the router.
- **Ending IP Address.** Specify the end of the range for the pool of IP addresses in the same subnet as the router.

Address Reservation

When you specify a reserved IP address for a computer on the LAN, that computer receives the same IP address each time it accesses the router's DHCP server. Assign reserved IP addresses to servers that require permanent IP settings.

Use the Router as a DHCP Server

By default, the router functions as a DHCP server, allowing it to assign IP, DNS server, and default gateway addresses to all computers connected to the router's LAN. The assigned default gateway address is the LAN address of the router. The router assigns IP addresses to the attached computers from a pool of addresses specified in this screen. Each pool address is tested before it is assigned to avoid duplicate addresses on the LAN. For most applications, the default DHCP and TCP/IP settings of the router are satisfactory.

You can specify the pool of IP addresses to be assigned by setting the starting IP address and ending IP address. These addresses should be part of the same IP address subnet as the router's LAN IP address. Using the default addressing scheme, you should define a range between 192.168.1.2 and 192.168.1.254, although you might want to save part of the range for devices with fixed addresses.

The router delivers the following parameters to any LAN device that requests DHCP:

- An IP address from the range you have defined
- Subnet mask
- Gateway IP address (the router's LAN IP address)
- Primary DNS server (if you entered a primary DNS address in the Internet Setup screen; otherwise, the router's LAN IP address)
- Secondary DNS server (if you entered a secondary DNS address in the Internet Setup screen)

To use another device on your network as the DHCP server, or to manually configure the network settings of all of your computers, clear the **Use Router as DHCP Server** check box and click **Apply**. Otherwise, leave this check box selected. If this service is not enabled and no other DHCP server is available on your network, you need to set your computers' IP addresses manually or they will not access the router.

Address Reservation

When you specify a reserved IP address for a computer on the LAN, that computer always receives the same IP address each time it accesses the router's DHCP server. Reserved IP addresses should be assigned to computers or servers that require permanent IP settings.

➤ To reserve an IP address:

1. In the Address Reservation section of the screen, click the **Add** button.
2. In the IP Address field, type the IP address to assign to the computer or server. (Choose an IP address from the router's LAN subnet, such as 192.168.1.x.)
3. Type the MAC address of the computer or server.

Tip: If the computer is already on your network, you can copy its MAC address from the Attached Devices screen and paste it here.

4. Click **Apply** to enter the reserved address into the table.

The reserved address is not assigned until the next time the computer contacts the router's DHCP server. Reboot the computer or access its IP configuration and force a DHCP release and renew.

To edit or delete a reserved address entry, select the radio button next to the reserved address you want to edit or delete. Then click **Edit** or **Delete**.

Quality of Service (QoS) Setup

QoS is an advanced feature that can be used to prioritize some types of traffic ahead of others. The N300 Personal Router can provide QoS prioritization over the wireless link and on the Internet connection. To configure QoS, use the QoS Setup screen.

Select **Advanced > Setup > QoS Setup** to display the following screen:



Enable WMM QoS for Wireless Multimedia Applications

The N300 Personal Router supports Wi-Fi Multimedia Quality of Service (WMM QoS) to prioritize wireless voice and video traffic over the wireless link. WMM QoS provides prioritization of wireless data packets from different applications based on four access categories: voice, video, best effort, and background. For an application to receive the benefits of WMM QoS, both it and the client running that application have to have WMM enabled. Legacy applications that do not support WMM and applications that do not require QoS are assigned to the best effort category, which receives a lower priority than voice and video.

WMM QoS is enabled by default. You can disable it in the QoS Setup screen by clearing the **Enable WMM** check box and clicking **Apply**.

Set Up QoS for Internet Access

You can give prioritized Internet access to the following types of traffic:

- Specific applications
- Specific online games
- Individual Ethernet LAN ports of the router
- A specific device by MAC address

To specify prioritization of traffic, you have to create a policy for the type of traffic and add the policy to the QoS Policy table in the QoS Setup screen. For convenience, the QoS Policy table lists many common applications and online games that can benefit from QoS handling.

QoS for Applications and Online Gaming

➤ To create a QoS policy for applications and online games:

1. In the QoS Setup screen, select the **Turn Internet Access QoS On** check box.



2. Click the **Setup QoS rule** button. The existing priority rules display.
3. To edit a priority rule, select its radio button and click the **Edit** button.
4. To delete a priority rule, select its radio button and click the **Delete** button.
5. To delete all of the priority rules, click the **Delete All** button.
6. To add a priority rule, scroll down to the bottom of the QoS Setup screen and click **Add Priority Rule**:



7. In the QoS Policy for field, type the name of the application or game.
8. In the Priority Category list, select either **Applications** or **Online Gaming**. A list of applications or games displays.
9. You can select an existing item from the list, or you can scroll and select **Add a New Application** or **Add a New Game**, as applicable.
 - a. If you add a new entry, the Priority Rules screen expands as shown:



- b. In the QoS Policy for field, enter a descriptive name for the new application or game.
 - c. In the Connection Type list, select either **TCP**, **UDP**, or both (**TCP/UDP**), and specify the port number or range of port numbers used by the application or game.
10. From the Priority list, select the priority that this traffic should receive relative to other applications and traffic when accessing the Internet. The options are Low, Normal, High, and Highest.
11. Click **Apply** to save this rule to the QoS Policy list and return to the QoS Setup screen.

QoS for a Router LAN Port

- **To create a QoS policy for a device connected to one of the router's LAN ports:**
 1. Select **Advanced > Setup > QoS Setup** to display the QoS Setup screen. Select the **Turn Internet Access QoS On** check box.
 2. Click the **Setup QoS Rule** button.
 3. Click the **Add Priority Rule** button.

- From the Priority Category list, select **Ethernet LAN Port**. The following screen appears:



- From the LAN port list, select the LAN port you want to create a QoS policy for.
- From the Priority list, select the priority that this port's traffic should receive relative to other applications and traffic when accessing the Internet. The options are Low, Normal, High, and Highest.
- Click **Apply** to save this rule to the QoS Policy list and return to the QoS Setup screen.
- In the QoS Setup screen, click **Apply**.

QoS for a MAC Address

- To create a QoS policy for traffic from a specific MAC address:

- Select **Advanced > Setup > QoS Setup**, and click the **Setup QoS Rule** button. The QoS Setup screen displays.
- Click **Add Priority Rule**.
- From the Priority Category list, select **MAC Address** to display the following screen:



4. If the device to be prioritized appears in the MAC Device List, select its radio button. The information from the MAC Device List populates the policy name, MAC Address, and Device Name fields. If the device does not appear in the MAC Device List, click **Refresh**. If it still does not appear, you have to complete these fields manually.
5. From the Priority list, select the priority that this device's traffic should receive relative to other applications and traffic when accessing the Internet. The options are Low, Normal, High, and Highest. Click **Add** to add this rule to MAC Device List.
6. Click **Apply** to save this rule to the QoS Policy list and return to the QoS Setup screen.
7. In the QoS Setup screen, select the **Turn Internet Access QoS On** check box.
8. Click **Apply**.

Edit or Delete an Existing QoS Policy

➤ **To edit or delete a QoS policy:**

1. Select **Advanced > QoS Setup** to display the QoS Setup screen.
2. Select the radio button next to the QoS policy to be edited or deleted, and do one of the following:
 - Click **Delete** to remove the QoS policy.
 - Click **Edit** to edit the QoS policy. Follow the instructions in the preceding sections to change the policy settings.
3. Click **Apply** in the QoS Setup screen to save your changes.

5. USB Storage

5

Accessing and configuring a USB storage drive

This chapter describes how to access and configure a USB storage drive attached to your router. Note that the USB port on the router can be used to connect only USB storage devices like flash drives or hard drives. Do not connect computers, USB modems, printers, CD drives, or DVD drives to the router USB port.

This chapter contains the following sections:

- *USB Drive Requirements*
- *ReadySHARE Access*
- *File-Sharing Scenarios*
- *Basic Settings*
- *USB Storage Advanced Settings*
- *Safely Remove a USB Drive*
- *Specify Approved USB Devices*
- *Connect to the USB Drive from a Remote Computer*

USB Drive Requirements

The router works with 1.0 and 1.1 (USB Full Speed) and 2.0 (USB High Speed) standards. The approximate USB bus speeds are shown in the following table. Actual bus speeds can vary, depending on the CPU speed, memory, speed of the network, and other variables.

Table 2. USB drive speeds

Bus	Speed/Sec
USB 1.1	12 Mbits
USB 2.0	480 Mbits

The router should work with most USB-compliant external flash and hard drives. For the most up-to-date list of USB drives supported by the router, visit:

<http://kbserver.netgear.com/readyshare>

The router supports both read and write for FAT16, FAT32, NTFS, and Linux file systems (EXT2 and EXT3).

Note: Some USB external hard drives and flash drives require drivers be loaded into the Windows computer before the Windows computer can access the USB device. Such USB devices will not work with the router.

ReadySHARE Access

Once you have set up your router, you can connect any USB storage device and share the contents with other users on your network.

You can access your USB device in any of the following ways:

- On Windows 7, Windows 8, Windows XP, Windows Vista, and Windows 2000 systems, select **Start > Run**, and enter **\\readyshare** in the dialog box. Click **OK**.
- On Windows 7, Windows 8, Windows XP, Windows Vista, and Windows 2000 systems, open Internet Explorer, or Safari, and enter **\\readyshare** in the address bar.
- On Mac OS X (version 10.2 or later), enter **smb://readyshare** in the address bar.
- In My Network Places, enter **\\readyshare** in the address bar.

For more information about ReadySHARE access for USB storage devices, go to:

<http://www.netgear.com/readyshare>

File-Sharing Scenarios

You can share files on the USB drive for a wide variety of business and recreational purposes. The files can be any Windows, Mac, or Linux file type including text, Word, PowerPoint, Excel, and MP3 files, pictures, and multimedia. USB drive applications include:

- Sharing multimedia, such as MP3 files, pictures, and so on, with friends and family who are local or remote.
- Sharing resources on your network. You might want to store files in a central location so that you do not need to power up a computer to perform local sharing. In addition, you can share files between Mac, Linux, and Windows computers by using the USB drive as a go-between across the systems.
- Sharing files such as Word documents, PowerPoint presentations, and text files with remote users.

A few common uses are described in the following sections.

Share Photos

You can create your own central storage location for photos and multimedia. This eliminates the need to log in to (and pay for) an external photo sharing site.

➤ To share files with your friends and family:

1. Insert your USB drive into the USB port on the router either directly or with a USB cable. Computers on your local area network (LAN) can automatically access this USB drive using a web browser or Microsoft Networking.
2. If you want to specify read-only access or to allow access from the Internet, see [USB Storage Advanced Settings](#) on page 62.

Store Files in a Central Location for Printing

This scenario is for a family that has one high-quality color printer directly attached to a computer, but not shared on the local area network (LAN). This family does not have a print server.

- A family member has photos on a Mac computer and wants to print them.
- The photo-capable color printer is directly attached to a Windows computer, but not shared on the network.
- The Mac and Windows computer are not visible to each other on the network.

➤ To print photos from a Mac on the printer attached to a Windows computer:

1. On the Mac, access the USB drive by typing `\\readyshare` in the address field of a web browser. Then copy the photos to the USB drive.
2. On the Windows computer, use a web browser or Microsoft Networking to copy the files from the USB drive to the Windows computer. Print the files.

Share Large Files over the Internet

Sending files that are larger than 5 MB can pose a problem for many email systems. The router allows you to share large files such as PowerPoint presentations or .zip files over the Internet. FTP can be used to easily download shared files from the router.

Sharing files with a remote colleague involves the following considerations:

- There are two user accounts: admin and guest. The password for admin is the same one that you use to access the router. By default, it is **password**. The guest user account has no password.
- On the FTP site, the person receiving the files should use the guest user account and enter any password (FTP requires that you type something in the password field).
- Be sure to select the **FTP (via Internet)** check box in the USB Storage (Advanced Settings) screen. This option supports both downloading and uploading of files.

Note: You can enable the HTTP (via Internet) option on the USB Storage (Advanced Settings) screen to share large files. This option supports downloading files only.

Basic Settings

You can view or edit basic settings for the USB storage device attached to your router.

You can access this feature by selecting **Basic > ReadySHARE**, or **Advanced > USB Storage > ReadySHARE**.

The USB Storage (Basic Settings) screen displays:

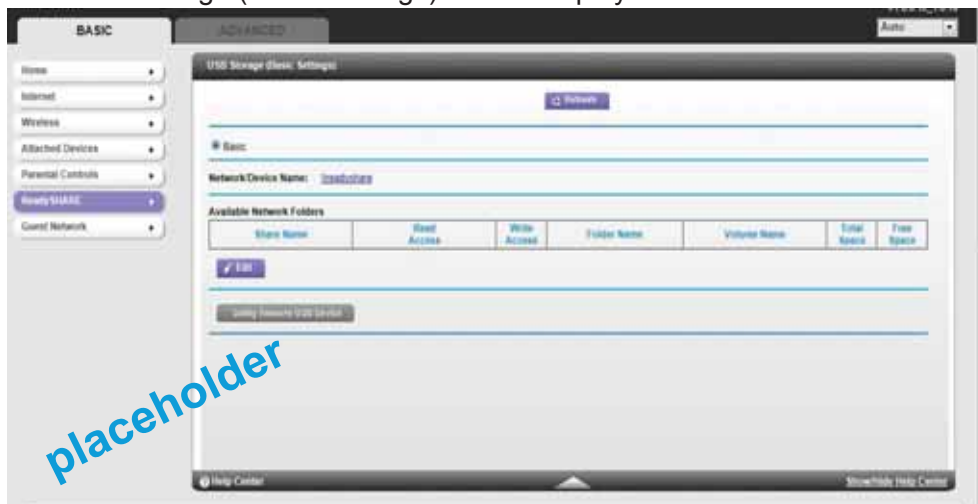

By default, the USB storage device is available to all computers on your local area network (LAN).

➤ **To access your USB device:**

1. Click the network device name or the share name in your computer's network folders list.
2. For SMB://readyshare, click **Connect**.

Note: If you log in to the router before you connected your USB device, you might not see your USB device in the router screens until you log out and then log back in again.

Add or Edit a Network Folder

1. You can access this feature by selecting **Basic > ReadyShare > Edit**, or **Advanced > USB Storage > Advanced Settings**.



2. Specify the changes that you want to make:
 - To add a folder, click **Create Network Folder**.



- To edit a folder, select its radio button and click **Edit**.
- You can use this screen to select a folder, to change the share name, or to change the read access or write access from All – no password to **admin**.

The user name (account name) for All – no password is guest. The password for admin is the same one that is used to log in to the router. By default, it is password.

- Click **Apply** for your changes to take effect.

USB Storage Advanced Settings

You can set up the device name, workgroups, and network folders for your USB device. On the Advanced tab, select **USB Storage > Advanced Settings** to display the following screen:



You can use this screen to specify access to the USB storage device.

- Network/Device Name.** The default is readyshare. This is the name used to access the USB device connected to the router.
- Workgroup.** If you are using a Windows workgroup rather than a domain, the workgroup name is displayed here. The name works only in an operating system that supports NetBIOS, such as Microsoft Windows.
- Access Method.** The access methods are described here.

Network Connection. Enabled by default, this connection allows all users on the LAN to have access to the USB drive.

HTTP. Enabled by default. You can type **http://readyshare.routerlogin.net/shares** to access the USB drive.

HTTP (via internet). Disabled by default. If you select this check box, remote users can type **http://<public IP address>/shares** (for example, **http://1.1.10.102/shares**) or a URL domain name to access the USB drive over the Internet. This feature supports file uploading only.

FTP. Disabled by default.

FTP (via internet). Disabled by default. If you select this check box, remote users can access the USB drive through FTP over the Internet. This feature supports both downloading and uploading of files.

Available Network Folders

You might need to scroll down to view this section of the screen:



- **Share Name.** If only one device is connected, the default share name is USB_Storage. You can click the name shown, or you can type it in the address field of your web browser. If Not Shared is shown, the default share has been deleted and no other share for the root folder exists. Click the link to change this setting.
- **Read Access and Write Access.** Shows the permissions and access controls on the network folder: All - no password (the default) allows all users to access the network folder. The password for admin is the same one that you use to log in to the router.
- **Folder Name.** Full path used by the network folder.
- **Volume Name.** Volume name from the storage device (either USB drive or HDD).
- **Total Space and Free Space.** Shows the current utilization of the storage device.

Safely Remove a USB Drive

To safely remove a USB disk drive so that no users can access it, select **USB Storage > Basic Settings**, and click the **Safely Remove USB Device** button. This takes the drive offline.

Specify Approved USB Devices

For more security, you can set up the router to share approved USB devices only. You can access this feature from the Advanced Setup menu on the Advanced tab.

➤ **To set up approved USB devices:**

1. Select **Advanced > Advanced Setup > USB Settings**. The following screen displays:



2. Click the **Approved Devices** button. The USB Drive Approved Devices screen displays:



This screen shows the approved USB devices and the available USB devices. You can remove or add approved USB devices.

3. To add an approved USB device, select it from the Available USB Devices list and click **Add**.
4. Select the **Allow only approved devices** check box.

5. Click **Apply** so that your change takes effect.

If you want to work with another USB device, click the **Safely Remove USB Device** button for the currently connected USB device. Connect the other USB device and repeat this process.

Connect to the USB Drive from a Remote Computer

To connect to the USB drive from remote computers with a web browser, you have to use the router's Internet port IP address. If you are using Dynamic DNS, you can type the DNS name, rather than the IP address. You can view the router's Internet IP address from the dashboard on the Basic Home screen or the Advanced Home screen.

Access the Router's USB Drive Remotely Using FTP

- **To connect to the router's USB drive using a web browser:**

1. Connect to the router by typing **ftp://** and the Internet port IP address in the address field of Internet Explorer or Netscape Navigator, for example:

ftp://10.1.65.4

If you are using Dynamic DNS, you can type the DNS name rather than the IP address.

2. Type the account name and password that has access rights to the USB drive. The user name (account name) for All – no password is **guest**.
3. The directories of the USB drive that your account accesses are displayed, for example, share/partition1/directory1. You can now read and copy files from the USB directory.

6 Security

6

Keeping unwanted content out of your network

This chapter explains how to use the basic firewall features of the router to prevent objectionable content from reaching the computers and other devices connected to your network.

This chapter includes the following sections:

- *Keyword Blocking of HTTP Traffic*
- *Block Services (Port Filtering)*
- *Schedule Blocking*
- *Security Event Email Notifications*

Keyword Blocking of HTTP Traffic

Use keyword blocking to prevent certain types of HTTP traffic from accessing your network. The blocking can be always or according to a schedule.

1. Select **Advanced > Security > Block Sites** to display the following screen:

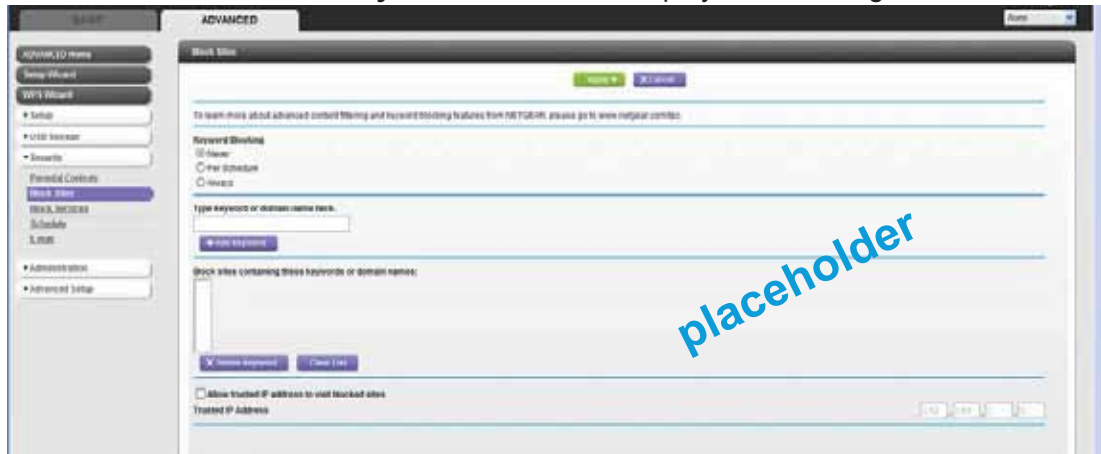

2. Select one of the keyword blocking options:
 - **Per Schedule.** Turn on keyword blocking according to the Schedule screen settings.
 - **Always.** Turn on keyword blocking all the time, independent of the Schedule screen.
3. In the keyword field, enter a keyword or domain, click **Add Keyword**, and click **Apply**.
The keyword list supports up to 32 entries. Here are some sample entries:
 - Specify XXX to block <http://www.badstuff.com/xxx.html>.
 - Specify .com if you want to allow only sites with domain suffixes such as .edu or .gov.
 - Enter a period (.) to block all Internet browsing access.

➤ To delete a keyword or domain:

1. Select the keyword you want to delete from the list.
2. Click **Delete Keyword** and **Apply** to save your changes.

➤ To specify a trusted computer:

You can exempt one trusted computer from blocking and logging. The computer you exempt must have a fixed IP address.

1. In the Trusted IP Address field, enter the IP address.
2. Click **Apply** to save your changes.

Block Services (Port Filtering)

Services are functions performed by server computers at the request of client computers. For example, web servers serve web pages, time servers serve time and date information, and

game hosts serve data about other players' moves. When a computer on the Internet sends a request for service to a server computer, the requested service is identified by a service or port number. This number appears as the destination port number in the transmitted IP packets. For example, a packet that is sent with the destination port number 80 is an HTTP (web server) request.

The service numbers for many common protocols are defined by the Internet Engineering Task Force (IETF at <http://www.ietf.org/>) and published in RFC1700, "Assigned Numbers." Service numbers for other applications are typically chosen from the range 1024 to 65535 by the authors of the application. Although the router already holds a list of many service port numbers, you are not limited to these choices. You can often determine port number information by contacting the publisher of the application, by asking user groups or newsgroups, or by searching.

The Block Services screen lets you add and block specific Internet services by computers on your network. This is called service blocking or port filtering. To add a service to block, first determine which port number or range of numbers are used by the application.

➤ **To block services:**

1. Select **Advanced > Security > Block Services** to display the following screen:



2. Select either **Per Schedule** or **Always** to enable service blocking, and click **Apply**. If you selected **Per Schedule**, specify a time period in the **Schedule** screen as described in [Schedule Blocking](#) on page 69.

3. Click **Add** to add a service. The Block Services Setup screen displays:



4. From the Service Type list, select the application or service to allow or block. The list already displays several common services, but you are not limited to these choices. To add any services or applications that do not already appear, select **User Defined**.
5. If you know that the application uses either TCP or UDP, select the appropriate protocol. If you are not sure, select **Both**.
6. Enter the starting and ending port numbers. If the application uses a single port number, enter that number in both fields.
7. Select the radio button for the IP address configuration you want to block and enter the IP addresses. You can block the specified service for a single computer, a range of computers with consecutive IP addresses, or all computers on your network.
8. Click **Add** to enable your Block Services Setup selections.

Schedule Blocking

You can specify the days and time that you want to block Internet access.

➤ To schedule blocking:

1. Select **Advanced > Security > Schedule** to display the following screen:



2. Set up the schedule for blocking keywords and services.
 - **Days to Block.** Select days on which you want to apply blocking by selecting the appropriate check boxes, or select **Every Day** to select the check boxes for all days.
 - **Time of Day to Block.** Select a start and end time in 24-hour format, or select **All Day** for 24-hour blocking.
3. Select your time zone from the list. If you use daylight savings time, select the **Automatically adjust for daylight savings time** check box.
4. Click **Apply** to save your settings.

Security Event Email Notifications

To receive logs and alerts by email, provide your email information in the E-mail screen and specify which alerts you want to receive and how often.

➤ To set up email notifications:

1. Select **Advanced > Security > E-mail** to display the following screen:

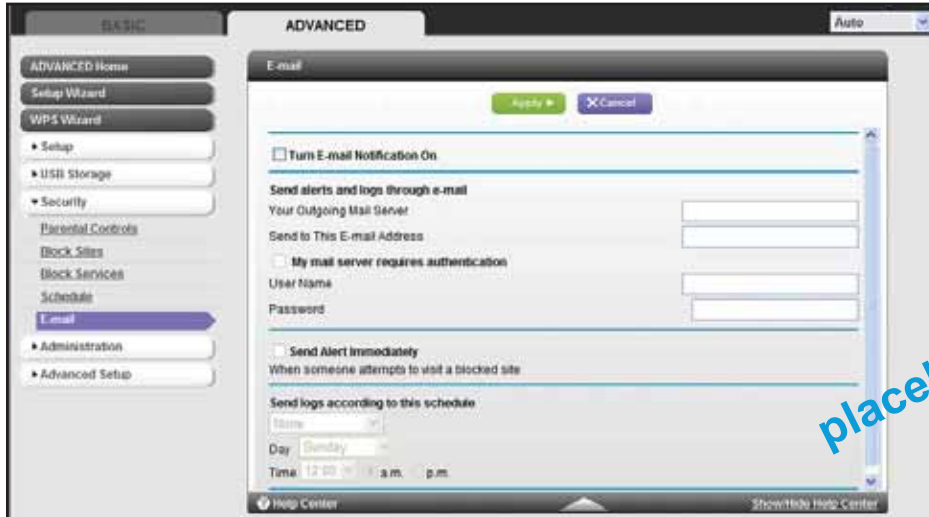

2. To receive email logs and alerts from the router, select the **Turn E-mail Notification On** check box.
3. In the Your Outgoing Mail Server field, enter the name of your ISP's outgoing (SMTP) mail server (such as mail.myISP.com). You might be able to find this information in the configuration screen of your email program. If you leave this field blank, log and alert messages are not sent by email.
4. Enter the email address to which logs and alerts are sent in the Send to This E-mail Address field. This email address is also used for the From address. If you leave this field blank, log and alert messages are not sent by email.
5. If your outgoing email server requires authentication, select the **My Mail Server requires authentication** check box. Fill in the User Name and Password fields for the outgoing email server.
6. You can have email alerts sent immediately when someone attempts to visit a blocked site and you can specify that logs are sent automatically.

If you select the Weekly, Daily, or Hourly option and the log fills up before the specified period, the log is automatically emailed to the specified email address. After the log is sent, the log is cleared from the router's memory. If the router cannot email the log file, the log buffer might fill up. In this case, the router overwrites the log and discards its contents.

7. Click **Apply** to save your settings.

Administration

7

Managing your network

This chapter describes the router settings for administering and maintaining your router and home network. For information about upgrading or checking the status of your router over the Internet, see also *Remote Management* on page 100. For information about monitoring the volume of Internet traffic passing through your router's Internet port, see *Traffic Meter* on page 103.

This chapter includes the following sections:

- *Upgrade the Router Firmware*
- *View Router Status*
- *View Logs of Web Access or Attempted Web Access*
- *Manage the Configuration File*
- *Set Password*

Upgrade the Router Firmware

The router firmware (routing software) is stored in flash memory. You can update the firmware from the Administration menu on the Advanced tab. You might see a message at the top of the genie screens when new firmware is available for your product.

You can use the Check button on the Router Upgrade screen to check and update to the latest firmware for your product if new firmware is available.

➤ **To check for new firmware and update your router:**

1. Select **Advanced > Administration > Router Update** to display the following screen:



2. Click **Check**.
The router finds new firmware if any is available.
3. Click **Yes** to update and locate the firmware you downloaded (the file ends in .img).



WARNING:

When uploading firmware to the router, *do not* interrupt the web browser by closing the window, clicking a link, or loading a new page. If the browser is interrupted, it could corrupt the firmware.

When the upload is complete, your router restarts. The upgrade process typically takes about 1 minute. Read the new firmware release notes to determine whether you need to reconfigure the router after upgrading.

View Router Status

To view router status and usage information, select **Advanced Home**, or select **Administration > Router Status** to display the following screen:

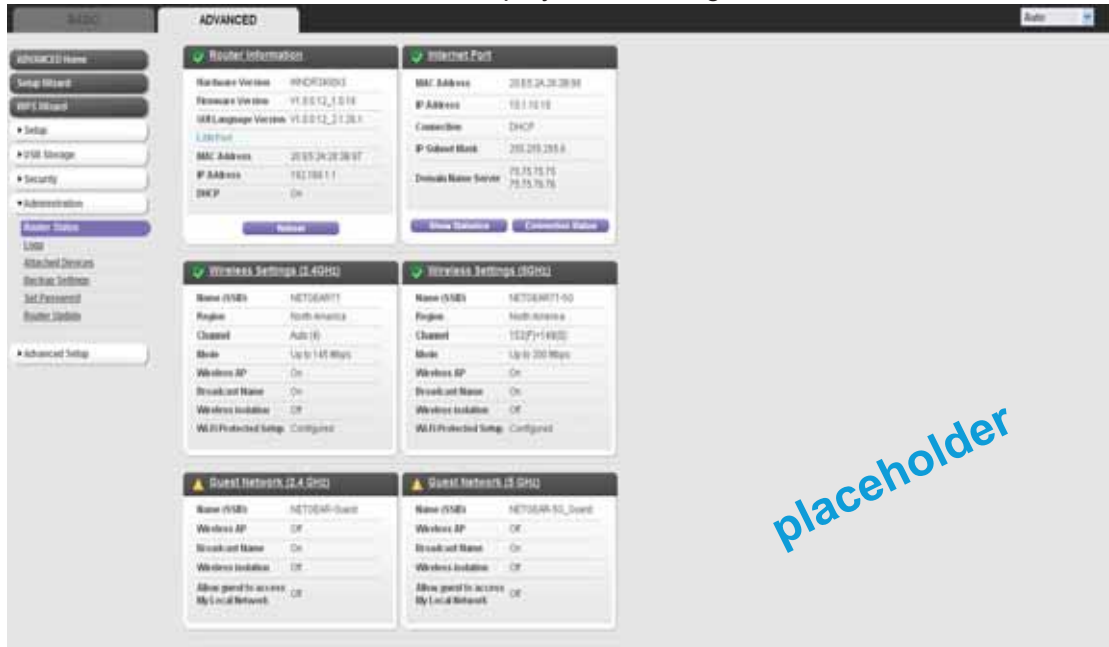

Router Information

Hardware Version. The router model.

Firmware Version. The version of the router firmware. It changes if you upgrade the router firmware.

GUI Language Version. The localized language of the user interface.

LAN Port.

- **MAC Address.** The Media Access Control address is the unique physical address used by the Ethernet (LAN) port of the router.
- **IP Address.** The IP address used by the Ethernet (LAN) port of the router. The default is 192.168.1.1.
- **DHCP.** Identifies whether the router's built-in DHCP server is active for the LAN-attached devices.

Internet Port

MAC Address. The Media Access Control address is the unique physical address used by the Internet (WAN) port of the router.

IP Address. The IP address used by the Internet (WAN) port of the router. If no address is shown or the address is 0.0.0, the router cannot connect to the Internet.

Connection. This shows if the router is using a fixed IP address on the WAN. If the value is DHCP Client, the router obtains an IP address dynamically from the ISP.

IP Subnet Mask. The IP subnet mask used by the Internet (WAN) port of the router.

Domain Name Server. The Domain Name Server addresses used by the router. A Domain Name Server translates human-language URLs such as www.netgear.com into IP addresses.

Show Statistics Button

On the Router Status screen, in the Internet Port pane, click the **Show Statistics** button to display the following screen:

Show Statistics

System Up Time 00:06:37

Port	Status	TxPkts	RxPkts	Collisions	Tx B/s	Rx B/s	Up Time
WAN	100M/Full	59	832	0	30	575	00:02:59
LAN1	Link Down	--	--	--	--	--	--
LAN2	Link Down	--	--	--	--	--	--
LAN3	Link Down	--	--	--	--	--	--
LAN4	Link Down	--	--	--	--	--	--
2G WLAN b/g/n	300M	4441	3391	0	19165	2177	00:03:04
5G WLAN a/n	300M	0	0	0	0	0	00:03:04

Poll Interval : (secs)

Figure 13. System up time and poll interval statistics

System Up Time. The time elapsed since the router was last restarted.

Port. The statistics for the WAN (Internet) and LAN (Ethernet) ports. For each port, the screen displays:

- **Status.** The link status of the port.
- **TxPkts.** The number of packets transmitted on this port since reset or manual clear.
- **RxPkts.** The number of packets received on this port since reset or manual clear.
- **Collisions.** The number of collisions on this port since reset or manual clear.
- **Tx B/s.** The current transmission (outbound) bandwidth used on the WAN and LAN ports.
- **Rx B/s.** The current reception (inbound) bandwidth used on the WAN and LAN ports.
- **Up Time.** The time elapsed since this port acquired the link.
- **Poll Interval.** The interval at which the statistics are updated in this screen.

To change the polling frequency, enter a time in seconds in the Poll Interval field, and click **Set Interval**.

To stop the polling entirely, click **Stop**.

Connection Status Button

On the Router Status screen in the Internet Connection pane, click the **Connection Status** button to view connection status information.

Connection Status	
IP Address	192.168.1.65
Subnet Mask	255.255.255.0
Default Gateway	192.168.1.254
DHCP Server	192.168.1.254
DNS Server	192.168.1.254
Lease Obtained	1 days,0 Hours,0 minutes.
Lease Expires	0 days,22 Hours,52 minutes.
<input type="button" value="Release"/> <input type="button" value="Renew"/>	
<input type="button" value="Close Window"/>	

placeholder

Figure 14. View connection status information

The **Release** button returns the status of all items to 0. The **Renew** button refreshes the items. The Close Window button closes the Connection Status screen.

IP Address. The IP address that is assigned to the router.

Subnet Mask. The subnet mask that is assigned to the router.

Default Gateway. The IP address for the default gateway that the router communicates with.

DHCP Server. The IP address for the Dynamic Host Configuration Protocol server that provides the TCP/IP configuration for all the computers that are connected to the router.

DNS Server. The IP address of the Domain Name Service server that provides translation of network names to IP addresses.

Lease Obtained. The date and time when the lease was obtained.

Lease Expires. The date and time that the lease expires.

Wireless Settings (2.4 GHz and 5 GHz)

✓ Wireless Settings (2.4GHz)		✓ Wireless Settings (5GHz)	
Name (SSID)	NETGEAR	Name (SSID)	NETGEAR-5G
Region	United States	Region	United States
Channel	Auto (10(P)+6(S))	Channel	44(P)+48(S)
Mode	Up to 300 Mbps	Mode	Up to 300 Mbps
Wireless AP	On	Wireless AP	On
Broadcast Name	On	Broadcast Name	On
Wireless isolation	Off	Wireless isolation	Off
Wi-Fi Protected Setup	Configured	Wi-Fi Protected Setup	Configured

The following settings are displayed:

Name (SSID). The wireless network name (SSID) used by the router. The default names for the 5 GHz network ends in -5G to distinguish it from the 2.4 GHz network.

Region. The geographic region where the router is being used. It might be illegal to use the wireless features of the router in some parts of the world.

Channel. Identifies the operating channel of the wireless port being used. The default channel is Auto. When Auto is selected, the router finds the best operating channel available. If you notice interference from nearby devices, you can select a different channel. Channels 1, 6, and 11 do not interfere with each other.

Mode. Indicates the wireless communication mode: Up to 54 Mbps, Up to 130 Mbps (default), and Up to 300 Mbps.

Wireless AP. Indicates whether the radio feature of the router is enabled. If this feature is not enabled, the Wireless LED on the front panel is off.

Broadcast Name. Indicates whether the router is broadcasting its SSID.

Wireless Isolation. Select this check box only if you want to prevent wireless connections to the router.

Wi-Fi Protected Setup. Indicates whether Wi-Fi Protected Setup is configured for this network.

Guest Network (2.4 GHz and 5 GHz)

▲ Guest Network (2.4 GHz)		▲ Guest Network (5 GHz)	
Name (SSID)	—	Name (SSID)	—
Wireless AP	Off	Wireless AP	Off
Broadcast Name	—	Broadcast Name	—
Wireless isolation	—	Wireless isolation	—
Allow guest to access My Local Network	—	Allow guest to access My Local Network	—

placeholder

Name (SSID). The 11N wireless network name (SSID) used by the router. The default names are NETGEAR-Guest and NETGEAR-5G-Guest.

Wireless AP. Indicates whether the radio feature of the router is enabled. If this feature is not enabled, the Wireless LEDs on the front panel are off.

Broadcast Name. Indicates whether the router is broadcasting its SSID.

Wireless Isolation. Select this check box only if you want to prevent wireless connections to the router.

Allow guest to access My Local Network. If selected, any user who connects to this SSID can access local networks associated with the router.

View Logs of Web Access or Attempted Web Access

The log is a detailed record of the websites you accessed or attempted to access. Up to 256 entries are stored in the log. Log entries appear only when keyword blocking is enabled and no log entries are made for the trusted user.

Select **Advanced > Administration > Logs**. The Logs screen displays.

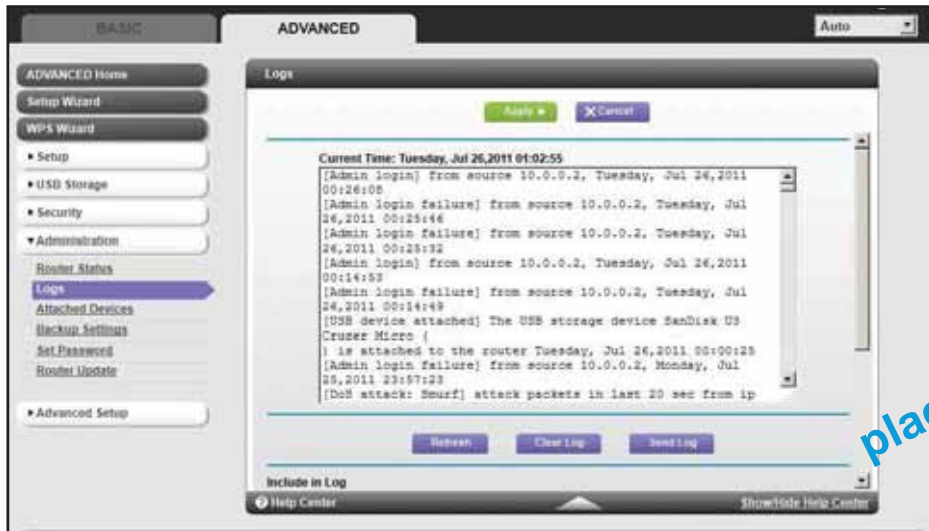

The log screen shows the following information:

- **Date and time.** The date and time the log entry was recorded.
- **Source IP address.** The IP address of the initiating device for this log entry.
- **Target address.** The name or IP address of the website or news group visited or to which access was attempted.
- **Action.** Whether the access was blocked or allowed.

To refresh the log screen, click the **Refresh** button.

To clear the log entries, click the **Clear Log** button.

To email the log immediately, click the **Send Log** button.

Manage the Configuration File

The configuration settings of the N300 Personal Router are stored within the router in a configuration file. You can back up (save) this file to your computer, restore it, or reset it to the factory default settings.

Back Up Settings

➤ To back up the router's configuration settings:

1. Select **Advanced > Administration > Back Up Settings** to display the following screen:

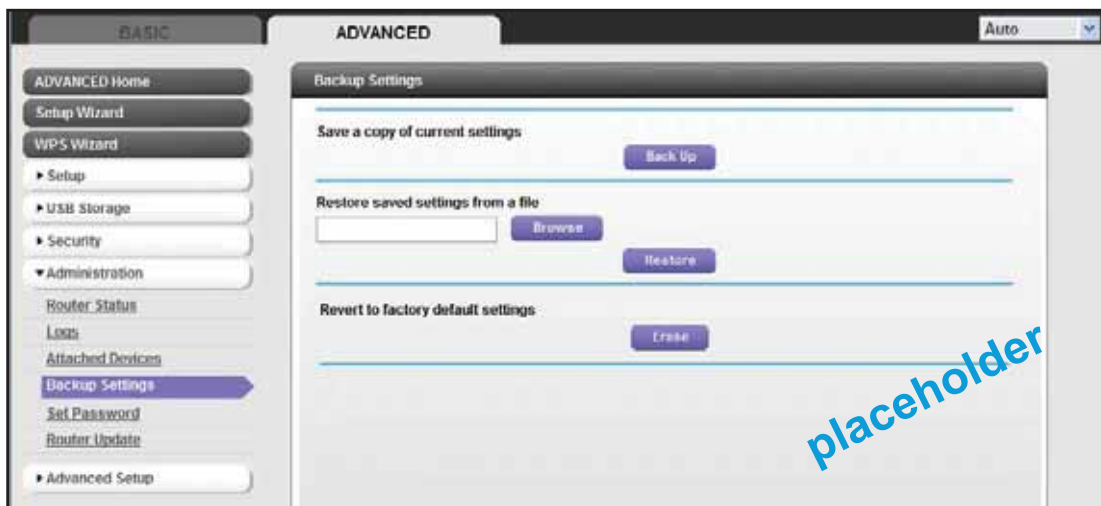

2. Click **Back Up** to save a copy of the current settings.
3. Choose a location to store the .cfg file that is on a computer on your network.

Restore Configuration Settings

➤ To restore configuration settings that you backed up:

1. Enter the full path to the file on your network, or click the **Browse** button to find the file.
2. When you have located the .cfg file, click the **Restore** button to upload the file to the router.

Upon completion, the router reboots.



WARNING:

Do not interrupt the reboot process.

Erase

Under some circumstances (for example, if you move the router to a different network or if you have forgotten the password), you might want to erase the configuration and restore the factory default settings.

You can either use the Restore Factory Settings button on the back of the router (see [Factory Settings](#) on page 115), or you can click the **Erase** button in this screen.

Erase sets the user name to admin, the password to password, and the LAN IP address to 192.168.1.1, and enables the router's DHCP.

Set Password

This feature allows you to change the default password that is used to log in to the router with the user name admin.

This is not the same as changing the password for wireless access. The label on the bottom of your router shows your unique wireless network name (SSID) and password for wireless access (see *Product Label* on page 15).

➤ **To set the password for the user name admin:**

1. Select **Advanced > Administration > Set Password** to display the following screen:



2. Type the old password and type the new password twice in the fields on this screen.
3. If you want to be able to recover the password, select the **Enable Password Recovery** check box.
4. Click **Apply** so that your changes take effect.

Password Recovery

NETGEAR recommends that you enable password recovery if you change the password for the router's user name of admin. You then have an easy way to recover the password if it is forgotten. This recovery process is supported in Internet Explorer, Firefox, and Chrome browsers, but not in the Safari browser.

➤ **To set up password recovery:**

1. Select the **Enable Password Recovery** check box.
2. Select two security questions and provide answers to them.

N300 Personal Router PR2000

3. Click **Apply** to save your changes.

When you use your browser to access the router, the login window displays. If password recovery is enabled, when you click Cancel, the password recovery process starts. You can then enter the saved answers to the security questions to recover the password.

8 Advanced Settings

8

Fine-tuning your network

This chapter describes the advanced features of your router. This information is for users with a solid understanding of networking concepts who want to set up the router for unique situations such as remote access from the Internet by IP or domain name.

This chapter includes the following sections:

- *Advanced Wireless Settings*
- *Wireless Repeating Function (WDS)*
- *Port Forwarding and Port Triggering*
- *Set Up Port Forwarding to Local Servers*
- *Set Up Port Triggering*
- *Dynamic DNS*
- *Static Routes*
- *Remote Management*
- *USB Settings*
- *Universal Plug and Play*
- *IPv6*
- *Traffic Meter*

Advanced Wireless Settings

Select **Advanced > Advanced Setup > Wireless Settings** to display the following screen:



The following settings are available in this screen for the 2.4 GHz and 5 GHz bands:

Enable Wireless Router Radio. You can completely turn off the wireless portion of the wireless router by clearing this check box. Select this check box again to enable the wireless portion of the router. When the wireless radio is disabled, other members of your household can use the router by connecting their computers to the router with an Ethernet cable.

Enable 20/40 MHz Coexistence. This applies only to the 2.4 GHz band. The 20/40 MHz coexistence function is enabled by default when the wireless mode is set to Up to 300 mbps (40 MHz), which is required for Wi-Fi certification. This check box is grayed out if the wireless mode is set to Up to 130 Mbps.

The router can run in either 40 MHz mode or 20 MHz mode when the wireless mode is set to Up to 300 Mbps. When the Enable 20/40 MHz Coexistence check box is selected, the router runs in 40 MHz mode unless there is another nearby WiFi network in the area already running in 40 MHz mode or there is a wireless access point on the secondary channel. If that happens, the router runs in 20 MHz mode to coexist with that network.

If you want the router to always run in 40 MHz mode, clear this check box and click **Apply**.

Note: The Fragmentation Length, CTS/RTS Threshold, and Preamble Mode options are reserved for wireless testing and advanced configuration only. Do not change these settings.

Turn off wireless signal by schedule. You can use this feature to turn off the wireless signal from your router at times when you do not need a wireless connection. For example, you could turn it off for the weekend if you leave town.

WPS Settings. You can add WPS devices to your network.

AP Mode. You can make the PR2000 function as an access point.

Wireless Card Access List. Click the **Set Up Access List** button to display the Wireless Card Access List screen. On this screen, you can restrict access to your network to specific devices based on their MAC address.

Wireless Repeating Function (WDS)

You can set the N300 Personal Router up to be used as a wireless access point (AP). This enables the router to act as a wireless repeater. A wireless repeater connects to another wireless router as a client where the network to which it connects becomes the ISP service.

Wireless repeating is a type of Wireless Distribution System (WDS). A WDS allows a wireless network to be expanded through multiple access points instead of using a wired backbone to link them. The following figure shows a wireless repeating scenario.

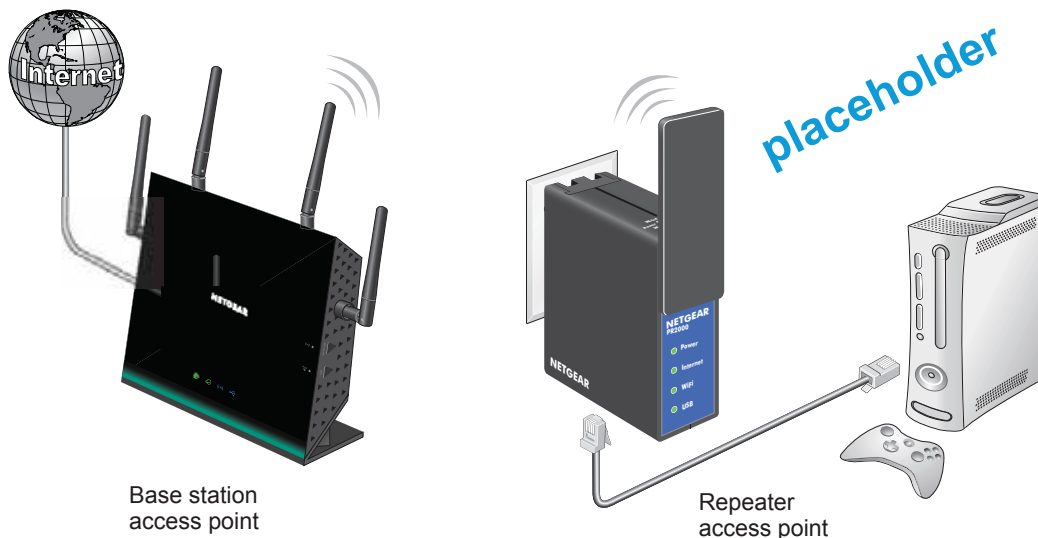

Figure 15. Wireless repeating scenario

Note: If you use the wireless repeating function, you need to select either **WEP** or **None** as a security option in the Wireless Setup screen. The WEP option displays only if you select the wireless mode Up to 54 Mbps in the Wireless Setup screen.

Wireless base station. The router acts as the parent access point, bridging traffic to and from the child repeater access point, as well as handling wireless and wired local computers. To configure this mode, you have to know the MAC addresses of the child repeater access point.

Wireless repeater. The router sends all traffic from its local wireless or wired computers to a remote access point. To configure this mode, you have to know the MAC address of the remote parent access point.

The PR2000 router is always in dual-band concurrent mode, unless you turn off one radio. If you enable the wireless repeater in either radio band, the wireless base station or wireless repeater cannot be enabled in the other radio band. However, if you enable the wireless base station in either radio band and use the other radio band as a wireless router or wireless base station, dual-band concurrent mode is not affected.

To set up a wireless network with WDS, the following conditions have to be met for both access points:

- Both access points have to use the same SSID, wireless channel, and encryption mode.
- Both access points have to be on the same LAN IP subnet. That is, all the access point LAN IP addresses are in the same network.
- All LAN devices (wired and wireless computers) have to be configured to operate in the same LAN network address range as the access points.

Wireless Repeating Function

Select **Advanced > Advanced Setup > Wireless Repeating** to view or change wireless repeater settings for the router.



- **Enable Wireless Repeating Function.** Select the check box for the 2.4 GHz or 5 GHz network to use the wireless repeating function.

Wireless MAC of this router. This field displays the MAC address for your router for your reference. Enter this MAC address in the corresponding Wireless Repeating Function screen of the other access point you are using.

- **Wireless Repeater.** If your router is the repeater, select this check box.

Disable Wireless Client Association. If your router is the repeater, selecting this check box means that wireless clients cannot associate with it. Only LAN client associations are allowed.

- If you are setting up a point-to-point bridge, select this check box.
- If you want all client traffic to go through the other access point (repeater with wireless client association), leave this check box cleared.

Repeater IP Address. If your router is the repeater, enter the IP address of the other access point.

Base Station MAC Address. If your router is the repeater, enter the MAC address for the access point that is the base station.

- **Wireless Base Station.** If your router is the base station, select this check box.

Disable Wireless Client Association. If your router is the base station, selecting this check box means that wireless clients cannot associate with it. Only LAN client associations are allowed.

Repeater MAC Address (1 through 4). If your router is the base station, it can act as the “parent” of up to four other access points. Enter the MAC addresses of the other access points in these fields.

Set Up the Base Station

The wireless repeating function works only in hub and spoke mode. The units cannot be daisy-chained. You have to know the wireless settings for both units. You have to know the MAC address of the remote unit. First, set up the base station, and then set up the repeater.

➤ **To set up the base station:**

1. Set up both units with the same wireless settings (SSID, mode, channel, and security). Note that the wireless security option has to be set to None or WEP.

2. Select **Advanced > Advanced Setup > Wireless Repeating Function** to display the Wireless Repeating Function screen.



3. For the frequency you want to use (2.4 GHz or 5 GHz), select the **Enable Wireless Repeating Function** check box and select the **Wireless Base Station** radio button.
4. Enter the MAC address for one or more repeater units.
5. Click **Apply** to save your changes.

Set Up a Repeater Unit

Use a wired Ethernet connection to set up the repeater unit to avoid conflicts with the wireless connection to the base station.

Note: If you are using the PR2000 base station with a non-NETGEAR router as the repeater, you might need to change more configuration settings. In particular, you should disable the DHCP server function on the wireless repeater AP.

➤ To configure the router as a repeater unit:

1. Log in to the router that will be the repeater. Select **Basic > Wireless Settings** and verify that the wireless settings match the base unit exactly. The wireless security option has to be set to **WEP** or **None**.
2. Select **Advanced > Wireless Repeating Function**, and select the **Enable Wireless Repeating Function** check box for the frequency you want and the **Wireless Repeater** radio button.
3. Fill in the Repeater IP Address field. This IP address has to be in the same subnet as the base station, but different from the LAN IP of the base station.
4. Click **Apply** to save your changes.

5. Verify connectivity across the LANs.

A computer on any wireless or wired LAN segment of the router connects to the Internet or share files and printers with any other wireless or wired computer or server connected to the other access point.

Port Forwarding and Port Triggering

By default, the router blocks inbound traffic from the Internet to your computers except replies to your outbound traffic. You might need to create exceptions to this rule for these purposes:

- To allow remote computers on the Internet to access a server on your local network.
- To allow certain applications and games to work correctly when their replies are not recognized by your router.

Your router provides two features for creating these exceptions: port forwarding and port triggering. The next sections provide background information to help you understand how port forwarding and port triggering work, and the differences between the two.

Remote Computer Access Basics

When a computer on your network needs to access a computer on the Internet, your computer sends your router a message containing the source and destination address and process information. Before forwarding your message to the remote computer, your router has to modify the source information and create and track the communication session so that replies can be routed back to your computer.

Here is an example of normal outbound traffic and the resulting inbound responses:

1. You open a browser, and your operating system assigns port number 5678 to this browser session.
2. You type `http://www.example.com` into the URL field, and your computer creates a web page request message with the following address and port information. The request message is sent to your router.

Source address. Your computer's IP address.

Source port number. 5678, which is the browser session.

Destination address. The IP address of `www.example.com`, which your computer finds by asking a DNS server.

Destination port number. 80, which is the standard port number for a web server process.

3. Your router creates an entry in its internal session table describing this communication session between your computer and the web server at `www.example.com`. Before sending the web page request message to `www.example.com`, your router stores the original information and then modifies the source information in the request message, performing Network Address Translation (NAT):

- The source address is replaced with your router's public IP address. This is necessary because your computer uses a private IP address that is not globally unique and cannot be used on the Internet.
- The source port number is changed to a number chosen by the router, such as 33333. This is necessary because two computers could independently be using the same session number.

Your router then sends this request message through the Internet to the web server at `www.example.com`.

4. The web server at `www.example.com` composes a return message with the requested web page data. The return message contains the following address and port information. The web server then sends this reply message to your router.

Source address. The IP address of `www.example.com`.

Source port number. 80, which is the standard port number for a web server process.

Destination address. The public IP address of your router.

Destination port number. 33333.

5. Upon receiving the incoming message, your router checks its session table to determine whether an active session for port number 33333 exists. Finding an active session, the router then modifies the message to restore the original address information replaced by NAT. Your router sends this reply message to your computer, which displays the web page from `www.example.com`. The message now contains the following address and port information.

Source address. The IP address of `www.example.com`.

Source port number. 80, which is the standard port number for a web server process.

Destination address. Your computer's IP address.

Destination port number. 5678, which is the browser session that made the initial request.

6. When you finish your browser session, your router eventually detects a period of inactivity in the communications. Your router then removes the session information from its session table, and incoming traffic is no longer accepted on port number 33333.

Port Triggering to Open Incoming Ports

In the preceding example, requests are sent to a remote computer by your router from a particular service port number, and replies from the remote computer to your router are directed to that port number. If the remote server sends a reply to a different port number, your router does not recognize it and discards it. However, some application servers (such as FTP and IRC servers) send replies to multiple port numbers. Using the port triggering function of your router, you can tell the router to open additional incoming ports when a particular outgoing port originates a session.

An example is Internet Relay Chat (IRC). Your computer connects to an IRC server at destination port 6667. The IRC server not only responds to your originating source port, but

also sends an “identify” message to your computer on port 113. Using port triggering, you can tell the router, “When you initiate a session with destination port 6667, you have to also allow incoming traffic on port 113 to reach the originating computer.” Using steps similar to the preceding example, the following sequence shows the effects of the port triggering rule you have defined:

1. You open an IRC client program to start a chat session on your computer.
2. Your IRC client composes a request message to an IRC server using a destination port number of 6667, the standard port number for an IRC server process. Your computer then sends this request message to your router.
3. Your router creates an entry in its internal session table describing this communication session between your computer and the IRC server. Your router stores the original information, performs Network Address Translation (NAT) on the source address and port, and sends this request message through the Internet to the IRC server.
4. Noting your port triggering rule and having observed the destination port number of 6667, your router creates an additional session entry to send any incoming port 113 traffic to your computer.
5. The IRC server sends a return message to your router using the NAT-assigned source port (as in the previous example, say port 33333) as the destination port. The IRC server also sends an identify message to your router with destination port 113.
6. Upon receiving the incoming message to destination port 33333, your router checks its session table to determine whether an active session for port number 33333 exists. Finding an active session, the router restores the original address information replaced by NAT and sends this reply message to your computer.
7. Upon receiving the incoming message to destination port 113, your router checks its session table and learns that an active session for port 113 is associated with your computer. The router replaces the message’s destination IP address with your computer’s IP address and forwards the message to your computer.
8. When you finish your chat session, your router eventually senses a period of inactivity in the communications. The router then removes the session information from its session table, and incoming traffic is no longer accepted on port numbers 33333 or 113.

To configure port triggering, you need to know which inbound ports the application needs. Also, you need to know the number of the outbound port that triggers the opening of the inbound ports. You can usually determine this information by contacting the publisher of the application or user groups or newsgroups.

Note: Only one computer at a time can use the triggered application.

Port Forwarding to Permit External Host Communications

In both of the preceding examples, your computer initiates an application session with a server computer on the Internet. However, you might need to allow a client computer on the Internet to initiate a connection to a server computer on your network. Normally, your router ignores any inbound traffic that is not a response to your own outbound traffic. You can configure exceptions to this default rule by using the port forwarding feature.

A typical application of port forwarding can be shown by reversing the client-server relationship from the previous web server example. In this case, a remote computer's browser needs to access a web server running on a computer in your local network. Using port forwarding, you can tell the router, "When you receive incoming traffic on port 80 (the standard port number for a web server process), forward it to the local computer at 192.168.1.123." The following sequence shows the effects of the port forwarding rule you have defined:

1. The user of a remote computer opens a browser and requests a web page from `www.example.com`, which resolves to the public IP address of your router. The remote computer composes a web page request message with the following destination information:

Destination address. The IP address of `www.example.com`, which is the address of your router.

Destination port number. 80, which is the standard port number for a web server process.

The remote computer then sends this request message through the Internet to your router.

2. Your router receives the request message and looks in its rules table for any rules covering the disposition of incoming port 80 traffic. Your port forwarding rule specifies that incoming port 80 traffic should be forwarded to local IP address 192.168.1.123. Therefore, your router modifies the destination information in the request message:

The destination address is replaced with 192.168.1.123.

Your router then sends this request message to your local network.

3. Your web server at 192.168.1.123 receives the request and composes a return message with the requested web page data. Your web server then sends this reply message to your router.
4. Your router performs Network Address Translation (NAT) on the source IP address, and sends this request message through the Internet to the remote computer, which displays the web page from `www.example.com`.

To configure port forwarding, you need to know which inbound ports the application needs. You can usually determine this information by contacting the publisher of the application or the relevant user groups and newsgroups.

How Port Forwarding Differs from Port Triggering

The following points summarize the differences between port forwarding and port triggering:

- Port triggering is used by any computer on your network, although only one computer can use it at a time.
- Port forwarding is configured for a single computer on your network.
- Port triggering does not require that you know the computer's IP address in advance. The IP address is captured automatically.

- Port forwarding requires that you specify the computer’s IP address during configuration, and the IP address can never change.
- Port triggering requires specific outbound traffic to open the inbound ports, and the triggered ports are closed after a period of no activity.
- Port forwarding is always active and does not need to be triggered.

Set Up Port Forwarding to Local Servers

Using the port forwarding feature, you can allow certain types of incoming traffic to reach servers on your local network. For example, you might want to make a local web server, FTP server, or game server visible and available to the Internet.

Use the Port Forwarding screen to configure the router to forward specific incoming protocols to computers on your local network. In addition to servers for specific applications, you can also specify a default DMZ server to which all other incoming protocols are forwarded.

Before starting, you need to determine which type of service, application, or game you want to provide, and the local IP address of the computer that provides the service. The server computer has to always have the same IP address.

➤ To set up port forwarding:

Tip: To ensure that your server computer always has the same IP address, use the reserved IP address feature of your N300 Personal Router.

1. Select **Advanced Setup > Port Forwarding/Port Triggering** to display the following screen:



Port Forwarding is selected as the service type.

2. From the Service Name list, select the service or game that you host on your network. If the service does not appear in the list, see [Add a Custom Service](#) on page 94.

3. In the corresponding Server IP Address field, enter the last digit of the IP address of your local computer that provides this service.
4. Click **Add**. The service appears in the list in the screen.

Add a Custom Service

To define a service, game, or application that does not appear in the Service Name list, you have to first determine which port number or range of numbers used by the application. You can usually determine this information by contacting the publisher of the application or user groups or newsgroups.

➤ **To add a custom service:**

1. Select **Advanced > Advanced Setup > Port Forwarding/Port Triggering**.
2. Select **Port Forwarding** as the service type.
3. Click the **Add Custom Service** button to display the following screen:

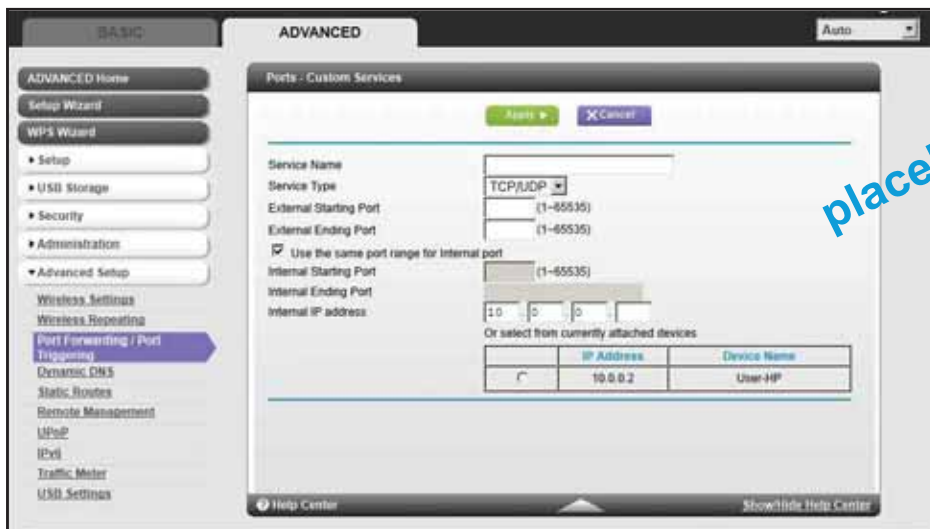

4. In the Service Name field, enter a descriptive name.
5. In the Service Type list, select the protocol. If you are unsure, select **TCP/UDP**.
6. Specify the port settings:
 - **External Starting Port** and **External Ending Port**. These are the starting number and ending number for the public ports at the Internet interface. For single port forwarding, the number in the External Starting Port and External Ending Port fields can be the same.
 - **Use the same port range for internal port**. This check box is selected by default. If you want to use different ports, clear this check box and specify the internal ports.
 - **Internal Starting Port** and **Internal Ending Port**. These are the starting number and ending number for the ports of a computer on the router's local area network (LAN). These are private ports. The router calculates the internal ending port.

7. In the Internal IP Address field, enter the IP address of your local computer that provides this service.
8. Click **Apply**. The service appears in the list in the Port Forwarding/Port Triggering screen.

Edit or Delete a Port Forwarding Entry

➤ **To edit or delete a port forwarding entry:**

1. In the table, select the radio button next to the service name.
2. Click **Edit Service** or **Delete Service**.

Application Example: Making a Local Web Server Public

If you host a web server on your local network, you can use port forwarding to allow web requests from anyone on the Internet to reach your web server.

➤ **To make a local web server public:**

1. Assign your web server either a fixed IP address or a dynamic IP address using DHCP address reservation. In this example, your router always gives your web server an IP address of 192.168.1.33.
2. In the Port Forwarding screen, configure the router to forward the HTTP service to the local address of your web server at **192.168.1.33**. HTTP (port 80) is the standard protocol for web servers.
3. (Optional) Register a host name with a Dynamic DNS service, and configure your router to use the name as described in *Dynamic DNS* on page 97. To access your web server from the Internet, a remote user has to know the IP address assigned by your ISP. However, if you use a Dynamic DNS service, the remote user can reach your server by a user-friendly Internet name, such as mynetgear.dyndns.org.

Set Up Port Triggering

Port triggering is a dynamic extension of port forwarding that is useful in these cases:

- More than one local computer needs port forwarding for the same application (but not simultaneously).
- An application needs to open incoming ports that are different from the outgoing port.

When port triggering is enabled, the router monitors outbound traffic looking for a specified outbound “trigger” port. When the router detects outbound traffic on that port, it remembers the IP address of the local computer that sent the data. The router then temporarily opens the specified incoming port or ports, and forwards incoming traffic on the triggered ports to the triggering computer.

Port forwarding creates a static mapping of a port number or range to a single local computer. Port triggering dynamically opens ports to any computer that needs them and can close the ports when they are no longer needed.

Note: If you use applications such as multiplayer gaming, peer-to-peer connections, real-time communications such as instant messaging, or remote assistance (a feature in Windows XP), you should also enable Universal Plug and Play (UPnP) according to the instructions in *Universal Plug and Play* on page 101.

To set up port triggering, you need to know which inbound ports the application needs. Also, you need to know the number of the outbound port that triggers the opening of the inbound ports. You can usually determine this information by contacting the publisher of the application or user groups or newsgroups.

➤ **To set up port triggering:**

1. Select **Advanced > Advanced Setup > Port Forwarding/Port Triggering**.
2. Select the **Port Triggering** radio button to display the port triggering information.



3. Clear the **Disable Port Triggering** check box if it is selected.

Note: If the *Disable Port Triggering* check box is selected after you configure port triggering, port triggering is disabled. However, any port triggering configuration information you added to the router is retained even though it is not used.

4. In the **Port Triggering Timeout** field, enter a value up to 9999 minutes. This value controls the inactivity timer for the designated inbound ports. The inbound ports close when the inactivity time expires. This is required because the router cannot be sure when the application has terminated.

- Click **Add Service** to display the following screen:



- In the Service Name field, type a descriptive service name.
- In the Service User list, select **Any** (the default) to allow this service to be used by any computer on the Internet. Otherwise, select **Single address**, and enter the IP address of one computer to restrict the service to a particular computer.
- Select the service type, either **TCP** or **UDP** or both (**TCP/UDP**). If you are not sure, select TCP/UDP.
- In the Triggering Port field, enter the number of the outbound traffic port that causes the inbound ports to open.
- Enter the inbound connection port information in the Connection Type, Starting Port, and Ending Port fields.
- Click **Apply**. The service appears in the Port Triggering Portmap table.

Dynamic DNS

If your Internet service provider (ISP) gave you a permanently assigned IP address, you can register a domain name and have that name linked with your IP address by public Domain Name Servers (DNS). However, if your Internet account uses a dynamically assigned IP address, you do not know in advance what your IP address will be, and the address can change frequently. In this case, you can use a commercial Dynamic DNS service. This type of service lets you register your domain to their IP address and forwards traffic directed at your domain to your frequently changing IP address.

If your ISP assigns a private WAN IP address (such as 192.168.x.x or 10.x.x.x), the Dynamic DNS service will not work because private addresses are not routed on the Internet.

Your router contains a client that can connect to the Dynamic DNS service provided by DynDNS.org. First visit their website at <http://www.dyndns.org> and obtain an account and host name that you configure in the router. Then, whenever your ISP-assigned IP address changes, your router automatically contacts the Dynamic DNS service provider, logs in to

your account, and registers your new IP address. If your host name is hostname, for example, you can reach your router at <http://hostname.dyndns.org>.

On the Advanced tab, select **Advanced Setup > Dynamic DNS** to display the following screen:



placeholder

➤ **To set up Dynamic DNS:**

1. Register for an account with one of the Dynamic DNS service providers whose URLs appear in the Service Provider list.
2. Select the **Use a Dynamic DNS Service** check box.
3. Select the URL of your Dynamic DNS service provider. For example, for DynDNS.org, select **www.dyndns.org**.
4. Type the host name (or domain name) that your Dynamic DNS service provider gave you.
5. Type the user name for your Dynamic DNS account. This is the name that you use to log in to your account, not your host name.
6. Type the password (or key) for your Dynamic DNS account.
7. Click **Apply** to save your configuration.

Static Routes

Static routes provide additional routing information to your router. Under usual circumstances, the router has adequate routing information after it has been configured for Internet access, and you do not need to configure additional static routes. You have to configure static routes only for unusual cases such as multiple routers or multiple IP subnets located on your network.

As an example of when a static route is needed, consider the following case:

- Your primary Internet access is through a cable modem to an ISP.

N300 Personal Router PR2000

- You have an ISDN router on your home network for connecting to the company where you are employed. This router's address on your LAN is 192.168.1.100.
- Your company's network address is 134.177.0.0.

When you first configured your router, two implicit static routes were created. A default route was created with your ISP as the gateway, and a second static route was created to your local network for all 192.168.1.x addresses. With this configuration, if you attempt to access a device on the 134.177.0.0 network, your router forwards your request to the ISP. The ISP forwards your request to the company where you are employed, and the request is denied by the company's firewall.

In this case you have to define a static route, telling your router that 134.177.0.0 should be accessed through the ISDN router at 192.168.1.100. In this example:

- The Destination IP Address and IP Subnet Mask fields specify that this static route applies to all 134.177.x.x addresses.
- The Gateway IP Address field specifies that all traffic for these addresses should be forwarded to the ISDN router at 192.168.1.100.
- A metric value of 1 works since the ISDN router is on the LAN.
- Private is selected only as a precautionary security measure in case RIP is activated.

➤ To set up a static route:

1. Select **Advanced > Advanced Setup > Static Routes**, and click **Add** to display the following screen:



2. In the **Route Name** field, type a **name** for this static route (for identification purposes only.)
3. Select the **Private** check box if you want to limit access to the LAN only. If Private is selected, the static route is not reported in RIP.
4. Select the **Active** check box to make this route effective.
5. Type the IP address of the final destination.
6. Type the IP subnet mask for this destination. If the destination is a single host, type **255.255.255.255**.

N300 Personal Router PR2000

7. Type the gateway IP address, which has to be a router on the same LAN segment as the N300 Personal Router.
8. Type a number between 1 and 15 as the metric value.
This value represents the number of routers between your network and the destination. Usually, a setting of 2 or 3 works, but if this is a direct connection, set it to 1.
9. Click **Apply** to add the static route.

Remote Management

The remote management feature lets you upgrade or check the status of your N300 Personal Router over the Internet.

➤ **To set up remote management:**

1. Select **Advanced > Advanced Setup > Remote Management**.



Note: Be sure to change the router's default login password to a secure password. The ideal password should contain no dictionary words from any language and contain uppercase and lowercase letters, numbers, and symbols. It can be up to 30 characters.

2. Select the **Turn Remote Management On** check box.
3. Under **Allow Remote Access By**, specify the external IP addresses allowed to access the router's remote management.

Note: For enhanced security, restrict access to as few external IP addresses as practical.

- To allow access from a single IP address on the Internet, select **Only This Computer**. Enter the IP address that allows access.
 - To allow access from a range of IP addresses on the Internet, select **IP Address Range**. Enter a beginning and ending IP address to define the allowed range.
 - To allow access from any IP address on the Internet, select **Everyone**.
4. Specify the port number for accessing the web management interface.
- Normal web browser access uses the standard HTTP service port 80. For greater security, enter a custom port number for the remote web management interface. Choose a number between 1024 and 65535, but do not use the number of any common service port. The default is 8080, which is a common alternate for HTTP.
5. Click **Apply** to have your changes take effect.
- When accessing your router from the Internet, type your router's WAN IP address into your browser's address or location field followed by a colon (:) and the custom port number. For example, if your external address is 134.177.0.123 and you use port number 8080, enter **http://134.177.0.123:8080** in your browser.

USB Settings

For added security, the router can be set up to share only approved USB devices. See [Specify Approved USB Devices](#) on page 64 for the procedure.

Universal Plug and Play

Universal Plug and Play (UPnP) helps devices, such as Internet appliances and computers, to access the network and connect to other devices as needed. UPnP devices can automatically discover the services from other registered UPnP devices on the network.

Note: If you use applications such as multiplayer gaming, peer-to-peer connections, or real-time communications such as instant messaging or remote assistance (a feature in Windows XP), you should enable UPnP.

➤ To turn on Universal Plug and Play:

1. Select **Advanced > Advanced Setup > UPnP**. The UPnP screen displays.



2. The available settings and information in this screen are:

Turn UPnP On. UPnP can be enabled or disabled for automatic device configuration. The default setting for UPnP is disabled. If this check box is not selected, the router does not allow any device to automatically control the resources, such as port forwarding (mapping), of the router.

Advertisement Period. The advertisement period is how often the router broadcasts its UPnP information. This value can range from 1 to 1440 minutes. The default period is 30 minutes. Shorter durations ensure that control points have current device status at the expense of additional network traffic. Longer durations can compromise the freshness of the device status, but can significantly reduce network traffic.

Advertisement Time to Live. The time to live for the advertisement is measured in hops (steps) for each UPnP packet sent. The time to live hop count is the number of steps a broadcast packet is allowed to propagate for each UPnP advertisement before it disappears. The number of hops can range from 1 to 255. The default value for the advertisement time to live is 4 hops, which should be fine for most home networks. If you notice that some devices are not being updated or reached correctly, it might be necessary to increase this value.

UPnP Portmap Table. The UPnP Portmap Table displays the IP address of each UPnP device currently accessing the router and which ports (internal and external) that device has opened. The UPnP Portmap Table also displays what type of port is open and whether that port is still active for each IP address.

3. Click **Apply** to save your settings.

IPv6

You can use this feature to set up an IPv6 Internet connection type if NETGEAR genie does not detect it automatically.

➤ **To set up an IPv6 Internet connection type:**

1. Select **Advanced > Advanced Setup > IPv6** to display the following screen:



2. Select the IPv6 connection type from the list of Internet connection types. Your Internet service provider (ISP) can provide this information.
 - If your ISP did not provide details, you can select **6to4 Tunnel**.
 - If you are not sure, select **Auto Detect** so that the router detects the IPv6 type that is in use.
 - If your Internet connection does not use PPPoE, DHCP, or fixed, but is IPv6, then select **Auto Config**.
3. Click **Apply** so that your changes take effect.

Traffic Meter

Traffic metering allows you to monitor the volume of Internet traffic passing through your router's Internet port. With the traffic meter utility, you can set limits for traffic volume, set a monthly limit, and get a live update of traffic usage.

➤ To monitor Internet traffic:

1. Click **Advanced > Advanced Setup > Traffic Meter** to display the following screen:

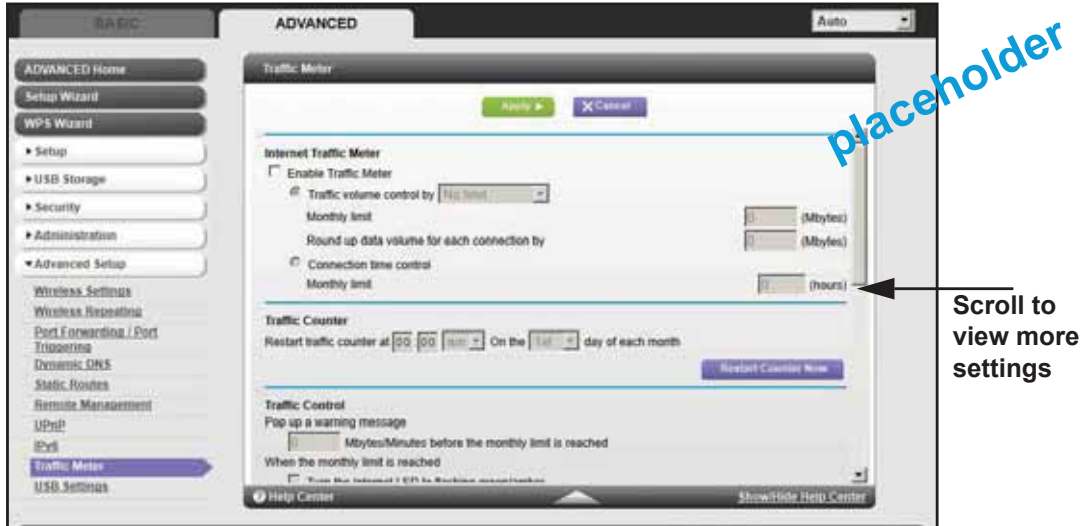

2. To enable the traffic meter, select the **Enable Traffic Meter** check box.
3. If you would like to record and restrict the volume of Internet traffic, select the **Traffic volume control by** radio button. You can select one of the following options for controlling the traffic volume:
 - **No Limit.** No restriction is applied when the traffic limit is reached.
 - **Download only.** The restriction is applied to incoming traffic only.
 - **Both Directions.** The restriction is applied to both incoming and outgoing traffic.
4. You can limit the amount of data traffic allowed per month by specifying how many Mbytes per month are allowed or by specifying how many hours of traffic are allowed.
5. Set the **Traffic Counter** to begin at a specific time and date.
6. Set up **Traffic Control** to issue a warning message before the monthly limit of Mbytes or hours is reached. You can select one of the following to occur when the limit is attained:
 - The Internet LED blinks green or amber.
 - The Internet connection is disconnected and disabled.
7. Set up Internet Traffic Statistics to monitor the data traffic by clicking the **Traffic Status** button. You get a live update on Internet traffic status on your router.
8. Click **Apply** to save your settings.

8 Troubleshooting

This chapter provides information to help you diagnose and solve problems you might have with your router. If you do not find the solution here, visit the NETGEAR support site at <http://support.netgear.com> for product and contact information.

This chapter contains the following sections:

- *Quick Tips*
- *Troubleshoot with the LEDs*
- *Cannot Log In to the Router*
- *Cannot Access the Internet*
- *Changes Not Saved*
- *Incorrect Date or Time*
- *Wireless Connectivity*
- *Restore the Factory Settings and Password*
- *Troubleshoot Your Network Using the Ping Utility*

Quick Tips

This section describes tips for troubleshooting some common problems.

Sequence to Restart Your Network

Be sure to restart your network in this sequence:

1. Turn off *and* unplug the modem.
2. Turn off the router and computers.
3. Plug in the modem and turn it on. Wait 2 minutes.
4. Turn on the router and wait 2 minutes.
5. Turn on the computers.

Check Ethernet Cable Connections

Make sure that the Ethernet cables are securely plugged in.

- The Internet status LED on the router is lit if the Ethernet cable connecting the router and the modem is plugged in securely and the modem and router are turned on.
- For each powered-on computer connected to the router by an Ethernet cable, the corresponding numbered router LAN port LED is lit.

Wireless Settings

Make sure that the wireless settings in the computer and router match exactly:

- For a wirelessly connected computer, the wireless network name (SSID) and wireless security settings of the router and wireless computer need to match exactly.
- If you set up an access list in the Advanced Wireless Settings screen, you have to add each wireless computer's MAC address to the router's access list.

Network Settings

Make sure that the network settings of the computer are correct:

- Wired and wirelessly connected computers need to have network (IP) addresses on the same network as the router. The simplest way to do this is to configure each computer to obtain an IP address automatically using DHCP.
- Some cable modem service providers require you to use the MAC address of the computer initially registered on the account. You can view the MAC address in the Attached Devices screen.

Troubleshoot with the LEDs

After you turn on power to the router, the following sequence of events should occur:

1. When power is first applied, verify that the Power/Test LED  is lit.
2. Verify that the Power/Test LED turns amber within a few seconds, indicating that the self-test is running.
3. After approximately 30 seconds, verify:
 - The Power/Test LED is solid green.
 - The Internet LED is lit.
 - A numbered Ethernet port LED is lit for any local port that is connected to a computer. This indicates that a link has been established to the connected device.

The LEDs on the front panel of the router can be used for troubleshooting.

Power/Test LED Is Off or Blinking

- Make sure that the power cord is securely connected to your router and that the power adapter is securely connected to a functioning power outlet.
- Make sure that you are using the 12V DC, 2.5A power adapter that NETGEAR supplied for this product.
- If the Power/Test LED blinks slowly and continuously, the router firmware is corrupted. This can happen if a firmware upgrade is interrupted, or if the router detects a problem with the firmware. If the error persists, you have a hardware problem. For recovery instructions or help with a hardware problem, contact technical support at <http://support.netgear.com/general/contact/default.aspx>.

Power/Test LED Stays Amber

When the router is turned on, the Power/Test LED turns amber for about 20 seconds and then turns green. If the LED does not turn green, the router has a problem.

If the Power/Test LED is still amber 1 minute after you turn on power to the router:

1. Turn the power off and back on to see if the router recovers.
2. Press and hold the **Restore Factory Settings** button to return the router to its factory settings. See *Factory Settings* on page 115.

If the error persists, you might have a hardware problem and should contact technical support at www.netgear.com/support.

LEDs Never Turn Off

When the router is turned on, the LEDs light for about 10 seconds and then turn off. If all the LEDs stay lit, the fault is within the router.

If all LEDs are still lit 1 minute after power-up:

- Cycle the power to see if the router recovers.
- Press and hold the **Restore Factory Settings** button to return the router to its factory settings. See *Factory Settings* on page 115.

If the error persists, you might have a hardware problem and should contact technical support at www.netgear.com/support.

Internet or Ethernet Port LEDs Are Off

If either the Ethernet port LEDs or the Internet LED does not light when the Ethernet connection is made, check the following:

- Make sure that the Ethernet cable connections are secure at the router and at the modem or computer.
- Make sure that power is turned on to the connected modem or computer.
- Be sure that you are using the correct cable:

When connecting the router's Internet port to a cable or DSL modem, use the cable that was supplied with the cable or DSL modem. This cable could be a standard straight-through Ethernet cable or an Ethernet crossover cable.

Wireless LEDs Are Off

If the Wireless LEDs stay off, check to see if the Wireless On/Off button on the router has been pressed. This button turns the wireless radios in the router on and off. The Wireless LEDs are lit when the wireless radio is turned on.

The Push 'N' Connect (WPS) Button Blinks Green

If after you use the WPS function the button blinks green, check the following:

- Make sure that you are using the button and not the router's built-in registrar.
- Check that PIN verification has succeeded for the wireless device you are adding to the wireless network.
- Make sure that you have not pressed the WPS button on the side of the router after disabling the WPS feature (you logged in to the router and disabled this previously).
- Check that the router is not in the temporary AP setup locked state (if you are using the wireless repeater function).

Cannot Log In to the Router

If you are unable to log in to the router from a computer on your local network, check the following:

- If you are using an Ethernet-connected computer, check the Ethernet connection between the computer and the router as described in the previous section.
- Make sure that your computer's IP address is on the same subnet as the router. If you are using the recommended addressing scheme, your computer's address should be in the range of 192.168.1.2 to 192.168.1.254.
- If your computer's IP address is shown as 169.254.x.x, recent versions of Windows and Mac OS generate and assign an IP address if the computer cannot reach a DHCP server. These autogenerated addresses are in the range of 169.254.x.x. If your IP address is in this range, check the connection from the computer to the router, and reboot your computer.
- If your router's IP address was changed and you do not know the current IP address, clear the router's configuration to factory defaults. This sets the router's IP address to 192.168.1.1. This procedure is explained in *Factory Settings* on page 115.
- Make sure that your browser has Java, JavaScript, or ActiveX enabled. If you are using Internet Explorer, click **Refresh** to be sure that the Java applet is loaded.
- Try quitting the browser and launching it again.
- Make sure that you are using the correct login information. The factory default login name is **admin**, and the password is **password**. Make sure that Caps Lock is off when you enter this information.
- If you are attempting to set up your NETGEAR router as an additional router behind an existing router in your network, consider replacing the existing router instead. NETGEAR does not support such a configuration.
- If you are attempting to set up your NETGEAR router as a replacement for an ADSL gateway in your network, the router cannot perform many gateway services, such as, converting ADSL or cable data into Ethernet networking information. NETGEAR does not support such a configuration.

Cannot Access the Internet

If you can access your router but you are unable to access the Internet, first determine whether the router can obtain an IP address from your Internet service provider (ISP). Unless your ISP provides a fixed IP address, your router requests an IP address from the ISP. You can determine whether the request was successful using the Router Status screen.

➤ To check the WAN IP address:

1. Start your browser, and select an external site such as <http://www.netgear.com>.
2. Access the router interface at <http://www.routerlogin.net>.
3. Select **Administration > Router Status**.
4. Check that an IP address is shown for the Internet port. If 0.0.0.0 is shown, your router has not obtained an IP address from your ISP.

If your router cannot obtain an IP address from the ISP, you might need to force your cable or DSL modem to recognize your new router by restarting your network, as described in *Sequence to Restart Your Network* on page 106.

If your router is still unable to obtain an IP address from the ISP, the problem might be one of the following:

- Your Internet service provider (ISP) might require a login program. Ask your ISP whether they require PPP over Ethernet (PPPoE) or some other type of login.
- If your ISP requires a login, the login name and password might be set incorrectly.
- Your ISP might check for your computer's host name. Assign the computer host name of your ISP account as the account name in the Internet Settings screen.
- Your ISP allows only one Ethernet MAC address to connect to Internet and might check for your computer's MAC address. In this case, do one of the following:
 - Inform your ISP that you have bought a new network device, and ask them to use the router's MAC address.
 - Configure your router to clone your computer's MAC address.

If your router can obtain an IP address, but your computer is unable to load any web pages from the Internet:

- Your computer might not recognize any DNS server addresses.

A DNS server is a host on the Internet that translates Internet names (such as www addresses) to numeric IP addresses. Typically, your ISP provides the addresses of one or two DNS servers for your use. If you entered a DNS address during the router's configuration, reboot your computer, and verify the DNS that address. You can configure your computer manually with DNS addresses, as explained in your operating system documentation.
- Your computer might not have the router configured as its TCP/IP gateway.

If your computer obtains its information from the router by DHCP, reboot the computer, and verify the gateway address.
- You might be running login software that is no longer needed.

If your ISP provided a program to log you in to the Internet (such as WinPoET), you no longer need to run that software after installing your router. You might need to go to Internet Explorer and select **Tools > Internet Options**, click the **Connections** tab, and select **Never dial a connection**.

Troubleshoot PPPoE

If you are using PPPoE, try troubleshooting your Internet connection.

➤ To troubleshoot a PPPoE connection:

1. Log in to the router.
2. Select **Administration > Router Status**.
3. Click **Connection Status**. If all of the steps indicate OK, your PPPoE connection is up and working.

If any of the steps indicate Failed, you can attempt to reconnect by clicking **Connect**. The router continues to attempt to connect indefinitely.

If you cannot connect after several minutes, you might be using an incorrect service name, user name, or password. There might also be a provisioning problem with your ISP.

Note: Unless you connect manually, the router does not authenticate using PPPoE until data is transmitted to the network.

Troubleshoot Internet Browsing

If your router can obtain an IP address but your computer is unable to load any web pages from the Internet, check the following:

- Your computer might not recognize any DNS server addresses. A DNS server is a host on the Internet that translates Internet names (such as www addresses) to numeric IP addresses.

Typically, your ISP provides the addresses of one or two DNS servers for your use. If you entered a DNS address during the router's configuration, restart your computer.

Alternatively, you can configure your computer manually with a DNS address, as explained in the documentation for your computer.

- Your computer might not have the router configured as its default gateway.

Reboot the computer, and verify that the router address (www.routerlogin.net) is listed by your computer as the default gateway address.

- You might be running login software that is no longer needed. If your ISP provided a program to log you in to the Internet (such as WinPoET), you no longer need to run that software after installing your router. You might need to go to Internet Explorer and select **Tools > Internet Options**, click the **Connections** tab, and select **Never dial a connection**.

If the router does not save changes you have made in the browser interface, check the following:

- When entering configuration settings, be sure to click **Apply** before moving to another screen or tab, or your changes could be lost.
- Click **Refresh** or **Reload** in the web browser. The changes might have occurred, but the web browser might be caching the old configuration.

Changes Not Saved

If the router does not save the changes you make in the router interface, check the following:

- When entering configuration settings, always click the **Apply** button before moving to another screen or tab, or your changes are lost.
- Click the **Refresh** or **Reload** button in the web browser. The changes might have occurred, but the old settings might be in the web browser's cache.

Incorrect Date or Time

Select **Advanced > Security > Schedule** to display the current date and time. The router uses the Network Time Protocol (NTP) to obtain the current time from one of several network time servers on the Internet. Each entry in the log is stamped with the date and time of day. Problems with the date and time function can include the following:

- Date shown is January 1, 2000. This means the router has not successfully reached a network time server. Check that your Internet access is configured correctly. If you have finished setting up the router, wait at least 5 minutes, and check the date and time again.
- Time is off by one hour. The router does not automatically sense daylight savings time. In the Schedule screen, select the **Automatically adjust for daylight savings time** check box.

Wireless Connectivity

If you are having trouble connecting wirelessly to the router, try to isolate the problem.

- Does the wireless device or computer that you are using find your wireless network?
If not, check the Wireless LEDs on the front of the router. They should be lit. If they are not, you can press the **WiFi On/Off** button on the side of the router to turn the router's wireless radio back on. You need to press and hold the **WiFi On/Off** button until the LED status changes.
If you disabled the router's SSID broadcast, your wireless network is hidden and does not show up in your wireless client's scanning list. (By default, SSID broadcast is enabled.)
- Does your wireless device support the security that you are using for your wireless network (WPA or WPA2)?
- If you want to view the wireless settings for the router, use an Ethernet cable to connect a computer to a LAN port on the router. Then log in to the router and select **Setup > Wireless Settings** see (*Basic Wireless Settings* on page 36).

Note: Be sure to click **Apply** if you make changes.

Wireless Signal Strength

If your wireless device finds your network, but the signal strength is weak, check these conditions:

- Is your router too far from your computer, or too close? Place your computer near the router, but at least 6 feet away, and see whether the signal strength improves.
- Is your wireless signal blocked by objects between the router and your computer?

Restore the Factory Settings and Password

To restore the factory settings, erasing the current configuration, and changing the router's administration password back to **password**, you can:

- Use the Erase function of the router (see *Erase* on page 80).
- Use the Restore Factory Settings button on the back of the router. See *Factory Settings* on page 115. If you restore the factory settings and the router fails to restart, or the green Power/Test LED continues to blink, the unit might be defective. If the error persists, you might have a hardware problem and should contact technical support at <http://www.netgear.com/support>.

Troubleshoot Your Network Using the Ping Utility

Most network devices and routers contain a ping utility that sends an echo request packet to the designated device. The device then responds with an echo reply. You can easily troubleshoot a network by using the ping utility in your computer or workstation.

Test the LAN Path to Your Router

You can ping the router from your computer to verify that the LAN path to your router is set up correctly.

➤ **To ping the router from a running Windows computer:**

1. From the Windows toolbar, click **Start**, and select **Run**.
2. In the field provided, type **ping** followed by the IP address of the router, as in this example:
ping www.routerlogin.net
3. Click **OK**.

You should see a message like this one:

```
Pinging <IP address > with 32 bytes of data
```

If the path is working, you see this message:

```
Reply from < IP address >: bytes=32 time=NN ms TTL=xxx
```

If the path is not working, you see this message:

```
Request timed out
```

If the path is not functioning correctly, you could have one of the following problems:

- Wrong physical connections

For a wired connection, make sure that the numbered LAN port LED is on for the port to which you are connected.

Check that the appropriate LEDs are on for your network devices. If your router and computer are connected to a separate Ethernet switch, make sure that the link LEDs are on for the switch ports that are connected to your computer and router.

- Wrong network configuration

Verify that the Ethernet card driver software and TCP/IP software are both installed and configured on your computer.

Verify that the IP address for your router and your computer are correct and that the addresses are on the same subnet.

Test the Path from Your Computer to a Remote Device

After verifying that the LAN path works correctly, test the path from your computer to a remote device.

1. From the Windows toolbar, click the **Start** button, and select **Run**.
2. In the Windows Run window, type:

ping -n 10 <IP address>

where <IP address> is the IP address of a remote device such as your ISP DNS server.

If the path is functioning correctly, replies as shown in the previous section are displayed.

If you do not receive replies:

- Check that your computer has the IP address of your router listed as the default gateway. If the IP configuration of your computer is assigned by DHCP, this information is not visible in your computer's Network Control Panel. Verify that the IP address of the router is listed as the default gateway.
- Check to see that the network address of your computer (the portion of the IP address specified by the subnet mask) is different from the network address of the remote device.
- Check that your cable or DSL modem is connected and functioning.
- If your ISP assigned a host name to your computer, enter that host name as the account name in the Internet Settings screen.
- Your ISP could be rejecting the Ethernet MAC addresses of all but one of your computers.

Many broadband ISPs restrict access by allowing traffic only from the MAC address of your broadband modem, but some ISPs additionally restrict access to the MAC address of a single computer connected to that modem. If so, configure your router to "clone" or "spoof" the MAC address from the authorized computer.

Supplemental Information



This appendix provides factory default settings and technical specifications for the N300 Personal Router PR2000.

Factory Settings

You can return the router to its factory settings. Use the end of a paper clip or a similar object to press and hold the **Restore Factory Settings** button on the back of the router for at least 5 seconds. The router resets and returns to the factory settings. Your device returns to the factory configuration settings shown in the following table.

Table 3. Factory default settings

Feature		Default behavior
Router login	User login URL	www.routerlogin.com or www.routerlogin.net
	User name (case-sensitive)	admin
	Login password (case-sensitive)	password
Internet connection	WAN MAC address	Use default hardware address
	WAN MTU size	1500
	Port speed	10/100 Mbps Autosensing
Local network (LAN)	LAN IP	192.168.1.1
	Subnet mask	255.255.255.0
	DHCP server	Enabled
	DHCP range	192.168.1.2 to 192.168.1.254
	Time zone	Pacific time
	Time zone daylight saving time	Disabled
	Allow a registrar to configure this router	Enabled

N300 Personal Router PR2000

Table 3. Factory default settings (continued)

Feature		Default behavior
Local network (LAN) (continued)	DHCP starting IP address	192.168.1.2
	DHCP ending IP address	192.168.1.254
	DMZ	Disabled
	Time zone	GMT+1 for GR, PE, UK GMT+4 for RU GMT+7 for PR GMT+10 for AU
	Time zone adjusted for daylight savings time	Disabled
	SNMP	Disabled
Firewall	Inbound (communications coming in from the Internet)	Disabled (except traffic on port 80, the HTTP port)
	Outbound (communications going out to the Internet)	Enabled (all)
	Source MAC filtering	Disabled
Wireless	Wireless communication	Enabled
	SSID name	See router label
	Security	Enabled
	Broadcast SSID	Enabled
	Transmission speed	Auto*
	Country/region	United States in the US; otherwise varies by region
	RF channel	2.4 GHz: Auto
	Operating mode	Up to 300 Mbps
	Data rate	Best
	Output power	Full

*. Maximum wireless signal rate derived from IEEE Standard 802.11 specifications. Actual throughput varies. Network conditions and environmental factors, including volume of network traffic, building materials and construction, and network overhead, lower actual data throughput rate.

Technical Specifications

Table 4. PR2000 Router specifications

Feature	Description
Data and routing protocols	TCP/IP, RIP-1, RIP-2, DHCP, PPPoE, PPTP, Bigpond, Dynamic DNS, UPnP, and SMB
Power adapter	No power adapter. Input alternating current: 100-240V ~50-60 Hz, 0.3A
Dimensions	3.39 in. x 3.31 in. x 1.30 in. (86.5 mm x 86.2 mm x 32 mm)
Weight	161g (0.355 lbs)
Operating temperature	0° to 40° C (32° to 104°F)
Operating humidity	90% maximum relative humidity, noncondensing
Electromagnetic emissions	FCC Part 15 Class B VCCI Class B EN 55 022 (CISPR 22), Class B
LAN	10BASE-T or 100BASE-Tx, RJ-45
WAN	10BASE-T or 100BASE-Tx, RJ-45
Wireless	Maximum wireless signal rate complies with the IEEE 802.11 standard. See the footnote for the previous table.
Radio data rates	Auto Rate Sensing
Data encoding standards	IEEE 802.11n version 2.0 IEEE 802.11n, IEEE 802.11g, IEEE 802.11b 2.4 GHz IEEE 802.11n, IEEE 802.11a 5.0 GHz
Maximum computers per wireless network	Limited by the amount of wireless network traffic generated by each node (typically 50–70 nodes).
Operating frequency range	2.4 GHz 2.412–2.462 GHz (US) 2.412–2.472 GHz (Japan) 2.412–2.472 GHz (Europe ETSI)
802.11 security	WPA-PSK, WPA2-PSK, WEP, and WPA/WPA2 PSK.

Notification of Compliance



NETGEAR wireless routers, gateways, APs

Regulatory Compliance Information

This section includes user requirements for operating this product in accordance with National laws for usage of radio spectrum and operation of radio devices. Failure of the end-user to comply with the applicable requirements may result in unlawful operation and adverse action against the end-user by the applicable National regulatory authority.

This product's firmware limits operation to only the channels allowed in a particular Region or Country. Therefore, all options described in this user's guide may not be available in your version of the product.

Europe – EU Declaration of Conformity

Products bearing the **CE** marking comply with the following EU directives:

- EMC Directive 2004/108/EC
- Low Voltage Directive 2006/95/EC

If this product has telecommunications functionality, it also complies with the requirements of the following EU Directive:

- R&TTE Directive 1999/5/EC

Compliance with these directives implies conformity to harmonized European standards that are noted in the EU Declaration of Conformity.

For indoor use only. Valid in all EU member states, EFTA states, and Switzerland.

This device may not be used for setting up outdoor radio links in France and in some areas the RF output power may be limited to 10 mW EIRP in the frequency range of 2454 - 2483.5 MHz. For detailed information the end-user should contact the national spectrum authority in France.

FCC Requirements for Operation in the United States

FCC Information to User

This product does not contain any user serviceable components and is to be used with approved antennas only. Any product changes or modifications will invalidate all applicable regulatory certifications and approvals.

FCC Guidelines for Human Exposure

This equipment complies with FCC radiation exposure limits set forth for an uncontrolled environment. This equipment should be installed and operated with minimum distance of 20 cm between the radiator and your body. This transmitter must not be co-located or operating in conjunction with any other antenna or transmitter.

FCC Declaration of Conformity

We, NETGEAR, Inc., 350 East Plumeria Drive, San Jose, CA 95134, declare under our sole responsibility that the N300 Personal Router PR2000 complies with Part 15 Subpart B of FCC CFR47 Rules. Operation is subject to the following two conditions:

- This device may not cause harmful interference, and
- This device must accept any interference received, including interference that may cause undesired operation.

N300 Personal Router PR2000

FCC Radio Frequency Interference Warnings & Instructions

This equipment has been tested and found to comply with the limits for a Class B digital device, pursuant to Part 15 of the FCC Rules. These limits are designed to provide reasonable protection against harmful interference in a residential installation. This equipment uses and can radiate radio frequency energy and, if not installed and used in accordance with the instructions, may cause harmful interference to radio communications. However, there is no guarantee that interference will not occur in a particular installation. If this equipment does cause harmful interference to radio or television reception, which can be determined by turning the equipment off and on, the user is encouraged to try to correct the interference by one or more of the following methods:

- Reorient or relocate the receiving antenna.
- Increase the separation between the equipment and the receiver.
- Connect the equipment into an electrical outlet on a circuit different from that which the radio receiver is connected.
- Consult the dealer or an experienced radio/TV technician for help.

FCC Caution

- Any changes or modifications not expressly approved by the party responsible for compliance could void the user's authority to operate this equipment.
- This device complies with Part 15 of the FCC Rules. Operation is subject to the following two conditions: (1) This device may not cause harmful interference, and (2) this device must accept any interference received, including interference that may cause undesired operation.
- For product available in the USA and Canada market, only channel 1~11 can be operated. Selection of other channels is not possible.
- Pour les produits disponibles aux États-Unis / Canada du marché, seul le canal 1 à 11 peuvent être exploités. Sélection d'autres canaux n'est pas possible.
- This device and its antenna(s) must not be co-located or operation in conjunction with any other antenna or transmitter.
- Cet appareil et son antenne (s) ne doit pas être co-localisés ou fonctionnement en association avec une autre antenne ou transmetteur.

Canadian Department of Communications Radio Interference Regulations

This digital apparatus (N300 Personal Router PR2000) does not exceed the Class B limits for radio-noise emissions from digital apparatus as set out in the Radio Interference Regulations of the Canadian Department of Communications.

This Class [B] digital apparatus complies with Canadian ICES-003.

Cet appareil numérique de la classe [B] est conforme à la norme NMB-003 du Canada

Industry Canada

This device complies with RSS-210 of the Industry Canada Rules. Operation is subject to the following two conditions: (1) This device may not cause harmful interference, and (2) this device must accept any interference received, including interference that may cause undesired operation.

Caution:

Ce dispositif est conforme à la norme CNR-210 d'Industrie Canada applicable aux appareils radio exempts de licence. Son fonctionnement est sujet aux deux conditions suivantes: (1) le dispositif ne doit pas produire de brouillage préjudiciable, et (2) ce dispositif doit accepter tout brouillage reçu, y compris un brouillage susceptible de provoquer un fonctionnement indésirable.

IMPORTANT NOTE: Radiation Exposure Statement:

This equipment complies with IC radiation exposure limits set forth for an uncontrolled environment. This equipment should be installed and operated with minimum distance 20cm between the radiator & your body.

N300 Personal Router PR2000

NOTE IMPORTANTE: Déclaration d'exposition aux radiations:

Cet équipement est conforme aux limites d'exposition aux rayonnements IC établies pour un environnement non contrôlé. Cet équipement doit être installé et utilisé avec un minimum de 20 cm de distance entre la source de rayonnement et votre corps.

Interference Reduction Table

The table below shows the recommended minimum distance between NETGEAR equipment and household appliances to reduce interference (in feet and meters).

Household Appliance	Recommended Minimum Distance (in feet and meters)
Microwave ovens	30 feet / 9 meters
Baby Monitor - Analog	20 feet / 6 meters
Baby Monitor - Digital	40 feet / 12 meters
Cordless phone - Analog	20 feet / 6 meters
Cordless phone - Digital	30 feet / 9 meters
Bluetooth devices	20 feet / 6 meters
ZigBee	20 feet / 6 meters

Index

A

- access
 - remote **100**
 - viewing logs **78**
- access points **85**
- accessing remote computer **89**
- adding
 - custom services **94**
 - guest network **39**
 - priority rules **53**
 - QoS policy **52**
 - wireless devices **28**
- address reservation **51**
- advertisement period **102**
- alerts, emailing **70**
- applications, QoS for online gaming **53**
- approved USB devices **64**
- attached devices **32**
- authentication, required by mail server **71**
- automatic firmware checking **73**
- automatic Internet connection **43**

B

- backing up configuration **80**
- base station, setting up **87**
- blocking
 - inbound traffic **89**
 - keywords **67**
 - services **68**
 - sites **67**
- box contents **8**

C

- cables, checking **106**
- changes not saved, router **111**
- compliance **118**
- configuration file **79, 80**
- configuring
 - DMZ server **47**
 - Dynamic DNS **98**
 - NAT **46**

- port forwarding **93**
- port triggering **95**
- QoS **52**
- repeater unit **88**
- user-defined services **68**
- connecting wirelessly **8**
- country setting **43**
- crossover cable **108**
- CTS/RTS Threshold **84**
- custom service (port forwarding) **94**

D

- dashboard **26**
- data packets, fragmented **47**
- date and time **112**
- daylight savings time **112**
- default DMZ server **47**
- default factory settings **80, 115**
- default gateway **76**
- deleting
 - configuration **80**
 - keywords **67**
 - port forwarding entry **95**
 - QoS policy **56**
- denial of service (DoS) protection **66**
- devices, attached **32**
- DHCP server **50, 76**
- DHCP setting **75**
- DMZ server **47**
- DNS addresses
 - primary **31**
 - troubleshooting **110**
- DNS servers **89**
- Domain Name Server (DNS) addresses **31, 75**
- Dynamic DNS **97**

E

- electromagnetic emissions **117**
- email notices **70**
- erasing configuration **80**
- Ethernet cables, checking **106**

Ethernet LED, troubleshooting [107](#), [108](#)

F

factory default settings

list of [115](#)

restoring [80](#)

file sharing [59](#)

firmware version [74](#)

firmware, upgrading [26](#), [73](#)

fragmentation length [84](#)

fragmented data packets [47](#)

G

games, online, QoS for [53](#)

gateway IP address [31](#)

Genie, NETGEAR

settings, advanced [42](#)

settings, basic [29](#)

setup, initial [25](#)

using, after installation [25](#)

guest networks [39](#), [78](#)

H

host name [30](#)

host, trusted [67](#)

I

inbound traffic, allowing or blocking [89](#)

installing [25](#), [43](#)

Internet connection

setting up [30](#)

troubleshooting [109](#)

Internet LEDs, troubleshooting [107](#)

Internet port [43](#), [74](#)

Internet Relay Chat (IRC) [90](#)

Internet service provider (ISP)

account information [24](#)

Internet Setup screen fields [30](#)

Internet services, blocking access [68](#)

interval, poll [75](#)

IP addresses

current [75](#)

DHCP [24](#)

dynamic [97](#)

reserved [51](#)

IP subnet mask [75](#)

K

keywords [67](#)

L

LAN port

QoS for [54](#)

settings [74](#)

LAN setup [49](#)

language setting [43](#)

large files, sharing [60](#)

lease, DHCP [76](#)

LEDs

troubleshooting [107](#)

local servers, port forwarding to [93](#)

logging in [24](#), [25](#)

logs

emailing [70](#)

viewing [78](#)

M

MAC addresses

current [74](#)

QoS for [55](#)

mail server, outgoing [71](#)

maintenance settings [72](#)

managing router remotely [100](#)

menus, described [27](#)

metric value [100](#)

mixed mode security options [41](#)

MTU size [47](#)

multicasting [50](#)

N

NAT (Network Address Translation) [46](#), [47](#), [89](#)

NETGEAR Genie

settings, advanced [42](#)

settings, basic, initial [29](#)

setup, initial [25](#)

using, after installation [25](#)

Network Time Protocol (NTP) [112](#)

network, correct settings, checking [106](#)

network, restarting [106](#)

networks, guest [39](#), [78](#)

O

outgoing mail server [71](#)

P

- packets, fragmented [47](#)
- Parental Controls [32](#)
- passphrases
 - changing [38](#)
- password recovery, admin [81](#)
- password, restoring [113](#)
- photos, sharing [59](#)
- ping utility [113](#)
- poll interval [75](#)
- port filtering [68](#)
- port forwarding [89](#), [91](#), [92](#), [93](#)
- port numbers [68](#)
- port status [75](#)
- port triggering [89](#), [90](#), [92](#), [95](#)
- positioning the router [8](#)
- Power LED, troubleshooting [107](#)
- PPPoE (PPP over Ethernet) [110](#)
- Preamble mode [84](#)
- preset security
 - about [36](#)
 - passphrase [38](#)
- primary DNS addresses [31](#)
- printing files and photos [59](#)
- prioritizing traffic [52](#)
- Push 'N' Connect [28](#)

Q

- QoS (Quality of Service) [52](#)

R

- radio, wireless [84](#)
- range of wireless connections [8](#)
- ReadyShare access [58](#), [61](#)
- recovering admin password [81](#)
- releasing connection status [76](#)
- remote management [100](#)
- renewing connection status [76](#)
- repeater units [88](#)
- reserved IP addresses [51](#)
- restarting network [106](#)
- restoring
 - configuration file [80](#)
 - default factory settings [113](#)
- router interface, described [26](#)
- router status, viewing [74](#)

S

- scheduling keyword and service blocking [70](#)
- secondary DNS [31](#)
- security [36](#)
 - firewall settings [66](#)
 - see also security options
- security options [40](#)
- security PIN [44](#)
- sending logs by email [70](#)
- services, blocking [68](#)
- settings, default. See default factory settings
- Setup Wizard [43](#)
- sharing files [59](#)
- sites, blocking [67](#)
- SMTP server [71](#)
- specifications, technical [115](#)
- SSID
 - described [38](#)
- static routes [98](#)
- status, router, viewing [74](#)
- subnet mask [75](#)
- system up time [75](#)

T

- technical specifications [115](#)
- technical support [2](#)
- Temporal Key Integrity Protocol (TKIP) [40](#)
- time of day [112](#)
- time to live, advertisement [102](#)
- time-out, port triggering [96](#)
- trademarks [2](#)
- traffic metering [103](#)
- troubleshooting [105](#)
 - date or time incorrect [112](#)
 - log in access [108](#)
 - router changes not saved [111](#)
- trusted host [67](#)

U

- Universal Plug and Play (UPnP) [101](#)
- up time, system [75](#)
- upgrading firmware [26](#), [73](#)
- USB
 - advanced configuration [62](#)
 - basic storage settings [60](#)
 - drive requirements [58](#)
 - file sharing [59](#)
 - ReadyShare access [58](#), [61](#)

- remote computer connection **65**
 - specifying approved devices **64**
 - unmounting a USB drive **63**
- USB devices, approved **64**
- user-defined services **68**

V

- viewing
- logs **78**
 - router status **74**

W

- WAN IP address, troubleshooting **109**
- WAN setup **46**
- WiFi Protected Setup (WPS) **28, 44**
- wireless channel **38**
- wireless connections
- range **8**
 - troubleshooting **112**
- wireless devices, adding to the network **27**
- Wireless Distribution System (WDS) **85, 86**
- Wireless LEDs, troubleshooting **108, 109**
- wireless mode **38**
- wireless network name (SSID)
- broadcasting **38**
 - described **38**
- wireless network settings **38**
- wireless radio **84**
- wireless repeating **85, 86**
- base station **87**
 - repeater unit **88**
- wireless security options **40**
- Wireless Settings screen **36, 78**
- checking for correct **106**
 - SSID broadcast **38**
- WMM (Wi-Fi Multimedia) **52**
- WPA encryption **40**
- WPA2 encryption **40**
- WPA2-PSK encryption **41**
- WPA-PSK encryption **40**
- WPA-PSK/WPA2-PSK mixed mode **41**
- WPS button **28**
- WPS-PSK encryption **41**
- WPS-PSK+ WPA2-PSK encryption **41**
- wrong date or time **112**