

## RATINGS LIMITS

Set rating limits for Movies, TV and Other (unrated) shows. From the left menu, select Rating Limits then select either Movies, TV or Other.

### Movies

Select the button next to the overall ratings limit you wish to impose. Brief descriptions of the ratings appear for your guidance.

### TV Programs

Highlight and select the TV ratings limit you desire. In addition to allowing or blocking shows by TV rating (i.e. TV-MA), you can also set ratings limits for particular types of content such as Fantasy Violence (FV), Dialogue (D), Language (L), Sexual Content (S) and Violence (V). A description of each content type displays when highlighted.

### Other Shows

Highlight and select the box to toggle the setting between Allow No Rating and Block No Rating. If you choose Block No Rating, programming that has no rating, such as news and sports, will not display.



## PARENTAL CONTROLS

### ADULT CHANNELS

Hide adult channels in the Program Guide, Manage Recordings screens, and when channel surfing. Select Adult Channels, then highlight and select the box to toggle between Hide Adult and Show Adult. This action also hides the Adults Only icon in the Search & Browse screen.



### CHANNEL BLOCKS

Prevent children from viewing pre-selected channels with the Channel Blocks feature. Scroll down the channel list and select those you wish to block. You can also key in channel numbers or use Block All or Allow All to save time.



### WEB VIDEOS

Prevent children from viewing videos from the Internet. Select Web Videos, then highlight and select the box to toggle between Block Web Videos and Allow Web Videos.



## SPENDING LIMITS

Limit the amount that can be spent on each Pay Per View purchase. Select Spending Limits. Then enter your preferred spending dollar limit using the numbers on your Remote.



## VIEWING HOURS

Specify days and times when TV watching is allowed in your household. Select Viewing Hours, then select the start times and durations for viewing. You can set hours based on "school nights" – Monday-Thursday – and/or weekend nights—Friday-Saturday, and Sunday.



## FAVORITE CHANNELS

Create lists of your favorite channels. Use your list to see only those specific channels listed in the Guide as well as when you're channel surfing in live TV. You can create up to two custom lists on your Receiver. You can also choose Channels I Get to see only the channels that are in your DIRECTV programming package.

Press MENU on your remote, select Settings and Help then Favorite Channels. If you haven't created a Favorites list, the Setup Custom 1 and Setup Custom 2 options will be displayed. Select the one you want and follow the onscreen instructions to create and name your list.

Selecting a Favorites list makes it active and hides the display of all other channels in the Guide. From the Guide, press the DASH key on your Remote, select Favorites and then select the list you want to make active. The name of the currently selected Favorites list is displayed in the bottom left of the Guide screen so you always know which list you are using. To restore the display of all channels, press the DASH key while in the Guide, select Change favorites list, then select All Channels.



HELP provides information about your Receiver and its functionality, features, and more, as well as step-by-step instructions and frequently asked questions (FAQs). Press MENU, select Settings & Help, then select Help.

Select a category folder to view its contents, then select a topic from the list for detailed information.

You can also view self-help videos on Channel 1 and find answers to all your questions on DIRECTV's Online Answer Center at [www.support.directv.com](http://www.support.directv.com).





## CHAPTER 7 - GENIE™ HD DVR

---

<b>Genie™ HD DVR .....</b>	<b>98</b>
Genie HD DVR - Key Features .....	98
Genie Mini - Key Features .....	99
Share Programs Between Rooms .....	100
Genie as a Media Server .....	101
Connecting Clients .....	102
<b>DIRECTV GENIE Mini Back Panel Example .....</b>	<b>103</b>

## GENIE™ HD DVR

The DIRECTV Genie HD DVR is the most advanced DVR experience available and provides HD DVR service in every room without the need for additional receivers. A single Genie (models HR34, HR44, HR54, and above), together with Genie Minis (C51, C61, C61K, C61W, C41, C41W, C51, C61, C61K, and earlier models) or DIRECTV Ready TVs, can serve your entire home, allowing for more personalized viewing.

This chapter provides information on the many features and benefits of DIRECTV Genie HD DVR and its companion Genie Minis.

### GENIE HD DVR - KEY FEATURES

- Record up to five programs simultaneously.
- Store up to 200 hours of HD programming and 800 hours of SD total on the 1TB (terabyte) hard drive. (Actual recording capacity varies based on type of programming being recorded.)
- Watch two shows at the same time with Picture In Picture.\*
- View live or recorded programming in up to four different rooms simultaneously (Genie Minis required).

**NOTE:** \*Picture in Picture is only available on the TV connected directly to the Genie HD DVR.

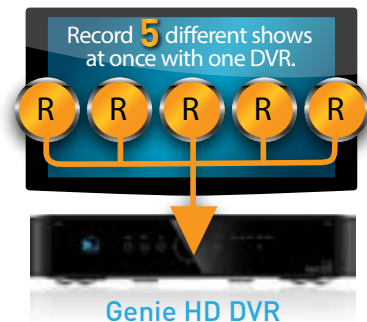



## Picture In Picture

Genie lets you watch two programs on the same TV, live or recorded, at the same time. While watching one program, press the INFO button on your remote. Select PIP. The program you're currently watching moves into a smaller window on your screen. The larger video is the active program and can be controlled by your remote. To switch between programs, press the DOWN ARROW.

To change the position of the smaller window, press INFO on your remote. Select PIP and choose a position from the options provided.



**NOTE:** Picture in Picture is only available on the TV that is connected directly to the Genie HD DVR (models HR34, HR44 and above).

## GENIE MINI - KEY FEATURES

- Watch and manage recorded programming from any room.\*
- Pause and rewind live or recorded TV from any room.\*\*
- Access On Demand content, TV Apps and other HD DVR features from any room.

**NOTE:** \*Including 4K On Demand programs when you have an HR44 or later receiver, a compatible 4K TV, and a 4K Genie Mini.

\*\*Including 4K Live TV when you have an HR54 or later receiver, a compatible 4K TV, and a 4K Genie Mini. See [directv.com/4k](http://directv.com/4k) for details.



Genie Mini Client

# GENIE™ HD DVR

## SHARE PROGRAMS BETWEEN ROOMS

The Genie HD DVR can be configured two ways to share content across your home:

1. **As part of a Whole-Home DVR network** - Genie enhances your current Whole-Home setup. When connected to other HD Receivers as the hub of your Whole-Home DVR experience, Genie allows you to stream recordings to four active rooms simultaneously (up to three Whole-Home Clients).\*
2. **In a Client-Server setup** - with Genie Minis, DIRECTV® Ready TVs or other RVU-capable devices in your home. RVU is a technology that allows you to connect certain TVs, devices, and DIRECTV Clients to your Genie HD DVR, without adding a full-featured DIRECTV Receiver. Please see next page for details.

**NOTE:** \*The Genie Receiver will work with any other DIRECTV HD DVRs, HD Receivers and Clients that are compatible with Genie and Whole-Home service, so you can play, pause, rewind and delete recorded content that's on your Genie HD DVR from any room in the house. However, you will not be able to record content to the Genie from another HD DVR.

## GENIE AS A MEDIA SERVER

You can use your Genie HD DVR as a media server. Any DIRECTV Genie Mini, or DIRECTV® Ready TV or RVU-enabled device lets you watch TV via your Whole-Home DVR Network.

- Start watching a show in one room, press EXIT on your remote, then resume watching in another.
- Pause or rewind live programming in any connected room.
- Schedule, watch or prioritize recordings from any room.

**NOTE:** Your Genie HD Receiver includes five (5) tuners. A tuner is used whenever you watch or record a program. For example, if two rooms are watching live TV, three tuners are available for recording. Watching a recorded program does not require a tuner.

Limit of three remote viewings per Genie HD DVR at a time.

See your DIRECTV Ready TV's User Guide for more information on connecting to the Genie HD DVR. You will need to activate the DIRECTV Ready TV by calling DIRECTV at 1.800.531.5000.



# GENIE™ HD DVR

## CONNECTING CLIENTS

You may register up to eight Clients per Genie HD DVR; these may be Genie Minis (C41, C31, C41W and above), or DIRECTV® Ready TVs.

Before connecting and activating Clients, your Genie HD DVR must be set up, activated, and functioning.

To begin, connect, plug in and turn on the Client. Once it detects the Genie HD DVR, it will prompt you to enter a PIN. On your DIRECTV HD DVR, press MENU, then select Settings & Help, then Settings. Select Whole-Home from the left menu, then select Manage Clients. Note the PIN shown on the Manage Clients screen, and **do not exit the screen!**

On the Client, enter the PIN you received from the Genie HD DVR using the remote. Select Done on the confirmation screen. The Create a Location screen displays. You may add a new location, or replace a location. Select the appropriate option and follow the onscreen instructions.

Once the location has been set up, you have a choice of copying settings from another location or accepting the DIRECTV defaults.

The following settings are copied from a server or Client to another Client:

- Parental Control Settings
- Favorite Channels
- Display Settings
- Clock
- Language
- Sound Effects



**NOTE:** The settings from any Client can also be copied to the Genie HD DVR.

**NOTE:** For more information on setting up, adding and moving Genie Minis and other DIRECTV® Ready Clients, do a search on the DIRECTV online Answer Center at <http://support.directv.com/> or call 1.800.531.5000.

## DIRECTV GENIE MINI BACK PANEL EXAMPLE

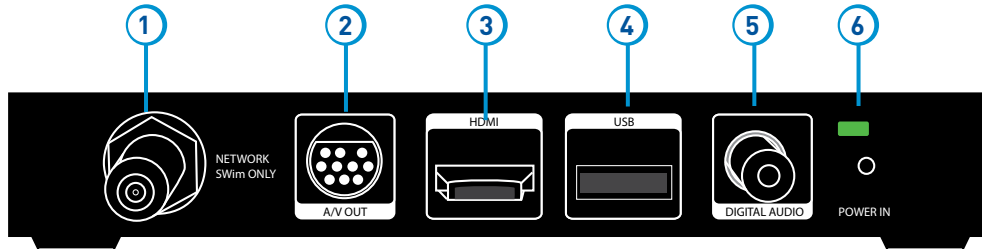

### DIRECTV Genie™ Mini (C41, C31, C41W and above)

*Your equipment may not look exactly like the model illustrated. This image has enlarged features for the purpose of clarity.*

1. **NETWORK SWM ONLY (models C41 and C31 only)** – Connect a cable from a Single Wire Multi-Switch (SWM) to this port. This is your SAT-IN connection.
2. **A/V OUT** – A combined 10-pin output that supports both audio and video. Your Genie Mini client comes with an A/V Out cable for Component Video and RCA audio. An A/V Out cable for Composite Video and RCA audio can be purchased separately.
3. **HDMI** – Use this combination digital video and audio connector for the best picture quality. **This is the recommended connector for HD TV.**
4. **USB** – USB 2.0 Port (For future use.)
5. **DIGITAL AUDIO OUT COAXIAL** – Use this digital audio connection for sound.
6. **POWER** – Your Receiver must be plugged in at all times to function properly.

**WARNING:** Use only the power supply (power cord) that came with your DIRECTV Receiver or Client. Failure to use the authorized power supply may cause electric shock, fire, bodily injury and/or property damage. If the power supply becomes damaged or needs to be replaced, please contact DIRECTV Customer Service to obtain an authorized replacement.



## CHAPTER 8 - TROUBLESHOOTING & FAQs

---

<b>Troubleshooting Tips</b> .....	<b>106</b>
Reset Your Receiver .....	106
Reauthorize Your Receiver .....	106
System Software Updates .....	107
Onscreen Messages .....	107
Run the System Test .....	108
<b>Frequently Asked Questions</b> .....	<b>109</b>

## TROUBLESHOOTING TIPS

### RESET YOUR RECEIVER

A simple reset of the DIRECTV® HD DVR can solve many issues. If you experience frozen audio or video, or a blank screen, or the Receiver won't respond to remote or front panel button commands, try resetting your Receiver as follows:

- Press the red RESET button behind the access card panel door on the front of your Receiver, then wait a few minutes for Program Guide information to be acquired.
- If you reset a Genie Mini and the problem persists, try resetting the Receiver.
- If the problems persist, try unplugging the power cord of the Receiver for 15 seconds, then plug it in again.

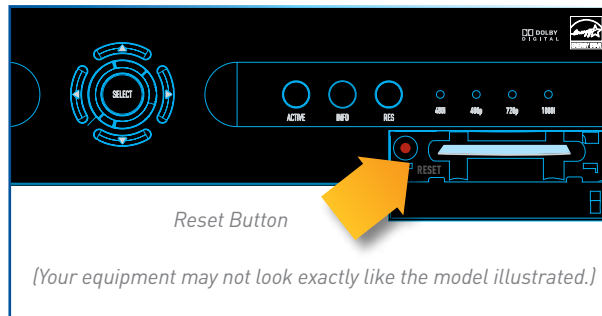

### REAUTHORIZE YOUR RECEIVER

If your Receiver displayed the message "722 - Service Expired," try reauthorizing your Receiver. On a computer, go to [directv.com/reauthorize](http://directv.com/reauthorize), log in to your account, and follow the onscreen instructions. You will need to be logged into your account on [directv.com](http://directv.com) to complete this process.

Running the System Test (at the end of this section) can also help you diagnose and solve many common problems.

**NOTE:** Resetting your Receiver twice in a row will clear all Guide data. It could take 48+ hours to reacquire all of it.



## SYSTEM SOFTWARE UPDATES

DIRECTV sends system automatic software updates to your Receiver to improve performance and upgrade features and functions. The Receiver will give you the option to download software “now” or “later.” Software downloads take just a few minutes and should be allowed to proceed when possible. When a download is in progress, your system will temporarily become unavailable. After the download, the Receiver may reset itself, after which, you can resume using your DIRECTV system.

## ONSCREEN MESSAGES

On occasion, you may see an onscreen message similar to that pictured at right. The top line of text provides a brief description of the message purpose, while the second line provides instructions. Most onscreen messages contain an error code in parentheses. Go to [directv.com/troubleshooting](http://directv.com/troubleshooting) and select the corresponding onscreen error message for solutions.

The sample message at the right displays when you try to view to view a channel that is not in your programming package. In this case, you must, call Customer Service at 1.800.531.5000 and mention the error code number when prompted.

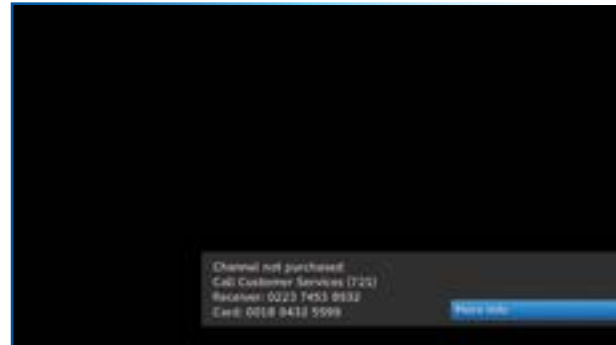

## TROUBLESHOOTING TIPS

### RUN THE SYSTEM TEST

The System Test runs a basic diagnostics check on your DVR.

First make sure that:

1. All connections — jacks, cables, etc. — are in place correctly. See Appendix 2, “Connections for TV and Equipment” for more information.
2. Remote control has working batteries.
3. The access card is inserted in the DIRECTV® Receiver.

Then follow these steps:

1. Turn on your TV and the DVR (if you have the Universal Remote, slide the MODE switch to DIRECTV position).
2. Press MENU, then select Settings & Help.
3. Select Settings then Info & Test.
4. Select Run System Test.
5. If your system does not pass the System Test, check any of these potential trouble areas: cabling, satellite dish position, phone connection and access card.
6. If you continue to have problems, call DIRECTV Customer Service at 1.800.531.5000.

**NOTE:** Occasional fluctuations in the phone line or satellite signal can give temporary false readings, therefore we recommend running a system test several times before concluding there is a problem.

## FREQUENTLY ASKED QUESTIONS

### Q: What to do about temporary loss of satellite signal, “frozen” picture, or picture breaking into blocks / pixels?

The image on your screen is frozen, blocky, or you see a message that says, “Searching for Satellite Signal (x 771)”.

#### Possible Causes:

- Severe weather (rain, snow, hail etc.) may cause this issue.
- There may be an obstruction to your dish (debris, snow, ice, etc.) or a building or tree that blocks your line of sight to the satellite.
- There may be a problem with the cables running from your satellite dish to your DIRECTV® Receiver.
- If the picture is frozen, blocky, or pixelated, there may be a problem with the transmission from the source.

#### Solution:

- Weather issues are usually temporary. Wait for the weather to clear and your signal should return to normal.
- If there are no weather problems in your area, reset your DIRECTV DVR using the red RESET button behind the door on the front of the Receiver or by unplugging the Receiver for 15 seconds and then plugging it back in.
- Check all the connections on the back of your Receiver, starting with the SAT-IN connection, and make sure they're secure.
- If the problem originates from the program source (for example, you see the problem on one channel, but not on any others), wait for the channel to resolve the issue.
- If there are obstructions blocking the dish's path to the satellite, you should contact a professional to remove them, or a DIRECTV installer at 1.800.531.5000 to relocate your dish.
- If your signal strength is lower than 70 (60 or lower on HD Receivers) in good weather, contact a professional installer to realign your dish, or call DIRECTV at 1.800.531.5000.



Check Satellite [SAT-IN] Connections



Coaxial Satellite Cable

## FREQUENTLY ASKED QUESTIONS

### Q: Why is my screen blue, black, gray or snowy?

Your TV displays a blue, black, gray or snowy screen.

#### Possible Causes:

- Your TV and/or your Receiver are not powered on.
- The DIRECTV® Receiver and most TVs and VCRs let you toggle between different video sources. Your TV may be on a different input source than what you are trying to view.
- Your TV may not support the selected HD resolution from your Receiver.

#### Solution:

- Check that the DIRECTV® Receiver and TV are both powered on.
- If you don't see the DIRECTV picture, verify your current TV input by turning the TV on and off. Most TVs display the input in the upper right- or left-hand corner. If the input is set to something other than your DIRECTV Receiver, toggle through the inputs with the input button on the DIRECTV Remote (if programmed) or TV Remote a your picture displays. (If the DIRECTV Remote is not working for the TV, it may need to be programmed.)

If the TV Remote is not available:

1. Find the Input or Source button on your TV and press it. It may be on the front panel, sides, bottom, or top edges of your TV.
  2. Slowly set the TV to each input option, one at a time. Sometimes it takes a second or two for the input to switch, so don't proceed too quickly.
  3. Set the TV to whichever input displays a picture.
- If you see a snowy screen and are using a coax connection to connect to the TV, make sure your TV is on channel 3 or 4.
  - Press the TV/VCR button on the VCR Remote or on the VCR's front panel.
  - If problems persist, turn off all equipment connected to your TV, wait a few minutes, then turn the DIRECTV® Receiver back on.
  - Check your connections and cables.

## FREQUENTLY ASKED QUESTIONS

- Check the HD output resolutions and deselect those not supported by your TV. For 1080p programs, some TVs do not support the 24 frame-per-second rate DIRECTV provides. Press the RES button on your Receiver's front panel to change the resolution to one your TV supports.

### Q: Why doesn't my remote work?

#### Possible Causes:

- Weak batteries are the most common problem.
- Trying to operate equipment other than your DIRECTV Receiver.
- Remote sensor on the Receiver could be blocked.

#### Solution:

##### For the DIRECTV Universal Remote Control (RC65 and earlier models):

- Check that nothing is between the Remote Control and the remote sensor.
- Make sure the Remote is in DIRECTV mode. Slide the MODE switch on the Remote to the DIRECTV position so the Remote will control the DIRECTV® Receiver.
- If you are trying to operate a device other than the DIRECTV DVR that you have programmed the Remote to control, make sure you first slide the MODE switch to the mode that is programmed for that device (AV1 or AV2). The indicator light for the component you're trying to control should light up when you press a valid key for that component. If it doesn't, make sure the MODE switch is in the correct position.

##### For All Remote Controls:

- Check the batteries in the Remote. They may be weak, dead or installed incorrectly. Try replacing batteries.
- If you're entering a channel number that is less than four digits long, the Receiver might wait two seconds before tuning to

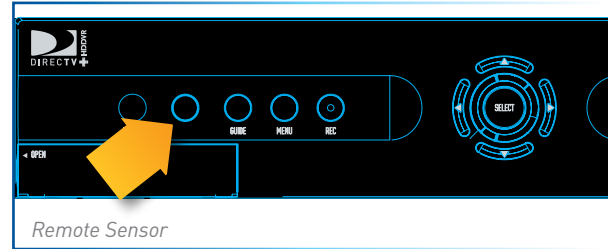

## FREQUENTLY ASKED QUESTIONS

the channel. Press ENTER after entering a channel number to tune immediately.

- Make sure the device you are trying to control has been programmed to your DIRECTV Remote Control. See Chapter 6, "Settings & Help: Settings: Remote Control" for instructions on how to program your remote to control other devices.
- If the indicator lights on the remote control start flashing, the batteries in the remote control are running low and should be replaced soon. You may also see an onscreen message that the batteries are low. Note that when you replace the batteries, you should not have to reprogram your remote to control other devices unless the batteries have been completely dead for a month or more.

### Q: Why won't my DIRECTV® Receiver or Client turn on?

Your Receiver or Client won't turn on with either the Remote or from the front panel.

#### Possible Causes:

- Remote batteries have an insufficient charge.
- Receiver / Client or power strip is not plugged in to a power source, or power cord is not plugged in to the Receiver.
- Wall outlet is not providing power.

#### Solution:

If your Receiver or Client won't turn on, the problem may be with the device itself, or with the remote control. Please try the following:

To Check the Receiver or Client (C31, C41, C41W and above):

- Verify the detachable power cord is plugged into the back of the DIRECTV® Receiver or Client and the wall outlet.
- Check the outlet or power strip to make sure it is "live" by plugging in something else.
- Try plugging Receiver or Client into a different wall outlet.
- Make sure the outlet is not controlled by a wall switch.
- Unplug Receiver or Client for five minutes, and then plug it in again.

## FREQUENTLY ASKED QUESTIONS

- If your Receiver or Client is plugged into a power strip, check the power strip and reset by pressing its reset button. Make sure the Receiver or Client is plugged into a power strip outlet that has continuous power. Some power strips have energy saving ports that only operate when a device is plugged in and powered on.

To Check the Remote:

- Press the power button on the front panel. If your device turns on, the issue is with the Remote.
- For the Universal Remote, make sure the MODE switch is in the left-most position (DIRECTV Mode), and press PWR (power key) or press POWER button on the front panel of the Receiver. On the Genie Remote, this step is not necessary. See the next bullet for more info.
- Make sure remote batteries have sufficient charge. For the Universal Remote, the green light should be solid green when you press its PWR button. If the light blinks several times slowly, replace the batteries. If there is no light, make sure batteries are inserted with the positive and negative ends in the proper positions. Otherwise, replace batteries. For the Genie Remote, a low battery indicator is displayed on your Receiver when the batteries need to be replaced.
- Make sure nothing is blocking the IR sensor on the Receiver. Remote must be pointed at Receiver, unless it is capable of RF (as is the case with the Genie Remote) and has been set up as RF.

### I see a message on my TV screen that says, “Please Call Customer Service x721.” What’s going on?

#### Possible Causes

- The channel you’re trying to watch may not be included in your programming package.
- Your DIRECTV® Receiver may not have the programming information for this channel.

#### Solutions

- If the channel is part of your programming package, try resetting your Receiver by turning it off and unplugging it. Wait 15 seconds, then plug it back in and turn it on.
- If the channel is not part of your programming package, you can change your package online or call 1.800.531.5000.
- Finally, try reauthorizing your Receiver. On a computer, go to [directv.com/reauthorize](http://directv.com/reauthorize) and follow the onscreen instructions. You will need to be logged into your account on [directv.com](http://directv.com) to complete this process.

## FREQUENTLY ASKED QUESTIONS

### Q: Why does my Progress Bar freeze while acquiring Guide data / data from satellite?

While the Acquiring Guide Data or Acquiring Data From Satellite message is on the screen, progress freezes during download.

#### Possible Causes:

- This may be normal. After five minutes, the screensaver will display. Press any key on the remote to see the progress bar again.
- This may happen if your satellite dish isn't adjusted properly.

#### Solution:

- If satellite data acquisition still does not move forward, press the RESET button behind the access panel door on the front of the DIRECTV® Receiver and wait for Program Guide information to be acquired.

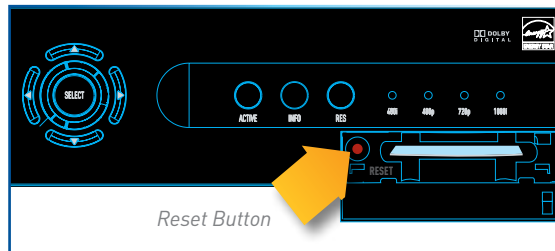

### Q: Why are my video and audio out of sync?

The audio track does not match the lip movements on the screen.

#### Possible Causes:

- Problem with how the program was produced or how it was sent to DIRECTV for broadcast.
- Your surround sound system may be out of sync, or may be set up incorrectly.

#### Solution:

- Change the channel on your DIRECTV® Receiver. This may re-sync the audio.
- Rewind the program for about 5 seconds, then fast forward to live programming.
- Try replacing or switching the cables between your surround sound system and your DIRECTV Receiver. Refer to your surround sound system's manual for assistance.



## FREQUENTLY ASKED QUESTIONS

- If the issue continues, reset your DIRECTV Receiver. Press the RESET button behind the access panel door on the front of the DIRECTV Receiver. You can also press MENU, press SELECT Settings & Help, then Settings. Select the Reset item from the left menu and follow the onscreen instructions.

### Q: Why is there no audio with picture?

You can see a picture from your DIRECTV® Receiver, but there is no sound.

#### Possible Causes:

- A setting (such as mute or volume) may have changed on the Receiver or your TV.
- The cables between your TV and the Receiver may not be connected properly, or there may be a problem with an external stereo or surround sound system.
- Verify that your surround sound system is working, if applicable.
- Your TV may not support the selected HD resolution from your Receiver.

#### Solution:

- Verify that the MUTE button is not activated on your Remote.
- Raise or lower the volume. Did volume meter display on TV?
- Test sound on your TV by changing the input to another source, such as a DVD player, game box, or antenna.
- If connected to stereo or surround sound system, verify components are on and set to the correct mode, and that audio cables are secure and connected correctly.
- If the issue continues, reset your DIRECTV® Receiver. Press the RESET button behind the access panel door on the front of the DIRECTV® Receiver. You can also press MENU, select Settings & Help, then Settings. Select the Reset item from the left menu and follow the onscreen instructions.
- Check the HD output resolutions and deselect those not supported by your TV. For 1080p programs, some TVs do not support the 24 frame-per-second rate DIRECTV provides. Also, many TVs do not support 480i. You may have to press the RES button on your Receiver's front panel to set the resolution to one your TV supports.

## FREQUENTLY ASKED QUESTIONS

Q: What to do about partial programming loss; channels missing from Guide; channel is in the Guide but I can't tune to it?

Your Program Guide is missing channels, or you are unable to use the Guide to tune to a channel.

### Possible Causes:

- The channels might be excluded from the Favorites list currently in use.
- Your satellite dish may be incorrectly configured.
- Your Receiver information may need to be refreshed.

### Solution:

- To change your Favorites List, press GUIDE on the Remote, then press the DASH [—] button and select Change Favorites List, then All Channels.
- Enter the channel number using the number pad on the remote control.
- Check the dish type set in your Receiver's preferences: Press MENU, select Settings & Help, Settings, Info & Test, then More System Info. Check the Satellite Dish Type shown on the System Setup screen to see if it is correct. If not, select Satellite from the left menu, then select Repeat Satellite Setup. Follow the steps. From the Satellite Dish Type screen, make sure the proper dish type is selected.
- To refresh your Receiver information, go to [directv.com/reauthorize](http://directv.com/reauthorize). You will need to be logged into your account on [directv.com](http://directv.com) to begin this process.

### Q: Why does my DIRECTV® Receiver turn off while playing?

Your Receiver turns off unexpectedly.

#### Possible Causes:

- Excessive heat may have caused the Receiver to go into a standby state.
- Electronic protection circuit may have been activated due to a power surge.
- You may have blown a circuit breaker or be experiencing a power outage.
- Parental viewing limits may have been activated on your DIRECTV® Receiver.

#### Solution:

- Ensure that your Receiver has plenty of ventilation and that nothing is on top of the Receiver.
- Wait 30 seconds for internal circuits to reset, then turn Receiver back on.
- Consider using a line conditioner or surge protector.
- Consult an electrician if the problem is frequent or severe, especially if other household appliances or electronics are affected.
- If parental limits are active, turn your DIRECTV® Receiver on again and enter your parental lock code when prompted.

### Q: Why does my DIRECTV DVR turn on or change channels unexpectedly?

Your Receiver changes to a different channel without a Remote command.

#### Possible Causes:

- A scheduled recording may be about to begin, so the Receiver is changing channels to record the show as requested.
- Your TV's timer may have been activated.

## FREQUENTLY ASKED QUESTIONS

### Solution:

- Check your To Do List to see if there are other scheduled recordings. Press MENU, select Recordings, then Manage Recordings, then To Do list.
- Check your TV owner's manual to turn off the TV's timer.

### Q: Why is my screen blank?

There is no viewable video or image on the screen. Screen could be black, blue, grey or seem like the TV is off.

### Possible Causes:

- Your TV and/or your Receiver are not powered on.
- Your Receiver may be hooked up to the TV incorrectly.
- You may be on the wrong video source for your DIRECTV® Receiver.
- You may be tuned to a channel that is not currently broadcasting, or that you don't subscribe to.

### Solution:

- Check that DIRECTV DVR and TV are both powered on.
- Read Appendix 2, "Connections to TV and Equipment" for instructions about connecting your Receiver.
- Press the INPUT button on the white TV remote control to change video source. If you are using the Black & Universal Remote, press ENTER and hold for three (3) seconds to bring up the TV INPUT to change the video source.
- Try another channel and see if you have live video.
- Press the POWER button on the front panel of the DIRECTV® Receiver.
- Press the red RESET button behind the door on the front panel of the Receiver.
- The program may have been blocked by Parental Locks.

### Q: Why is Caller ID not working?

Caller ID information isn't showing on your TV screen when phone calls come in.

#### Possible Causes:

- You don't subscribe to Caller ID service through your local phone company.
- The Caller ID feature in your DIRECTV® Receiver is turned off. See "Caller ID" in Chapter 5.
- You are using a wireless phone jack, which usually will not transmit Caller ID information.

#### Solution:

- Contact your local phone company to subscribe to Caller ID service.
- Turn on Caller ID notification. Press MENU, select Extras, then Caller ID, then Turn On Notices.
- Verify that your wireless phone jack transmits Caller ID information. If not, connect a standard phone cable to your Receiver or replace your wireless phone jack.

### Q: Why didn't a program I tried to record show up in the My Playlist screen?

You wanted to record a program to watch later, but it is not listed in your Playlist.

#### Possible Causes:

- Someone else may have prevented the recording or erased the program after it recorded.
- The recording may have been cancelled due to a conflict with another program with higher priority in the Prioritizer.
- The program may have been blocked by Parental Locks.
- You may have deleted a Series recording. If you delete a Series by pressing RECORD on an episode in the Guide, you cancel the entire series, not just the highlighted episode.

## FREQUENTLY ASKED QUESTIONS

### Solution:

- To see if the program was recorded then deleted, press MENU, select Recordings, then Manage Recordings, then in the left menu, select History.
- If the recording was cancelled due to a scheduling conflict, you will need to record the program again and if necessary you will need to adjust the programming priority. See the "Manage Recordings: Series Manager" section in Chapter 4 for details.
- Check the Parental Locks on your Receiver and TV. Adjust the content ratings, if necessary.

**Q: I wanted to record a program, but I got an error message saying it conflicted with another scheduled record. What do I do?**

Your DIRECTV DVR can record up to two programs at once, or it can record one program while you watch another live program.

### Possible Causes:

- You tried to record three programs at the same time or tried to watch a live program while recording two others at the same time.
- There was an overlap in the programs you tried to record.

### Solution:

- If you tried to record three programs at once, or watch a live TV program with two others recording, you will need to decide which recording to cancel.
- If the overlap is a couple of minutes (for example, some networks occasionally start programs at 8:59 instead of 9:00 p.m.), adjust your recording start and end time Recording Options. See the "Changing a Record Option" section in Chapter 4.
- Someone else manually deleted the program.
- The hard drive on your DVR is full. The program may not have recorded.

**Q: I recorded a program but the recording stopped just before the end so I missed the last bit of the program. Why?**

Your recording stopped before the program or event ended.

### Possible Causes:

- The program you were trying to record may have started or ended early.
- If you were trying to record a sporting event, the event may have run over its allotted time.
- You may have had a recording conflict with a higher priority program.
- Someone may have manually ended the recording.

### Solution:

- Try setting the end time of the recording in the Record Options so the recording ends one or two minutes later (or more, if necessary). You may be able to record the same program again later in the week. Check the Program Guide for additional showings.
- For sporting events, you may want to extend the recording stop time 15 minutes or more to protect against overtime games.
- If you had a priority conflict, try adjusting your start and end times. You may need to choose a different time slot to record a program if the conflict continues.

**Q: Why was a program I recorded displayed in the My Playlist screen, but deleted before I could watch it?**

Your recording(s) were deleted before you had a chance to view them.

### Possible Causes:

- Someone else manually deleted the program.
- The hard drive on your DVR is full. The program may not have recorded.
- The Receiver may have deleted older recordings to make room for newer ones.

## FREQUENTLY ASKED QUESTIONS

- You exceeded the allotted purchase or viewing time on a Pay Per View movie or event.
- Bad weather may have caused a loss in signal. Your Receiver will automatically delete these incomplete programs.

### Solution:

- Delete some of the content on your DVR to make room for new recordings.
- Change your recording options to keep programs until you delete them manually. See “Recording a Single Show” or “Recording a Series” in Chapter 4 for details.
- You can also change a recording you’ve already made to Keep Until I Delete. See “Managing My Playlist” in Chapter 4.
- To avoid this in the future, you can change settings for recordings that you’ve set to occur in the future, but haven’t recorded yet. Press MENU, select Recordings, then Manage Recordings, then To Do List, choose the show you want to change and select it, select RECORD, press SELECT on Keep..., press SELECT on the Keep Until box to change it to I Delete, use the ARROW button to move over to Update and press SELECT.
- If you recorded a DIRECTV CINEMA movie or Pay Per View event, but did not watch it, the time which you are allowed to purchase or watch it may have expired. To avoid this in the future, check your Pay Per View recordings in the My Playlist screen for expiration dates.

### Q: I’ve set up a series recording. Why do I get reruns and multiple copies of the same program?

Your DVR is getting full of duplicate recordings of the same program, or old episodes of the chosen show.

### Possible Causes:

- Your series is set to record both First Run and Repeat episodes.
- The programmer may not provide enough details in the program description for your Receiver to determine whether the program is a repeat.

### Solution:

- When you set up a series, make sure you select only the “First Run” option. This is the default for one-touch recording unless you have changed your default recording settings.



## FREQUENTLY ASKED QUESTIONS

Q: Why are the DIRECTV menus/screens not displaying on my TV?

OR

Why do I see this message: “This TV or its cables are not HD. To see screen graphics, press the RES key on the front of the Receiver until this message no longer appears”.

When the Receiver resolution is set to 720p, 1080i, or 1080p, DIRECTV screens and menus (user interface) will not appear on Standard Definition (SD) outputs. A message is displayed to notify you that the resolution setting needs to be changed.

### Possible Causes:

- You have connected your Receiver to your TV using both a High Definition output (HDMI) and Standard Definition (SD) outputs (S-Video, Component (Red/Yellow/White), or Coaxial) on the same Receiver.
- You are using SD outputs (S-Video, Component (Red/Yellow/White), or Coaxial) and have the Receiver set to HD resolutions such as, 720p, 1080i or 1080p.

### Solutions:

- Change the Receiver resolution to 480i or 480p by pressing the RES button on the front Receiver panel until 480i or 480p is selected.
- Uncheck all resolutions except 480i or 480p on the TV Resolutions menu. Press MENU, select Settings, HDTV and then TV Resolutions. Follow the onscreen instructions.
- Turn Native Off. Press MENU, select Settings, HDTV, Video, then Native, and follow the onscreen instructions.

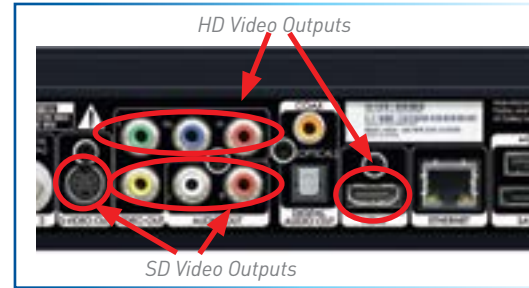



## CHAPTER 9: WARRANTY AND OTHER INFO

---

<b>Limited 90-Day Warranty</b> .....	<b>126</b>
Who is Covered? .....	126
What is Covered? .....	126
What is Excluded? .....	127
Make Sure You Keep... ..	127
Before Requesting Repair Service... ..	127
To Get Warranty Service... ..	128
To Get Out-of-Warranty Service... ..	128
<b>DIRECTV PROTECTION PLAN</b> .....	<b>129</b>
<b>FCC Customer Information</b> .....	<b>130</b>
<b>TERMS AND CONDITIONS FOR USE OF SOFTWARE</b> <b>("TERMS")</b> .....	<b>133</b>

## LIMITED 90-DAY WARRANTY

DIRECTV warrants your DIRECTV HD DVR (Model Number: HR20, HR21, HR22, HR23, HR24) or Advanced Whole-Home HD DVR (Model Numbers: HR34, HR44 and above) and any included accessories against defects in material or workmanship for a period of ninety (90) days after the date of acquisition.

### WHO IS COVERED?

You must have proof of acquisition to receive warranty service. A receipt or other document showing that you acquired the product is considered proof of acquisition. THIS LIMITED WARRANTY EXTENDS ONLY TO THE ORIGINAL CONSUMER ACQUIRER OR ANY PERSON RECEIVING THE DIRECTV HD DVR AS A GIFT FROM THE ORIGINAL CONSUMER ACQUIRER AND TO NO OTHER ACQUIRER OR TRANSFEREE. THIS WARRANTY DOES NOT EXTEND TO COMMERCIAL USERS. THIS PRODUCT IS NOT AUTHORIZED FOR USE OUTSIDE THE UNITED STATES AND ANY SUCH USE VOIDS THIS WARRANTY.

### WHAT IS COVERED?

Warranty coverage begins the day you acquire the product. For ninety (90) days from the acquisition date, at the option of DIRECTV, the DIRECTV HD DVR will be repaired or replaced with a new, repaired, refurbished or comparable product (whichever is deemed necessary) if it becomes defective or inoperative. This exchange is done without charge to you for parts and labor. You will be responsible for the cost of shipping to and from the location designated by DIRECTV. If DIRECTV cannot reasonably repair or replace the Receiver then DIRECTV may, at its sole discretion, refund the price you paid for the product or the current retail price of the product.

All products, including replacement products, are covered only for the original warranty period. When the warranty on the original product expires, the warranty on the replacement product also expires. After ninety (90) days from the date of acquisition, you pay for the replacement of all parts, and for all labor charges.

SOME STATES DO NOT ALLOW LIMITATIONS ON HOW LONG AN IMPLIED WARRANTY LASTS, SO THE ABOVE LIMITATION MAY NOT APPLY TO YOU.

## WHAT IS EXCLUDED?

Your warranty does NOT cover:

Labor charges for installation or setup of the product.

Installation, performance of, or repair of: audio/video cabling, telephone line, or accessory attachments used with the product.

Product replacement because of misuse, accident, lightning damage, unauthorized repair, or other cause not within the control of DIRECTV. Incidental or consequential damages resulting from the product. **SOME STATES DO NOT ALLOW THE EXCLUSION OF INCIDENTAL OR CONSEQUENTIAL DAMAGES, SO THE ABOVE EXCLUSION MAY NOT APPLY TO YOU.** Any modifications or other changes to the product, including but not limited to software or hardware modification in any way other than as expressly authorized by DIRECTV will void this limited warranty. Except in the case of hardware or software provided by DIRECTV, installing software modifications, "hacks" or utilizing service access or "back doors" will void this limited warranty.

Reception transmission problems caused by signal conditions, telephone line, or cable or antenna systems outside the unit. A product that has been modified or adapted to enable it to operate in any country other than the country for which it was designed, manufactured, approved and/or authorized, or repair of products damaged by these modifications. A product used for commercial or institutional purposes.

DIRECTV makes no warranty that the access connection will be a local (not long distance) phone call.

The continued provisioning of any of the programming and other services delivered through the Receiver including but not limited to television programming, show information, Program Guide data, and scheduling information.

## MAKE SURE YOU KEEP...

Please keep your receipt or other document showing proof of acquisition. Attach it to this User Guide (see page 10) and keep both nearby. Also keep the original box and packing material in case you need to return your product.

## BEFORE REQUESTING REPAIR SERVICE...

Please check the troubleshooting section of this Guide. This may save you a call to DIRECTV Customer Care.

## LIMITED 90-DAY WARRANTY

### TO GET WARRANTY SERVICE...

Warranty service will be provided by DIRECTV. If you believe you need service for your Receiver, contact DIRECTV at 1-800-DIRECTV. A representative will go through a diagnostic checklist with you. If it is determined that the product needs to be returned for service or exchanged, you will receive a return authorization number. The representative will give you complete shipping details.

### TO GET OUT-OF-WARRANTY SERVICE...

To obtain out-of-warranty service contact DIRECTV at 1-800-DIRECTV for information on the possibility of and any costs for repair or replacement of out-of-warranty products.

ALL WARRANTIES IMPLIED BY LAW, INCLUDING ANY IMPLIED WARRANTIES OF MERCHANTABILITY AND FITNESS FOR A PARTICULAR PURPOSE ARE EXPRESSLY LIMITED TO THE DURATION OF THIS EXPRESS LIMITED WARRANTY.

WITH THE EXCEPTION OF ANY WARRANTIES IMPLIED BY THE LAW OF ANY STATE OF THE U.S.A., THIS EXPRESS LIMITED WARRANTY IS EXCLUSIVE AND IN LIEU OF ALL OTHER WARRANTIES, GUARANTEES, AGREEMENTS AND SIMILAR OBLIGATIONS OF DIRECTV. REPAIR OR REPLACEMENT AS PROVIDED IN THIS LIMITED WARRANTY IS THE EXCLUSIVE REMEDY UNDER THIS LIMITED WARRANTY. IN NO EVENT WILL DIRECTV BE LIABLE FOR ANY AMOUNT GREATER THAN THE RETAIL PRICE OF THE DIRECTV® Receiver. DIRECTV SHALL NOT BE LIABLE FOR ANY INCIDENTAL OR CONSEQUENTIAL DAMAGES FOR BREACH OF ANY EXPRESS OR IMPLIED WARRANTY ON THE DIRECTV® Receiver.

SOME STATES DO NOT ALLOW LIMITATIONS ON WARRANTIES, SO THE ABOVE LIMITATIONS MAY NOT APPLY TO YOU. THIS WARRANTY GIVES YOU SPECIFIC LEGAL RIGHTS. YOU MAY HAVE OTHER RIGHTS WHICH VARY FROM STATE TO STATE.

**DIRECTV**  
2230 E. Imperial Hwy  
El Segundo, CA 90245  
1-800-DIRECTV

Safeguard your DIRECTV® System with the ultimate in professional technical service. For a low monthly fee, the DIRECTV PROTECTION PLAN covers the components of your entire DIRECTV® System, giving you affordable peace of mind and comprehensive support to ensure that you and your family enjoy nonstop DIRECTV® entertainment.

### DIRECTV PROTECTION PLAN Benefits

Your DIRECTV Limited Warranty provides certain remedies for this Receiver during the stated coverage term. The DIRECTV PROTECTION PLAN provides comprehensive coverage for your DIRECTV® System, including\*:

#### YOUR BENEFITS INCLUDE:

- **COMPLETE SYSTEM COVERAGE.** Every DIRECTV Receiver in your home... plus remotes, satellite antenna wiring, connectors, switches, and dish antenna alignments.
- Power surge protection.
- No hassles, service around the clock. Call 24 hours a day, 7 days a week... our technical specialists are ready and are dedicated exclusively to you!
- Fast and convenient repair service when you need it. Save money should you need a service technician to come to your house.
- Professional expertise and experience, on the phone and in your home... whenever you need us.

*\*Limitations and exclusions apply. Please visit [www.directv.com/protection](http://www.directv.com/protection).*

The DIRECTV PROTECTION PLAN is offered by Asurion Service Plans, Inc. in all states except Florida (in which Asurion Service Plans of Florida, Inc offers the plan) and underwritten by Continental Casualty Company. Pricing, terms and conditions of the DIRECTV PROTECTION PLAN are subject to change. Full terms and conditions will be mailed to you prior to service billing.

## FCC CUSTOMER INFORMATION

This device complies with Part 15 of the FCC Rules. Operation is subject to the following two conditions: (1) this device may not cause harmful interference, and (2) this device must accept any interference received, including interference that may cause undesired operation.

Responsible Party:

**DIRECTV**  
**2230 E. Imperial Hwy**  
**El Segundo, CA 90245**  
**1-800-DIRECTV**

- Trade Name: DIRECTV
- Type of Equipment: DIRECTV Satellite Receiver
- Model Number: H44, HR34, HR44, HR54, C31, C41, C41W, C61, C61K, C61W, C61KW, and later models.

Federal Communications Commission (FCC): This equipment complies with both Part 15 and Part 68 of the FCC rules.

This equipment has been tested and found to comply with the limits of a Class B digital device, pursuant to part 15 of the FCC Rules.

These limits are designed to provide reasonable protection against harmful interference in a residential installation.

This equipment generates, uses, and can radiate radio frequency energy and, if not installed and used in accordance with the instructions, may cause harmful interference to radio communications. However there is no guarantee that interference will not occur in a particular installation. If this equipment does cause harmful interference to radio or television reception, which can be determined by removing and applying power to the equipment, the user is encouraged to try to correct the interference by one or more of the following measures:

- Reorient or relocate the receiving satellite dish antenna.
- Increase the separation between the equipment and the DIRECTV Receiver.
- Connect the equipment into an outlet on a circuit different from that to which the DIRECTV Receiver is connected.
- Consult the dealer or an experienced radio/TV technician for help.



- **CAUTION:** Changes or modifications not expressly approved by the manufacturer responsible for compliance could void the user's authority to operate the equipment.

The user may find the following booklet, prepared by the Federal communications Commission, helpful: "How to Identify and Resolve Radio and TV Interference Problems". This booklet is available from the U.S. Government Printing Office, Washington, DC. To meet FCC requirements, only peripherals (computer input/output devices, terminals, printers, etc.) certified to comply with Class B limits may be attached to this device. Operation with non-certified peripherals is likely to result in interference to radio and TV reception. To meet FCC requirements, shielded cables are required to connect the device to a personal computer, peripheral, or other Class B certified device.

This equipment complies with Part 68 of the FCC Rules and the requirements adopted by ACTA. On the back of this equipment is a label that contains a product identifier in the format US:AAAEQ##TXXXX.

If requested, this information must be provided to your telephone company. This equipment uses the following USOC Jack: RJ11C. A plug and jack used to connect this equipment to the premises' wiring and telephone network must comply with the applicable FCC Part 68 rules and requirements adopted by ACTA. A compliant telephone cord and modular plug is provided with this product. It is designed to be connected to a compatible modular jack that is also compliant.

See installation instructions for details.

The REN (Ringer Equivalence Number) is used to determine the number of devices that may connect to a telephone line. Excessive RENs on a telephone line may result in the devices not ringing in response to an incoming call. In most but not all areas, the sum of the RENs should not exceed five (5.0).

To be certain of the number of devices that may be connected to a line, as determined by the total RENs, contact your local telephone company. The REN for this product is part of the product identifier that has the format US: AA AEQ##TXXXX. The digits represented by ## are the REN without the decimal point (e.g., 03 is a REN of 0.3).

If this DIRECTV® Receiver causes harm to the telephone network, the telephone company will notify you in advance that temporary discontinuance of service may be required. But if advance notice isn't practical, the telephone company will notify the customer as soon as possible. Also, you will be advised of your right to file a complaint with the FCC if you believe it is necessary.

The telephone company may make changes in its facilities, equipment, operations or procedures that could affect the proper functioning of your equipment. If they do, you will be notified in advance in order for you to make necessary modifications to

## FCC CUSTOMER INFORMATION

maintain uninterrupted service. Connection to party line service is subject to state tariffs. Contact the state public utility commission, public service commission or corporation commission for information.

If trouble is experienced with this unit, for repair or warranty information, please contact DIRECTV Customer Care at the address and phone number listed below. If the equipment is causing harm to the network, the telephone company may request that you disconnect the equipment until the problem is resolved.

### **DIRECTV**

**2230 E. Imperial Hwy  
El Segundo, CA 90245  
1-800-DIRECTV**

If your home has specially wired alarm equipment connected to the telephone line, ensure the installation of this DIRECTV Satellite Receiver does not disable your alarm equipment. If you have questions about what will disable alarm equipment, consult your alarm company, telephone company or a qualified installer.

**DO NOT DISASSEMBLE THIS EQUIPMENT.** It does not contain any user-serviceable components.

We recommend the installation of an AC surge arrester in the AC outlet to which this equipment is connected. Telephone companies report that electrical surges, typically lightning transients, are very destructive to customer terminal equipment connected to AC power sources.

### **FCC RF Radiation Exposure Statement**

MPE/SAR/RF Exposure Information. This equipment complies with FCC RF radiation exposure limits set forth for an uncontrolled environment.

This equipment was verified for RF exposure and found to comply with Council Recommendation 1999/519/EC and FCC OET-65 RF exposure requirements.

**WARNING:** While this equipment is in operation, a separation distance of at least 20 centimeters (equal to 8 inches) must be maintained between the antenna inside the equipment and the bodies of all persons exposed to the antenna in order to meet the FCC RF exposure guidelines. Making changes to the antenna or the equipment is not permitted. Doing so may result in the equipment exceeding the FCC RF exposure guidelines. This equipment must not be co-located or operated in conjunction with any other antenna or radio transmitter.

## TERMS AND CONDITIONS FOR USE OF SOFTWARE (“TERMS”)

THE DIRECTV® RECEIVER INCORPORATES SOFTWARE WHICH IS OWNED BY DIRECTV OR ITS THIRD PARTY LICENSORS (the “Software”). BEFORE USING THE RECEIVER PLEASE READ THESE TERMS. IF YOU DO NOT AGREE TO THESE TERMS, YOU MAY NOT USE THE RECEIVER AND SHOULD IMMEDIATELY RETURN THE RECEIVER TO DIRECTV OR YOUR SUPPLIER. THESE TERMS ALSO APPLY TO ANY MODIFICATIONS, UPDATES OR SUPPLEMENTS TO THE SOFTWARE PROVIDED TO YOU.

### A. License Grant and Conditions

DIRECTV grants you a non-exclusive, non-transferable, limited license to use the Software solely in executable code form and solely as integrated with, incorporated into, and in conjunction with the Receiver. You must ensure that the copyright, trademark and other protective notices contained in the Software are maintained and not altered or removed. The Software is protected by copyright and other laws and international copyright and other treaties. All title and intellectual property rights in and to the Software and all modifications, updates, enhancements and derivative works of the Software are owned exclusively by DIRECTV or its licensors and you agree to execute any document reasonably requested by DIRECTV to evidence such ownership rights. Certain third party software used in connection with the Receiver may be made directly available to you by the providers thereof. The source code to certain software subject to the GNU GPL and other open source licenses that is used in connection with the Receiver is made available to you by DIRECTV following the written request to DIRECTV. Use of such Software is also subject to the terms of any applicable agreement between you and each such provider. DIRECTV reserves the right to modify, supplement, update and otherwise alter the Software via software download or other modification procedures, and these terms will apply to such Software as modified, supplemented, updated, and otherwise altered.

### B. License Restrictions

You may not copy, modify or transfer the Software, or any copy thereof, in whole or in part. You may not reverse engineer, disassemble, decompile or translate the Software, or otherwise attempt to derive the source code of the Software, except to the extent allowed under any applicable law. Any attempt to transfer any of the rights, duties or obligations of this license agreement is void. You may not rent, lease, load, resell for profit or distribute the Software, or any part thereof. You may not export, transfer or re-export the Software in violation of any applicable law. The Software may include some components that are covered by “free software” licenses, open source licenses and other similar license use rights, which require such components to be used, modified and/or distributed only under the terms of such licenses. Any such components are subject only to the terms of such licenses, and not these Terms.

## TERMS AND CONDITIONS FOR USE OF SOFTWARE (“TERMS”)

### C. Ownership of Software and Reservation of Rights

The Software is licensed, not sold, to you for use only under the terms of this license agreement, DIRECTV is NOT transferring title or any ownership rights in the Software to you and DIRECTV and its suppliers reserve all rights not expressly granted to you. Except as stated above, this license agreement does not grant to you any intellectual property rights in the Software.

### D. Termination

These Terms are effective until terminated. You may terminate these Terms by returning the Receiver to DIRECTV or your supplier. These Terms will terminate automatically without notice if you fail to comply with these Terms or any other agreement between you and DIRECTV. Upon termination you must return the Receiver to DIRECTV or your supplier.

### E. Disclaimer

THE SOFTWARE IS (TO THE EXTENT PERMITTED BY LAW) SUPPLIED “AS IS”. NEITHER DIRECTV NOR ANY OF ITS LICENSORS EXPRESSLY MAKES OR PASSES ON TO YOU ANY WARRANTY OR REPRESENTATION ON BEHALF OF DIRECTV OR ITS LICENSORS WITH RESPECT TO THE SOFTWARE, INCLUDING BUT NOT LIMITED TO ANY WARRANTIES, EXPRESS OR IMPLIED, INCLUDING (BUT NOT LIMITED TO) ANY IMPLIED WARRANTIES OF MERCHANTABILITY, SATISFACTORY QUALITY, FITNESS FOR A PARTICULAR PURPOSE, TITLE OR NON-INFRINGEMENT OF THIRD PARTY RIGHTS.

IN NO EVENT WILL DIRECTV OR ITS LICENSORS BE LIABLE TO YOU WITH RESPECT TO THE SOFTWARE FOR ANY DIRECT, INDIRECT, CONSEQUENTIAL, SPECIAL, PUNITIVE OR INCIDENTAL DAMAGE (INCLUDING LOSS OF PROFITS, LOST SAVINGS, LOSS OF DATA OR THE COST OF PROCUREMENT OF SUBSTITUTE GOODS, TECHNOLOGY OR SERVICES) ARISING OUT OF THE USE OR THE INABILITY TO USE THE SOFTWARE, EVEN IF DIRECTV OR ITS LICENSORS HAVE BEEN ADVISED OF THE POSSIBILITY OF SUCH DAMAGES, OR FOR ANY CLAIM BY A THIRD PARTY. Some states or jurisdictions do not allow the exclusion or limitation of incidental, consequential or special damages, so the above limitations may not apply to you.

### F. Third Party Beneficiaries

DIRECTV’S LICENSORS AND SUPPLIERS SHALL BE THIRD PARTY BENEFICIARIES OF THESE LICENSE TERMS, AS APPLICABLE.

YOUR USE OF THE RECEIVER CONSTITUTES YOUR ACKNOWLEDGEMENT THAT YOU HAVE READ THESE TERMS AND AGREE TO BE BOUND HEREBY.

## TERMS AND CONDITIONS FOR USE OF SOFTWARE (“TERMS”)

### G. Additional Information

Certain additional terms and information for the Software and certain third party software (including the text of licenses applicable to any free, open source and other similar software that may be included in the Software) may be found in the DIRECTV website located at [www.directv.com](http://www.directv.com), and the GNU website located at [www.gnu.org](http://www.gnu.org).

### H. GNU GPL and Open Source Software

Certain components of the Software may be subject to the GNU General Public Licence, Version 2, June 1991 (“GPL”), “free software” licenses and other open source software licenses. The foregoing components of the Software are not and may not be subject to the License Restrictions in Section B above. In compliance with the GPL, DIRECTV, its suppliers, or its third party licensors, upon written request, will make the source code of the software, libraries and associated utilities it uses, together with its modifications (if any), available to the public in source code form. You are free to use, modify and distribute the software and any modifications as long as you comply with the terms of the GPL referred to above and other open source software licenses. The license terms applicable to the GPL may be found in the DIRECTV website located at [www.directv.com](http://www.directv.com), and the GNU website located at [www.gnu.org](http://www.gnu.org), specifically at (<http://www.gnu.org/licenses/old-licenses/gpl-2.0.html>). To request a copy of the applicable source code please write to DIRECTV at:

**Attention: Vice President, STB Engineering**  
**DIRECTV**  
**2230 E. Imperial Highway**  
**El Segundo, CA 90245**

### GNU GENERAL PUBLIC LICENSE

Version 2, June 1991

Copyright © 1989, 1991 Free Software Foundation, Inc.,  
51 Franklin Street, Fifth Floor, Boston, MA 02110-1301 USA  
Everyone is permitted to copy and distribute verbatim copies  
of this license document, but changing it is not allowed.

## TERMS AND CONDITIONS FOR USE OF SOFTWARE (“TERMS”)

### Preamble

The licenses for most software are designed to take away your freedom to share and change it. By contrast, the GNU General Public License is intended to guarantee your freedom to share and change free software--to make sure the software is free for all its users. This General Public License applies to most of the Free Software Foundation's software and to any other program whose authors commit to using it. (Some other Free Software Foundation software is covered by the GNU Lesser General Public License instead.) You can apply it to your programs, too.

When we speak of free software, we are referring to freedom, not price. Our General Public Licenses are designed to make sure that you have the freedom to distribute copies of free software (and charge for this service if you wish), that you receive source code or can get it if you want it, that you can change the software or use pieces of it in new free programs; and that you know you can do these things.

To protect your rights, we need to make restrictions that forbid anyone to deny you these rights or to ask you to surrender the rights. These restrictions translate to certain responsibilities for you if you distribute copies of the software, or if you modify it.

For example, if you distribute copies of such a program, whether gratis or for a fee, you must give the recipients all the rights that you have. You must make sure that they, too, receive or can get the source code. And you must show them these terms so they know their rights.

We protect your rights with two steps: (1) copyright the software, and (2) offer you this license which gives you legal permission to copy, distribute and/or modify the software.

Also, for each author's protection and ours, we want to make certain that everyone understands that there is no warranty for this free software. If the software is modified by someone else and passed on, we want its recipients to know that what they have is not the original, so that any problems introduced by others will not reflect on the original authors' reputations.

Finally, any free program is threatened constantly by software patents. We wish to avoid the danger that redistributors of a free program will individually obtain patent licenses, in effect making the program proprietary. To prevent this, we have made it clear that any patent must be licensed for everyone's free use or not licensed at all.

The precise terms and conditions for copying, distribution and modification follow.

# TERMS AND CONDITIONS FOR USE OF SOFTWARE (“TERMS”)

## GNU GENERAL PUBLIC LICENSE

### TERMS AND CONDITIONS FOR COPYING, DISTRIBUTION AND MODIFICATION

0. This License applies to any program or other work which contains a notice placed by the copyright holder saying it may be distributed under the terms of this General Public License. The “Program”, below, refers to any such program or work, and a “work based on the Program” means either the Program or any derivative work under copyright law: that is to say, a work containing the Program or a portion of it, either verbatim or with modifications and/or translated into another language. (Hereinafter, translation is included without limitation in the term “modification”.) Each licensee is addressed as “you”.

Activities other than copying, distribution and modification are not covered by this License; they are outside its scope. The act of running the Program is not restricted, and the output from the Program is covered only if its contents constitute a work based on the Program (independent of having been made by running the Program). Whether that is true depends on what the Program does.

1. You may copy and distribute verbatim copies of the Program’s source code as you receive it, in any medium, provided that you conspicuously and appropriately publish on each copy an appropriate copyright notice and disclaimer of warranty; keep intact all the notices that refer to this License and to the absence of any warranty; and give any other recipients of the Program a copy of this License along with the Program.

You may charge a fee for the physical act of transferring a copy, and you may at your option offer warranty protection in exchange for a fee.

2. You may modify your copy or copies of the Program or any portion of it, thus forming a work based on the Program, and copy and distribute such modifications or work under the terms of Section 1 above, provided that you also meet all of these conditions:

- a) You must cause the modified files to carry prominent notices stating that you changed the files and the date of any change.
- b) You must cause any work that you distribute or publish, that in whole or in part contains or is derived from the Program or any part thereof, to be licensed as a whole at no charge to all third parties under the terms of this License.
- c) If the modified program normally reads commands interactively when run, you must cause it, when started running for such interactive use in the most ordinary way, to print or display an announcement including an appropriate copyright notice and a notice that there is no warranty (or else, saying that you provide a warranty) and that users may redistribute the program under these conditions, and telling the user how to view a copy of this License. (Exception: if the Program itself is interactive but does not normally print such an announcement, your work based on the Program is not required to print an announcement.)

## TERMS AND CONDITIONS FOR USE OF SOFTWARE (“TERMS”)

These requirements apply to the modified work as a whole. If identifiable sections of that work are not derived from the Program, and can be reasonably considered independent and separate works in themselves, then this License, and its terms, do not apply to those sections when you distribute them as separate works. But when you distribute the same sections as part of a whole which is a work based on the Program, the distribution of the whole must be on the terms of this License, whose permissions for other licensees extend to the entire whole, and thus to each and every part regardless of who wrote it.

Thus, it is not the intent of this section to claim rights or contest your rights to work written entirely by you; rather, the intent is to exercise the right to control the distribution of derivative or collective works based on the Program.

In addition, mere aggregation of another work not based on the Program with the Program (or with a work based on the Program) on a volume of a storage or distribution medium does not bring the other work under the scope of this License.

3. You may copy and distribute the Program (or a work based on it, under Section 2) in object code or executable form under the terms of Sections 1 and 2 above provided that you also do one of the following:

- a) Accompany it with the complete corresponding machine-readable source code, which must be distributed under the terms of Sections 1 and 2 above on a medium customarily used for software interchange; or,
- b) Accompany it with a written offer, valid for at least three years, to give any third party, for a charge no more than your cost of physically performing source distribution, a complete machine-readable copy of the corresponding source code, to be distributed under the terms of Sections 1 and 2 above on a medium customarily used for software interchange; or,
- c) Accompany it with the information you received as to the offer to distribute corresponding source code. (This alternative is allowed only for noncommercial distribution and only if you received the program in object code or executable form with such an offer, in accord with Subsection b above.)

The source code for a work means the preferred form of the work for making modifications to it. For an executable work, complete source code means all the source code for all modules it contains, plus any associated interface definition files, plus the scripts used to control compilation and installation of the executable. However, as a special exception, the source code distributed need not include anything that is normally distributed (in either source or binary form) with the major components (compiler, kernel, and so on) of the operating system on which the executable runs, unless that component itself accompanies the executable.

If distribution of executable or object code is made by offering access to copy from a designated place, then offering equivalent access to copy the source code from the same place counts as distribution of the source code, even though third parties are not compelled to copy the source along with the object code.



## TERMS AND CONDITIONS FOR USE OF SOFTWARE (“TERMS”)

4. You may not copy, modify, sublicense, or distribute the Program except as expressly provided under this License. Any attempt otherwise to copy, modify, sublicense or distribute the Program is void, and will automatically terminate your rights under this License.

However, parties who have received copies, or rights, from you under this License will not have their licenses terminated so long as such parties remain in full compliance.

5. You are not required to accept this License, since you have not signed it. However, nothing else grants you permission to modify or distribute the Program or its derivative works. These actions are prohibited by law if you do not accept this License. Therefore, by modifying or distributing the Program (or any work based on the Program), you indicate your acceptance of this License to do so, and all its terms and conditions for copying, distributing or modifying the Program or works based on it.

6. Each time you redistribute the Program (or any work based on the Program), the recipient automatically receives a license from the original licensor to copy, distribute or modify the Program subject to these terms and conditions. You may not impose any further restrictions on the recipients' exercise of the rights granted herein. You are not responsible for enforcing compliance by third parties to this License.

7. If, as a consequence of a court judgment or allegation of patent infringement or for any other reason (not limited to patent issues), conditions are imposed on you (whether by court order, agreement or otherwise) that contradict the conditions of this License, they do not excuse you from the conditions of this License. If you cannot distribute so as to satisfy simultaneously your obligations under this License and any other pertinent obligations, then as a consequence you may not distribute the Program at all. For example, if a patent license would not permit royalty-free redistribution of the Program by all those who receive copies directly or indirectly through you, then the only way you could satisfy both it and this License would be to refrain entirely from distribution of the Program.

If any portion of this section is held invalid or unenforceable under any particular circumstance, the balance of the section is intended to apply and the section as a whole is intended to apply in other circumstances.

It is not the purpose of this section to induce you to infringe any patents or other property right claims or to contest validity of any such claims; this section has the sole purpose of protecting the integrity of the free software distribution system, which is implemented by public license practices. Many people have made generous contributions to the wide range of software distributed through that system in reliance on consistent application of that system; it is up to the author/donor to decide if he or she is willing to distribute software through any other system and a licensee cannot impose that choice.

## TERMS AND CONDITIONS FOR USE OF SOFTWARE (“TERMS”)

This section is intended to make thoroughly clear what is believed to be a consequence of the rest of this License.

8. If the distribution and/or use of the Program is restricted in certain countries either by patents or by copyrighted interfaces, the original copyright holder who places the Program under this License may add an explicit geographical distribution limitation excluding those countries, so that distribution is permitted only in or among countries not thus excluded. In such case, this License incorporates the limitation as if written in the body of this License.

9. The Free Software Foundation may publish revised and/or new versions of the General Public License from time to time. Such new versions will be similar in spirit to the present version, but may differ in detail to address new problems or concerns. Each version is given a distinguishing version number. If the Program specifies a version number of this License which applies to it and “any later version”, you have the option of following the terms and conditions either of that version or of any later version published by the Free Software Foundation. If the Program does not specify a version number of this License, you may choose any version ever published by the Free Software Foundation.

10. If you wish to incorporate parts of the Program into other free programs whose distribution conditions are different, write to the author to ask for permission. For software which is copyrighted by the Free Software Foundation, write to the Free Software Foundation; we sometimes make exceptions for this. Our decision will be guided by the two goals of preserving the free status of all derivatives of our free software and of promoting the sharing and reuse of software generally.

### NO WARRANTY

11. BECAUSE THE PROGRAM IS LICENSED FREE OF CHARGE, THERE IS NO WARRANTY FOR THE PROGRAM, TO THE EXTENT PERMITTED BY APPLICABLE LAW. EXCEPT WHEN OTHERWISE STATED IN WRITING THE COPYRIGHT HOLDERS AND/OR OTHER PARTIES PROVIDE THE PROGRAM “AS IS” WITHOUT WARRANTY OF ANY KIND, EITHER EXPRESSED OR IMPLIED, INCLUDING, BUT NOT LIMITED TO, THE IMPLIED WARRANTIES OF MERCHANTABILITY AND FITNESS FOR A PARTICULAR PURPOSE. THE ENTIRE RISK AS TO THE QUALITY AND PERFORMANCE OF THE PROGRAM IS WITH YOU. SHOULD THE PROGRAM PROVE DEFECTIVE, YOU ASSUME THE COST OF ALL NECESSARY SERVICING, REPAIR OR CORRECTION.

12. IN NO EVENT UNLESS REQUIRED BY APPLICABLE LAW OR AGREED TO IN WRITING WILL ANY COPYRIGHT HOLDER, OR ANY OTHER PARTY WHO MAY MODIFY AND/OR REDISTRIBUTE THE PROGRAM AS PERMITTED ABOVE, BE LIABLE TO YOU FOR DAMAGES, INCLUDING ANY GENERAL, SPECIAL, INCIDENTAL OR CONSEQUENTIAL DAMAGES ARISING OUT OF THE USE OR INABILITY TO USE THE PROGRAM (INCLUDING BUT NOT LIMITED TO LOSS OF DATA OR DATA BEING RENDERED INACCURATE OR LOSSES SUSTAINED BY YOU OR THIRD PARTIES OR A FAILURE OF THE PROGRAM TO OPERATE WITH ANY OTHER PROGRAMS),

## TERMS AND CONDITIONS FOR USE OF SOFTWARE (“TERMS”)

EVEN IF SUCH HOLDER OR OTHER PARTY HAS BEEN ADVISED OF THE POSSIBILITY OF SUCH DAMAGES.

END OF TERMS AND CONDITIONS

How to Apply These Terms to Your New Programs

If you develop a new program, and you want it to be of the greatest possible use to the public, the best way to achieve this is to make it free software which everyone can redistribute and change under these terms.

To do so, attach the following notices to the program. It is safest to attach them to the start of each source file to most effectively convey the exclusion of warranty; and each file should have at least the “copyright” line and a pointer to where the full notice is found.

<one line to give the program’s name and a brief idea of what it does.>

Copyright (C) <year> <name of author>

This program is free software; you can redistribute it and/or modify it under the terms of the GNU General Public License as published by the Free Software Foundation; either version 2 of the License, or (at your option) any later version.

This program is distributed in the hope that it will be useful, but WITHOUT ANY WARRANTY; without even the implied warranty of MERCHANTABILITY or FITNESS FOR A PARTICULAR PURPOSE. See the GNU General Public License for more details. You should have received a copy of the GNU General Public License along with this program; if not, write to the Free Software Foundation, Inc., 51 Franklin Street, Fifth Floor, Boston, MA 02110-1301 USA.

Also add information on how to contact you by electronic and paper mail. If the program is interactive, make it output a short notice like this when it starts in an interactive mode:

Gnomovision version 69, Copyright (C) year name of author

Gnomovision comes with ABSOLUTELY NO WARRANTY; for details type `show w`. This is free software, and you are welcome to redistribute it under certain conditions; type `show c` for details.

The hypothetical commands `show w` and `show c` should show the appropriate parts of the General Public License. Of course, the commands you use may be called something other than `show w` and `show c`; they could even be mouse-clicks or menu items--whatever suits your program.

You should also get your employer (if you work as a programmer) or your school, if any, to sign a “copyright disclaimer” for the program, if necessary. Here is a sample; alter the names:

## TERMS AND CONDITIONS FOR USE OF SOFTWARE (“TERMS”)

Yoyodyne, Inc., hereby disclaims all copyright interest in the program `Gnomovision' (which makes passes at compilers) written by James Hacker.

<signature of Ty Coon>, 1 April 1989

Ty Coon, President of Vice

This General Public License does not permit incorporating your program into proprietary programs. If your program is a subroutine library, you may consider it more useful to permit linking proprietary applications with the library. If this is what you want to do, use the GNU Lesser General Public License instead of this License.

# APPENDICES

---

<b>Appendix 1: Setup and Activation</b> .....	<b>144</b>
Guided Setup .....	144
Activate Your DIRECTV® Service .....	144
<b>Appendix 2: Connections to TV &amp; Equipment</b> .....	<b>145</b>
Your Phone Connection .....	145
Your Internet Connection .....	145
Connections For Auxiliary Equipment .....	146
HD TV Connections .....	149
HD TV Connections .....	150
SD TV Connections .....	151
Audio Connections .....	153
Connections to Other Equipment .....	154
<b>Appendix 3: Receiver Front and Back Panels</b> .....	<b>155</b>
<b>Appendix 4: Get Connected</b> .....	<b>159</b>
Accounts Without Whole-Home Service .....	160
<b>Appendix 5: About High-Definition</b> .....	<b>165</b>
Screen Format & Resolution .....	165
Supported Resolutions .....	167
Wide-Screen vs. Standard Formats .....	168

## APPENDIX 1: SETUP AND ACTIVATION

### GUIDED SETUP

If your Receiver was not professionally installed, or you have had to reset your Receiver for any reason, you will need to follow the guided setup screens before starting DIRECTV service.

1. For the Universal Remote, make sure the MODE switch at the top of the Remote is set to DIRECTV, which is the far-left position.
2. Press ON. The DIRECTV® Receiver will turn on. (Make sure your TV is also turned on!)
3. The first screen will allow you to select a language. Using the arrow keys on the remote control, move to the language you prefer and press SELECT.
4. Follow the onscreen instructions.

After these setup procedures are complete, you'll see a message onscreen that says, "Acquiring Satellite Info", as the Receiver gathers information from the satellite for the onscreen Program Guide. Next, you'll be given the opportunity to program your remote to control other equipment such as your TV and/or DVD player. Just follow the screen instructions and you'll be ready to watch in no time!

### ACTIVATE YOUR DIRECTV® SERVICE

Once all the setup processes are complete, all that's left to do is activate your DIRECTV® service. Be sure to:

1. Have on hand your service address, social security number and a valid major credit card.
2. Note your Receiver ID and access card numbers. The Receiver ID is on a sticker behind the access card door on the front of the Receiver, while the card number is on the access card itself. Use the Product Information page to note this information.
3. When you're ready, call 1.800.531.5000 to choose the programming package that's right for you and subscribe to DIRECTV service.

## APPENDIX 2: CONNECTIONS TO TV & EQUIPMENT

### YOUR PHONE CONNECTION

Connecting your Receiver to a land-based telephone line saves you money. It allows you to purchase Pay Per View movies and special events without calling DIRECTV® to order. It is required for sports package subscriptions and is also used to enhance features on interactive channels. The Receiver uses a toll-free number once a month for a few minutes duration and is designed not to interfere with your regular phone service. You will need an RJ11-type modulator jack (the most common type of phone jack). If you disconnect the phone line, the Receiver will be unable to transact PPV purchases, and some interactive channel features will be limited. If your Receiver is connected to the Internet, either directly or via a DIRECTV Home Network connection, you do not need to be connected to a phone line. See “Your Internet Connection” below.

**WARNING:** Do not connect your Receiver to a digital PBX phone system — doing so may permanently damage your equipment and void your warranty.

### YOUR INTERNET CONNECTION

Connecting your DIRECTV Receiver to the Internet and your home network gives you access to the full range of DIRECTV features and content like:

- Thousands of free and premium On Demand titles, some almost a month before they are available on Netflix and other streaming services.
- TV Apps, including ScoreGuide, Weather, and What's Hot.
- Pandora, Music & Photos and more.

The instructions for connecting to a network vary depending on whether you have Whole-Home DVR Service or not. Please see Appendix 4 for more information.

**NOTE:** For the most current options, benefits and instructions for connecting your Receiver to the Internet, go to [directv.com/getconnected](http://directv.com/getconnected).

## APPENDIX 2: CONNECTIONS TO TV & EQUIPMENT

### CONNECTIONS FOR AUXILIARY EQUIPMENT

If you upgrade your TV, or DIRECTV® Receiver, or add new equipment such as a surround sound system, DVD player or burner, you have various options for connecting your equipment. All of the video and audio outputs on your Receiver offer good quality. Pick a video and audio output from the following lists based on the connectors your Receiver and TV support; they are listed in order, with the highest quality options at the top of each list. Not all connectors are available on all Receivers and TV models.

#### NOTE:

- Not all cables come with your Receiver; you may need to purchase additional cables depending on your setup. HDMI cables are available from DIRECTV at a nominal charge. Contact DIRECTV customer service for more information.
- Never connect an IN to an IN or an OUT to an OUT. All A/V jacks and inputs are color-coded. Always match the color of the plug to the same color of the jack.
- To obtain the best picture quality, make sure the Receiver is connected directly to the TV.
- Due to restrictions imposed by copyright holders, certain programming may include content protection measures that may restrict viewing or recording with certain consumer electronics equipment attached to the Receiver. Please contact the manufacturer of such equipment for additional information.

**WARNING:** Use only the power supply (power cord) that came with your DIRECTV Receiver. Failure to use the authorized power supply (power cord) may cause electric shock, fire, bodily injury and/or property damage. If the power supply (power cord) becomes damaged or needs to be replaced, please contact DIRECTV Customer Service to obtain an authorized replacement.

**WARNING:** Do not connect your Receiver (or any other equipment, such as a TV or VCR) to the AC power supply until you have properly connected all the other cables.



## APPENDIX 2: CONNECTIONS TO TV & EQUIPMENT

The table below shows the benefits and disadvantages of each type of available video connector:

	HDMI	Component	S-Video	RCA
High Def (HD)	✓	✓	✗	✗
HD 1080p	✓	✗	✗	✗
3D	✓	✗	✗	✗
Built-in Audio	✓	✗	✗	✗
Standard Def	✓	✓	✓	✓

### HD Video Connections

- **HDMI [High-Definition Multimedia Interface]** provides the best digital video and digital audio in one connector. HDMI is the only recommended cable, and is required for the highest quality 1080p signal and 3D TV.
- **Component Video Output (YPbPr)** provides high-quality HD video, but does not provide audio. You will need to connect audio separately using the digital audio or RCA audio connectors. Newer Receivers have an "A/V Out" connector that provides Component Video and RCA audio output in a single, custom cable. Component cables do not provide 1080p or 3D TV.

### SD Video Connections

These cables are provided for convenience only, and do not present an HD picture. They are useful if you have to connect your DIRECTV® HD DVR to an older CRT TV, a VCR, or other non-HD device.

- **S-Video** provides good video, but does not provide audio. You will need to connect audio separately using the digital audio or RCA audio connectors. (Not all Receivers have S-Video outputs.)
- **RCA output (composite video)** provides good video and usually comes bundled with three cables for one video and two audio channels.

## APPENDIX 2: CONNECTIONS TO TV & EQUIPMENT

### Audio Connections

- **HDMI [High-Definition Multimedia Interface]** provides the best digital video and audio in one connector.
- **Digital Audio Optical** provides excellent quality digital audio and is often used on newer surround sound and DVD equipment.
- **Digital Audio Coax** provides high quality digital audio and is also found on newer surround sound and DVD equipment.
- **RCA** outputs provide good audio quality and are found on older auxiliary equipment.

Because so many makes and models of TVs and auxiliary equipment are available, we cannot fully describe all of the possible connections with your Receiver. Refer to the manuals for that equipment to see the connection options specific to each make and model. The following images show examples of how your Receiver may be connected using the supported video and audio connections for the TV, the surround sound, and the DVD player/burner. Several models of DIRECTV Receivers are shown, giving you a variety of connection options to your TV and other equipment.

## HD TV CONNECTIONS

### Example: TV with HDMI Connector - RECOMMENDED

Here is an example using a TV that has an HDMI connector as the best video/audio input.

Note: **Only** an HDMI connection provides a 1080p picture and 3D TV.

### Television



HDMI Cable



## APPENDIX 2: CONNECTIONS TO TV &amp; EQUIPMENT

## HD TV CONNECTIONS

## Example: TV with Component Video Connectors

Here is an example using a TV that has component video connectors as the best video input.

Note: A Component Video connection will not provide a 1080p picture nor 3D TV.

Component Video requires a separate audio connection.

## Television

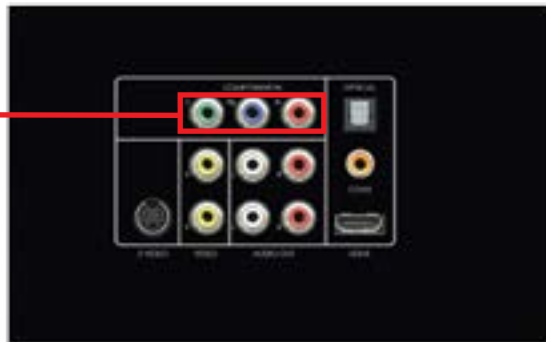

Component  
Video



## SD TV CONNECTIONS

[This connection does not provide an HD picture.]

### Example: TV with RCA Connectors

Here is an example of a TV that has an S-Video connector as the best video input (Not all Receivers have an S-Video connector.)

S-Video requires a separate audio connection.

### Television

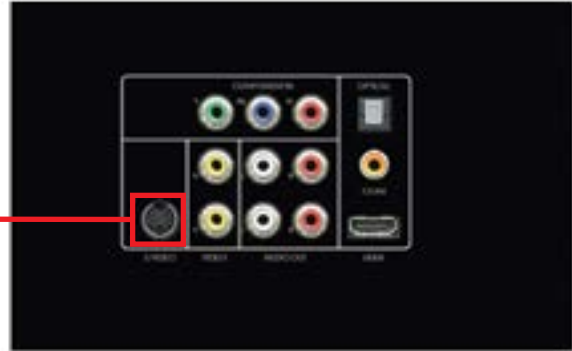

S-Video  
Cable



## APPENDIX 2: CONNECTIONS TO TV & EQUIPMENT

### SD TV CONNECTIONS

(This connection does not provide an HD picture.)

#### Example: TV with RCA Connectors

Here is an example of a TV that has RCA connectors as the best video input.

RCA cables are often bundled as a three-way cable with one video and two audio connections. You can also purchase a single-connection RCA video cable, and a separate cable for audio.

*RCA Video  
and Audio*



#### Television

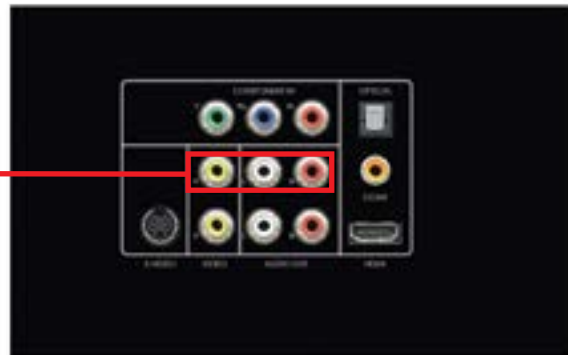

## AUDIO CONNECTIONS

Of all the video connections, only HDMI provides an audio signal with the video. The other connections all require a separate audio cable. Of these, your best quality signal will be from the Digital Audio Out/Optical connector, followed by the Digital Coax connector, followed by the RCA Audio Out connector.

The connector you end up using may be determined by the equipment you are connecting to. (For example, your home theater system may support only the Digital Audio Out/Optical connector.)

The red and white RCA audio out connectors are so common, it is possible you may have one of these cables already. However, these cables provide an analog signal, so you will be missing out on the benefits of digital quality sound.

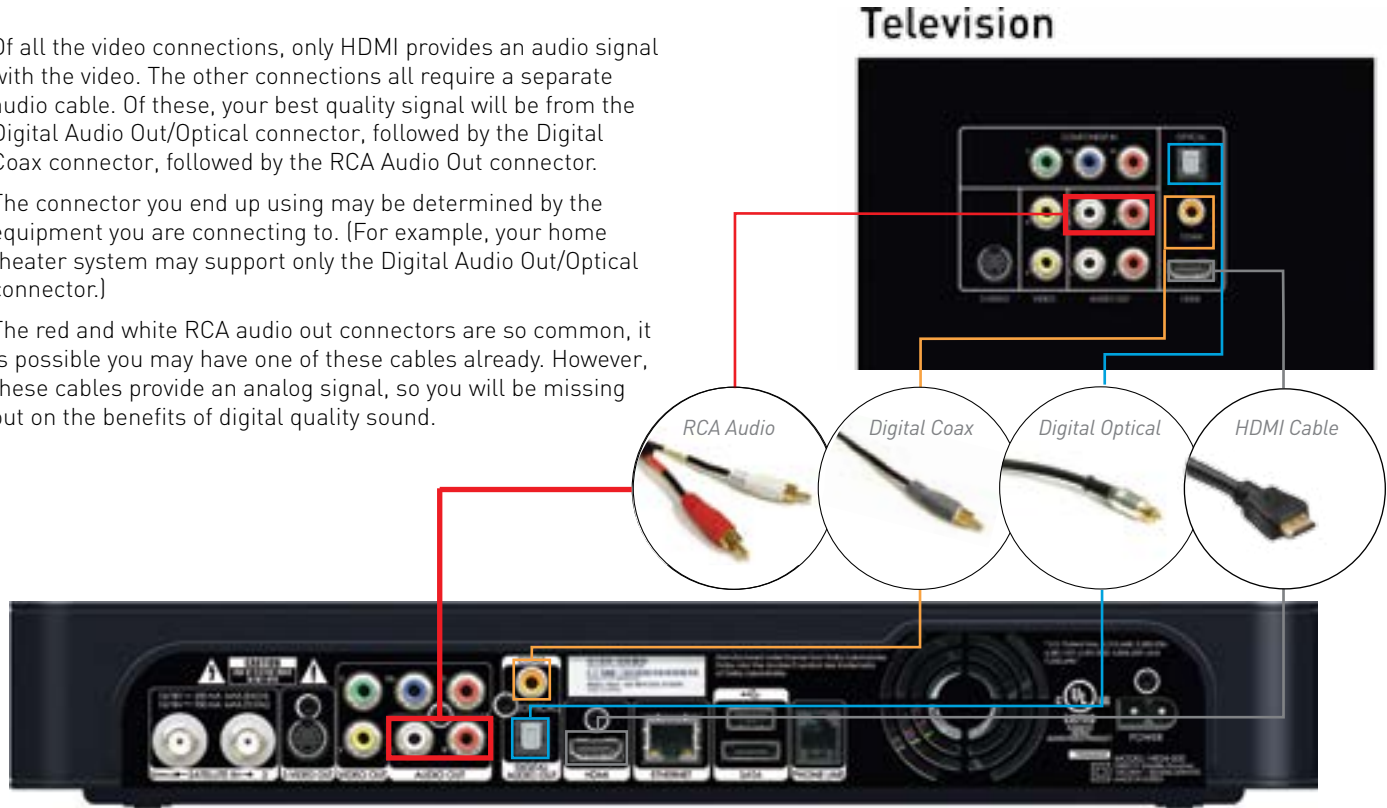

## APPENDIX 2: CONNECTIONS TO TV &amp; EQUIPMENT

## CONNECTIONS TO OTHER EQUIPMENT

In addition to your TV, you may wish to connect other devices, such as a BluRay Player, DVD burner, or even a second TV to your DIRECTV® Receiver. For the best-quality picture, it is recommended you do not use a pass-through connection from your TV or other equipment as an input to a DVD burner. Instead, use an available connection from your DIRECTV Receiver. For example, if you use the HDMI connection on your DIRECTV Receiver to connect to your TV, you can use the Component Video, Composite Video RCA, or S-Video Out to connect to your DVD burner or second TV.





## APPENDIX 3: RECEIVER FRONT AND BACK PANELS

### Front Panel Example

The buttons on the front panel perform the same functions as like-named buttons on the Remote. You can use the front panel buttons at any time, but they are especially useful if you misplace your Remote or the batteries die.

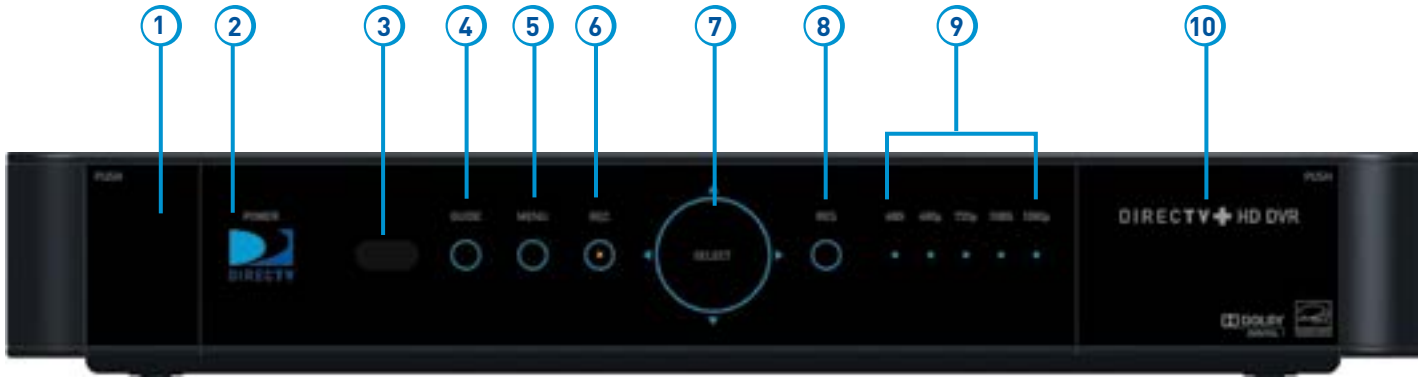

*Your equipment may not look exactly like the model illustrated.*

## APPENDIX 3: RECEIVER FRONT AND BACK PANELS

1. **DOOR PANEL, USB PORT** – For future use. USB 2.0 Host (FRONT/REAR EACH 5V = 500mA)
2. **POWER** – Turns your DIRECTV® Receiver on or off. Your DIRECTV Receiver still records and receives messages when powered off. The power light flashes when you press a key on the remote to let you know it has received the command.
3. **REMOTE SENSOR** – The infrared sensor picks up commands from the remote control. You cannot have any opaque object between the remote and this sensor or else the command will not get through. If you have an optional RF remote, this sensor is not used. With an optional RF remote, you can place your Receiver inside a cabinet or any non-metal enclosure and it will receive the remote control commands up to 200 feet away.
4. **GUIDE** – Displays the onscreen Program Guide.
5. **MENU** – Brings up the Main Menu to access features, settings and services.
6. **RECORD** – This button lights orange when a recording is in progress.
7. **SELECT** – Selects the item highlighted.
8. **RES (RESOLUTION)** – The RES key switches the output resolution of the DIRECTV Receiver. Each time you press the key, it cycles to the next available resolution: 480i, 480p, 720p, 1080i and 1080p (supported on some models). Note: The RESOLUTION button on the front panel only changes the resolution. It does not change the screen format (crop, stretch, letterbox, pillarbox). The FORMAT button on the remote control cycles through all of the screen formats and resolutions. See Appendix 5 for details.
9. **RESOLUTION INDICATORS** – Lights indicate the current resolution setting. 480i is the old analog TV setting. 480p is Enhanced Definition TV, which is less than HD. 720p is the first level of HDTV. 1080p is the highest level of HDTV provided by the Receiver. To get the best out of HD, you should be using 720p or higher resolution for your HDTV.
10. **DOOR / PANEL, ACCESS CARD** – The access card slot, RESET button, and Receiver ID and model number are located behind the door panel.

## APPENDIX 3: RECEIVER FRONT AND BACK PANELS

### Back Panel Examples

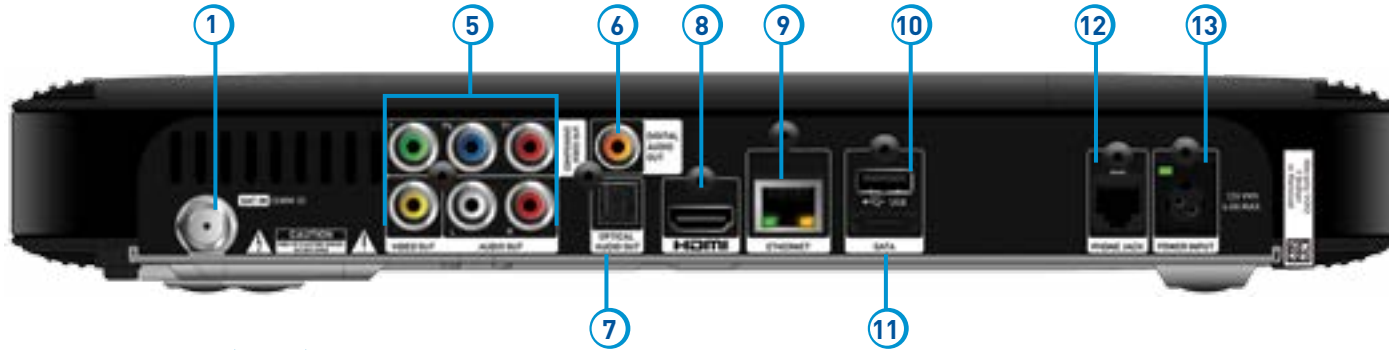

GENIE™ HD DVR (HR44)

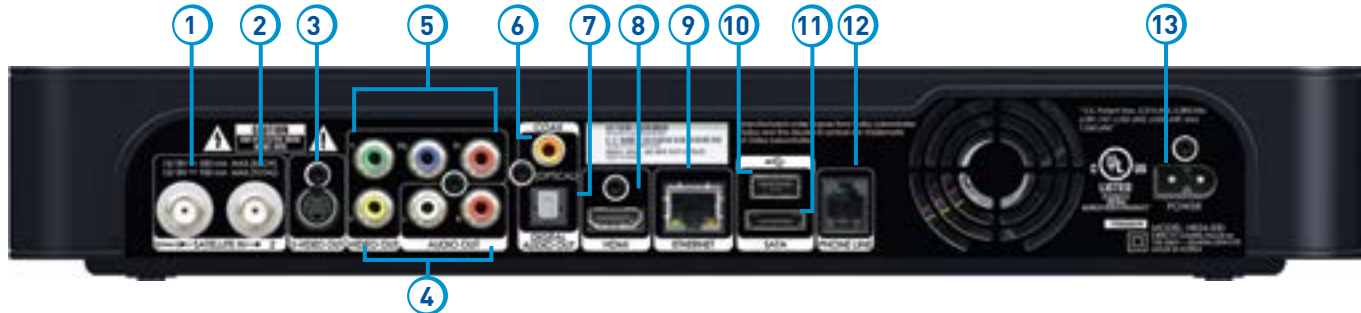

DIRECTV® HD DVR (HR2x Series)

*Your equipment may not look exactly like the model illustrated.*

## APPENDIX 3: RECEIVER FRONT AND BACK PANELS

1. **SATELLITE IN 1** – Connect one line from your satellite dish here. A Single Wire Multi-Switch (SWM) connection, if applicable, is made to this satellite in port.
2. **SATELLITE IN 2** – Connect the second line from your satellite dish here.
3. **S-VIDEO OUT** – A Standard-Definition video output.
4. **RCA-Audio/Video Jacks** – Standard-Definition output. You can use the entire row of RCA connectors (yellow, white and red) to feed a VCR or DVD player/burner.
5. **COMPONENT VIDEO OUT** – Use this block to connect up component video cables (green, blue, red); use the white and red RCA connectors below it for analog audio out. **These connectors provide an HD picture, but do not support 1080p or 3D.**
6. **DIGITAL AUDIO OUT COAXIAL** – Use this digital audio connection for sound.
7. **DIGITAL AUDIO OUT OPTICAL** – Use this digital audio connection for sound.
8. **HDMI** – Use this combination digital video and audio connector for the best picture quality. **This is the recommended connector for HD TV.**
9. **ETHERNET** – Please refer to Appendix 4 for information on networking options on your HD DVR before connecting anything to the Ethernet port.
10. **USB** – For future use. USB 2.0 Host (FRONT/REAR EACH 5V = 500mA)
11. **SATA** – Use this connector to add an external hard drive to your Receiver.
12. **PHONE JACK** – Connect your phone line here to enable Pay Per View purchasing and Caller ID (if your phone service package includes it).
13. **POWER** – Your Receiver must be plugged in at all times to function properly.
14. **IR RECEIVE** – Connect an IR (infrared) extender or repeater here when your Receiver is in a cabinet or otherwise not “visible” to your remote control.

## APPENDIX 4: GET CONNECTED

Connecting your HD DVR to the Internet means getting access to thousands of titles and shows across the entire DIRECTV library. To connect your DIRECTV® HD DVR to your home network, you will need:

- A DIRECTV HD DVR model HR20, HR34, HR44 or later, or DIRECTV Plus® DVR (model R22)
- A broadband Internet connection, with a connection speed of 750 kbps or higher (DSL or cable).
- A network router with an open Ethernet port, and/or wireless capability.

Connection instructions vary based on the type of DIRECTV service you have. Please see the appropriate sections that follow.

### If you have Whole-Home service:

- **Professionally Installed DIRECTV CINEMA® Connection Kit (CCK):** Schedule a professional installation appointment at [directv.com/getconnected](http://directv.com/getconnected).
- **Wireless Self-Installed DIRECTV CCK:** If you already connect to the Internet via WiFi, you can order the wireless CCK at [directv.com](http://directv.com) or by calling 1.800.531.5000 and connect it yourself with the instructions provided with the equipment.\*

### If you do not have Whole-Home service:

- **Wired:** The fastest, most reliable connection is a wired configuration. Requires running an Ethernet cable from a network router to your DIRECTV HD DVR.
- **Wireless:** This is the easiest method if you already connect to the Internet via WiFi. However, a wireless connection may be slower and less reliable than wired. You can order the DIRECTV Wireless CCK from [directv.com](http://directv.com), or at 1.800.531.5000.

For information for accounts without Whole-Home service, please see the instructions on the pages that follow.

**NOTE:** \*If you have the DIRECTV Genie HR44 Receiver, the DIRECTV CINEMA Connection Kit is not required to connect to the Internet. Please see page 165 later in this Appendix for special instructions for connecting your Genie HR44 HD DVR Receiver to the Internet.

For the most current information on connecting your Receiver to the Internet, visit [directv.com/getconnected](http://directv.com/getconnected).

## APPENDIX 4: GET CONNECTED

## ACCOUNTS WITHOUT WHOLE-HOME SERVICE

## For a Wired Connection

**Step 1** - Connect your DIRECTV HD DVR to your router:

- Connect one end of your Ethernet cable to the Ethernet port on the back of your router.
- Connect the other end of the Ethernet cable to the Ethernet port on the back of your DIRECTV® HD DVR.

**Step 2** - Verify that you are connected:

- Press **MENU** on your DIRECTV Remote
- Select **Settings & Help**
- Select **Settings**
- Select **Network Setup**
- Choose **Connect Now** (or Test Connection if you have connected previously)
- Select **Continue** after successfully connecting to DIRECTV via the Internet (See Figure A).
- Select **Done** to complete the setup process (See Figure B).

If your DIRECTV HD DVR does not immediately recognize the network connection, you will get the option to choose the connection method. Choose **Wired**. Follow the onscreen instructions.

## Direct Connection

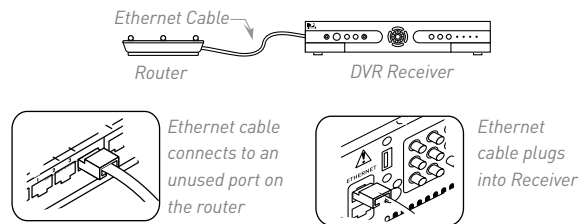

Figure A



Figure B



## For a Wireless Connection

Create a wireless connection between your wireless router and your DIRECTV HD DVR. As with a wired Internet connection, you'll have access to thousands of free and premium On Demand titles, TV Apps, Pandora and other features and content available only with an Internet connection.

### For HR44 HD DVR & Later Receiver Models

The DIRECTV® Genie™ HR44 HD DVR has a built-in wireless transceiver, which will pair with your existing wireless router to connect to your home broadband WiFi service. It eliminates the need for the external DIRECTV CINEMA® Connection Kit (CCK). However, if you do have a CCK already configured from a previous DIRECTV Receiver, the Genie HR44 will automatically detect your network settings and connect to the Internet.

In addition to the Network Requirements outlined earlier in this Appendix, you will need a **wireless router** set up and initialized for your home Internet service before you start the Internet connection sequence for your Genie HR44 HD DVR.

Get connected with the following steps:

**Step 1** - Be sure that your TV and DIRECTV Genie HR44 Receiver are on.

**Step 2** - Using the DIRECTV Genie Remote that came with your HR44 Receiver, or the Universal Remote, press **MENU**.

**Step 3** - Select **Settings & Help**, then **Settings**, then **Network Setup**.

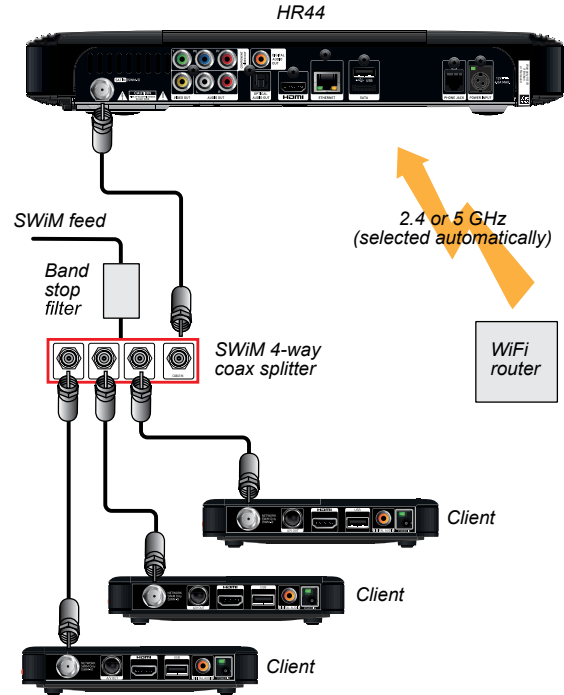

## APPENDIX 4: GET CONNECTED

**Step 4** - Select **Connect Now**, then **Continue**; the **Setup: Wireless Connection** screen will display.

**Step 5** - If supported by your WiFi router, choose **Push Button Setup** (also known as WPS) and the connection will complete; otherwise go to Step 5a below for **Manual Setup**.

**Step 5a** - Manual Setup Option

- From the Setup: **Wireless Connection** screen, select **Manual Setup**. Your HR44 will detect wireless networks within range and list them on the screen. (This can take a few minutes.)
- Select the target network that displays in the list.
- Use the RIGHT ARROW button and select **Continue**.
- Input your wireless router's password.
- Use the RIGHT ARROW button and select **Continue**.
- The wireless connection between your wireless router and your DIRECTV® HR44 HD DVR should now be active.
- Select **Done** to complete the manual setup process.

**NOTE:** If you experience difficulty connecting to the Internet, or need more information, visit [www.directv.com/getconnected](http://www.directv.com/getconnected).





## For HR34 HD DVR & Earlier Receiver Models

In addition to the Network Requirements previously outlined, you will need:

- A wireless adapter that uses an Ethernet port to connect to a media device, preferably the **Wireless DIRECTV CINEMA Connection Kit** – (CCK-W).
- A **wireless router** set up and initialized for your home Internet service before you start the Internet connection sequence for your HR34 HD DVR or earlier Receiver model.

**Step 1** - Connect your DIRECTV HR34 HD DVR (or earlier) to the wireless adapter:

- Connect one end of the Ethernet cable to the back of the wireless adapter and connect the other end of the cable to the back of your HD DVR.
- If using the DIRECTV CCK-W, follow connection instructions in the device user manual (or go to [directv.com/getconnected](http://directv.com/getconnected)) to determine proper connection.
- Plug your wireless adapter in to an electrical outlet.

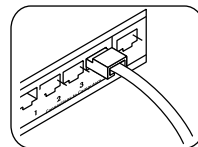
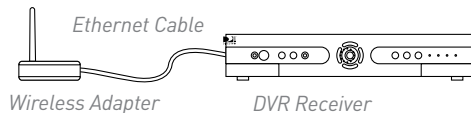

*Ethernet cable connects to the Ethernet port of the wireless adapter.*

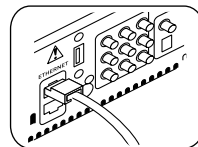

*Ethernet cable plugs into your HD DVR*

## APPENDIX 4: GET CONNECTED

**Step 2** - Ensure the wireless adapter is recognized by your home network:

- Once your router detects the wireless adapter, it will prompt you to configure the two devices. Select **Set Up Now**.
- Highlight your wireless network and press **SELECT** to display a blue dot next to your network. Then select **Continue**.
- Follow the onscreen instructions to complete the set-up process of the wireless adapter.

**Step 3** - Verify that you are connected:

Press the **MENU** button on your DIRECTV Remote.

- Select **Settings & Help**, then **Settings**, then **Network Setup**.
- Choose **Connect Now** (or **Test Connection**, if you have connected previously).
- Select **Continue** after successfully connecting to DIRECTV via the Internet (See Figure A).
- Select **Done** to finish the setup process (See Figure B).

If your DIRECTV HD DVR does not immediately recognize the network connection, you will have the option to choose the connection method. Choose **Wireless** (See Figure C) and follow the onscreen instructions.

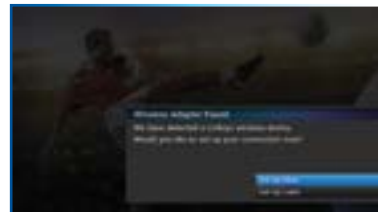

Figure A



Figure B



Figure C



## SCREEN FORMAT & RESOLUTION

In addition to resolution and interlacing, a television picture is also defined by its aspect ratio—aspect ratio equals the ratio of the screen's width to its height.

Analog TV (i.e., non-digital, conventional TV):

- Aspect ratio = 4 units wide by 3 units high (4:3).
- SDTV & EDTV = 4:3 or 16:9.
- HDTV = 16:9 (nearly twice as wide as it is tall.)
- HDTV's aspect ratio is approximately the shape of theatrical movie screens, which makes HD an ideal format for viewing movies on TV.

To optimize the display of programs on your television:

- Press INFO, then ARROW Right to **Audio/Video** and select **Change Resolution & Format**.
- Press **SELECT** until you see the settings you want.
- OR, using the RES (Resolution) key on the front panel of the DIRECTV HD DVR (HR25, HR34, HR44 and above) to change the resolution, but not the screen format, press RES and cycle through the options until you see the indicator light illuminate on the front of the Receiver for the resolution you want.

**NOTE:** In Native mode, the Receiver automatically adjusts the resolution to match individual TV programs as they are tuned. To confirm your Receiver's Native setting, press MENU, select Settings & Help, then select Settings, then Display, then Video. Press SELECT on the Native field to toggle this setting On or Off.

## APPENDIX 5: ABOUT HIGH-DEFINITION

### FORMAT Key on the Universal Remote

Alternately, if you are using a DIRECTV Universal Remote (RC6x series), you can use the FORMAT key on your remote to cycle the resolutions settings supported by your TV, as well as the screen formats in conjunction with each individual resolution. Available screen formats such as crop, stretch or letter/pillar box, are based on the TV Ratio setting. With each press, an onscreen message will indicate the current resolution/format setting is.

If Native is turned on, the FORMAT key cycles through the following formats for the current program's native resolution:

- Stretch
- Letter
- Crop

The FORMAT key allows you to easily cycle all resolution and format settings with a single key until the picture displays the way you like it.

**NOTE:** If pressing this key causes a loss of video and audio, continue pressing it until the picture returns. (Wait a second between presses to allow the Receiver to change the resolution.) This can happen if your settings include a resolution that your TV doesn't support.

To correct this: Press MENU, select Settings & Help, Settings, HDTV and then TV Resolutions. Mark or unmark the TV Resolutions to display the resolutions supported by your television.

**SUPPORTED RESOLUTIONS**

The following table shows the resolutions that can be output from each type of connection:

Output Connection	Available Resolutions
HDMI	1080i, 1080p, 720p, 480p
Component Video (YPbPr)	1080i, 720p, 480i, 480p
S-Video	480i
Video (RCA Type/Yellow)	480i

NOTE: 720p, 1080i and 1080p are HD formats: 480i and 480p are not. S-Video and RCA outputs display all resolutions as 480i.

## APPENDIX 5: ABOUT HIGH-DEFINITION

### WIDE-SCREEN VS. STANDARD FORMATS

#### 4:3 TVs Showing 16:9 Programing

A standard 4:3 TV is too narrow to a wide screen program. To correct this, choose:

**Letterbox:** This format, shrinks the 16.9 image until the entire width of the program fits on your TV. Since the aspect ratio of the program is maintained, the image is no longer tall enough to fill your screen, so gray or black bars are seen at the top and bottom of the screen. To change the bar color, press MENU, select Settings & Help, Settings, and then Video. Arrow right and down to the Bar Color field, then scroll through the color options to select your desired bar color. See your TV's owner's manual for information on the best color for your set.

**Stretch:** In the Stretch setting, instead of adding bars to the top and bottom, the 16:9 program image is stretched vertically until it's tall enough to fill the screen. Your entire screen will be full, but the program images are stretched to compensate.

**Crop:** This format crops (cuts off) the left and right portions of the 16:9 frame so it fits the 4:3 screen.

If your display is a 4:3 format TV or monitor, your format options include these:

For 16:9 program signals:



Letterbox



Stretch



Crop

### 16:9 TVs Showing 4:3 Programs

For a wide screen 16:9 TV showing a standard 4:3 TV program, the program is too tall to fit the screen. Your choices here include:

**Pillar Box:** Here the 4:3 image is shrunk until the entire height of the program fits on your TV. Since the aspect ratio is maintained, the image is no longer wide enough to fill the screen, so gray or black bars are seen at the left and right edges. To change the bar color, press MENU, select Settings & Help, Settings, and then Video. Select the desired bar color option. See your TV's owner's manual for information on the best color for your set.

**Stretch:** In this setting, instead of adding bars to the sides, the 4:3 program image is stretched horizontally until it's wide enough to fill the screen. Your entire screen will be full, but the images are a little stretched to compensate.

**Crop:** This format crops (cuts off) the top and bottom of a 4:3 frame, keeping the 4:3 ratio intact.

If your display is a 16:9 format TV or monitor, your format options include these:

For 4:3 program signals:



Pillar Box

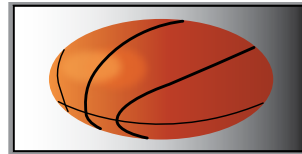

Stretch



Crop

# INDEX

## A

Access Card - 7, 8, 80, 88, 106, 108, 144, 156  
 Adult Channels - 92  
 Advance - 14, 74, 179, 180  
 Advanced Whole-Home HD DVR - 126  
 Album - 63  
 Apps - 44, 59, 60, 62, 68, 69, 76, 77, 78, 99, 145, 161  
 Artist - 63  
 Aspect Ratio - 82, 165, 168, 169  
 Audio Connections - 99, 153  
 Audio Options - 80, 84  
 Audio Sync - 114  
 Autorecord - 44, 55, 174  
 Auxiliary Equipment - 15, 146, 148

## B

Back Panel - 157, 158  
 Batteries - 7, 16, 111, 112, 113, 155

## C

Cables - 7, 70, 99, 103, 108, 109, 110, 114, 115, 119, 123, 127, 131, 146, 147, 152, 153, 158, 159, 160  
 Caller ID - 62, 99, 119, 158  
 Cast & Crew - 20  
 Channel Banner - 26, 27, 28, 29, 81  
 Clients - 3, 12, 70, 72, 74, 75, 100, 102

Clock - 83, 102  
 Closed Captioning - 26, 83  
 Component Video Out - 158  
 Component Video Output - 147  
 Connections - 46, 108, 109, 110, 118, 145, 146, 148, 149, 150, 151, 152, 153, 154, 159  
 Customer Care - 127, 132

## D

3D - 22, 147, 149, 150, 158  
 3D Channels - 22  
 Date & Time - 24, 60  
 Defaults - 57, 58, 88, 102  
 Deleting - 55  
 Digital Audio - 103, 148, 153, 158  
 DIRECTV Active Channel - 62, 99, 179  
 DIRECTV CINEMA - 122, 159, 175  
 DIRECTV Customer Care - 132  
 DIRECTV® DoublePlay™ - 66  
 DIRECTV Everywhere™ - 60  
 DIRECTV Mode - 111, 113  
 DIRECTV Protection Plan - 99, 129  
 DIRECTV® Ready TVs - 75, 98, 102  
 DIRECTV SUNDAY TICKET - 78  
 DIRECTV™ Mobile Apps - 76, 77, 78  
 DIRECTV™ Voice Search - 44, 78  
 DIRECTV® Whole-Home DVR Service - 70, 71, 73, 87  
 Disk Space Bar - 53

Display - 21, 80, 102  
 Dolby Digital - 84, 99  
 Download - 22, 35, 38, 55, 114, 133  
 DVD burner - 154  
 DVR control buttons - 14, 17, 50, 74

## E

Episodes - 36, 48, 51, 54, 58, 122, 174, 175  
 Erase - 38, 88  
 Error Message - 107, 120  
 Ethernet - 70, 158, 159, 160  
 Exit - 50, 65, 101, 179, 180  
 Extras - 30, 60, 62, 63, 119

## F

FAQs - 95, 109, 110, 111, 112, 113, 114, 115, 116, 117, 118, 119, 120, 121, 122, 123  
 Far in Advance - 43  
 Favorite Channels - 21, 24, 26, 27, 31, 94, 102  
 FCC Customer Information - 130, 131, 132  
 Filtering the Guide - 23  
 Folders - 51, 53  
 Front Panel - 8, 110, 111, 112, 113, 115, 118, 155, 156, 165, 174



## G

GameSearch™ - 67  
 Genie Clients - 42, 98, 103  
 Genie HD DVR - 98, 102  
 Genie Minis - 42, 75, 98, 102  
 Genie Recommends - 41  
 Genie Remote Control - 10, 11, 16, 85, 113  
 Guide - 20, 22, 81, 116, 156, 179, 180  
 channel types - 20, 21, 22  
 customize - 21, 28  
 customizing - 24  
 filtering - 23  
 guided setup - 144  
 jump to a date & time - 24

## H

HDMI - 103, 123, 147, 148, 149, 153, 154, 158, 167  
 Help - 12, 21, 24, 30, 31, 71, 72, 80, 89, 90, 94, 95, 102, 112, 115, 116, 160, 161, 164, 166, 168, 169  
 History - 30, 55, 57, 120  
 Home Page - 36

## I

Icons - 55, 174, 175  
 Info - 20, 26, 29, 35, 47, 48, 51, 73, 80, 81, 89, 90, 99, 179, 180

Interactive Channels - 22  
 Internet Connection - 145  
 Internet radio - 65  
 In Theaters - 34, 38, 39

## J

Just Added - 34

## K

Keep - 37, 53  
 Keyword Search - 55

## L

Language - 28, 81, 84, 91, 102  
 Live Buffer - 18  
 Live TV - 18, 46, 48, 50, 66, 67, 80, 94, 101, 120, 179  
 Local Channels - 21  
 Lock - 88

## M

Mail - 26  
 Manual Recordings - 57  
 Mark & Delete - 52  
 Media Server - 63, 101  
 Media Share - 63  
 Menu - 12, 30, 179, 180

Messages - 26, 62, 107  
 Mini Clients - 3, 12  
 Mini Guide - 25  
 Mobile Apps - 59, 76, 77, 78  
 Model Number - 126, 130  
 Mode Switch - 12, 85, 111, 113, 144, 179  
 Movies - 23, 24, 34, 35, 36, 37, 38, 39, 52, 60, 91, 145, 165  
 Movies Ratings - 91  
 Music & Photos - 62, 63  
 Mute - 115, 179  
 My Playlist - 51, 53, 54, 71, 119, 121, 122

## N

Network - 7, 63, 70, 78, 80, 100, 131, 132, 145, 159, 160, 161, 162, 164  
 New Movie Releases - 34  
 NFL SUNDAY TICKET - 68, 77

## O

On Demand - 24, 30, 35, 56, 99  
 Onscreen Messages - 107  
 Ordering Programs - 39  
 Other Ratings - 91

## P

Pandora - 62, 65  
 Parental Controls - 26, 31, 74, 88, 89, 90,

## INDEX

- 91, 92, 93, 174
  - adult channels - 92
  - channel blocks - 92
  - hours (viewing) - 93
  - passcode - 89, 90, 175
  - rating limits - 91
  - spending - 93
  - web videos - 92
  - Password - 88, 89, 162
  - Pay Per View - 34, 35, 36, 37, 38, 39, 40, 56, 57, 93, 122, 145, 158
  - Phone - 8, 35, 44, 60, 70, 76, 77, 78, 80, 108, 119, 127, 132, 145
  - Phone Connection - 108, 145
  - Picture In Picture - 29, 98, 99
  - Playlist - 30, 37, 38, 39, 51, 52, 54, 55, 71, 72, 74, 87, 119, 121, 122, 179, 180
  - change order - 52
  - filter - 53
  - managing - 53
  - mark and delete - 52
  - open/close all - 53
  - options - 52
  - sharing options - 71
  - sort - 52
  - Power - 3, 7, 12, 103, 106, 112, 113, 118, 130, 146, 156, 158, 179, 180
  - Power Outage - 117
  - Power Saving - 87
  - Power Surge - 117
  - Press and Hold Buttons - 179
  - Previous Channels - 27
  - Product Information - 8, 144
  - Program Guide - 13, 20, 21, 22, 23, 24, 25, 27, 34, 39, 46, 48, 58, 59, 81, 92, 114, 116, 121, 127, 144, 156, 179
  - Program Info - 26
  - Progress Bar - 17, 18, 114
  - Protection Plan - 10, 99, 103, 106
  - Purchases - 55, 57
- Q**
- Queue - 36, 37, 39, 55, 56, 175
  - QuickTune - 67
- R**
- RC71 Remote - 10, 14
  - RCA Connectors - 151, 152, 158
  - Rear Panel - 6, 157, 158
  - Reauthorize Your Receiver -
  - Recordings - 30, 36, 37, 39, 40, 46, 49, 51, 54, 55, 56, 57, 58, 59, 73, 74, 75, 78, 88, 92, 118, 120, 122
  - a series - 48
  - a single show - 46
  - changing a record option - 46, 48
  - defaults - 57
  - from a computer - 59
  - from a phone or tablet - 60
  - from Live TV - 48
  - from the guide - 48
  - history - 57
  - managing - 56, 57, 58
  - manually - 57
  - purchases - 57
  - remote - 60
  - stopping an in-progress - 49
  - watching and deleting - 50
  - Remote Control - 7, 10, 11, 12, 13, 14, 15, 16, 67, 74, 80, 85, 86, 111, 112, 116, 118, 144, 155, 156, 158, 175
  - advanced setups - 86
  - buttons - 10, 12, 14, 16, 17, 179
  - IR/RF setup - 85
  - modes - 12
  - problems - 111
  - program remote - 85
  - receiver mode - 86
  - Remote Recording - 59, 60
  - Repair - 127, 128
  - Reset - 83, 88, 106, 109, 113, 115, 117, 144
  - Resolution - 28, 80, 81, 82, 83, 110, 111, 115, 123, 156, 165, 166, 167
  - Resolution Indicator - 156
  - Restart - 88
  - RF Remote - 85
  - RVU - 101

## S

Satellite - 3, 7, 46, 86, 108, 109, 114, 116, 130, 132, 144, 158  
 Satellite Data Acquisition - 114  
 Satellite Signal Strength - 86  
 Scheduler - 174  
 ScoreGuide™ - 68, 180  
 Search & Browse - 30  
 Serial Number - 8  
 Series - 35, 40, 41, 43, 47, 48, 49, 51, 53, 54, 55, 56, 58, 60, 119  
 Series Manager - 55, 56, 58, 120  
 Settings - 10, 11, 31, 57, 80, 81, 84, 85, 86, 87, 88, 102, 160, 161  
 Setup - 80  
 Showroom - 65  
 Smart Search - 30, 43  
 Software - 22, 80, 107, 127, 133, 134, 135, 136, 138, 139, 140, 141  
 Song - 63  
 Sort - 24, 52  
 Sort Programs by Category - 52  
 Sound Effects - 84, 102  
 Spending Limits - 93  
 Sports - 22, 40, 52, 65, 67, 77  
 Surround Sound - 3, 12, 84, 85, 114, 115, 146, 148  
 S-Video - 123, 147, 151, 154, 167  
 System Info - 80, 116

System Messages - 26, 62, 107  
 System Software Updates - 107  
 System Test - 80, 106, 108

## T

Tablet - 59, 60, 76, 78  
 Temporarily Unlock - 90  
 Terms & Conditions for Use of Software - 133, 134, 135, 136, 137, 138, 139, 140, 141, 142  
 Tickmark - 14  
 To Do List - 48, 55, 74, 118, 122  
 Troubleshooting - 80, 106, 107, 108  
 TV Apps - 68, 99  
 NFL.COM Fantasy Football TV App - 68  
 ScoreGuide™ - 68  
 Weather - 68  
 What's Hot - 68  
 TV Problems - 110, 113, 114, 115, 118  
 TV Ratings - 91  
 TV Shows - 34, 41, 42

## U

Universal Remote Control - 10, 12, 111  
 Unlock - 90  
 Unsubscribed Channels - 21

## T

VCR - 85, 110, 158, 179  
 Video - 80, 81, 92, 106, 110, 114, 118, 158, 166, 167  
 Voice Search - 44, 78



















## W

Warranty - 8, 126, 127, 128, 129  
 Weather - 68  
 Web Videos - 92  
 What's Hot - 68  
 What's On Now? - 34  
 Whole-Home DVR service - 70, 71, 72, 73  
 Wired Connection - 159, 160

## Y

You Might Like - 21

## ICON REFERENCE

Arrow Icons		Indicate that a show's start or end time is earlier or later than is visible in the Guide program cell.
		LEFT and RIGHT arrows on the remote offer special functionality.
		Objects are scrollable above or below the visible window.
		UP and DOWN arrows on the Receiver front panel offer special functionality.
Other Icons		Indicates a program is set to record.
		Indicates record has been set for all episodes of an ongoing program.
		Indicates showing that was set by the user conflicts with another showing.
		Indicates showing that was set by the user was canceled by the scheduler due to an unexpected conflict.
		Shows Autorecord has been set for matching programs in a Search.
		Indicates a recorded or live-stored video is fast forwarding at normal speed.
		Indicated a recorded or live-stored video is rewinding at normal speed.
		Indicates current video is paused.
		This key plays current video when paused; it displays the control bar when already playing.
		Indicates one or more new messages are in the Inbox.
		Shows that Parental Control limits are currently "locked".
		Shows that limits are temporarily unlocked.
		Shows that there are no current limits imposed.
	Indicates a rating level or channel that is blocked via Parental Controls.	
	All Day Ticket indicates that the program is rented for 24 hours starting when you first view the program.	

## Other Icons



ENTER



Screen hints indicating a special function, activated by pressing the related button on the remote control.

LB

Indicates program shown in letterbox format.



Denotes an error condition has occurred.



Appears when at least one rating or channel is allowed.



Appears when at least one rating or channel is blocked.



Used to create/enter passcodes in Parental Controls.



Indicates the scheduled PPV is set to purchase.



Program is currently downloading.

HD

Indicates the program is/will be broadcast in High-Definition format.



Indicates program is ready to watch.



Indicates a Program is in the Queue.



All episodes of an ongoing programs are in the Queue.



Indicates a program is about to expire

VOD

Indicates that the programs comes from DIRECTV CINEMA.



Indicates a recorded program is not available for viewing.

## NOTES



ACTIVATION OF PROGRAMMING SUBJECT TO CREDIT APPROVAL. CREDIT CARD REQUIRED (except in MA and PA). Programming subject to change. DIRECTV services not available outside the U.S. DIRECTV programming is available separately and independently of DIRECTV System hardware. A valid programming subscription is required to operate DIRECTV System hardware. Activate your DIRECTV programming today at 1.800.531.5000. ©2013 DIRECTV. DIRECTV and the Cyclone Design logo, DIRECTV Active, DIRECTV INTERACTIVE, DIRECTV PLUS, GENIE, HomePlug and the DIRECTV Plus DVR and DIRECTV HD DVR logos are trademarks of DIRECTV. All other trademarks and service marks are the property of their respective owners.

This item incorporates copy protection technology that is protected by U.S. patents and other intellectual property rights of Rovi Corporation. Reverse engineering and disassembly are prohibited.

Due to restrictions imposed by copyright holders, certain programming may include content protection measures that may restrict viewing in high-definition and/or recording with certain consumer electronics equipment attached to the Receiver. Please contact the manufacturer of such equipment for additional information.

THIS PRODUCT IS LICENSED UNDER THE AVC PATENT PORTFOLIO LICENSE FOR THE PERSONAL AND NON-COMMERCIAL USE OF A CONSUMER TO (i) ENCODE VIDEO IN COMPLIANCE WITH THE AVC STANDARD (“AVC VIDEO”) AND/OR (ii) DECODE AVC VIDEO THAT WAS ENCODED BY A CONSUMER ENGAGED IN A PERSONAL AND NON-COMMERCIAL ACTIVITY AND/OR WAS OBTAINED FROM A VIDEO PROVIDER LICENSED TO PROVIDE AVC VIDEO. NO LICENSE IS GRANTED OR SHALL BE IMPLIED FOR ANY OTHER USE. ADDITIONAL INFORMATION MAY BE OBTAINED FROM MPEG LA, L.L.C. SEE [HTTP://WWW.MPEGLA.COM](http://www.mpegla.com)

V1.6GENIEHR44HR34HR2X04MAR2016



## MODE SWITCH

Changes remote to control other equipment, for example a DVD Player.

## TV INPUT

Changes the "source" - the piece of equipment whose signal is displayed on your TV.

## FORMAT

Cycles through screen formats (loop, stretch, pillar box, letter box) and resolutions.

## STOP\*

Stops Recorded Video

## REPLAY\*

Jumps back 6 seconds. Hold down to jump back to the beginning.

## REWIND\*

Press up to four times to rewind at increasing speed.

## PAUSE\*

Pauses current video.

## ACTIVE

Displays the DIRECTV Active Channel - local weather and more!

## GUIDE

Press once to see the Program Guide. Press twice to see programs by category.

## SELECT

Selects any highlighted item.

## BACK

Takes you back one menu screen.

## MENU

Display a menu of settings and services.

## RED

In Guide, jumps 12 hours back; other functions vary - look for hint onscreen.

## GREEN

In Guide, jumps 12 hours forward; function varies on other screens - look for onscreen hints.

## VOLUME

Raises or lowers volume.

## MUTE

Toggles sound volume on/off.

## NUMBERS & DASH

Tune to a channel directly - also input numbers when needed in onscreen menus.

## DIRECTV & TV POWER ON

Turns your DIRECTV® Receiver and TV together, on or off.

## POWER

Turns on/off whichever equipment the MODE switch is set to.

## ADVANCE\*

Jumps ahead 30 seconds. Hold down to jump forward to the end.

## PLAY\*

Play current video; press and hold for slow motion.

## FFWD\*

Press up to four times to fast forward at increasing speeds.

## RECORD\*

Press once to record a live TV program, or the program highlighted in the Program Guide. Press twice to record a series.

## LIST

Displays the Playlist.

## EXIT

Exits any menu and returns to last channel viewed.

## ARROWS

Moves the highlight (up, down, left, right) within a menu.

## INFO

Displays information about the program you are watching or that is highlighted in the Program Guide.

## BLUE

In the TV, displays the Kim Guide; function varies on other screens - look for onscreen hints.

## YELLOW

Displays various options while viewing the Guide or the Playlist.

## CHAN/PAGE

In live TV, changes channel up or down; in a menu, such as the Guide, scrolls page up and down.

## PREV

Tunes to previous channel viewed.

## ENTER

Activates channel number entries quickly.



Keys in orange text can be programmed to function with your VCR, DVD player or other stand alone equipment.

\* These descriptions apply to DIRECTV HD DVRs. Other equipment may behave differently.

**ON/OFF**  
Turns both DIRECTV® Receiver and TV ON or OFF at the same time. (Remote must be programmed for TV. DVR Receiver still records when off).

**GUIDE**  
Press once for On-Screen Guide. Press twice for programming grouped into categories.

**RECORD**  
RECORD program now playing or highlighted in the On-Screen Guide. Press twice to record the entire series.

**RED CIRCLE BUTTON**  
Jump back 12 hours while viewing the On-Screen Guide. Access ScoreGuide™ while viewing any sports channel.

**VOL**  
Increase or decrease the VOLUME level.

**MUTE**  
MUTE the sound.

**REPLAY**  
REPLAY previous six seconds. Press and hold to jump back to the beginning of a recorded program.

**REWIND**  
REWIND at increasing speeds – press up to four times. Press and hold to jump to previous tick mark. Jump back 12 hours while viewing the On-Screen Guide..

**PLAY/PAUSE**  
PLAY current program. Press once while program is playing to PAUSE. Press and hold while program is playing for slow motion.

**DASH**  
Press for Guide Options while viewing On-Screen Guide. Press twice to delete recorded shows from your playlist.  
Press to display last 6 digits of Receiver ID. Satellite signal type (SYM or Multiswitch) and Invert status.

**MENU**  
Display the MENU.

**LIST**  
Display the LIST of your recorded programs.

**ARROWS**  
Press ▲ to move up within a menu.  
Press ▼ to move down within a menu.  
Press ► to move right within a menu.  
Press ◀ to move left within a menu.  
Press ◀▶ to go back within menus.

**EXIT**  
EXIT the menu and return to previous channel viewed. Stop playback while viewing recorded content.

**SELECT**  
SELECT Item highlighted on-screen.  
**INFO**  
Display INFORMATION about the program now playing or highlighted in the On-Screen Guide.

**CH**  
Change TV CHANNELS.  
Scroll a full page while viewing the On-Screen Guide.

**PREV**  
Return to PREVIOUS channel viewed.

**ADVANCE**  
ADVANCE 30 seconds.  
Press and hold to jump ahead to the end of a recorded program.

**FAST-FORWARD**  
FAST-FORWARD at increasing speeds – press up to four times. Press and hold to jump to next tick mark. Jump ahead 12 hours while viewing the On-Screen Guide.

**ENTER**  
Press for Menu Guide while viewing your program and dismiss with EXIT.  
ENTER also replaces TV INPUT buttons: To cycle through the equipment connected to your TV, press and hold for three seconds until LED light at top turns green. Then scroll through inputs by pressing ENTER again.



V1.5GENIEHR2X04/MAR2016