

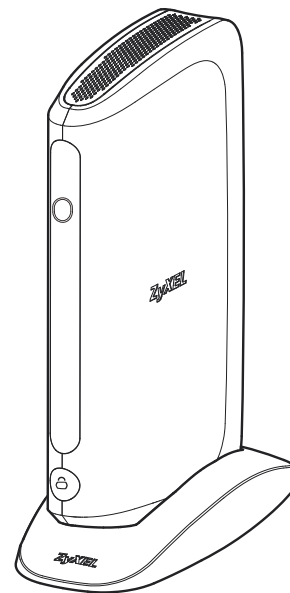

ARMOR X1 (WAP6806)

Dual-Band Wireless AC2100 Access Point

Version 1.00
Edition 1, 12/2015



User's Guide

Default Login Details

Web Address	http://zyxelsetup http://192.168.1.2
Password	1234

IMPORTANT!

READ CAREFULLY BEFORE USE.

KEEP THIS GUIDE FOR FUTURE REFERENCE.

Related Documentation

- Quick Start Guide

The Quick Start Guide shows how to connect the WAP6806 and access the Web Configurator wizards. (See the wizard real time help for information on configuring each screen.) It also contains a connection diagram and package contents list.

Contents Overview

User's Guide	8
Introduction	9
WAP6806 Modes	15
Repeater Mode	17
Access Point Mode	23
Client Mode	27
The Web Configurator	30
Connection Wizard	33
Status	44
Technical Reference	48
Monitor	49
Operation Mode	52
Ethernet	60
Wireless LAN	62
Management	74
Maintenance	76
Troubleshooting	83

Table of Contents

Contents Overview	3
Table of Contents	4
Part I: User's Guide	8
Chapter 1	
Introduction.....	9
1.1 Overview	9
1.2 Securing the WAP6806	10
1.3 Panel Views	10
1.4 WPS Button	12
1.4.1 Wi-Fi Protected Setup	12
1.5 Reset Button	12
1.5.1 Procedure to Use the Reset Button	12
1.6 2-way Installation	13
1.6.1 Stand	13
1.6.2 Wall Mounting	13
Chapter 2	
WAP6806 Modes	15
2.1 Overview	15
2.1.1 Device Modes	15
Chapter 3	
Repeater Mode	17
3.1 Overview	17
3.2 What You Can Do	17
3.3 What You Need to Know	18
3.3.1 Setting your WAP6806 to Repeater Mode	18
3.4 Repeater Mode Status Screen	18
3.5 WPS Screen	20
Chapter 4	
Access Point Mode.....	23
4.1 Overview	23
4.2 What You Can Do	23
4.3 What You Need to Know	23

4.3.1 Setting your WAP6806 to AP Mode	24
4.3.2 Configuring your WLAN, LAN and Maintenance Settings	24
4.4 AP Mode Status Screen	24
Chapter 5	
Client Mode	27
5.1 Overview	27
5.2 What You Can Do	27
5.3 What You Need to Know	27
5.4 Setting your WAP6806 to Client Mode	28
5.5 Client Mode Status Screen	28
Chapter 6	
The Web Configurator	30
6.1 Overview	30
6.2 Accessing the Web Configurator	30
6.2.1 Login Screen	30
6.2.2 Password Screen	31
6.3 Resetting the WAP6806	32
Chapter 7	
Connection Wizard	33
7.1 Overview	33
7.2 Using the Web Configurator Wizard	33
7.3 Configuring the WAP6806 to AP Mode	33
7.4 Configuring the WAP6806 to Client Mode	35
7.5 Configuring the WAP6806 to Repeater Mode	38
Chapter 8	
Status	44
8.1 WAP6806 Status	44
8.2 Navigation Panel	46
Part II: Technical Reference.....	48
Chapter 9	
Monitor.....	49
9.1 Overview	49
9.2 What You Can Do	49
9.3 System Log	49
9.4 Statistics	50

9.5 WLAN Station Status	51
Chapter 10	
Operation Mode	52
10.1 Overview	52
10.2 What You Can Do	52
10.3 Operation Mode Setup	52
10.3.1 Client Mode Setup	53
10.3.2 Repeater Mode Setup	53
10.4 AP Connection	55
10.4.1 WEP Encryption	57
10.4.2 WPA-Personal / WPA2-Personal / WPA/WPA2-Personal Mixed	58
Chapter 11	
Ethernet	60
11.1 Overview	60
11.2 What You Can Do	60
11.3 LAN Setup Screen	60
11.4 IP Alias Screen	61
Chapter 12	
Wireless LAN.....	62
12.1 Overview	62
12.2 What You Can Do	62
12.3 What You Should Know	62
12.3.1 Wireless Security Overview	62
12.4 General Wireless LAN Screen	63
12.5 Wireless LAN Advanced Screen	65
12.6 Security	66
12.7 WPS Screen	69
12.7.1 Connecting to a Wireless Network Using WPS	70
Chapter 13	
Management.....	74
13.1 Overview	74
13.2 What You Can Do	74
13.3 MCL Screen	74
13.4 One Connect Screen	75
Chapter 14	
Maintenance	76
14.1 Overview	76
14.2 What You Can Do	76

14.3 System	76
14.3.1 General Screen	76
14.3.2 Time Setting Screen	77
14.4 Firmware Upgrade Screen	78
14.5 Backup / Restore Screen	80
14.5.1 Export Setting	81
14.5.2 Import Setting	81
14.5.3 Restore to Factory Defaults	82
14.6 Reboot	82
Chapter 15	
Troubleshooting.....	83
15.1 Power, Hardware Connections, and LED	83
15.2 WAP6806 Access and Login	84
15.3 Internet Access	85
15.4 Resetting the WAP6806 to Its Factory Defaults	86
15.5 Wireless Problems	86
Appendix A Customer Support	88
Appendix B Setting Up Your Computer's IP Address	94
Appendix C Legal Information	122
Index	131

PART I

User's Guide

Introduction

1.1 Overview

The ZyXEL WAP6806 Dual-Band Wireless AC2100 Access Point makes it fast and easy to easily extend existing IEEE 802.11 b/g/n/ac wireless networks. Simply plug the WAP6806 directly into a power outlet and the LED signal strength indicator allows you to determine the ideal installation location. The one-click Wi-Fi Protected Setup ([WPS Button on page 12](#)) provides frustration-free wireless client setup and completes the instant network access setup.

Figure 1 Universal Repeater

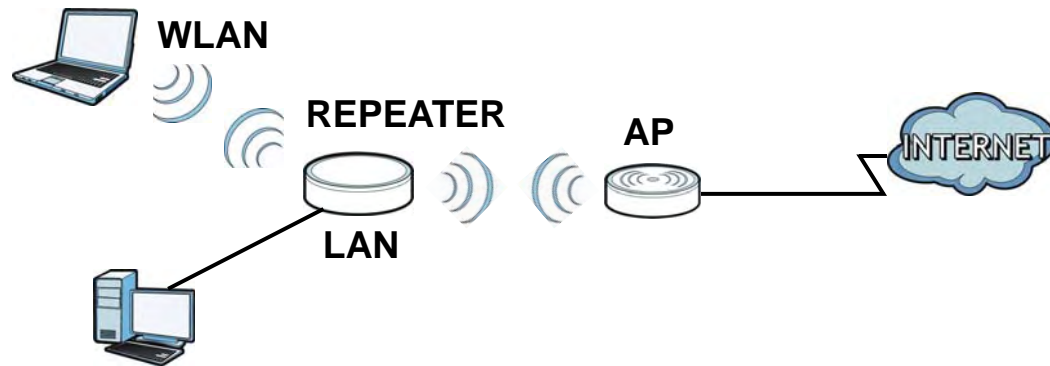

You can create the following connections using the WAP6806:

- **LAN.** You can connect network devices via the Ethernet port of the WAP6806 so that they can communicate with each other and access the Internet.
- **WLAN.** Wireless clients can connect to the WAP6806 to access network resources.

Use a (supported) web browser to manage the WAP6806.



See [Chapter 8 on page 44](#) for more information.

1.2 Securing the WAP6806

Do the following things regularly to make the WAP6806 more secure and to manage the WAP6806 more effectively.

- Change the password. Use a password that's not easy to guess and that consists of different types of characters, such as numbers and letters.
- Write down the password and put it in a safe place.
- Back up the configuration (and make sure you know how to restore it). Restoring an earlier working configuration may be useful if the device becomes unstable or even crashes. If you forget your password, you will have to reset the WAP6806 to its factory default settings. If you backed up an earlier configuration file, you would not have to totally re-configure the WAP6806. You could simply restore your last configuration.

1.3 Panel Views

Figure 2 Panel Views

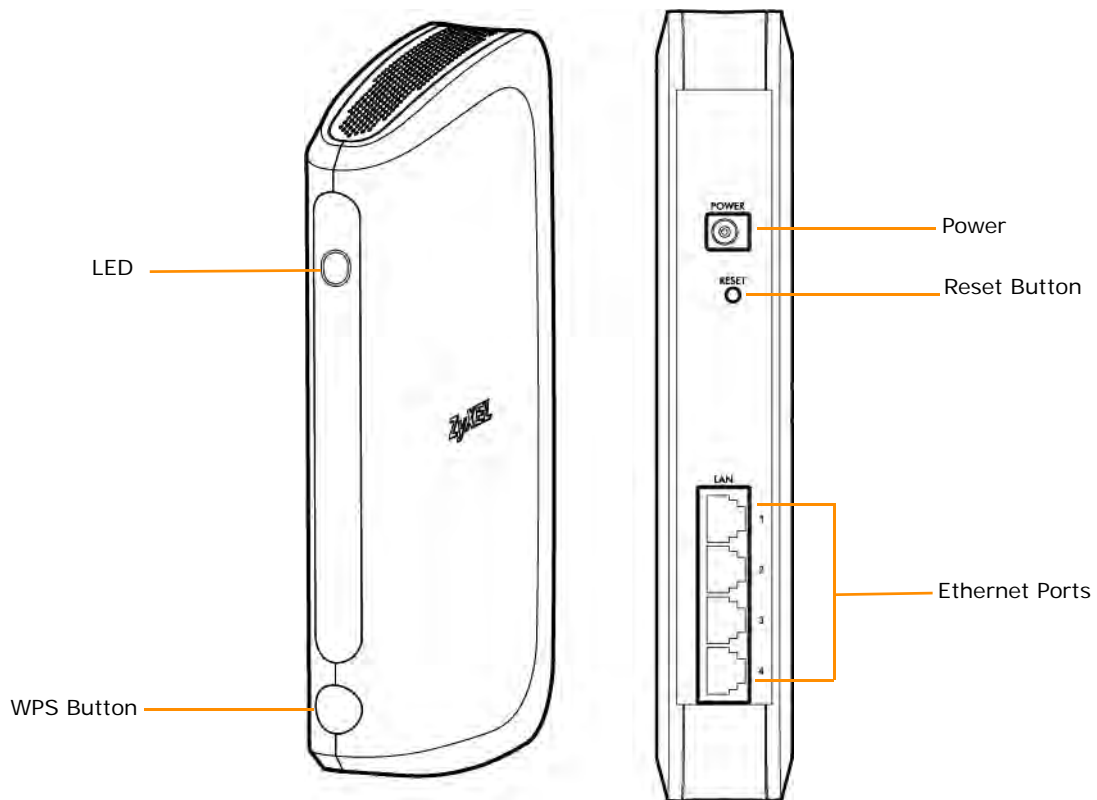

The following table describes the LED status.

Table 1 WAP6806 LED Status

FUNCTION	STATUS	DESCRIPTION
Power	On (Green)	The WAP6806 is receiving power and functioning properly.
	Blinking (Green)	The WAP6806 is booting.
	Off	The WAP6806 is not receiving power.
Connection Status		The device uses the LED to generate the following three signal colors: <ul style="list-style-type: none"> Red: signifies a signal strength under 50% Orange: signifies a signal strength under 75% Green: signifies a signal strength over 75%
System	Blinking (Red)	The WAP6806 has an error.
	Blinking (all colors)	The WAP6806 is resetting to the factory default or upgrading the firmware.
WPS	Blinking (Amber)	The WAP6806's WPS function is in progress.

The following table describes the LED combination status of 2.4G and 5G for dual uplink in repeater mode.

Table 2 LED Combination Status of 2.4G and 5G

COMBINATION	BAND	EXCELLENT (100% ~ 70%)	GOOD (69% ~ 51%)	POOR (50% ~ 0%)	RESULT
1	2.4G	Green			Green
	5G	Green			
2	2.4G	Green			Green
	5G		Amber		
3	2.4G		Amber		Green
	5G	Green			
4	2.4G	Green			Amber
	5G			Red	
5	2.4G		Amber		Amber
	5G		Amber		
6	2.4G		Amber		Amber
	5G			Red	
7	2.4G			Red	Amber
	5G		Amber		
8	2.4G			Red	Amber
	5G	Green			
9	2.4G			Red	Red
	5G			Red	

1.4 WPS Button

The WPS button can be used to configure 2.4G and 5G settings.

Table 3 WPS Button Functions

ACTION	RESULT
Client Mode	
Push once for less than 5 seconds	The WAP6806 triggers uplink WPS.
AP Mode	
Push once for less than 5 seconds	The WAP6806 triggers both 2.4G and 5G primary Service Set Identity (SSID) at the same time.
Repeater Mode	
Push once for less than 5 seconds	The WAP6806 triggers uplink WPS.
Push twice for less than 5 seconds	The WAP6806 triggers downlink WPS.

1.4.1 Wi-Fi Protected Setup

Your WAP6806 supports Wi-Fi Protected Setup (WPS), which is an easy way to set up a secure wireless network. WPS is an industry standard specification, defined by the Wi-Fi Alliance.

WPS allows you to quickly set up a wireless network with strong security, without having to configure security settings manually. Each WPS connection works between two devices. Both devices must support WPS (check each device's documentation to make sure).

Depending on the devices you have, you can either press a button (recommended) on the device itself, or in its configuration utility or enter a PIN (a unique Personal Identification Number that allows one device to authenticate the other) in each of the two devices. When WPS is activated on a device, it has two minutes to find another device that also has WPS activated. Then, the two devices connect and set up a secure network by themselves.

For more information on using WPS, see [Section 12.7 on page 69](#).

1.5 Reset Button

If you forget your password or IP address, or you cannot access the Web Configurator, you will need to use the **RESET** button at the back of the WAP6806 to reload the factory-default configuration file. This means that you will lose all configurations that you had previously saved, the password will be reset to "1234" and the IP address of the WAP6806 will be reset to "192.168.1.2".

1.5.1 Procedure to Use the Reset Button

- 1 Make sure the power LED is on.
- 2 Press the **RESET** button for one to five seconds to reboot the WAP6806.

- 3 Press the **RESET** button for longer than five seconds to set the WAP6806 back to its factory-default configuration.

1.6 2-way Installation

The WAP6806 can be used for 2-way installation: vertical and wall mounted.

1.6.1 Stand

To have your WAP6806 as a stand-alone device, put you WAP6806 vertically into the stand as shown below.

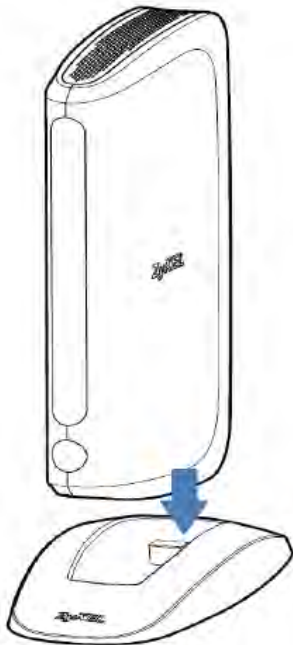

1.6.2 Wall Mounting

The following are the dimensions of a screw anchor and M3 tap screw used for wall mounting. All measurements are in millimeters (mm).

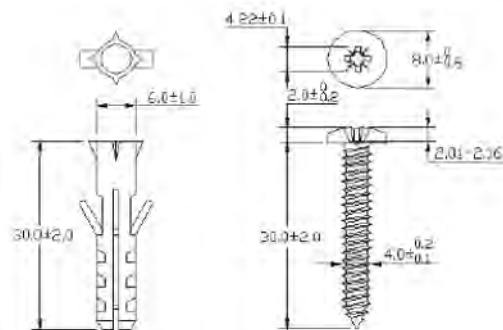

- 1 Locate a high position on a wall that is free of obstructions. Use a sturdy wall.
- 2 For a concrete or brick wall find a drill bit with the same diameter as the screw anchors. If you do not need the screw anchors, find a drill bit slightly smaller in diameter than the included screws.
- 3 Drill two screw holes in the wall. Make sure the distance between the centers of the holes is the same as the wall-mount holes.

Note: Be careful to avoid damaging pipes or cables located inside the wall when drilling holes for the screws.

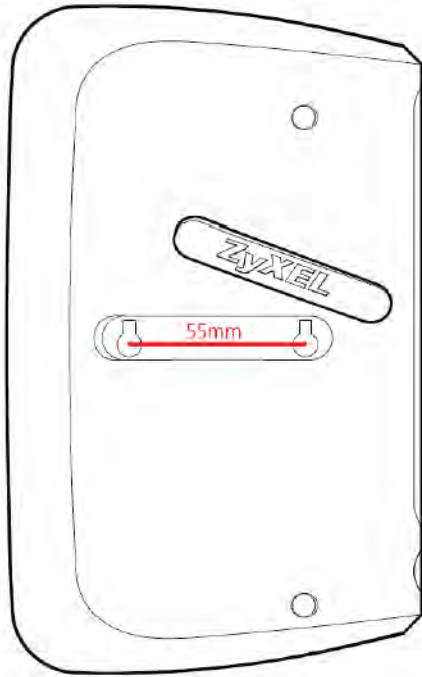

- 4 Align the holes on the back of the WAP6806 with the screws on the wall. Hang the WAP6806 on the screws.

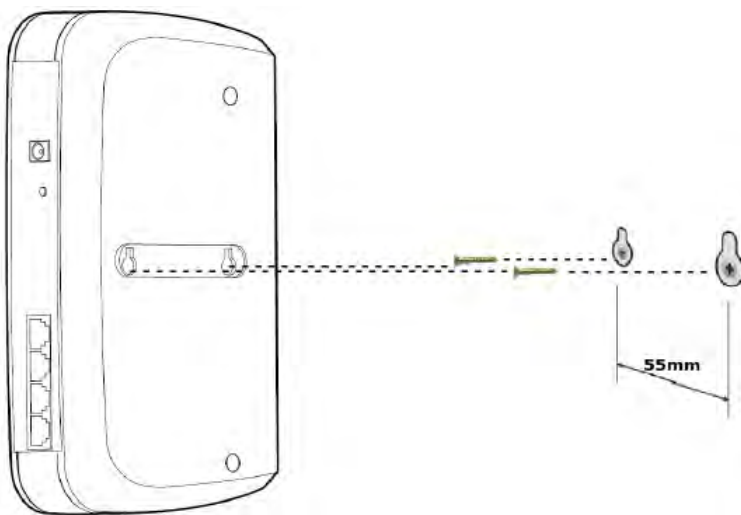

WAP6806 Modes

2.1 Overview

This chapter introduces the different modes available on your WAP6806.

- **Device mode.** This is the operating mode of your WAP6806, or simply how the WAP6806 is being used in the network.

2.1.1 Device Modes

This refers to the operating mode of the WAP6806, which can act as a:

- **Repeater:** In this mode, the WAP6806 can be an access point and a wireless client at the same time. Go to [Section 3.4 on page 18](#) to view the **Status** screen in this mode. Use this mode if there is an existing wireless router or access point in your network and you also want to allow clients to connect to the WAP6806 wirelessly.
- **Access Point:** Use this mode if you want to extend your network by allowing network devices to connect to the WAP6806 wirelessly. Go to [Section 4.4 on page 24](#) to view the **Status** screen in this mode.
- **Client:** Use this mode if there is an existing wireless router or access point in the network to which you want to connect your local network. Go to [Section 5.5 on page 28](#) to view the **Status** screen in this mode. In Client mode, you should know the SSID and wireless security details of the access point to which you want to connect.

The following figure illustrates the device configuration modes of the WAP6806.

Figure 3 Device Mode Example

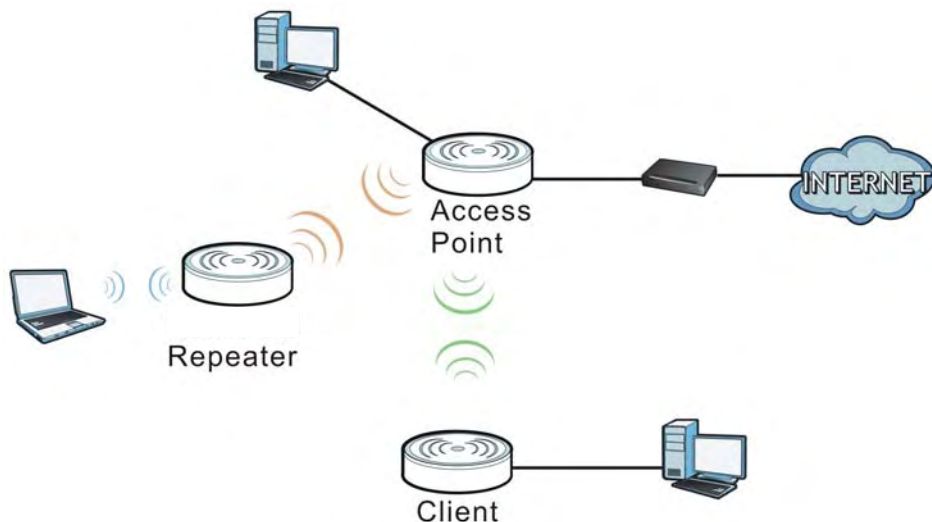

Note: Choose your device mode carefully to avoid having to change it later.

Under Repeater mode, the WAP6806 supports three WPS behaviors: Normal mode, Range boost mode, and Speed boost mode. These behaviors are only available in Repeater mode through the **Operation Mode** screen. See [Section 10.3.2 on page 53](#) for details.

Repeater Mode

3.1 Overview

In repeater mode, your WAP6806 can act as an access point and wireless client at the same time. The WAP6806 can connect to an existing network through another access point and also lets wireless clients connect to the network through it. This helps you expand wireless coverage when you have an access point or wireless router already in your network.

In the example below, the WAP6806 (**A**) is configured as a repeater. It has three clients that want to connect to the Internet. The WAP6806 wirelessly connects to the available access point (**B**).

Figure 4 Repeater Mode

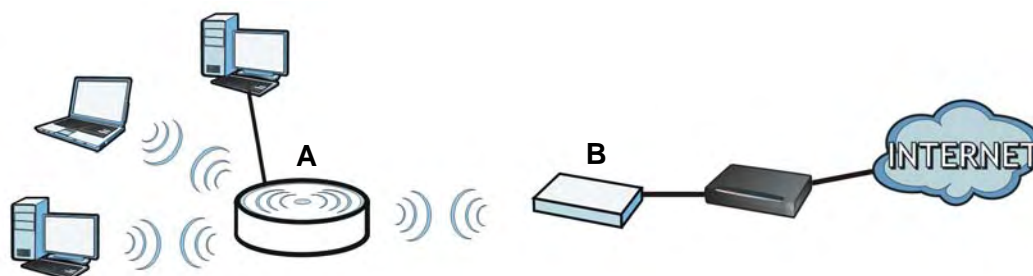

After the WAP6806 and the access point connect, the WAP6806 acquires its IP address from the access point. The clients of the WAP6806 can now surf the Internet.

3.2 What You Can Do

- Use the **Status** screen ([Section 3.4 on page 18](#)) to view read-only information about your WAP6806.
- Use the **Ethernet > IP Alias** screen ([Section 11.4 on page 61](#)) to set the IP address for your WAP6806.
- Use the **Wireless LAN > WPS** screen ([Section 12.7 on page 69](#)) to configure WPS on the WAP6806 to associate to another access point.
- Use the **Network > Wireless LAN (2.4G/5G) > Security** screen ([Section 12.6 on page 66](#)) to configure the wireless security between the WAP6806 and another access point.
- Use other **Wireless LAN** screens ([Section 12.5 on page 65](#)) to configure the wireless settings between the wireless clients and the WAP6806.

3.3 What You Need to Know

With the exception of the **Operation Mode** other configuration screens in the Repeater mode are similar to the ones in Access Point Mode. See [Chapter 2 on page 15](#) of this User's Guide.

3.3.1 Setting your WAP6806 to Repeater Mode

- 1 To use your WAP6806 as a repeater, see [Section 2.1.1 on page 15](#).
- 2 Connect your computer to the LAN port of the WAP6806.
- 3 Open a web browser such as Internet Explorer and type `http://zyxelsetup` or `http://192.168.1.2` as the web address in your web browser.
- 4 Enter "1234" (default) as the password and click **Login**.
- 5 Type a new password and retype it to confirm, then click **Change**. Otherwise, click **Skip**. See [Section 7.5 on page 38](#) for details.

Note: You have to log in to the Web Configurator again when you change modes. As soon as you do, your WAP6806 is already in Repeater mode.

Note: If a client is connected to the WAP6806 through the wired Ethernet connection, the client can only directly access the 5 GHz Wi-Fi. In the following figure, the LAN Client is only able to directly communicate with devices in the 5 GHz wireless network.

Figure 5 Repeater Mode Overview

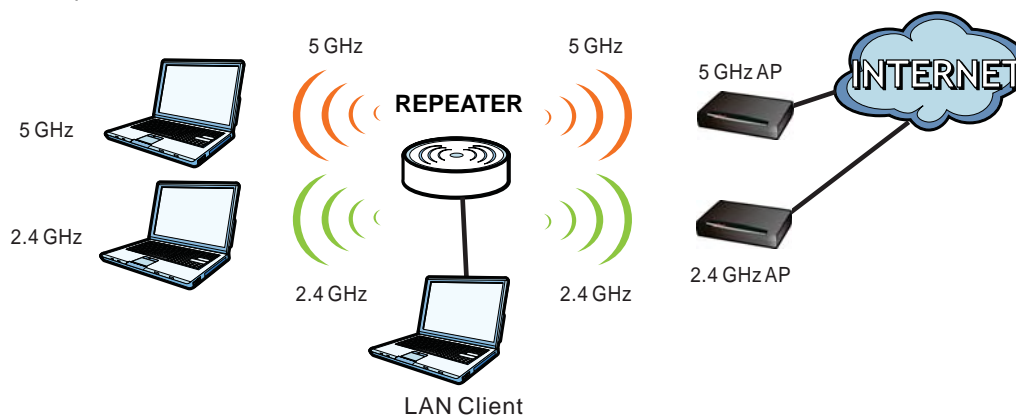

3.4 Repeater Mode Status Screen

Click  to open the **Status** screen.

Figure 6 Status: Repeater Mode

The screenshot shows the 'Status' page for a WAP6806 device in Repeater Mode. The page includes a 'Refresh Interval' dropdown set to 'NONE' and a 'Refresh' button. The information is organized into several sections:

- System Information:** Host Name: WAP6806, System Mode: Repeater Mode, Hardware Version: A0B, Firmware Version: 1.00(ABAL.0)C0, System Up Time: 4 days: 2 hours: 53 minutes, Current Date/Time: 1970-Jan-04/18:56:53.
- Ethernet Information:** MAC Address: 58:8B:F3:02:D4:9B, IP Address: 169.254.71.254, Subnet Mask: 255.255.0.0, Encapsulation mode: IP over Ethernet (IPv6), Gateway: 0.0.0.0, DNS Server: 192.168.1.2, IP Alias: 255.255.0.0.
- AP Connection Status - 2.4G:** MAC Address: 52:60:F0:37:FF:3D, SSID: Unizyx_GUEST, Channel: 1, Security: NONE, Status: Connected.
- AP Connection Status - 5G:** MAC Address: N/A, SSID: N/A, Channel: N/A, Security: N/A, Status: Disconnected.
- Wireless Network Information - 2.4 GHz:** MAC Address: 5A:8B:F3:80:D5:98, Wireless Network: Enable, SSID: ZyXEL02D49B, Link rate: 300 Mbps, Current Channel: 1, Authentication: WPA2-Personal, Mode: 802.11b/g/n Mixed, WPS Status: Configured.
- Wireless Network Information - 5.0 GHz:** MAC Address: N/A, Wireless Network: Enable, SSID: N/A, Link rate: 1733.2 Mbps, Current Channel: 44, Authentication: OPEN, Mode: 802.11a/n/ac Mixed, WPS Status: Configured.

The following table describes the labels shown in the **Status** screen.

Table 4 Status Screen: Repeater Mode

LABEL	DESCRIPTION
System Information	
Host Name	This is the WAP6806's model name.
System Mode	This is the device mode (Section 2.1.1 on page 15) to which the WAP6806 is set - Repeater Mode .
Hardware Version	This displays the hardware version of the device.
Firmware Version	This displays the firmware version and the date created.
System Up Time	This displays the total time the WAP6806 has been on.
Current Date/Time	This displays the WAP6806's present date and time.
Ethernet Information	
MAC Address	This shows the LAN Ethernet adapter MAC Address of your device.
IP Address	This shows the LAN port's IP address.
IP Subnet Mask	This shows the LAN port's subnet mask.
Encapsulation mode	This shows the protocol for encapsulating packages the WAP6806 uses.
Gateway	This shows the gateway of the WAP6806.
DNS Server	This shows the IP address of the DNS Server.

Table 4 Status Screen: Repeater Mode (continued)

LABEL	DESCRIPTION
IP Alias	This shows the IP address of the WAP6806.
Subnet Mask	This shows the subnet mask of the WAP6806.
AP Connection Status - 2.4G / 5G	
MAC Address	This shows the wireless adapter MAC Address of the root AP.
SSID	This shows a descriptive name used to identify the root AP in the wireless LAN.
Channel	This shows the channel number which you select manually or the root AP automatically scans and selects.
Security	This shows the level of wireless security the root AP is using.
Status	This shows the current status of the Wireless LAN.
Wireless Network Information - 2.4G / 5G	
MAC Address	This shows the wireless adapter MAC Address of your WAP6806.
Wireless Network	This shows whether the wireless LAN function is enabled or disabled.
SSID	This shows a descriptive name used to identify the WAP6806 in the wireless LAN.
Link Rate	This shows the data transfer rate of the wireless network.
Current Channel	This shows the channel number which you select manually or the WAP6806 automatically scans and selects.
Authentication	This shows the wireless security mode used to protect the information that is sent in the wireless network.
Mode	This shows which IEEE 802.11b/g/n wireless networking standards the wireless device supports.
WPS Status	This shows the current status of the WPS.

3.5 WPS Screen

Use this screen to connect to another AP. Go to **Configuration > Network > Wireless LAN (2.4G/5G) > WPS** to open the following screen.

Note: Wireless clients cannot use WPS to set up a wireless network with the WAP6806 in repeater mode.

Figure 7 Repeater: Configuration > Network > Wireless LAN (2.4G/5G) > WPS

Figure 8 AP: Configuration > Network > Wireless LAN (2.4G/5G) > WPS

The following table describes the labels in this screen.

Table 5 Repeater: Configuration > Network > Wireless LAN (2.4G / 5G) > WPS

LABEL	DESCRIPTION
WPS Setup	
WPS	Select this to enable or disable the WPS feature.
Confirm	Click Confirm to save your changes.
WPS Setup	
Configured	This displays Yes when the WAP6806 has connected to a wireless network using WPS or when Enable is selected.
WPS SSID	This displays the network name for the WPS connection.
WPS Auth Mode	This displays the security protocol selected for the WPS connection.

Table 5 Repeater: Configuration > Network > Wireless LAN (2.4G / 5G) > WPS (continued)

LABEL	DESCRIPTION
WPS Encryption Type	This displays the type of wireless encryption employed by the access point to which you want to connect.
PIN Code	This displays the previous PIN number the system generated.
Generate New PIN	Click Generate New PIN to have the WAP6806 generate a PIN number.
Release Configuration	Click this button to remove all configured wireless and wireless security settings for WPS connections on the WAP6806.
WPS Progress	
WPS Mode	Select whether the WAP6806 performs wireless security information synchronization using the PIN configuration method or the Push Button Configuration (PBC) method.
PIN Code	Type the same PIN number generated in the wireless station's utility.
Confirm	Click Confirm to save your changes.
WPS Status	
Status	<p>This displays the current WPS process.</p> <p>Idle - It means there is no active WPS.</p> <p>Start WSC Process - The WPS is activated to set up a wireless network.</p> <p>WPS Succeeded - The client is successfully connected with an AP.</p> <p>WSC Failed - The client fails to connect with an AP.</p>
Progress	This is an indication bar displaying the WPS connecting progress.

Access Point Mode

4.1 Overview

In Access Point (AP) mode your WAP6806 bridges a wired network (LAN) and wireless LAN (WLAN) in the same subnet. See the figure below for an example.

Figure 9 Wireless Internet Access in Access Point Mode

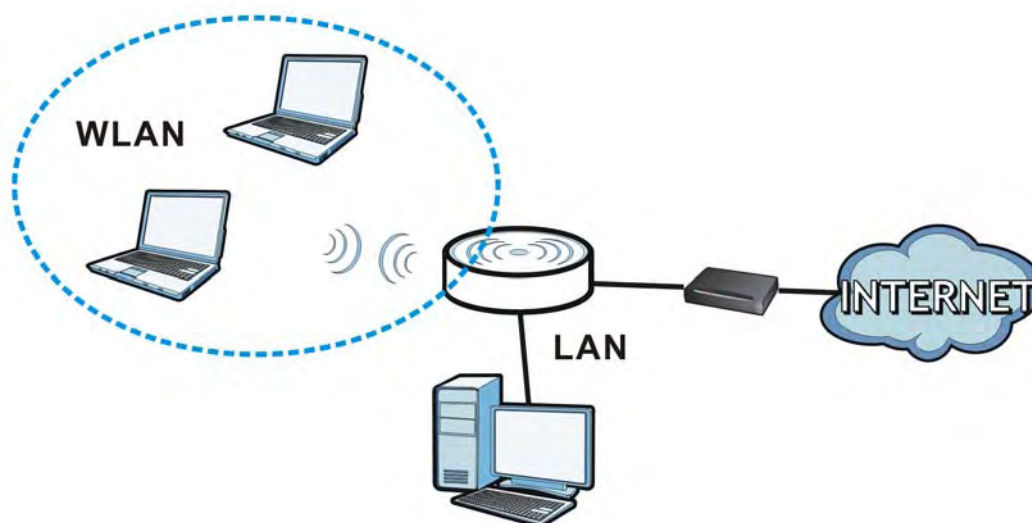

4.2 What You Can Do

- Use the **Status** screen ([Section 4.4 on page 24](#)) to view read-only information about your WAP6806.
- Use the **IP Alias** screen ([Section 11.4 on page 61](#)) to set the IP address for your WAP6806 acting as an access point.
- Use the **Wireless LAN > WPS** screen ([Section 12.7 on page 69](#)) to configure WPS on the WAP6806 to associate with another access point.

4.3 What You Need to Know

With the exception of the **Operation Mode**, other configuration screens in Access Point mode are similar to the ones in Repeater mode. See [Chapter 2 on page 15](#) of this User's Guide.

4.3.1 Setting your WAP6806 to AP Mode

By default, AP mode in the WAP6806 is not configured with a static IP address. To setup your WAP6806 in AP mode for the first time, the directly-connected router must have the DHCP server function enabled.

- 1 Connect one end of an Ethernet cable to the Ethernet port on the WAP6806 and the other end to your router.
- 2 Connect your computer to your network, make sure both the WAP6806 and computer are under the same subnet.
- 3 Open a web browser window and type “http://zyxelsetup” or “http://192.168.1.2” in the web address.
The login screen displays.
- 4 Enter “1234” (default) as the password and click **Login**.
- 5 Type a new password and retype it to confirm, then click **Change**. Otherwise, click **Skip**.

The WAP6806 Web Configurator displays, which allows you to configure the AP mode. See [Section 7.3 on page 33](#) for details.

4.3.2 Configuring your WLAN, LAN and Maintenance Settings

- See [Chapter 12 on page 62](#) and [Chapter 11 on page 60](#) for information on configuring your wireless network and LAN settings.
- See [Chapter 14 on page 76](#) for information on configuring your Maintenance settings.

4.4 AP Mode Status Screen

Click  to open the **Status** screen.

Figure 10 Status Screen: Access Point Mode

System Information	
Host Name:	WAP6806
System Mode:	AP Mode
Hardware Version:	A0B
Firmware Version:	1.00(ABAL 1)B1
System Up Time:	0 day: 0 hour: 26 minutes
Current Date/Time:	1969-Dec-31/16:28:16

Ethernet Information	
MAC Address:	58:8B:F3:15:76:92
IP Address:	169.254.71.254
Subnet Mask:	255.255.0.0
Encapsulation mode:	IP over Ethernet (IPoE)
Gateway:	0.0.0.0
DNS Server:	
IP Alias:	192.168.1.12
Subnet Mask:	255.255.0.0

Wireless Network Information - 2.4 GHz	
MAC Address:	5A:8B:83:15:76:90
Wireless Network:	Enable
SSID:	ZyXEL157692
Link rate:	300 Mbps
Current Channel:	6
Authentication:	WPA2-Personal
Mode:	802.11b/g/n Mixed
WPS Status:	Configured

Wireless Network Information - 5.0 GHz	
MAC Address:	58:8B:F3:15:76:93
Wireless Network:	Enable
SSID:	ZyXEL157692.speed
Link rate:	1733.2 Mbps
Current Channel:	38
Authentication:	WPA2-Personal
Mode:	802.11a/n/ac Mixed
WPS Status:	Configured

The following table describes the labels shown in the **Status** screen.

Table 6 Status Screen: Access Point Mode

LABEL	DESCRIPTION
System Information	
Host Name	This is the WAP6806's model name.
System Mode	This is the device mode (Section 2.1.1 on page 15) to which the WAP6806 is set - AP Mode .
Hardware Version	This displays the hardware version of the device.
Firmware Version	This displays the firmware version and the date created.
System Up Time	This displays the total time the WAP6806 has been on.
Current Date/Time	This displays the WAP6806's present date and time.
Ethernet Information	
MAC Address	This shows the LAN Ethernet adapter MAC Address of your device.
IP Address	This shows the LAN port's IP address.
IP Subnet Mask	This shows the LAN port's subnet mask.
Encapsulation mode	This shows the protocol for encapsulating packages the WAP6806 uses.
Gateway	This shows the gateway of the WAP6806.
DNS Server	This shows the IP address of the DNS Server.
IP Alias	This shows the IP address of the WAP6806.
Subnet Mask	This shows the subnet mask of the WAP6806.
Wireless Network Information - 2.4G / 5G	
MAC Address	This shows the wireless adapter MAC Address of your WAP6806.

Table 6 Status Screen: Access Point Mode (continued)

LABEL	DESCRIPTION
Wireless Network	This shows whether the wireless LAN function is enabled or disabled.
SSID	This shows a descriptive name used to identify the WAP6806 in the wireless LAN.
Link Rate	This shows the data transfer rate of the wireless network.
Current Channel	This shows the channel number which you select manually or the WAP6806 automatically scans and selects.
Authentication	This shows the wireless security mode used to protect the information that is sent in the wireless network.
Mode	This shows which IEEE 802.1b/g/n wireless networking standards the wireless device supports.
WPS Status	This shows the current status of the WPS.

Client Mode

5.1 Overview

Your WAP6806 can act as a wireless client. In wireless client mode, it can connect to an existing network via an access point. Use this mode if you already have an access point or wireless router in your network.

In the example below, one WAP6806 (**A**) is configured as a wireless client and another is used as an access point (**B**). The WAP6806 has two wired clients that need to connect to the Internet. The WAP6806 wirelessly connects to the available access point (**B**).

Figure 11 Wireless Client Mode

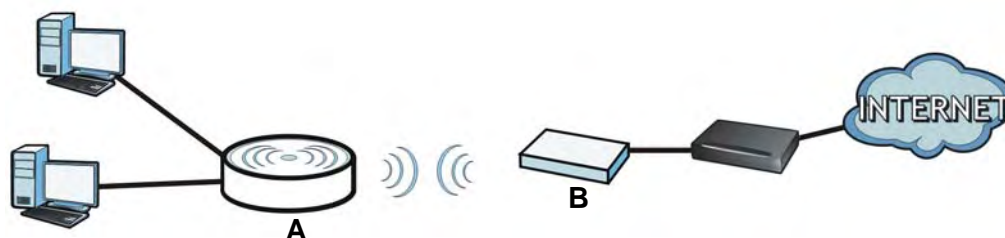

After the WAP6806 and the access point connect, the WAP6806 acquires its WAN IP address from the access point. The clients of the WAP6806 can now surf the Internet.

5.2 What You Can Do

- Use the **Status** screen ([Section 5.5 on page 28](#)) to view read-only information about your WAP6806.
- Use the **Ethernet** screen ([Chapter 11 on page 60](#)) to set the IP address for your WAP6806.

5.3 What You Need to Know

With the exception of the **Wireless LAN** screens, the **Ethernet**, **Monitor**, **Configuration** and **Maintenance** screens in Client mode are similar to the ones in Access Point Mode. See [Chapter 11 on page 60](#) through [Chapter 14 on page 76](#) of this User's Guide.

5.4 Setting your WAP6806 to Client Mode

- 1 Connect your computer to the LAN port of the WAP6806.
- 2 The default IP address of the WAP6806 is "192.168.1.2". In this case, your computer must have an IP address in the range between "192.168.1.3" and "192.168.1.254".
- 3 Click **Start > Run** on your computer in Windows. Type "cmd" in the dialog box. Enter "ipconfig" to show your computer's IP address. If your computer's IP address is not in the correct range then see [Appendix B on page 94](#) for information on changing your computer's IP address.
- 4 After you've set your computer's IP address, open a web browser such as Internet Explorer and type " http://zyxelsetup" or "http://192.168.1.2" as the web address in your web browser.
- 5 Enter "1234" (default) as the password and click **Login**.
- 6 Type a new password and retype it to confirm, then click **Change**. Otherwise, click **Skip**.

Note: You have to log in to the Web Configurator again when you change modes. As soon as you do, your WAP6806 is already in Client mode.

Note: The client mode IP address is always the same as the access point mode IP address. If you changed the IP address of your WAP6806 while in access point mode, use this IP address in client mode.

5.5 Client Mode Status Screen

Click  to open the status screen.

Figure 12 Status: Client Mode



The screenshot shows the ZyXEL ARMOR X1 web interface. The top navigation bar includes the ZyXEL logo, the model name "ARMOR X1", and user information: "Welcome: admin Logout | eaZy123 Home About". Below the navigation bar is a "Status" section with a "Refresh Interval" dropdown set to "NONE" and a "Refresh" button. The main content area is divided into three sections:

- System Information:**

Host Name:	WAP6806
System Mode:	Client Mode
Hardware Version:	A0B
Firmware Version:	1.00(ABAL.0)C0
System Up Time:	0 day, 0 hour, 2 minutes
Current DateTime:	1969-Dec-31/16:03:01
- Ethernet Information:**

MAC Address:	58:9B:F3:02:D4:9B
IP Address:	172.23.132.205
Subnet Mask:	255.255.252.0
Encapsulation mode:	IP over Ethernet (IPvE)
Gateway:	172.23.135.254
DNS Server:	168.95.1.1, 8.8.8.8
IP Alias:	192.168.1.2
Subnet Mask:	255.255.252.0
- AP Connection Status - 5G:**

MAC Address:	52:60:F0:37:FF:3E
SSID:	Unizy_0UEST
Channel:	40
Security:	NONE
Status:	Connected

The following table describes the labels shown in the **Status** screen.

Table 7 Status Screen: Client Mode

LABEL	DESCRIPTION
Device Information	
Host Name	This is the WAP6806's model name.
System Mode	This is the device mode (Section 2.1.1 on page 15) to which the WAP6806 is set - Client Mode .
Hardware Version	This displays the hardware version of the device.
Firmware Version	This displays the firmware version and the date created.
System Up Time	This displays the total time the WAP6806 has been on.
Current Date/Time	This displays the WAP6806's present date and time.
Ethernet Information	
MAC Address	This shows the LAN Ethernet adapter MAC Address of your device.
IP Address	This shows the LAN port's IP address.
Subnet Mask	This shows the LAN port's subnet mask.
Encapsulation Mode	This shows the protocol for encapsulating packets the WAP6806 uses.
Gateway	This shows the gateway of the WAP6806.
DNS Server	This shows the IP address of the DNS Server.
IP Alias	This shows the IP address of the WAP6806.
Subnet Mask	This shows the subnet mask of the WAP6806.
AP Connection Status - 2.4G / 5G	
MAC Address	This shows the wireless adapter MAC Address of the root AP.
SSID	This shows a descriptive name used to identify the root AP in the wireless LAN.
Channel	This shows the channel number which you select manually or the root AP automatically scans and selects.
Security	This shows the level of wireless security the root AP is using.
Status	This shows the current status of the Wireless LAN.

The Web Configurator

6.1 Overview

This chapter describes how to access the WAP6806 Web Configurator and provides an overview of its screens.

The Web Configurator is an HTML-based management interface that allows easy setup and management of the WAP6806 via Internet browser. Use a browser that supports HTML5, such as Internet Explorer 9.0 and later versions, Mozilla Firefox 21 and later versions, or Safari 6.0 and later versions or Google Chrome 26.0 and later versions. The recommended screen resolution is 1024 by 768 pixels.

In order to use the Web Configurator you need to allow:

- Web browser pop-up windows from your device. Web pop-up blocking is enabled by default in Windows XP SP (Service Pack) 2.
- JavaScript (enabled by default).
- Java permissions (enabled by default).

Refer to [Chapter 15 Troubleshooting](#) to see how to make sure these functions are allowed in Internet Explorer.

6.2 Accessing the Web Configurator

- 1 Make sure your WAP6806 hardware is properly connected and prepare your computer or computer network to connect to the WAP6806 (refer to the Quick Start Guide).
- 2 Launch your web browser.
- 3 Open a web browser such as Internet Explorer and type "http://zyxelsetup" or "http://192.168.1.2" as the web address in your web browser.

6.2.1 Login Screen

The Web Configurator initially displays the following login screen.

Figure 13 Login Screen



The following table describes the label in this screen.

Table 8 Login screen

LABEL	DESCRIPTION
Password	Type "1234" (default) as the password.

6.2.2 Password Screen

You should see a screen asking you to change your password (highly recommended) as shown next.

Figure 14 Change Password Screen



The following table describes the labels in this screen.

Table 9 Change Password Screen

LABEL	DESCRIPTION
New Password	Type a new password.
Confirm Password	Retype the password for confirmation.
Change	Click Change to save your changes back to the WAP6806.
Skip	Click Skip if you do not want to change the password this time.

6.3 Resetting the WAP6806

If you forget your password or IP address, or you cannot access the Web Configurator, use the **Reset** button to reboot the WAP6806. See [Section 1.5 on page 12](#) for more details.

Connection Wizard

7.1 Overview

This chapter provides information on the wizard setup screens in the Web Configurator.

The Web Configurator's wizard setup helps you configure your device for different modes.

7.2 Using the Web Configurator Wizard

After you log in to the WAP6806 Web Configurator, the **eaZy 123 Setup** screen displays.

Figure 15 Web Configurator Wizard

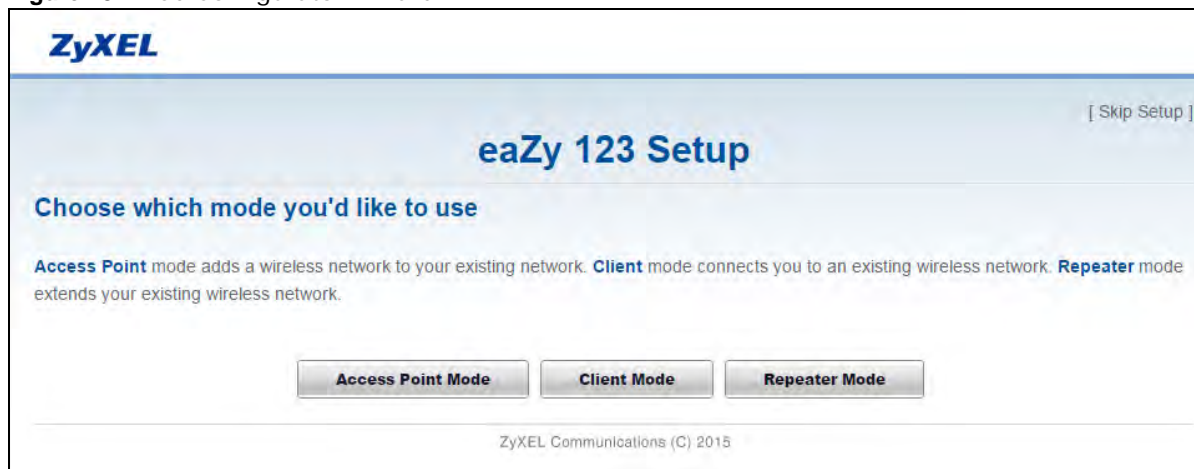

7.3 Configuring the WAP6806 to AP Mode

In wireless client mode, your WAP6806 bridges a wired network (LAN) and wireless LAN (WLAN) in the same subnet. Select **Access Point Mode** in the **eaZy 123 Setup** screen. The following screen displays.

Figure 16 eaZy 123 Setup -- Access Point Mode

ZyXEL

[Skip Setup]

eaZy 123 Setup

1 Check Internet

You've selected Access Point mode. Please ensure that you connect this access point to an Internet sharing router or gateway after completing this setup.

2 Wireless Network

Wireless Name (SSID):

Wireless Password (WPA2):

Edit 5 GHz wireless network

5 GHz Wireless Name (SSID):

5 GHz Wireless Password (WPA2):

Your 5 GHz (11ac) wireless name will automatically have ".speed" added to the end. Check "Edit 5 GHz wireless network" if you would like to edit it.

3 Apply Settings

Apply

! IMPORTANT!

Please write down all information that you've input here, so that you can refer to it in the future. When you're ready to apply this setup, click on "Apply"

- 1 Type the SSID and password for 2.4 GHz and 5 GHz (optional) wireless network, and then click **Apply**.
- 2 After entering the wireless network's password, the WAP6806 starts applying the wireless network as follows.

Figure 17 Applying the Wireless Network



The following screen appears if the network configuration is successful.

Figure 18 Wireless Network Configuration Complete

You can click **Expert** to go to the **Status** screen.

7.4 Configuring the WAP6806 to Client Mode

In wireless client mode, your WAP6806 connects to an existing network via an access point. Select **Client Mode** in the **eaZy 123 Setup** screen. The wizard scans for available networks as shown in the following screen.

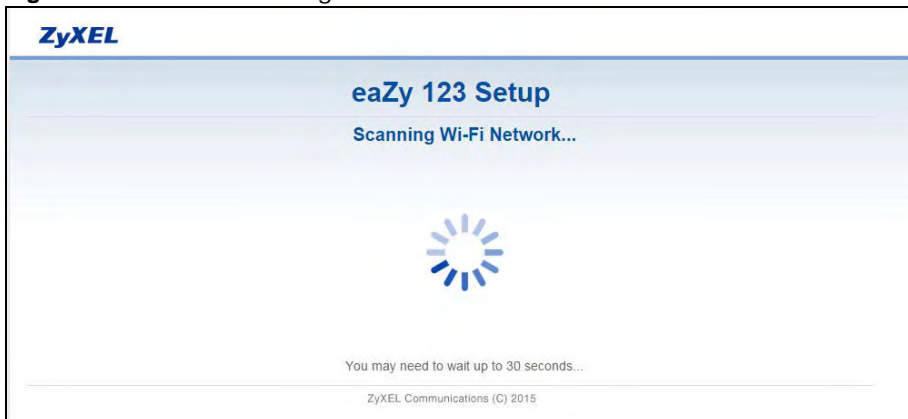
Figure 19 Wizard Scanning for Wireless Network

- 1 Select an available Wi-Fi network from the Wi-Fi Network list, as shown in the following screen.

Figure 20 Wireless Network List

[Skip Setup]

eaZy 123 Setup

1 Choose a Wi-Fi network

Choose your Wi-Fi network you wish to extend. We recommend to have at least 70% signal strength

Select	Signal(%)	Wi-Fi Network	Security	Wireless
<input type="radio"/>	100	ZyXEL157692.speed	NONE	11a/n/ac
<input type="radio"/>	100	ZyXEL157692	WPA2PSK/AES	11b/g/n
<input type="radio"/>	100	Unizyx_Mech	WPA1PSKWPA2PSK/TKIPAES	11b/g
<input type="radio"/>	100	WLAN11_7D43D4	WPA1PSKWPA2PSK/TKIPAES	11b/g/n
<input type="radio"/>	100	CDD_54423_01	WPA2PSK/AES	11b/g/n
<input type="radio"/>	100	Unizyx_MANAGER	WPA1PSKWPA2PSK/TKIPAES	11b/g/n
<input type="radio"/>	100	Unizyx_GUEST	NONE	11b/g/n
<input type="radio"/>	100	Unizyx_WLAN	WPA1WPA2/TKIPAES	11b/g/n
<input type="radio"/>	100	HTC Portable Hotspot AA5F	WPA2PSK/AES	11b/g/n
<input type="radio"/>	100	Mech.	WPAPSK/TKIP	11b/g/n
<input type="radio"/>	99	ZyXEL03	NONE	11b/g
<input type="radio"/>	96	HUAWEI-E5377-FC65	WPA2PSK/AES	11b/g/n
<input type="radio"/>	89	Unizyx_WLAN	WPA1WPA2/TKIPAES	11b/g/n
<input type="radio"/>	88	WLAN21_7D43D4	WPA1PSKWPA2PSK	11a/n/ac
<input type="radio"/>	86	MOVISTAR_2370	WPA2PSK/AES	11b/g/n
<input type="radio"/>	86	Unizyx_MANAGER	WPA1PSKWPA2PSK/TKIPAES	11b/g/n
<input type="radio"/>	21	ZyXEL_8940-5GHz	WPA2PSK	11a/n/ac
<input type="radio"/>	20	ZyXEL_WMS	WEP	11b/g
<input type="radio"/>	17	MOVISTAR_PLUS_9900	WPA2PSK	11a/n/ac
<input type="radio"/>	15	Unizyx_WLAN	WPA1WPA2/TKIPAES	11b/g/n
<input type="radio"/>	7	ZyXEL_668B-5GHz	WPA2PSK	11a/n/ac
<input type="radio"/>	7	TIM-00165100	WPA1PSKWPA2PSK	11a/n/ac
<input type="radio"/>	3	MT01354_56819_vv.speed	WPA2PSK	11a/n/ac
<input type="radio"/>	3	8888	WPA2PSK	11a/n/ac
<input type="radio"/>	3	ZyXEL_6689-5GHz	WPA2PSK	11a/n/ac

The following table describes the label in this screen.

Table 10 Wireless Network List

LABEL	DESCRIPTION
Select	Use the radio button to select the wireless device to which you want to connect.
Signal (%)	This displays the strength of the wireless signal. The signal strength mainly depends on the antenna output power and the distance between your WAP6806 and this device.
Wi-Fi Network	This displays the SSID of the wireless device.
Security	This displays the type of security configured on the wireless device. When None is shown, no security is configured and you can connect to it without a password.
Wireless	This displays which IEEE 802.1b/g/n/ac wireless networking standards the wireless device supports.
Continue	Click Continue to go to the next step in the setup process.
Scan Again	Click Scan Again to search for available wireless devices within transmission range and update this table.
Choose Network Manually	Click Choose Network Manually to set up the AP manually. You need to know the wireless device's SSID and password.

- 2 Click **Continue** to go to the next step.
- 3 Type the selected network's wireless password and then click **Continue**.

Figure 21 Enter Wireless Network Password

The screenshot shows the ZyXEL eaZy 123 Setup interface. At the top left is the ZyXEL logo. In the top right corner, there is a link that says "[Skip Setup]". The main heading is "eaZy 123 Setup". Below this, a blue circle with the number "2" is followed by the text "Enter Wi-Fi Network's Password". Underneath, there is a prompt: "Please enter in the wireless network's password that you're extending". To the right of this prompt is a rectangular text input field. At the bottom center of the screen is a button labeled "Continue".

- 4 After entering the wireless network's password, the verification screen displays as follows.

Figure 22 Verifying the Password



The following screen appears if the key verifies successfully.

Figure 23 Wireless Network Configuration Complete

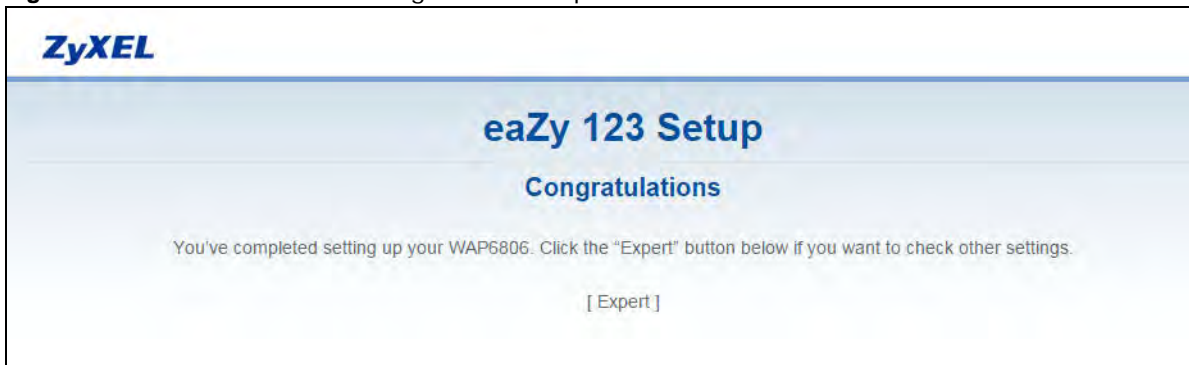

You can click **Expert** to go to the **Status** screen.

7.5 Configuring the WAP6806 to Repeater Mode

In wireless client mode, your WAP6806 can act as an access point and wireless client at the same time. Select **Repeater Mode** in the **eaZy 123 Setup** screen. The wizard scans for available networks as shown in the following screen.

Figure 24 Wizard Scanning for Wireless Network

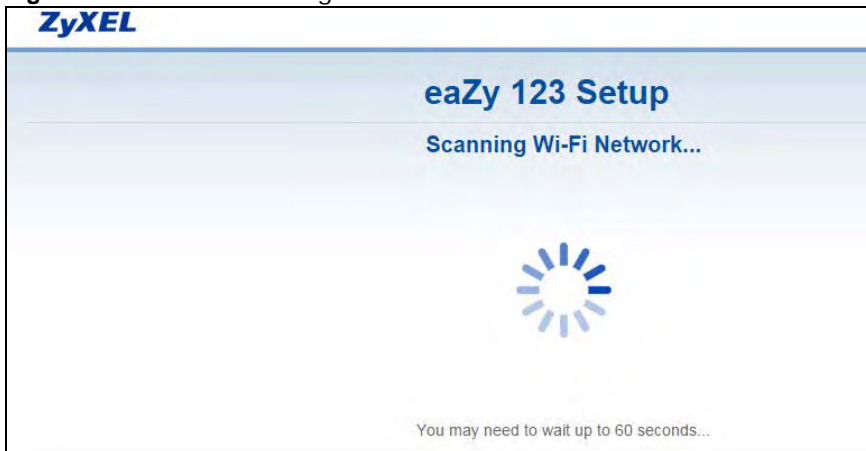

- 1 Select an available 2.4G Wi-Fi network from the Wi-Fi Network list, as shown in the following screen.

Figure 25 Wireless Network List

[Skip Setup]

eaZy 123 Setup

1 Choose a 2.4 GHz Wi-Fi network

Choose your 2.4 GHz Wi-Fi network you wish to extend. We recommend to have at least 70% signal strength

Select	Signal(%)	Wi-Fi Network	Security	Wireless
<input type="radio"/>	100	Unizyx_WLAN	WPA1WPA2/TKIPAES	11b/g/n
<input type="radio"/>	100	WLAN11_7D43D4	WPA1PSKWPA2PSK/TKIPAES	11b/g/n
<input type="radio"/>	100	Unizyx_GUEST	NONE	11b/g/n
<input type="radio"/>	100	Mech.	WPAPSK/TKIP	11b/g/n
<input type="radio"/>	100	CDD_54423_01	WPA2PSK/AES	11b/g/n
<input type="radio"/>	100	ZyXEL157692	WPA2PSK/AES	11b/g/n
<input type="radio"/>	99	Unizyx_MANAGER	WPA1PSKWPA2PSK/TKIPAES	11b/g/n
<input type="radio"/>	91	ZyXEL03	NONE	11b/g
<input type="radio"/>	91	GIGa	WPA2PSK/AES	11b/g/n
<input type="radio"/>	89	Unizyx_GUEST	NONE	11b/g/n
<input type="radio"/>	89	Unizyx_Mech	WPA1PSKWPA2PSK/TKIPAES	11b/g
<input type="radio"/>	86	Unizyx_MANAGER	WPA1PSKWPA2PSK/TKIPAES	11b/g/n
<input type="radio"/>	83	Unizyx_WLAN	WPA1WPA2/TKIPAES	11b/g/n
<input type="radio"/>	78	ZyXEL_WMS	WEP	11b/g
<input type="radio"/>	76	MOVISTAR_76B9	WPA2PSK/AES	11b/g/n
<input type="radio"/>	73	VIVO-90DC	WPA1PSKWPA2PSK/TKIPAES	11b/g/n
<input type="radio"/>	68	KLun	WPA2PSK/AES	11b/g/n
<input type="radio"/>	68	ZyXEL_WMS	WEP	11b/g
<input type="radio"/>	57	ZyXEL_WMS	WEP	11b/g
<input type="radio"/>	55	ZyXEL_3208	WPA2PSK/AES	11b/g/n
<input type="radio"/>	55	ZyXEL_WMS	WEP	11b/g
<input type="radio"/>	52	albu_tsou	WPA1PSKWPA2PSK/TKIP	11b/g
<input type="radio"/>	52	NSBU_R407_24G	WPA2PSK/AES	11b/g/n
<input type="radio"/>	37	J_TP-LINK	WPA1PSKWPA2PSK/AES	11b/g/n
<input type="radio"/>	37	ZyXEL_cjalee	WPA2PSK/AES	11b/g/n
<input type="radio"/>	34	TTNET_ZyXEL_H3XN	WPA2PSK/TKIPAES	11b/g/n
<input type="radio"/>	34	WIFI-2200	WPA1PSKWPA2PSK/AES	11b/g/n
<input type="radio"/>	31	SPEEDY-00500A	WPA1PSKWPA2PSK/TKIPAES	11b/g/n
<input type="radio"/>	18	888888	NONE	11b/g/n
<input type="radio"/>	18	777777	NONE	11b/g/n
<input type="radio"/>	10	BrcmAP0	NONE	11b/g/n

The following table describes the label in this screen.

Table 11 Wireless Network List

LABEL	DESCRIPTION
Select	Use the radio button to select the wireless device to which you want to connect.
Signal (%)	This displays the strength of the wireless signal. The signal strength mainly depends on the antenna output power and the distance between your WAP6806 and this device.
Wi-Fi Network	This displays the SSID of the wireless device.
Security	This displays the type of security configured on the wireless device. When None is shown, no security is configured and you can connect to it without a password.
Wireless	This displays which IEEE 802.1b/g/n wireless networking standards the wireless device supports.
Continue	Click Continue to go to the next step in the setup process.
Scan Again	Click Scan Again to search for available wireless devices within transmission range and update this table.
Choose Network Manually	Click Choose Network Manually to set up the AP manually. You need to know the wireless device's SSID and password.
Skip 2.4 GHz	Click Skip 2.4 GHz to go to set up the 5 GHz wireless network without configuring the 2.4G wireless network setup.

- 2 Click **Continue** to go to the next step.
- 3 Type the selected network's wireless password and then click **Continue**.

Figure 26 Enter Wireless Network Password

- 4 Select an available 5G Wi-Fi network from the Wi-Fi Network list, as shown in the following screen.

Figure 27 Wireless Network List

ZyXEL [Skip Setup]

eaZy 123 Setup

1 Choose a 5 GHz Wi-Fi network

Choose your 5 GHz Wi-Fi network you wish to extend. We recommend to have at least 70% signal strength

Select	Signal(%)	Wi-Fi Network	Security	Wireless
<input type="radio"/>	99	ZyXEL157692.speed	NONE	11a/n/ac
<input type="radio"/>	89	WLAN21_7D43D4	WPA1PSKWPA2PSK	11a/n/ac
<input type="radio"/>	82	Unizyx_MANAGER	WPA1PSKWPA2PSK	11a/n/ac
<input type="radio"/>	81	Unizyx_GUEST	NONE	11a/n/ac
<input type="radio"/>	56	ZyXEL 0 1 8 0 8_5G	WPA2PSK	11a/n/ac
<input type="radio"/>	56	ZyXEL 0 1 8 0 8_5G_MBSS2	WPA2PSK	11a/n/ac
<input type="radio"/>	42	Unizyx_MANAGER	WPA1PSKWPA2PSK	11a/n/ac
<input type="radio"/>	28	ZyXEL784514.speed	WPA2PSK	11a/n/ac
<input type="radio"/>	25	ZyXEL_8940-5GHz	WPA2PSK	11a/n/ac
<input type="radio"/>	17	MOVISTAR_PLUS_9900	WPA2PSK	11a/n/ac
<input type="radio"/>	3	Unizyx_MANAGER	WPA1PSKWPA2PSK	11a/n/ac

Continue Scan Again Choose Network Manually Skip 5 GHz

The following table describes the label in this screen.

Table 12 Wireless Network List

LABEL	DESCRIPTION
Select	Use the radio button to select the wireless device to which you want to connect.
Signal (%)	This displays the strength of the wireless signal. The signal strength mainly depends on the antenna output power and the distance between your WAP6806 and this device.
Wi-Fi Network	This displays the SSID of the wireless device.
Security	This displays the type of security configured on the wireless device. When None is shown, no security is configured and you can connect to it without a password.
Wireless	This displays which IEEE 802.1b/g/n wireless networking standards the wireless device supports.
Continue	Click Continue to go to the next step in the setup process.
Scan Again	Click Scan Again to search for available wireless devices within transmission range and update this table.
Choose Network Manually	Click Choose Network Manually to set up the AP manually. You need to know the wireless device's SSID and password.
Skip 5 GHz	Click Skip 5 GHz to go to the next step without configuring the 2.4G wireless network setup.

- 5 Click **Continue** to go to the next step. Verify the SSIDs and passwords of 2.4G/5G wireless network, and then click **Apply**.

Figure 28 Set the Repeater's Wireless Network

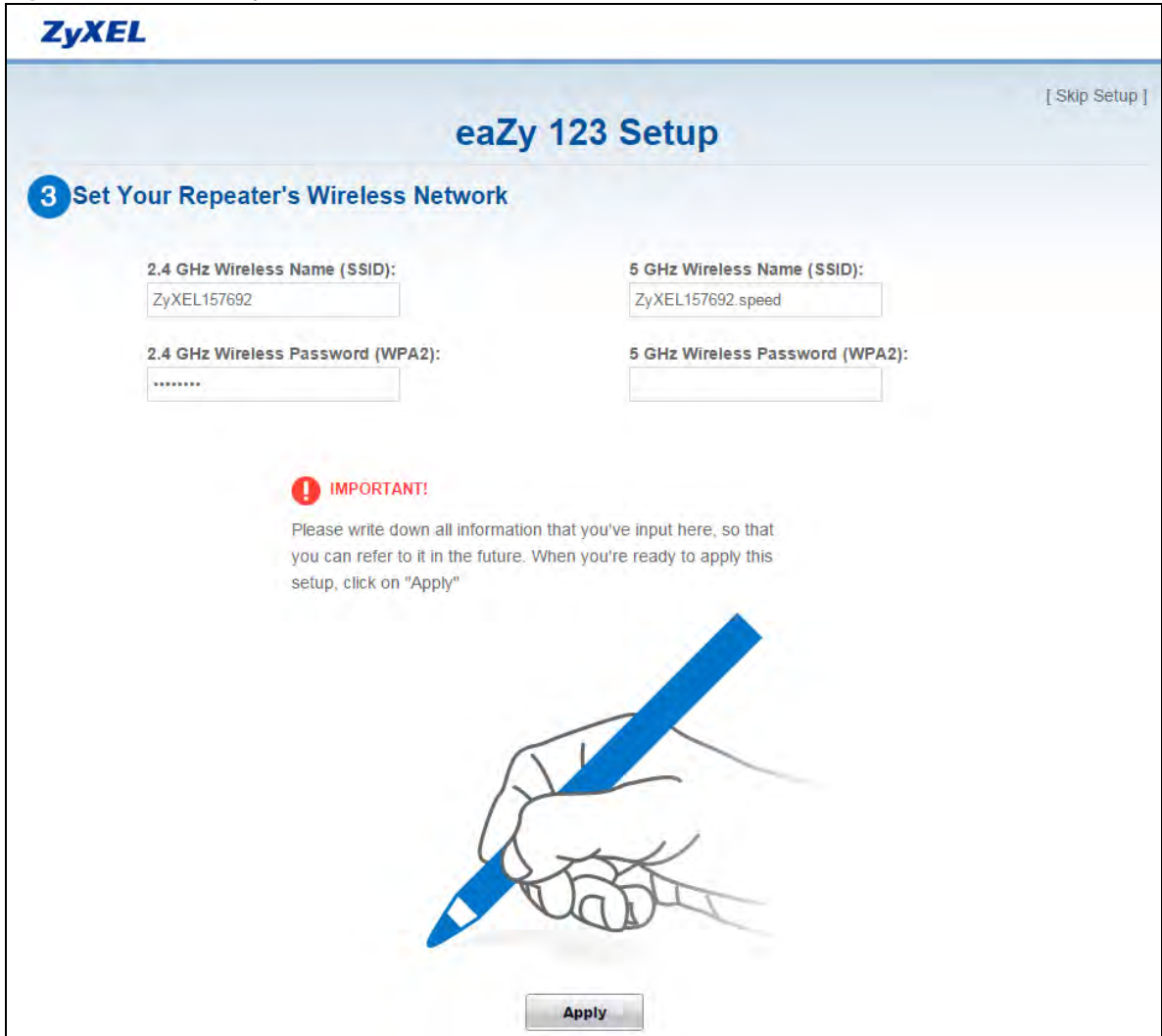

- 6 After verifying the SSIDs and passwords, the WAP6806 starts applying the wireless network as follows.

Figure 29 Applying the Wireless Network



The following screen appears if the key verifies successfully.

Figure 30 Wireless Network Configuration Complete



You can click **Expert** to go to the **Status** screen.

8.1 WAP6806 Status

The screens below show the status screen.

Figure 31 Client Mode > Status Screen

The screenshot shows the ZyXEL ARMOR X1 Client Mode Status Screen. The page includes a navigation bar with 'Welcome: admin', 'Logout', 'leaZy123', 'Home', and 'About'. The main content area is titled 'Status' and contains three sections:

System Information	
Host Name:	WAP6806
System Mode:	Client Mode
Hardware Version:	A0B
Firmware Version:	1.00(ABAL.0)C0
System Up Time:	0 day, 0 hour, 2 minutes
Current Date/Time:	1969-Dec-31/16:03:01

Ethernet Information	
MAC Address:	58:8B:F3:02:D4:9B
IP Address:	172.23.132.205
Subnet Mask:	255.255.252.0
Encapsulation mode:	IP over Ethernet (IPoE)
Gateway:	172.23.135.254
DNS Server:	168.95.1.1, 8.8.8.8
IP Alias:	192.168.1.2
Subnet Mask:	255.255.252.0

AP Connection Status - 5G	
MAC Address:	52:80:F9:37:FF:3E
SSID:	Unizys_GUEST
Channel:	40
Security:	NONE
Status:	Connected

Figure 32 AP Mode > Status Screen

The screenshot shows the ZyXEL ARMOR X1 AP Mode Status Screen. The page includes a navigation bar with 'Welcome: admin', 'Logout', 'leaZy123', 'Home', and 'About'. The main content area is titled 'Status' and contains three sections:

System Information	
Host Name:	WAP6806
System Mode:	AP Mode
Hardware Version:	A0B
Firmware Version:	1.00(ABAL.1)b1
System Up Time:	0 day, 0 hour, 26 minutes
Current Date/Time:	1969-Dec-31/16:28:16

Ethernet Information	
MAC Address:	58:8B:F3:15:76:92
IP Address:	169.254.71.254
Subnet Mask:	255.255.0.0
Encapsulation mode:	IP over Ethernet (IPoE)
Gateway:	0.0.0.0
DNS Server:	
IP Alias:	192.168.1.12
Subnet Mask:	255.255.0.0

Wireless Network Information - 2.4 GHz	
MAC Address:	5A:8B:83:15:76:90
Wireless Network:	Enable
SSID:	ZyXEL157692

Figure 33 Repeater Mode > Status Screen

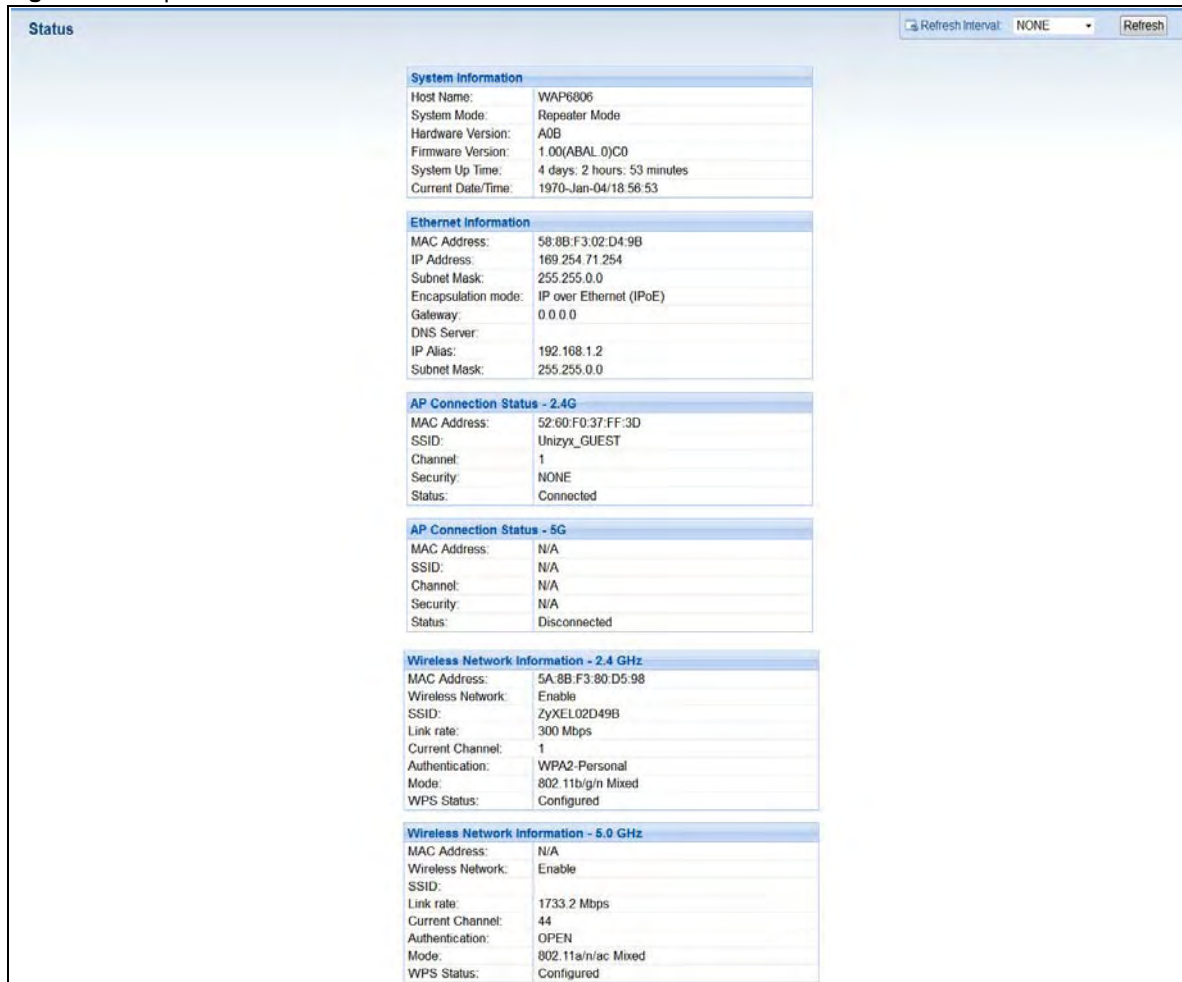

The following table describes the items shown on the top-right corner of the screen.

Table 13 Items on the Top-Right

ICON	DESCRIPTION
Logout	Click this at any time to exit the Web Configurator.
eaZy123	Click this hyperlink to open the setup wizard.
Home	Click this icon to go back to the Status screen.
About	Click this icon to view copyright and a link for related product information.
	Select a number of seconds or None from the drop-down list box to refresh all screen statistics automatically at the end of every time interval or to not refresh the screen statistics.
	Click this button to refresh the status screen.

For the **Status** screen of Repeater Mode, please go to [Table 4 on page 19](#) for details.

For the **Status** screen of AP Mode, please go to [Table 6 on page 25](#) for details.

For the **Status** screen of Client Mode, please go to [Table 7 on page 29](#) for details.

8.2 Navigation Panel

Use the menu in the navigation panel menus to configure WAP6806 features.

Figure 34 Menus



The following table describes the sub-menus.

Table 14 Menus

LINK	TAB	FUNCTION
Status		This screen shows the WAP6806's general device, system and interface status information.
Monitor		
System Log		This screen shows the logs for categories such as system maintenance and system errors.
Statistics		This screen shows the packet statistics of each port and the system up time. You can configure the Poll Interval to refresh the screen.
WLAN Station Status		This screen shows the wireless stations that are currently connected to the WAP6806. Note: This is for Repeater and AP mode only.
Configuration		
Operation Mode	Operation Mode Setup	Use this screen to select a system operation mode.
	AP Connection	Use the screen to configure the AP connection settings.
Ethernet	LAN Setup	Use this screen to configure the LAN port's settings.
	IP Alias	Use this screen to configure the WAP6806's IP address and subnet mask.
Wireless LAN 2.4G / 5G (for Repeater and AP mode only)	General	Use this screen to configure wireless LAN.
	Advanced	This screen allows you to configure advanced wireless settings.
	Security	Use this screen to select the available security modes as defined by the paired AP or wireless router.
	WPS	Use this screen to configure WPS.
Management	MCL	Use this screen to enable or disable services.
	One Connect	Use this screen to enable or disable the auto-configuration of One Connect.
Maintenance		
System	General	Use this screen to change the password.
	Time Setting	Use this screen to configure the WAP6806's time based on your local time zone.
Firmware Upgrade		Use this screen to upload firmware to your WAP6806.

Table 14 Menus (continued)

LINK	TAB	FUNCTION
Backup/ Restore		Use this screen to backup and restore the configuration or reset the factory defaults to your WAP6806.
Reboot		Use this screen to restart the system.

PART II

Technical Reference

9.1 Overview

This chapter discusses read-only information related to the device state of the WAP6806.

9.2 What You Can Do

- Use the **System Log** screen (Section 9.3 on page 49) to view the logs for the categories such as system maintenance, system errors, and so on.
- Use the **Statistics** screen (Section 9.4 on page 50) to view port status, packet specific statistics, the "system up time" and so on.
- Use the **WLAN Station Status** screen (Section 9.5 on page 51) to view the wireless stations that are currently associated to the WAP6806.

9.3 System Log

Click **Monitor > System Log**. Use the **View Log** screen to see the logged messages for the WAP6806.

Log entries in red indicate system error logs. The log wraps around and deletes the old entries after it fills.

Figure 35 Monitor > System Log

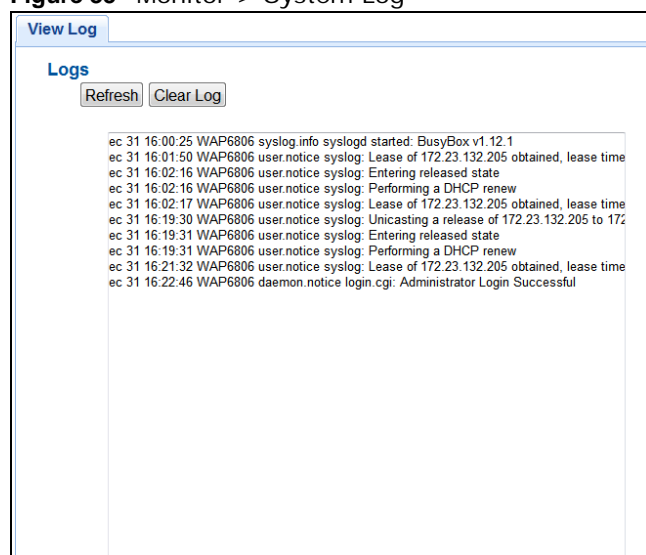

The following table describes the labels in this screen.

Table 15 Monitor > Log

LABEL	DESCRIPTION
Refresh	Click Refresh to renew the log screen.
Clear Log	Click Clear Log to delete all the logs.

9.4 Statistics

Click **Monitor > Statistics**. Read-only information here includes port status, packet specific statistics and the "system up time". The **Poll Interval(s)** field is configurable and is used for refreshing the screen.

Figure 36 Monitor > Statistics

Port	TxPkts	RxPkts	Tx Bytes	Rx Bytes	Tx Drop	Rx Drop	Tx Error	Rx Error
LAN1	5100	8972	1550637	790172	0	0	0	0
LAN2	0	0	0	0	0	0	0	0
LAN3	0	0	0	0	0	0	0	0
LAN4	0	0	0	0	0	0	0	0
Yvonne	0	0	0	0	0	0	0	0
Unizyx_GUEST	587	0	76899	0	0	0	0	0

System Up Time : 0 day: 0 hour: 44 minutes

Poll Interval(s) :

The following table describes the labels in this screen.

Table 16 Monitor > Statistics

LABEL	DESCRIPTION
Port	This is the WAP6806's port type.
TxPkts	This is the number of transmitted packets on this port.
RxPkts	This is the number of received packets on this port.
Tx Bytes	This displays the transmission speed in bytes per second on this port.
Rx Bytes	This displays the reception speed in bytes per second on this port.
Tx Drop	This displays the amount of packets that are dropped on the transmitting direction.
Rx Drop	This displays the amount of packets that are dropped on the receiving direction.
Tx Error	This displays the amount of packets that have errors on the transmitting direction.
Rx Error	This displays the amount of packets that have errors on the receiving direction.
System Up Time	This is the total time the WAP6806 has been on.
Poll Interval(s)	Enter the time interval in seconds for refreshing statistics in this field.
Set Interval	Click this button to apply the new poll interval you entered in the Poll Interval(s) field.
Stop	Click Stop to stop refreshing statistics.
Refresh	Click Refresh to renew the statistics screen.

9.5 WLAN Station Status

Click **Monitor > WLAN Station Status**. View the wireless stations that are currently associated to the WAP6806 in the **Connection List**. Connection means that a wireless client (for example, your network or computer with a wireless network card) has connected successfully to the AP (or wireless router) using the same SSID, channel and security settings.

Note: This screen is not available when the WAP6806 is in Client mode.

Figure 37 Monitor > WLAN Station Status

Wireless Network connection List						
#	MAC Address	RSSI	BW	Link rate	Connection Time	SSID
Refresh						

The following table describes the labels in this screen.

Table 17 Monitor > WLAN Station Status

LABEL	DESCRIPTION
#	This is the index number of an associated wireless station.
MAC Address	This field displays the MAC address of the connected wireless station.
RSSI	Received Signal Strength Indication (RSSI) is a measurement of the signal strength. Signal strength is displayed in units of decibel-milliwatts (dBm) and as a negative number. The stronger the signal, the better the quality of the connection.
BW	This displays the bandwidth the radio frequency (RF) uses. The bigger the bandwidth, the faster the link rate.
Link Rate	This displays the data transfer rate between the wireless station and the WAP6806.
Connection Time	This field displays the time a wireless station first connected to the WAP6806's WLAN network.
SSID	This field displays the Service Set Identity (SSID) of the connected wireless station.
Refresh	Click Refresh to reload the list.

Operation Mode

10.1 Overview

This chapter provides information on the **Operation Mode** screens.

10.2 What You Can Do

- Use the **Operation Mode** screen ([Section 10.3 on page 52](#)) to select how you want to use your WAP6806.
- Use the **AP Connection** screen ([Section 10.4 on page 55](#)) to view the AP connection status and configure the AP connection settings.

10.3 Operation Mode Setup

Use this screen to configure the system operation mode. Click **Configuration > Operation Mode > Operation Mode Setup**. The following screen displays.

Figure 38 Configuration > Operation Mode > Operation Mode Setup

The following table describes the labels in this screen.

Table 18 Configuration > Operation Mode > Operation Mode Setup

LABEL	DESCRIPTION
Operation Mode	<p>Select the system operation mode you want to use.</p> <ul style="list-style-type: none"> • Select AP Mode to have your device bridge traffic between clients on the same network. • Select Client Mode to have your device act as a wireless client to connect to an existing access point. See Section 10.3.1 on page 53 for more details. • Select Repeater Mode if you want to have wireless clients associate with the WAP6806 and also want to connect the WAP6806 to an existing access point. See Section 10.3.2 on page 53 for more details.

Table 18 Configuration > Operation Mode > Operation Mode Setup

LABEL	DESCRIPTION
Confirm	Click Confirm to save your changes.
Reset	Click Reset to begin configuring this screen afresh.

10.3.1 Client Mode Setup

Click **Configuration > Operation Mode > Operation Mode Setup** and then select **Client Mode**.

Figure 39 Configuration > Operation Mode > Operation Mode Setup

The screenshot shows a configuration window with two tabs: 'Operation Mode Setup' (selected) and 'AP Connection'. Below the tabs, there are two rows of settings: 'Operation Mode : Client Mode' (with a dropdown arrow) and 'Operating Band : 2.4GHz 5GHz'. At the bottom right, there are two buttons: 'Confirm' and 'Reset'.

The following table describes the labels in this screen.

Table 19 Configuration > Operation Mode > Operation Mode Setup

LABEL	DESCRIPTION
Operating Band	Select the operating band you want to use.
Confirm	Click Confirm to save your changes.
Reset	Click Reset to begin configuring this screen afresh.

10.3.2 Repeater Mode Setup

Click **Configuration > Operation Mode > Operation Mode Setup** and then select **Repeater Mode**.

Figure 40 Configuration > Operation Mode > Operation Mode Setup

The screenshot shows a configuration window with two tabs: 'Operation Mode Setup' (selected) and 'AP Connection'. Below the tabs, there are two rows of settings: 'Operation Mode : Repeater Mode' (with a dropdown arrow) and 'Repeater Mode: Normal Speed Ranging'. At the bottom right, there are two buttons: 'Confirm' and 'Reset'.

The following table describes the labels in this screen.

Table 20 Maintenance > General

LABEL	DESCRIPTION
Repeater Mode	Select the type of Repeater mode: Normal - both 2.4G and 5G bands are supported in up and down broadcasting. Speed - the 5G band is supported on the up behavior, while the 2.4G/5G bands are supported on the down behavior. Ranging - the 2.4G band is supported on the up behavior, while the 2.4G/5G bands are supported on the down behavior.
Confirm	Click Confirm to save your changes.
Reset	Click Reset to begin configuring this screen afresh.

You can select the type of Repeater mode: Normal, Ranging, or Speed mode.

The device enables you to extend the range of your dual-band router to eliminate "dead spots" in your wireless network. You can choose from normal, ranging, or speed modes for both your 2.4GHz and 5GHz networks.

The following terms are used to describe the Repeater mode:

- Up: The connection from the WAP6806 to the Router
- Down: The connection from the WAP6806 to a client

The following section describes the normal, ranging, or speed modes.

As connection profiles are established, the WAP6806 maintains a record of the varying profiles and automatically joins the network when in range.

Note: The home wireless network is the initial setup environment. The WAP6806 does not have any established network profiles at the time of initial setup.

10.3.2.1 Normal Mode

In Normal mode, both Down and Up are supported for both 2.4 GHz and 5 GHz bands.

Figure 41 Repeater Mode: Normal Mode

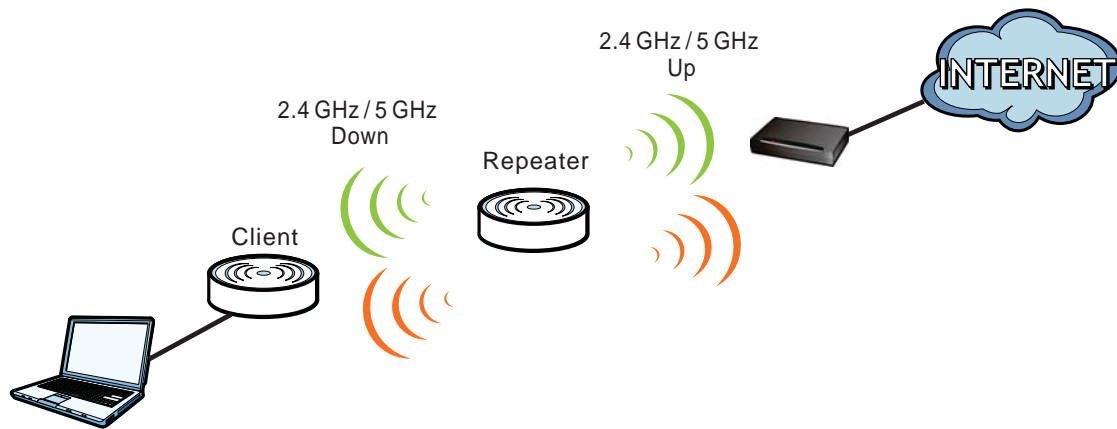

10.3.2.2 Ranging Mode

In Ranging mode, the 2.4 GHz band is supported on the Up behavior, while the 2.4 GHz and 5 GHz bands are supported on the Up behavior.

Figure 42 Repeater Mode: Ranging Mode

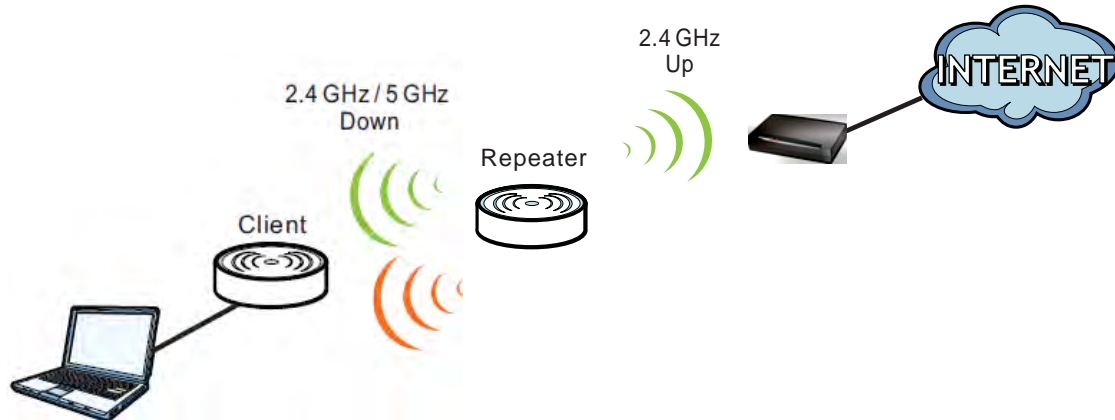

10.3.2.3 Speed Mode

In speed mode, the 5 GHz band is supported on the Up behavior, while the 2.4 GHz and 5 GHz bands are supported on the Up behavior.

Figure 43 Repeater Mode: Speed Mode

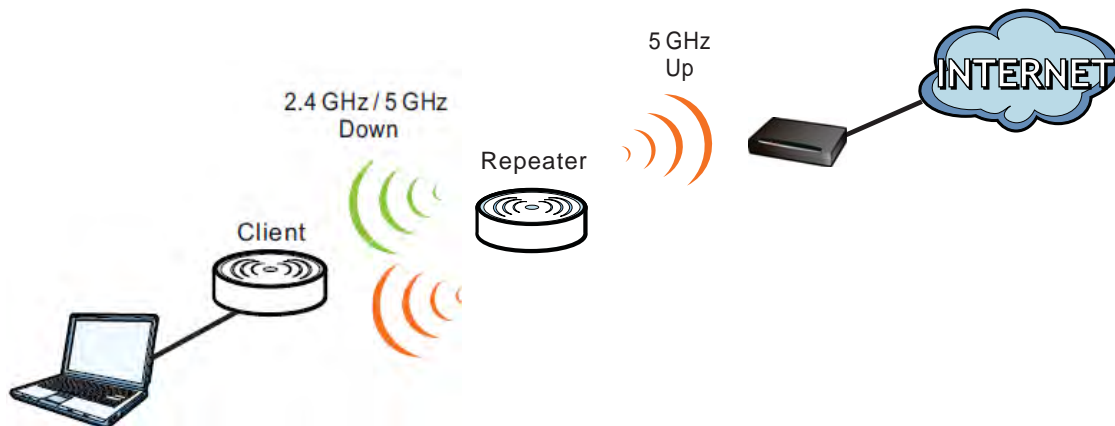

10.4 AP Connection

Use this screen to configure the AP connection settings. Click **Configuration > Operation Mode > AP Connection**.

Note: AP Connection screens are not available when the WAP6806 is in AP mode.

Figure 44 Configuration > Operation Mode > AP Connection

The following table describes the labels in this screen.

Table 21 Configuration > Operation Mode > AP Connection

LABEL	DESCRIPTION
AP Connection Status	
2.4 GHz Connection Status	This field displays the connected 2.4G wireless network name.
5 GHz Connection Status	This field displays the connected 5G wireless network name.
Setup AP Connection Manually	
SSID	Use this field to type the SSID of the AP. This is useful when the AP's SSID is hidden.
Encryption Type	Use this field to select an encryption mode to protect the information that is sent in the wireless network. None - allows wireless clients to communicate with the AP without any data encryption. WEP - See Section 10.4.1 on page 57 for details. WPA-Personal - See Section 10.4.2 on page 58 for details. WPA2-Personal - See Section 10.4.2 on page 58 for details. WPA/WPA2-Personal Mixed - See Section 10.4.2 on page 58 for details.
Confirm 2.4G	Click Confirm 2.4G to save your changes.
Confirm 5G	Click Confirm 5G to save your changes.
AP Connection List	

Table 21 Configuration > Operation Mode > AP Connection (continued)

LABEL	DESCRIPTION																																																																																																																																																																																																																																							
Scan	<p>Click Scan to display the wireless networks your WAP6806 can connect to as shown in the figure below.</p> <table border="1"> <thead> <tr> <th colspan="7">Wireless Network connection List</th> </tr> <tr> <th>#</th> <th>SSID</th> <th>BSSID</th> <th>Channel</th> <th>Security</th> <th>Signal(%)</th> <th></th> </tr> </thead> <tbody> <tr><td>⊖</td><td>HTC Portable Hotspot AASF</td><td>2c:8a:72:d3:3f:8b</td><td>3</td><td>WPA2PSK/AES</td><td>100</td><td></td></tr> <tr><td>⊖</td><td>Mech.</td><td>00:23:18:09:5f:34</td><td>6</td><td>WPAPSK/TKIP</td><td>100</td><td></td></tr> <tr><td>⊖</td><td>CDD_54423_01</td><td>00:17:9a:50:24:9f</td><td>6</td><td>WPA2PSK/AES</td><td>100</td><td></td></tr> <tr><td>⊖</td><td>ZyXEL03</td><td>00:19:cb:cf:45:af</td><td>6</td><td>NONE</td><td>99</td><td></td></tr> <tr><td>⊖</td><td>HUAWEI-E5377-FC65</td><td>3c:47:11:be:fc:65</td><td>8</td><td>WPA2PSK/AES</td><td>99</td><td></td></tr> <tr><td>⊖</td><td>Unizyx_Mech</td><td>40:4a:03:de:6c:73</td><td>3</td><td>WPA1PSKWPA2PSK/TKIPAES</td><td>89</td><td></td></tr> <tr><td>⊖</td><td>WLAN21_7D43D4</td><td>12:41:36:34:a6:e0</td><td>48</td><td>WPA1PSKWPA2PSK/TKIPAES</td><td>89</td><td></td></tr> <tr><td>⊖</td><td>Unizyx_GUEST</td><td>52:60:10:37:ff:3e</td><td>40</td><td>NONE</td><td>82</td><td></td></tr> <tr><td>⊖</td><td>Unizyx_MANAGER</td><td>52:61:10:37:ff:3e</td><td>40</td><td>WPA1PSKWPA2PSK/TKIPAES</td><td>82</td><td></td></tr> <tr><td>⊖</td><td>MOVISTAR_76B9</td><td>b0:46:fc:80:7b:ba</td><td>1</td><td>WPA2PSK/AES</td><td>81</td><td></td></tr> <tr><td>⊖</td><td>ZyXEL_WMS</td><td>fc:f5:28:ca:6f:6f</td><td>1</td><td>WEP</td><td>78</td><td></td></tr> <tr><td>⊖</td><td>Unizyx_WLAN</td><td>50:67:10:37:fe:b6</td><td>1</td><td>WPA1WPA2/TKIPAES</td><td>73</td><td></td></tr> <tr><td>⊖</td><td>VIVO-90DC</td><td>00:19:cb:00:00:00</td><td>6</td><td>WPA1PSKWPA2PSK/TKIPAES</td><td>65</td><td></td></tr> <tr><td>⊖</td><td>MOVISTAR_2370</td><td>b2:46:fc:53:23:70</td><td>8</td><td>WPA2PSK/AES</td><td>65</td><td></td></tr> <tr><td>⊖</td><td>ZyXEL_WMS</td><td>fc:f5:28:ca:6f:6b</td><td>1</td><td>WEP</td><td>63</td><td></td></tr> <tr><td>⊖</td><td>Sean&Melissa</td><td>c8:d3:a3:63:68:fd</td><td>5</td><td>WPA1PSKWPA2PSK/TKIPAES</td><td>60</td><td></td></tr> <tr><td>⊖</td><td>ZyXEL01808</td><td>02:00:b7:e6:24:9c</td><td>7</td><td>WPAPSK/AES</td><td>60</td><td></td></tr> <tr><td>⊖</td><td>ZyXEL_WMS</td><td>fc:f5:28:ca:6f:6f</td><td>1</td><td>WEP</td><td>55</td><td></td></tr> <tr><td>⊖</td><td>ZyXEL_6138</td><td>02:19:cb:02:61:38</td><td>1</td><td>WPA2PSK/AES</td><td>52</td><td></td></tr> <tr><td>⊖</td><td>TP-LINK_2.4Ghz_893225</td><td>10:fe:ed:89:32:25</td><td>1</td><td>WPA1PSKWPA2PSK/AES</td><td>52</td><td></td></tr> <tr><td>⊖</td><td>ZyXEL784514</td><td>ce:5d:04:8a:d4:10</td><td>2</td><td>WPA2PSK/AES</td><td>52</td><td></td></tr> <tr><td>⊖</td><td>ZyXEL 0 1 8 0 8_5G</td><td>b0:46:fc:5c:d1:c1</td><td>44</td><td>WPA2PSK/AES</td><td>51</td><td></td></tr> <tr><td>⊖</td><td>ZyXEL_WMS</td><td>fc:f5:28:ca:6f:6d</td><td>1</td><td>WEP</td><td>50</td><td></td></tr> <tr><td>⊖</td><td>Unizyx_GUEST</td><td>52:60:10:37:fe:b7</td><td>40</td><td>NONE</td><td>50</td><td></td></tr> <tr><td>⊖</td><td>Unizyx_MANAGER</td><td>52:61:10:37:fe:b7</td><td>40</td><td>WPA1PSKWPA2PSK/TKIPAES</td><td>50</td><td></td></tr> <tr><td>⊖</td><td>J_TP-LINK</td><td>c0:4a:00:67:5d:d2</td><td>6</td><td>WPA1PSKWPA2PSK/AES</td><td>44</td><td></td></tr> <tr><td>⊖</td><td>aisifire_9CE8</td><td>2a:28:5d:54:9c:e8</td><td>9</td><td>WPA1PSKWPA2PSK/AES</td><td>42</td><td></td></tr> <tr><td>⊖</td><td>ZyXEL023030 speed</td><td>00:13:49:02:30:31</td><td>40</td><td>WPA2PSK/AES</td><td>42</td><td></td></tr> <tr><td>⊖</td><td>ZyXEL_2044</td><td>52:67:10:d6:20:44</td><td>1</td><td>WPA1PSKWPA2PSK/TKIPAES</td><td>39</td><td></td></tr> <tr><td>⊖</td><td>movistar_013660</td><td>00:19:cb:01:36:60</td><td>1</td><td>WPA1PSKWPA2PSK/AES</td><td>39</td><td></td></tr> <tr><td>⊖</td><td>TP-LINK_4AD268</td><td>c0:4a:00:4a:d2:68</td><td>6</td><td>WPA1PSKWPA2PSK/TKIPAES</td><td>37</td><td></td></tr> </tbody> </table>	Wireless Network connection List							#	SSID	BSSID	Channel	Security	Signal(%)		⊖	HTC Portable Hotspot AASF	2c:8a:72:d3:3f:8b	3	WPA2PSK/AES	100		⊖	Mech.	00:23:18:09:5f:34	6	WPAPSK/TKIP	100		⊖	CDD_54423_01	00:17:9a:50:24:9f	6	WPA2PSK/AES	100		⊖	ZyXEL03	00:19:cb:cf:45:af	6	NONE	99		⊖	HUAWEI-E5377-FC65	3c:47:11:be:fc:65	8	WPA2PSK/AES	99		⊖	Unizyx_Mech	40:4a:03:de:6c:73	3	WPA1PSKWPA2PSK/TKIPAES	89		⊖	WLAN21_7D43D4	12:41:36:34:a6:e0	48	WPA1PSKWPA2PSK/TKIPAES	89		⊖	Unizyx_GUEST	52:60:10:37:ff:3e	40	NONE	82		⊖	Unizyx_MANAGER	52:61:10:37:ff:3e	40	WPA1PSKWPA2PSK/TKIPAES	82		⊖	MOVISTAR_76B9	b0:46:fc:80:7b:ba	1	WPA2PSK/AES	81		⊖	ZyXEL_WMS	fc:f5:28:ca:6f:6f	1	WEP	78		⊖	Unizyx_WLAN	50:67:10:37:fe:b6	1	WPA1WPA2/TKIPAES	73		⊖	VIVO-90DC	00:19:cb:00:00:00	6	WPA1PSKWPA2PSK/TKIPAES	65		⊖	MOVISTAR_2370	b2:46:fc:53:23:70	8	WPA2PSK/AES	65		⊖	ZyXEL_WMS	fc:f5:28:ca:6f:6b	1	WEP	63		⊖	Sean&Melissa	c8:d3:a3:63:68:fd	5	WPA1PSKWPA2PSK/TKIPAES	60		⊖	ZyXEL01808	02:00:b7:e6:24:9c	7	WPAPSK/AES	60		⊖	ZyXEL_WMS	fc:f5:28:ca:6f:6f	1	WEP	55		⊖	ZyXEL_6138	02:19:cb:02:61:38	1	WPA2PSK/AES	52		⊖	TP-LINK_2.4Ghz_893225	10:fe:ed:89:32:25	1	WPA1PSKWPA2PSK/AES	52		⊖	ZyXEL784514	ce:5d:04:8a:d4:10	2	WPA2PSK/AES	52		⊖	ZyXEL 0 1 8 0 8_5G	b0:46:fc:5c:d1:c1	44	WPA2PSK/AES	51		⊖	ZyXEL_WMS	fc:f5:28:ca:6f:6d	1	WEP	50		⊖	Unizyx_GUEST	52:60:10:37:fe:b7	40	NONE	50		⊖	Unizyx_MANAGER	52:61:10:37:fe:b7	40	WPA1PSKWPA2PSK/TKIPAES	50		⊖	J_TP-LINK	c0:4a:00:67:5d:d2	6	WPA1PSKWPA2PSK/AES	44		⊖	aisifire_9CE8	2a:28:5d:54:9c:e8	9	WPA1PSKWPA2PSK/AES	42		⊖	ZyXEL023030 speed	00:13:49:02:30:31	40	WPA2PSK/AES	42		⊖	ZyXEL_2044	52:67:10:d6:20:44	1	WPA1PSKWPA2PSK/TKIPAES	39		⊖	movistar_013660	00:19:cb:01:36:60	1	WPA1PSKWPA2PSK/AES	39		⊖	TP-LINK_4AD268	c0:4a:00:4a:d2:68	6	WPA1PSKWPA2PSK/TKIPAES	37	
Wireless Network connection List																																																																																																																																																																																																																																								
#	SSID	BSSID	Channel	Security	Signal(%)																																																																																																																																																																																																																																			
⊖	HTC Portable Hotspot AASF	2c:8a:72:d3:3f:8b	3	WPA2PSK/AES	100																																																																																																																																																																																																																																			
⊖	Mech.	00:23:18:09:5f:34	6	WPAPSK/TKIP	100																																																																																																																																																																																																																																			
⊖	CDD_54423_01	00:17:9a:50:24:9f	6	WPA2PSK/AES	100																																																																																																																																																																																																																																			
⊖	ZyXEL03	00:19:cb:cf:45:af	6	NONE	99																																																																																																																																																																																																																																			
⊖	HUAWEI-E5377-FC65	3c:47:11:be:fc:65	8	WPA2PSK/AES	99																																																																																																																																																																																																																																			
⊖	Unizyx_Mech	40:4a:03:de:6c:73	3	WPA1PSKWPA2PSK/TKIPAES	89																																																																																																																																																																																																																																			
⊖	WLAN21_7D43D4	12:41:36:34:a6:e0	48	WPA1PSKWPA2PSK/TKIPAES	89																																																																																																																																																																																																																																			
⊖	Unizyx_GUEST	52:60:10:37:ff:3e	40	NONE	82																																																																																																																																																																																																																																			
⊖	Unizyx_MANAGER	52:61:10:37:ff:3e	40	WPA1PSKWPA2PSK/TKIPAES	82																																																																																																																																																																																																																																			
⊖	MOVISTAR_76B9	b0:46:fc:80:7b:ba	1	WPA2PSK/AES	81																																																																																																																																																																																																																																			
⊖	ZyXEL_WMS	fc:f5:28:ca:6f:6f	1	WEP	78																																																																																																																																																																																																																																			
⊖	Unizyx_WLAN	50:67:10:37:fe:b6	1	WPA1WPA2/TKIPAES	73																																																																																																																																																																																																																																			
⊖	VIVO-90DC	00:19:cb:00:00:00	6	WPA1PSKWPA2PSK/TKIPAES	65																																																																																																																																																																																																																																			
⊖	MOVISTAR_2370	b2:46:fc:53:23:70	8	WPA2PSK/AES	65																																																																																																																																																																																																																																			
⊖	ZyXEL_WMS	fc:f5:28:ca:6f:6b	1	WEP	63																																																																																																																																																																																																																																			
⊖	Sean&Melissa	c8:d3:a3:63:68:fd	5	WPA1PSKWPA2PSK/TKIPAES	60																																																																																																																																																																																																																																			
⊖	ZyXEL01808	02:00:b7:e6:24:9c	7	WPAPSK/AES	60																																																																																																																																																																																																																																			
⊖	ZyXEL_WMS	fc:f5:28:ca:6f:6f	1	WEP	55																																																																																																																																																																																																																																			
⊖	ZyXEL_6138	02:19:cb:02:61:38	1	WPA2PSK/AES	52																																																																																																																																																																																																																																			
⊖	TP-LINK_2.4Ghz_893225	10:fe:ed:89:32:25	1	WPA1PSKWPA2PSK/AES	52																																																																																																																																																																																																																																			
⊖	ZyXEL784514	ce:5d:04:8a:d4:10	2	WPA2PSK/AES	52																																																																																																																																																																																																																																			
⊖	ZyXEL 0 1 8 0 8_5G	b0:46:fc:5c:d1:c1	44	WPA2PSK/AES	51																																																																																																																																																																																																																																			
⊖	ZyXEL_WMS	fc:f5:28:ca:6f:6d	1	WEP	50																																																																																																																																																																																																																																			
⊖	Unizyx_GUEST	52:60:10:37:fe:b7	40	NONE	50																																																																																																																																																																																																																																			
⊖	Unizyx_MANAGER	52:61:10:37:fe:b7	40	WPA1PSKWPA2PSK/TKIPAES	50																																																																																																																																																																																																																																			
⊖	J_TP-LINK	c0:4a:00:67:5d:d2	6	WPA1PSKWPA2PSK/AES	44																																																																																																																																																																																																																																			
⊖	aisifire_9CE8	2a:28:5d:54:9c:e8	9	WPA1PSKWPA2PSK/AES	42																																																																																																																																																																																																																																			
⊖	ZyXEL023030 speed	00:13:49:02:30:31	40	WPA2PSK/AES	42																																																																																																																																																																																																																																			
⊖	ZyXEL_2044	52:67:10:d6:20:44	1	WPA1PSKWPA2PSK/TKIPAES	39																																																																																																																																																																																																																																			
⊖	movistar_013660	00:19:cb:01:36:60	1	WPA1PSKWPA2PSK/AES	39																																																																																																																																																																																																																																			
⊖	TP-LINK_4AD268	c0:4a:00:4a:d2:68	6	WPA1PSKWPA2PSK/TKIPAES	37																																																																																																																																																																																																																																			
Wireless Network Connection List	<p>This list displays the wireless networks your WAP6806 can connect to.</p> <p># - Click this field to select a wireless network for your WAP6806.</p> <p>SSID - This displays the SSID of the wireless device.</p> <p>BSSID - This displays the MAC address of the wireless device.</p> <p>Channel - This displays the channel number used by this wireless device.</p> <p>Security - This displays the type of security configured on the wireless device.</p> <p>Signal (%) - This displays the strength of the wireless signal. The signal strength depends on the antenna output power and distance between your WAP6806 and the wireless device.</p>																																																																																																																																																																																																																																							
Key	Use this field to type the selected network's wireless password.																																																																																																																																																																																																																																							
Confirm	Click Confirm to save your changes.																																																																																																																																																																																																																																							
Reset	Click Reset to begin configuring this screen afresh.																																																																																																																																																																																																																																							

10.4.1 WEP Encryption

Wire Equivalence Protection (WEP) encryption scrambles the data transmitted between the wireless stations and the access points to keep network communication private. It encrypts unicast and multicast communications in a network. Both the wireless stations and the access points must use the same WEP key.

Select **WEP** from the **Encryption Type** list.

Figure 45 WEP Encryption

Setup AP Connection Manually

SSID :

Encryption type :

Key Index :

WEP Key : ASCII

The following table describes the labels in this screen.

Table 22 WEP Encryption

LABEL	DESCRIPTION
Key Index	Select one index for configuring a key. The default key index is Key 1 . You must configure at least one key, and only one key is activated at one time.
WEP Key	WEP keys are used to encrypt data. Both the WAP6806 and the wireless stations must use the same WEP key for data transmission. ASCII - Select this option to enter ASCII characters as a WEP key. Hex - Select this option to enter hexadecimal characters as a WEP key.
Confirm 2.4G	Click Confirm 2.4G to save your changes.

10.4.2 WPA-Personal / WPA2-Personal / WPA/WPA2-Personal Mixed

Wi-Fi Protected (WPA) is a subset of the IEEE 802.11i standard. WPA2 (IEEE 802.11i) is a wireless security standard that defines stronger encryption, authentication and key management than WPA.

Key differences between WPA or WPA2 and WEP are improved data encryption and user authentication.

If both an AP and the wireless clients support WPA2 and you have an external RADIUS server, use WPA2 for stronger data encryption. If you don't have an external RADIUS server, you should use WPA-Personal that only requires a single (identical) password entered into each access point, wireless gateway and wireless client. As long as the password match, a wireless client will be granted access to a WLAN.

If the AP or the wireless clients do not support WPA2, just use WPA or WPA-Personal depending on whether you have an external RADIUS server or not.

Select WEP only when the AP and/or wireless clients do not support WPA or WPA2. WEP is less secure than WPA or WPA2.

Select **WPA-Personal**, **WPA2-Personal**, or **WPA/WPA2-Personal Mixed** from the **Encryption Type** list.

Figure 46 WPA-Personal, WPA2-Personal, or WPA/WPA2-Personal Mixed

Setup AP Connection Manually

SSID :

Encryption type :

Encryption : TKIP AES TKIP/AES

KEY :

The following table describes the labels in this screen.

Table 23 WPA-Personal, WPA2-Personal, or WPA/WPA2-Personal Mixed

LABEL	DESCRIPTION
Encryption	Select TKIP , AES , or TKIP/AES to enable data encryption. TKIP - Temporal Key Integrity Protocol (TKIP) uses 128-bit keys that are dynamically generated and distributed by the authentication server. AES - Advanced Encryption Standard (AES) is a block cipher that uses a 256-bit mathematical algorithm called Rijndael. TKIP/AES - Supports both the TKIP and AES encryption types at the same time.
Key	WPA-Personal, WPA2-Personal, and WPA/WPA2-Personal Mixed uses a simple common password for authentication. Type a password from 8 to 63 ASCII characters or 64 hexadecimal characters.
Confirm 2.4G	Click Confirm 2.4G to save your changes.
Confirm 5G	Click Confirm 5G to save your changes.

11.1 Overview

This chapter describes how to configure LAN settings.

11.2 What You Can Do

- Use the **LAN Setup** screen (Section 11.3 on page 60) to change the IP address for your WAP6806.
- Use the **IP Alias** screen (Section 11.4 on page 61) to have the WAP6806 apply IP alias to create LAN subnets.

11.3 LAN Setup Screen

This screen allows you to assign the WAP6806 a fixed or dynamic management IP address. The default IP address of the WAP6806 in repeater mode is 192.168.1.2. Alternatively, you can connect to the WAP6806 using the default domain name, `http://zyxelsetup`.

Use this screen to change the WAP6806's management IP address. Click **Configuration > Network > Ethernet > LAN Setup**.

Figure 47 Configuration > Network > Ethernet > LAN Setup

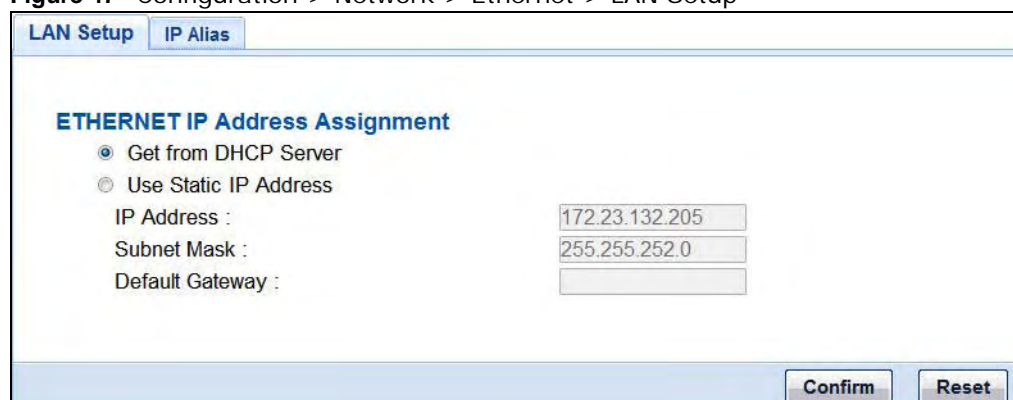

The screenshot shows the 'LAN Setup' screen with two tabs: 'LAN Setup' and 'IP Alias'. The 'LAN Setup' tab is active. The screen displays the title 'ETHERNET IP Address Assignment' and two radio button options: 'Get from DHCP Server' (selected) and 'Use Static IP Address'. Below these options are three input fields: 'IP Address' with the value '172.23.132.205', 'Subnet Mask' with the value '255.255.252.0', and 'Default Gateway' which is empty. At the bottom right, there are two buttons: 'Confirm' and 'Reset'.

The following table describes the labels in this screen.

Table 24 Configuration > Network > Ethernet > LAN Setup

LABEL	DESCRIPTION
Get from DHCP Server	Select this to have the WAP6806 get a dynamic IP address from a DHCP server.
Use Static IP Address	Click this to enable the manual IP configuration.
IP Address	Enter the IP address of your WAP6806 in dotted decimal notation.
Subnet Mask	Enter the subnet mask of your WAP6806 in dotted decimal notation.
Default Gateway	Enter the gateway of your WAP6806 in dotted decimal notation.
Confirm	Click Confirm to save your changes.
Reset	Click Reset to reload the previous configuration for this screen.

11.4 IP Alias Screen

IP alias allows you to partition a physical network into different logical networks over the same Ethernet interface. The WAP6806 supports three logical LAN interfaces via its single physical Ethernet interface with the WAP6806 itself as the gateway for each LAN network.

Use this screen to have the WAP6806 apply IP alias to create LAN subnets. Click **Configuration > Network > Ethernet > IP Alias**.

Figure 48 Configuration > Network > Ethernet > IP Alias

The following table describes the labels in this screen.

Table 25 Configuration > Network > Ethernet > IP Alias

LABEL	DESCRIPTION
IP Address	Enter the IP alias address of your WAP6806 in dotted decimal notation.
Subnet Mask	Enter the subnet mask of the IP alias in dotted decimal notation.
Confirm	Click Confirm to save your changes.
Reset	Click Reset to reload the previous configuration for this screen.

Wireless LAN

12.1 Overview

This chapter discusses how to configure the wireless network settings in your WAP6806. See [Section 1.1 on page 9](#) for an overview of wireless networks.

Note: Wireless LAN screens are not available when the WAP6806 is in Client mode.

12.2 What You Can Do

- Use the **General** screen to enable the Wireless LAN (2.4G/5G), enter the SSID and select the HT physical mode ([Section 12.4 on page 63](#)).
- Use the **Advanced** screen to set the RTS Threshold and WMM ([Section 12.5 on page 65](#)).
- Use the **Security** screen to configure wireless security between the WAP6806 and the wireless clients ([Section 12.6 on page 66](#)).
- Use the **WPS** screen to quickly set up a wireless network with strong security, without having to configure security settings manually ([Section 12.7 on page 69](#)).

12.3 What You Should Know

Every wireless network must follow these basic guidelines.

- Every wireless client in the same wireless network must use the same SSID.
The SSID is the name of the wireless network. It stands for Service Set IDentity.
- If two wireless networks overlap, they should use different channels.
Like radio stations or television channels, each wireless network uses a specific channel, or frequency, to send and receive information.
- Every wireless client in the same wireless network must use security compatible with the AP.
Security stops unauthorized devices from using the wireless network. It can also protect the information that is sent in the wireless network.

12.3.1 Wireless Security Overview

The following sections introduce different types of wireless security you can set up in the wireless network.

12.3.1.1 Encryption

Wireless networks can use encryption to protect the information that is sent in the wireless network. Encryption is like a secret code. If you do not know the secret code, you cannot understand the message.

Table 26 Types of Encryption for Each Type of Authentication

	NO AUTHENTICATION
Weakest	No Security
↕	WEP
	WPA-Personal
Strongest	WPA2-Personal

For example, if users do not log in to the wireless network, you can choose no authentication, if users do log on to the wireless network, you can choose No Security, **WEP**, **WPA-Personal**, or **WPA2-Personal**.

Usually, you should set up the strongest encryption that every wireless client in the wireless network supports. Suppose the wireless network has two wireless clients. Device A only supports WEP, and device B supports WEP and WPA-Personal. Therefore, you should set up **WEP** in the wireless network.

Note: It is recommended that wireless networks use WPA-Personal, or stronger encryption. IEEE 802.1x and WEP encryption are better than none at all, but it is still possible for unauthorized devices to figure out the original information pretty quickly.

Many types of encryption use a key to protect the information in the wireless network. The longer the key, the stronger the encryption. Every wireless client in the wireless network must have the same key.

12.3.1.2 WPS

Wi-Fi Protected Setup (WPS) is an industry standard specification, defined by the Wi-Fi Alliance. WPS allows you to quickly set up a wireless network with strong security, without having to configure security settings manually. Depending on the devices in your network, you can either press a button (on the device itself, or in its configuration utility) or enter a PIN (Personal Identification Number) in the devices. Then, they connect and set up a secure network by themselves.

12.4 General Wireless LAN Screen

Use this screen to enable the Wireless LAN, enter the SSID and select the HT physical mode.

Note: If you are configuring the WAP6806 from a computer connected to the wireless LAN and you change the WAP6806's SSID, channel or security settings, you will lose your wireless connection when you press **Confirm**. You must then change the wireless settings of your computer to match the WAP6806's new settings.

Click **Configuration** > **Network** > **WLAN (2.4G/5G)** to open the **General** screen.

Figure 49 Configuration > Network > WLAN (2.4G) > General

General | Advanced | Security | WPS

Wireless Network

Wireless Network : Enable Disable

802.11 Mode : 802.11b/g/n Mixed

Channel : Auto Current Channel:1

SSID : Hide SSID AP Isolation

HT Physical Mode

Bandwidth : 20 20/40

Confirm Reset

Figure 50 Configuration > Network > WLAN (5G) > General

General | Advanced | Security | WPS

Wireless Network

Wireless Network : Enable Disable

Mode : 802.11a/n/ac Mixed

Channel: Auto Current Channel:44

SSID : ZyXEL02D49B.speed Hide SSID AP Isolation

VHT Option

VHT BandWidth : 20 40 80

Confirm Reset

The following table describes the general wireless LAN labels in this screen.

Table 27 Network > Wireless LAN (2.4G/5G) > General

LABEL	DESCRIPTION
Wireless Network	This is turned on by default. Click Disable to turn off the wireless LAN function.

Table 27 Network > Wireless LAN (2.4G/5G) > General (continued)

LABEL	DESCRIPTION
802.11 Mode	<p>Choose from the following options for 2.4G:</p> <ul style="list-style-type: none"> Select 802.11b/g Mixed mode to allow IEEE802.11b and IEEE 802.11g compliant WLAN devices to associate with the WAP6806. The transmission rate of your WAP6806 might be reduced. Select 802.11b Only mode to allow IEEE802.11b compliant WLAN devices to associate with the WAP6806. Select 802.11g Only mode to allow IEEE802.11g compliant WLAN devices to associate with the WAP6806. Select 802.11b/g/n Mixed mode to allow IEEE802.11b, IEEE802.11g and IEEE 802.11n compliant WLAN devices to associate with the WAP6806. The transmission rate of your WAP6806 might be reduced. Select 802.11n Only mode to allow IEEE802.11n compliant WLAN devices to associate with the WAP6806. Select 802.11g/n Mixed mode to allow IEEE802.11g and IEEE 802.11n compliant WLAN devices to associate with the WAP6806. The transmission rate of your WAP6806 might be reduced. <p>Choose from the following options for 5G:</p> <ul style="list-style-type: none"> Select 802.11a/n Mixed mode to allow IEEE802.11a and IEEE 802.11n compliant WLAN devices to associate with the WAP6806. Select 802.11a/n/ac Mixed mode to allow IEEE802.11a, IEEE 802.11n and IEEE 802.11ac compliant WLAN devices to associate with the WAP6806.
Channel	Use this field to select the channel number used by this wireless device.
SSID	The SSID (Service Set IDentity) identifies the Service Set with which a wireless client is associated. Enter a descriptive name (up to 32 printable characters found on a typical English language keyboard) for the wireless LAN.
Hide SSID	<p>Select this check box to hide the SSID in the outgoing beacon frame so a wireless client cannot obtain the SSID through scanning using a site survey tool.</p> <p>Note: Hide SSID will disable WPS automatically after you click Confirm.</p>
AP Isolation	<p>AP Isolation is to prevent wireless clients from communicating directly with each other through the WAP6806.</p> <p>Select this check box to enable this function.</p>
HT (High Throughput) Physical Mode (for WLAN 2.4G)	
Bandwidth	<p>Select the channel bandwidth you want to use for your wireless network.</p> <p>It is recommended that you select 20/40 MHz. Select 20 MHz if you want you lessen radio interference with other wireless devices in your neighborhood.</p>
VHT (Very High Throughput) Option (for WLAN 5G)	
VHT Bandwidth	Select the channel bandwidth you want to use for your wireless network.
Confirm	Click Confirm to save your changes.
Reset	Click Reset to reload the previous configuration for this screen.

12.5 Wireless LAN Advanced Screen

Use this screen to configure advanced wireless LAN parameters.

Click **Configuration** > **Network** > **Wireless LAN (2.4G/5G)** > **Advanced**. The screen appears as shown.

Figure 51 Configuration > Network > Wireless LAN (2.4G/5G) > Advanced

General	Advanced	Security	WPS
Wireless Advanced Setup			
Fragmentation Threshold :		2346	(Range 256-2346, default 2346)
RTS Threshold :		2347	(Range 1-2347, default 2347)
Output Power :		High	▼
WMM			
WMM Power Save :		<input type="radio"/> Enable	<input checked="" type="radio"/> Disable
		Confirm	Reset

The following table describes the labels in this screen.

Table 28 Configuration > Network > Wireless LAN (2.4G/5G) > Advanced

LABEL	DESCRIPTION
Wireless Advanced Setup	
Fragmentation Threshold	The threshold (number of bytes) for the fragmentation boundary for directed messages. It is the maximum data fragment size that can be sent. Enter an even number between 256 and 2346 .
RTS Threshold	Data with its frame size larger than this value will perform the RTS (Request To Send) handshake. Enter a value between 1 and 2347 .
Output Power (for 2.4G only)	Set the output power of the WAP6806 in this field. If there is a high density of APs in an area, decrease the output power of the WAP6806 to reduce interference with other APs. High - 100% Medium - 50% Low - 25%
WMM (Wi-Fi Multimedia)	
WMM Power Save	Select Enable or Disable to activate/inactivate the power save mechanism to save power and fine-tune power consumption.
Confirm	Click Confirm to save your changes.
Reset	Click Reset to reload the previous configuration for this screen.

12.6 Security

Use this screen to select the wireless security mode. Click **Configuration > Network > Wireless LAN (2.4G/5G) > Security** to open the **Security** screen. The screen varies depending on what you select in the **Encryption Type**.

Figure 52 Universal Repeater Mode: Wireless LAN (2.4G/5G) > Security (None)

General	Advanced	Security	WPS
Security			
Encryption type :		None	
Access Rule			
Function :		Disable	
MAC Filter Table			
#	MAC Address	Modify	
Add :		<input type="text"/>	
		Confirm	Reset

Figure 53 Universal Repeater Mode: Wireless LAN (2.4G) > Security (WEP)

General	Advanced	Security	WPS
Security			
Encryption type :		WEP	
Wire Equivalence Protection (WEP)			
Default Key Index :		KEY2	
WEP Key 1 :	1234567890	Hex	
WEP Key 2 :	1234567890	Hex	
WEP Key 3 :	1234567890	Hex	
WEP Key 4 :	1234567890	Hex	
<input type="checkbox"/> 64-bit: Enter 5 ASCII characters or 10 hex characters ("0-9", "A-F") or 128-bit: Enter 13 ASCII characters or 26 hex characters ("0-9", "A-F")			
Access Rule			
Function :		Disable	
MAC Filter Table			
#	MAC Address	Modify	
Add :		<input type="text"/>	
		Confirm	Reset

Figure 54 Universal Repeater Mode: Wireless LAN (2.4G/5G) > Security (WPA)

General	Advanced	Security	WPS
Security			
Encryption type :		WPA2-Personal	
WPA			
Encryption :		<input type="radio"/> TKIP <input checked="" type="radio"/> AES <input type="radio"/> TKIP/AES	
KEY :		4df8ab59	
Group Key Update Timer :		3600 Sec(0~4194303)	
Access Rule			
Function :		Disable	
MAC Filter Table			
#	MAC Address	Modify	
Add :		<input type="text"/>	
		Confirm	Reset

The following table describes the labels in this screen.

Table 29 Universal Repeater Mode: Wireless LAN (2.4G/5G) > Security

LABEL	DESCRIPTION
Security	
Encryption Type	Use this field to select an encryption mode to protect the information that is sent in the wireless network. None - allows wireless clients to communicate with the AP without any data encryption.
WEP (for 2.4G only)	
Default Key Index	Select one key (Key 1-4) as the default.
WEP Key 1~4	WEP keys are used to encrypt data. Both the WAP6806 and the wireless stations must use the same WEP key for data transmission. You must configure at least one key, and only one key is activated at one time. ASCII - Select this option to enter ASCII characters as a WEP key. Hex - Select this option to enter hexadecimal characters as a WEP key.
WPA-Personal / WPA2-Personal / WPA/PAS2-Personal (WPA-Personal is for 2.4G only)	
Encryption	Select TKIP , AES , or TKIP/AES to enable data encryption. TKIP - Temporal Key Integrity Protocol (TKIP) uses 128-bit keys that are dynamically generated and distributed by the authentication server. AES - Advanced Encryption Standard (AES) is a block cipher that uses a 256-bit mathematical algorithm called Rijndael. TKIP/AES - Supports both TKIP and AES encryption type at the same time.
Key	WPA-Personal, WPA2-Personal, and WPA/WPA2-Personal Mixed uses a simple common password for authentication. Type a password from 8 to 63 ASCII characters or 64 hexadecimal characters.
Group Key Update Timer	The Group Key Update Timer is the rate at which the AP sends a new group key out to all clients. The default is 3600 seconds (60 minutes).
Access Rule	
Function	This defines the filter action for the list of MAC addresses in the MAC Filter Table. Disable - Select Disable to deactivate the MAC filtering you configure below. Allow - Select Allow to permit access to the WAP6806, MAC addresses not listed will be denied access to the WAP6806. Block - Select Block to block access to the WAP6806, MAC addresses not listed will be allowed to access to the WAP6806.
MAC Filter Table	The MAC filter table allows you to configure the WAP6806 to give exclusive access to devices (Allow) or exclude devices (Block) from accessing the WAP6806. # - This is the index number of the wireless station. MAC Address - This is the MAC address of the wireless station that is allowed or denied access to the WAP6806. Modify - Click the delete icon to remove the MAC address from the table.
Add	Enter the MAC addresses of the wireless stations that are allowed or denied access to the WAP6806 in these address fields. Enter the MAC addresses in a valid MAC address format, that is, six hexadecimal character pairs, for example, 12:34:56:78:9a:bc.
Confirm	Click Confirm to save your changes.
Reset	Click Reset to reload the previous configuration for this screen.

12.7 WPS Screen

Use this screen to enable/disable WPS, view or generate a new PIN and check current WPS status. To open this screen, click **Configuration > Network > Wireless LAN (2.4G/5G) > WPS** tab.

Figure 55 Configuration > Network > Wireless LAN (2.4G/5G) > WPS

The following table describes the labels in this screen.

Table 30 Network > Wireless LAN (2.4G/5G) > WPS

LABEL	DESCRIPTION
WPS Setup	
WPS	Select this to enable or disable the WPS feature.
Confirm	Click Confirm to save your changes.
WPS Setup	
Configured	This displays Yes when the WAP6806 has connected to a wireless network using WPS or when Enable is selected.
WPS SSID	This displays the network name for the WPS connection.
WPS Auth Mode	This displays the security protocol selected for the WPS connection.
WPS Encryption Type	This displays the type of wireless encryption employed by the access point to which you want to connect. Note: This is for Wireless LAN 2.4G only.
PIN Code	This displays the previous PIN number the system generated.
Generate New PIN	Click Generate New PIN to have the WAP6806 generate a PIN number.

Table 30 Network > Wireless LAN (2.4G/5G) > WPS (continued)

LABEL	DESCRIPTION
Release Configuration	Click this button to remove all configured wireless and wireless security settings for WPS connections on the WAP6806.
WPS Progress	
WPS Mode	Select whether the WAP6806 performs wireless security information synchronization using the PIN configuration method or the Push Button Configuration (PBC) method.
PIN Code	Type the same PIN number generated in the wireless station's utility.
Confirm	Click Confirm to save your changes.
WPS Status	
Status	This displays the current WPS process. Idle - It means there is no active WPS. Start WSC Process - The WPS is activated to set up a wireless network. WPS Succeeded - The client is successfully connected with an AP. WSC Failed - The client fails to connect with an AP.
Progress	This is an indication bar displaying the WPS connecting progress.

12.7.1 Connecting to a Wireless Network Using WPS

This section gives you an example of how to set up wireless network using WPS. The following example uses the WAP6806 as the AP and NWD-211AN as the wireless client which connects to a notebook.

Note: The wireless client must be a WPS-aware device (for example, a WPS USB adapter or PCI card).

The following WPS methods for creating a secure connection are described in the tutorial.

- **Push Button Configuration (PBC)** - create a secure wireless network simply by pressing a button. See [Section 12.7.1.1 on page 70](#). This is the easier method.
- **PIN Configuration** - create a secure wireless network simply by entering a wireless client's PIN (Personal Identification Number) in the WAP6806's interface. See [Section 12.7.1.2 on page 71](#). This is the more secure method, since one device can authenticate the other.

12.7.1.1 Push Button Configuration (PBC)

The push button configuration function found in the interface is only available in AP mode. The WPS button, see [Section 1.4 on page 12](#), can also be used for PBC configurations in either AP or Repeater mode.

- 1 Make sure that your WAP6806 is turned on and set to work in AP mode and that it is connected to your network.
- 2 Launch your wireless client's configuration utility.
- 3 In the wireless client utility, find the WPS settings. Enable WPS and press the WPS button (**Start** or **WPS** button).

- 4 Log into the WAP6806's Web Configurator. Make sure WPS is enabled in the **Configuration > Network > Wireless LAN > WPS** screen.
- 5 Navigate to **Configuration > Network > Wireless LAN > WPS** and select the **PBC**.

Note: Your WAP6806 has a WPS button located on its panel, as well as a WPS button in its configuration utility. Both buttons have exactly the same function; you can use one or the other.

Note: It doesn't matter which button is pressed first. You must press the second button within two minutes of pressing the first one.

The WAP6806 sends the proper configuration settings to the wireless client. This may take up to two minutes. Then the wireless client is able to communicate with the WAP6806 securely.

The following figure shows you how to set up wireless network and security by pressing a button on both WAP6806 and wireless client (the NWD-211AN in this example).

Figure 56 Example WPS Process: PBC Method

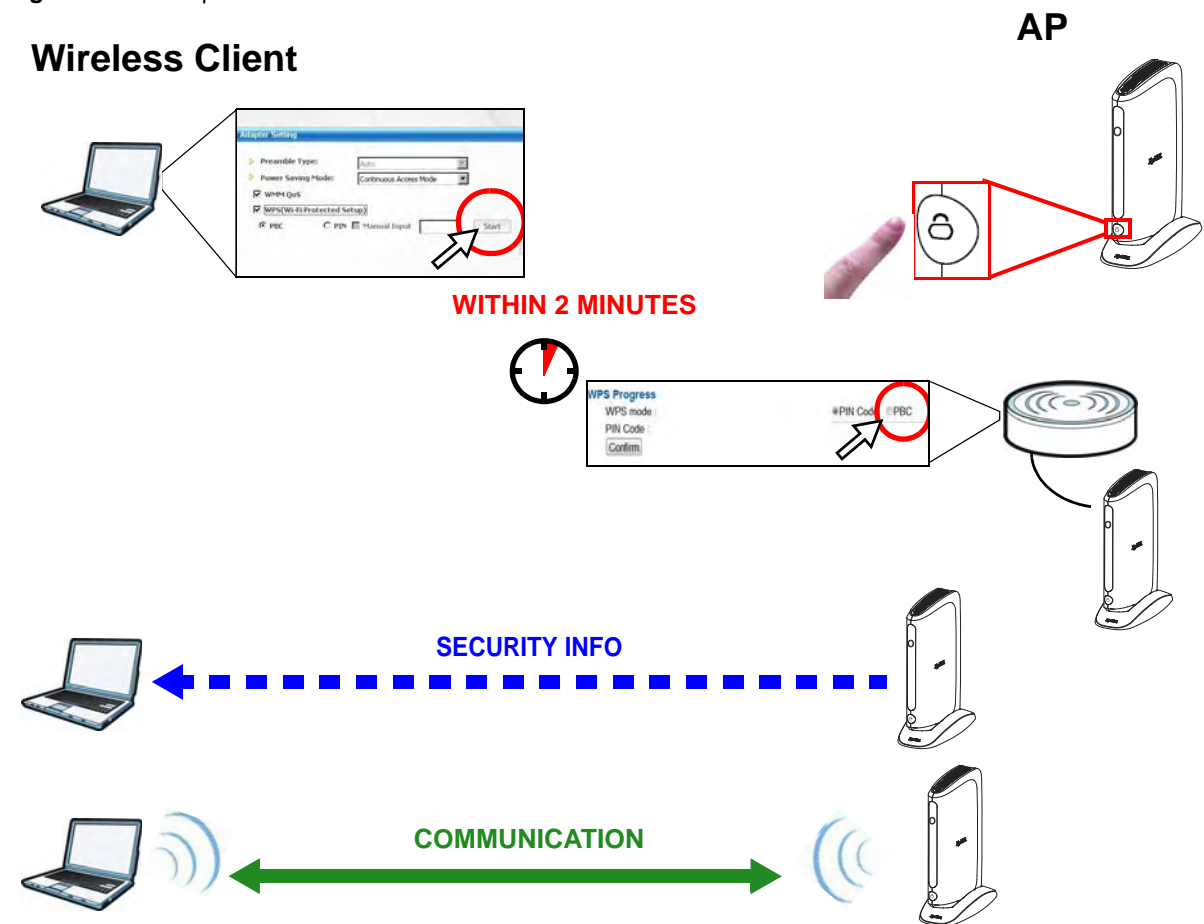

12.7.1.2 PIN Configuration

When you use the PIN configuration method, you need to use both WAP6806's configuration interface and the client's utilities.

The push button configuration function is only available in AP mode.

- 1 Launch your wireless client's configuration utility. Go to the WPS Station settings and select the PIN method to get a PIN number.
- 2 On the WAP6806, navigate to the **Network > Wireless LAN (2.4G/5G) > WPS** screen.
- 3 Obtain the PIN number for the WAP6806 or press the **Generate New PIN** button to create a new PIN number. See [Section 12.7 on page 69](#).
- 4 Enter the WAP6806 PIN number in the wireless station's utility screen.

The WAP6806 authenticates the wireless client and sends the proper configuration settings to the wireless client. This may take up to two minutes. Then the wireless client is able to communicate with the WAP6806 securely.

The following figure shows an example of how to set up wireless network and security on WAP6806 and wireless client (ex. NWD210N in this example) by using PIN method.

Figure 57 Example WPS Process: PIN Method

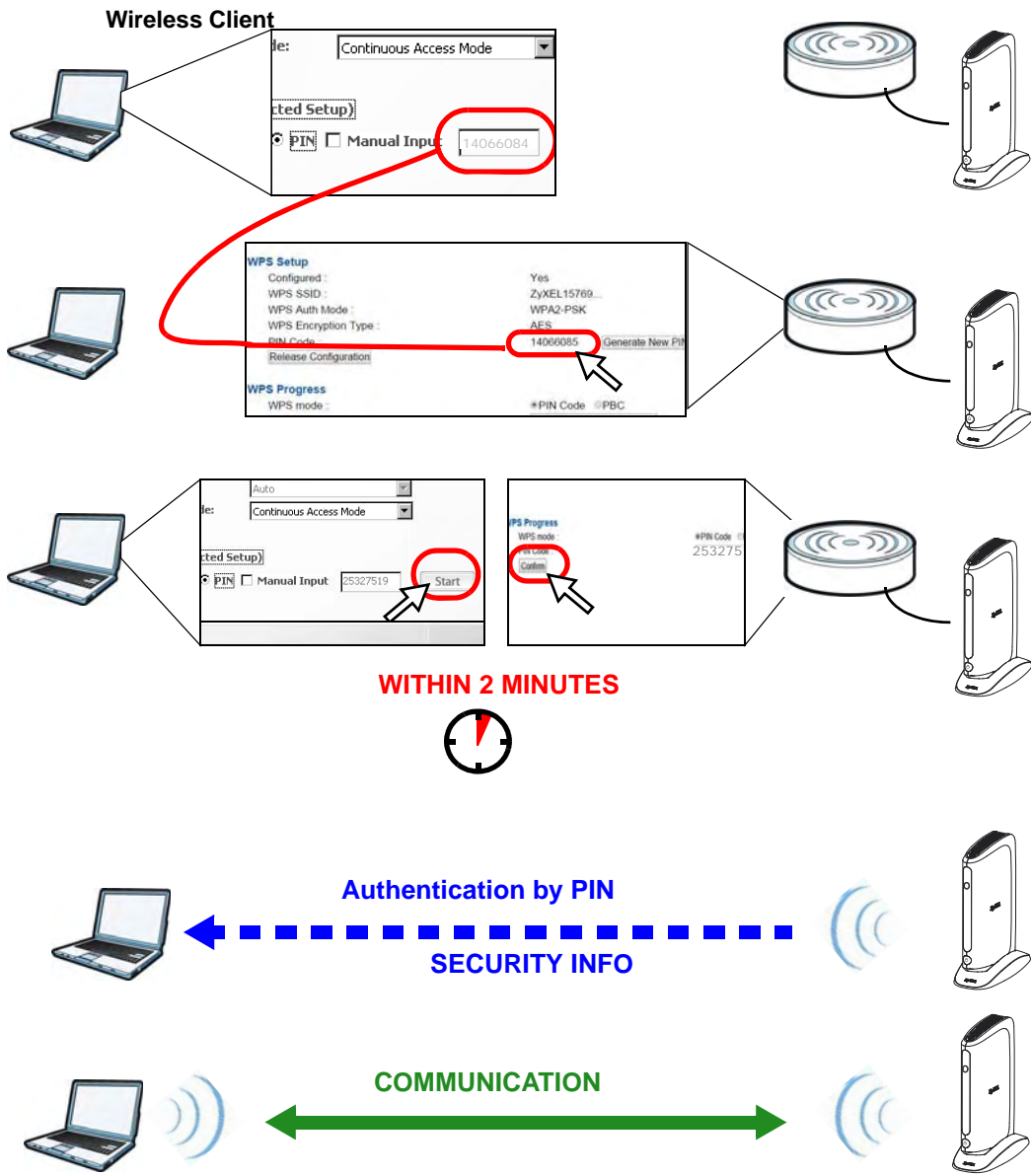

Management

13.1 Overview

This chapter provides information on the **Management** screens.

13.2 What You Can Do

- Use the **MCL** screen ([Section 13.3 on page 74](#)) to enable or disable services access to the WAP6806.
- Use the **One Connect** screen ([Section 13.4 on page 75](#)) to enable or disable the One Connect configuration.

13.3 MCL Screen

Use this screen to enable or disable services access to the WAP6806. Click **Configuration** > **Management** > **MCL**. The following screen displays.

Figure 58 Configuration > Management > MCL

Service Control		
Service Control List		
#	Service Name	Enable
1	HTTP	<input checked="" type="checkbox"/>
2	TELNET	<input type="checkbox"/>
3	ICMP	<input checked="" type="checkbox"/>

The following table describes the labels in this screen.

Table 31 Maintenance > General

LABEL	DESCRIPTION
Service Control List	
#	This is the index number of the service.
Service Name	This displays the service name.
Enable	Select Enable to allow the service to access the WAP6806.
Apply	Click Apply to save your changes.

13.4 One Connect Screen

ZyXEL One Connect app is an easy tool to manage, monitor, and synchronize wireless settings through your mobile devices, such as adding a wireless AP or powerline adapters, configuring guest Wi-Fi settings, or checking the network connection quality, and more. You can apply One Connect to integrate all devices in your home, and don't have turn on your computer or do redundant settings on each network device.

The WAP6806 supports two features through One Connect:

- **Network Map to overview your home network:** With ZyXEL One connect, you can easily and quickly view your connected devices on the network. Change Wi-Fi settings to the home router from the app and realize the utilization of internet bandwidth or even reboot the router if needed.
- **Wi-Fi setting synchronization:** The WAP6806 can automatically synchronize the Wi-Fi settings from the One Connect router.

Click **Configuration > Management > One Connect**.

Figure 59 Configuration > Management > One Connect

The following table describes the labels in this screen.

Table 32 Configuration > Management > One Connect

LABEL	DESCRIPTION
Auto-Configuration	Select Enable or Disable to activate/inactivate the One Connect function.
Confirm	Click Confirm to save your changes.
Reset	Click Reset to reload the previous configuration for this screen.

Maintenance

14.1 Overview

This chapter provides information on the **Maintenance** screen.

14.2 What You Can Do

- Use the **System** screens to set the password and configure time and date of your WAP6806 ([Section 14.3 on page 76](#)).
- Use the **Firmware Upgrade** screen to update firmware ([Section 14.4 on page 78](#)).
- Use the **Backup/Restore** screen to backup and restore device configurations ([Section 14.5 on page 80](#)).
- Use the **Reboot** screen to restart your WAP6806 ([Section 14.6 on page 82](#)).

14.3 System

Use the **System** screens to set the password and configure time and date of your WAP6806.

14.3.1 General Screen

It is strongly recommended that you change your WAP6806's password. Use this screen to set the web configurator password. Click **Maintenance > System > General**. The following screen displays.

Figure 60 Maintenance > System > General

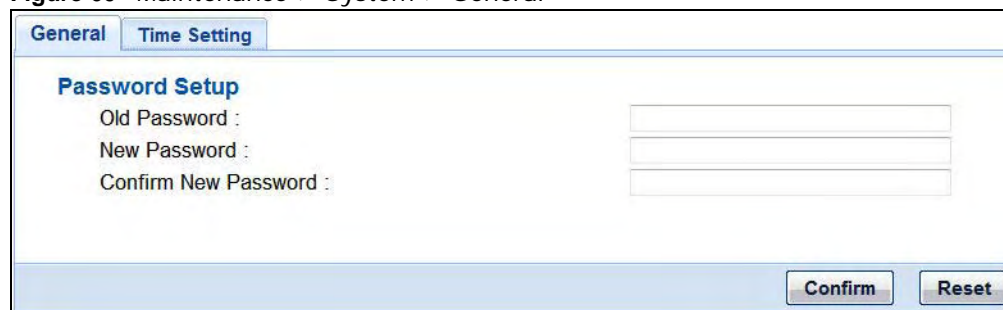

The screenshot shows a web interface for password setup. At the top, there are two tabs: 'General' (selected) and 'Time Setting'. Below the tabs, the title 'Password Setup' is displayed. There are three input fields: 'Old Password', 'New Password', and 'Confirm New Password'. At the bottom right, there are two buttons: 'Confirm' and 'Reset'.

The following table describes the labels in this menu.

Table 33 Maintenance > System > General

LABEL	DESCRIPTION
Old Password	Type the default password or the existing password you use to access the system in this field.
New Password	Type your new system password (up to 30 characters).
Confirm New Password	Type the new password again in this field.
Confirm	Click Confirm to save your changes.
Reset	Click Reset to reload the previous configuration for this screen.

14.3.2 Time Setting Screen

Use this screen to configure the WAP6806's time based on your local time zone. To change your WAP6806's time and date, click **Maintenance > System > Time Setting**. The screen appears as shown.

Figure 61 Maintenance > System > Time Setting

The following table describes the labels in this menu.

Table 34 Maintenance > System > Time Setting

LABEL	DESCRIPTION
Current Time and Date	
Current Time	This field displays the current time and date of your WAP6806.
NTP Server	
NTP Server IP Address 1	Enter the IP address or URL of an available time server and synchronize the date and time with the time server.
NTP Server IP Address 2	Enter the IP address or URL of an available time server and synchronize the date and time with the time server.
Time Zone Setting	

Table 34 Maintenance > System > Time Setting (continued)

LABEL	DESCRIPTION
Time Zone	Choose the time zone of your location. This will set the time difference between your time zone and Greenwich Mean Time (GMT).
Daylight Saving	
Daylight Saving	Daylight saving is a period from late spring to fall when many countries set their clocks ahead of normal local time by one hour to give more daytime light in the evening. Select Enable if you use Daylight Saving Time.
Start Day	Configure the date when Daylight Saving Time starts.
End Day	Configure the date when Daylight Saving Time ends.
Confirm	Click Confirm to save your changes.
Reset	Click Reset to reload the previous configuration for this screen.

14.4 Firmware Upgrade Screen

Find firmware at www.zyxel.com in a file that (usually) uses the system model name with a “*.bin” extension, e.g., “WAP6806.bin”. The upload process uses HTTP (Hypertext Transfer Protocol) and may take up to two minutes. After a successful upload, the system will reboot.

Click **Maintenance > Firmware Upgrade**. Follow the instructions in this screen to upgrade firmware to your WAP6806.

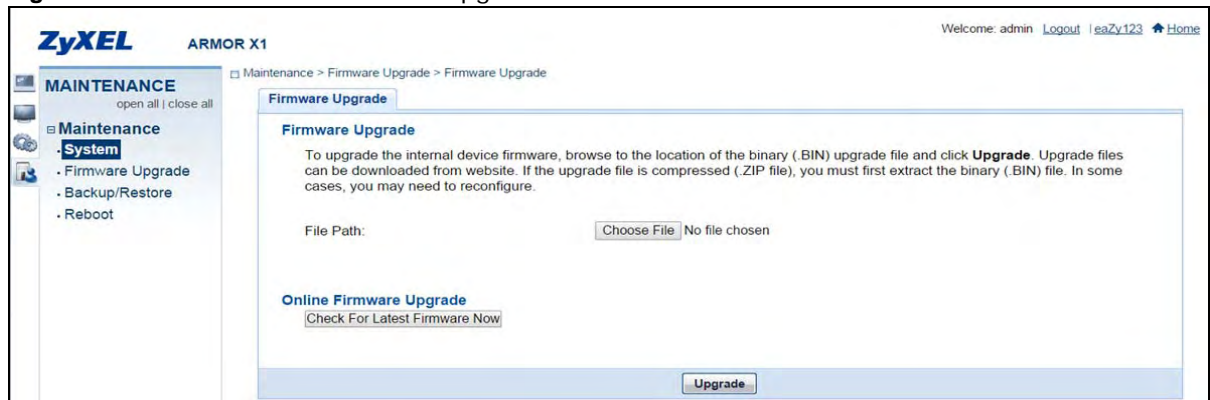
Figure 62 Maintenance > Firmware Upgrade

The following table describes the labels in this screen.

Table 35 Maintenance > Firmware Upgrade

LABEL	DESCRIPTION
Firmware Upgrade	
Choose File	Click Choose File to find the .bin file you want to upload. Remember that you must decompress compressed (.zip) files before you can upload them.
Online Firmware Upgrade	

Table 35 Maintenance > Firmware Upgrade (continued)

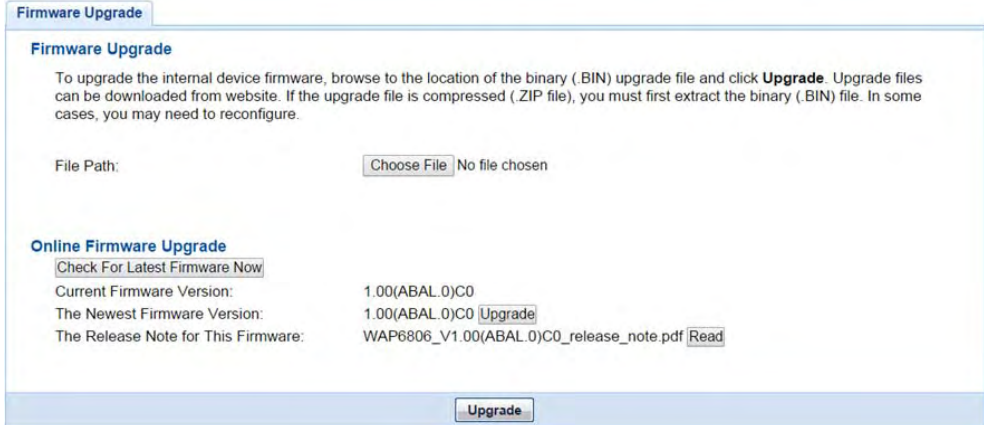
LABEL	DESCRIPTION
Check for Latest Firmware Now	<p>The following fields display when you click this button.</p>  <p>The screenshot shows the 'Firmware Upgrade' section with instructions to browse for a .BIN file. Below is a 'File Path:' field with a 'Choose File' button and 'No file chosen' text. The 'Online Firmware Upgrade' section includes a 'Check For Latest Firmware Now' button, 'Current Firmware Version: 1.00(ABAL.0)C0', 'The Newest Firmware Version: 1.00(ABAL.0)C0 Upgrade', and 'The Release Note for This Firmware: WAP6806_V1.00(ABAL.0)C0_release_note.pdf Read'. An 'Upgrade' button is at the bottom.</p>
Current Firmware Version	The firmware version consists of the trunk version number, model code, and release number. For example, V1.00(ABAL.0) means V1.00 is the trunk number, ABAL represents WAP6806, and 0 means the fifth release.
The Newest Firmware Version	Compare the release number in the previous field with the release number in this one to see if you have the latest firmware. In this example, V1.00(ABAL.0), the numbers are the same (0), so the WAP6806 already has the latest firmware. If the current firmware version is not the same as the newest firmware version, click Upgrade to upgrade the firmware.
The Release Note for This Version	The release note shows what has changed (new features, bug fixes, known issues) in this firmware version. Check Read before deciding to use new firmware.
Upgrade	Click this button to download and upgrade the new firmware to the WAP6806.

If the WAP6806 cannot connect to the online server, the screen displays as below.



If the firmware version of your WAP6806 is not the latest one, the screen displays as below.



Note: Do not turn off the WAP6806 while firmware upload is in progress!

After you see the **Firmware Upgrading** screen, wait until the upgrade process is complete.

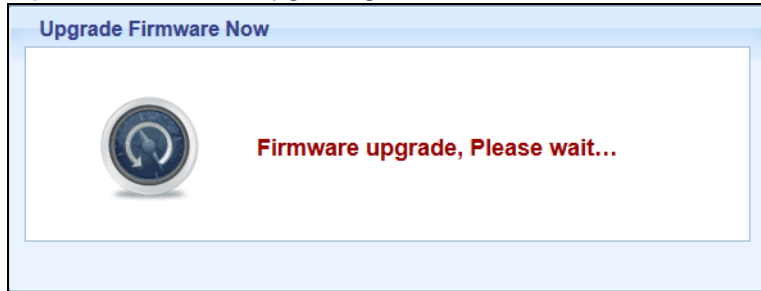
Figure 63 Firmware Upgrading

The WAP6806 automatically restarts in this time causing a temporary network disconnect. In some operating systems, you may see the following icon on your desktop.

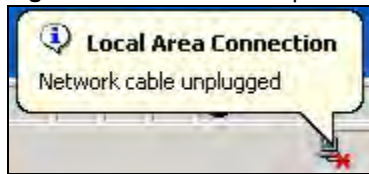
Figure 64 Network Temporarily Disconnected

After the WAP6806 restarts, the **Upgrade Accomplished** screen appears.

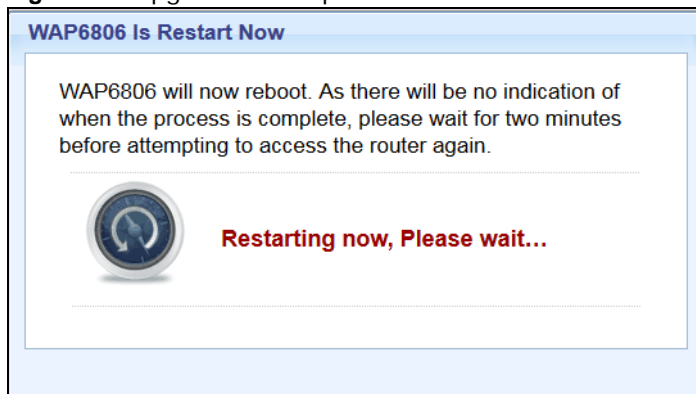
Figure 65 Upgrade Accomplished

Refresh the web page and log in again and check your new firmware version in the **Status** screen.

14.5 Backup / Restore Screen

Click **Maintenance > Backup/Restore**. Information related to factory defaults, backup configuration, and restoring configuration appears as shown next.

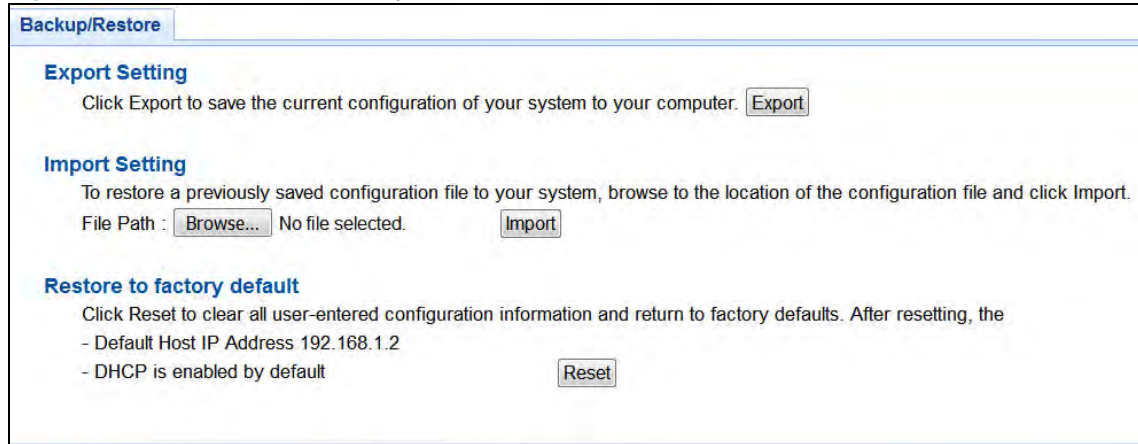
Figure 66 Maintenance > Backup/Restore

14.5.1 Export Setting

Export setting allows you to back up (save) the WAP6806's current configuration to a file on your computer. Once your WAP6806 is configured and functioning properly, it is highly recommended that you back up your configuration file before making configuration changes. The backup configuration file will be useful in case you need to return to your previous settings.

Click **Export** to save the WAP6806's current configuration to your computer.

14.5.2 Import Setting

Import setting allows you to upload a new or previously saved configuration file from your computer to your WAP6806.

Table 36 Maintenance Restore Configuration

LABEL	DESCRIPTION
Browse...	Click Browse... to find the file you want to upload. Remember that you must decompress compressed (.ZIP) files before you can upload them.
Import	Click Import to begin the import process.

Note: Do not turn off the WAP6806 while configuration file import is in progress.

After you see a "configuration upload successful" screen, you must then wait one minute before logging into the WAP6806 again.

The WAP6806 automatically restarts in this time causing a temporary network disconnect. In some operating systems, you may see the following icon on your desktop.

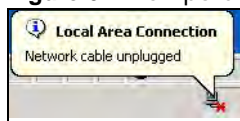
Figure 67 Temporarily Disconnected

If you uploaded the default configuration file you may need to change the IP address of your computer to be in the same subnet as that of the default WAP6806 IP address (192.168.1.2). Refer to your operating system's help files for details on how to set up your computer's IP address.

14.5.3 Restore to Factory Defaults

Click **Reset** to clear all user-entered configuration information and returns the WAP6806 to its factory defaults.

You can also press the **Reset** button on the rear panel to reset the factory defaults of your WAP6806.

14.6 Reboot

System reboot allows you to restart the WAP6806 without turning the power off. Click **Maintenance > Reboot** to open the following screen.

Figure 68 Maintenance > Reboot

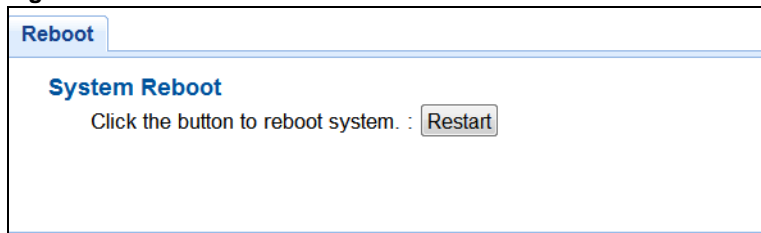

Click **Restart** to have the WAP6806 reboot. This does not affect the WAP6806's configuration.

Troubleshooting

This chapter offers some suggestions to solve problems you might encounter. The potential problems are divided into the following categories.

- [Power, Hardware Connections, and LED](#)
- [WAP6806 Access and Login](#)
- [Internet Access](#)
- [Resetting the WAP6806 to Its Factory Defaults](#)
- [Wireless Problems](#)

15.1 Power, Hardware Connections, and LED

The WAP6806 does not turn on. The LED does not turn on.

- 1 Make sure the WAP6806 is plugged in to an appropriate power source. Make sure the power source is turned on.
- 2 Disconnect and re-connect the power adaptor or cord to the WAP6806.
- 3 If the problem continues, contact the vendor.

The LED does not behave as expected.

- 1 Make sure you understand the normal behavior of the LED. See [Table 1 on page 11](#).
- 2 Check the hardware connections. See the Quick Start Guide.
- 3 Inspect your cables for damage. Contact the vendor to replace any damaged cables.
- 4 Disconnect and re-connect the power adaptor to the WAP6806.
- 5 If the problem continues, contact the vendor.

15.2 WAP6806 Access and Login

I forgot the password.

- 1 The default password is **1234**.
- 2 If this does not work, you have to reset the device to its factory defaults. See [Section 14.5.3 on page 82](#).

I cannot see or access the **Login** screen in the Web Configurator.

- 1 Make sure you are using the correct address.
 - The default web address (URL) of the WAP6806 is **http://zyxelsetup** or **http://192.168.1.2**.
- 2 Check the hardware connections, and make sure the LEDs are behaving as expected. See the Quick Start Guide.
- 3 Make sure your Internet browser does not block pop-up windows and has JavaScript and Java enabled.
- 4 Reset the device to its factory defaults, and try to access the WAP6806 with the default address.
- 5 If the problem continues, contact the network administrator or vendor, or try one of the advanced suggestions.

Advanced Suggestions

- If your computer is connected wirelessly, use a computer that is connected to a **ETHERNET** port.

I can see the **Login** screen, but I cannot log in to the WAP6806.

- 1 Make sure you have entered the password correctly. The default password is **1234**.
- 2 This can happen when you fail to log out properly from your last session. Try logging in again after 5 minutes.
- 3 Disconnect and re-connect the power adaptor or cord to the WAP6806.
- 4 If this does not work, you have to reset the device to its factory defaults. See [Section 15.4 on page 86](#).

15.3 Internet Access

I cannot access the Internet.

- 1 Check the hardware connections, and make sure the LEDs are behaving as expected. See the Quick Start Guide.
- 2 Try to connect directly to the AP. If you can access the Internet, check that the WAP6806 has associated with the AP by checking the **WLAN STA Information** SSID field shows the SSID of the AP. See [Section 12.4 on page 63](#).
- 3 If you are trying to access the Internet wirelessly, make sure the wireless settings in the wireless client are the same as the settings in the AP.
- 4 Disconnect all the cables from your device, and follow the directions in the Quick Start Guide again.
- 5 If the problem continues, contact your ISP.

I cannot access the Internet anymore. I had access to the Internet (with the WAP6806), but my Internet connection is not available anymore.

- 1 Check the hardware connections, and make sure the LEDs are behaving as expected. See the Quick Start Guide and [Table 1 on page 11](#).
- 2 Reboot the WAP6806.
- 3 Try to connect directly to the AP. If you can access the Internet, check that the WAP6806 has associated with the AP by checking the **WLAN STA Information** SSID field shows the SSID of the AP. See [Section 12.4 on page 63](#).
- 4 If the problem continues, contact your ISP.

The Internet connection is slow or intermittent.

- 1 There might be a lot of traffic on the network. Look at the LEDs, and check [Table 2 on page 11](#). If the WAP6806 is sending or receiving a lot of information, try closing some programs that use the Internet, especially peer-to-peer applications.
- 2 Check the signal strength. If the signal strength is low, try moving the WAP6806 closer to the AP if possible, and look around to see if there are any devices that might be interfering with the wireless network (for example, microwaves, other wireless networks, and so on).
- 3 Reboot the WAP6806.

- 4 If the problem continues, contact the network administrator or vendor, or try one of the advanced suggestions.

Advanced Suggestion

- Check the settings for QoS. If it is disabled, you might consider activating it.

15.4 Resetting the WAP6806 to Its Factory Defaults

If you reset the WAP6806, you lose all of the changes you have made. The WAP6806 re-loads its default settings, and the password resets to **1234**. You have to make all of your changes again.

You will lose all of your changes when you reset the WAP6806 to its factory defaults.

To reset the WAP6806,

- 1 Make sure the power LED is on.
- 2 Press the **RESET** button for longer than 10 seconds, the Power LED begins to blink, to set the WAP6806 back to its factory-default configuration.

OR

- 3 Click **Maintenance > Backup/Restore > Restore** and then click **Reset**.

If the WAP6806 restarts automatically, wait for the WAP6806 to finish restarting, and log in to the Web Configurator. The password is **1234**.

If the WAP6806 does not restart automatically, disconnect and reconnect the WAP6806's power. Then, follow the directions above again.

15.5 Wireless Problems

I cannot access the WAP6806 or ping any computer from the WLAN.

- 1 Make sure the wireless LAN is enabled on the WAP6806.
- 2 Make sure the wireless adapter on the wireless station is working properly.
- 3 Make sure the wireless adapter installed on your computer is IEEE 802.11 compatible and supports the same wireless standard as the WAP6806.
- 4 Make sure your computer (with a wireless adapter installed) is within the transmission range of the WAP6806.

- 5 Check that both the WAP6806 and your wireless station are using the same wireless and wireless security settings, and that both the WAP6806 and the AP are using the same wireless and wireless security settings.

Customer Support

In the event of problems that cannot be solved by using this manual, you should contact your vendor. If you cannot contact your vendor, then contact a ZyXEL office for the region in which you bought the device.

See <http://www.zyxel.com/homepage.shtml> and also

http://www.zyxel.com/about_zyxel/zyxel_worldwide.shtml for the latest information.

Please have the following information ready when you contact an office.

Required Information

- Product model and serial number.
- Warranty Information.
- Date that you received your device.
- Brief description of the problem and the steps you took to solve it.

Corporate Headquarters (Worldwide)

Taiwan

- ZyXEL Communications Corporation
- <http://www.zyxel.com>

Asia

China

- ZyXEL Communications (Shanghai) Corp.
- ZyXEL Communications (Beijing) Corp.
- ZyXEL Communications (Tianjin) Corp.
- <http://www.zyxel.cn>

India

- ZyXEL Technology India Pvt Ltd
- <http://www.zyxel.in>

Kazakhstan

- ZyXEL Kazakhstan

- <http://www.zyxel.kz>

Korea

- ZyXEL Korea Corp.
- <http://www.zyxel.kr>

Malaysia

- ZyXEL Malaysia Sdn Bhd.
- <http://www.zyxel.com.my>

Pakistan

- ZyXEL Pakistan (Pvt.) Ltd.
- <http://www.zyxel.com.pk>

Philippines

- ZyXEL Philippines
- <http://www.zyxel.com.ph>

Singapore

- ZyXEL Singapore Pte Ltd.
- <http://www.zyxel.com.sg>

Taiwan

- ZyXEL Communications Corporation
- <http://www.zyxel.com/tw/zh/>

Thailand

- ZyXEL Thailand Co., Ltd
- <http://www.zyxel.co.th>

Vietnam

- ZyXEL Communications Corporation-Vietnam Office
- <http://www.zyxel.com/vn/vi>

Europe

Austria

- ZyXEL Deutschland GmbH
- <http://www.zyxel.de>

Belarus

- ZyXEL BY
- <http://www.zyxel.by>

Belgium

- ZyXEL Communications B.V.
- <http://www.zyxel.com/be/nl/>
- <http://www.zyxel.com/be/fr/>

Bulgaria

- ZyXEL България
- <http://www.zyxel.com/bg/bg/>

Czech Republic

- ZyXEL Communications Czech s.r.o
- <http://www.zyxel.cz>

Denmark

- ZyXEL Communications A/S
- <http://www.zyxel.dk>

Estonia

- ZyXEL Estonia
- <http://www.zyxel.com/ee/et/>

Finland

- ZyXEL Communications
- <http://www.zyxel.fi>

France

- ZyXEL France
- <http://www.zyxel.fr>

Germany

- ZyXEL Deutschland GmbH
- <http://www.zyxel.de>

Hungary

- ZyXEL Hungary & SEE
- <http://www.zyxel.hu>

Italy

- ZyXEL Communications Italy
- <http://www.zyxel.it/>

Latvia

- ZyXEL Latvia
- <http://www.zyxel.com/lv/lv/homepage.shtml>

Lithuania

- ZyXEL Lithuania
- <http://www.zyxel.com/lt/lt/homepage.shtml>

Netherlands

- ZyXEL Benelux
- <http://www.zyxel.nl>

Norway

- ZyXEL Communications
- <http://www.zyxel.no>

Poland

- ZyXEL Communications Poland
- <http://www.zyxel.pl>

Romania

- ZyXEL Romania
- <http://www.zyxel.com/ro/ro>

Russia

- ZyXEL Russia
- <http://www.zyxel.ru>

Slovakia

- ZyXEL Communications Czech s.r.o. organizacna zlozka
- <http://www.zyxel.sk>

Spain

- ZyXEL Communications ES Ltd
- <http://www.zyxel.es>

Sweden

- ZyXEL Communications

- <http://www.zyxel.se>

Switzerland

- Studerus AG
- <http://www.zyxel.ch/>

Turkey

- ZyXEL Turkey A.S.
- <http://www.zyxel.com.tr>

UK

- ZyXEL Communications UK Ltd.
- <http://www.zyxel.co.uk>

Ukraine

- ZyXEL Ukraine
- <http://www.ua.zyxel.com>

Latin America

Argentina

- ZyXEL Communication Corporation
- <http://www.zyxel.com/ec/es/>

Brazil

- ZyXEL Communications Brasil Ltda.
- <https://www.zyxel.com/br/pt/>

Ecuador

- ZyXEL Communication Corporation
- <http://www.zyxel.com/ec/es/>

Middle East

Israel

- ZyXEL Communication Corporation
- <http://il.zyxel.com/homepage.shtml>

Middle East

- ZyXEL Communication Corporation

- <http://www.zyxel.com/me/en/>

North America

USA

- ZyXEL Communications, Inc. - North America Headquarters
- <http://www.zyxel.com/us/en/>

Oceania

Australia

- ZyXEL Communications Corporation
- <http://www.zyxel.com/au/en/>

Africa

South Africa

- Nology (Pty) Ltd.
- <http://www.zyxel.co.za>

Setting Up Your Computer's IP Address

Note: Your specific WAP6806 may not support all of the operating systems described in this appendix. See the product specifications for more information about which operating systems are supported.

This appendix shows you how to configure the IP settings on your computer in order for it to be able to communicate with the other devices on your network. Windows Vista/XP/2000, Mac OS 9/OS X, and all versions of UNIX/LINUX include the software components you need to use TCP/IP on your computer.

If you manually assign IP information instead of using a dynamic IP, make sure that your network's computers have IP addresses that place them in the same subnet.

In this appendix, you can set up an IP address for:

- [Windows XP/NT/2000](#) on [page 94](#)
- [Windows Vista](#) on [page 98](#)
- [Windows 7](#) on [page 102](#)
- [Mac OS X: 10.3 and 10.4](#) on [page 106](#)
- [Mac OS X: 10.5 and 10.6](#) on [page 109](#)
- [Linux: Ubuntu 8 \(GNOME\)](#) on [page 112](#)
- [Linux: openSUSE 10.3 \(KDE\)](#) on [page 116](#)

Windows XP/NT/2000

The following example uses the default Windows XP display theme but can also apply to Windows 2000 and Windows NT.

- 1 Click **Start** > **Control Panel**.

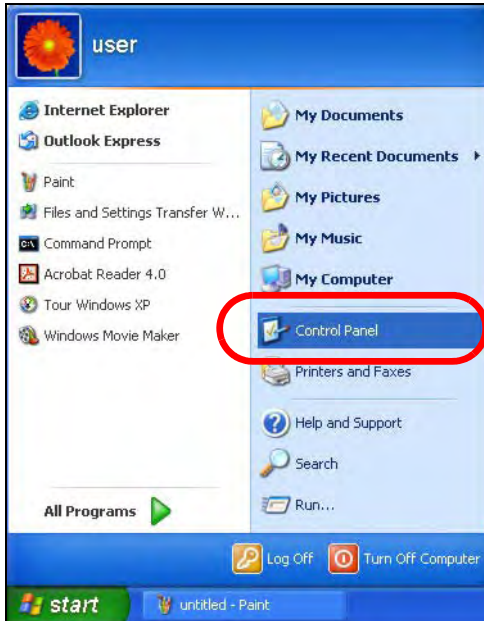

- 2 In the **Control Panel**, click the **Network Connections** icon.



- 3 Right-click **Local Area Connection** and then select **Properties**.

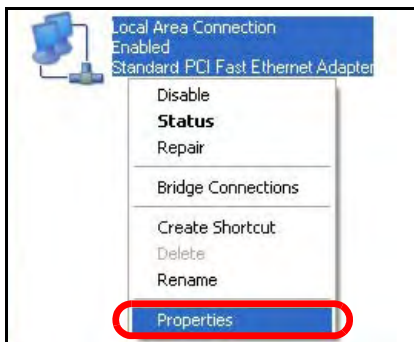

- 4 On the **General** tab, select **Internet Protocol (TCP/IP)** and then click **Properties**.

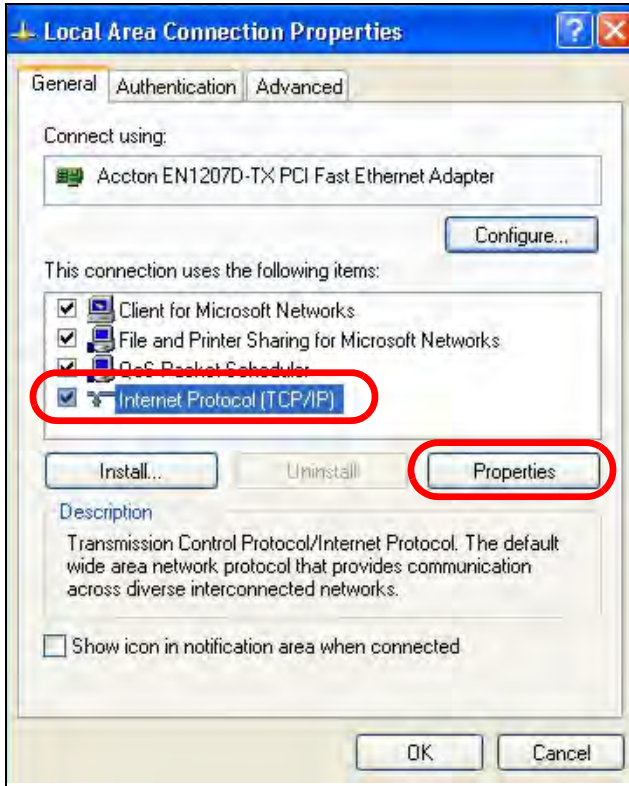

- 5 The **Internet Protocol TCP/IP Properties** window opens.

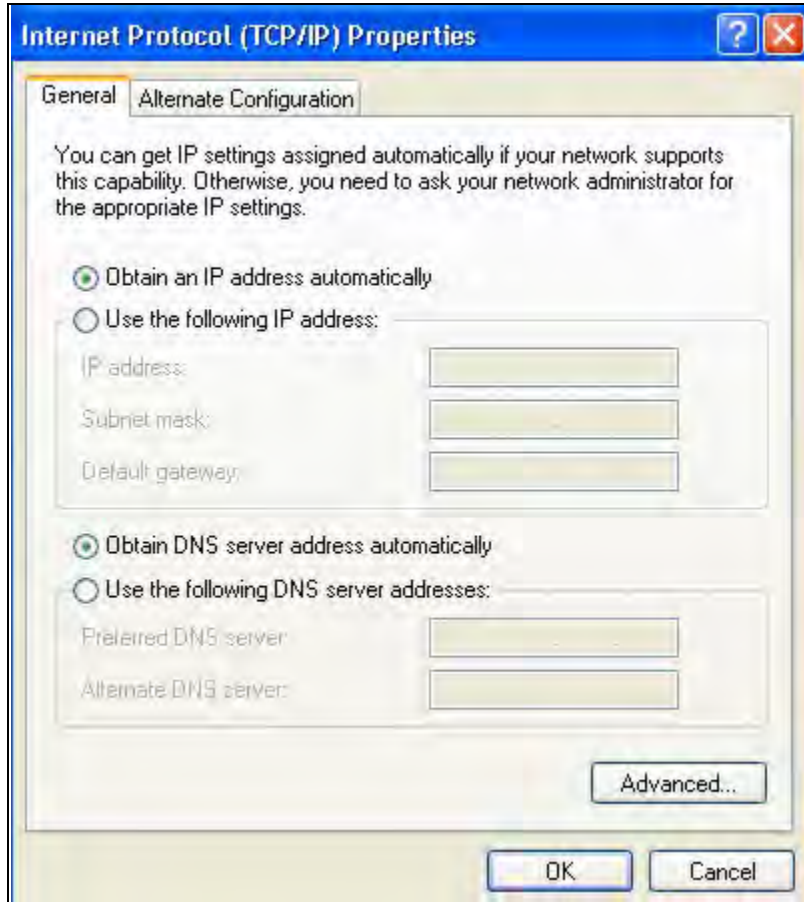

- 6 Select **Obtain an IP address automatically** if your network administrator or ISP assigns your IP address dynamically.
Select **Use the following IP Address** and fill in the **IP address**, **Subnet mask**, and **Default gateway** fields if you have a static IP address that was assigned to you by your network administrator or ISP. You may also have to enter a **Preferred DNS server** and an **Alternate DNS server**, if that information was provided.
- 7 Click **OK** to close the **Internet Protocol (TCP/IP) Properties** window.
- 8 Click **OK** to close the **Local Area Connection Properties** window.

Verifying Settings

- 1 Click **Start > All Programs > Accessories > Command Prompt**.
- 2 In the **Command Prompt** window, type "ipconfig" and then press [ENTER].
You can also go to **Start > Control Panel > Network Connections**, right-click a network connection, click **Status** and then click the **Support** tab to view your IP address and connection information.

Windows Vista

This section shows screens from Windows Vista Professional.

- 1 Click **Start > Control Panel**.

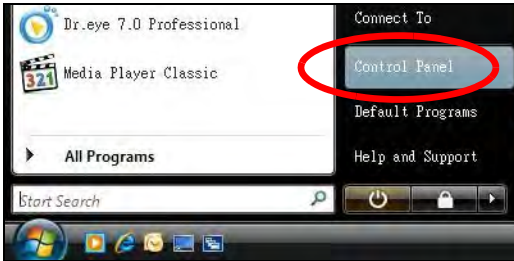

- 2 In the **Control Panel**, click the **Network and Internet** icon.

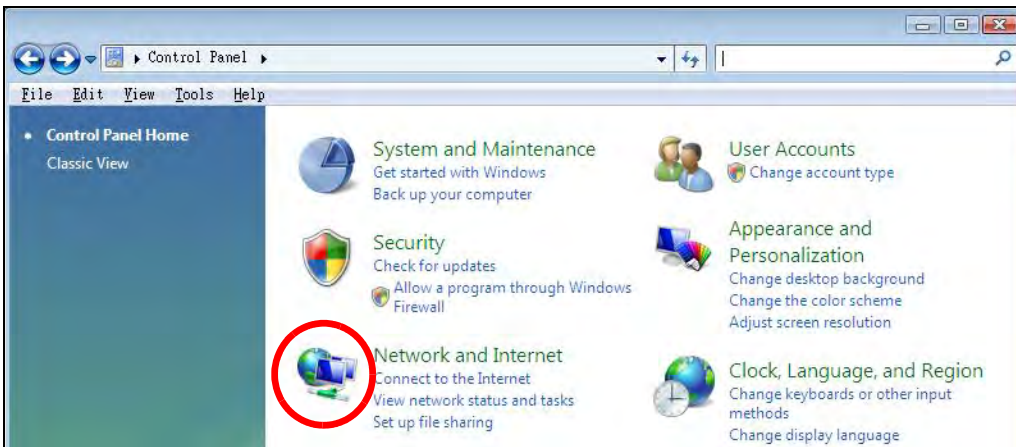

- 3 Click the **Network and Sharing Center** icon.



- 4 Click **Manage network connections**.

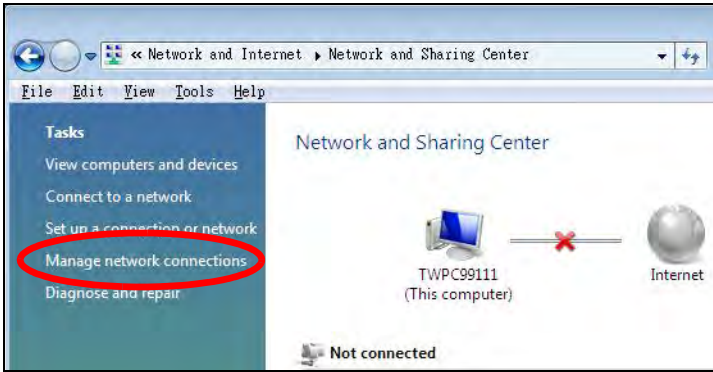

- 5 Right-click **Local Area Connection** and then select **Properties**.

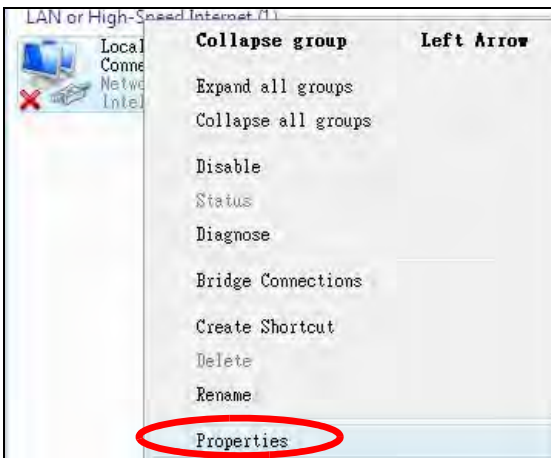

Note: During this procedure, click **Continue** whenever Windows displays a screen saying that it needs your permission to continue.

- 6 Select **Internet Protocol Version 4 (TCP/IPv4)** and then select **Properties**.

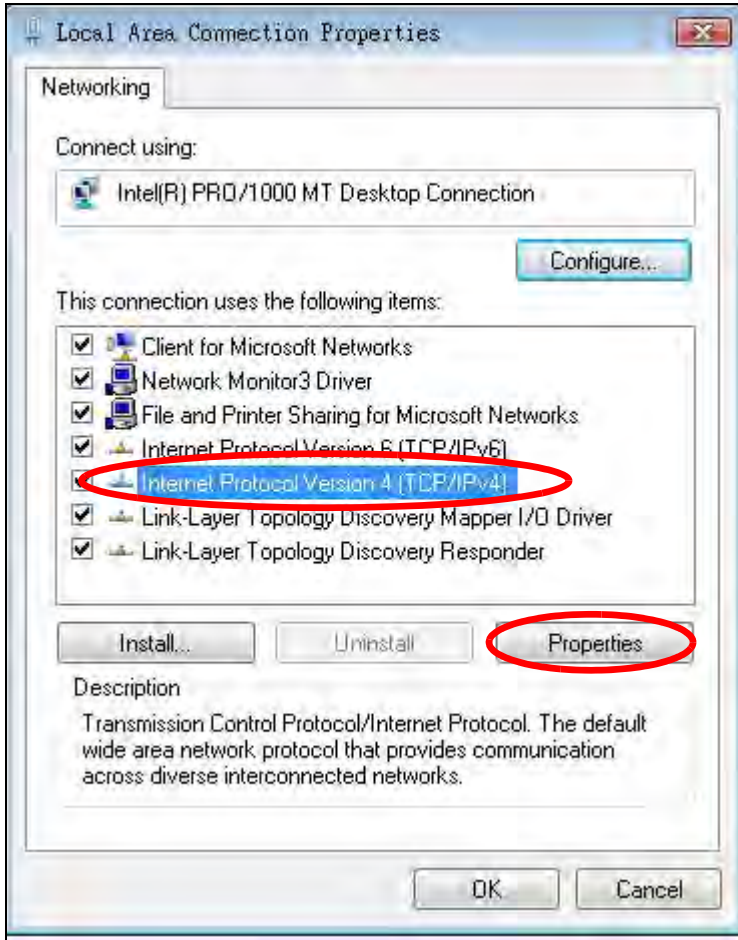

- 7 The **Internet Protocol Version 4 (TCP/IPv4) Properties** window opens.



- 8 Select **Obtain an IP address automatically** if your network administrator or ISP assigns your IP address dynamically.

Select **Use the following IP Address** and fill in the **IP address**, **Subnet mask**, and **Default gateway** fields if you have a static IP address that was assigned to you by your network administrator or ISP. You may also have to enter a **Preferred DNS server** and an **Alternate DNS server**, if that information was provided. Click **Advanced**.

- 9 Click **OK** to close the **Internet Protocol (TCP/IP) Properties** window.
- 10 Click **OK** to close the **Local Area Connection Properties** window.

Verifying Settings

- 1 Click **Start > All Programs > Accessories > Command Prompt**.
- 2 In the **Command Prompt** window, type "ipconfig" and then press [ENTER].

You can also go to **Start > Control Panel > Network Connections**, right-click a network connection, click **Status** and then click the **Support** tab to view your IP address and connection information.

Windows 7

This section shows screens from Windows 7 Enterprise.

- 1 Click **Start > Control Panel**.

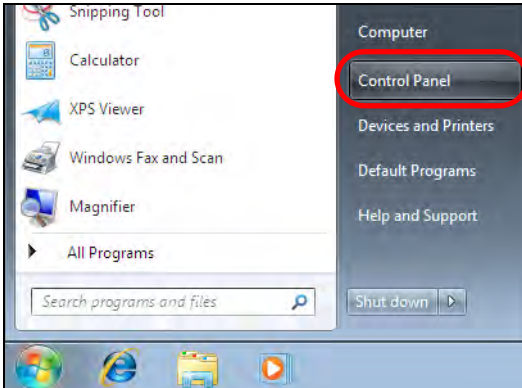

- 2 In the **Control Panel**, click **View network status and tasks** under the **Network and Internet** category.

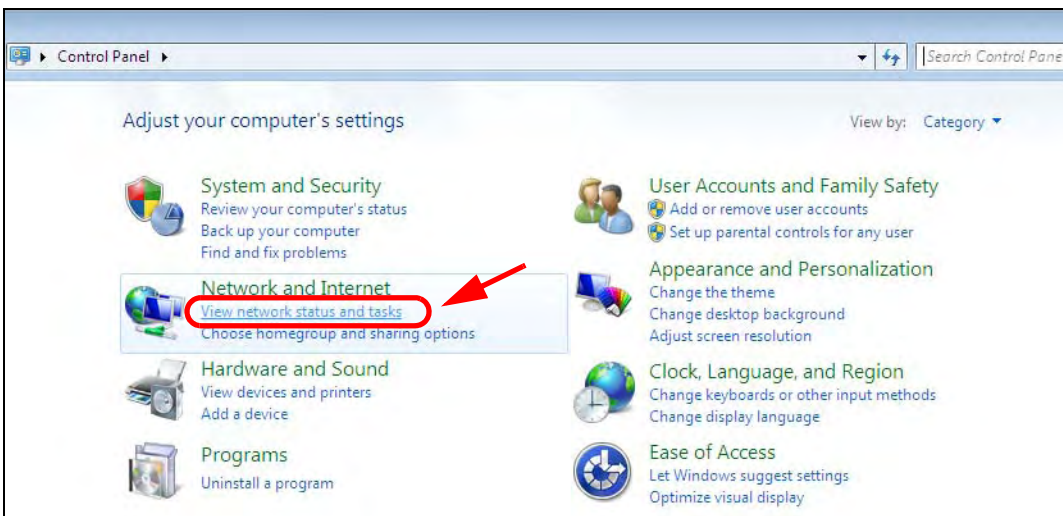

- 3 Click **Change adapter settings**.

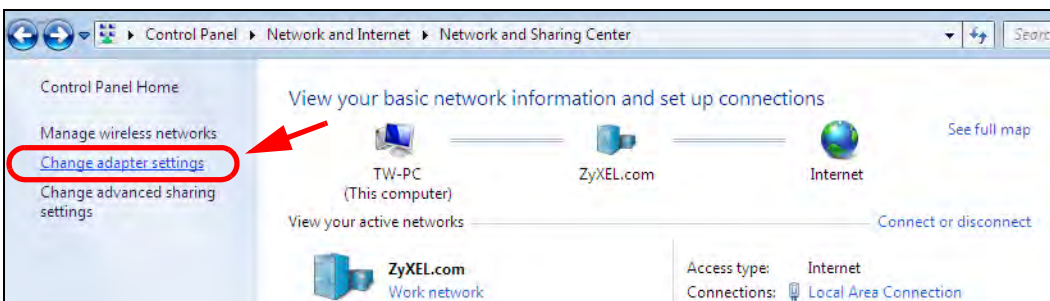

- 4 Double click **Local Area Connection** and then select **Properties**.

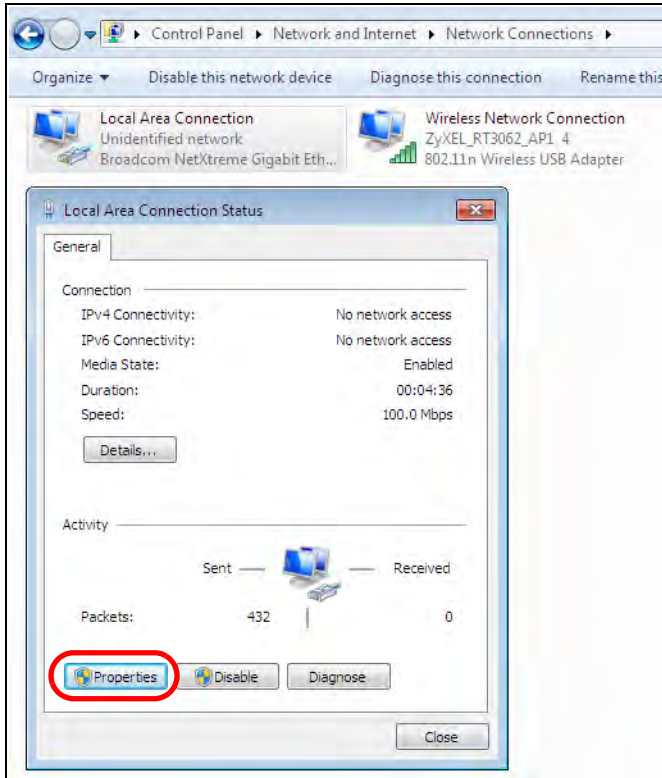

Note: During this procedure, click **Continue** whenever Windows displays a screen saying that it needs your permission to continue.

- 5 Select **Internet Protocol Version 4 (TCP/IPv4)** and then select **Properties**.

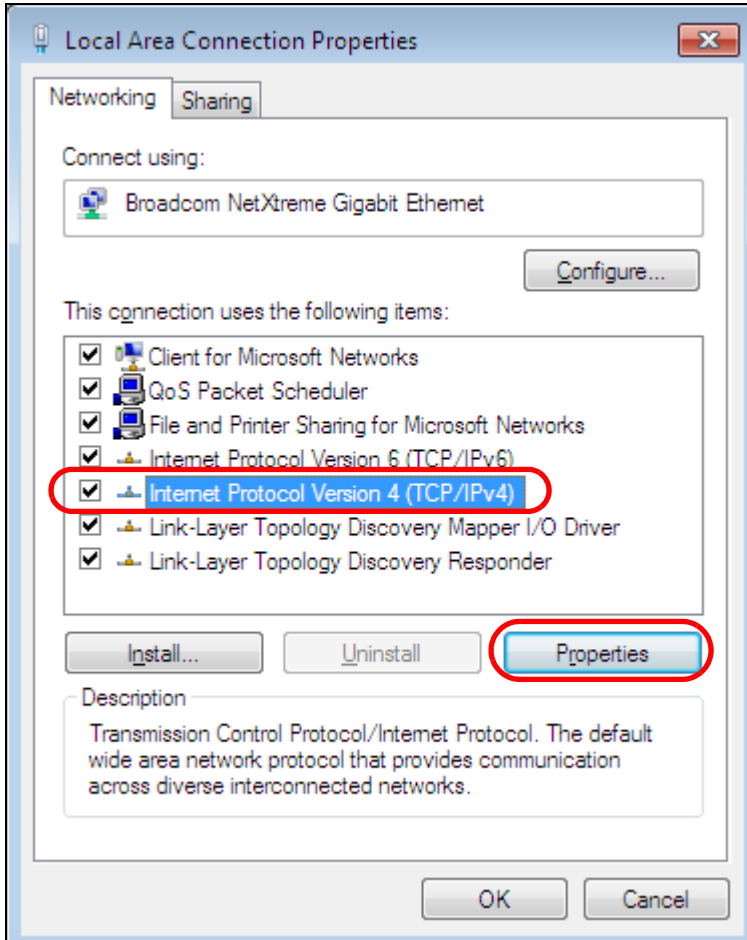

6 The **Internet Protocol Version 4 (TCP/IPv4) Properties** window opens.

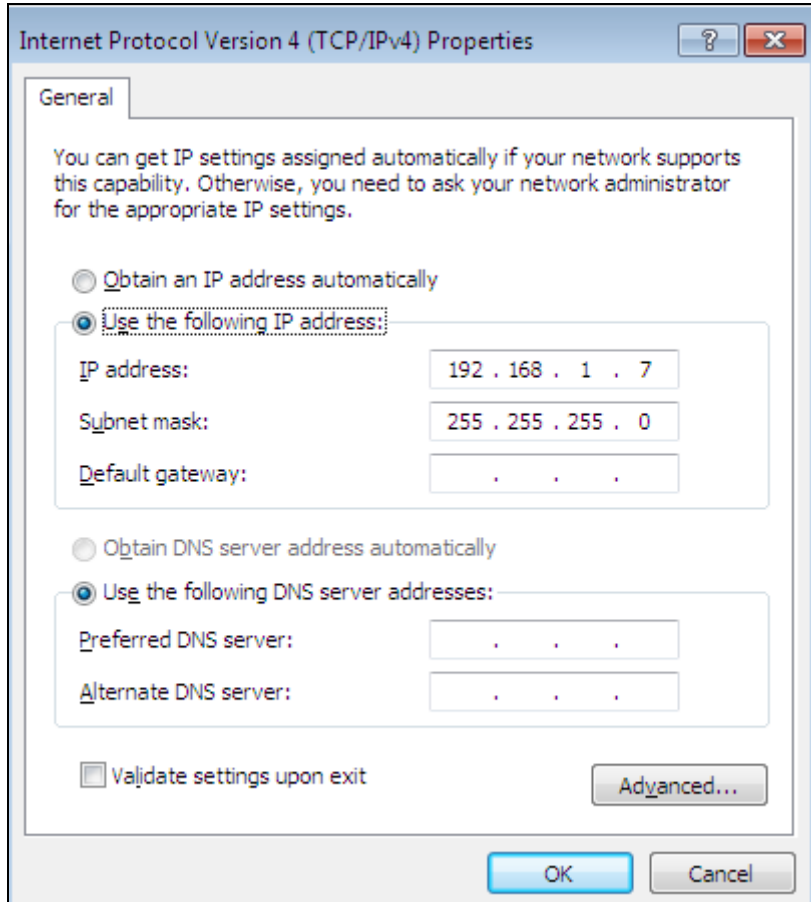

- 7 Select **Obtain an IP address automatically** if your network administrator or ISP assigns your IP address dynamically.

Select **Use the following IP Address** and fill in the **IP address**, **Subnet mask**, and **Default gateway** fields if you have a static IP address that was assigned to you by your network administrator or ISP. You may also have to enter a **Preferred DNS server** and an **Alternate DNS server**, if that information was provided. Click **Advanced** if you want to configure advanced settings for IP, DNS and WINS.

- 8 Click **OK** to close the **Internet Protocol (TCP/IP) Properties** window.
- 9 Click **OK** to close the **Local Area Connection Properties** window.

Verifying Settings

- 1 Click **Start > All Programs > Accessories > Command Prompt**.
- 2 In the **Command Prompt** window, type "ipconfig" and then press [ENTER].
- 3 The IP settings are displayed as follows.

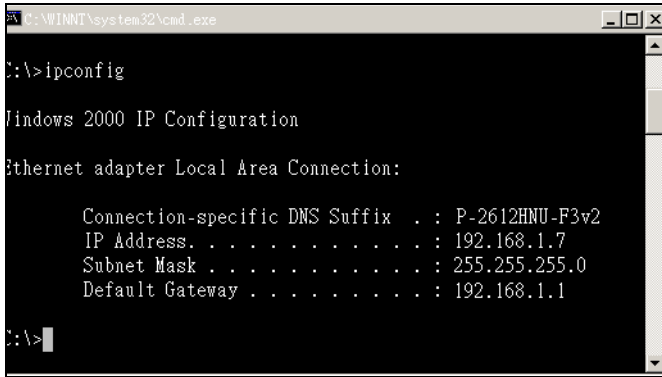

```
C:\WINNT\system32\cmd.exe

C:\>ipconfig

Windows 2000 IP Configuration

Ethernet adapter Local Area Connection:

    Connection-specific DNS Suffix  . : P-2612HNU-F3v2
    IP Address. . . . . : 192.168.1.7
    Subnet Mask . . . . . : 255.255.255.0
    Default Gateway . . . . . : 192.168.1.1

C:\>
```

Mac OS X: 10.3 and 10.4

The screens in this section are from Mac OS X 10.4 but can also apply to 10.3.

- 1 Click **Apple** > **System Preferences**.

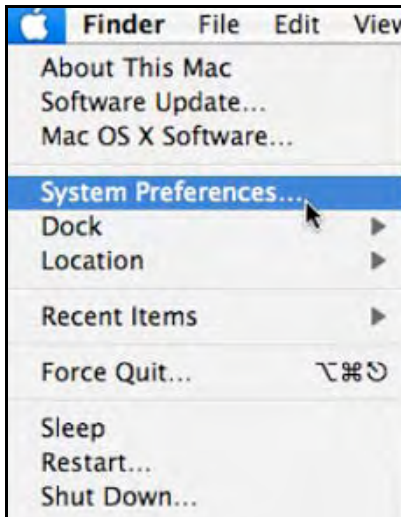

- 2 In the **System Preferences** window, click the **Network** icon.



- 3 When the **Network** preferences pane opens, select **Built-in Ethernet** from the network connection type list, and then click **Configure**.

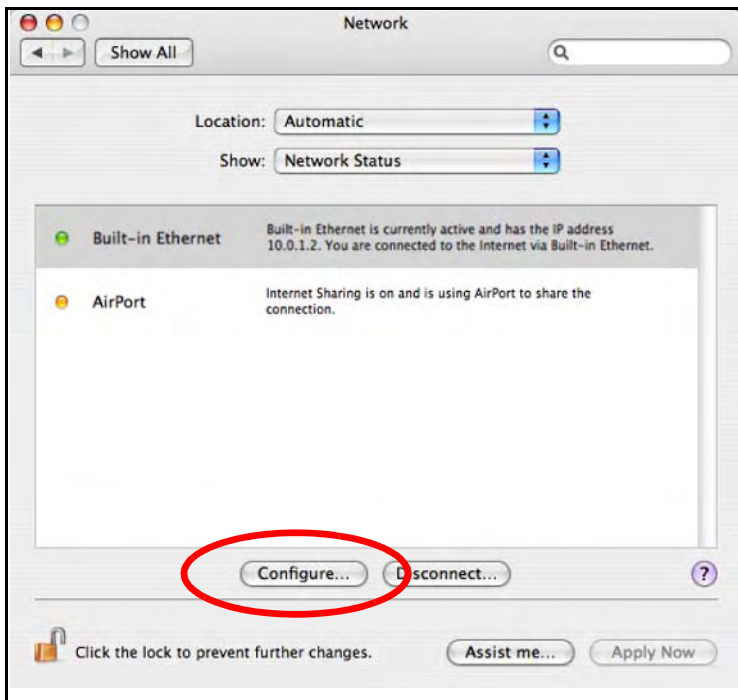

- 4 For dynamically assigned settings, select **Using DHCP** from the **Configure IPv4** list in the **TCP/IP** tab.

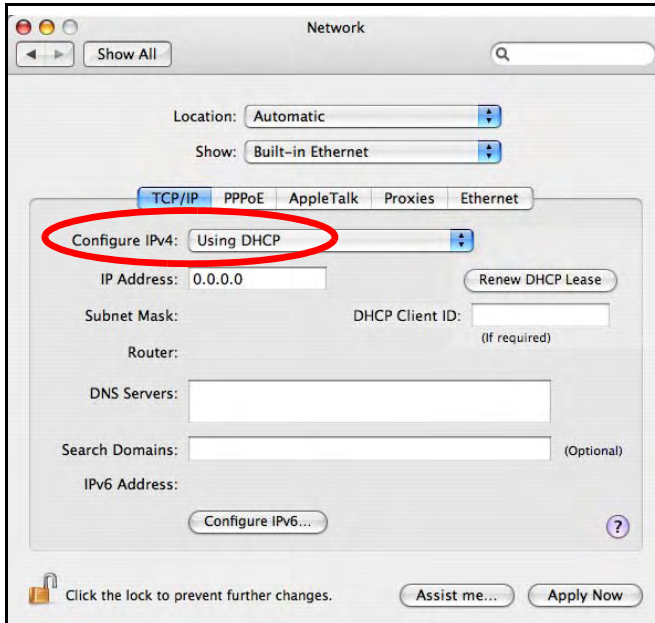

- 5 For statically assigned settings, do the following:
- From the **Configure IPv4** list, select **Manually**.
 - In the **IP Address** field, type your IP address.
 - In the **Subnet Mask** field, type your subnet mask.
 - In the **Router** field, type the IP address of your device.

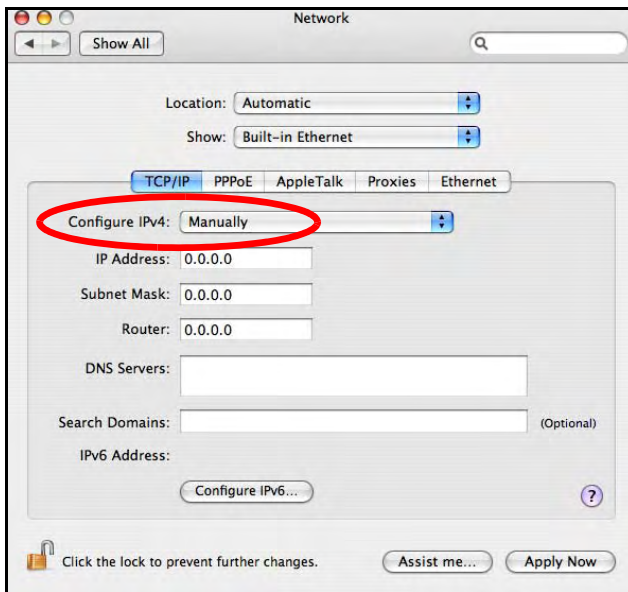

- 6 Click **Apply Now** and close the window.

Verifying Settings

Check your TCP/IP properties by clicking **Applications > Utilities > Network Utilities**, and then selecting the appropriate **Network Interface** from the **Info** tab.

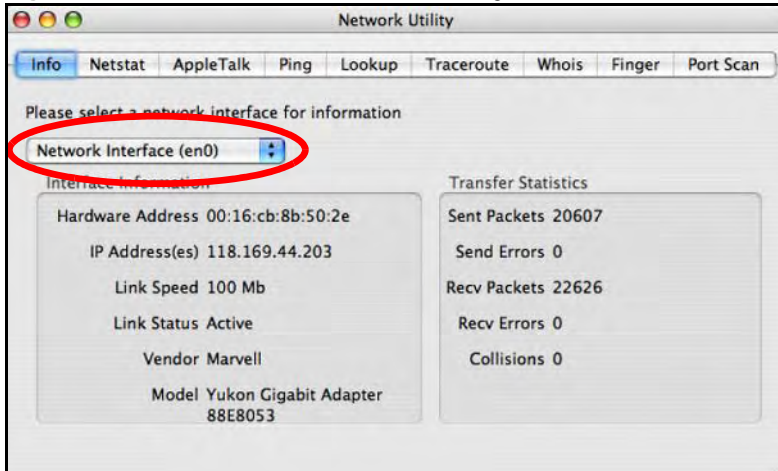
Figure 69 Mac OS X 10.4: Network Utility

Mac OS X: 10.5 and 10.6

The screens in this section are from Mac OS X 10.5 but can also apply to 10.6.

- 1 Click **Apple > System Preferences**.

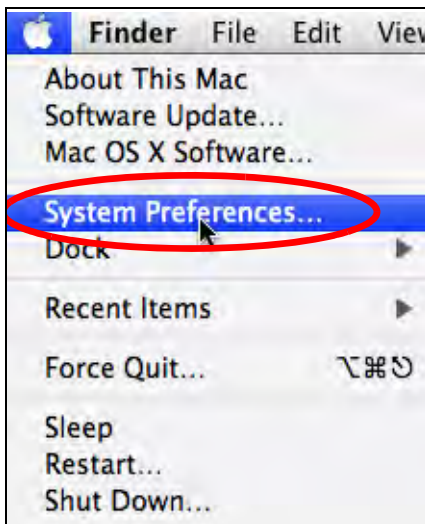

- 2 In **System Preferences**, click the **Network** icon.



- 3 When the **Network** preferences pane opens, select **Ethernet** from the list of available connection types.

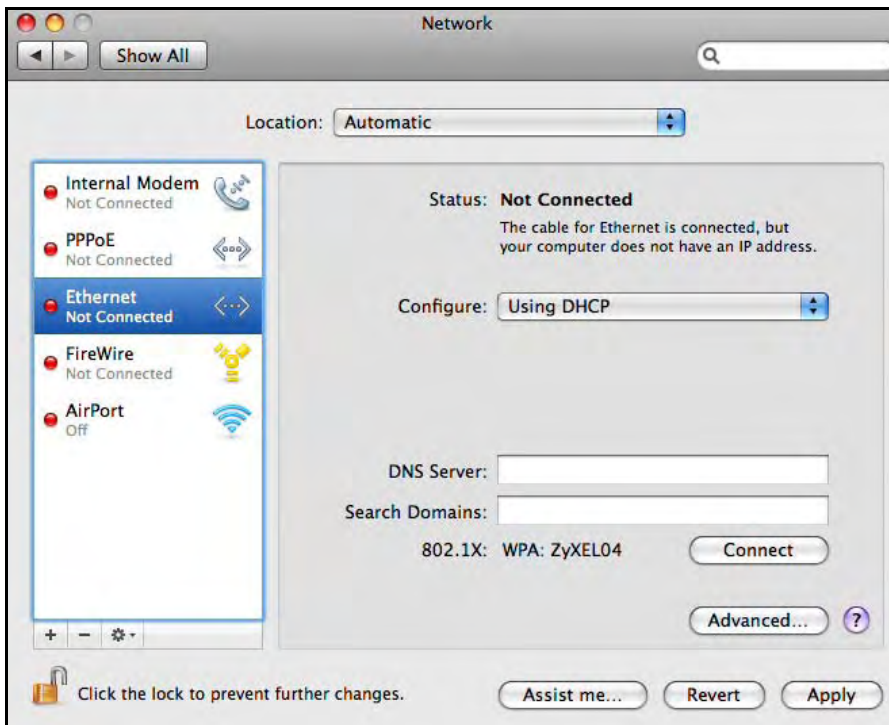

- 4 From the **Configure** list, select **Using DHCP** for dynamically assigned settings.
- 5 For statically assigned settings, do the following:
 - From the **Configure** list, select **Manually**.
 - In the **IP Address** field, enter your IP address.

- In the **Subnet Mask** field, enter your subnet mask.
- In the **Router** field, enter the IP address of your WAP6806.

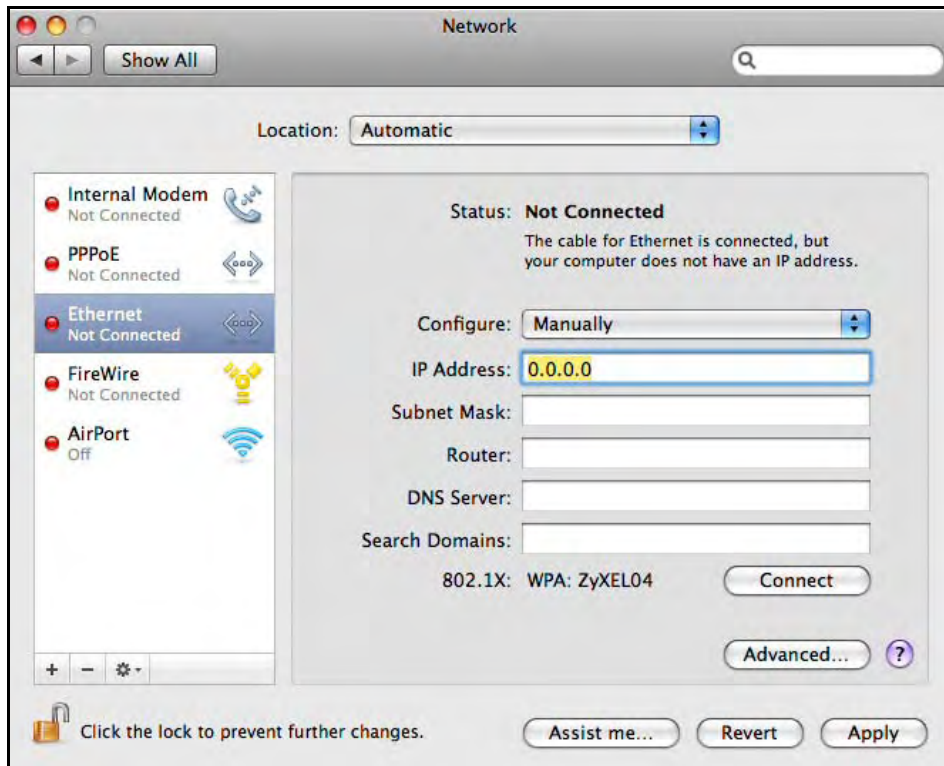

- 6 Click **Apply** and close the window.

Verifying Settings

Check your TCP/IP properties by clicking **Applications > Utilities > Network Utilities**, and then selecting the appropriate **Network interface** from the **Info** tab.

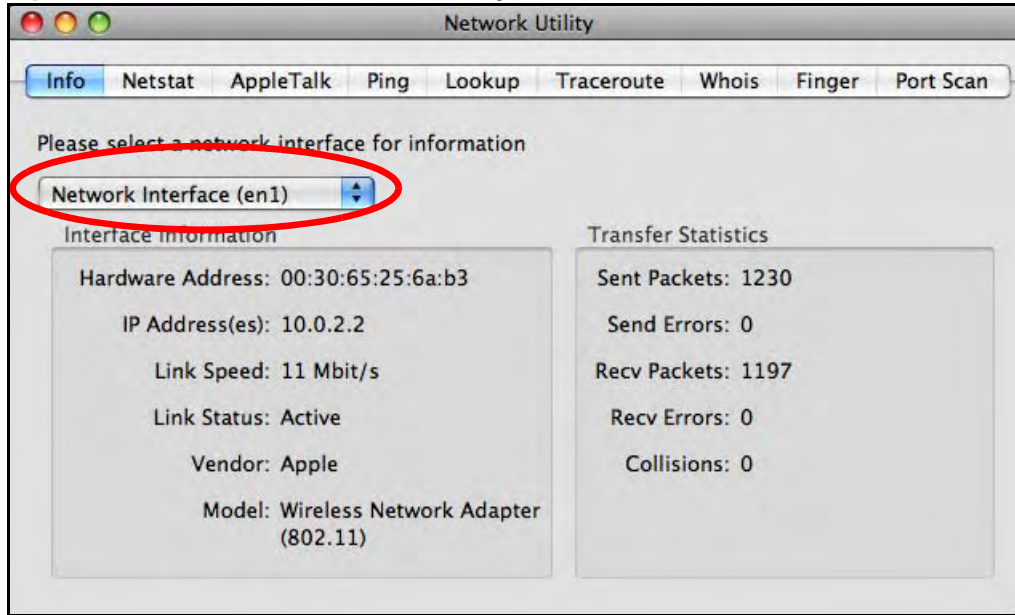
Figure 70 Mac OS X 10.5: Network Utility

Linux: Ubuntu 8 (GNOME)

This section shows you how to configure your computer's TCP/IP settings in the GNU Object Model Environment (GNOME) using the Ubuntu 8 Linux distribution. The procedure, screens and file locations may vary depending on your specific distribution, release version, and individual configuration. The following screens use the default Ubuntu 8 installation.

Note: Make sure you are logged in as the root administrator.

Follow the steps below to configure your computer IP address in GNOME:

- 1 Click **System > Administration > Network**.

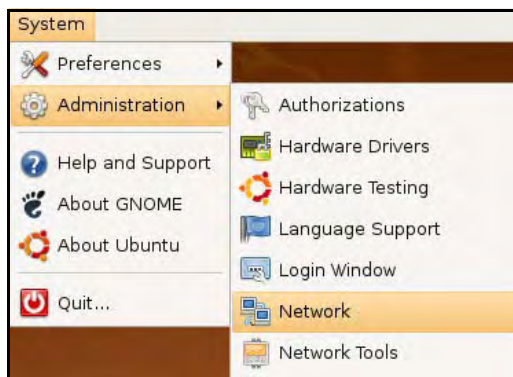

- 2 When the **Network Settings** window opens, click **Unlock** to open the **Authenticate** window. (By default, the **Unlock** button is greyed out until clicked.) You cannot make changes to your configuration unless you first enter your admin password.

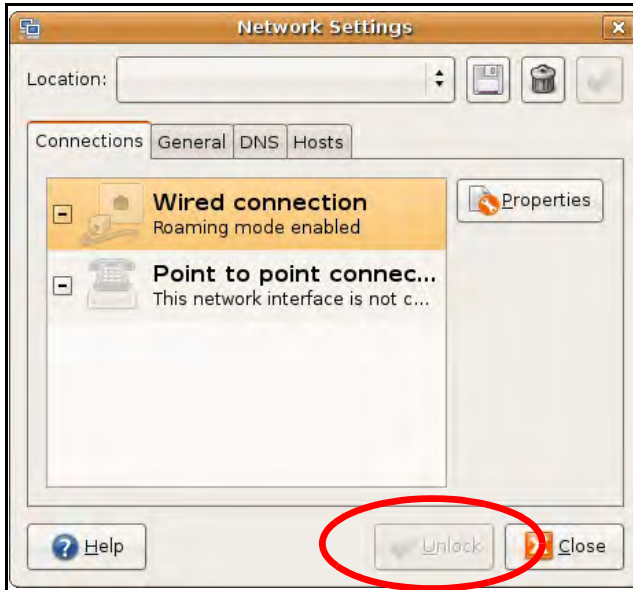

- 3 In the **Authenticate** window, enter your admin account name and password then click the **Authenticate** button.



- 4 In the **Network Settings** window, select the connection that you want to configure, then click **Properties**.



- 5 The **Properties** dialog box opens.



- In the **Configuration** list, select **Automatic Configuration (DHCP)** if you have a dynamic IP address.
 - In the **Configuration** list, select **Static IP address** if you have a static IP address. Fill in the **IP address**, **Subnet mask**, and **Gateway address** fields.
- 6 Click **OK** to save the changes and close the **Properties** dialog box and return to the **Network Settings** screen.
 - 7 If you know your DNS server IP address(es), click the **DNS** tab in the **Network Settings** window and then enter the DNS server information in the fields provided.



- 8 Click the **Close** button to apply the changes.

Verifying Settings

Check your TCP/IP properties by clicking **System > Administration > Network Tools**, and then selecting the appropriate **Network device** from the **Devices** tab. The **Interface Statistics** column shows data if your connection is working properly.

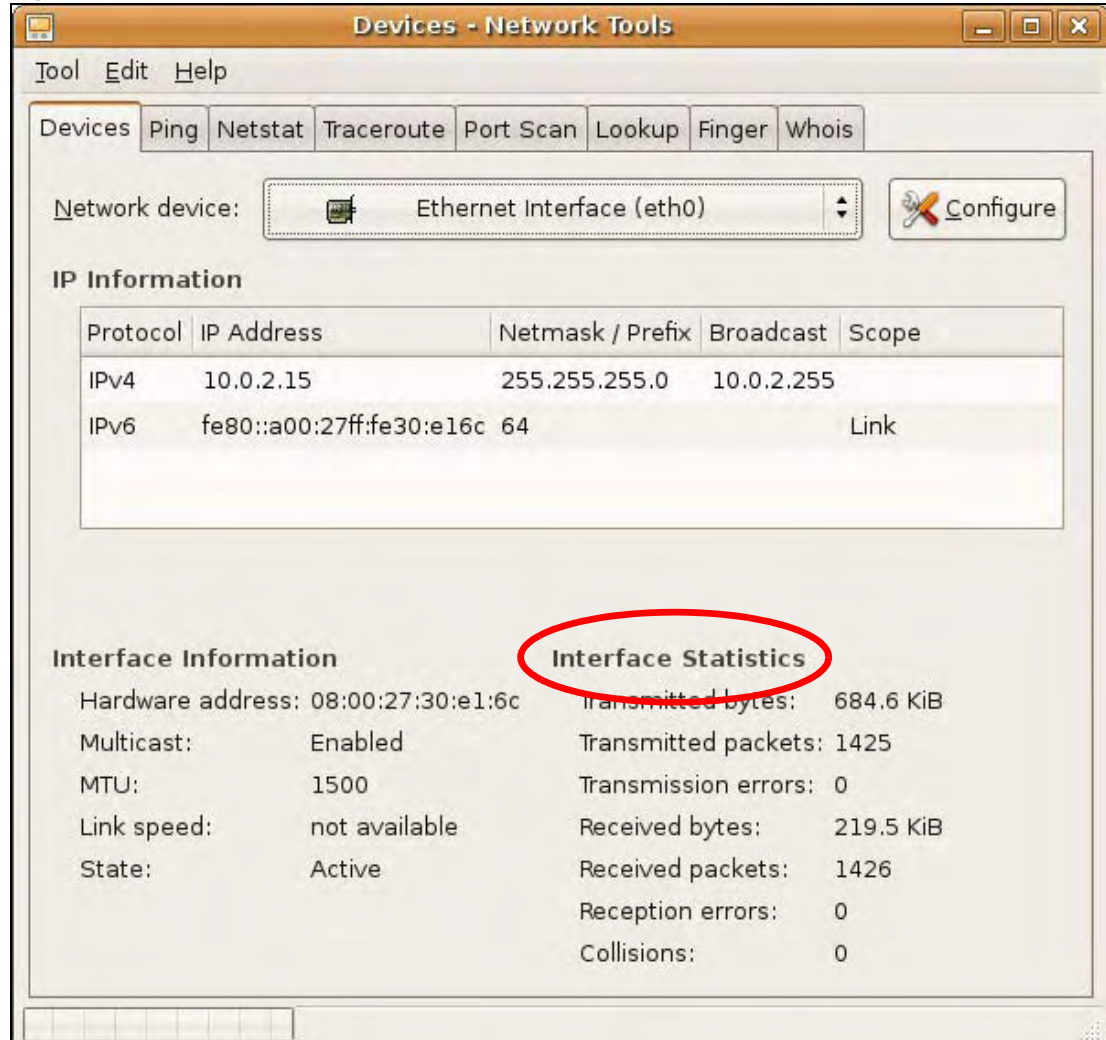
Figure 71 Ubuntu 8: Network Tools

Linux: openSUSE 10.3 (KDE)

This section shows you how to configure your computer's TCP/IP settings in the K Desktop Environment (KDE) using the openSUSE 10.3 Linux distribution. The procedure, screens and file locations may vary depending on your specific distribution, release version, and individual configuration. The following screens use the default openSUSE 10.3 installation.

Note: Make sure you are logged in as the root administrator.

Follow the steps below to configure your computer IP address in the KDE:

- 1 Click **K Menu > Computer > Administrator Settings (YaST)**.

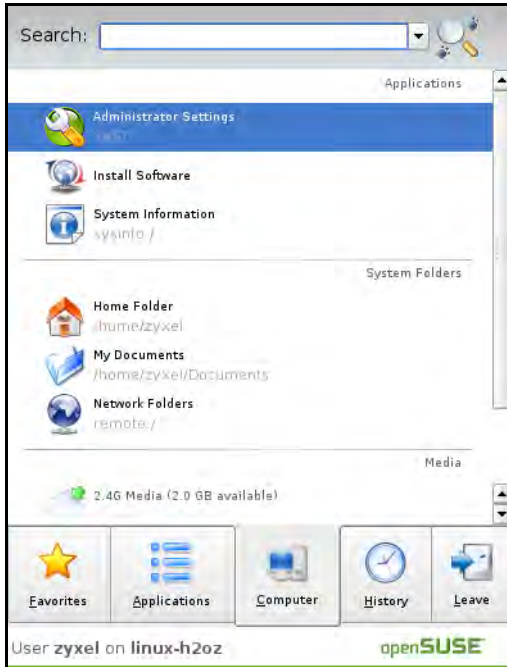

- 2 When the **Run as Root - KDE su** dialog opens, enter the admin password and click **OK**.



- 3 When the **YaST Control Center** window opens, select **Network Devices** and then click the **Network Card** icon.

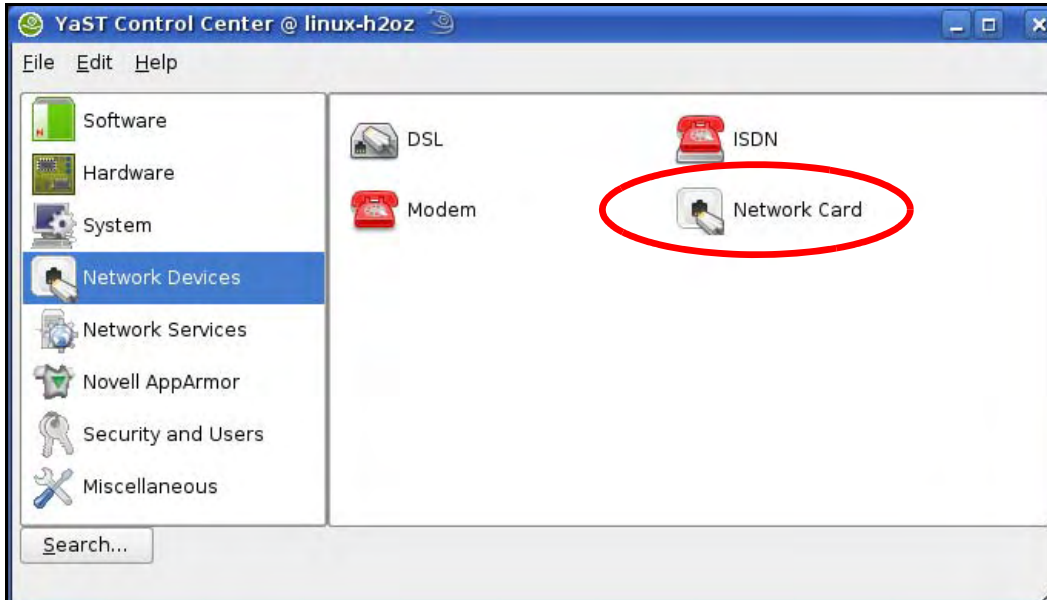

- 4 When the **Network Settings** window opens, click the **Overview** tab, select the appropriate connection **Name** from the list, and then click the **Configure** button.

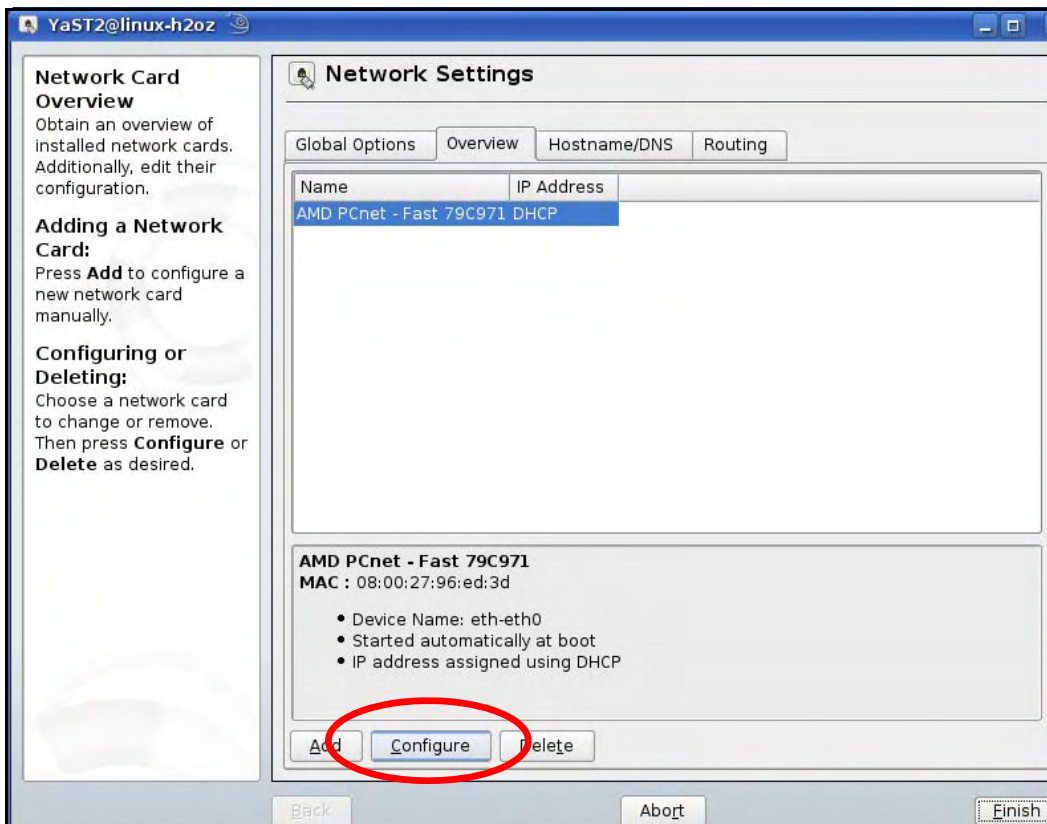

- 5 When the **Network Card Setup** window opens, click the **Address** tab

Figure 72 openSUSE 10.3: Network Card Setup

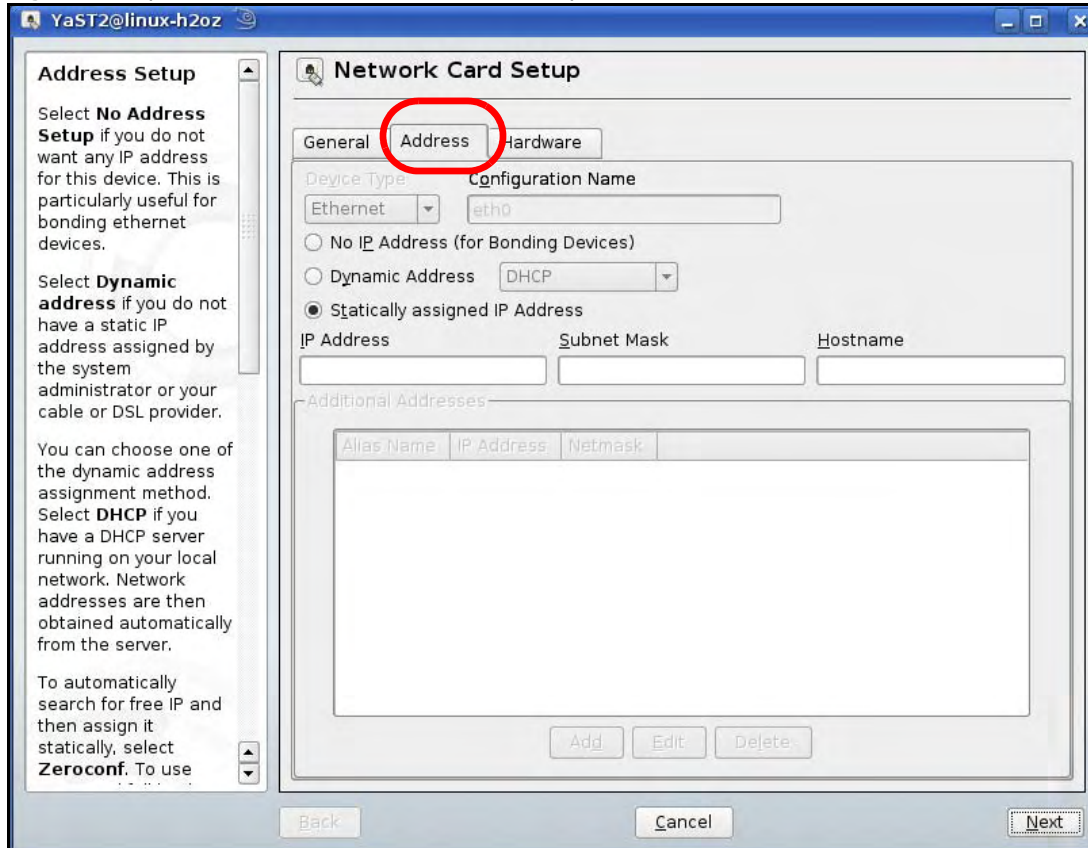

- 6 Select **Dynamic Address (DHCP)** if you have a dynamic IP address.
Select **Statically assigned IP Address** if you have a static IP address. Fill in the **IP address**, **Subnet mask**, and **Hostname** fields.
- 7 Click **Next** to save the changes and close the **Network Card Setup** window.
- 8 If you know your DNS server IP address(es), click the **Hostname/DNS** tab in **Network Settings** and then enter the DNS server information in the fields provided.

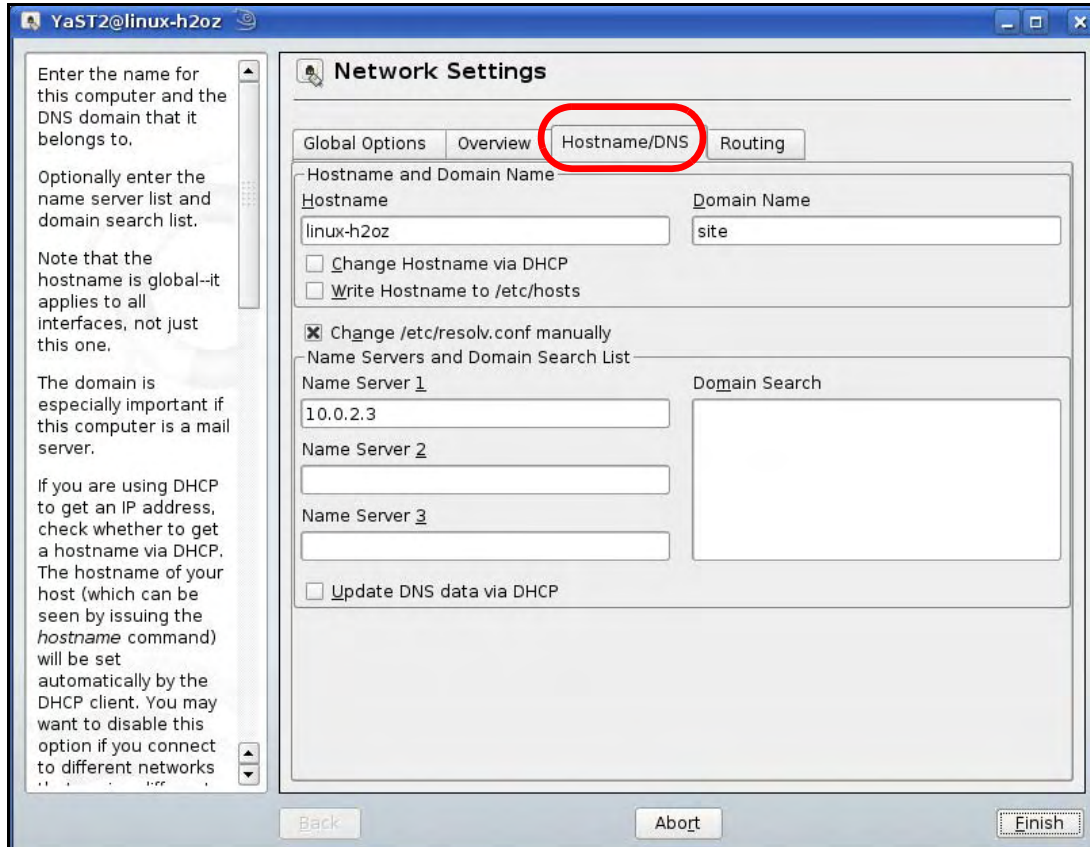

- 9 Click **Finish** to save your settings and close the window.

Verifying Settings

Click the **KNetwork Manager** icon on the **Task bar** to check your TCP/IP properties. From the **Options** sub-menu, select **Show Connection Information**.

Figure 73 openSUSE 10.3: KNetwork Manager

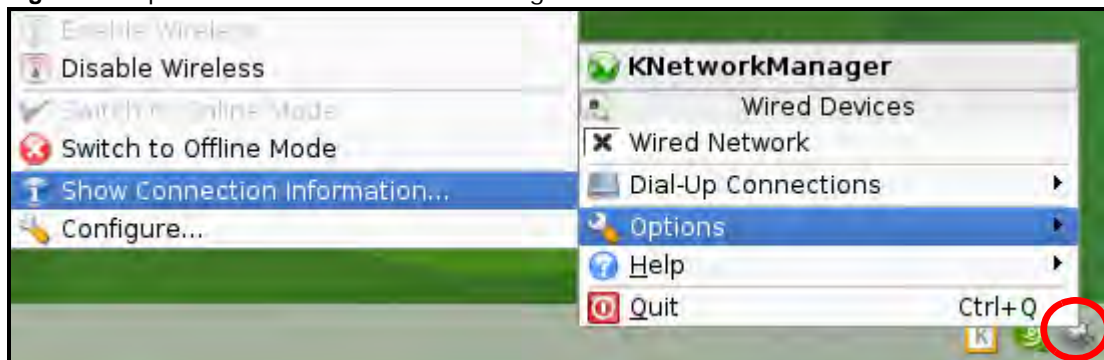

When the **Connection Status - KNetwork Manager** window opens, click the **Statistics** tab to see if your connection is working properly.

Figure 74 openSUSE: Connection Status - KNetwork Manager

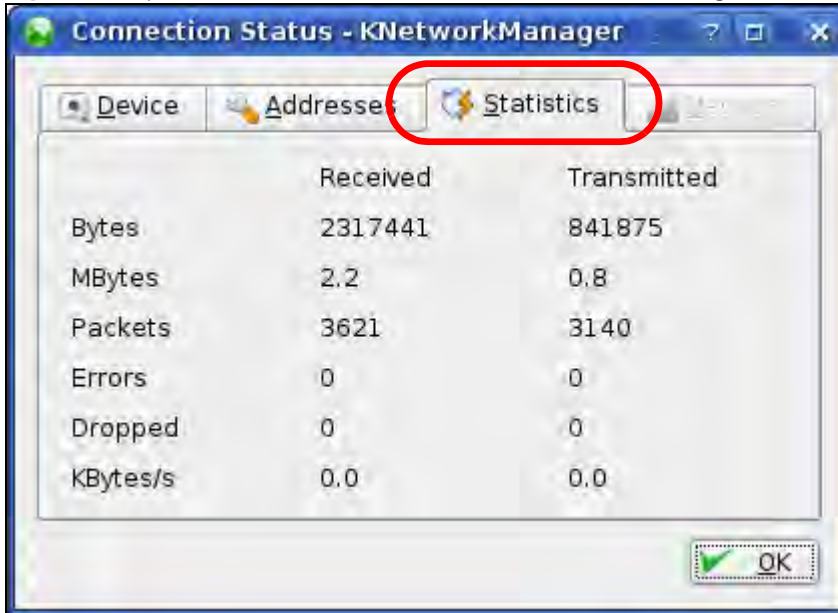

Legal Information

Copyright

Copyright © 2015 by ZyXEL Communications Corporation.

The contents of this publication may not be reproduced in any part or as a whole, transcribed, stored in a retrieval system, translated into any language, or transmitted in any form or by any means, electronic, mechanical, magnetic, optical, chemical, photocopying, manual, or otherwise, without the prior written permission of ZyXEL Communications Corporation.

Published by ZyXEL Communications Corporation. All rights reserved.

Disclaimer

ZyXEL does not assume any liability arising out of the application or use of any products, or software described herein. Neither does it convey any license under its patent rights nor the patent rights of others. ZyXEL further reserves the right to make changes in any products described herein without notice. This publication is subject to change without notice.

Regulatory Notice and Statement

UNITED STATES of AMERICA

This device complies with Part 15 of the FCC Rules. Operation is subject to the following two conditions: (1) This device may not cause harmful interference, and (2) this device must accept any interference received, including interference that may cause undesired operation.

This equipment has been tested and found to comply with the limits for a Class B digital device, pursuant to Part 15 of the FCC Rules. These limits are designed to provide reasonable protection against harmful interference in a residential installation. This equipment generates, uses and can radiate radio frequency energy and, if not installed and used in accordance with the instructions, may cause harmful interference to radio communications. However, there is no guarantee that interference will not occur in a particular installation. If this equipment does cause harmful interference to radio or television reception, which can be determined by turning the equipment off and on, the user is encouraged to try to correct the interference by one of the following measures:

- Reorient or relocate the receiving antenna.
- Increase the separation between the equipment and receiver.
- Connect the equipment into an outlet on a circuit different from that to which the receiver is connected.
- Consult the dealer or an experienced radio/TV technician for help.

FCC Caution: Any changes or modifications not expressly approved by the party responsible for compliance could void the user's authority to operate this equipment.

This transmitter must not be co-located or operating in conjunction with any other antenna or transmitter.

For operation within 5.15 ~ 5.25GHz / 5.47 ~ 5.725GHz frequency range, it is restricted to indoor environment. The band from 5600-5650MHz will be disabled by the software during the manufacturing and cannot be changed by the end user. This device meets all the other requirements specified in Part 15E, Section 15.407 of the FCC Rules.

Radiation Exposure Statement:

This equipment complies with FCC radiation exposure limits set forth for an uncontrolled environment. This equipment should be installed and operated with minimum distance 31cm between the radiator & your body.

Note: The country code selection is for non-US model only and is not available to all US model. Per FCC regulation, all WiFi product marketed in US must fixed to US operation channels only.

Industry Canada RSS-GEN & RSS-247 statement

- This device complies with Industry Canada license-exempt RSS standard(s). Operation is subject to the following two conditions: (1) this device may not cause interference, and (2) this device must accept any interference, including interference that may cause undesired operation of the device.
- This radio transmitter (2468C-NBG6815) has been approved by Industry Canada to operate with the antenna types listed below with the maximum permissible gain and required antenna impedance for each antenna type indicated. Antenna types not included in this list, having a gain greater than the maximum gain indicated for that type, are strictly prohibited for use with this device.

If the product with 5G wireless function operating in 5150-5250 MHz and 5725-5850 MHz, the following attention must be paid.

- The device for operation in the band 5150-5250 MHz is only for indoor use to reduce the potential for harmful interference to co-channel mobile satellite systems.
- For devices with detachable antenna(s), the maximum antenna gain permitted for devices in the band 5725-5850 MHz shall be such that the device still complies with the e.i.r.p. limits specified for point-to-point and non-point-to-point operation as appropriate; and
- The worst-case tilt angle(s) necessary to remain compliant with the e.i.r.p. elevation mask requirement set forth in Section 6.2.2(3) of RSS 247 shall be clearly indicated.

In the product with 5G wireless function operating in 5250-5350 MHz and 5470-5725 MHz, the following attention must be paid.

- For devices with detachable antenna(s), the maximum antenna gain permitted for devices in the bands 5250-5350 MHz and 5470-5725 MHz shall be such that the device still complies with the e.i.r.p. limit.
- Le présent appareil est conforme aux CNR d'Industrie Canada applicables aux appareils radio exempts de licence. L'exploitation est autorisée aux deux conditions suivantes : (1) l'appareil ne doit pas produire de brouillage, et (2) l'utilisateur de l'appareil doit accepter tout brouillage radioélectrique subi, même si le brouillage est susceptible d'en compromettre le fonctionnement.
- Le présent émetteur radio (2468C-NBG6815) de modèle s'il fait partie du matériel de catégorie I) a été approuvé par Industrie Canada pour fonctionner avec les types d'antenne énumérés ci-dessous et ayant un gain admissible maximal et l'impédance requise pour chaque type d'antenne. Les types d'antenne non inclus dans cette liste, ou dont le gain est supérieur au gain maximal indiqué, sont strictement interdits pour l'exploitation de l'émetteur.

Lorsque la fonction sans fil 5G fonctionnant en 5150-5250 MHz et 5725-5850 MHz est activée pour ce produit, il est nécessaire de porter une attention particulière aux choses suivantes.

- Les dispositifs fonctionnant dans la bande 5150-5250 MHz sont réservés uniquement pour une utilisation à l'intérieur afin de réduire les risques de brouillage préjudiciable aux systèmes de satellites mobiles utilisant les mêmes canaux.
- Pour les dispositifs munis d'antennes amovibles, le gain maximal d'antenne permis (pour les dispositifs utilisant la bande de 5725 à 5850 MHz) doit être conforme à la limite de la p.i.r.e. spécifiée pour l'exploitation point à point et l'exploitation non point à point, selon le cas.
- Les pires angles d'inclinaison nécessaires pour rester conforme à l'exigence de la p.i.r.e. applicable au masque d'élévation, et énoncée à la section 6.2.2 3) du CNR-247, doivent être clairement indiqués.

Lorsque la fonction sans fil 5G fonctionnant en 5250-5350 MHz et 5470-5725 MHz est activée pour ce produit, il est nécessaire de porter une attention particulière aux choses suivantes.

- Pour les dispositifs munis d'antennes amovibles, le gain maximal d'antenne permis pour les dispositifs utilisant les bandes de 5250 à 5350 MHz et de 5470 à 5725 MHz doit être conforme à la limite de la p.i.r.e.

Industry Canada radiation exposure statement

This device complies with IC radiation exposure limits set forth for an uncontrolled environment. This device should be installed and operated with a minimum distance of **31cm** between the radiator and your body.

Déclaration d'exposition aux radiations:

Cet équipement est conforme aux limites d'exposition aux rayonnements IC établies pour un environnement non contrôlé. Cet équipement doit être installé et utilisé avec un minimum de **31cm** de distance entre la source de rayonnement et votre corps.

EUROPEAN UNION



The following information applies if you use the product within the European Union.

Declaration of Conformity with Regard to EU Directive 1999/5/EC (R&TTE Directive)

Compliance information for 2.4GHz and/or 5GHz wireless products relevant to the EU and other Countries following the EU Directive 1999/5/EC (R&TTE).

Български (Bulgarian)	С настоящото ZyXEL декларира, че това оборудване е в съответствие със съществените изисквания и другите приложими разпоредбите на Директива 1999/5/EC.
Español (Spanish)	Por medio de la presente ZyXEL declara que el equipo cumple con los requisitos esenciales y cualesquiera otras disposiciones aplicables o exigibles de la Directiva 1999/5/CE.
Čeština (Czech)	ZyXEL tímto prohlašuje, že tento zařizení je ve shodě se základními požadavky a dalšími příslušnými ustanoveními směrnice 1999/5/EC.
Dansk (Danish)	Undertegnede ZyXEL erklærer herved, at følgende udstyr overholder de væsentlige krav og øvrige relevante krav i direktiv 1999/5/EF.
Deutsch (German)	Hiermit erkläre ZyXEL, dass sich das Gerät Ausstattung in Übereinstimmung mit den grundlegenden Anforderungen und den übrigen einschlägigen Bestimmungen der Richtlinie 1999/5/EU befindet.
Eesti keel (Estonian)	Käesolevaga kinnitab ZyXEL seadme seadmed vastavust direktiivi 1999/5/EÜ põhinõuetele ja nimetatud direktiivist tulenevatele teistele asjakohastele sätetele.
Ελληνικά (Greek)	ΜΕ ΤΗΝ ΠΑΡΟΥΣΑ ΖΥΧΕΛ ΔΗΛΩΝΕΙ ΟΤΙ ΕΞΟΠΛΙΣΜΟΣ ΣΥΜΜΟΡΦΩΝΕΤΑΙ ΠΡΟΣ ΤΙΣ ΟΥΣΙΩΔΕΙΣ ΑΠΑΙΤΗΣΕΙΣ ΚΑΙ ΤΙΣ ΛΟΙΠΕΣ ΣΧΕΤΙΚΕΣ ΔΙΑΤΑΞΕΙΣ ΤΗΣ ΟΔΗΓΙΑΣ 1999/5/ΕΚ.
English	Hereby, ZyXEL declares that this device is in compliance with the essential requirements and other relevant provisions of Directive 1999/5/EC.
Français (French)	Par la présente ZyXEL déclare que l'appareil équipements est conforme aux exigences essentielles et aux autres dispositions pertinentes de la directive 1999/5/EC.
Hrvatski (Croatian)	ZyXEL ovime izjavljuje da je radijska oprema tipa u skladu s Direktivom 1999/5/EC.
Íslenska (Icelandic)	Hér með lýsir, ZyXEL því yfir að þessi búnaður er í samræmi við grunnkröfur og önnur viðeigandi ákvæði tilskipunar 1999/5/EC.
Italiano (Italian)	Con la presente ZyXEL dichiara che questo attrezzatura è conforme ai requisiti essenziali ed alle altre disposizioni pertinenti stabilite dalla direttiva 1999/5/CE.
Latviešu valoda (Latvian)	Ar šo ZyXEL deklarē, ka iekārtas atbilst Direktīvas 1999/5/EK būtiskajām prasībām un citiem ar to saistītajiem noteikumiem.
Lietuvių kalba (Lithuanian)	Šiuo ZyXEL deklaruoja, kad šis įranga atitinka esminius reikalavimus ir kitas 1999/5/EB Direktyvos nuostatas.
Magyar (Hungarian)	Alulírott, ZyXEL nyilatkozom, hogy a berendezés megfelel a vonatkozó alapvető követelményeknek és az 1999/5/EK irányelv egyéb előírásainak.
Malti (Maltese)	Hawnhekk, ZyXEL, jiddikjara li dan tagħmir jikkonforma mal-ħtiġijiet essenzjali u ma provvedimenti oħrajn rilevanti li hemm fid-Dirrettiva 1999/5/EC.
Nederlands (Dutch)	Hierbij verklaart ZyXEL dat het toestel uitrusting in overeenstemming is met de essentiële eisen en de andere relevante bepalingen van richtlijn 1999/5/EC.
Polski (Polish)	Niniejszym ZyXEL oświadcza, że sprzęt jest zgodny z zasadniczymi wymogami oraz pozostałymi stosownymi postanowieniami Dyrektywy 1999/5/EC.
Português (Portuguese)	ZyXEL declara que este equipamento está conforme com os requisitos essenciais e outras disposições da Directiva 1999/5/EC.
Română (Romanian)	Prin prezenta, ZyXEL declară că acest echipament este în conformitate cu cerințele esențiale și alte prevederi relevante ale Directivei 1999/5/EC.
Slovenčina (Slovak)	ZyXEL týmto vyhlasuje, že zariadenia spĺňa základné požiadavky a všetky príslušné ustanovenia Smernice 1999/5/EC.
Slovenščina (Slovene)	ZyXEL izjavlja, da je ta oprema v skladu z bistvenimi zahtevami in ostalimi relevantnimi določili direktive 1999/5/EC.
Suomi (Finnish)	ZyXEL vakuuttaa täten että laitteet tyyppinen laite on direktiivin 1999/5/EY oleellisten vaatimusten ja sitä koskevien direktiivin muiden ehtojen mukainen.
Svenska (Swedish)	Härmed intygar ZyXEL att denna utrustning står i överensstämmelse med de väsentliga egenskapskrav och övriga relevanta bestämmelser som framgår av direktiv 1999/5/EC.
Norsk (Norwegian)	Erklærer herved ZyXEL at dette utstyret er i samsvar med de grunnleggende kravene og andre relevante bestemmelser i direktiv 1999/5/EF.

- This device is restricted to indoor use only when operating in the 5150 to 5350 MHz frequency range.

National Restrictions

This product may be used in all EU countries (and other countries following the EU Directive 1999/5/EC) without any limitation except for the countries mentioned below:

Ce produit peut être utilisé dans tous les pays de l'UE (et dans tous les pays ayant transposés la directive 1999/5/EC) sans aucune limitation, excepté pour les pays mentionnés ci-dessous:

Questo prodotto è utilizzabile in tutte i paesi EU (ed in tutti gli altri paesi che seguono le direttiva 1999/5/EC) senza nessuna limitazione, eccetto per i paesi menzionati di seguito:

Das Produkt kann in allen EU Staaten ohne Einschränkungen eingesetzt werden (sowie in anderen Staaten die der Richtlinie 1999/5/EC folgen) mit Ausnahme der folgenden aufgeführten Staaten:

In the majority of the EU and other European countries, the 2.4GHz and 5GHz bands have been made available for the use of wireless local area networks (LANs). Later in this document you will find an overview of countries in which additional restrictions or requirements or both are applicable.

The requirements for any country may evolve. ZyXEL recommends that you check with the local authorities for the latest status of their national regulations for both the 2.4GHz and 5GHz wireless LANs.

The following countries have restrictions and/or requirements in addition to those given in the table labeled "Overview of Regulatory Requirements for Wireless LANs":

Belgium

The Belgian Institute for Postal Services and Telecommunications (BIPT) must be notified of any outdoor wireless link having a range exceeding 300 meters. Please check <http://www.bipt.be> for more details.

Draadloze verbindingen voor buitengebruik en met een reikwijdte van meer dan 300 meter dienen aangemeld te worden bij het Belgisch Instituut voor postdiensten en telecommunicatie (BIPT). Zie <http://www.bipt.be> voor meer gegevens.

Les liaisons sans fil pour une utilisation en extérieur d'une distance supérieure à 300 mètres doivent être notifiées à l'Institut Belge des services Postaux et des Télécommunications (IBPT). Visitez <http://www.ibpt.be> pour de plus amples détails.

Denmark

In Denmark, the band 5150 - 5350 MHz is also allowed for outdoor usage.

I Danmark må frekvensbåndet 5150 - 5350 også anvendes udendørs.

Italy

This product meets the National Radio Interface and the requirements specified in the National Frequency Allocation Table for Italy. Unless this wireless LAN product is operating within the boundaries of the owner's property, its use requires a "general authorization." Please check <http://www.sviluppoeconomico.gov.it/> for more details.

Questo prodotto è conforme alla specifiche di Interfaccia Radio Nazionali e rispetta il Piano Nazionale di ripartizione delle frequenze in Italia. Se non viene installato all'interno del proprio fondo, l'utilizzo di prodotti Wireless LAN richiede una "Autorizzazione Generale". Consultare <http://www.sviluppoeconomico.gov.it/> per maggiori dettagli.

Latvia

The outdoor usage of the 2.4 GHz band requires an authorization from the Electronic Communications Office. Please check <http://www.esd.lv> for more details.

2.4 GHz frekvenču joslas izmantošanai ārpus telpām nepieciešama atļauja no Elektronisko sakaru direkcijas. Vairāk informācijas: <http://www.esd.lv>.

Notes:

1. Although Norway, Switzerland and Liechtenstein are not EU member states, the EU Directive 1999/5/EC has also been implemented in those countries.
2. The regulatory limits for maximum output power are specified in EIRP. The EIRP level (in dBm) of a device can be calculated by adding the gain of the antenna used (specified in dBi) to the output power available at the connector (specified in dBm).

List of national codes

COUNTRY	ISO 3166 2 LETTER CODE	COUNTRY	ISO 3166 2 LETTER CODE
Austria	AT	Liechtenstein	LI
Belgium	BE	Lithuania	LT
Bulgaria	BG	Luxembourg	LU
Croatia	HR	Malta	MT
Cyprus	CY	Netherlands	NL
Czech Republic	CZ	Norway	NO
Denmark	DK	Poland	PL
Estonia	EE	Portugal	PT
Finland	FI	Romania	RO
France	FR	Serbia	RS
Germany	DE	Slovakia	SK
Greece	GR	Slovenia	SI
Hungary	HU	Spain	ES
Iceland	IS	Sweden	SE
Ireland	IE	Switzerland	CH
Italy	IT	Turkey	TR
Latvia	LV	United Kingdom	GB

Safety Warnings

- Do not use this product near water, for example, in a wet basement or near a swimming pool.

- Do not expose your device to dampness, dust or corrosive liquids.
- Do not store things on the device.
- Do not install, use, or service this device during a thunderstorm. There is a remote risk of electric shock from lightning.
- Connect ONLY suitable accessories to the device.
- Do not open the device or unit. Opening or removing covers can expose you to dangerous high voltage points or other risks. Only qualified service personnel should service or disassemble this device. Please contact your vendor for further information.
- Make sure to connect the cables to the correct ports.
- Place connecting cables carefully so that no one will step on them or stumble over them.
- Always disconnect all cables from this device before servicing or disassembling.
- Do not remove the plug and connect it to a power outlet by itself; always attach the plug to the power adaptor first before connecting it to a power outlet.
- Do not allow anything to rest on the power adaptor or cord and do NOT place the product where anyone can walk on the power adaptor or cord.
- Please use the provided or designated connection cables/power cables/adaptors. Connect it to the right supply voltage (for example, 110V AC in North America or 230V AC in Europe). If the power adaptor or cord is damaged, it might cause electrocution. Remove it from the device and the power source; repairing the power adapter or cord is prohibited. Contact your local vendor to order a new one.
- Do not use the device outside, and make sure all the connections are indoors. There is a remote risk of electric shock from lightning.
- Caution: risk of explosion if battery is replaced by an incorrect type. dispose of used batteries according to the instructions. Dispose them at the applicable collection point for the recycling of electrical and electronic device. For detailed information about recycling of this product, please contact your local city office, your household waste disposal service or the store where you purchased the product.
- Do not obstruct the device ventilation slots, as insufficient airflow may harm your device.

The following warning statements apply, where the disconnect device is not incorporated in the device or where the plug on the power supply cord is intended to serve as the disconnect device,

- For permanently connected devices, a readily accessible disconnect device shall be incorporated external to the device;
- For pluggable devices, the socket-outlet shall be installed near the device and shall be easily accessible.

Environment statement

ErP (Energy-related Products)

ZyXEL products put on the EU market in compliance with the requirement of the European Parliament and the Council published Directive 2009/125/EC establishing a framework for the setting of ecodesign requirements for energy-related products (recast), so called as "ErP Directive (Energy-related Products directive) as well as ecodesign requirement laid down in applicable implementing measures, power consumption has satisfied regulation requirements which are:

Network standby power consumption < 12W, and/or

Off mode power consumption < 0.5W, and/or

Standby mode power consumption < 0.5W.

Wireless setting, please refer to the "Wireless" chapter for more detail.

European Union - Disposal and Recycling Information

The symbol below means that according to local regulations your product and/or its battery shall be disposed of separately from domestic waste. If this product is end of life, take it to a recycling station designated by local authorities. At the time of disposal, the separate collection of your product and/or its battery will help save natural resources and ensure that the environment is sustainable development.

Die folgende Symbol bedeutet, dass Ihr Produkt und/oder seine Batterie gemäß den örtlichen Bestimmungen getrennt vom Hausmüll entsorgt werden muss. Wenden Sie sich an eine Recyclingstation, wenn dieses Produkt das Ende seiner Lebensdauer erreicht hat. Zum Zeitpunkt der Entsorgung wird die getrennte Sammlung von Produkt und/oder seiner Batterie dazu beitragen, natürliche Ressourcen zu sparen und die Umwelt und die menschliche Gesundheit zu schützen.

El símbolo de abajo indica que según las regulaciones locales, su producto y/o su batería deberán depositarse como basura separada de la doméstica. Cuando este producto alcance el final de su vida útil, llévelo a un punto limpio. Cuando llegue el momento de desechar el producto, la recogida por separado éste y/o su batería ayudará a salvar los recursos naturales y a proteger la salud humana y medioambiental.

Le symbole ci-dessous signifie que selon les réglementations locales votre produit et/ou sa batterie doivent être éliminés séparément des ordures ménagères. Lorsque ce produit atteint sa fin de vie, amenez-le à un centre de recyclage. Au moment de la mise au rebut, la collecte séparée de votre produit et/ou de sa batterie aidera à économiser les ressources naturelles et protéger l'environnement et la santé humaine.

Il simbolo sotto significa che secondo i regolamenti locali il vostro prodotto e/o batteria deve essere smaltito separatamente dai rifiuti domestici. Quando questo prodotto raggiunge la fine della vita di servizio portarlo a una stazione di riciclaggio. Al momento dello smaltimento, la raccolta separata del vostro prodotto e/o della sua batteria aiuta a risparmiare risorse naturali e a proteggere l'ambiente e la salute umana.

Symbolen innebär att enligt lokal lagstiftning ska produkten och/eller dess batteri kastas separat från hushållsavfallet. När den här produkten när slutet av sin livslängd ska du ta den till en återvinningsstation. Vid tiden för kasseringen bidrar du till en bättre miljö och mänsklig hälsa genom att göra dig av med den på ett återvinningsställe.



Environmental Product Declaration

Български (Bulgarian)	Čeština (Czech)	Dansk (Danish)	Deutsch (German)
<p>Екологична продуктова декларация</p> <p>RoHS Директива 2011/65/ЕО WEEE Директива 2012/19/ЕО PPW Директива 94/62/ЕО REACH Регламент (ЕО) № 1907/2006 ECP Директива 2009/125/ЕО</p> <p>Име/ титла : Richard Hsu / Quality Management Division Senior Manager Podpis : Дата (dd/mm/yyyy) : 01/10/2014</p>   	<p>Environmentální prohlášení o produktu</p> <p>RoHS Směrnice 2011/65/EU WEEE Směrnice 2012/19/EU PPW Směrnice 94/62/EC REACH Nařízení (ES) č. 1907/2006 ECP Směrnice 2009/125/ES</p> <p>Iměno/ titul : Richard Hsu / Quality Management Division Senior Manager Podpis : Datum (dd/mm/yyyy) : 01/10/2014</p>   	<p>Miljøvaredeklaration</p> <p>RoHS Direktiv 2011/65/EU WEEE Direktiv 2012/19/EU PPW Direktiv 94/62/EF REACH Forordning (EF) nr. 1907/2006 ECP Direktiv 2009/125/EF</p> <p>Navn/ titel : Richard Hsu / Quality Management Division Senior Manager Underskrift : Datum (dd/mm/åååå) : 01/10/2014</p>   	<p>Produkt-Umweltdeklaration</p> <p>RoHS Richtlinie 2011/65/EU WEEE Richtlinie 2012/19/EU PPW Richtlinie 94/62/EG REACH VERORDNUNG (EG) Nr. 1907/2006 ECP Richtlinie 2009/125/EG</p> <p>Name/ titel : Richard Hsu / Quality Management Division Senior Manager Unterschrift : Datum (dd/mm/yyyy) : 2014/10/01</p>   
Eesti keel (Estonian)	English	Español (Spanish)	Français (French)
<p>Toote keskkonnadeklaratsioon</p> <p>RoHS Direktiv 2011/65/EL WEEE Direktiv 2012/19/EL PPW Direktiv 94/62/EZ REACH MÄÄRUS (EÜ) nr 1907/2006 ECP Direktiv 2009/125/EZ</p> <p>Nimi / pealkiri : Richard Hsu / Quality Management Division Senior Manager Allkiri : Koostöö (pp/AA/kaas) : 01/10/2014</p>   	<p>Environmental product declaration</p> <p>RoHS Directive 2011/65/EU WEEE Directive 2012/19/EU PPW Directive 94/62/EC REACH Regulation (EC) No 1907/2006 ECP Directive 2009/125/CE</p> <p>Name/ title : Richard Hsu / Quality Management Division Senior Manager Signature : Date (dd/mm/yyyy) : 01/10/2014</p>   	<p>Declaraciones Ambientales de Producto</p> <p>RoHS Directiva 2011/65/UE WEEE Directiva 2012/19/UE PPW Directiva 94/62/CE REACH REGLAMENTO (CE) nº 1907/2006 ECP Directiva 2009/125/CE</p> <p>Nombre/ título : Richard Hsu / Quality Management Division Senior Manager Firma : Fecha (aaaa/mm/aa) : 2014/10/01</p>   	<p>Profil environnemental de produit</p> <p>RoHS Directive 2011/65/UE WEEE Directive 2012/19/UE PPW Directive 94/62/CE REACH RÈGLEMENT (CE) No 1907/2006 ECP Directive 2009/125/CE</p> <p>Nom/ titre : Richard Hsu / Quality Management Division Senior Manager Signature : Date (aaaa/mm/jj) : 2014/10/01</p>   
Hrvatski (Croatian)	Italiano (Italian)	Latviešu valoda (Latvian)	Lietuvių kalba (Lithuanian)
<p>Deklaraciju o zbrinjavanju proizvoda</p> <p>RoHS Direktiva 2011/65/EU WEEE Direktiva 2012/19/EU PPW Direktiva 94/62/EZ REACH Uredba (EZ) br. 1907/2006 ECP Direktiva 2009/125/EZ</p> <p>Ime/ naziv : Richard Hsu / Quality Management Division Senior Manager Podpis : Datum (dd/mm/yyyy) : 01/10/2014</p>   	<p>Dichiarazione ambientale di prodotto</p> <p>RoHS Direttiva 2011/65/UE WEEE Direttiva 2012/19/UE PPW Direttiva 94/62/CE REACH REGOLAMENTO (CE) n. 1907/2006 ECP Direttiva 2009/125/CE</p> <p>Nome/ titolo : Richard Hsu / Quality Management Division Senior Manager Firma : Data (aaaa/mm/aa) : 2014/10/01</p>   	<p>Produkta vides ietekmējuma deklarācija</p> <p>RoHS Direktīva 2011/65/EK WEEE Direktīva 2012/19/EK PPW Direktīva 94/62/EK REACH Regula (ES) Nr. 1907/2006 ECP Direktīva 2009/125/EK</p> <p>Nosaukums/ tituls : Richard Hsu / Quality Management Division Senior Manager Paraksts : Datums (dd/mm/gggg) : 01/10/2014</p>   	<p>Aplinkosauginis gaminių deklaracija</p> <p>RoHS Direktyva 2011/65/UE WEEE Direktyva 2012/19/UE PPW Direktyva 94/62/EB REACH REGLAMENTAS (ES) Nr. 1907/2006 ECP Direktyva 2009/125/EB</p> <p>Vardas/ statusas : Richard Hsu / Quality Management Division Senior Manager Parašas : Data (ddmmmmmm) : 01/10/2014</p>   
Magyar (Hungarian)	Malti (Maltese)	Nederlands (Dutch)	Polski (Polish)
<p>Környezetvédelmi terméknyilatkozat</p> <p>RoHS 2011/65/EU irányelve WEEE 2012/19/EU irányelve PPW 94/62/EK irányelve REACH 1907/2006/EK Rendelet ECP 2009/125/EK irányelve</p> <p>Név/ cím : Richard Hsu / Quality Management Division Senior Manager Aláírás : Dátum (dd/mm/yyyy) : 2014/10/01</p>   	<p>Dikjarazzjoni Ambjentali dwar il-Prodott</p> <p>RoHS 2011/65/UE WEEE 2012/19/UE PPW 94/62/CE REACH (REGOLAMENTO) (KE) NR 1907/2006 ECP 2009/125/KE</p> <p>Isim/ itidul : Richard Hsu / Quality Management Division Senior Manager Firma : Data (aaaa/aa/jj) : 2014/10/01</p>   	<p>Milieuproductverklaring</p> <p>RoHS Richtlijn 2011/65/UE WEEE Richtlijn 2012/19/UE PPW Richtlijn 94/62/CE REACH Verordening (EG) nr. 1907/2006 ECP Richtlijn 2009/125/EG</p> <p>Naam/ titel : Richard Hsu / Quality Management Division Senior Manager Handtekening : Datum (dd/mm/jaar) : 01/10/2014</p>   	<p>Deklarację środowiskową produktu</p> <p>RoHS Dyrektywa 2011/65/UE WEEE Dyrektywa 2012/19/UE PPW Dyrektywa 94/62/EB REACH Rozporządzenie (WE) nr 1907/2006 ECP Dyrektywa 2009/125/WE</p> <p>Nazwisko/ tytuł : Richard Hsu / Quality Management Division Senior Manager Podpis : Data (mmmm/rrrr) : 2014/10/01</p>   
Português (Portuguese)	Română (Romanian)	Slovenčina (Slovak)	Slovenščina (Slovene)
<p>Declaração ambiental do produto</p> <p>RoHS Directiva 2011/65/UE WEEE Directiva 2012/19/UE PPW Directiva 94/62/CE REACH Regulamento (CE) nº 1907/2006 ECP Directiva 2009/125/CE</p> <p>Nome/ título : Richard Hsu / Quality Management Division Senior Manager Assinatura : Data (dd/mm/aaaa) : 01/10/2014</p>   	<p>Declarație de mediu privind produsele</p> <p>RoHS Directivă 2011/65/UE WEEE Directivă 2012/19/UE PPW Directivă 94/62/CE REACH REGULAMENTUL (CE) NR. 1907/2006 ECP Directivă 2009/125/CE</p> <p>Numele/ titlu : Richard Hsu / Quality Management Division Senior Manager Semnatura : Data (dd/mm/aaaa) : 01/10/2014</p>   	<p>Vyhľadzenie o environmentálnom výrobku</p> <p>RoHS Smernica 2011/65/EU WEEE Smernica 2012/19/EU PPW Smernica 94/62/ES REACH Nařízení (ES) č. 1907/2006 ECP Smernica 2009/125/ES</p> <p>Meno/ titul : Richard Hsu / Quality Management Division Senior Manager Podpis : Datum (dd/mm/yyyy) : 01/10/2014</p>   	<p>Okoljsko deklaracija izdelka</p> <p>RoHS Direktiva 2011/65/EU WEEE Direktiva 2012/19/EU PPW Direktiva 94/62/EG REACH Uredba (ES) br. 1907/2006 ECP Direktiva 2009/125/ES</p> <p>Ime/ naziv : Richard Hsu / Quality Management Division Senior Manager Podpis : Datum (ddmm/aa) : 01/10/2014</p>   
Suomi (Finnish)	Svenska (Swedish)	Ελληνικά (Greek)	Norsk (Norwegian)
<p>Standardin perustava ympäristötuoteseloste</p> <p>RoHS Direktiiv 2011/65/EU WEEE Direktiiv 2012/19/EU PPW Direktiiv 94/62/EY REACH ASETUS (EY) No 1907/2006 ECP Direktiiv 2009/125/EY</p> <p>Nimi/ osasto : Richard Hsu / Quality Management Division Senior Manager Allekirjoitus : Päivämäärä (pp/kk/vvvv) : 01/10/2014</p>   	<p>Miljöproduktdeklaration</p> <p>RoHS Direktiv 2011/65/EU WEEE Direktiv 2012/19/EU PPW Direktiv 94/62/EG REACH Förordning (EG) nr 1907/2006 ECP Direktiv 2009/125/EG</p> <p>Namn/ titel : Richard Hsu / Quality Management Division Senior Manager Namnteckning : Datum (ddmm/åååå) : 01/10/2014</p>   	<p>Περιβαλλοντική δήλωση προϊόντος</p> <p>RoHS Οδηγία 2011/65/ΕΕ WEEE Οδηγία 2012/19/ΕΕ PPW Οδηγία 94/62/ΕΚ REACH Ένταξη (ΕΚ) αριθ. 1907/2006 ECP Οδηγία 2009/125/ΕΚ</p> <p>Όνομα/ τίτλος : Richard Hsu / Quality Management Division Senior Manager Υπογραφή : Ημερομηνία (ηη/μμ/εεεε) : 01/10/2014</p>   	<p>Miljødeklarasjon</p> <p>RoHS Direktiv 2011/65/EU WEEE Direktiv 2012/19/EU PPW Direktiv 94/62/EG REACH Forordning (EF) nr. 1907/2006 ECP Direktiv 2009/125/EF</p> <p>Navn/ tittel : Richard Hsu / Quality Management Division Senior Manager Signatur : Dato (ddmm/åååå) : 01/10/2014</p>   

台灣



以下訊息僅適用於產品銷售至台灣地區

- 第十二條→經型式認證合格之低功率射頻電機，非經許可，公司，商號或使用者均不得擅自變更頻率、加大功率或變更原設計之特性及功能。
- 第十四條→低功率射頻電機之使用不得影響飛航安全及干擾合法通信；經發現有干擾現象時，應立即停用，並改善至無干擾時方得繼續使用。

前項合法通信，指依電信法規定作業之無線電通信。低功率射頻電機須忍受合法通信或工業、科學及醫療用電波輻射性電機設備之干擾。

用 31cm 計算 MPE 能符合 1 mW/cm²。

電磁波曝露量 MPE 標準值 1mW/cm²，送測產品實測值為：_XX_mW/cm²。

無線資訊傳輸設備忍受合法通信之干擾且不得干擾合法通信；如造成干擾，應立即停用，俟無干擾之虞，得繼續使用。

無線資訊傳輸設備的製造廠商應確保頻率穩定性，如依製造適使用手冊上所述正常操作，發射的信號應維持於操作頻帶中。

以下訊息僅適用於產品操作於 5.25-5.35 赫茲頻帶內並銷售至台灣地區

- 在 5.25-5.35 赫茲頻帶內操作之無線資訊傳輸設備，限於室內使用。

以下訊息僅適用於產品屬於專業安裝並銷售至台灣地區

- 本器材須經專業工程人員安裝及設定，始得設置使用，且不得直接販售給一般消費者。

安全警告

為了您的安全，請先閱讀以下警告及指示：

- 請勿將此產品接近水、火焰或放置在高溫的環境。
- 避免設備接觸。
- 任何液體 - 切勿讓設備接觸水、雨水、高溫度、污水腐蝕性的液體或其他水份。
- 灰塵及污物 - 切勿接觸灰塵、污物、沙土、食物或其他不適合的材料。
- 雷雨天氣時，不要安裝，使用或維修此設備。有遭受電擊的風險。
- 切勿重摔或撞擊設備，並勿使用不正確的電源變壓器。
- 若接上不正確的電源變壓器會有爆炸的風險。
- 請勿隨意更換產品內的電池。
- 如果更換不正確的電池型式，會有爆炸的風險，請依製造商說明書處理使用過之電池。
- 請將廢電池丟棄在適當的電器或電子設備回收處。
- 請勿將設備解體。
- 請勿阻礙設備的散熱孔，空氣對流不足將會造成設備損害。
- 請插在正確的電壓供給插座（如：北美 / 台灣電壓 110V AC，歐洲是 230V AC）。
- 假若電源變壓器或電源變壓器的纜線損壞，請從插座拔除，若您還繼續插電使用，會有觸電死亡的風險。
- 請勿試圖修理電源變壓器或電源變壓器的纜線，若有毀損，請直接聯絡您購買的店家，購買一個新的電源變壓器。
- 請勿將此設備安裝於室外，此設備僅適合放置於室內。
- 請勿隨一般垃圾丟棄。
- 請參閱產品背貼上的設備額定功率。
- 請參考產品型錄或是彩盒上的作業溫度。
- 產品沒有斷電裝置或者採用電源線的插頭視為斷電裝置的一部分，以下警語將適用：
 - 對永久連接之設備，在設備外部須安裝可觸及之斷電裝置；
 - 對插接式之設備，插座必須接近安裝之地點而且是易於觸及的。

Viewing Certifications

Go to <http://www.zyxel.com> to view this product's documentation and certifications.

ZyXEL Limited Warranty

ZyXEL warrants to the original end user (purchaser) that this product is free from any defects in material or workmanship for a specific period (the Warranty Period) from the date of purchase. The Warranty Period varies by region. Check with your vendor and/or the authorized ZyXEL local distributor for details about the Warranty Period of this product. During the warranty period, and upon proof of purchase, should the product have indications of failure due to faulty workmanship and/or materials, ZyXEL will, at its discretion, repair or replace the defective products or components without charge for either parts or labor, and to whatever extent it shall deem necessary to restore the product or components to proper operating condition. Any replacement will consist of a new or re-manufactured functionally equivalent product of equal or higher value, and will be solely at the discretion of ZyXEL. This warranty shall not apply if the product has been modified, misused, tampered with, damaged by an act of God, or subjected to abnormal working conditions.

Note

Repair or replacement, as provided under this warranty, is the exclusive remedy of the purchaser. This warranty is in lieu of all other warranties, express or implied, including any implied warranty of merchantability or fitness for a particular use or purpose. ZyXEL shall in no event be held liable for indirect or consequential damages of any kind to the purchaser.

To obtain the services of this warranty, contact your vendor. You may also refer to the warranty policy for the region in which you bought the device at http://www.zyxel.com/web/support_warranty_info.php.

Registration

Register your product online to receive e-mail notices of firmware upgrades and information at www.zyxel.com for global products, or at www.us.zyxel.com for North American products.

Open Source Licenses

This product contains in part some free software distributed under GPL license terms and/or GPL like licenses. Open source licenses are provided with the firmware package. You can download the latest firmware at www.zyxel.com. If you cannot find it there, contact your vendor or ZyXEL Technical Support at support@zyxel.com.tw.

To obtain the source code covered under those Licenses, please contact your vendor or ZyXEL Technical Support at support@zyxel.com.tw.

Index

A

- AP Mode
 - status screen [24, 28](#)
- AP mode
 - setting up [24](#)

B

- backup configuration [81](#)

C

- certifications
 - viewing [129](#)
- channel [20](#)
- client mode [53](#)
- configuration
 - backup [81](#)
 - Export [81](#)
 - Import [81](#)
 - reset factory defaults [82](#)
 - restore [81](#)
- contact information [88](#)
- copyright [122](#)
- customer support [88](#)

D

- disclaimer [122](#)
- documentation
 - related [2](#)

E

- encryption [63](#)
 - key [63](#)
- Ethernet [60](#)

F

- factory defaults
 - restore [82](#)
- FCC interference statement [122](#)
- firmware upgrade
 - screen [78](#)
- firmware upload [78](#)
 - file extension
 - using HTTP
- firmware version [19, 25, 29](#)

G

- general [76](#)
- general wireless LAN screen [63](#)
- guide
 - quick start [2](#)

I

- IP Address [61](#)

L

- LAN IP
 - screen [60](#)
- language [82](#)
- Log [49](#)

M

managing the device
 good habits [10](#)
mode
 access point [15](#)
 client [15](#), [53](#)
 normal [54](#)
 range boost [55](#)
 repeater [15](#), [53](#)
 speed boost [55](#)

N

navigation
 panel [46](#)
navigation panel [46](#)
normal mode [54](#)

O

operating mode
 client mode [53](#)
 normal [54](#)
 range boost [55](#)
 repeater mode [53](#)
 speed boost [55](#)
other documentation [2](#)

P

PBC [70](#)
PIN
 configuration [70](#)
product registration [129](#)

Q

quick start guide [2](#)

R

range boost mode [55](#)
registration
 product [129](#)
related documentation [2](#)
repeater mode [53](#)
Reset Button [12](#)
reset the device [32](#)
resetting
 factory default [32](#)
restore configuration [81](#)
RTS threshold [66](#)

S

security
 PBC [70](#)
 PIN [70](#)
service set identity. see SSID.
speed boost mode [55](#)
SSID [20](#), [26](#), [62](#)
subnet mask [61](#)
Summary
 Packet statistics [50](#)
 Wireless station status [51](#)
system [76](#)
system mode
 client mode [53](#)
 normal [54](#)
 range boost [55](#)
 repeater mode [53](#)
 speed boost [55](#)

W

warranty [129](#)
 note [129](#)
web configurator
 accessing [30](#)
 overview [30](#)
WEP Encryption [68](#)
Wireless association list [51](#)

- wireless channel [86](#)
- wireless LAN [86](#)
- wireless network
 - basic guidelines [62](#)
 - encryption [63](#)
 - security [62](#)
 - SSID [62](#)
- wireless security [62](#)
 - overview [62](#)
 - troubleshooting [86](#)
 - type [62](#)
- wizard setup [33](#)
- WPS [69](#)
 - screen [69](#)
- WPS button [12, 32](#)

