

BUFFALO™

User Manual for Professional Firmware WZR-HP-G300NH / WZR-HP-G300NH2 Nfiniti High Power Wireless N Router & Access Point



www.buffalotech.com

35011943 ver.01_

1.	Introduction	3
1.1.	Welcome	3
1.2.	Device Configuration	3
1.2.1.	Factory Settings	3
1.2.2.	Initial Operation	3
2.	Configuration via the Web Interface	4
2.1.	Preparation	4
2.2.	Web Interface Access	4
2.3.	Web Interface Structure	5
2.3.1.	Setup	6
2.3.1.1.	Basic Configuration	6
2.3.1.2.	Dynamic DNS (DynDNS or DDNS)	6
2.3.1.3.	MAC Address Cloning	7
2.3.1.4.	Advanced Routing	7
2.3.1.5.	Networking	7
2.3.1.6.	EoIP Tunnel	8
2.3.2.	Wireless	8
2.3.2.1.	Basic Settings	8
2.3.2.2.	Wireless Security	9
2.3.2.3.	AOSS/WPS	11
2.3.2.4.	MAC Filter	11
2.3.3.	Services	12
2.3.3.1.	Services	12
2.3.3.2.	FreeRadius	12
2.3.3.3.	PPPoE Server	12
2.3.3.4.	VPN	12
2.3.3.5.	USB	13
2.3.3.6.	NAS	13
2.3.3.7.	Hotspot	14
2.3.3.8.	Milkfish SIP Router	14
2.3.3.9.	My Ad Network	14
2.3.4.	Security	14
2.3.4.1.	Firewall	14
2.3.4.2.	VPN Pass-through	14
2.3.5.	Access Restrictions	14
2.3.5.1.	WAN Access	14
2.3.6.	NAT / QoS	14
2.3.6.1.	Port Forwarding	14
2.3.6.2.	Port Range Forwarding	15
2.3.6.3.	Port Triggering	15
2.3.6.4.	UPnP	15
2.3.6.5.	DMZ	15
2.3.6.6.	QoS	15
2.3.7.	Administration	15
2.3.7.1.	Management	15
2.3.7.2.	Keep Alive	16
2.3.7.3.	Commands	16
2.3.7.4.	WOL	16
2.3.7.5.	Factory Defaults	16
2.3.7.6.	Firmware Upgrade	16
2.3.7.7.	Backup	16
2.3.8.	Status	16
2.3.8.1.	Router	16
2.3.8.2.	WAN	16
2.3.8.3.	LAN	17
2.3.8.4.	Wireless	17
2.3.8.5.	Bandwidth	17

2.3.8.6. SysInfo	17
3. Use Cases	18
3.1. Access Point	18
3.1.1. Access Point with NAT / DHCP	18
3.1.1. Access Point attached to a network / Internet gateway	19
3.2. Wireless Client	20
3.3. Wireless Client Bridge	21
3.4. FTP Server	23
3.4.1. Examples	23
3.4.2. Logging into the FTP server	25
3.4.3. Common FTP commands	25
4. GPL Statement	27
4.1. GNU General Public License	27
4.1.1. Preamble	27
4.1.2. GNU General Public License - Terms and Conditions or Copying, Distribution and Modification	28
4.1.3. NO WARRANTY	31

1. Introduction

1.1. Welcome

This AirStation wireless router comes with two different firmware packages. You may use either the dd-wrt-based Professional firmware or the simple User-friendly firmware. By default, the Professional firmware is preinstalled for US/EU products, and the User-friendly firmware is preinstalled for Asia-Pacific products.

1.2. Device Configuration

From the factory, the router is configured as a network bridge. That means that all network interfaces can communicate with each other using this default bridge. The router is ready to use with a few simple adjustments.

1.2.1. Factory Settings

Because all interfaces are attached to the bridge by default, they all have the same IP configuration:

IP address	192.168.11.1
Subnet Mask	255.255.255.0
DHCP server	enabled
DHCP-Range	192.168.11.2 - 66

The Wireless LAN interface is activated by default with an SSID generated from the device's MAC address. For security, unused interfaces should be disabled. Wireless LAN interfaces that are not disabled should be configured with secure encryption (WPA2 or WPA is recommended) and a secure password.

1.2.2. Initial Operation

Connect your computer to the router with an Ethernet LAN cable and power the router on. It will take about 30 seconds to boot. You can then access it via telnet or web browser at the IP address 192.168.11.1. The DHCP server in the router is enabled by default. If your PC's Ethernet is configured for DHCP it should receive an IP address from the router's DHCP server. If not, please configure the Ethernet interface with an address from the 192.168.11.x subnet.

Because all relevant settings can be made using the web interface, this manual refers to configuration via the web GUI only.

2. Configuration via the Web Interface

The router contains an integrated web server that provides an easy to use web interface. It allows configuration, administration, and status checking in a simple but effective way.

When accessing the web GUI for the first time, change the default username and password. By default, the router's status page can be accessed without authentication, but this can be disabled.

The web interface was successfully tested on the following browsers:

- Internet Explorer 7.x and newer versions
- Firefox 2.x and newer versions
- Safari 2.x and newer versions

2.1. Preparation

Connect your PC to the router and power the router on as described in 1.2.2. After the router has loaded its operating system, you can communicate with it via your LAN network interface.

The easiest way to test if your PC can communicate with the router is to ping 192.168.11.1.

2.2. Web Interface Access

Open a browser window. Enter the address `http://192.168.11.1` into the address bar. The status page will be displayed.

When you click on a tab, the login window will pop up. Enter the username and password you previously set.

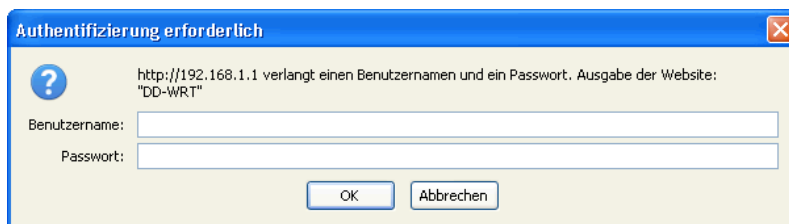

2.3. Web Interface Structure

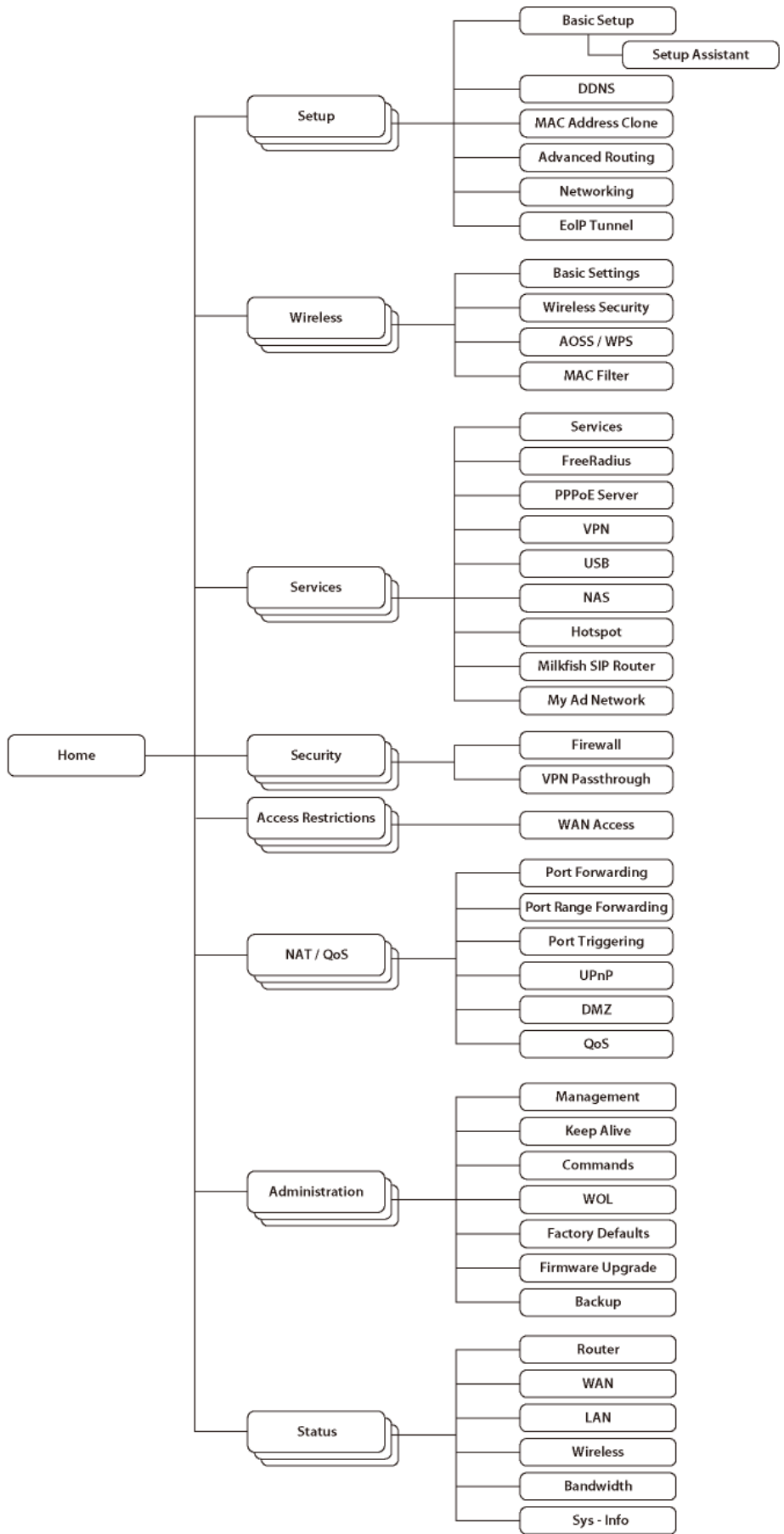

2.3.1. Setup

2.3.1.1. Basic Configuration

Setup Assistant

The setup assistant provides a step-by-step interface for basic router configuration. This configures most common settings automatically.

WAN Setup

Here you'll find the most important settings to configure your internet access and WAN port. DHCP is enabled by default, but you can also use PPPoE, PPTP, L2TP, static IP, or HeartBeat Signal. If you don't use a password to log in to your ISP, you may need to enter "0000" for the password. Also, for some ISPs you should not enter the service name, as it will prevent establishing the connection. If you experience connection problems, then leave the service name empty.

WAN Connection Type	Description
Disabled	The WAN port is disabled.
Static IP	A static IP address will be used - enter the IP address, subnet mask, gateway, and server manually.
Automatic Configuration - DHCP	The router obtains its WAN-side IP address from a DHCP server.
PPPoE	Configure as PPPoE-client. For VDSL, check the "VDSL-Tagging" box.
PPTP	Establishes connection via PPTP.
L2TP	Establishes connection via L2TP.
HeartBeat Signal	If you use a HeartBeat connection, consult your ISP for setup information. HeartBeat Signal is used only in Australia.

Network Setup

Network Setup configures the router's basic settings to match the local network. By default these settings are valid for all network ports except the WAN because they are all attached to the default bridge. If ports are disassociated from the bridge they will have different settings.

2.3.1.2. Dynamic DNS (DynDNS or DDNS)

Dynamic DNS allows the assignment of a DNS record to a dynamically assigned WAN-side IP address. A DynDNS client updates DNS records when your WAN-side IP address changes.

The router's firmware offers presets for the most common DynDNS services plus an option to define individual settings.

DynDNS Service	Description
Disabled	Default, no DynDNS
DynDNS.org	
freedns.afraid.org	
ZoneEdit.com	
No-IP.com	
3322.org	
easyDNS.com	
TZO.com	
DynSIP.org	
Custom	Individual DynDNS service configuration

2.3.1.3. MAC Address Cloning

MAC address cloning lets you assign a different MAC address to the router than the one encoded in the hardware.

2.3.1.4. Advanced Routing

Operating Mode

The default operating mode of the router is *Gateway*. Other routing protocols are available.

Modus	Description
Gateway	Gateway (default)
BGP	BGP Routing
Rip2 Router	Rip2 Routing
Router	Router

Static Routing

The Static Routing section lets you add static routes. The input parameters are equivalent to the parameters of the Linux command "route".

2.3.1.5. Networking

The Networking section allows detailed network configuration.

VLAN Tagging

Use this option to configure VLAN tagging.

Bridging

By default, one bridge (br0) is defined and active. In this section you can define additional bridges and change the interface assignment according to your requirements.

Bonding

Bonding offers the ability to "bond" interfaces together. Bonding can be used to enhance throughput or provide failover capabilities.

Port Setup

The port setup section allows further configuration of the routers network interfaces. Network interfaces can be separated from the bridge and it is possible to assign separate network settings for each interface. If an interface is separated from the bridge, add routing rules to allow communication between the interface and the bridge or other unbridged interfaces.

DHCPD

Besides the default DHCP server, you can define additional DHCP servers.

2.3.1.6. EoIP Tunnel

EoIP (Ethernet over IP) tunnels can transport Ethernet data packages via a tunnel over existing IP connections. You can define up to 10 tunnels that can also be bonded.

2.3.2. Wireless

2.3.2.1. Basic Settings

Each Wireless LAN interface has its own section in the wireless basic settings screen. The wireless interfaces are labelled ath0 and ath0.1 - ath0.4 depending on the number of radios installed. To correctly identify the antenna connectors, please compare the MAC addresses printed on the enclosure with the addresses displayed in the web interface.

Wireless Mode

This parameter is used to define the operating mode of the Wireless LAN interface. You can select among the following modes:

Modus	Description
AP	WLAN Access Point mode (default)
Client	WLAN Client mode
Client-Bridge	Client-Bridge mode allows connecting to another Wireless LAN access point and establishing a network bridge with that access point
Adhoc	Adhoc operating mode, required for building mesh networks
WDS Station	WDS Station is the client in a WDS-AP <-> WDS station bridge. This is a special wireless networking mode that offers better flexibility and security than the classical MAC address based WDS.
WDS AP	WDS AP is the AP side for WDS AP <-> WDS Station. A WDS AP allows connections from WDS Stations and Wireless Clients.

Wireless Network Mode

Defines the IEEE802.11 networking mode.

Mode	Description
Disabled	Interface is disabled
Mixed	2.4 GHz 802.11b / 802.11g / 802.11n mixed mode
B-Only	2.4 GHz 802.11b mode (802.11g and 802.11n devices cannot connect)
G-Only	2.4 GHz 802.11g mode (802.11b, and 802.11n devices cannot connect)
BG-Mixed	2.4 GHz 802.11b & 802.11g mixed mode (802.11n devices cannot connect)
NG-Mixed	2.4 GHz 802.11n & 802.11g mixed mode (802.11b devices cannot connect)
N-Only (2.4 GHz)	2.4 GHz 802.11n mode (802.11a, 802.11b, and 802.11g devices cannot connect)

Channel Width

Some wireless network modes support wireless channel widths besides the standard 20 MHz. 802.11g & 802.11n offer the option to use 40 MHz channels for enhanced throughput. Both the AP and the client must support 40 MHz channels to use them.

Wireless Channel (AP only)

Set the desired wireless channel, or let the router choose a free channel automatically. If the router is in classic WDS (MAC address based) mode, then the wireless channel must be selected manually.

Wireless Network Name (SSID)

The name of the wireless network the radio transmits or connects to (depending on the wireless mode)

Wireless SSID Broadcast (AP only)

The name of the wireless network (SSID) may be broadcasted or not. Not broadcasting does not prevent the network from being detected by a wireless network sniffer; it just hides the name.

Advanced Settings

Check this box to get access to advanced wireless settings. These advanced parameters should be only modified by experienced users.

2.3.2.2. Wireless Security

Because wireless data packets can easily be sniffed, wireless connections require a greater level of security to ensure that data cannot be read by unauthorized users.

Security Mode

Mode	Description
Disabled	No encryption set (not recommended!)

WPA Personal	WPA encryption with a passphrase (text password)
WPA Enterprise (AP only)	WPA encryption with Radius Client authentication according to 802.1x
WPA2 Personal	WPA2 encryption with a passphrase (text password)
WPA2 Enterprise (AP only)	WPA2 encryption with Radius Client authentication according to 802.1x
WPA2 Personal Mixed	WPA & WPA2 encryption in WPA/WPA2 mixed mode with a passphrase (text password)
WPA2 Enterprise Mixed (AP only)	WPA & WPA2 encryption in WPA/WPA2 mixed with Radius Client authentication according to 802.1x
RADIUS	
WEP	WEP 64 Bit / 128 Bit encryption (insecure; not recommended!)
802.1x (Client only)	Client side mode to connect to AP's working with WPA Enterprise Modes via RADIUS authentication

When using WEP encryption (not recommended), the user can choose between 64 bit and 128 bit keys. Keys can be entered as passphrases that are used to generate the Hex keys. Theoretically 128 bit keys offer a higher level of security but because of design flaws, that's not the case in actual use.

Key length	Description
64 Bit (10 Hexadecimal characters)	Standard
128 Bit (26 Hexadecimal characters)	

With WPA or WPA2 encryption, there are several encryption algorithms to choose from. AES is more secure but TKIP is more widely supported. There is also a TKIP + AES setting, but that does not offer more security than TKIP.

Algorithm	Description
TKIP	TKIP encryption, supported by most clients devices
AES	AES encryption offers a better level of security but might not be supported by a number of client devices and requires less CPU processing power.
TKIP + AES	Mixed mode - offers best compatibility but doesn't work in all environments

If RADIUS security is used, the MAC address format has to be set accordingly.

RADIUS MAC format options	Description
aabbcc-ddeeff	Standard
aabbccddeeff	
aa:bb:cc:dd:ee:ff	
aa-bb-cc-dd-ee-ff	

2.3.2.3. AOSS/WPS

AOSS (AirStation One-touch Secure Setup) is Buffalo Technology's system to automatically connect wireless clients to an access point. Just press the button on the AirStation, then press the button for the wireless client (which might be in its software). AOSS will connect the wireless devices automatically. AOSS is recommended if all of your wireless devices support it. AOSS can only be used in AP mode.

The WPS is a standard created by the Wi-Fi Alliance. There are two methods of configuration, PBC and PIN. PBC is similar to AOSS. PIN uses a unique PIN code to register the wireless client to the AirStation. If your wireless devices support it, WPS makes configuration simple and automatic.

Enable AOSS

Enables the AOSS Service. When disabled, AOSS cannot be used.

Start AOSS Negotiation

To initiate AOSS, either click the AOSS button in the GUI or hold down the AOSS button on the front of the router for 3 seconds.

Security Modes

You may choose which security modes are offered in the AOSS negotiation process. The use of WEP in general is not recommended due to security concerns.

WPS Button

Enables the WPS button. When disabled, WPS button cannot be used.

WPS PIN

Enter the PIN code printed on your client device or your client authentication application.

2.3.2.4. MAC Filter

The MAC Filter defines a list of client MAC addresses that are allowed to connect wirelessly. MAC addresses that aren't on the list aren't allowed to connect.

2.3.3. Services

2.3.3.1. Services

The services section allows the configuration of basic service settings. Telnet and SSH can be configured this way. Remote access options are configured in the *Administration* section.

Available DHCP Server Domains	Description
WAN	Standard
LAN / WLAN	

Rflow / MACupd Interface Options	Description
LAN & WLAN	Standard
LAN	
WLAN	

2.3.3.2. FreeRadius

Certain applications (for example, Chillispot hotspot software) benefit from a RADIUS server for management of user credentials and settings.

Server Certificate

This section contains the parameters to generate the RADIUS server certificate. The certificate needs to be generated before clients can be configured to connect to the RADIUS server.

Certificate Status

Displays the server certificate creation status.

Settings

Choose the port that the RADIUS server uses for client communication. The default port is 1812.

Clients

This section is used to define RADIUS clients (required for HotSpot usage).

Users

Lists the users defined in the RADIUS servers. Allows creation and modification of accounts.

2.3.3.3. PPPoE Server

Some applications require a PPPoE server on the router, which can be configured here. The PPPoE server is disabled by default.

2.3.3.4. VPN

The router can also be configured as VPN server or VPN client.

PPTP

When defining the PPTP server's IP range, avoid overlap with the range of IP addresses handed out by DHCP if DHCP is enabled. The IP range is defined using the following syntax:

```
xxx.xxx.xxx.<start-ip>-<end-ip>
```

for example

```
192.168.1.20-30
```

Enter client login data follows:

```
<username> * <password> *
```

for example

```
testuser * test *
```

The encryption options can be set as follows

PPTP server type	Settings
DD-WRT Router	mppe required (Standard)
Windows PPTP Server	mppe required,no40,no56,stateless <i>or</i> mppe required,no40,no56,stateful

OpenVPN

OpenVPN is a powerful and flexible VPN solution. OpenVPN security is based on certificates that cannot be created on the router itself. Please refer to OpenVPN's online documentation for instructions on creating certificates and configuring OpenVPN.

2.3.3.5. USB

The router's USB port can be used for several purposes. Here the basic and advanced USB parameters are defined. Besides enabling USB and defining the USB hardware standard to use you can also define if printer and storage support for USB shall be enabled.

2.3.3.6. NAS

If USB hard drive support is enabled, you can start the integrated ProFTPD server to share data on an attached hard disk via FTP.

The User/Password data are entered as follows:

```
<username> * <password> *
```

for example

```
testuser * test *
```

Be careful enabling anonymous login. If anonymous login is enabled, everyone accessing your network has permission to read and write data.

2.3.3.7. Hotspot

Most hotspot software requires a server to store user settings and login information. Please note that Sputnik is a commercial hotspot service that requires an agreement with Sputnik for usage.

2.3.3.8. Milkfish SIP Router

This package is an implementation of the Milkfish SIP router.

2.3.3.9. My Ad Network

Allows the creation of an AnchorFree Hotspot that can be used to create revenue via AnchorFree.

2.3.4. Security

2.3.4.1. Firewall

Aside from enabling and disabling the firewall, you can also set additional filters, block certain network requests for the WAN interface, and manage logs.

2.3.4.2. VPN Pass-through

VPN settings effect how the firewall handles IPsec, PPTP, and L2TP connections. By default, pass-through is enabled. Please note that disabling pass-through will usually prevent you from establishing VPN connections from computers located in your local network to VPN servers on the internet.

2.3.5. Access Restrictions

2.3.5.1. WAN Access

The WAN access settings allow the definition of time and service related access rules.

2.3.6. NAT / QoS

2.3.6.1. Port Forwarding

Port forwarding allows the assigning of WAN ports to specific internal IP addresses and matching ports. Bidirectional external traffic can be forwarded to specific internal devices and computers. Each port forwarding entry defines a source port and a target IP address.

Before adding or removing a port forwarding entry, save all changed settings. Any changes not saved will be lost when a port forwarding entry is added or deleted.

2.3.6.2. Port Range Forwarding

Port range forwarding works similarly to port forwarding. Unlike port forwarding, instead of a single port, a range of ports is forwarded to the same range of ports at the internal target IP address.

2.3.6.3. Port Triggering

Port triggering is a kind of port range forwarding where outgoing traffic on specific ports enables previously defined port forwards for the activating device. This temporarily opens required ports when specific applications are opened on computers on the LAN. This offers a greater level of security than port forwarding or port range forwarding because the ports are only opened when needed.

2.3.6.4. UPnP

UPnP allows UPnP capable applications and devices to open and close required ports automatically as needed. This is simple to use and does not require further configuration steps.

2.3.6.5. DMZ

A DMZ computer is a special computer in the internal network that gets all incoming traffic forwarded. The task of that computer is managing this traffic. When the DMZ feature is activated the internal firewall is activated. This can pose a security issue if not handled with care. Furthermore, several services of the router, that have to be accessible from the WAN side, will not work because the associated traffic is forwarded to the DMZ computer.

2.3.6.6. QoS

QoS (Quality of Service) is a procedure to prioritise network traffic by application. Specific services can be assigned specific bandwidth.

Aside from upstream and downstream bandwidth, you can define settings for specific services and IP and MAC address ranges.

2.3.7. Administration

2.3.7.1. Management

The Management section contains settings for remotely accessing the router and other basic settings that are usually not changed. The settings for the language used in the Web GUI are also located here. You may choose between Chinese (simplified & traditional), Croatian, Dutch, French, German, Hungarian, Italian, Japanese, Latvian, Polish, Portuguese, Romanian, Russian, Slovenian, Spanish, and Swedish. The default setting is English.

Before using Telnet or SSH, activate the associated service(s) in this section.

2.3.7.2. Keep Alive

Keep-Alive lets you configure monitoring options that automatically reboot the router if a service malfunction causes it to fail to respond.

2.3.7.3. Commands

Entering Linux commands is one of the most powerful ways to access the router's functionality. This enables you to access services and configure options that are not accessible via the Web GUI. Using shell commands can lead to unexpected results. Use them with utmost care.

Aside from executing the shell commands directly you can also save custom start up and firewall scripts.

2.3.7.4. WOL

With Wake-on-LAN, you can send special data packets to compatible devices on your LAN, causing them to exit sleep mode.

WOL data packets can be triggered manually or scheduled automatically.

2.3.7.5. Factory Defaults

With this feature you can reset the router's settings to factory defaults. After a reset, the router will restart.

2.3.7.6. Firmware Upgrade

The firmware upgrade option can be used to install a different firmware version. When doing this you can choose if the router's settings will be restored to factory defaults or kept.

2.3.7.7. Backup

You can use this feature to store your current configuration into a backup file, or to restore from a previously stored configuration. This also makes it simple to set up a number of routers with the exact same configuration.

2.3.8. Status

2.3.8.1. Router

The status screen displays information about the router, such as cpu load, memory consumption, and currently active IP connections. Status is updated automatically.

2.3.8.2. WAN

If the WAN interface is enabled, this screen displays WAN settings and throughput statistics.

2.3.8.3. LAN

Here you can find LAN-related information like active clients and DHCP clients.

2.3.8.4. Wireless

The wireless LAN status screen displays the current wireless LAN interface configuration, wireless LAN clients (in AP modes), and access points (in client modes). If there's more than one wireless LAN interface, you can switch between them via the interface pull down menu.

2.3.8.5. Bandwidth

Bandwidth monitoring displays real time diagrams for incoming and outgoing traffic for each network interface.

2.3.8.6. SysInfo

The SysInfo screen combines the most important information of the other status pages. By default, the SysInfo page can be accessed from LAN devices without authentication. That can be changed in the *Management* section of the *Administration* area.

3. Use Cases

The following use cases relate to the most commonly used router configurations. The related router configuration is explained step by step.

3.1. Access Point

Access Point (AP, sometimes also called "Infrastructure Mode") is the mode where the router is also the central wireless hub that connects to the LAN and provides access to wireless devices. These wireless clients of the AP can communicate with each other and with wired devices on the network such as the Internet.

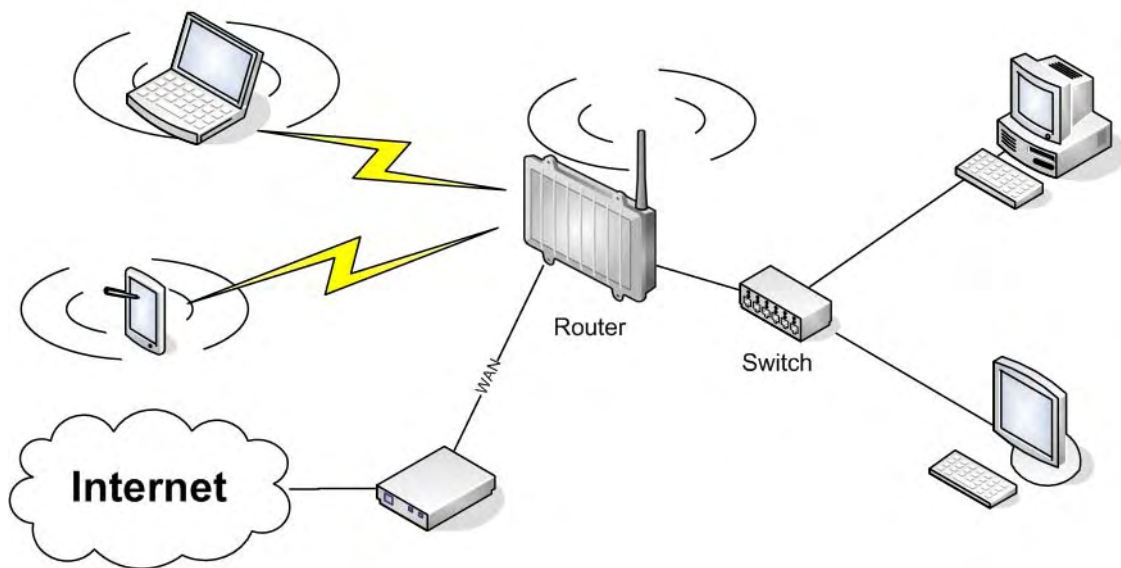

Connect your computer to the router as described in 2.1. and access the web interface according to 2.2.

3.1.1. Access Point with NAT / DHCP

Setup -> Basic Setup

- *WAN Setup*
 - In "Connection Type", choose the type of WAN connection you want to use and complete the related settings.
- *Network Setup*
 - Enter the desired LAN IP address for the router into "Router IP".
 - Set "DHCP Type" to "DHCP Server" (this is the default).
 - "Enable" DHCP Server (this is the default).
 - Adjust the DHCP address range to match your requirements.
- *Time Settings*
 - Choose your time zone.
- Click "Save".

Wireless -> Basic Settings

- Enter your country in "Regulatory Domain"
- In the "Antenna Gain" field, please enter the gain of the antenna on your router. The firmware will adjust the transmit power accordingly to meet regulatory requirements. Please keep in mind that very long cables can dampen the HF signal thus reducing the usable antenna gain.
- Configure "Wireless Mode" to "AP"
- Set your desired wireless mode in "Wireless Network Mode". Please note that mixed modes will lead to reduced performance because of maintaining compatibility.
- Enter a name for your wireless network into "Wireless Network Name (SSID)"
- Click "Save"

Wireless -> Wireless Security

- Choose and configure a security mode. Please note that WEP is insecure and should only be used if no other option is available.
- Click "Apply Settings"

You can now connect the router to the Internet and your local network. After you successfully connect wireless devices, they will then be displayed on the "SysInfo" and "WLAN Status" pages.

3.1.1. Access Point attached to a network / Internet gateway

Setup -> Basic Setup

- *WAN Setup*
 - For "Connection Type", choose "Disabled".
- *Network Setup*
 - Enter the desired LAN-side IP address for the router into "Router IP".
 - Set the "DHCP Type" to "DHCP Server" (this is the default).
 - "Disable" "DHCP Server".
- *Time Settings*
 - Choose your time zone.
- Click "Save".

Wireless -> Basic Settings

- Enter your country in "Regulatory Domain"
- In the "Antenna Gain" field, please enter the gain of the antenna on your router. The firmware will adjust the transmit power accordingly to meet regulatory requirements. Please keep in mind that very long cables can dampen the HF signal thus reducing the usable antenna gain.
- Configure "Wireless Mode" to "AP"
- Choose a wireless mode in "Wireless Network Mode". Please note that mixed modes will lead to reduced performance because of maintaining compatibility.

- Enter a name for your wireless network into "Wireless Network Name (SSID)".
- Click "Save".

Wireless -> Wireless Security

- Choose and configure your desired security mode. Please note that WEP is insecure and should only be used if no other option is available.
- Click "Apply Settings"

You can now connect the router to the Internet and your local network. If you're running a DHCP server in your LAN, connected wireless devices will get their IP addresses from the server.

3.2. Wireless Client

The router can be also used as a wireless LAN client. This can be useful if you want to connect devices to your wireless LAN that do not have a wireless LAN interface. In this configuration, the wireless LAN interface acts as a wireless client. Attached wired Ethernet devices can also access the WAN through the wireless connection.

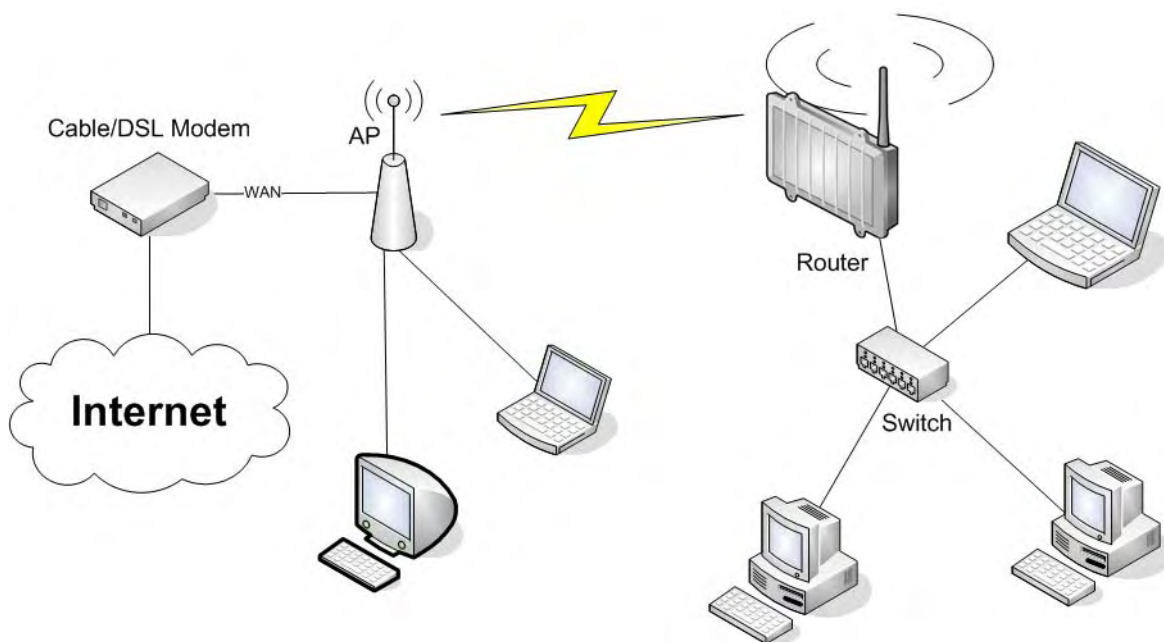

Setup -> Basic Setup

- *WAN Setup*
 - o Set "Connection Type" to "DHCP" to have the AirStation get its IP address from a DHCP server, or to a "Static IP" if no DHCP server is available.
- *Network Setup*
 - o Enter the desired LAN-side IP address for the router in "Router IP".
 - o Set the "DHCP Type" to "DHCP Server" (this is the default setting).
 - o "Enable" "DHCP Server" (this is the default setting).
 - o Adjust the DHCP address range to match your requirements.

- *Time Settings*
 - Choose your time zone.
- Click "Save".

Wireless -> Basic Settings

- Enter your country in "Regulatory Domain"
- In the "Antenna Gain" field, please enter the gain of your AirStation's antenna. The firmware will adjust the transmit power automatically to meet regulatory requirements. Please note that the use of a long extension cable for your antenna will reduce the usable antenna gain.
- Configure "Wireless Mode" to "Client".
- Configure "Wireless Network Mode" to match the capabilities of the access point you want to connect to.
- Enter the network name (SSID) of the AP you want to connect to into "Wireless Network Name (SSID)".
- Click "Save".

Wireless -> Wireless Security

- Configure the security mode to match the security settings of the access point you want to connect to.
- Click "Apply Settings".

After the router reboots, please confirm that it has connected to the access point. If there is a DHCP server available on the access point side, and the router is configured to request an IP address, then it should receive an IP address for its WAN-side interface.

You can now either connect wired clients to the access point or configure another wireless network interface as an access point to grant access to wireless clients.

3.3. Wireless Client Bridge

A wireless client bridge offers the ability to transparently integrate the router's LAN into a different LAN that another access point is connected to. Clients connected to such a router can access devices in both LANs and vice versa. In that configuration the router's WAN interface is disabled.

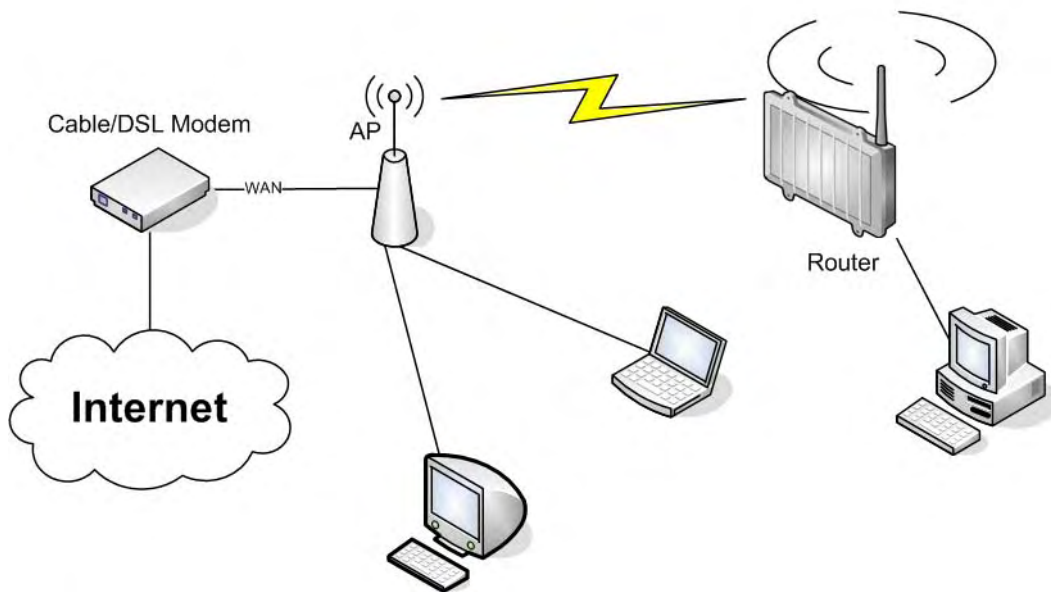

Setup -> Basic Setup

- *WAN Setup*
 - o Choose "Disabled" for "Connection Type" (this will be set automatically).
- *Network Setup*
 - o Enter the desired LAN-side IP address for the router into "Router IP".
 - o "Disable" "DHCP Server".
- *Time Settings*
 - o Choose your time zone.
- Click "Save".

Wireless -> Basic Settings

- Enter your country in "Regulatory Domain".
- In the "Antenna Gain" field, please enter the gain of your AirStation's antenna. The firmware will adjust the transmit power automatically to meet regulatory requirements. Please note that the use of a long extension cable for your antenna will reduce the usable antenna gain.
- Configure "Wireless Mode" to "Client Bridge".
- Set "Wireless Network Mode" to match the access point you want to connect to.
- Enter the network name (SSID) of the AP you want to connect to.
- Click "Save".

Wireless -> Wireless Security

- Configure security to match the security settings of the access point you want to connect to.
- Click "Apply Settings".

After the router reboots, please confirm that it has connected to the access point. If there is a DHCP server available on the access point

side, a pc in the router's LAN configured to request an address from DHCP should receive an IP address.

3.4. FTP Server

The router can be used as an FTP server when a USB disk (such as a hard disk or flash memory device) is connected to the USB port on the rear of the router.

3.4.1. Examples

Services -> USB

·Make the settings in the USB Support section, then click [Apply Settings].

USB Support

Core USB Support Enable Disable

USB 1.1 Support (UHCI) Enable Disable

USB 1.1 Support (OHCI) Enable Disable

USB 2.0 Support Enable Disable

USB Printer Support Enable Disable

USB Storage Support Enable Disable

Automatic Drive Mount Enable Disable

Run-on-mount Script Name

Disk Mount Point

Disk Info

Examples:

Core USB Support	Enabled
USB 1.1 Support (UHCI)	Enabled
USB 1.1 Support (OHCI)	Enabled
USB 2.0 Support	Enabled
USB Storage Support	Enabled
Automatic Drive Mount	Enabled
Run-on-mount Script Name	blank
Disk Mount Point	/mnt

•Connect a USB disk to the router.

After a short wait, the disk information is displayed in the Disk Info section.

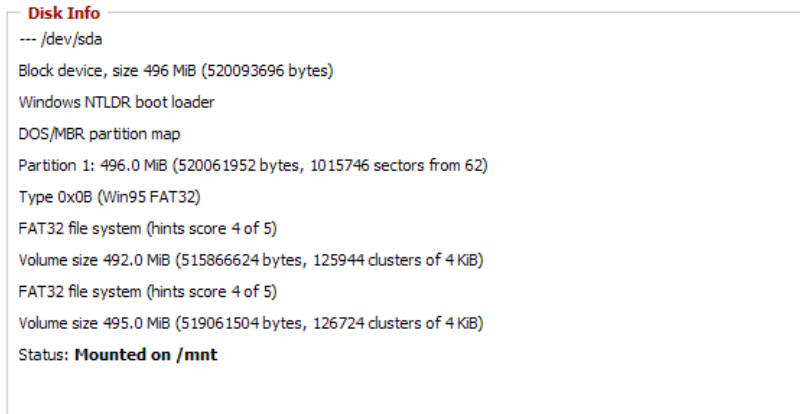

Services -> NAS

•Make the settings in the ProFTPD section, and click [Apply Settings].

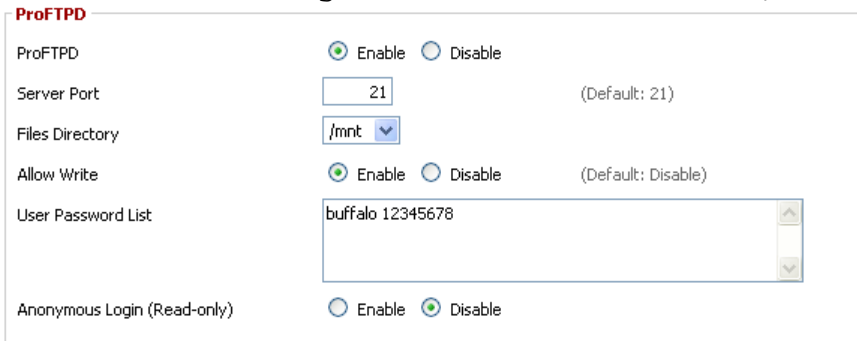

Setting example:

ProFTPD	Enable
Server Port	21
Files Directory	/mnt
Allow Write	Enable
User Password List	buffalo 12345678
Anonymous Login (Read-only)	Disable

Separate the username (example: buffalo) and password (example: 12345678) with a space.

3.4.2. Logging into the FTP server

- Open a command prompt window.
- Enter "ftp 192.168.11.1" to access the FTP server.
- Enter the user name, and press the Enter key.
- Enter the password, and press the Enter key.
- When the login is successful, "ftp>" appears on the screen.
- To logout, enter the "bye" command.

```
Microsoft Windows [Version 6.1.7600]
Copyright (c) 2009 Microsoft Corporation. All rights reserved.

C:\Users\John>ftp 192.168.11.1
Connected to 192.168.11.1.
220 ProFTPD 1.3.3 Server (DD-WRT) [192.168.11.1]
User (192.168.11.1:(none)): buffalo
331 Password required for buffalo
Password:
230 User buffalo logged in
ftp>
```

3.4.3. Common FTP commands

Command	Description	Entry example
ftp	Starts FTP	ftp
ls	Displays a list of the remote directory's files	ls
pwd	Displays the current directory on the remote computer	pwd
cd	Changes the current working directory on the remote computer	cd img
mkdir	Creates a remote directory	mkdir test
rmdir	Deletes a remote directory	rmdir test
lcd	Changes the current working directory on the local computer	lcd E:\test
asc	Switches to ASCII transfer mode	asc
bin	Switches to binary transfer mode	bin
put	Uploads a file to the remote computer	put test.pdf
mput	Uploads multiple files to the remote computer	mput test1.jpg test2.jpg test3.jpg
get	Downloads a file to the local computer	get index.html
mget	Downloads multiple files to the local computer	mget test1.jpg test2.jpg test3.jpg

delete	Deletes a file on the remote computer	delete test1.jpg
mdelete	Deletes multiple files on the remote computer	mdelete test1.jpg test2.jpg test3.jpg
rename	Renames a file on the remote computer	rename test1.jpg new1.jpg
help	Displays the Help for FTP commands	help
bye	Exits FTP	bye

4. GPL Statement

The firmware that is used in this product includes software that is subject to the GNU Public Licence (GPL)/the GNU Lesser Public Licence (LGPL). To the extent that it is applicable within the context of the GPL and the LGPL, the conditions of the GPL and the LGPL, as well as the relevant source codes, are available from the manufacturer. The code underlying the GPL/LGPL for the software shall be provided, without any ensuing warranty or liability claims. Please see the conditions of the GPL/LGPL for further details.

4.1. GNU General Public License

Version 2, June 1991

Copyright (C) 1989, 1991 Free Software Foundation, Inc. 51 Franklin Street, Fifth Floor, Boston, MA 02110-1301, USA

Everyone is permitted to copy and distribute verbatim copies of this license document, but changing it is not allowed.

4.1.1. Preamble

The licenses for most software are designed to take away your freedom to share and change it. By contrast, the GNU General Public License is intended to guarantee your freedom to share and change free software--to make sure the software is free for all its users. This General Public License applies to most of the Free Software Foundation's software and to any other program whose authors commit to using it. (Some other Free Software Foundation software is covered by the GNU Library General Public License instead.) You can apply it to your programs, too.

When we speak of free software, we are referring to freedom, not price. Our General Public Licenses are designed to make sure that you have the freedom to distribute copies of free software (and charge for this service if you wish), that you receive source code or can get it if you want it, that you can change the software or use pieces of it in new free programs; and that you know you can do these things.

To protect your rights, we need to make restrictions that forbid anyone to deny you these rights or to ask you to surrender the rights. These restrictions translate to certain responsibilities for you if you distribute copies of the software, or if you modify it.

For example, if you distribute copies of such a program, whether gratis or for a fee, you must give the recipients all the rights that you have. You must make sure that they, too, receive or can get the source code. And you must show them these terms so they know their rights.

We protect your rights with two steps: (1) copyright the software, and (2) offer you this license which gives you legal permission to copy, distribute and/or modify the software.

Also, for each author's protection and ours, we want to make certain that everyone understands that there is no warranty for this free

software. If the software is modified by someone else and passed on, we want its recipients to know that what they have is not the original, so that any problems introduced by others will not reflect on the original authors' reputations.

Finally, any free program is threatened constantly by software patents. We wish to avoid the danger that redistributors of a free program will individually obtain patent licenses, in effect making the program proprietary. To prevent this, we have made it clear that any patent must be licensed for everyone's free use or not licensed at all.

The precise terms and conditions for copying, distribution and modification follow.

4.1.2. GNU General Public License - Terms and Conditions of Copying, Distribution and Modification

0. This License applies to any program or other work which contains a notice placed by the copyright holder saying it may be distributed under the terms of this General Public License. The "Program", below, refers to any such program or work, and a "work based on the Program" means either the Program or any derivative work under copyright law: that is to say, a work containing the Program or a portion of it, either verbatim or with modifications and/or translated into another language. (Hereinafter, translation is included without limitation in the term "modification".) Each licensee is addressed as "you".

Activities other than copying, distribution and modification are not covered by this License; they are outside its scope. The act of running the Program is not restricted, and the output from the Program is covered only if its contents constitute a work based on the Program (independent of having been made by running the Program). Whether that is true depends on what the Program does.

1. You may copy and distribute verbatim copies of the Program's source code as you receive it, in any medium, provided that you conspicuously and appropriately publish on each copy an appropriate copyright notice and disclaimer of warranty; keep intact all the notices that refer to this License and to the absence of any warranty; and give any other recipients of the Program a copy of this License along with the Program.

You may charge a fee for the physical act of transferring a copy, and you may at your option offer warranty protection in exchange for a fee.

2. You may modify your copy or copies of the Program or any portion of it, thus forming a work based on the Program, and copy and distribute such modifications or work under the terms of Section 1 above, provided that you also meet all of these conditions:

a) You must cause the modified files to carry prominent notices stating that you changed the files and the date of any change.

b) You must cause any work that you distribute or publish, that in whole or in part contains or is derived from the Program or any part

thereof, to be licensed as a whole at no charge to all third parties under the terms of this License.

c) If the modified program normally reads commands interactively when run, you must cause it, when started running for such interactive use in the most ordinary way, to print or display an announcement including an appropriate copyright notice and a notice that there is no warranty (or else, saying that you provide a warranty) and that users may redistribute the program under these conditions, and telling the user how to view a copy of this License. (Exception: if the Program itself is interactive but does not normally print such an announcement, your work based on the Program is not required to print an announcement.)

These requirements apply to the modified work as a whole. If identifiable sections of that work are not derived from the Program, and can be reasonably considered independent and separate works in themselves, then this License, and its terms, do not apply to those sections when you distribute them as separate works. But when you distribute the same sections as part of a whole which is a work based on the Program, the distribution of the whole must be on the terms of this License, whose permissions for other licensees extend to the entire whole, and thus to each and every part regardless of who wrote it.

Thus, it is not the intent of this section to claim rights or contest your rights to work written entirely by you; rather, the intent is to exercise the right to control the distribution of derivative or collective works based on the Program.

In addition, mere aggregation of another work not based on the Program with the Program (or with a work based on the Program) on a volume of a storage or distribution medium does not bring the other work under the scope of this License.

3. You may copy and distribute the Program (or a work based on it, under Section 2) in object code or executable form under the terms of Sections 1 and 2 above provided that you also do one of the following:

a) Accompany it with the complete corresponding machine-readable source code, which must be distributed under the terms of Sections 1 and 2 above on a medium customarily used for software interchange; or,

b) Accompany it with a written offer, valid for at least three years, to give any third party, for a charge no more than your cost of physically performing source distribution, a complete machine-readable copy of the corresponding source code, to be distributed under the terms of Sections 1 and 2 above on a medium customarily used for software interchange; or,

c) Accompany it with the information you received as to the offer to distribute corresponding source code. (This alternative is allowed only for non-commercial distribution and only if you received the program in object code or executable form with such an offer, in accord with Subsection b above.)

The source code for a work means the preferred form of the work for making modifications to it. For an executable work, complete source code means all the source code for all modules it contains, plus any associated interface definition files, plus the scripts used to control compilation and installation of the executable. However, as a special exception, the source code distributed need not include anything that is normally distributed (in either source or binary form) with the major components (compiler, kernel, and so on) of the operating system on which the executable runs, unless that component itself accompanies the executable.

If distribution of executable or object code is made by offering access to copy from a designated place, then offering equivalent access to copy the source code from the same place counts as distribution of the source code, even though third parties are not compelled to copy the source along with the object code.

4. You may not copy, modify, sublicense, or distribute the Program except as expressly provided under this License. Any attempt otherwise to copy, modify, sublicense or distribute the Program is void, and will automatically terminate your rights under this License. However, parties who have received copies, or rights, from you under this License will not have their licenses terminated so long as such parties remain in full compliance.

5. You are not required to accept this License, since you have not signed it. However, nothing else grants you permission to modify or distribute the Program or its derivative works. These actions are prohibited by law if you do not accept this License. Therefore, by modifying or distributing the Program (or any work based on the Program), you indicate your acceptance of this License to do so, and all its terms and conditions for copying, distributing or modifying the Program or works based on it.

6. Each time you redistribute the Program (or any work based on the Program), the recipient automatically receives a license from the original licensor to copy, distribute or modify the Program subject to these terms and conditions. You may not impose any further restrictions on the recipients' exercise of the rights granted herein. You are not responsible for enforcing compliance by third parties to this License.

7. If, as a consequence of a court judgment or allegation of patent infringement or for any other reason (not limited to patent issues), conditions are imposed on you (whether by court order, agreement or otherwise) that contradict the conditions of this License, they do not excuse you from the conditions of this License. If you cannot distribute so as to satisfy simultaneously your obligations under this License and any other pertinent obligations, then as a consequence you may not distribute the Program at all. For example, if a patent license would not permit royalty-free redistribution of the Program by all those who receive copies directly or indirectly through you, then the only way you could satisfy both it and this License would be to refrain entirely from distribution of the Program.

If any portion of this section is held invalid or unenforceable under any particular circumstance, the balance of the section is intended to

apply and the section as a whole is intended to apply in other circumstances.

It is not the purpose of this section to induce you to infringe any patents or other property right claims or to contest validity of any such claims; this section has the sole purpose of protecting the integrity of the free software distribution system, which is implemented by public license practices. Many people have made generous contributions to the wide range of software distributed through that system in reliance on consistent application of that system; it is up to the author/donor to decide if he or she is willing to distribute software through any other system and a licensee cannot impose that choice.

This section is intended to make thoroughly clear what is believed to be a consequence of the rest of this License.

8. If the distribution and/or use of the Program is restricted in certain countries either by patents or by copyrighted interfaces, the original copyright holder who places the Program under this License may add an explicit geographical distribution limitation excluding those countries, so that distribution is permitted only in or among countries not thus excluded. In such case, this License incorporates the limitation as if written in the body of this License.

9. The Free Software Foundation may publish revised and/or new versions of the General Public License from time to time. Such new versions will be similar in spirit to the present version, but may differ in detail to address new problems or concerns.

Each version is given a distinguishing version number. If the Program specifies a version number of this License which applies to it and "any later version", you have the option of following the terms and conditions either of that version or of any later version published by the Free Software Foundation. If the Program does not specify a version number of this License, you may choose any version ever published by the Free Software Foundation.

10. If you wish to incorporate parts of the Program into other free programs whose distribution conditions are different, write to the author to ask for permission. For software which is copyrighted by the Free Software Foundation, write to the Free Software Foundation; we sometimes make exceptions for this. Our decision will be guided by the two goals of preserving the free status of all derivatives of our free software and of promoting the sharing and reuse of software generally.

4.1.3. NO WARRANTY

11. BECAUSE THE PROGRAM IS LICENSED FREE OF CHARGE, THERE IS NO WARRANTY FOR THE PROGRAM, TO THE EXTENT PERMITTED BY APPLICABLE LAW. EXCEPT WHEN OTHERWISE STATED IN WRITING THE COPYRIGHT HOLDERS AND/OR OTHER PARTIES PROVIDE THE PROGRAM "AS IS" WITHOUT WARRANTY OF ANY KIND, EITHER EXPRESSED OR IMPLIED, INCLUDING, BUT NOT LIMITED TO, THE IMPLIED WARRANTIES OF MERCHANTABILITY AND FITNESS FOR A PARTICULAR

PURPOSE. THE ENTIRE RISK AS TO THE QUALITY AND PERFORMANCE OF THE PROGRAM IS WITH YOU. SHOULD THE PROGRAM PROVE DEFECTIVE, YOU ASSUME THE COST OF ALL NECESSARY SERVICING, REPAIR OR CORRECTION.

12. IN NO EVENT UNLESS REQUIRED BY APPLICABLE LAW OR AGREED TO IN WRITING WILL ANY COPYRIGHT HOLDER, OR ANY OTHER PARTY WHO MAY MODIFY AND/OR REDISTRIBUTE THE PROGRAM AS PERMITTED ABOVE, BE LIABLE TO YOU FOR DAMAGES, INCLUDING ANY GENERAL, SPECIAL, INCIDENTAL OR CONSEQUENTIAL DAMAGES ARISING OUT OF THE USE OR INABILITY TO USE THE PROGRAM (INCLUDING BUT NOT LIMITED TO LOSS OF DATA OR DATA BEING RENDERED INACCURATE OR LOSSES SUSTAINED BY YOU OR THIRD PARTIES OR A FAILURE OF THE PROGRAM TO OPERATE WITH ANY OTHER PROGRAMS), EVEN IF SUCH HOLDER OR OTHER PARTY HAS BEEN ADVISED OF THE POSSIBILITY OF SUCH DAMAGES.

User Manual for User-friendly Firmware

Nfiniti High Power Wireless Router & Access Point

WZR-HP-G300NH / WZR-HP-G300NH2



www.buffalotech.com

35011944 ver.01

Contents

Chapter 1 - Product Overview	6
Features	6
AirNavigator CD Requirements.....	8
300 Mbps High Speed Mode.....	8
Package Contents.....	8
Hardware Overview.....	9
Front Panel LEDs.....	9
Back Panel.....	11
Bottom.....	12
Right Side	13
Chapter 2 - Placing Your AirStation	14
Vertical Placement	14
Horizontal Placement.....	14
Wall-Mounting	15
Chapter 3 - Installation.....	16
Automatic Setup.....	16
Windows 7 / Vista / XP.....	16
Mac OS X.....	16
Other OS.....	16
Manual Setup.....	17
Windows	20
Macintosh.....	23
Chapter 4 - Configuration	25
Accessing the Web-based Configuration Interface	25
Configuration Interface Menus in Router Mode	27

Configuration Interface Menus in Bridge Mode	29
Setup	31
Internet/LAN (LAN Config)	33
Internet (Router Mode only)	33
PPPoE (Router Mode only).....	34
DDNS (Router Mode only).....	37
VPN server (Router Mode Only).....	39
LAN	41
DHCP Lease (Router Mode only)	43
NAT (Router Mode only)	44
Route	45
Wireless Config.....	46
WPS.....	46
AOSS	47
Basic	49
Advanced	52
WMM.....	53
MAC Filter	55
Multicast Control	56
WDS.....	57
Security (Router Mode only)	59
Firewall (Router Mode only).....	59
IP Filter (Router Mode only).....	61
VPN Passthrough (Router Mode only).....	62
LAN Config.....	63
Port Forwarding (Router Mode only).....	63
DMZ (Router Mode only)	64
UPnP (Router Mode only).....	65
QoS (Router Mode only).....	66
Movie Engine (QoS)	68
NAS.....	70
Disk management.....	70
Shared Folder	72

User Management	74
Shared Service	75
Web Access	76
Media Server.....	78
BitTorrent.....	79
Admin Config.....	81
Name	81
Password	82
Time/Date	83
NTP.....	84
ECO	85
Network-USB	87
Access	88
Log.....	89
Save/Restore	90
Initialize/Restart	91
Update	92
Diagnostic	93
System Info.....	93
Logs	95
Packet Info.....	96
Client Monitor.....	97
Ping.....	98

Chapter 5 - Connect to a Wireless Network 99

Automatic Secure Setup (AOSS/WPS).....	99
Windows 7/Vista (Client Manager V)	100
Windows XP (Client Manager 3).....	101
Mac OS X (AOSS Assistant).....	102
Other Devices (e.g. Game Console).....	103
Manual Setup.....	103
Windows 7 (WLAN AutoConfig).....	103
Windows Vista (WLAN AutoConfig).....	104

Windows XP (Wireless Zero Configuration).....	107
Mac OS X (AirPort)	108

Chapter 6 - Troubleshooting..... 109

Cannot connect to the Internet over wired connection.....	109
Cannot access the web-based configuration Interface.	109
Cannot connect to the network wirelessly.	110
You forgot AirStation's SSID, Encryption Key, or Password....	110
The link speed is slower than 300 Mbps (Maximum link speed is only 130 Mbps).....	110
Other Tips.....	111

Chapter 7 - Default Configuration Settings..... 113

Chapter 8 - Network-USB Navigator 120

Initial Setup for Windows Users	120
Initial Setup for Mac Users	125
Opening the Network-USB User Manual	128
How to use Network-USB	129

Chapter 9 - Checking Wireless Signal Quality..... 130

Windows 7/Vista.....	130
Macintosh.....	131

Chapter 10 - TCP/IP Settings 133

Windows 7.....	133
Windows Vista.....	134
Windows XP	135
Mac OS X.....	136

Chapter 11 - Restoring the Default Configuration 137

Chapter 12 - Shared Folders and the USB Port 138

Chapter 1 - Product Overview

Installing Your AirStation

To install your AirStation, insert the software CD from your package into your computer and follow the directions on the screen. For more information about installation, turn to chapter 3 of this manual.

Professional or User-friendly?

This AirStation wireless router comes with two different firmware packages. You may use either the dd-wrt-based Professional firmware or the simple User-friendly firmware. By default, the Professional firmware is preinstalled for US/EU products, and the User-friendly firmware is preinstalled for Asia-Pacific products. Turn to page 20 for instructions on switching between the two firmware packages.

Note : Most of this manual documents the user-friendly version of the firmware. For more information on the dd-wrt-based professional firmware, consult the help files in its web-based configuration interface or the *WZR-HP-G300NH / WZR-HP-G300NH2 User Manual for Professional Firmware*, available for download from Buffalo Technology.

Features

Supports IEEE802.11n and IEEE802.11b/g

With support for current Wireless-N, Wireless-G, and Wireless-B standards, the AirStation can transfer data to and from all standard 2.4 GHz wireless clients.

Dual speed mode

Dual speed mode makes wireless transmission faster by using 2 channels, allowing 300 Mbps data transmission.

Supports AOSS and WPS

Both AOSS (AirStation One-touch Secure System) and WPS (Wi-Fi Protected Setup) are supported. These automatic connection standards make connection with compatible wireless devices easier.

Security Features

The AirStation is equipped with the following security features:

- AOSS
- WPS
- WPA-PSK (TKIP/AES)
- WPA2-PSK(TKIP/AES)
- WPA/WPA2 mixed PSK
- WEP (64-bit and 128-bit)
- Privacy Separator
- MAC address access restriction
- Deny Any Connection/SSID stealth
- Password for web-based control interface
- Firewall with easy rules

Automatic Channel Selection

Monitors wireless interference and automatically assigns the clearest, best channel.

Roaming

You can use multiple AirStations to cover a large area. Wireless clients can automatically switch AirStations for the best signal.

Initialization

To restore settings back to the factory defaults, hold down the Reset button on the bottom of the unit.

Browser Based Administration

This unit can be easily configured from a web browser on your computer.

Auto Mode (Router/Bridge Automatic Recognition)

In Auto mode, the AirStation will detect whether or not your network has a router and automatically switch to the appropriate router or bridge mode. You can also manually switch between modes. (See page 11.)

MovieEngine

MovieEngine uses QoS to optimise your network for multimedia streaming. This can reduce jumps, distorted audio, and dropped frames while watching streamed video.

NAS (Network Attached Storage)

Attach a USB hard drive to the AirStation and share it on the network as a NAS. All connected clients can access it.

Gigabit Ethernet

This unit supports gigabit Ethernet, allowing transmission rates of up to a billion bits per second.

AirNavigator CD Requirements

The AirStation wireless router and access point works with most wired and wireless devices. However, the automatic installation program on the CD requires a connected Windows 7, Vista or XP computer to run. If you use the AirStation with a different operating system, you will have to configure your network settings manually from a browser window.

300 Mbps High Speed Mode

300 Mbps is the link speed when using Wireless-N mode. It represents actual wireless data speeds, including overhead. Because the overhead is not available for user data transfer, usable wireless throughput will be substantially slower.

Package Contents

The following items are included in your AirStation package. If any of the items are missing, please contact your vender.

- WZR-HP-G300NH or WZR-HP-G300NH2..... 1
- AC adapter 1
- Stand for vertical/wall-mounting..... 1
- Screws for wall-mounting..... 2
- LAN cable 1
- AirNavigator CD..... 1
- Quick Setup Guide..... 1

Hardware Overview

Front Panel LEDs

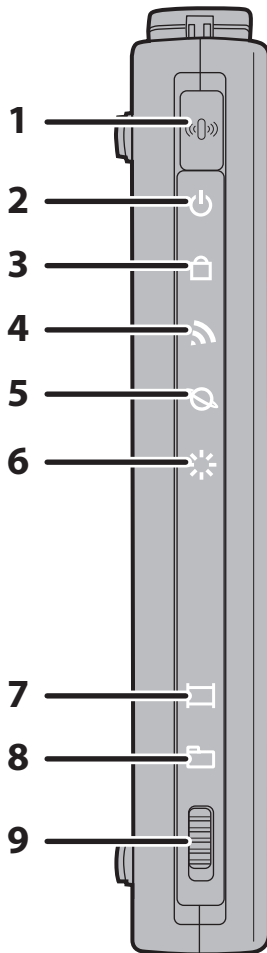

1 AOSS Button

To initiate AOSS, hold down this button until the Security LED flashes (about 1 second). Then, push or click the AOSS button on your wireless client device to complete the connection. Both devices must be powered on for this to work.

2 Power LED (Green)

On: The AC adapter is connected.
Off: The AC adapter is not connected.

3 Security LED (Amber)

Indicates security status.

Off: AOSS or Encryption is not set.

On: AOSS/WPS activated; accessed to exchange security keys.
Wireless security has been set.

2 blinks: AirStation is waiting for an AOSS or WPS security key.

Blinking: AOSS/WPS error; failed to exchange security keys.

Note: The Security LED is lit if an security key has been set.

4 Wireless LED (Green)

Indicates wireless LAN status.

On: Wireless LAN is transmitting.

Off: Wireless LAN is disabled.

5 Router LED (Green)

On: Router functionality is enabled.

Off: Router functionality is disabled.

- 6 Diag LED (Red)** This indicates the status of this unit depending on the number of blinks per cycle.
 Note: When the unit is first turned on or restarted, the Diag LED will blink for almost a minute during boot. This is normal.

Diag LED status	Meaning	Status
2 blinks * ¹	Flash ROM error	Cannot read or write to the flash memory.
3 blinks * ¹	Ethernet (wired) LAN error	Ethernet LAN controller is malfunctioning.
4 blinks * ¹	Wireless LAN error	Wireless LAN controller is malfunctioning.
5 blinks	IP address setting error	Because the network addresses of both the Internet port (WAN port) and the LAN port are the same, it is not possible to establish communication. Change the LAN side IP address of this unit.
Continuously blinking * ²	Updating the firmware Saving settings Initializing settings	Updating the firmware. Saving the settings. Initializing the settings.

*1 Unplug the AC adapter from the wall socket, wait for a few seconds, and then plug it again. If the light still flashes, please contact technical support.

*2 Never unplug the AC adapter while the Diag LED is blinking continuously.

7 Movie Engine On LED (Blue)

On: Movie Engine functionality is enabled.
 Off: Movie Engine functionality is disabled.

8 Movie Engine Off LED (Blue)

On: Movie Engine functionality is disabled.
 Off: Movie Engine functionality is enabled.

9 Movie Engine Switch

Switches the movie engine function between enabled and disabled.

On: Movie Engine functionality is enabled.
 Off: Movie Engine functionality is disabled.

Back Panel

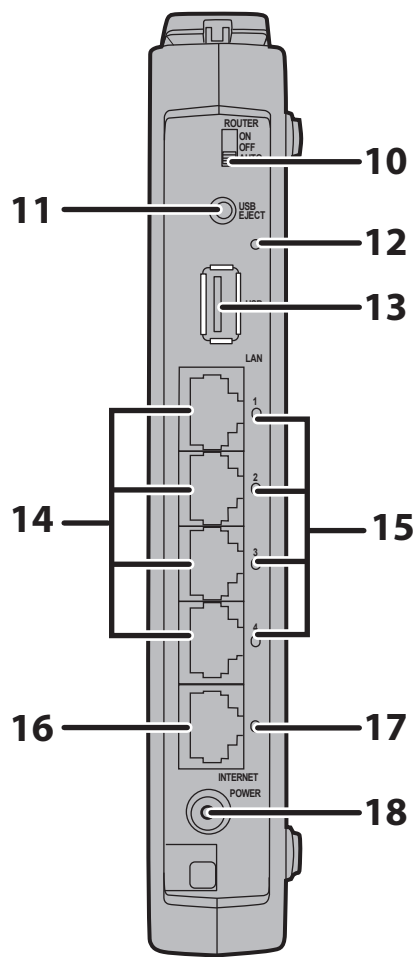

10 Router Switch

Switches router mode between enabled, disabled, and auto.

On: Router functionality is enabled (router mode).

Off: Router functionality is disabled (bridge/AP mode).

Auto: This switches between modes automatically based on whether or not another router is detected on the Internet port. The default setting for this switch is Auto.

11 USB Eject Button

To dismount a USB hard drive, hold down this button until the USB LED flashes (about 3 seconds). The USB drive can then be unplugged safely.

12 USB LED (Blue)

On: The USB disk is connected.

Off: The USB drive can be removed or no USB drive is connected.

Flashing: Overcurrent detected.

Note: When this LED is blinking, the connected USB drive cannot be used. Remove the connected USB drive. If the LED continues to blink even after the USB drive is removed, restart the AirStation.

Do not remove the USB drive or turn off the AirStation while the USB LED is on.

13 USB Port

Connect the USB drive.

Note: USB hubs are not supported.

14 LAN Port

Connect your computer, hub, or other Ethernet devices to these ports.

This switching hub supports 10 Mbps, 100 Mbps, and 1000 Mbps connections.

15 LAN LED (Green)

On: An Ethernet device is connected.

Flashing: An Ethernet device is communicating.

16 Internet Port 10 Mbps, 100 Mbps, and 1000 Mbps connections are supported.
Note: In bridge/AP mode (router switch off), the Internet port becomes a regular LAN port, for a total of 5 usable LAN ports.

17 Internet LED (Green)

On: The Internet port is connected.
Flashing: The Internet port is transmitting data.

18 DC Connector Connect the included AC adapter here.

Bottom

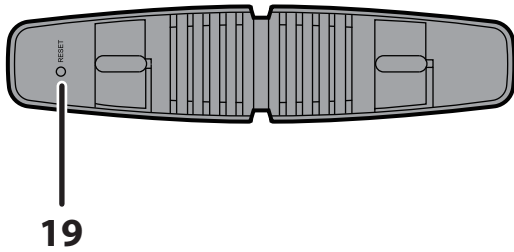

19 Reset Button To reset all settings, hold down this button until the Diag LED comes on (about 3 seconds). Power must be on.

Right Side

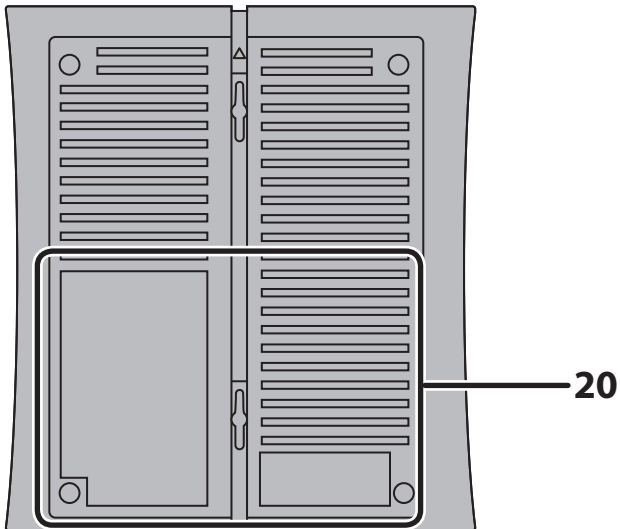

Note: The right side of the unit may become hot. Please be careful not to place anything next to it that could be damaged by heat.

20 Factory Default Settings

This sticker shows the AirStation's SSID, default encryption key, and WPS PIN code. By default, encryption is disabled for AirStations sold in Asia Pacific.

Chapter 2 - Placing Your AirStation

Vertical Placement

If the AirStation is to be placed vertically, attach the stand as shown.

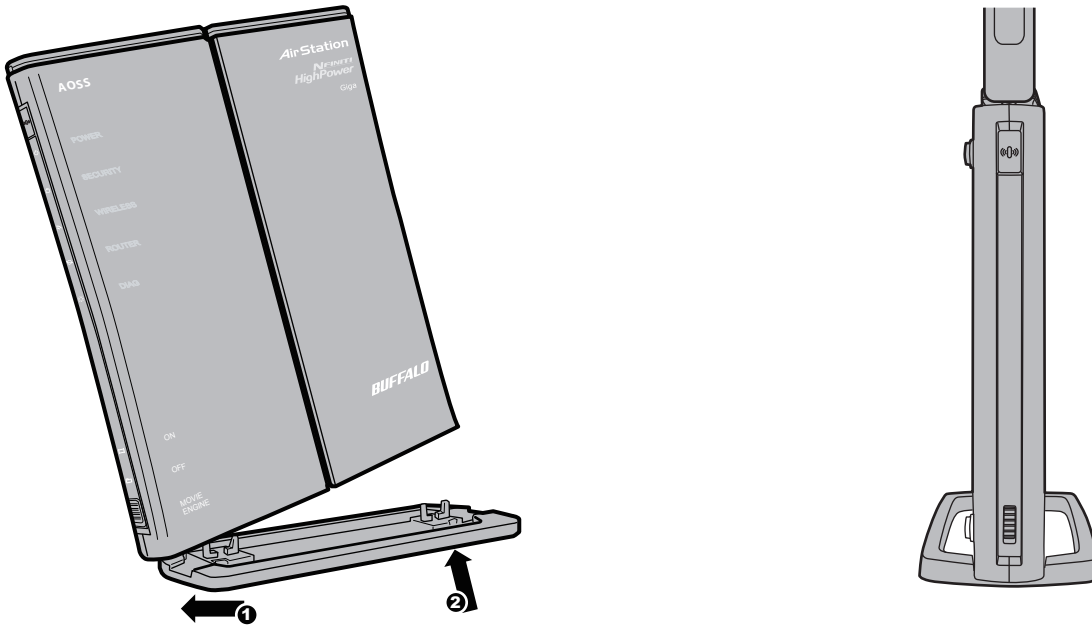

Horizontal Placement

The stand is not used if the AirStation is placed horizontally.

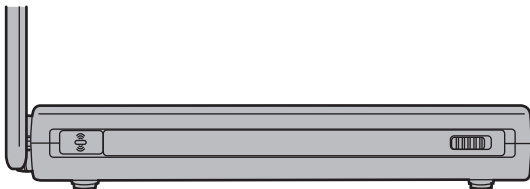

Wall-Mounting

1

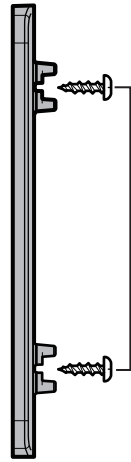
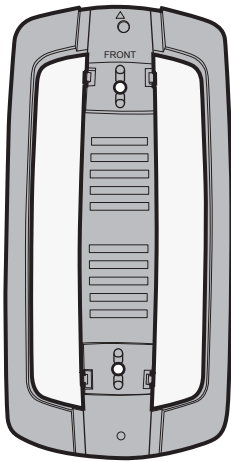

To wall-mount the AirStation, attach the stand to the wall with the two screws (included).

8.6 cm
(~3.4 inches)

2

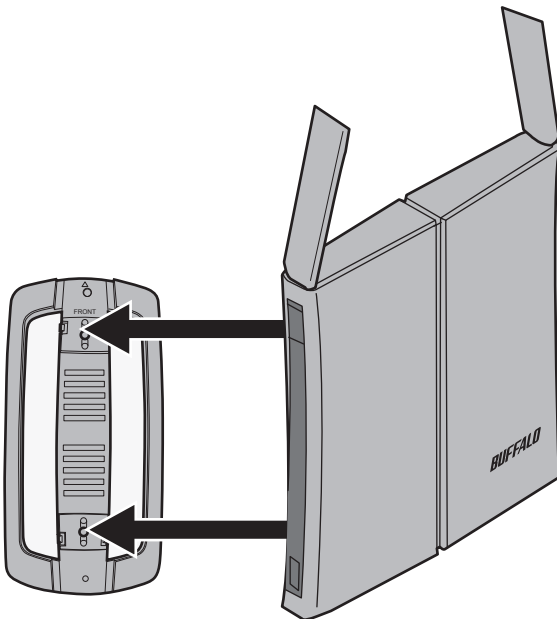

Snap the center of the AirStation to the stand as shown.

Chapter 3 - Installation

Automatic Setup

Windows 7 / Vista / XP

The AirNavigator CD can guide you through installing your AirStation. To launch the setup program please insert the CD into your Windows 7/Vista/XP PC and follow the instructions on the screen. If you deactivated auto-run for CD's please navigate to [CD drive]:\Win\ and launch ASSetWiz.exe.

- Note:**
- **To use a wireless client in Windows 7 or Vista, perform setup using the AirNavigator CD to automatically generate a profile for wirelessly connecting to the AirStation. After setup is complete, once the LAN cable is removed, you can connect from your wireless client to the AirStation.**
 - **Before performing setup, enable your computer's wireless client.**

Mac OS X

For a Mac, open the Mac folder on the CD and launch the AirStation Configuration tool. Search and select the Buffalo AirStation you want to set up. You can either configure the IP or open the web interface for all settings. Please refer to "Manual Setup" in the next section.

- Note:** **You can use the easy and simple setup via AOSS to connect the Mac wirelessly. Please press the AOSS button on the Buffalo router, start the AOSS assistant and follow the steps. The WLAN monitor in the same folder shows the wireless status regardless which method you use to connect.**

Other OS

If your computer uses a different operating system, use manual setup instead. Please refer to the next section "Manual Setup".

Manual Setup

To configure your AirStation manually, follow the procedure below.

- 1 Verify that you can connect to the internet without the AirStation, then turn off your modem and computer.

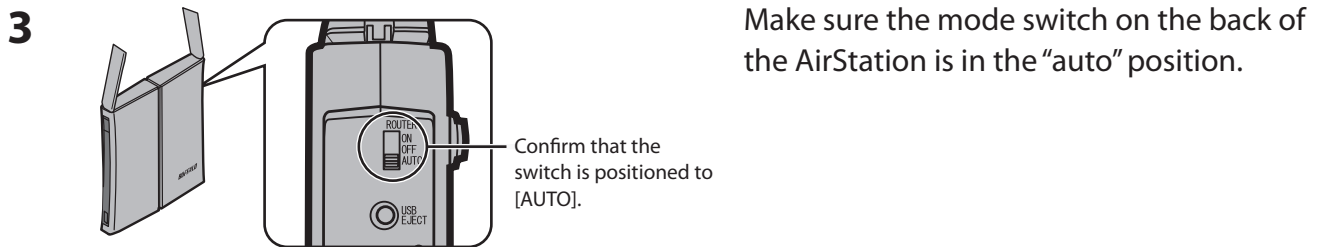
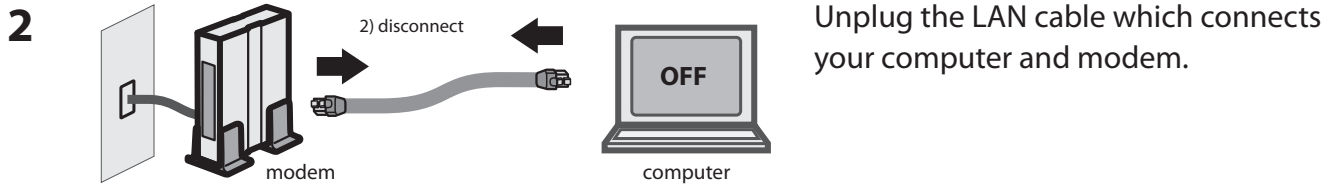

- 4 Plug one end of the LAN cable into your modem and the other end to the AirStation's Internet (WAN) port. Turn on the modem.

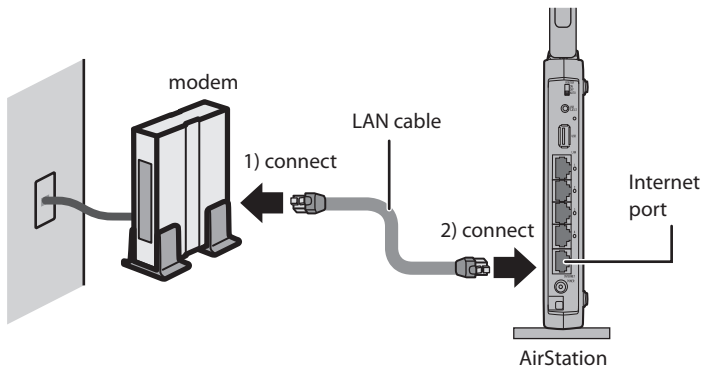

5 Connect your computer to one of the AirStation's LAN ports with the LAN cable.

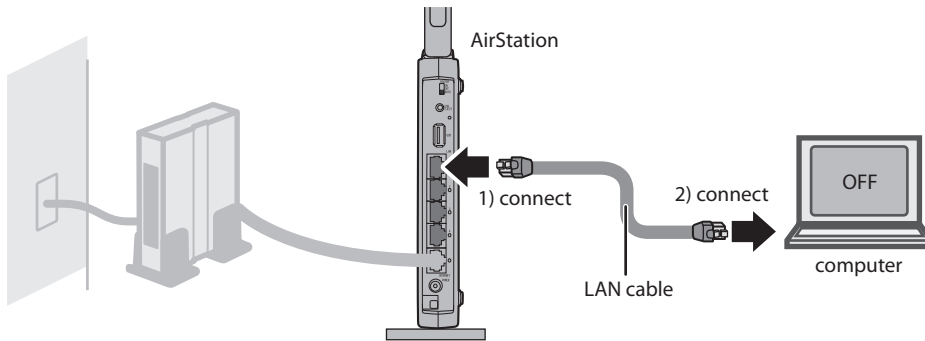

6 Turn on the AirStation, wait one minute, then turn on your computer.

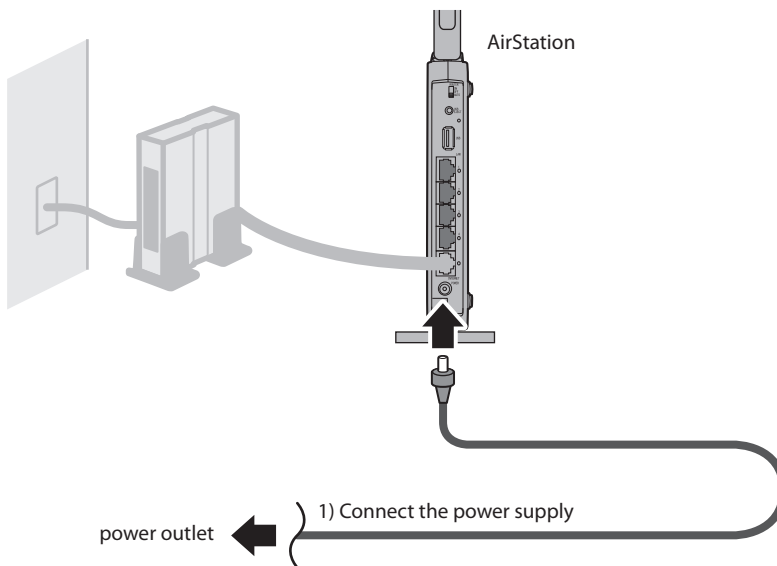

7 Once your computer has booted, the AirStation's LEDs should be lit as described below:

Power	Green light on.
Wireless	Green light on or blinking.
Router	Green light on or off depending on your network.
Diag	Off
LAN	Green light on or blinking.
Internet	Green light on or blinking.

For LED locations, refer to chapter 1.

- 8** Launch a web browser. If the home screen is displayed, setup is complete. If username and password fields are displayed, enter “root” for the username. Enter “admin” for the password if you’re using the professional firmware (default), or leave the password field blank if you’ve switched to the user-friendly firmware. Click [OK]. Step through the wizard to complete setup.

You’ve completed initial setup of your AirStation. Refer to Chapter 4 for advanced settings.

Firmware Differences

You can choose between two different firmwares for your AirStation. By default, the professional firmware (dd-wrt) is preinstalled for US/EU products. If you prefer, you may install the user-friendly firmware instead. The two firmwares have slightly different features, as shown in the chart below.

Function	Professional firmware (dd-wrt)	User-friendly firmware
Router mode switch functionality	—	✓
Default administrator name	root	root (fixed)
Default administrator password	admin	none
AOSS	✓	✓
WPS	✓	✓
WDS	✓	✓

Changing Firmware

To change between the professional firmware (dd-wrt) and the user-friendly firmware, follow the steps below.

Windows

- 1 Insert the AirNavigator CD into your computer. The setup wizard will automatically launch.
Note: If the Setup Wizard does not launch, open the CD and double-click [ASSetWiz.exe] in the "Win" folder.



Click [Change Firmware].



The procedure for wiring will be displayed. Step through the wizard to connect your AirStation.

4



When this screen is displayed, click [Change Firmware].

5



If requested, enter the AirStation's username and password.

Note: By default, the professional firmware doesn't have a username and password configured. Set them before you go to the next step.

- When the following screen is displayed, make sure that the firmware file name is displayed, click [Upgrade] or [Apply], and follow the instructions on the screen.

Note: If the firmware name is not displayed on the screen, click [Browse...] and select the desired firmware. The firmware files are contained in the "Firmware" folder of the AirNavigator CD.

Professional firmware (dd-wrt) update screen:

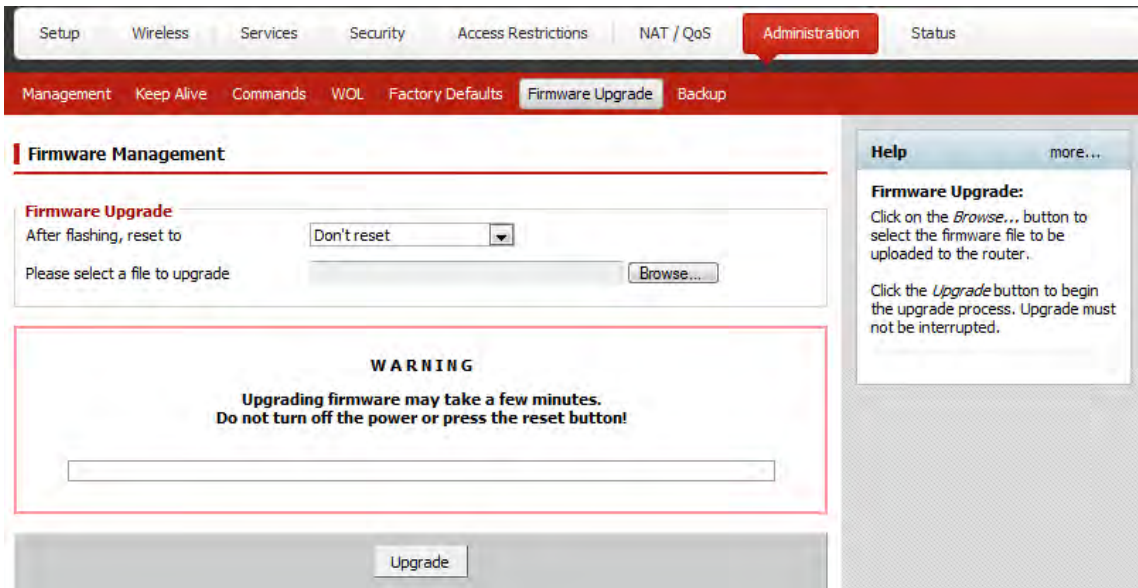

User-friendly firmware update screen:

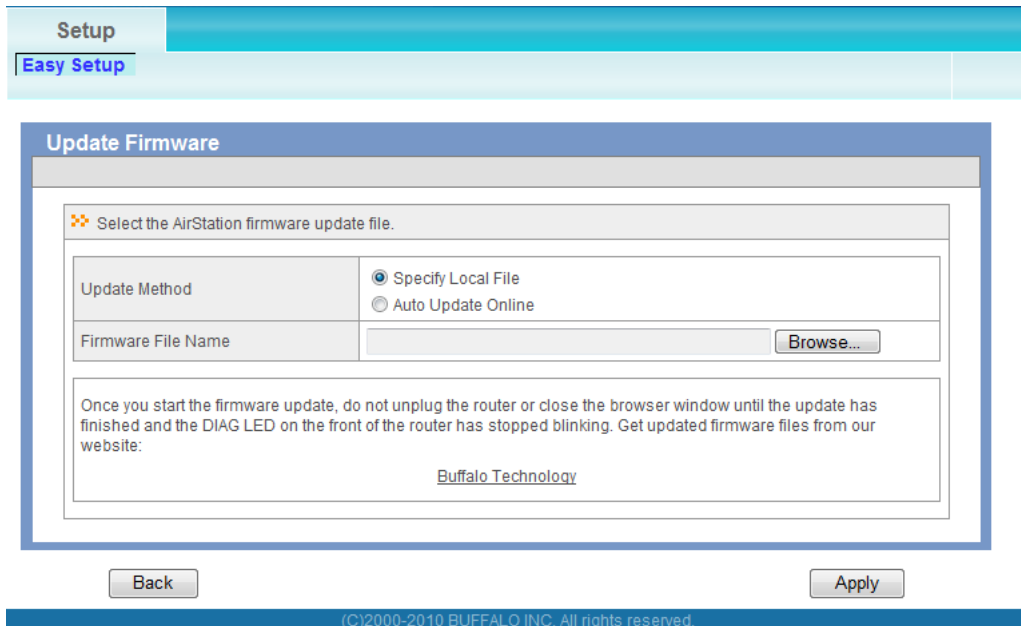

Macintosh

- 1 Open the configuration Interface of the AirStation.
- 2 To replace the professional firmware with the user-friendly firmware, click [Administration] > [Firmware Upgrade].
To replace the user-friendly firmware with the professional firmware, go to [Easy Setup] and click [Update AirStation Firmware].
- 3 Click [Browse...] to select the firmware file, and click [Upgrade] or [Apply].
Note: The firmware files are contained in the "Firmware" folder of the AirNavigator CD.

Professional firmware (dd-wrt) update screen:

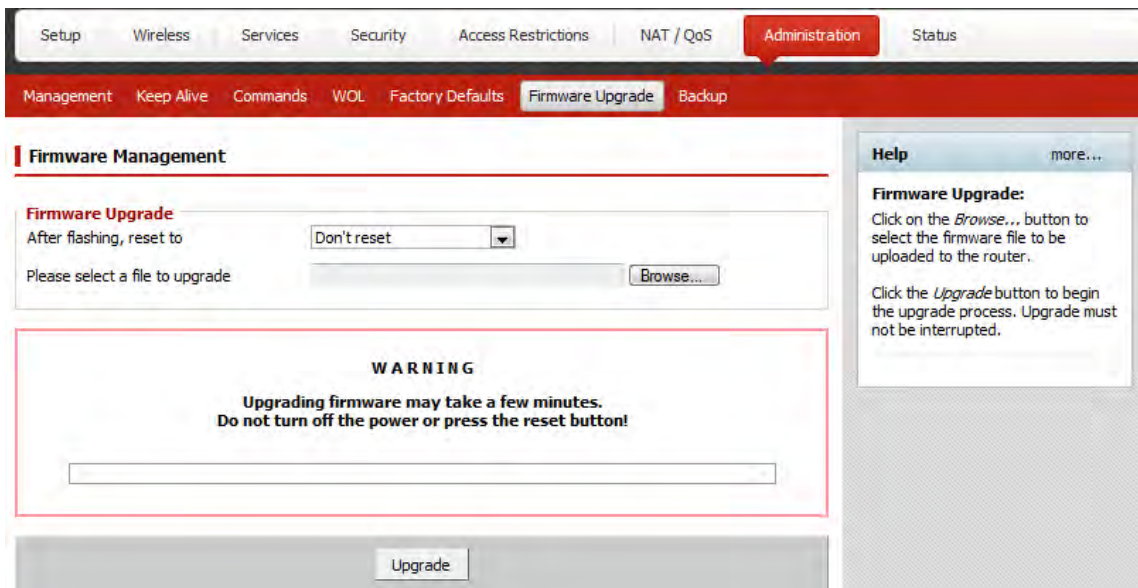

User-friendly firmware update screen:

The screenshot shows a web interface for updating firmware. At the top, there are navigation tabs for 'Setup' and 'Easy Setup'. The main content area is titled 'Update Firmware' and contains the following elements:

- A header instruction: "Select the AirStation firmware update file."
- An 'Update Method' section with two radio buttons: "Specify Local File" (selected) and "Auto Update Online".
- A 'Firmware File Name' input field with a "Browse..." button.
- A warning box containing the text: "Once you start the firmware update, do not unplug the router or close the browser window until the update has finished and the DIAG LED on the front of the router has stopped blinking. Get updated firmware files from our website: [Buffalo Technology](#)".
- At the bottom of the form area, there are "Back" and "Apply" buttons.

At the very bottom of the page, there is a copyright notice: "(C)2000-2010 BUFFALO INC. All rights reserved."

Chapter 4 - Configuration

The web-based configuration tool lets you change advanced settings for the AirStation. Don't change these settings unless you know what you're doing.

Accessing the Web-based Configuration Interface

To configure the AirStation's advanced settings manually, log in to the web-based configuration interface as shown below.

1 Launch a web browser.

2

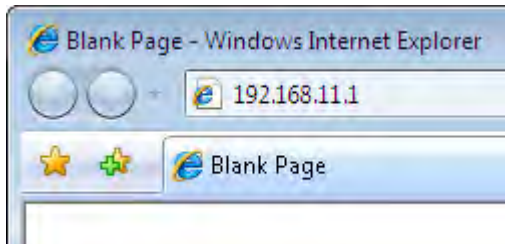

Enter the AirStation's LAN-side IP address in the address field and press the Enter key.

- Note:
- The AirStation's default LAN-side IP address depends on the position of the mode switch.
In router mode: 192.168.11.1
In bridge mode: 192.168.11.100
 - Note: If the router switch is set to auto and the unit is in bridge mode, then the AirStation's IP address was assigned by an external DHCP server.
 - If you changed the IP address of the AirStation, then use the new IP address.

3



When this screen appears, enter "root" (in lower case) for the username and the password that you set during initial setup. Click [OK].

- Note:
- By default, the password is blank (not set).
 - If you forget your password, hold down the reset button (page 12) to initialize all settings. The password will then be blank. Note that all other settings will also revert to their default values.

4

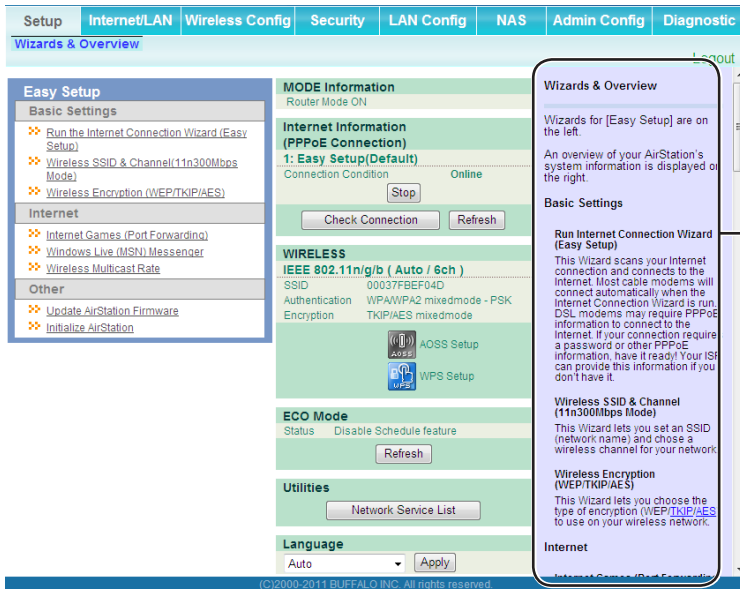

This is the configuration interface, where most AirStation settings can be configured.

Help is always displayed on the right side of each screen. Refer to the Help screens for more information on using the configuration interface.

Configuration Interface Menus in Router Mode

The menu structure for the AirStation in router mode is as follows. Please refer to the pages listed at right for explanations of each item.

Main screen	Descriptions	Page
Internet/LAN		
Internet	Configure Internet side port and settings.	Page 33
PPPoE	PPPoE settings (DSL login).	Page 34
DDNS	DNS settings.	Page 37
VPN Server	VPN server settings.	Page 39
LAN	LAN side port configuration.	Page 41
DHCP Lease	DHCP lease settings.	Page 43
NAT	Network address translation settings, used to connect LAN side devices to the Internet.	Page 44
Route	Configure the AirStation's IP communication route.	Page 45
Wireless Config		
WPS	WPS settings and status.	Page 46
AOSS	AOSS (AirStation One-touch Secure System) settings and status.	Page 47
Basic	Configure basic wireless settings.	Page 49
Advanced	Configure advanced wireless settings.	Page 52
WMM	Set priorities for Wireless Multimedia Extensions (Wi-Fi Multimedia).	Page 53
MAC Filter	Limit access to specific devices.	Page 55
Multicast Control	Configure limits on sending unnecessary multicast packets to the wireless LAN port.	Page 56
WDS	Configure communication between AirStations.	Page 57
Security		
Firewall	Protect your computer from outside intruders.	Page 59
IP Filter	IP filters for packets passing through the LAN side and the Internet side.	Page 61
VPN Passthrough	Configure IPv6 passthrough, PPPoE passthrough, and PPTP passthrough.	Page 62
LAN Config		
Port Forwarding	Configure port translation and exceptions for games and other programs.	Page 63
DMZ	Configure a destination to transfer communication packets without a LAN side destination.	Page 64

UPnP	Configure UPnP (Universal Plug and Play).	Page 65
QoS	Configure priority for packets that require a guaranteed data flow.	Page 66
Movie Engine	Configure options for the Movie Engine feature.	Page 68
NAS		
Disk Management	View the status and configure of attached USB disks.	Page 70
Shared Folder	Set the USB disk to use as shared folders.	Page 72
User Management	Configure users to access shared folders.	Page 74
Shared Service	Configure shared folder access.	Page 75
Web Access	Configure Web Access.	Page 76
Media Server	Configure a Media Server.	Page 78
BitTorrent	Configure a BitTorrent client.	Page 79
Admin Config		
Name	Configure the AirStation's name.	Page 81
Password	Configure the AirStation's login password for access to the configuration interface.	Page 82
Time/Date	Configure the AirStation's internal clock.	Page 83
NTP	Configure the AirStation to synchronize with an NTP server to automatically set the AirStation's internal clock.	Page 84
ECO	Configure the AirStation's ECO Mode.	Page 85
NTP	Configure Network-USB from this screen.	Page 87
Access	Configure access restrictions to the AirStation's configuration interface.	Page 88
Log	Configure a syslog server to manage the AirStation's logs.	Page 89
Save/Restore	Save or restore the AirStation's configuration from a configuration file.	Page 90
Initialize/Restart	Initialize the AirStation or reboot it.	Page 91
Update	Update the AirStation's firmware.	Page 92
Diagnostic		
System Info	View current system information for the AirStation.	Page 93
Logs	Check the AirStation's logs.	Page 95
Packet Info	View all packets transferred by the AirStation.	Page 96
Client Monitor	View all devices currently connected to the AirStation.	Page 97
Ping	Test the AirStation's connection to other devices on the network.	Page 98
Logout		
Click this to log out of the AirStation's configuration interface.		

Configuration Interface Menus in Bridge Mode

The menu structure in bridge mode is as follows. Please refer to the pages listed at right for explanations of each item.

Main screen	Descriptions	Page
LAN Config		
LAN	Configure LAN side ports and devices.	Page 41
Route	Configure the AirStation's IP communication route.	Page 45
Wireless Config		
WPS	WPS settings and status.	Page 46
AOSS	AOSS (AirStation One-touch Secure System) settings and status.	Page 47
Basic	Configure basic wireless settings.	Page 49
Advanced	Configure advanced wireless settings.	Page 52
WMM	Set priorities for Wireless Multimedia Extensions (Wi-Fi Multimedia).	Page 53
MAC Filter	Limit access to specific devices.	Page 55
Multicast Control	Configure limits on sending unnecessary multicast packets to the wireless LAN port.	Page 56
WDS	Configure communication between AirStations.	Page 57
QoS		
Movie Engine	Configure options for the Movie Engine feature.	Page 68
NAS		
Disk Management	View the status and configure of attached USB disks.	Page 70
Shared Folder	Set the USB disk to use as shared folders.	Page 72
User Management	Configure the name to access shared folders.	Page 74
Shared Service	Configure the name to access shared folders.	Page 75
Web Access	Set to use the Web Access function.	Page 76
Media Server	Set to use the Media Server function.	Page 78
BitTorrent	Set to use the BitTorrent function.	Page 79
Admin Config		
Name	Configure the AirStation's name.	Page 81
Password	Configure the AirStation's login password for access to configuration interface.	Page 82
Time/Date	Configure the AirStation's internal clock.	Page 83

NTP	Configure the AirStation to synchronize with an NTP server to automatically set the AirStation's internal clock.	Page 84
ECO	Configure ECO Mode.	Page 85
NTP	Configure Network-USB from this screen.	Page 87
Access	Configure access restrictions to the AirStation's configuration interface.	Page 88
Log	Check the AirStation's logs.	Page 89
Save/Restore	Save or restore the AirStation's configuration from a configuration file.	Page 90
Initialize/Restart	Initialize the AirStation or reboot it.	Page 91
Update	Update the AirStation's firmware.	Page 92
Diagnostic		
System Info	View current system information for the AirStation.	Page 93
Logs	Check the AirStation's logs.	Page 95
Packet Info	View all packets transferred by the AirStation.	Page 96
Client Monitor	View all devices currently connected to the AirStation.	Page 97
Ping	Test the AirStation's connection to other devices on the network.	Page 98
Logout		
Click this to log out of the AirStation's configuration interface.		

Setup

Setup is the home page of the configuration interface. You can verify settings and the status of the AirStation here.

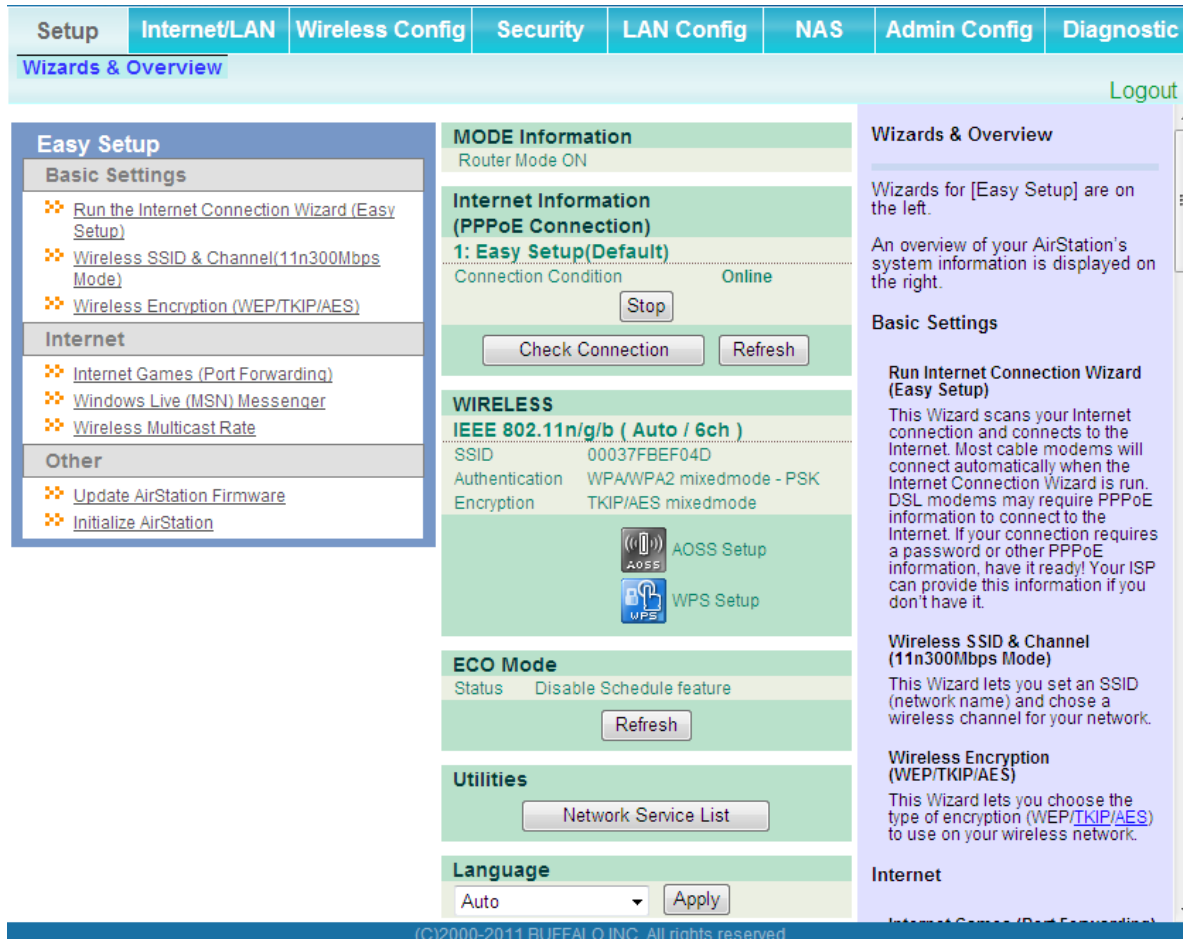

Parameter	Meaning
Internet/LAN (LAN Config)	Displays the configuration screen for the Internet port and LAN ports.
Wireless Config	Click this button to display the configuration screen for wireless settings.
Security	Click this button to display the configuration screen for security.
LAN Config	Click this button to display the configuration screen to open ports for games and applications.

Parameter	Meaning
NAS	Click this button to display the configuration screen for NAS settings.
Admin Config	Click this button to display the configuration screen for administration settings.
Diagnostic	Click this button to display the status of the AirStation.
Easy Setup	Enables you to easily configure the AirStation's network settings automatically.
MODE Information	This indicates the operation mode of the AirStation.
Internet Information	Displays WAN-side system information for the AirStation.
Check Connection	Click this button to check if the AirStation is connected to the Internet properly.
Refresh	Click this button to refresh the current screen.
WIRELESS	Displays the current wireless settings.
AOSS Setup	Click this button to display the AOSS configuration screen.
WPS Setup	Click this button to display the WPS configuration screen.
ECO Mode	This indicates the operating status of ECO Mode.
Network Service List	Displays the list of the network devices for which information is provided from the network on the LAN-side.
Media Server	Displays the status of the media server.
Download List	Displays the list of BitTorrent files downloading.
Language	Enables you to select the language you use.
Logout	Log out of the configuration interface. If the AirStation does not communicate for 5 minutes, it will log out automatically.

Internet/LAN (LAN Config)

Internet (Router Mode only)

Configure the WAN-side port ("Internet port").

Setup | Internet/LAN | Wireless Config | Security | LAN Config | NAS | Admin Config | Diagnostic

Internet | PPPoE | DDNS | VPN Server | LAN | DHCP Lease | NAT | Route

Logout

As for the IP address acquisition method, "Perform Easy Setup (Internet Connection Wizard)" is set up.

To set up PPPoE, [click here](#).

Advanced Settings

Default Gateway	<input type="text"/>
Address of DNS Name Server	Primary: <input type="text"/>
	Secondary: <input type="text"/>
Internet MAC Address	<input checked="" type="radio"/> Use Default MAC Address(00:24:A5:C0:00:D8) <input type="radio"/> Use this address <input type="text"/>
MTU Size of Internet Port	1500 Bytes

(C)2000-2010 BUFFALO INC. All rights reserved.

Internet Ethernet Settings

Configuring your [Internet](#) side port:

Normally, you'll connect the [Internet](#) side port to an external network such as the internet.

Method of Acquiring IP Address

Select one of the following methods to acquire an [INTERNET port IP Address](#). Please ask your [Provider](#) for any other information about your line format. If you're not sure which method to choose, try selecting Easy Setup. You can confirm the status of the current [Internet](#) side [IP Address](#) on the System Information screen. This setting can only be changed when the hardware mode switch on the AirStation is set to [ROUTER ON].

Perform Easy Setup (Internet Connection Wizard)

The Easy Setup scans your [Internet](#) connection and determines your internet

Parameter	Meaning
Method of Acquiring IP Address	Specify how the WAN-side IP address is obtained.
Default Gateway	Configure an IP address for the default gateway.
Address of DNS Name Server	Specify an IP address for the DNS server.
Internet MAC Address	Configure the Internet side MAC address. Note: Configuring an improper MAC address may make the AirStation unusable. Change this setting at your own risk.
MTU size of Internet Port	Configure the MTU value of the Internet port. Values of 578 to 1500 bytes may be entered.

PPPoE (Router Mode only)

Configure PPPoE settings.

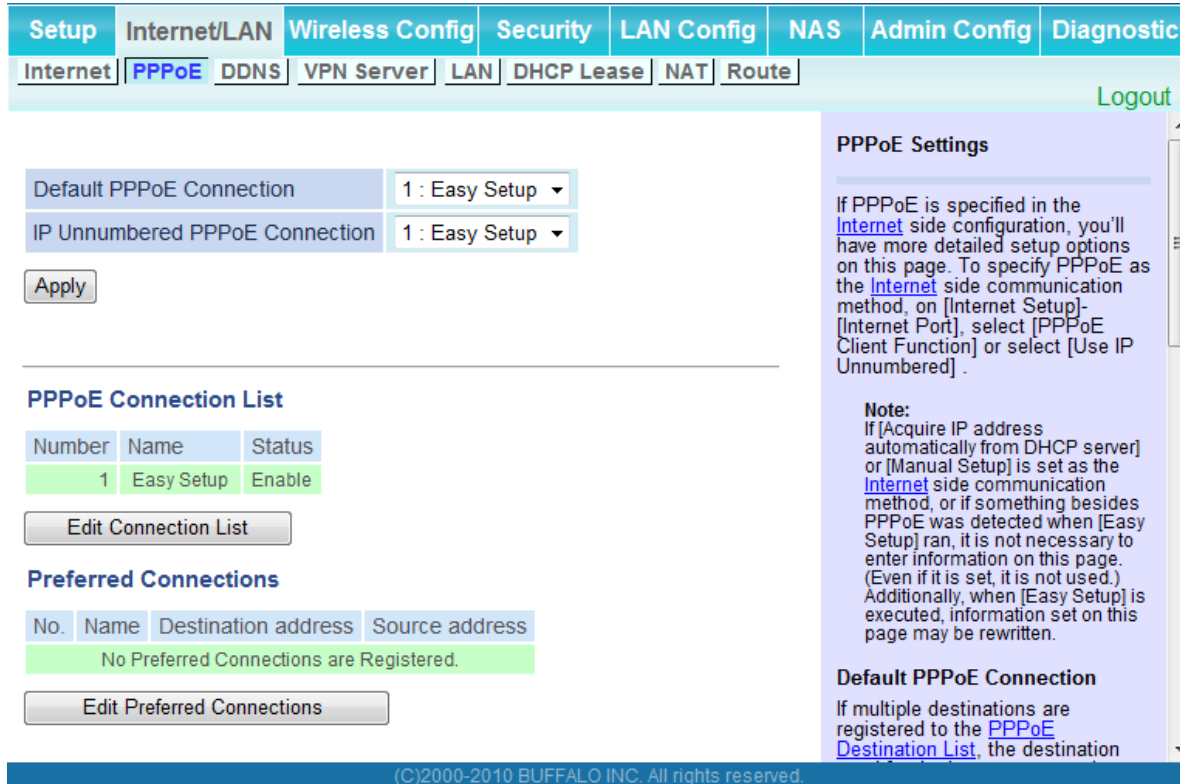

Setup Internet/LAN Wireless Config Security LAN Config NAS Admin Config Diagnostic

Internet PPPoE DDNS VPN Server LAN DHCP Lease NAT Route Logout

Default PPPoE Connection 1 : Easy Setup ▾

IP Unnumbered PPPoE Connection 1 : Easy Setup ▾

Apply

PPPoE Connection List

Number	Name	Status
1	Easy Setup	Enable

Edit Connection List

Preferred Connections

No.	Name	Destination address	Source address
No Preferred Connections are Registered.			

Edit Preferred Connections

PPPoE Settings

If PPPoE is specified in the [Internet](#) side configuration, you'll have more detailed setup options on this page. To specify PPPoE as the [Internet](#) side communication method, on [Internet Setup]-[Internet Port], select [PPPoE Client Function] or select [Use IP Unnumbered] .

Note:
If [Acquire IP address automatically from DHCP server] or [Manual Setup] is set as the [Internet](#) side communication method, or if something besides PPPoE was detected when [Easy Setup] ran, it is not necessary to enter information on this page. (Even if it is set, it is not used.) Additionally, when [Easy Setup] is executed, information set on this page may be rewritten.

Default PPPoE Connection
If multiple destinations are registered to the [PPPoE Destination List](#), the destination

(C)2000-2010 BUFFALO INC. All rights reserved.

Parameter

Meaning

Default PPPoE Connection	If you have registered multiple connection destinations in the PPPoE Connection List, connection destinations selected here have priority. You need to configure the route to which PPPoE is connected to if you don't use the default settings.
IP Unnumbered PPPoE Connection	Select the destination from the PPPoE Connection List which is used when "Use IP Unnumbered" is chosen for the Method of Acquiring IP Address (page 33).
PPPoE Connection List	Edit PPPoE destination. You can register up to 5 sessions.
[Edit Connection List]	Click this button to edit destination settings.

Parameter	Meaning
PPPoE Connection No.*-Add	This is displayed when [Edit Connection List] is clicked. Name of Connection Enter the name to identify the connected destination. You may enter up to 32 alphanumeric characters and symbols. Username Enter the username specified by your ISP for PPPoE certification. You may enter up to 32 alphanumeric characters and symbols. Password Enter the password specified by your ISP for PPPoE certification. You may enter up to 32 alphanumeric characters and symbols. Service Name Fill in this field only if your ISP specifies a Service Name. Leave blank otherwise. You may enter up to 32 alphanumeric characters and symbols. Connection Type Specifies the timing for the AirStation to connect to your provider. Automatic disconnection Set time to disconnect after communication is stopped when the connection method is set to [Connect on Demand] or [Manual]. You can enter up to 1440 minutes. Authorization Configure an authorization method with a provider. MTU Size Configure the MTU size for PPPoE. Values of 578 to 1500 bytes may be entered. MRU Size Configure MRU (Maximum Receive Unit) for PPPoE. Values of 578 to 1492 may be entered.

Parameter	Meaning
PPPoE Connection No. *-Add	<p>Keep Alive If Keep Alive is enabled, then the AirStation will issue an LCP echo request once a minute in order to maintain the connection with the PPPoE. If the server does not respond for more than 6 minutes, the line is recognized as disconnected and the AirStation will terminate the connection. [Disabled] is the recommended setting.</p>
Preferred Connections	<p>Displays information you have set regarding to the connection destination route.</p>
[Edit Preferred Connections]	<p>Click to edit the connection destination route settings.</p>
Preferred PPPoE Connection -Add	<p>Click [Edit Preferred Connections] to display.</p> <p>Name The destination to connect by PPPoE if [Destination address] and [Source address] match. Select the destination registered to the PPPoE Connection List.</p> <p>Destination address When communicating to this address, the AirStation will communicate with [Name of Connection.]</p> <p>Source address When communicating from this address, the AirStation will communicate with [Name of Connection.]</p>

DDNS (Router Mode only)

Configure Dynamic DNS settings. Many settings are only available when the appropriate Dynamic DNS service is enabled.

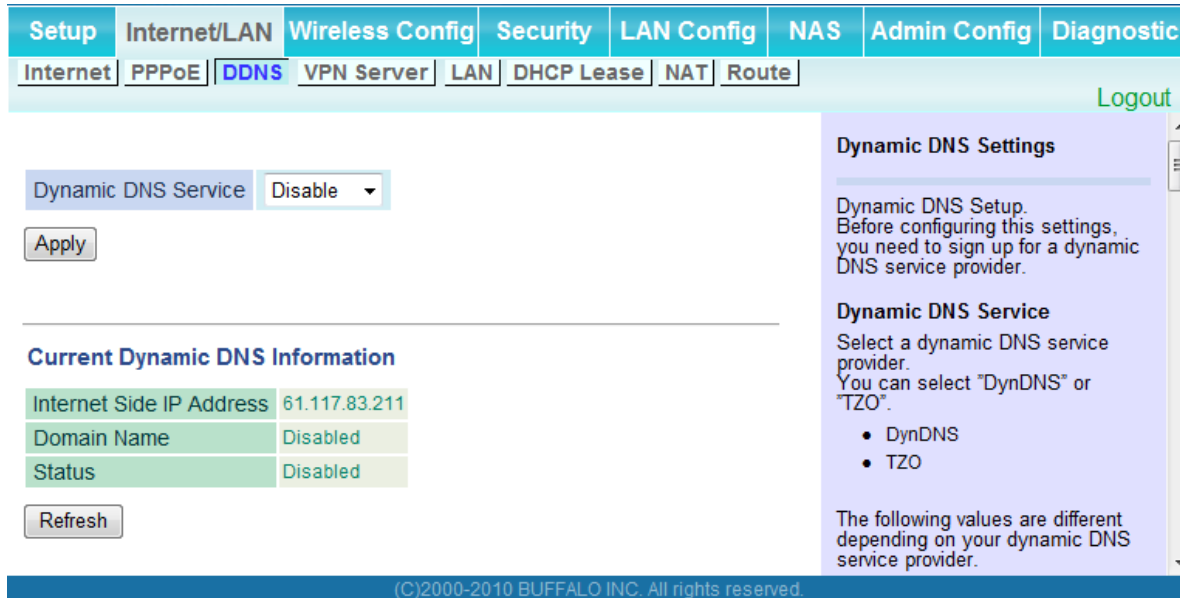

Dynamic DNS Service:

Current Dynamic DNS Information

Internet Side IP Address	61.117.83.211
Domain Name	Disabled
Status	Disabled

Dynamic DNS Settings

Dynamic DNS Setup. Before configuring this settings, you need to sign up for a dynamic DNS service provider.

Dynamic DNS Service

Select a dynamic DNS service provider. You can select "DynDNS" or "TZO".

- DynDNS
- TZO

The following values are different depending on your dynamic DNS service provider.

(C)2000-2010 BUFFALO INC. All rights reserved.

Parameter	Meaning
Dynamic DNS Service	Select a provider (DynDNS or TZO) for Dynamic DNS.
Username	Enter the Dynamic DNS username. You may enter up to 64 alphanumerical characters and symbols.
Password	Enter the Dynamic DNS password. You may enter up to 64 alphanumerical characters and symbols.
Hostname	Enter the Dynamic DNS hostname. You may enter up to 255 alphanumerical characters, hyphens, and periods.
Email Address	Enter the email address which is registered to the Dynamic DNS service. You may enter up to 64 alphanumerical characters and symbols.
TZO Key	Enter the TZO Key which is registered to the Dynamic DNS service. You may enter up to 64 alphanumerical characters and symbols.
Domain Name	Enter the domain name which is registered to the Dynamic DNS service. You may enter up to 255 alphanumerical characters, hyphens, and periods.

Parameter	Meaning
IP Address Update Period	Specifies the period to notify the dynamic DNS service provider of the current IP address. For DynDNS, set it between 0 and 35 days. For TZO, set it between 0 and 99 days. If 0 (zero) days is set, no periodic update is performed.
Internet Side IP Address	The WAN-side IP address of the AirStation's Internet port. This address is sent to the dynamic DNS service provider.
Domain Name	The domain name assigned by the dynamic DNS Service provider. The AirStation can be accessed from the Internet using this domain name.
Status	Display the status of dynamic DNS service.

VPN server (Router Mode Only)

Configure the VPN server.

Setup	Internet/LAN	Wireless Config	Security	LAN Config	NAS	Admin Config	Diagnostic
Internet	PPPoE	DDNS	VPN Server	LAN	DHCP Lease	NAT	Route

[Logout](#)

**The LAN side IP address is set to 192.168.11.1.
Therefore, a PC connected to BUFFALO's router may be unable to access to the PC on the LAN.
The LAN side IP address and DHCP IP address pool should be changed.**

Auto Input	<input type="button" value="Generate Recommended IP Address"/>	
LAN Side IP Address	IP Address	192.168.11.1
	Subnet Mask	255.255.255.0
DHCP Server Function	<input checked="" type="checkbox"/> Enable	
DHCP IP Address Pool	192.168.11.2	for up to 64 Address(es)
PPTP Server Function	<input type="checkbox"/> Enable	
Authorization Type	MS-CHAPv2 (40/128-bit Encryption)	

[Advanced Settings]

Server IP Address	<input checked="" type="radio"/> Auto	<input type="radio"/> Manual	<input type="text"/>
Client IP Address	<input checked="" type="radio"/> Auto	<input type="radio"/> Manual	<input type="text"/> for up to 5 address(es)
DNS Server IP Address	<input checked="" type="radio"/> LAN IP address of the AirStation	<input type="radio"/> Manual	<input type="text"/>
		<input type="radio"/> Do Not Specify	
WINS Server IP Address	<input type="text"/>		
MTU/MRU value	1396		

PPTP User List

User Name	Connection Condition	IP Address	Operation
No registered users			

VPN Server Settings

By using the PPTP server function it is possible to access the AirStation from the Internet and the LAN from a Windows PPTP client.

Note
If using GRE protocol (protocol no.47) and no.1723 TCP port filtering, then this function may not work correctly.
Also, be aware that if a router on the Internet side has these protocols blocked, then this function cannot be used.

Auto Input
Click this button to generate a random IP address with a small possibility of overlapping with IP addresses of other Buffalo routers.

LAN Side IP Address
Configure the AirStation's LAN [IP Address](#). The default is 192.168.11.1. If you want to connect the AirStation to an existing LAN, specify a unique, unused [IP Address](#) from the LAN's range of IP addresses.

Subnet Mask
Select the AirStation's LAN side Subnet Mask. The default is 255.255.255.0. If you want to connect the AirStation to an existing LAN, specify a unique, unused [IP Address](#) from the LAN's range of IP addresses.

DHCP Server Function
Enable the DHCP Server here. The default is enabled. If there is another DHCP server on the network, one DHCP server must be disabled or the IP ranges must be changed to avoid conflicts caused by overlapping DHCP scopes. If DHCP Server is enabled, confirm [DHCP IP Address Pool](#) doesn't overlap existing [IP Addresses](#) in the LAN segment.

DHCP IP Address Pool
This determines the [IP Address](#) range from which IP addresses will be distributed to DHCP clients (both wired and wireless). Enter the starting IP address and the

(C)2000-2010 BUFFALO INC. All rights reserved.

Parameter	Meaning
Auto Input	Click to generate a random IP address.
LAN Side IP Address	Set a LAN side IP address and subnet mask.
DHCP Server Function	Enable or disable the DHCP server, which assigns IP addresses automatically.
DHCP IP Address Pool	Configure the range of IP addresses to be assigned by the DHCP server and IP addresses to be excluded from that range. Values from 0-253 may be entered.
PPTP Server Function	Enable to use a PPTP server.
Authorization Type	Select the authentication method for PPTP connection.
Server IP Address	Select the server IP address.
Client IP Address	Select the IP address range.
DNS Server IP Address	Choose the IP address for the DHCP server.
WINS Server IP Address	Choose the IP address for the WINS server.
[Edit PPTP User List]	Click to edit user information.
Username	Enter the username to connect to the PPTP server. You may enter up to 16 alphanumerical characters and symbols.
Password	Enter the password to connect to the PPTP server. You may enter up to 16 alphanumerical characters and symbols.
Method of Acquiring IP Address	Select the method to be used to assign the IP address is assigned to the PPTP client.
PPTP User List	Displays the PPTP connection user information.

LAN

Configure LAN-side and DHCP Server settings.

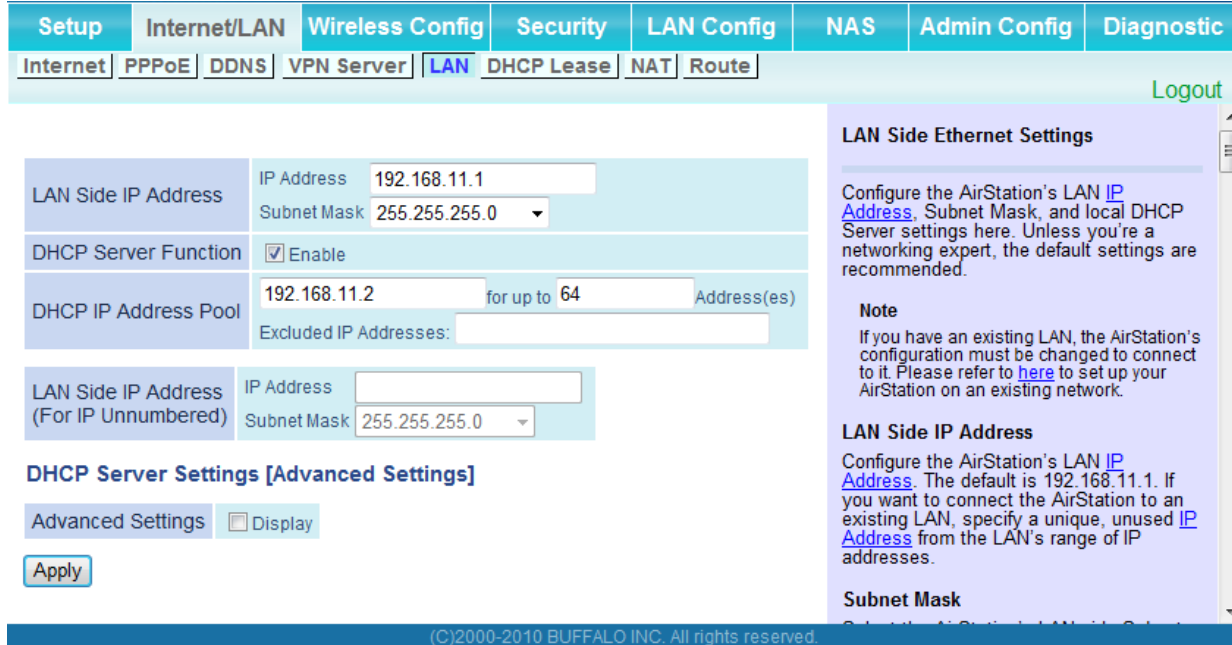

Parameter	Meaning
LAN Side IP Address	By default, the LAN side IP address is 192.168.11.1 with subnet mask 255.255.255.0. You may change it here.
DHCP Server Function	Enable or disable the DHCP server, which assigns LAN-side IP addresses automatically.
DHCP IP Address Pool	Configure the range of IP addresses to be assigned by the DHCP server and IP addresses to be excluded from that range. Values from 0-253 may be entered.
LAN Side IP Address (For IP Unnumbered)	Set an IP unnumbered LAN side IP address. Note: A PC with a normal LAN side IP address and a PC with an IP Unnumbered IP address cannot communicate each other.
Advanced Settings	Check [Display] to display DHCP server advanced settings options.
Lease Period	Set the effective period of an IP address assigned by the DHCP server. Up to 999 hours may be entered.
Default Gateway	Set the default gateway IP address for the DHCP server to issue to clients.

Parameter	Meaning
DNS Servers * Router Mode only	Set the DNS server IP address for the DHCP server to issue to clients.
WINS Server * Router Mode only	Set the WINS server IP address for the DHCP server to issue to clients.
Domain Name * Router Mode only	Set the domain name for the DHCP server to issue to clients. You may enter up to 127 alphanumerical characters, hyphens, and periods.
Default Gateway * Bridge Mode only	Set the default gateway IP address.
DNS Server Address * Bridge Mode only	Set the DNS server IP address.

DHCP Lease (Router Mode only)

Configure DHCP Exceptions.

Parameter	Meaning
IP Address	Enter an IP address to lease manually. The IP address should be from the same subnet as the DHCP scope, but not be within the range that DHCP is assigning to other devices.
MAC Address	Enter the MAC address which identifies the client.
Current DHCP Client Information	Displays information for current leases. An IP address which is leased automatically can be changed to manual leasing by clicking [Manual Assignment].

NAT (Router Mode only)

Configure network address translation settings. This enables LAN-side devices to communicate with the Internet.

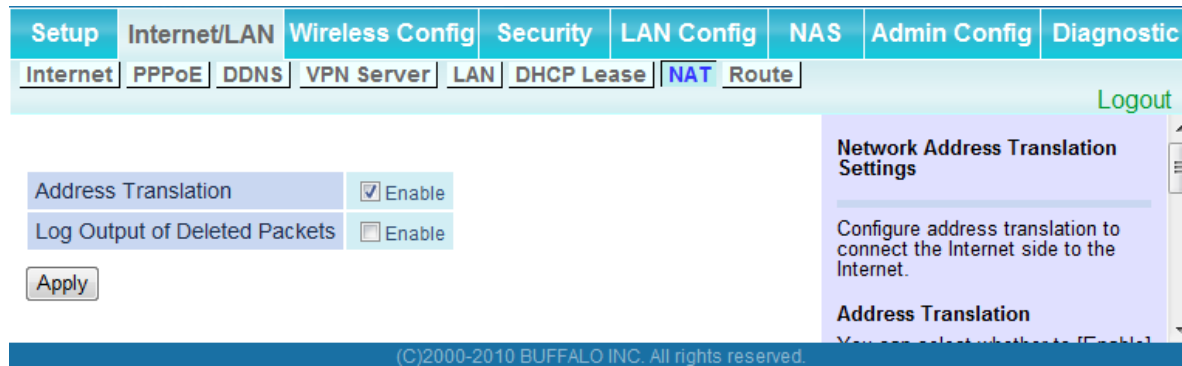

Parameter	Meaning
Address Translation	Enable to use Network Address Translation.
Log Output of Deleted Packets	Enable to log deleted packets (such as errors) during address translation.

Route

Configure the AirStation's IP communication route.

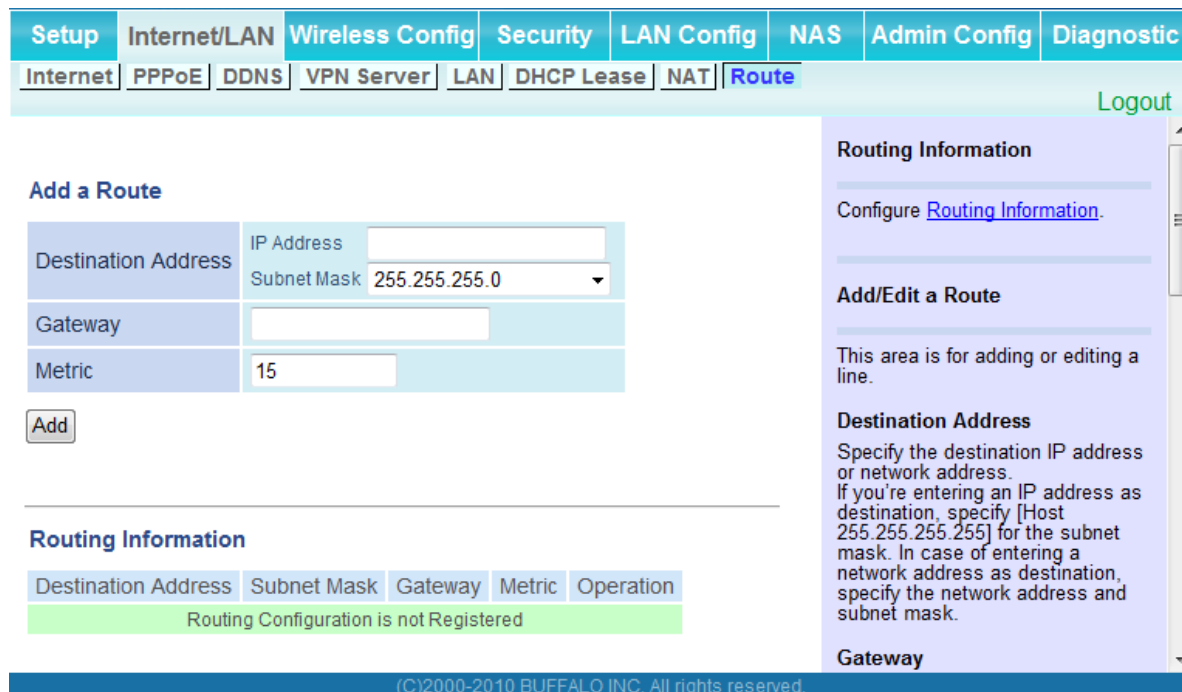

Parameter	Meaning
Destination Address	Adds a destination IP address and subnet mask to a routing table.
Gateway	Adds a gateway address to a routing table.
Metric	The metric is the maximum number of router hops a packet may take on the way to its destination address. Values between 1 and 15 may be entered. The default value is 15.
Routing Information	Manual entries will appear here after being added.

Wireless Config

WPS

WPS Status and Settings.

WPS(WiFi Protected Setup)

WPS

Configuring WPS
 WPS is WiFi Protected Setup which corresponds to Windows Connect Now-NET (WCN-NET). WPS is also known as the Wi-Fi Simple Configuration Protocol. WPS function can safely and easily distribute wireless security information from an access point (AirStation) to the WPS clients. The WPS device which registers wireless security information is called Registrar. The AirStation has an internal Registrar built-in it, but can also use an External Registrar. The WPS device which receives the wireless security information from the Registrar is called Enrollee.

WPS status	configured	<input type="button" value="release"/>
11n/g/b	SSID	00037FBEF04D
	Security	WPA/WPA2 mixedmode - PSK TKIP/AES mixedmode
	Encryption key	1234567890123

(C)2000-2011 BUFFALO INC. All rights reserved.

Parameter	Meaning
WPS	Enable to use WPS automatic configuration.
External Registrar	Enable to accept configure requests from other WPS devices. Note: Configure requests will not be accepted if AOSS is in use.
AirStation PIN	Displays the PIN code of the AirStation. Clicking [Generate PIN] will generate a new PIN code. This code can be entered into other wireless devices that support WPS.
Enrollee PIN	Enter the PIN code for the other wireless device and click [OK].
WPS status	Displays "configured" if all available wireless bands are configured. Displays "unconfigured" if at least one wireless band is unconfigured.

AOSS

AOSS Status and Settings.

Setup	Internet/LAN	Wireless Config	Security	LAN Config	NAS	Admin Config	Diagnostic
WPS	AOSS	Basic(11n/g/b)	Advanced(11n/g/b)	WMM(11n/g/b)	MAC Filter	Multicast Control	WDS

Logout



AOSS Settings - Edit AOSS Client Information

Encryption Type of Exclusive SSID for WEP	802.11n/g/b	Stop
Encryption level expansion function	802.11n/g/b	Enabled
Dedicated WEP SSID isolation	802.11n/g/b	Disabled
Dedicated WEP for game consoles	802.11n/g/b	<input type="checkbox"/> Enable
AOSS Button on the AirStation Unit	<input checked="" type="checkbox"/> Enable	

Current Encryption Information 802.11n/g/b

Encryption Type	WPA-PSK-AES (Now in use)		
SSID	00037FBEF04D-1		
Encryption key	1234567890123		
Encryption Type	WPA/WPA2-PSK-mixed (Now in use)		
SSID	00037FBEF04D		
Encryption key	1234567890123		
Encryption Type	WEP128		
SSID	00037FBEF04D-3		
Encryption key	8A673B261C5D4E2F7203ED0420 (Sending Key)		
	B4227C7B137904778244FAD0A0		
	2B0CCC5826EFB977093B71F836		
	AB443525B353ACC8C62B11BCF3		
Encryption Type	WEP64		
SSID	00037FBEF04D-4		
Encryption key	31FBD9A5A9 (Sending Key)		
	1E0918B3BC		
	3F6F91000B		
	FD9D5F0638		

AOSS Client Information

Client Information	MAC Address	Encryption Type	Wireless	Connection Setting
WLI-UC-G300xN	00:1D:73:92:0F:82	WEP64/WEP128 WPA-PSK-TKIP/WPA-PSK-AES	802.11n/g/b	Allow

AOSS Ethernet Converter Information

AOSS (AirStation One-Touch Secure System)

AOSS is Buffalo's unique technology for quickly forming a secure wireless connection. You can see AOSS's configuration and status from this screen.



[Start AOSS] button

Click this button to start AOSS. The AOSS button on top of the router works the same as this button. Refer to [How to use AOSS](#) for more details.



[Disable AOSS] button

This button appears when AOSS is enabled. Click this button to disable AOSS. Connections to wireless clients will be terminated, [AOSS Information](#) removed, and Encryption Type reset to its default value, AES. Current Encryption Information will also be removed. Wireless Setting and Wireless Security are enabled in Advanced Settings when AOSS is disabled.

How to use AOSS

How to use AOSS:

- First**
Power on or reboot the AirStation and a wireless client that supports AOSS.
- Press AOSS buttons**
After rebooting, press both product's AOSS buttons, the router's first, then the client's. The AirStation and the wireless client will exchange security information to set up the most secure encryption type automatically and are ready to communicate.

Note:



- Once the AOSS button is pressed, other operations can't be started until AOSS is finished. If the AirStation can't find a wireless client after three minutes, the AirStation's status returns to its previous state.
- Up to 24 wireless clients may be connected through AOSS.
- By default, AOSS is functional but does not initiate a connection unless started manually by pushing the AOSS button, either here or on the top of the router.
- Use AirStation's System Information page to manually configure a wireless client that doesn't support AOSS.
- When wireless security is configured, its security information is succeeded.

In the following cases, the setting of wireless security is not succeeded and AOSS returns error.

- Any blank is contained in SSID.
- WPA-PSK is input with 'hexadecimal 64 characters'.
- Any blank is contained in WPA-PSK.

In the following cases, the setting of wireless security is not succeeded and AOSS generates new encryption settings.

(C)2000-2011 BUFFALO INC. All rights reserved.

Parameter	Meaning
	Initiates AOSS automatic wireless configuration. Click this, then press or click the AOSS button on your AOSS-compatible wireless client. Repeat for additional AOSS clients.
	Click this button to disconnect AOSS connections. Note: If AOSS connections are disconnected, the SSID and encryption keys will be restored to their last settings from before AOSS was used.
Encryption Type of Exclusive SSID for WEP	You may allow a separate SSID specifically for WEP connections. If "disabled" is selected, then clients will not be able to connect with WEP.
Encryption level expansion function	Expands security method from TKIP to WPA/WPA2-PSK-mixed mode.
Dedicated WEP SSID isolation	Set a separate SSID and network segment specifically for WEP connections. Devices connected with WEP will not be able to communicate with devices connected using AES/TKIP. All connected devices will be able to communicate with the internet.
Allow WEP for Game consoles	When enabled, the AirStation allows wireless devices to connect with 64-bit or 128-bit WEP.
AOSS Button on the AirStation Unit	Uncheck to disable the physical AOSS button on the AirStation.
Current Encryption Information (AOSS connection only)	Displays the encryption type, SSID, and encryption key configured by AOSS.
[Random]	Click to enter random values for SSID, encryption key, and other settings.
[KEY base]	Click to return the SSID, encryption key, and other wireless settings to the values on the case sticker.
[Reset]	Click to return the SSID, encryption key, and other wireless settings to their previous values.
AOSS Client Information*	Displays AOSS clients connected to the AirStation and information of the devices which are wirelessly communicated.
AOSS Ethernet Converter Information*	Displays information about Ethernet converters connected to the AirStation via AOSS.
* Only displayed if there are AOSS Connections	

Basic

The screen to configure a basic wireless settings.

The screenshot displays the 'Basic Wireless Setting (11n/g/b)' configuration page. At the top, there are navigation tabs: Setup, Internet/LAN, Wireless Config, Security, LAN Config, NAS, Admin Config, and Diagnostic. Below these are sub-tabs: WPS, AOSS, Basic(11n/g/b), Advanced(11n/g/b), WMM(11n/g/b), MAC Filter, Multicast Control, and WDS. A 'Logout' link is in the top right. The main configuration area includes:

- Wireless Radio:** Enable
- Wireless Channel:** Auto Channel (Current Channel: 5)
- 300Mbps Mode:** Band Width: 20 MHz, Extension Channel: 1
- Broadcast SSID:** Allow
- Use Multi Security function:** [Button]
- Separate feature:** Use
- SSID:** Use AirStation's MAC address(00037FBFEF04D) or Enter: [Text Field]
- Wireless authentication:** WPA/WPA2 mixedmode - PSK
- Wireless encryption:** TKIP/AES mixedmode
- WPA-PSK (Pre-Shared Key):** [Masked Text Field]
- Rekey interval:** 60 minutes
- Apply:** [Button]

 A help sidebar on the right provides details:

- Wireless Radio:** Un-checking "Enable" will disable wireless LAN functionality. When disabled, all wireless functionality, including broadcasting, is halted. Default value is enabled.
- Wireless Channel:** You may specify a channel (frequency band) for your wireless communication. If there are other wireless clients near the AirStation, you may get interference. Change to a different (and preferably non-overlapping) channel in this case. Available channels vary with which wireless standard you're using. When Auto channel is selected, a vacant channel is selected automatically. 11n/g/b: Auto, 1-11 Channel (Default value: Auto channel).

 At the bottom, a copyright notice reads: (C)2000-2011 BUFFALO INC. All rights reserved.

Parameter

Meaning

Wireless Radio	Determines whether to allow wireless communication. If this is unchecked, then no wireless connections will be allowed.
Wireless Channel	Sets a channel (a range of frequencies) for wireless connections. With Auto Channel selected, the AirStation will automatically use the best available channel.
300 Mbps Mode	300 Mbps mode uses twice the normal frequency range, 40 MHz instead of 20 MHz. In uncongested areas this can increase performance. To use 300 Mbps mode, set the Bandwidth to 40 MHz and choose an Extension Channel. Note: If Auto Channel is selected, then the Extension Channel is set automatically.

Parameter	Meaning
Broadcast SSID	If [Allow] is checked, then the AirStation will respond to SSID searches from wireless devices by broadcasting its SSID. If [Allow] is unchecked, then the AirStation ignores SSID searches from wireless devices.
Use Multi Security function Do not use Multi Security function	Clicking [Use Multi Security function] will enable Multi Security, allowing the use of multiple SSIDs, each with different wireless security settings. Clicking [Do not use Multi Security function] will disable Multi Security. The AirStation will then allow one SSID and one type of wireless security. Note: When using Multi Security, enable at least one of the following: SSID1, SSID2, or SSID3.
SSID1	Multi Security SSID1 can use WPA-PSK-TKIP or WPA/WPA2-Mixed for wireless security.
SSID2	Multi Security SSID2 can use WPA-PSK-AES for wireless security.
SSID3	Multi Security SSID3 can use WEP for wireless security.
Separate	When enabled, wireless devices connected to the AirStation can communicate only with the Internet side, not with each other.
SSID	Set SSID using 1 - 32 alphanumeric characters.
Wireless authentication	Specifies an authentication method used when connecting to a wireless device.

Parameter	Meaning
Wireless encryption	<p>You may use any of the following types of encryption:</p> <p>No encryption Data is transmitted without encryption. With this setting, anyone within range can connect to your wireless network and might be able to access data on the network. Not recommended for anyone with private data that needs to be kept secure. [No encryption] can be selected only when [No authentication] is selected for wireless authentication.</p> <p>WEP WEP is a common encryption method supported by most devices. WEP can only be selected when wireless authentication is set to [No authentication]. Note that WEP's encryption is weak, and networks protected with WEP are not much more secure than those with no encryption at all. Not recommended for anyone with private data that needs to be kept secure.</p> <p>TKIP TKIP is an encryption method which is more secure than WEP, but slower. Use an pre-shared-key to communicate with a wireless device. TKIP can be selected only when WPA-PSK or WPA2-PSK is selected for Wireless authentication.</p> <p>AES AES is more secure than TKIP, and faster. Use a pre-shared-key to communicate with a wireless device. AES can be selected only when WPA-PSK or WPA2-PSK is selected for wireless authentication.</p> <p>TKIP/AES mixed mode TKIP/AES mixed mode allows both TKIP and AES authentication and communication. This is no more secure than TKIP alone, but more convenient for some users. TKIP/AES mixed mode can be selected only when WPA/WPA2 mixed mode - PSK is selected for wireless authentication.</p>
WPA-PSK (Pre-Shared Key)	<p>A pre-shared key or passphrase is the password for your wireless connections. There are two different formats for a pre-shared key. Use 8 to 63 alphanumeric characters (case-sensitive) for an ASCII passphrase, or use 64 alphanumeric characters (0 to 9 and a to f, not case-sensitive) for a hexadecimal passphrase.</p>

Parameter	Meaning
Rekey interval	Set the update interval for the encryption key between 0 and 1440 (minutes).
Set up WEP encryption key	A WEP encryption key (passphrase) may have any of four different formats. An ASCII passphrase may use either 5 or 13 alphanumeric characters (case-sensitive). A hexadecimal passphrase may use either 10 or 26 alphanumeric characters (0 to 9 and a to f, not case-sensitive).

Advanced

Configure advanced wireless settings.



Parameter	Meaning
Multicast Rate	Set the communication speed of multi-cast packets.
DTIM Period	Set the beacon responding interval (1 -255) for which the AirStation responds to a wireless device. This setting is effective only when power management is enabled for the wireless device.
Privacy Separator	If enabled, the Privacy Separator blocks communication between wireless devices connected to the AirStation. Wireless devices will be able to connect to the Internet but not with each other. Devices that are connected to the AirStation with wired connections will still be able to connect to wireless devices normally.

WMM

Set priorities for specific communications.

Setup	Internet/LAN	Wireless Config	Security	LAN Config	NAS	Admin Config	Diagnostic
WPS	AOSS	Basic(11n/g/b)	Advanced(11n/g/b)	WMM(11n/g/b)	MAC Filter	Multicast Control	WDS

Logout

WMM-EDCA Parameters

Priority	Parameter	For AP	For STA
AC_BK(Low)	CWmin:	15	15
	CWmax:	1023	1023
	AIFSN:	7	7
	TXOP Limit:	0	0
	Admission Control:	---	Disable ▾
AC_BE(Normal)	CWmin:	15	15
	CWmax:	63	1023
	AIFSN:	3	3
	TXOP Limit:	0	0
	Admission Control:	---	Disable ▾
AC_VI(High)	CWmin:	7	7
	CWmax:	15	15
	AIFSN:	1	2
	TXOP Limit:	94	94
	Admission Control:	---	Disable ▾
AC_VO(Highest)	CWmin:	3	3
	CWmax:	7	7
	AIFSN:	1	2
	TXOP Limit:	47	47
	Admission Control:	---	Disable ▾

WMM Settings (11n/g/b)

Prioritized AirStation communication for specific transactions. This settings provides some real time communication, which can help improve the quality of VOIP or other streaming protocols.

WMM-EDCA Parameters

It is usually not necessary to change this value.

Priority
The priority is ranked (Highest)8 : (High)4 : (Normal)2 : (Low)1 for each packet.

Parameter

CWmin, CWmax
The maximum and minimum value for the contention window. The contention window is used to control the frame collision avoidance system in IEEE802.11. Values that can be inputted: 1-32767.

AIFSN
Interval of the sending frame. The unit defines a time-slot (similar to the window value of CWmin, CWmax). Lower values define a higher priority as the back-off algorithm starts earlier. Values that can be inputted: 1-15.

TXOP Limit
The time for the queue to obtain send priority. The minimum value is 32ms. Large values can send more frames at a time. However, latency may increase. Only one frame is transferred at the time when the TXOP Limit is 0.

(C)2000-2011 BUFFALO INC. All rights reserved.

Parameter	Meaning
WMM-EDCA Parameters	<p data-bbox="641 321 1442 394">You don't usually need to change these settings. Using the default settings is recommended.</p> <p data-bbox="641 422 740 453">Priority</p> <p data-bbox="662 457 1442 600">The following priorities may be applied to individual transmission packets: (Highest) 8, (High) 4, (Normal) 2, and (Low) 1. From the queue, these packets are processed in order of priority.</p> <p data-bbox="641 627 846 659">CWmin, CWmax</p> <p data-bbox="662 663 1442 846">The maximum and minimum value of the contention window. The contention window is used in the frame collision avoidance structure performed in IEEE802.11, and generally, the smaller the value in the window, the higher the probability that the queue obtains the right to send.</p> <p data-bbox="641 873 721 905">AIFSN</p> <p data-bbox="662 909 1442 1052">The interval to send frames. The unit of the AIFSN is a slot, just as the window defined by CWmin and CWmax is. The smaller the interval of sending frames, the faster the algorithm can restart. As a result, the priority of the queue is higher.</p> <p data-bbox="641 1079 786 1110">TXOP Limit</p> <p data-bbox="662 1115 1442 1297">The period of time that the queue can use after obtaining the right to send. The unit is 32 ms. The longer this time, the more frames can be sent per right to send. However, the queue may interfere with other packet transmissions. If TXOP Limit is set to 0 (zero), only one frame can be sent per right to send.</p> <p data-bbox="641 1325 878 1356">Admission Control</p> <p data-bbox="662 1360 1442 1467">Restricts new frames from interfering with a previous queue. New packets are prioritized lower until a queue of them is collected. As the new queue accumulates more packets, its priority increases.</p>

MAC Filter

Restrict access to specific wireless devices.

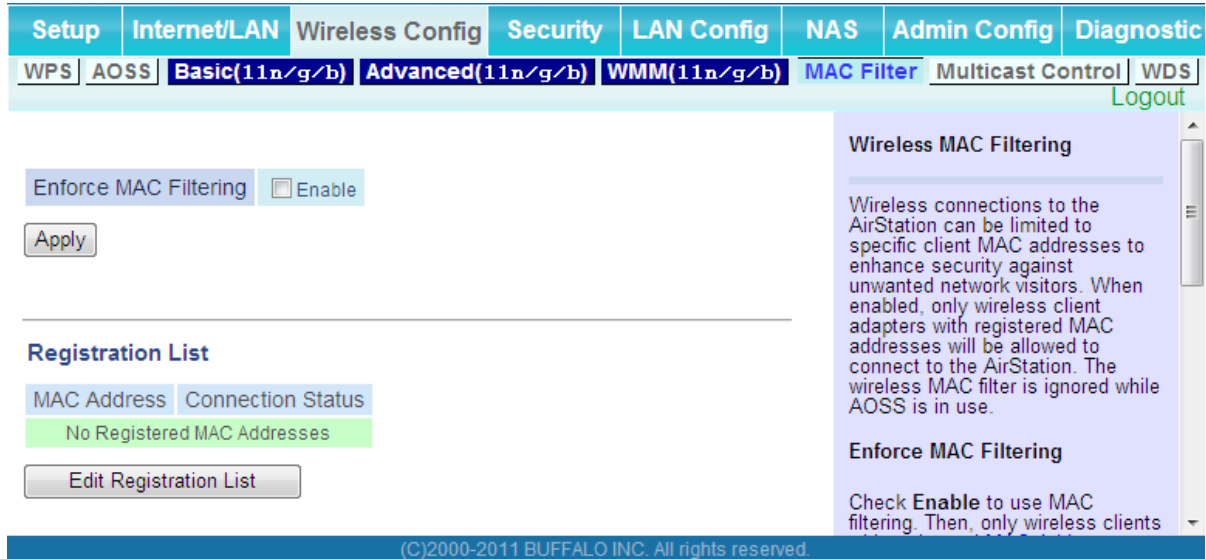

Parameter	Meaning
Enforce MAC Filtering	Enable to restrict wireless connections to devices with registered MAC addresses.
Registration List	Displays the MAC addresses of registered devices which are permitted to connect wirelessly.
Edit Registration List	Adds a wireless device to the list of permitted devices.
MAC Addresses to be Registered	Enter a MAC address of a wireless device to permit to connect to the AirStation. Click [Register] to add that MAC address to the list.
List of all clients associated with this AirStation	Display the list of all MAC addresses of wireless devices connected to the AirStation.

Multicast Control

Configure restrictions on unnecessary multicast packets sent to the wireless LAN port.



Parameter	Meaning
Snooping	If enabled, snooping supervises multicast administrative packets such as IGMP and restricts unnecessary multicast transfers to wired or wireless ports.
Multicast Aging Time	Set the time to hold the data from multicast snooping in the range of 1 to 3600 (seconds). Enter a value bigger than the IGMP/MLD query interval.

WDS

WDS bridging allows communication between AirStations.

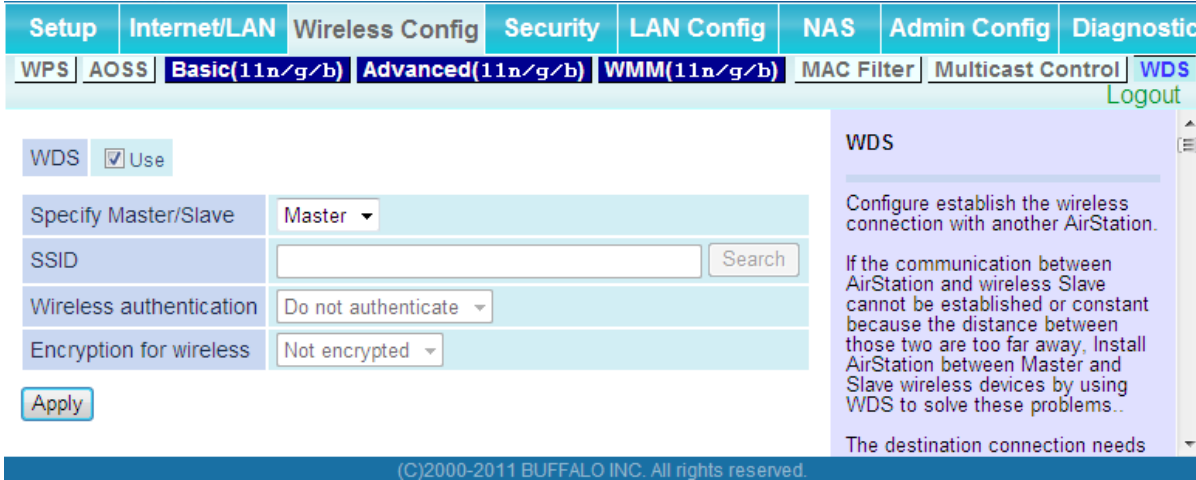

Parameter	Meaning
WDS	Check to use WDS bridging.
Specify Master/Slave	<p>Define this AirStation's role in a WDS bridge.</p> <p>Master This AirStation will be the master in a WDS bridge. It will have the Internet connection, and other AirStations in the bridge will be connected through this AirStation.</p> <p>Slave Slave AirStations are connected to the master AirStation.</p> <p>Auto Automatically switches between Master and Slave modes depending on the surrounding network. If an AirStation works as a router, it will automatically be set as a master. If the Airstation works as a bridge and a DHCP server exists in the network, it will automatically be set as a master . If the AirStation works as a bridge and no DHCP server is available, it will automatically be set as a slave.</p>

Parameter	Meaning
SSID	Configure the Master Airstation's SSID.
[Search]	Click to search for other AirStations' SSIDs.
Wireless authentication	Configure authentication method for the master AirStation
Encryption for wireless	Choose encryption type for the master AirStation.
WPA-PSK (Pre Shared Key)	Set the master AirStation's Encryption key.

Notes: Two AirStation can be connected per one Master AirStation.
 The slave AirStation is allowed to connect to another slave AirStation as lower slave AirStation.
 The lower slave AirStation is not allowed to connect to another slave AirStation.
 The slave AirStation is not allowed to communicate with the lower Slave AirStation or client adapters when it is not connected to a master AirStation.

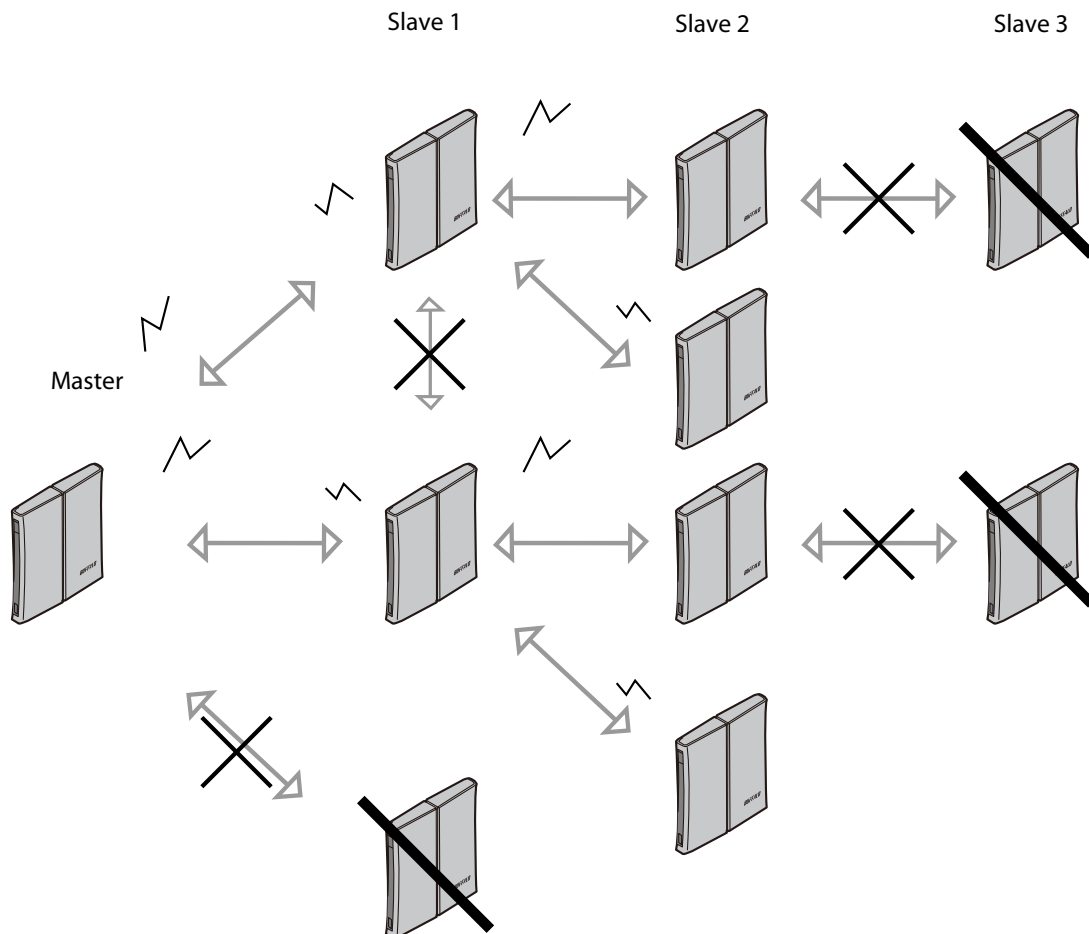

Security (Router Mode only)

Firewall (Router Mode only)

Configure the AirStation’s firewall.

Parameter	Meaning
Log Output	Enable to output a log of firewall activity.
Basic Rules	<p>Enable to use any of the quick filters. Preconfigured quick filters include:</p> <p>Prohibit NBT and Microsoft-DS Routing Enabling this blocks communication using these protocols from the WAN side to the LAN side or from the LAN side to the Internet. You can configure this with PPPoE if you select [Use PPPoE Client] or [Use IP Unnumbered] in Method of Acquiring IP address (page 33), or if Easy Setup identified a PPPoE connection during setup.</p>

Parameter	Meaning
	<p data-bbox="641 321 932 352">Reject IDENT Requests</p> <p data-bbox="662 359 1458 611">Enabling this option will answer IDENT requests from the Internet side with corresponding rejection packets. Enable this option if you experienced slow transfer speeds for network applications such as mail, ftp or web browsing. If you have configured transfer of IDENT requests to the LAN side computer in the address translation settings (DMZ or TCP port 113), then that setting has higher priority, and overrides this setting.</p> <p data-bbox="641 642 959 674">Block Ping from Internet</p> <p data-bbox="662 680 1458 856">If this is enabled, the AirStation will not respond to pings from the Internet side. You can configure this with PPPoE if you select [Use PPPoE Client] or [Use IP Unnumbered] in Method of Acquiring IP address (page 33), or if Easy Setup identified a PPPoE connection during setup.</p>

IP Filter (Router Mode only)

Edit IP filters.

Parameter	Meaning
Log Output	If enabled, IP filter activity is saved to a log.
Operation	Specify how to process target packets.
Direction	Specify the transmission direction of target packets.
IP Address	Specify the sender's IP address and receiver's IP address of the target packets.
Protocol	Select a protocol for target transmission packet.
IP Filter Information	Display the list of IP filters which have been registered.

VPN Passthrough (Router Mode only)

Configure IPv6 passthrough, PPPoE passthrough, and PPTP passthrough.

The screenshot shows the router's configuration interface for VPN Passthrough. The navigation menu at the top includes Setup, Internet/LAN, Wireless Config, Security, LAN Config, NAS, Admin Config, and Diagnostic. Under Security, there are sub-menus for Firewall, IP Filter, and VPN Pass Through. The main content area has three settings:

- IPv6 Pass Through: Enable
- PPPoE Path Through: Enable
- PPTP Pass Through: Enable

An 'Apply' button is located below these settings. On the right, a sidebar titled 'VPN Pass Through' contains the following text:

VPN Pass Through
Specify VPN Pass Through settings.

IPv6 Pass Through
Select whether to use IPv6 Pass-through for address translation. The default setting is disabled.

Note:

At the bottom of the page, a copyright notice reads: (C)2000-2010 BUFFALO INC. All rights reserved.

Parameter	Meaning
IPv6 Passthrough	Enable to use IPv6 Passthrough for address translation.
PPPoE Passthrough	Enable to use PPPoE bridging. PPPoE bridging lets you automatically obtain an IP address from your provider for your LAN-side computer using the PPPoE protocol because PPPoE packets can pass between the Internet and LAN.
PPTP Passthrough	Enable to use PPTP passthrough for address translation.

LAN Config

Port Forwarding (Router Mode only)

Configure port translation.

Setup	Internet/LAN	Wireless Config	Security	LAN Config	NAS	Admin Config	Diagnostic
Port Forwarding	DMZ	UPnP	QoS	Movie Engine			

[Logout](#)

Add Port Forwarding

Group	New Group ▾ Group Name: <input type="text"/>
Internet Side IP Address	AirStation's Internet IP Address ▾ Manual IP Address: <input type="text"/>
Protocol	<input type="radio"/> All <input type="radio"/> ICMP <input type="radio"/> Manual Protocol Number: <input type="text"/> <input checked="" type="radio"/> TCP/UDP TCP Port Manual Setup ▾ Specification Method Port Number: <input type="text"/>
LAN Side IP Address	192.168.11.2 <input type="text"/>
LAN Side Port	TCP/UDP Port: <input type="text"/>

Port Forwarding Registration Information

Group	Internet Side IP Address LAN Side IP Address	Protocol LAN Side Port	Customize
Port Forwarding has not been set up yet			

Port Forwarding Settings

Although the AirStation performs Address Translation only for communication which is started from the LAN side, certain applications, such as network games, require that you allow communications from the Internet side via ([Static NAT](#)). Edit the rules for communicating from outside the internal network to the LAN side network device([Static NAT](#)) carefully, consulting your internet game's documentation as necessary. Up to 32 rules can be registered.

Add/Edit Port Forwarding

You can add new port forwarding information and edit existing information.

Group

You can give a name (group name) to configured [Static NATs](#) and give multiple [Static NATs](#) one name and manage them together. By giving names to groups, you can [Enable] or [Disable] each separately. To add a [Static NAT](#) rule to existing group, select the group from the drop-down box and choose [Add].

(C)2000-2010 BUFFALO INC. All rights reserved.

Parameter

Meaning

Group	Specify a group name for a new rule to belong to. Select [New Group] and enter the new group name in the Group Name field to create a new group. A group name can include up to 16 alphanumeric characters.
Internet Side IP Address	Enter the Internet side IP address (before translation) for the port translation table entry.
Protocol	Select the Internet side protocol (before translation) for the port translation table entry.

Parameter	Meaning
LAN Side IP Address	Enter the LAN side IP address (after translation) for the port translation table entry.
LAN Side Port	Select the LAN side (after translation) port number (1 - 65535) for the port translation table entry.
Port Forwarding Registration Information	Shows current entries in the port translation table.

DMZ (Router Mode only)

Configure a destination to transfer communication packets without a LAN side destination to.

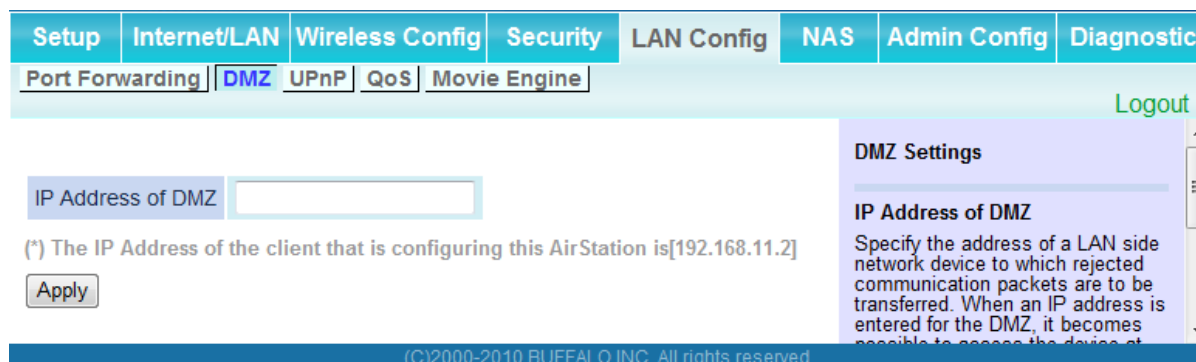

Parameter	Meaning
IP Address of DMZ	Enter the IP address of the destination to which packets which are not routed by a port translation table are forwarded. Note: RIP protocol packets (UDP port number 520) will not be forwarded.

UPnP (Router Mode only)

Configure UPnP (Universal Plug and Play).



Parameter	Meaning
UPnP	Enable or disable Universal Plug and Play (UPnP) functionality.

QoS (Router Mode only)

Configure the priority of packets sent to the Internet.

QoS for transmission to the Internet Enable

Upload bandwidth Kbps

No.	Enable	application name	protocol	destination port	priority
1	<input type="checkbox"/>	VoIP	UDP		high
2	<input type="checkbox"/>	ssh	TCP	22	medium
3	<input type="checkbox"/>	telnet	TCP	23	medium
4	<input type="checkbox"/>	ftp	TCP	21	low
5	<input type="checkbox"/>		TCP		low
6	<input type="checkbox"/>		TCP		low
7	<input type="checkbox"/>		TCP		low
8	<input type="checkbox"/>		TCP		low

Apply

QoS Setting
 QoS is a technology to use the bandwidth on the network more effectively. When two or more packets arrive at the same time, the packet with higher priority is processed first. This can be used to give priority to communications that require real time processing, such as VOIP.

QoS for transmission to the Internet
 If checked, this gives priority to packets being transmitted to the Internet. When enabled, you will be able to add four levels of increased priority for specific applications. By default, this is disabled.

Uplink Bandwidth
 Specify the bandwidth transferred from this unit to the Internet in kbps. The real uplink bandwidth should be entered. If a bandwidth value larger than the real line speed is entered, the uplink bandwidth will be limited by the line speed. If a smaller bandwidth value is entered, the maximum line speed cannot be used. Use a link speed measuring tool on the

(C)2000-2010 BUFFALO INC. All rights reserved.

Parameter

Meaning

QoS for transmission to the Internet	Determine whether or not to prioritize packets sent to the Internet. Check this box to enable QoS.
Upload bandwidth	Specify the upstream bandwidth in kbps from the AirStation to the internet side. Set the actual value for the upstream bandwidth.
Enable	Enable or disable this entry.
application name	Enter an application name. Names may use up to 32 alphanumeric characters, double or single tick marks ("), quotation marks ("), and semicolons (;).
protocol	Select either TCP or UDP.
destination Port	Specify a destination port from 1 - 65535. If this field is empty, a random port is selected.

Parameter	Meaning
priority	Select high, medium or low. If packets do not qualify for classification as a type on the list, then their priority is treated as a level between medium and low.

Movie Engine (QoS)

Configure Movie Engine options.

Setup
Internet/LAN
Wireless Config
Security
LAN Config
NAS
Admin Config
Diagnostic

Port Forwarding
DMZ
UPnP
QoS
Movie Engine
Logout

*** This setting is enabled when the "Movie Engine" switch on the main unit is set to "ON".**

Movie Engine switch status ON

Packet Control Setting

IPv6 Pass Through	<input checked="" type="checkbox"/> Use
Multicast Rate	11 Mbps ▼
Multicast Control	Snooping Function <input checked="" type="checkbox"/> Use
	Aging Time 300 Seconds
	Change Priority VI (priority) ▼
TCP Rwin Size Limit	Size Limit <input type="checkbox"/> Limit
	Maximum Rwin Size 65536 bytes

Apply

Wireless Priority Control Rules

No.	MAC Address	IP address	Protocol	Port Number	Priority
Wireless priority control rules not registered.					

Editing of Priority Control Rules

Transmission Rate Limit

Priority	Transmission Rate	Number of Retries
BackGround	No Limits ▼	No Limits ▼
BestEffort	No Limits ▼	No Limits ▼
Voice	No Limits ▼	No Limits ▼
Video	No Limits ▼	No Limits ▼

Apply

Movie Engine

Details the configuration options for the Movie Engine feature. When Movie Engine switch is ON position, this router optimizes packet transfer of video or audio data. This page configures video or audio data processing in specific when Movie Engine switch is ON position.

Movie Engine Status

Display the status (ON/OFF) of the Movie Engine switch on the main unit. The Movie engine feature is enabled when the switch is ON.

Packet Control Setting

IPv6 Pass Through

Enable IPv6 Pass Through when the Movie Engine switch is ON. The router transfers IPv6 packets between the Internet and LAN. The factory default setting is [Enabled].
* This function is only enabled when the AirStation is in Router mode.

Multicast Rate

Configure Multicast Control when the Movie Engine switch is ON. The factory default setting is [11 Mbps].

Multicast Control

Multicast control setting when the Movie Engine switch is ON.

Snooping Function

Enable the Multicast Snooping function. Checking Use when the Movie Engine switch is ON will force Multicast control. The factory default setting is [Use].

Aging Time

The Aging Time for Multicast Snooping feature. This setting range is 1-3600 seconds. The factory default setting is [300]

(C)2000-2009 BUFFALO INC. All rights reserved.

Parameter	Meaning
Movie Engine switch status	Displays the status of the Movie Engine switch.
IPv6 Passthrough	Set to enable the IPv6 pass-through.
Multicast Rate	Select the Multicast Control rate.
Multicast Control	Turn on Multicast Control.
TCP Rwin Size Limit	Limits the maximum size of TCP Rwin packets passing through the AirStation's wireless LAN.
Wireless Priority Control Rules	Display the list of rules controlling the priority of packets passing through the AirStation's wireless LAN.
Transmission Rate	Select the maximum transmission rate.
Number of Retries	Select maximum number of retries.

NAS

Disk management

View the status of and configure attached USB hard disks.

Setup | **Internet/LAN** | **Wireless Config** | **Security** | **LAN Config** | **NAS** | **Admin Config** | **Diagnostic**

Disk Management | **Shared Folder** | **User Management** | **Shared Service** | **Logout**

Web Access | **Media Server** | **BitTorrent**

USB Disk Information

Device	Disk Assignment	Partition Information
BUFFALO ClipDrive <input type="button" value="Remove"/>	Disk1 (Automatic Assignment)	Partition1 Format: FAT Status: Mounted Used/Available(%): 323,300 / 506,864 (64%) Operate: <input type="button" value="Format"/>

[Advanced Settings]

Automatic USB Disk Assignment	<input checked="" type="checkbox"/> Use
FAT format file name character code	North America (CP437) ▾
HDD power-saving function	<input type="checkbox"/> Use HDD stop time: 10 Minutes

(C)2000-2010 BUFFALO INC. All rights reserved.

Disk Management

Displays the status of attached USB disks and allows you to manage these disks. Information for up to four connected USB disks is displayed. If the USB disks have multiple partitions, then the information for the first four partitions will be displayed. Windows compatible primary partitions and extended partitions are recognized. The possible operations are format and remove USB disk. Disk file checking is executed with a PC.

Caution

If several drives or one drive with multiple partition is connected, the drive might not be detected properly. Please connect one drive with single partition.

Device

Display detecting USB disk identification.

Caution

The device information is acquired from USB disk. It might be different from product name.

Parameter

Meaning

Device	Displays information for attached USB disks. Disks are removed when [Remove] in the Device column is clicked.
Disk Assignment	A disk number will be automatically assigned to the disk or you can choose a number. Select a disk number, or select [Do not assign], then click [Apply].
Partition Information	Displays the partition information for the selected USB disk. Click [Format] to format the disk. Note: formatting a disk will erase all information on it.
Re-recognize USB devices	Click this to re-scan for connected USB disks.

Parameter	Meaning
Automatic USB Disk Assignment	Check [Use] to automatically select an attached USB hard disk. The entire drive will be used as the shared folder. To configure your disk and share manually, uncheck [Use]. [Use] is selected by default.
FAT format file name character code	Select the character code for filenames in FAT formatted partitions.
HDD power-saving function	Click [Use] to enable power saving mode.
HDD stop time	Powers down the drive after this duration of time.

Shared Folder

Configure a USB hard disk for use with shared folders.

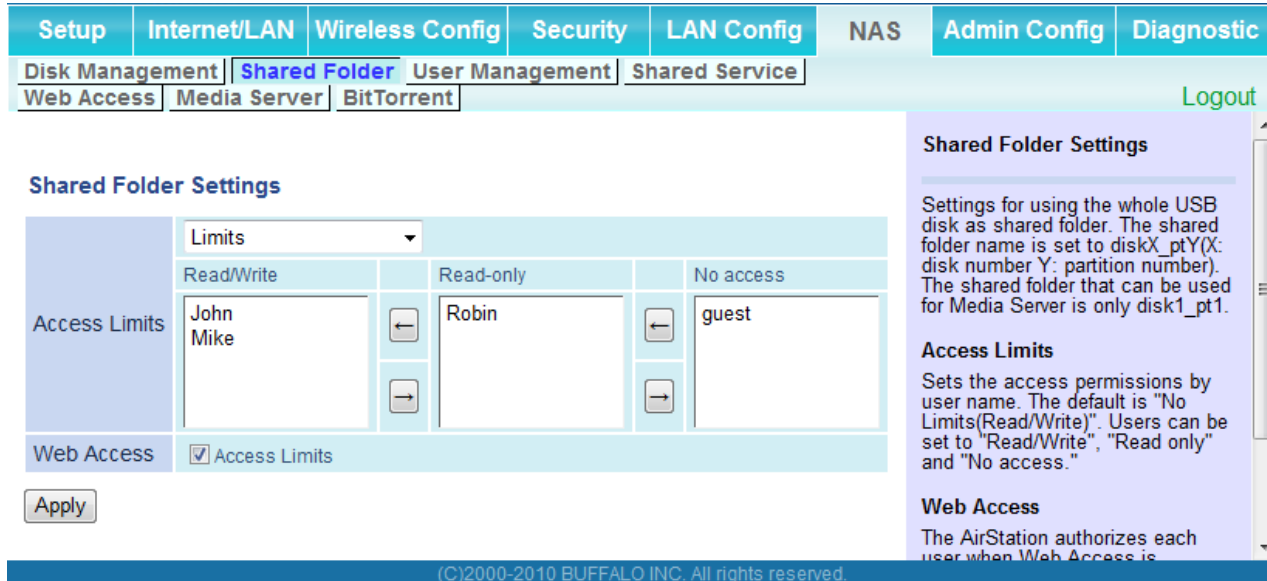

Parameter	Meaning
Shared Folder Name*	Enter a name for the shared folder. Up to 18 alphanumeric characters, spaces, hyphens (-), and underscores (_) may be used.
Shared Folder Description*	Enter a description of the shared folder (optional). Up to 75 alphanumeric characters, spaces, hyphens (-), and underscores (_) may be used.
Disk Partition Area*	Displays the partition area, format type, and the capacity of the USB disk.
Disclosed to*	Check the functionality that you want to support. Win/Mac OS (Samba NAS), Web Access, Media Server, and/or BitTorrent may be checked. Only one folder may be chosen for either Media Server or BitTorrent functionality.
Access Limits	If access limits are enabled, use the arrows to move highlighted users between the columns for [Read/Write], [Read-only], or [No access] privileges.

Parameter	Meaning
Web Access	You may also select to enforce access limits on users accessing through Web Access by checking the Access Limits checkbox. Users will have the same access levels as assigned above. If Access Limits is not checked, then all users accessing the shared folder via Web Access will have [Read only] access..
Shared Folder Registration Information*	Displays information about the shared folder.

* This is not displayed when Automatic USB Disk Assignment (page 71) is used:

The following shared folder settings are used when Disk Management is activated:

- All folders: Access limits in effect.
- Shared Folder/ Web Access: All folders are shared.
- Media Server/BitTorrent: The first folder is shared.

User Management

This screen lets you add users to the access list with the ability to access shared folders.

Setup	Internet/LAN	Wireless Config	Security	LAN Config	NAS	Admin Config	Diagnostic
Disk Management	Shared Folder	User Management	Shared Service	Logout			
Web Access	Media Server	BitTorrent					

Add User

User Name	<input type="text"/>
Password	<input type="password"/>
	<input type="password"/> (confirmation)
User Description	<input type="text"/>

Current Users

No.	User Name	User Description	Operation
--	guest	Built-in account for guest access to the system	---
1	John	office	<input type="button" value="Edit"/> <input type="button" value="Delete"/>
2	Mike	home	<input type="button" value="Edit"/> <input type="button" value="Delete"/>
3	Robin	guestroom	<input type="button" value="Edit"/> <input type="button" value="Delete"/>

User Management

User Name
Set the user names that will have access to shared folders. From 1 to 20 8-bit alphanumeric characters, " " " " and " " can be used. Symbols cannot be used as the first character. The maximum number of users that can be registered is 16.

Password
Set the password necessary to access shared folders. From 1 to 20 8-bit alphanumeric characters, " " and " " can be used. "." cannot be used as the first character. For Windows 98SE, 98 and 95, up to 14 8-bit alphanumeric characters can be used. For Mac OS, up to eight 8-bit alphanumeric characters can be used. There is a possibility that shared folders will become inaccessible.

User Description
Set user description. Up to 75 8-bit characters can be input. Characters from various countries, 8-bit spaces, and the symbols "-"

(C)2000-2010 BUFFALO INC. All rights reserved.

Parameter

Meaning

Username	Enter the name of a user to be given access to the shared folder. Up to 20 alphanumeric characters, space, hyphens (-), and underscores (_) may be used for each user. Up to 16 users may be entered.
Password	Enter the user's password. Use of the same password that they use to log into their computer is recommended. Up to 20 alphanumeric characters, spaces, hyphens (-), and underscores (_) may be used. For Windows 98SE/98/95 users, up to 14 alphanumeric characters may be used. Mac OS users may use up to 8 alphanumeric characters. If you enter a longer password than your users can use, then they will not be able to access the share.
User Description	Describe the user (optional). Up to 75 alphanumeric characters, spaces, hyphens (-), and underscores (_) may be used.
Current Users	Lists current users, including "guest". Guest is a built-in account that cannot be changed or deleted.

Shared Service

Assign AirStation and workgroup names to access shared folders.

Parameter	Meaning
Shared Folder	Enable to make a USB disk available on your local network.
AirStation name	Rename your AirStation if desired. Up to 15 alphanumeric characters, space, and hyphens (-), may be used. The AirStation name is also used as the hostname that will be used with the shared service. The shared service may not be available if you use over 15 alphanumeric characters in your AirStation's name.
AirStation Description	Describe the AirStation (optional). Up to 48 alphanumeric characters, space, hyphens (-), and underscores (_) may be used.
Workgroup name	Enter your workgroup name. Up to 15 alphanumeric characters, space, hyphens (-), underscores (_), and periods (.) may be used.
Windows Client Language	Select the language to be used by the Windows client.
Shared Service	Displays the status of the USB disk that is used with the shared service.

Web Access

The screen to configure Web Access.

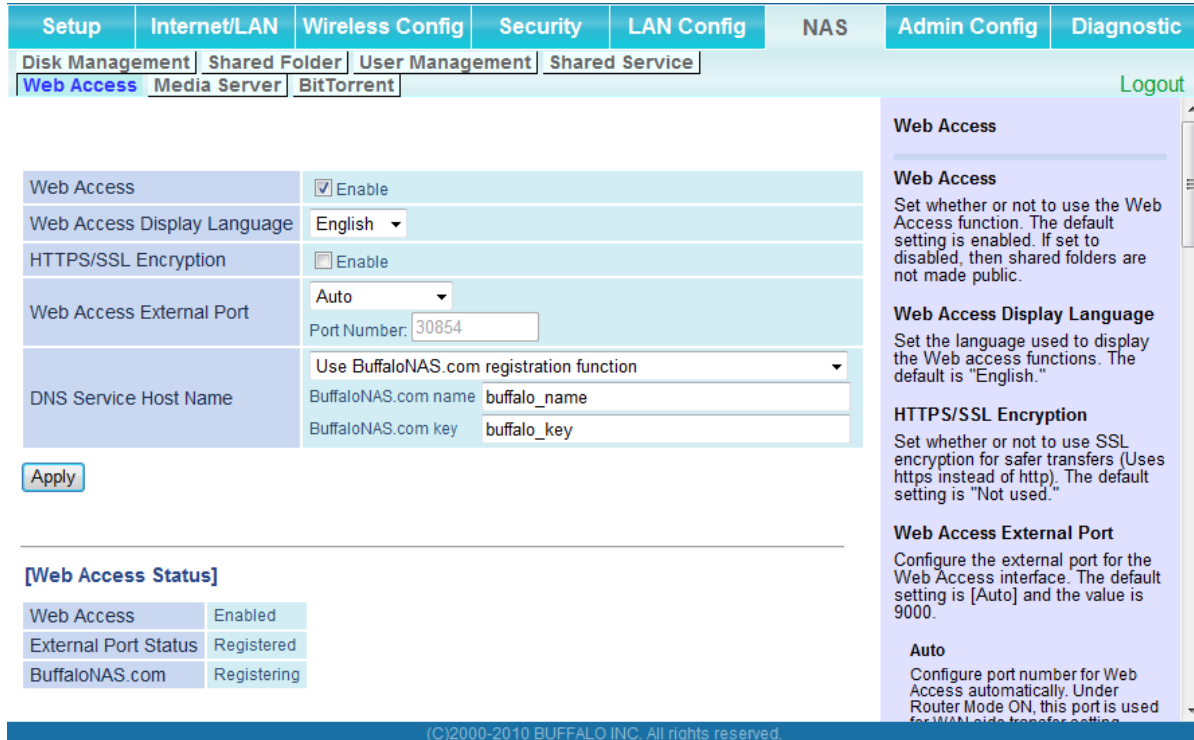

Parameter	Meaning
Web Access	Check [Enable] to use Web Access.
Web Access Display Language	Set the language to be used with Web Access.
HTTPS/SSL Encryption	Check [Enable] to use SSL encryption for protected data transfer.
Web Access External Port	Automatically sets the external port used for Web access. To select the port manually, select [Manual].
DNS Service Hostname	Sets the DNS Service Hostname when the Web access function is activated. Select [Use BuffaloNAS.com registration function] to use the Web access function easily. You'll have to configure a [BuffaloNAS.com name] and [BuffaloNAS.com key] to use BuffaloNAS.com. 3 - 0 alphanumeric characters, spaces, hyphens (-), underscores (_) and period (.), may be used in the BuffaloNAS.com name. 3 - 20 alphanumeric characters, spaces, hyphens (-), underscores (_) and period (.), may be used in the BuffaloNAS.com key. Note: The registered name is deleted from the server if the AirStation is disconnected from power, even for a moment.

Parameter	Meaning
Web Access	Displays the status of web access.
External Port Status	Displays the status of the external port.
BuffaloNAS.com	Displays the status of BuffaloNAS.com.

Media Server

Media Server settings.

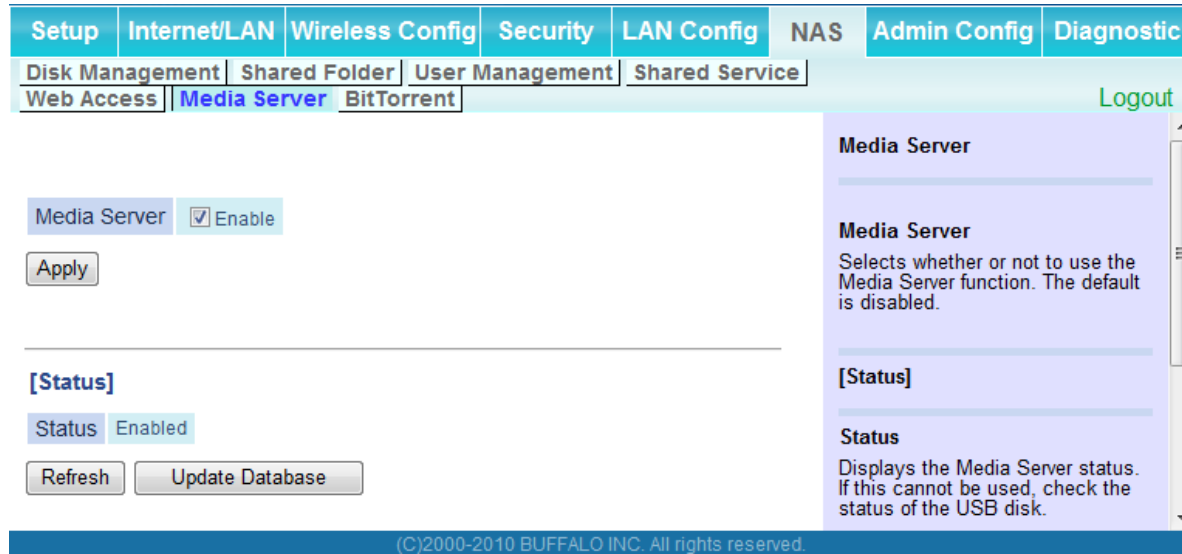

Parameter	Meaning
Media Server	Enable to use the media server.
Status	Displays the status of the media server.

BitTorrent

Configure the BitTorrent client.

Setup	Internet/LAN	Wireless Config	Security	LAN Config	NAS	Admin Config	Diagnostic
Disk Management	Shared Folder	User Management	Shared Service				
Web Access	Media Server	BitTorrent					

[Logout](#)

BitTorrent Function	<input checked="" type="checkbox"/> Enable
External Port Number	Auto
	Port Number <input type="text" value="31759"/>

[Advanced Settings]

Bandwidth Restriction	<input checked="" type="checkbox"/> Enable
Maximum Download Speed	<input type="text" value="1000"/> KB/s
Maximum Upload Speed	<input type="text" value="200"/> KB/s

[BitTorrent Status]

BitTorrent Status	Not Available (specified disk's file system does not support BitTorrent.)
BitTorrent External Port Status	Registered

BitTorrent

BitTorrent Function
 Allows you to enable/disable the BitTorrent function. The default setting is disabled. You can get downloaded BitTorrent files via shared folder or Web Access function. Please configure the folder setting from "Disclosed to" of "Shared Folder" page. Downloaded files are stored in bittorrent folder on the USB disk. Automatic USB Disk Assignment is set to [Use] : disk1_pt1/bittorrent Automatic USB Disk Assignment is set to [Do not use] : shared folder name/bittorrent

if you use BitTorrent, transmission quality may be degraded or the response of the configuration screen may become slow.

Caution
 Bit Torrent can be only used when XFS is used as a format on USB drive.

External Port Number
 Specify the external port number for BitTorrent. The default is [Auto] and the value is [9002].

Auto

(C)2000-2010 BUFFALO INC. All rights reserved.

Parameter	Meaning
BitTorrent Function	Enable to use the BitTorrent client. If the BitTorrent client is enabled, overall communication performance may decrease and settings screens may respond slower. If that happens, reformat the USB disk with XFS. That may help performance.
External Port Number	Select an external port number.

Parameter	Meaning
Bandwidth Restriction	Set a bandwidth limit for BitTorrent.
[Download Manager]	Displays the BitTorrent download manager screen. Add a torrent, then click [Add] to download the file(s).
[Delete BitTorrent information]	Deletes all files, including the torrent files and files which are currently downloading. Downloaded files are not deleted.
BitTorrent Status	Displays the status of the BitTorrent client.
BitTorrent External Port Status	Display the external port status of the BitTorrent client.

You can download the latest Windows BitTorrent client from www.bittorrent.com.

Admin Config

Name

Configure basic AirStation settings.

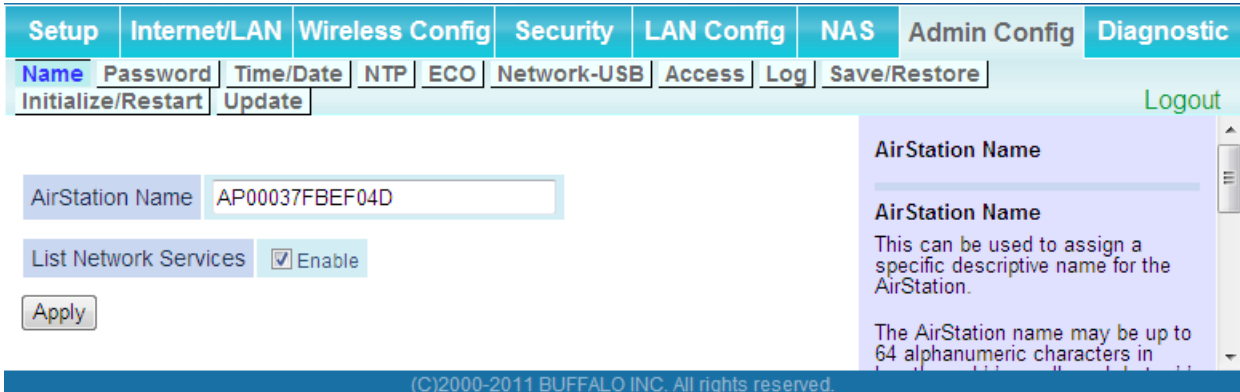

Parameter	Meaning
AirStation Name	Enter a name for the AirStation. Names may include up to 64 alphanumeric characters and hyphens (-).
List Network Services	Enable or disable this to display the computers and devices on your network with their supported services.

Password

Configure the password to log in to the AirStation's configuration screen.

The screenshot shows the configuration web interface for an AirStation. The top navigation bar includes tabs for Setup, Internet/LAN, Wireless Config, Security, LAN Config, NAS, Admin Config, and Diagnostic. The 'Security' tab is active, and the 'Password' sub-tab is selected. Below the navigation bar, there are several menu items: Name, Password, Time/Date, NTP, ECO, Network-USB, Access, Log, Save/Restore, Initialize/Restart, and Update. A 'Logout' link is visible in the top right corner. The main content area contains a form for configuring the Administrator Name and Password. The Administrator Name is set to 'root (fixed)'. The Administrator Password field is empty, and there is a '(Confirm)' label next to it. An 'Apply' button is located below the form. On the right side, there is a sidebar with a scrollable list of configuration items, including 'AirStation Administrator Password', 'Administrator Name', and 'Administrator Password'. The 'Administrator Name' item is expanded, showing a description: 'This is the user name used to log into the AirStation's configuration screens. It cannot be changed from 'root'.'. At the bottom of the page, there is a copyright notice: '(C)2000-2011 BUFFALO INC. All rights reserved.'

Parameter	Meaning
Administrator Name	The name of the Administrator account is "root".
Administrator Password	The Administrator password may contain up to 8 alphanumeric characters and underscores (_).

Time/Date

Configure the AirStation's internal clock.

Parameter	Meaning
Local Date	You may manually set the date of the AirStation's internal clock.
Local Time	You may manually set the time of the AirStation's internal clock.
Time Zone	Specify the time zone (offset of Greenwich Mean Time) of the AirStation's internal clock.
DST (Daylight Saving Time)	You may configure the AirStation to automatically use DST (Daylight Saving Time). If selected, the AirStation will automatically adjust the time at the beginning and end of DST.

NTP

Configure an NTP server to automatically synchronise the AirStation’s internal clock.

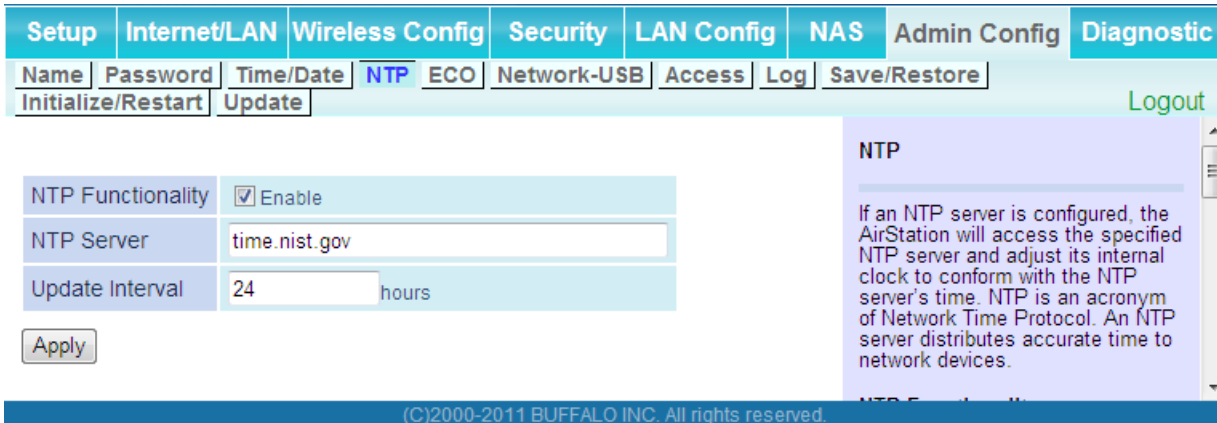

Parameter	Meaning
NTP Functionality	Enable to use an NTP server. The default is Enabled.
NTP Server	Enter the name of the NTP server as a hostname, hostname with domain name, or IP address. Up to 255 alphanumeric characters, hyphens (-), and underscores (_) may be used. The default is “time.nist.gov”.
Update Interval	How often will the AirStation check the NTP server for the correct time? Intervals of 1 - 24 hours may be set. The default is 24 hours.

ECO

Configure Eco mode from this screen.

Setup	Internet/LAN	Wireless Config	Security	LAN Config	NAS	Admin Config	Diagnostic	
Name	Password	Time/Date	NTP	ECO	Network-USB	Access	Log	Save/Restore
Initialize/Restart	Update							Logout

Schedule feature Enable

Weekly schedule

	00	02	04	06	08	10	12	14	16	18	20	22
Sun												
Mon												
Tue												
Wed												
Thu												
Fri												
Sat												

Normal
 Sleep
 User Define

Operational Mode Normal ▾

Start time 0:00 ▾

End time 0:30 ▾

The day of week

Sun	Mon	Tue	Wed	Thu	Fri	Sat
<input type="checkbox"/>	<input type="checkbox"/>	<input type="checkbox"/>	<input type="checkbox"/>	<input type="checkbox"/>	<input type="checkbox"/>	<input type="checkbox"/>

User Define Mode Settings

User Define Mode	LED	Off ▾
	Wired LAN	ECO (Slow operation) ▾
	Wireless LAN	Off ▾

ECO

Configure ECO Mode. Enabling ECO Mode will put it in energy save operation according to Weekly schedule.

Schedule feature

Selecting "Enable" will enable ECO Mode and change the operation mode according to Weekly schedule. The default is disabled.

Note:

- The Operational Mode is changed even during communicating at the time set in the weekly schedule. Please note that communication may be disconnected in such a case.
- AOSS does not work during ECO mode if the Operational Mode is not "normal".
- Pressing and holding AOSS button on the main unit while the Operational Mode is not Normal can temporarily recover it to "Normal".

Weekly schedule

Register Weekly schedule. If you want to change the Operational Mode you have registered, overwrite a period of time you want to change in the new Operational Mode.

Register schedule

Operational Mode
Select the Operational Mode. The default value is "Normal".

Normal
Does not perform energy saving operation.

Sleep
Perform following the energy saving operation.
* Turn off LED
* Stop wired LAN
* Stop wireless LAN

(C)2000-2011 BUFFALO INC. All rights reserved.

Parameter	Meaning
Schedule feature	Enable to schedule Eco Mode. If Eco mode is enabled, AOSS will function only when the AirStation is in Normal operating mode.
Weekly schedule	Graphically displays the configured schedule.
Register schedule	Configure operational mode for time periods in the weekly schedule. If User Defined mode is chosen, configure it below.
User Defined Mode	Individual power saving elements may be configured for User Defined mode.

Network-USB

Configure Network-USB from this screen.



Parameter	Meaning
Network-USB	Network-USB allows sharing USB devices connected to the AirStation from multiple computers on a wired or wireless LAN. Disable to reduce the impact on the NAS and other functions, improve performance, or for security reasons.
Use multifunction Printer	This uses a multifunction printer supporting mass storage classes as a printer. Disable if using as a NAS instead.

Access

Restrict access to the AirStation's settings screens.

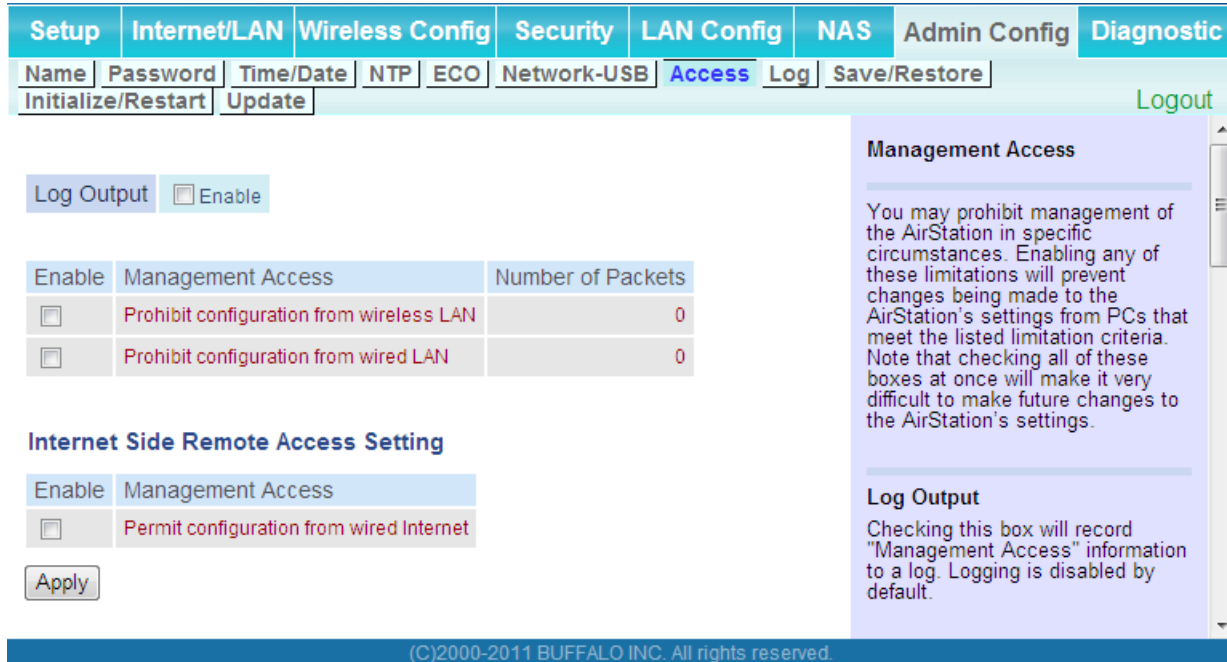

Parameter	Meaning
Log Output	Enabling outputs a log of changes to access settings.
Prohibit configuration from wireless LAN	If enabled, prevents access to settings screens from wirelessly connected devices (only wired devices may configure).
Prohibit configuration from wired LAN	If enabled, prevents access to settings screens from wired devices (only wirelessly connected devices may configure).
Permit configuration from wired Internet	If enabled, allows access to settings screens from network devices on the WAN (Internet) side.
Permitted IP address	Displayed only if Internet side configuration is enabled. Enter the IP address of a device that is permitted to configure the AirStation remotely from the WAN (Internet) side.
Permitted Port	Displayed only if Internet side configuration is enabled. Set a port number (1 - 65535) to configure the AirStation from the WAN (Internet) side.

Log

Transfer the AirStation's logs to a syslog server.

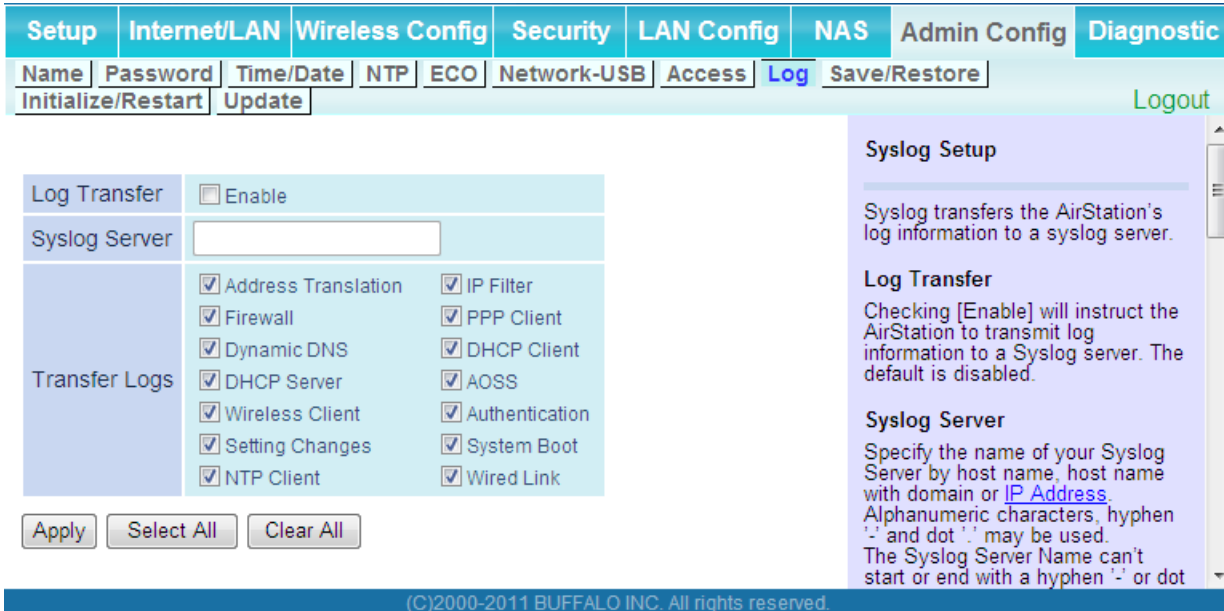

Parameter	Meaning
Log Transfer	Enable to send logs to a syslog server.
Syslog Server	Identify the syslog server by hostname, hostname with domain name, or IP address. You may enter up to 255 alphanumeric characters, hyphens (-), and underscores (_).
Transfer Logs	Choose which logs will be transferred to the syslog server.

Save/Restore

Save AirStation settings as a file, and restore from them later.

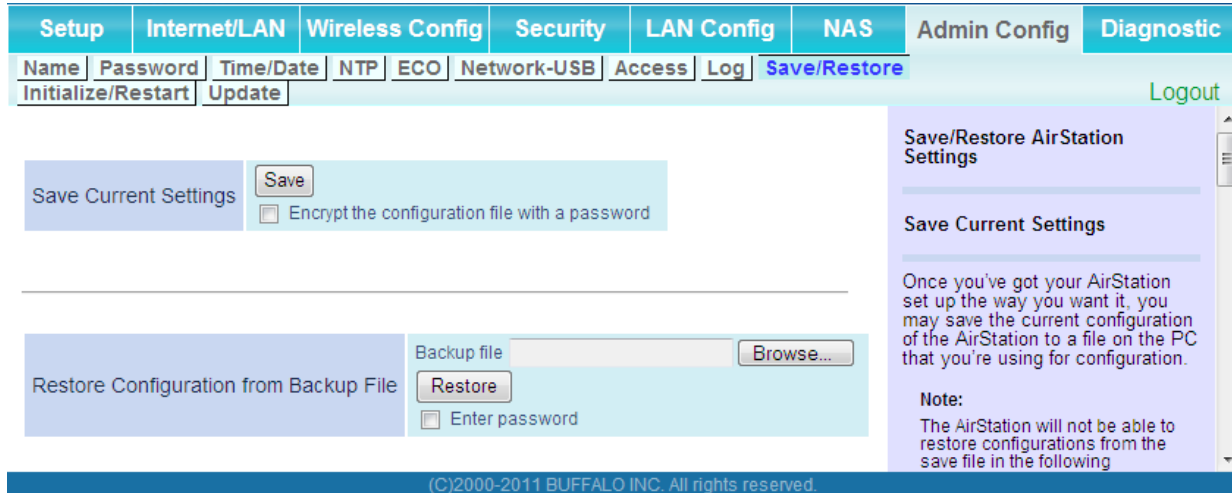

Parameter	Meaning
Save current settings	Clicking [Save] will save the current configuration of the AirStation to a file. If the [Encrypt the configuration file with a password] option is checked, then the configuration file will be password protected with the current administrator password.
Restore Configuration from Backup File	Restore the configuration of the AirStation from a saved configuration file by clicking the [Browse...] button, navigating to the configuration file, and then clicking Restore. If the configuration file was password protected, then put a check next to [To restore from the file you need the password], enter the password, and click [Open].

Initialize/Restart

Initialize or restart the AirStation.

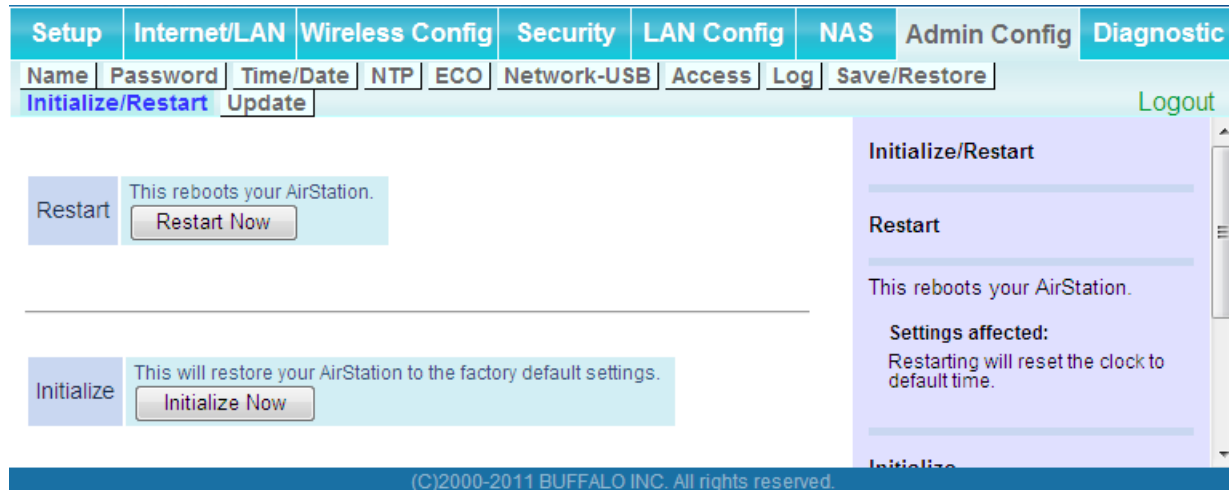

Parameter	Meaning
Restart	Click [Restart Now] to restart the AirStation.
Initialize	Click [Initialize Now] to initialize and restart the AirStation.

Update

Update the AirStation's firmware.



The screenshot shows the 'Firmware Update' section of the AirStation web interface. The main content area includes a table with the following information:

Firmware Version	WZR-HP-G300NH2 Ver.1.79
Update Method	<input checked="" type="radio"/> Specify Local File <input type="radio"/> Automatic Update (On Line Version Up)
Firmware File Name	<input type="text"/> <input type="button" value="Browse..."/>

Below the table is an button. A note below the button reads: ***Get updated firmware files from our website:** [Download Service](#)

The right sidebar contains the following text:

Firmware Update
 Update the AirStation's firmware.

Current Firmware
 Displays the firmware version of the AirStation.

Update Method
 Please select firmware update method.

Specify Local File
 Update the firmware with a file stored on the local PC.

Automatic Update (On Line Version Up)
 Connect to On Line Version Up site via Internet to update firmware.

Firmware file name
 Use the browse button to find the firmware file that will be applied to

(C)2000-2011 BUFFALO INC. All rights reserved.

Parameter	Meaning
Firmware Version	Displays the current firmware version of the AirStation.
Update Method	<p>Specify Local File Updates from a firmware file stored on your computer.</p> <p>Automatic Update (Online Version) Automatically updates to the latest firmware available.</p>
Firmware File Name	Click [Browse...] to navigate to the firmware file on your computer if [Specify Local File] was selected. You don't need to specify the firmware location if you're using [Automatic Update]. Click [Update Firmware] to update the firmware.

Diagnostic

System Info

View system information for the AirStation.

Setup	Internet/LAN	Wireless Config	Security	LAN Config	NAS	Admin Config	Diagnostic
System Info	Logs	Packet Info	Client Monitor	Ping			Logout

Model	WZR-HP-AG300H Ver.1.72 (R1.07/B1.00)	
AirStation Name	AP0024A5C000D8	
Mode Switch Status	Automatic Mode	
Operational Mode	Router Mode ON	
Movie Engine Status	OFF	
Internet	Method of Acquiring IP Address	Auto Detect Mode - PPPoE
	Name of Connection	Easy Setup (Default Connection)
	Connection Status	Online
	Operation	<input type="button" value="Stop"/>
	IP Address	211.18.137.199
	PPP Server IP	61.117.68.185
	DNS1(Primary)	210.196.3.183 (Auto)
	DNS2(Secondary)	210.141.112.163 (Auto)
	MTU Size	1454
	Wired Link	100Base-TX (Full-duplex)
MAC Address	00:24:A5:C0:00:D8	
LAN	IP Address	192.168.11.1
	Subnet Mask	255.255.255.0
	DHCP Server	Enabled
	MAC Address	00:24:A5:C0:00:D8
Wireless(802.11n/a)	Wireless Status	Enabled
	SSID	BUFFALO-C000D8_A
	Authentication	WPA/WPA2 mixedmode - PSK
	Encryption	TKIP/AES mixedmode
	Broadcast SSID	Enable
	Privacy Separator	Disable
	Wireless Channel	40 (Auto)
	300 Mbps Mode	40 MHz (Extension Channel : 36)
MAC Address	00:24:A5:C0:00:D9	
Wireless(802.11n/g/b)	Wireless Status	Enabled
	SSID	BUFFALO-C000D8_G
	Authentication	WPA/WPA2 mixedmode - PSK
	Encryption	TKIP/AES mixedmode
	Broadcast SSID	Enable
	Privacy Separator	Disable
	Wireless Channel	1 (Auto)
	300 Mbps Mode	20 MHz
MAC Address	00:24:A5:C0:00:D8	
NAS	USB disk	Connected
	Shared Folder Function Use	
	Web Access	Use
	Media Server function	Use
	BitTorrent Function	Use
ECO Mode	Status	Disable Schedule feature

System Information

Display the AirStation's main settings.

Model
Displays the model name and firmware version of the AirStation.

AirStation Name
Displays the AirStation's host name.

Status of the hardware mode switch
Displays the status of the ROUTER switch.

Operational Mode
Displays the current mode of operation.

Movie Engine Status
Displays the status of the Movie Engine switch.

Internet
AirStation's [INTERNET port](#) side information.

Method of Acquiring IP Address
Acquiring a Internet IP address.

Name of the Connection
The name of the PPPoE connection specified in the configuration.

Connection Status
Displays the current Internet side status.

Operational Mode
The Operational Mode will show if any DHCP or PPPoE configuration is active. If DHCP is in use, the following commands can be executed.

- [Release] : Releases the IP address assigned by the DHCP Server.
- [Renew] : Renews the IP address from the DHCP Server.

The following commands can be executed when using PPPoE.

- [Start] : Start connecting to a PPPoE Server from idle/stop.
- [Connect] : Connect to PPPoE from an idle condition.
- [Disconnect] : Disconnect communication with a PPPoE Server.
- [Stop] : Stop idle condition.

IP Address
The IP address assigned to the AirStation.

Subnet Mask
The Subnet Mask assigned to the AirStation.

(C)2000-2010 BUFFALO INC. All rights reserved.

Parameter	Meaning
Model	Displays the product name of the AirStation and the firmware version.
AirStation Name	Displays the name of the AirStation.
Mode Switch Status	Displays the status of the AirStation's mode switch.
Operational Mode	Displays the AirStation's current operational mode.
Movie Engine Status	Displays the current Movie Engine Status.
Internet	Displays information about the Internet port.
LAN	Displays information about the LAN port.
Wireless	Displays the wireless status.
NAS	Displays information about the USB disk.
ECO Mode	This indicates the operating status of ECO Mode.

Logs

The AirStation's logs are recorded here.

The screenshot shows the 'Logs' configuration page in the AirStation web interface. At the top, there is a navigation menu with tabs for 'Setup', 'Internet/LAN', 'Wireless Config', 'Security', 'LAN Config', 'NAS', 'Admin Config', and 'Diagnostic'. Under the 'Diagnostic' tab, there are sub-tabs for 'System Info', 'Logs', 'Packet Info', 'Client Monitor', and 'Ping'. The 'Logs' sub-tab is selected. The main content area is divided into two sections: 'Display log info' and 'Logs'. The 'Display log info' section contains a grid of checkboxes for various log categories, including Address Translation, Firewall, Dynamic DNS, DHCP Server, Wireless Client, Setting Changes, NTP Client, IP Filter, PPP Client, DHCP Client, AOSS, Authentication, System Boot, and Wired Link. Below this grid are buttons for 'Display', 'Select All', and 'Clear All'. The 'Logs' section features a 'Save to file logfile.log.' button and a 'Delete' button. A table displays the log entries with columns for Date Time, Type, and Log Content. The table shows three entries for NTP logs from 2010/01/01 01:39:35. On the right side, there is a 'Logout' link and a 'Logs' sidebar with a description of the log information and a list of log categories to be displayed.

Parameter	Meaning
Display log info	Choose the types of logs to display.
Logs	Displays the log information recorded in the AirStation.

Packet Info

View packet transfer information.

Setup	Internet/LAN	Wireless Config	Security	LAN Config	NAS	Admin Config	Diagnostic
System Info	Logs	Packet Info	Client Monitor	Ping	Logout		

Interface	Sent		Received	
	Normal	Errors	Normal	Errors
Wired LAN	37442	0	31143	0
Wired Internet	12745	0	16608	0
PPPoE No. 1: Easy Setup	50	0	55	0
Wireless LAN (802.11n/a)	426	0	0	0
Wireless LAN (802.11n/g/b)	1476	0	0	0

Packet Traffic Information

The total numbers of packets sent and received by the AirStation, as well as the errors sending and receiving, are displayed.

[Refresh] button
Displayed packet information is renewed with current information when this button is clicked.

(C)2000-2010 BUFFALO INC. All rights reserved.

Parameter

Meaning

Sent	Displays the number of packets sent to the WAN, the LAN, and the wireless LAN.
Received	Displays the number of packets received from the WAN, the LAN, and the wireless LAN.

Client Monitor

This screen shows devices that are connected to the AirStation.

MAC Address	Lease IP Address	Hostname	Communication Method	Wireless Authentication	802.11n
00:11:09:94:F5:B9	192.168.11.2	John-PC	Wired	-	-

Refresh

(C)2000-2010 BUFFALO INC. All rights reserved.

Parameter	Meaning
Client Monitor	Displays information (MAC address, lease IP address, hostname, communication method, wireless authentication and 802.11n) for devices that are connected to the AirStation.

Ping

A ping test checks whether the AirStation can communicate with a specific network device.

The screenshot shows the web interface for the Ping test. At the top, there is a navigation menu with tabs for Setup, Internet/LAN, Wireless Config, Security, LAN Config, NAS, Admin Config, and Diagnostic. Below this, there are sub-tabs for System Info, Logs, Packet Info, Client Monitor, and Ping. The Ping tab is active. On the left, there is a 'Destination Address' input field with the value '192.168.11.2' and an 'Execute' button. Below the input field, the 'Result' section shows the following output:

Destination	192.168.11.2
Result	64 bytes from 192.168.11.2: icmp_seq=0 ttl=128 time=0.4 ms 64 bytes from 192.168.11.2: icmp_seq=1 ttl=128 time=0.3 ms 64 bytes from 192.168.11.2: icmp_seq=2 ttl=128 time=0.3 ms

On the right, there is a help sidebar titled 'Ping' which contains the following text:

Ping

A Ping test can be performed from the AirStation. With a ping test, you can determine whether the AirStation can communicate with a specific network device.

Destination Address

Enter the network IP address that you want to ping; e.g. 192.168.11.3 or www.buffalotech.com.

Execute

At the bottom of the page, there is a copyright notice: (C)2000-2010 BUFFALO INC. All rights reserved.

Parameter	Meaning
Destination Address	Enter the IP address or hostname of the device that you are testing communication with, then click [Execute]. The result will be displayed below.

Chapter 5 - Connect to a Wireless Network

Automatic Secure Setup (AOSS/WPS)

AOSS and WPS are systems that let you automatically configure wireless LAN settings. Just pressing the buttons will connect wireless devices and complete security settings. Easily connect to wireless devices, computers, or game machines which support AOSS or WPS.



AOSS (AirStation One-Touch Secure System) was developed by Buffalo Technology. WPS was created by the Wi-Fi Alliance.

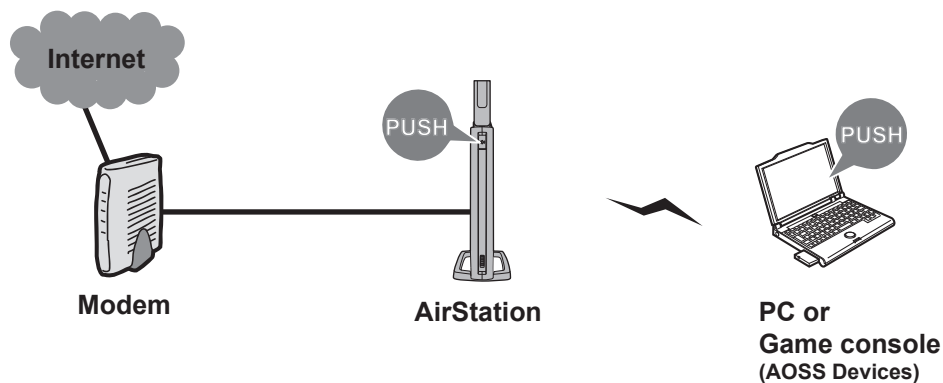

- Before using AOSS/WPS to connect to a Buffalo wireless client, install Client Manager software from the included AirNavigator CD. Consult your wireless client's documentation for more information.
- Buffalo's Client Manager software can be used with the wireless LAN devices built into most computers. However, it is not guaranteed to work with all wireless LAN devices available. Some wireless clients may require manual setup.

Windows 7/Vista (Client Manager V)

If you are using Windows 7 or Vista, use the included Client Manager V software to connect wirelessly with AOSS/WPS.

1 Click the  icon in the system tray.

2  Click [Create Profile].

3 If the User Account Control screen opens, click [Yes] or [Continue].

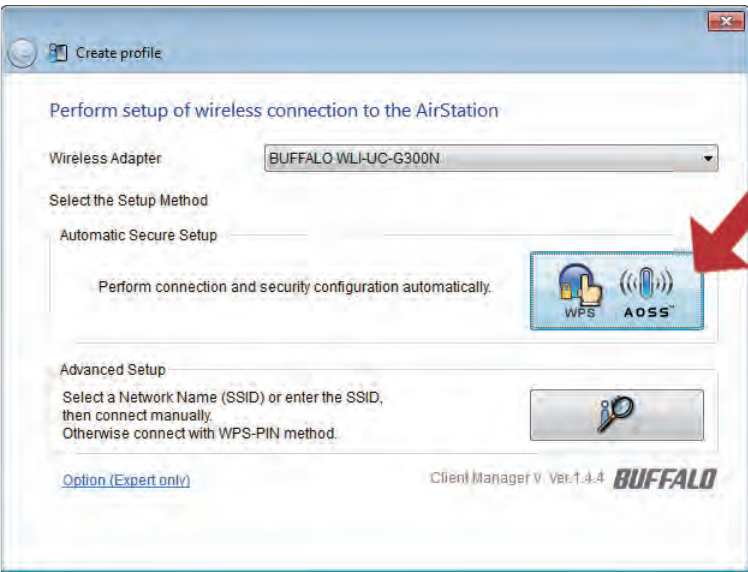
4  Click the [WPS AOSS] button.

Follow any instructions displayed on the screen. When the Security LED on the front of the AirStation stop flashing and glows steadily, the connection is complete.

Windows XP (Client Manager 3)

If you are using Windows XP, use Client Manager 3 to connect wirelessly with AOSS/WPS.

1 Right click on the  icon in the system tray and select [Profile].

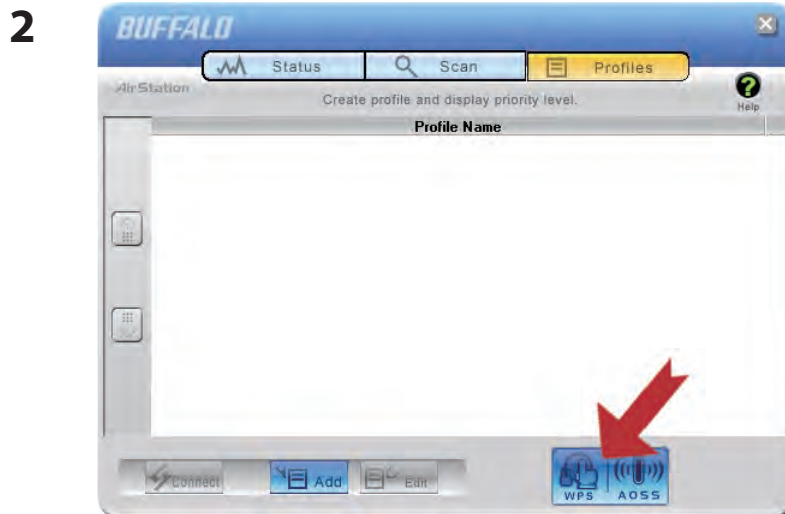

Click the [WPS AOSS] button.

It will take several seconds for your wireless connection to be configured. When the Security LED on the front of the AirStation stop flashing and glows steadily, the connection is complete.

Mac OS X (AOSS Assistant)

If you are using Mac OS X 10.6 / 10.5 / 10.4, use the included AOSS Assistant software to connect wirelessly with AOSS.

- 1 Load the AirNavigator CD in your Macintosh.
- 2 Double-click the Mac folder in the AirNavigator CD.
- 3 Double-click [AOSS Assistant].
- 4 The software license screen is displayed. Click [Agree] to proceed.

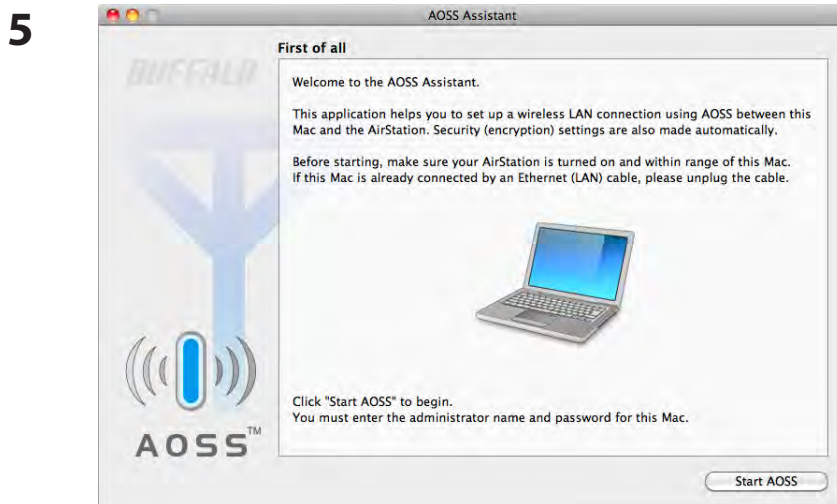

Click [Start AOSS].



Enter the Mac's username and password and click [OK].

It will take several seconds for your wireless connection to be configured. When the Security LED on the front of the AirStation stop flashing and glows steadily, the connection is complete.

Other Devices (e.g. Game Console)

If you are using a game machine which supports AOSS or WPS, refer to that device's manual to initiate AOSS/WPS. When instructed, hold down the AOSS button on the AirStation for 1 second.

When the Security LED on the front of the AirStation stop flashing and glows steadily, the connection is complete.

Manual Setup

You can also connect to the AirStation without installing Client Manager V or Client Manager 3 by using the utility built-in to Windows. The procedure varies depending on which version of Windows you are using.

- Note:**
- If the AirNavigator CD is used to perform setup when making the initial settings of AirStation, the wireless connection settings for the AirStation are completed during the Setup process. As a result, you do not need to make the settings below. After setup is complete, once the LAN cable is removed, you can connect from your wireless client to the AirStation.
 - Before performing setup, make the settings to enable the wireless client of the computer.

Windows 7 (WLAN AutoConfig)

With Windows 7, use WLAN AutoConfig to connect to the AirStation.

1 Click on the network  icon in the system tray.



Select the target AirStation and click [Connect]. If you will be connecting to this device in the future, checking [Connect automatically] is recommended.

3



Enter the encryption key and click [OK].

Windows Vista (WLAN AutoConfig)

With Vista, use WLAN AutoConfig to connect to the AirStation.

1

Right click on the wireless network  icon in the system tray.

2

Click [Connect to a network].

3

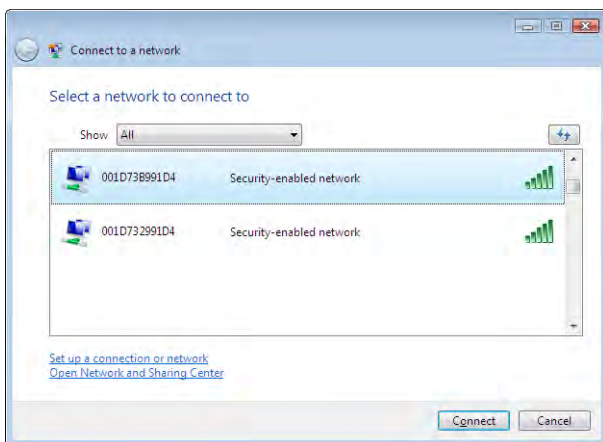

When this screen is displayed, select your network and click [Connect].

If the screen below is displayed, click [I want to enter the network key or passphrase instead]. Otherwise, go to step 4.

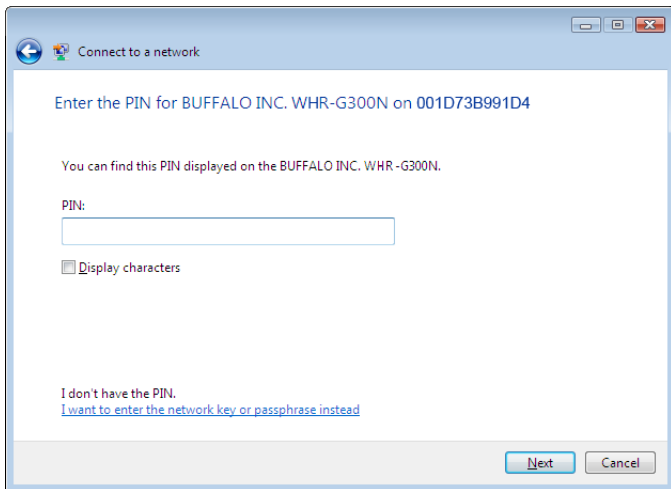
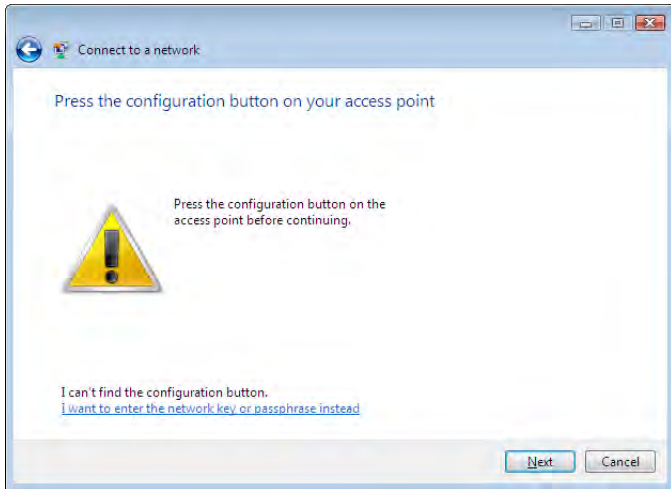

4

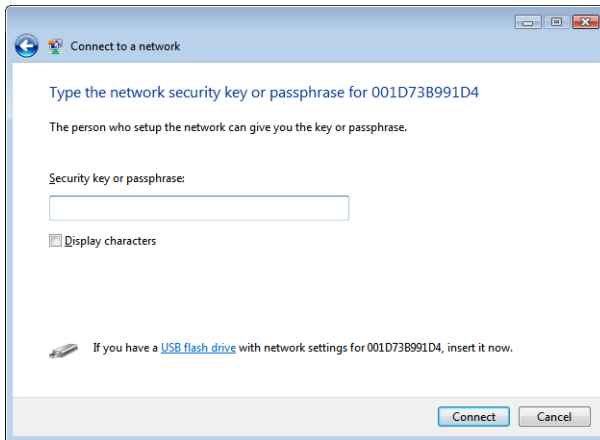

Enter the encryption key and click [Connect].

Step through the wizard to finish configuration.

If the Set Network Location screen is displayed, select [Home], [Work], or [Public location] depending on where you're using the AirStation.

Windows XP (Wireless Zero Configuration)

Windows XP includes Wireless Zero Config, a built-in utility to connect to your AirStation.

Note: If Client Manager 3 is installed on your computer, Wireless Zero Config is disabled. Uninstall Client Manager 3 to use Wireless Zero Config, or just use Client Manager 3 to connect to the AirStation.

- 1 Right click on the  wireless network icon in the system tray.
- 2 Click [View Available Wireless Networks].

- 3  Select the network to connect to and click [Connect].

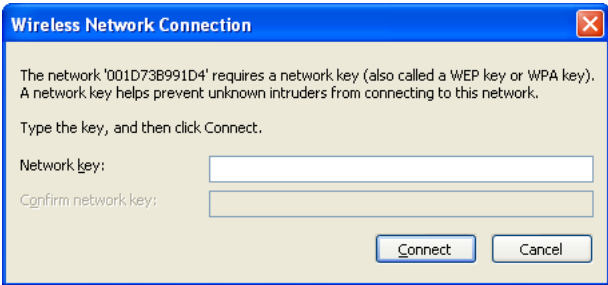
- 4  Enter the encryption key (twice) and click [Connect].

It will take several seconds for configuration to complete.

Mac OS X (AirPort)

Use AirPort on a Mac to connect to the AirStation.

1

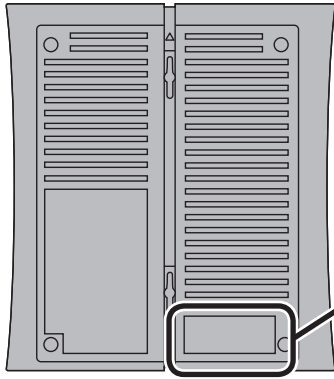

Refer to the label on the side of the AirStation. Make a note of the SSID and KEY printed on the label.

2

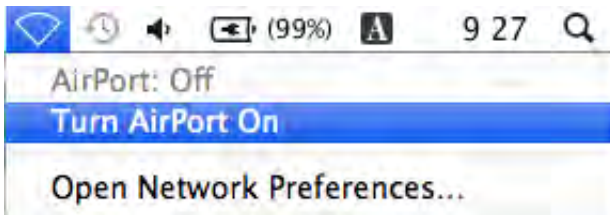

Click the  icon in the top section of the screen and select [Turn AirPort On].

3

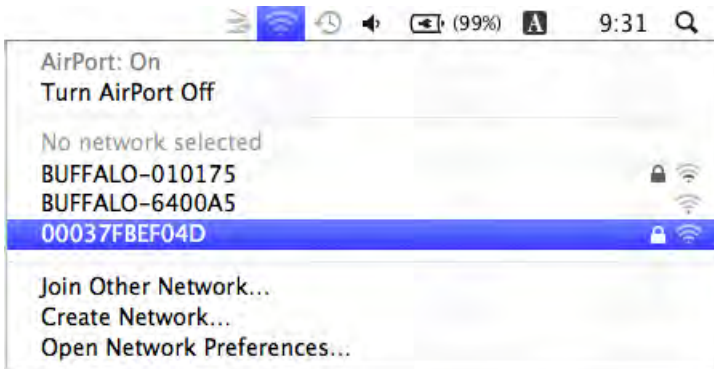

Find the SSID from step 1 on the list. Click it to highlight it.

4

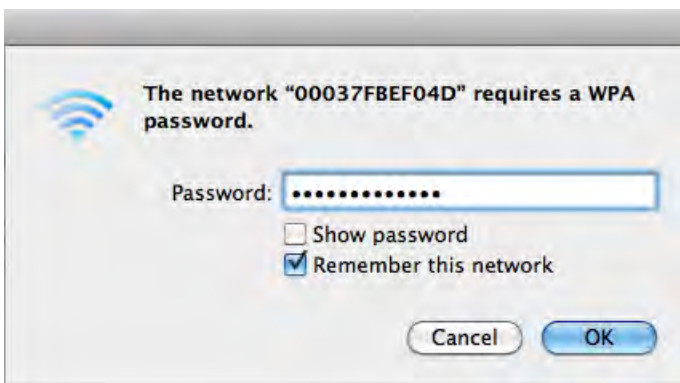

Enter the KEY from step 1 into the Password entry box, check [Remember this network], and click [OK].

It will take several seconds for configuration to complete.

Chapter 6 - Troubleshooting

Cannot connect to the Internet over wired connection.

- Make sure that your AirStation is plugged in!
- Check that the status LEDs of your AirStation are lit as below:

Power	Green light is on
Router	Green light is on or off (depending on your environment)
Diag	off
LAN	Green light is on or flashing
Internet	Green light is on or flashing
- Make sure that your computer is configured to “obtain an IP address automatically from DHCP”. (See chapter 10)
- Restart your AirStation.

Cannot access the web-based configuration Interface.

- See chapter 4 for instructions to open the AirStation’s configuration interface.
- Enter the correct username and password to log in to the configuration interface. The factory defaults are “root” (in lower case) for the username and a blank password (enter nothing). If you changed the password, enter the new password that you set.
- Verify that your web browser is not set to use proxies.
- Make sure that your computer is configured to “obtain an IP address automatically from DHCP”. (See chapter 10)
- Restart your AirStation.

Cannot connect to the network wirelessly.

- Configure your wireless client with the same SSID, encryption type, and encryption key as set on the AirStation.

The factory defaults are:

SSID -	The AirStation's MAC address (printed on the label)
Encryption Type -	WPA/WPA2 mixed mode - PSK (Connect with either WPA-PSK TKIP or WPA2-PSK AES).
Encryption Key -	Printed on the label of the AirStation.

Note: Encryption is disabled by default in Asia Pacific.

- Place your AirStation and wireless devices 2 - 10 feet apart.
- Restart your AirStation.

You forgot AirStation's SSID, Encryption Key, or Password.

Hold down the reset button on the base of your AirStation for 3 seconds to initialize its settings. All settings, including your password, SSID, and encryption key will be initialized to their defaults. The factory defaults are:

SSID -	The AirStation's MAC address (printed on the label)
Encryption Type -	WPA/WPA2 mixed mode - PSK (Connect with either WPA-PSK TKIP or WPA2-PSK AES).
Encryption Key -	Printed on the label of the AirStation. (Encryption is disabled by default for Asia Pacific AirStations.)

The link speed is slower than 300 Mbps (Maximum link speed is only 130 Mbps).

By default, the AirStation's 300 Mbps mode is not enabled. You may enable it with the following procedure:

1. Open the configuration interface (chapter 4).
2. In Easy Setup, click [Wireless SSID & Channel (11n 300 Mbps Mode)].
3. Change the value in [300 Mbps Mode] - [Bandwidth] to 40 MHz and click [Apply].

If you still cannot connect at 300 Mbps, check the settings of your wireless client devices.

Other Tips

Issue:

I reset my wireless router to factory settings and forgot how to log in to the configuration interface.

Answer:

Open your browser, enter 192.168.11.1 as the browser address, and hit Enter. You will be prompted to log in. Enter "root" for the username and leave the password box empty (no password). Click [OK] to complete the login and the option to reset your password will be available on the first page.

Issue:

How do I forward ports on my wireless router for my gaming console?

Answer:

Log in to the router's configuration interface. From the home page, go to the Internet Game/ Port Mapping section. Enter the port that needs to be forwarded and the IP address of the gaming console.

Issue:

How do I enable or modify security encryption settings on the wireless router?

Answer:

Log in to the configuration interface with your browser. Go to [Wireless Config] - [Security]. Buffalo recommends WPA for wireless encryption. The passphrase/key should be at least 8 characters in length.

Issue:

How do I change my wireless router's broadcasted network name (SSID)?

Answer:

Log in to the configuration interface. Go to the Wireless Config tab and then select the Basic tab if necessary. Find the settings area for SSID. Select the [Use] radio button and enter the name you wish to use for your network in the text field provided. Click [Apply] to save the settings. Once the wireless router has rebooted, select the new network name for all wireless devices and re-enter your encryption key if necessary.

Issue:

What can I do if my wireless connection drops randomly or seems slow?

Answer:

There are many environmental factors that may cause this. First, ensure the issue is not range related by moving the wireless router and the client device closer together. If the connection drops continue, then range is probably not the issue.

Other 2.4 GHz devices such as microwaves, other wireless networks, and 2.4 GHz wireless phones may impact performance. Try a different wireless channel for your wireless router. Log in to the wireless router with your browser. Click on the Wireless Config tab and then the Basic tab. Wireless channels from 1 - 13 may be selected. Try the Auto-Channel option if available. Otherwise, manually select an alternate channel and click [Apply].

Issue:

Though I am able to successfully make a connection with my wireless router, I am unable to access the Internet with my web browser.

Answer:

First, power off the cable or DSL modem, the wireless router, and your computer. Move the router's mode switch to the *on* position. Verify that the modem is connected to the wireless router with an Ethernet cable to the WAN port. Power on the modem and wait one minute. Power on the wireless router and wait another minute. Power on the computer. Open a browser on the computer and navigate to a familiar website to verify whether the Internet connection is functioning normally. If after these steps, an Internet connection is still unavailable, power off the cable or DSL modem and computer again and directly connect your computer to the cable or DSL modem with a cable between the computer and the port on the modem. Power on the modem and wait one minute. Power on the computer and again check for an Internet connection.

If an Internet connection IS NOT available with a direct connection to the computer, please call the Internet Service Provider who installed the modem.

If an Internet connection IS available with a direct connection to the computer, please call our customer support.

Issue:

Where can I download the latest drivers, firmware, and instructions for my Buffalo wireless products?

Answer:

The latest drivers and firmware are available online at **www.buffalotech.com**

Chapter 7 - Default Configuration Settings

Feature	Parameter	Default Setting
Internet (Router Mode only)	Method of Acquiring IP Address	Perform Easy Setup (Internet Connection Wizard)
	Default Gateway	none
	Address of DNS Name Server	none
	Internet MAC Address	Use Default MAC Address
	MTU Size of Internet Port	1500 Bytes
PPPoE (Router Mode only)	Default PPPoE Connection	No Active Session
	IP Unnumbered PPPoE Connection	No Active Session
	PPPoE Connection List	none
	Preferred Connections	none
DDNS (Router Mode only)	Dynamic DNS Service	Disabled
	Current Dynamic DNS Information	none
VPN Server (Router Mode only)	LAN Side IP Address	192.168.11.1 (255.255.255.0)
	DHCP Server Function	Enabled
	DHCP IP Address Pool	192.168.11.2 for up to 64 Address(es)
	PPTP Server Function	Disabled
	Authorization Type	MS-CHAPv2 (40/128-bit Encryption)
	Server IP Address	Auto
	Client IP Address	Auto
	DNS Server IP Address	LAN IP address of the AirStation
	WINS Server IP Address	none
	MTU/MRU value	1396
	PPTP User List	none

Feature	Parameter	Default Setting
LAN	LAN Side IP Address	Router Mode (Router Switch AUTO/ON): 192.168.11.1 (255.255.255.0) Bridge Mode (Router Switch OFF): 192.168.11.100 (255.255.255.0) Bridge Mode (Router Switch AUTO): Obtain automatically from DHCP Server
	DHCP Server Function (Router Mode only)	Enabled
	DHCP IP Address Pool (Router Mode only)	192.168.11.2 for up to 64 Addresses
	LAN Side IP Address (For IP Unnumbered) (Router Mode only)	none
	Lease Period (Router Mode only)	48 Hours
	Default Gateway (Router Mode only)	AirStation's IP Address
	DNS Servers (Router Mode only)	AirStation's IP Address
	WINS Server (Router Mode only)	Do Not Specify
	Domain Name (Router Mode only)	Assigned Domain Name
	Default Gateway (Bridge Mode only)	none
	DNS Server Address (Bridge Mode only)	none
	DHCP Lease (Router Mode only)	Current DHCP Client Information
NAT (Router Mode only)	Address Translation	Enabled
	Log Output of Deleted Packets	Disabled
Route	Routing Information	none

Feature	Parameter	Default Setting
WPS	WPS	Enabled
	External Registrar	Enabled
	AirStation PIN	An 8-digit random value (Printed on the label of the AirStation)
	WPS Security Information	WPS status: configured SSID: AirStation's MAC Address Security: WPA/WPA2 mixedmode - PSK TKIP/AES mixedmode or none Encryption key: Either a 13-digit random value or disabled. Printed on the label of the AirStation. Encryption is disabled by default settings on AirStation for Asia Pacific.
AOSS	Encryption Type of Exclusive SSID for WEP	none
	Encryption level expansion function	Enabled
	Dedicated WEP SSID isolation	Disabled
	Dedicated WEP for game consoles	Disabled
	AOSS Button on the AirStation Unit	Enabled
Basic	Wireless Radio	Enabled
	Wireless Channel	Auto Channel
	300 Mbps Mode	Band Width: 20 MHz Extension Channel: -
	Broadcast SSID	Allow
	Separate feature	not used
	SSID	Use AirStation's MAC address
	Wireless authentication	WPA/WPA2 mixedmode - PSK, or no authentication
	Wireless encryption	TKIP/AES mixedmode, or no encryption
	WPA-PSK (Pre-Shared Key)	A 13-digit random value or disabled (Printed on the label of the AirStation. Encryption is disabled in default settings on AirStation for Asia Pacific.)
Rekey interval	60 minutes	
Advanced	Multicast Rate	Auto
	DTIM Period	1
	Privacy Separator	Disabled

Feature	Parameter	Default Setting		
WMM	WMM-EDCA Parameters (Priority AC_BK (Low))		For AP	For STA
		CWmin	15	15
		CWmax	1023	1023
		AIFSN	7	7
		TXOP Limit	0	0
		Admission Control	-----	Disabled
	WMM-EDCA Parameters (Priority AC_BE (Normal))		For AP	For STA
		CWmin	15	15
		CWmax	63	1023
		AIFSN	3	3
		TXOP Limit	0	0
		Admission Control	-----	Disabled
	WMM-EDCA Parameters (Priority AC_VI (High))		For AP	For STA
		CWmin	7	7
		CWmax	15	15
		AIFSN	1	2
		TXOP Limit	94	94
		Admission Control	-----	Disabled
	WMM-EDCA Parameters (Priority AC_VO (Highest))		For AP	For STA
		CWmin	3	3
CWmax		7	7	
AIFSN		1	2	
TXOP Limit		47	47	
Admission Control		-----	Disabled	
MAC Filter	Enforce MAC Filtering	Disabled		
	Registration List	none		
Multicast Control	Snooping	Enabled		
	Multicast Aging Time	300 Sec.		
WDS	WDS	Use		
	Specify Master/Slave	Master		
Firewall (Router Mode only)	Log Output	Disabled		
	Basic Rules	Prohibit NBT and Microsoft-DS Routing	Disabled	
		Reject IDENT Requests	Enabled	
		Block Ping from Internet	Enabled	

Feature	Parameter	Default Setting
IP Filter (Router Mode only)	Log Output	Disabled
	IP Filter Information	none
VPN Pass Through (Router Mode only)	IPv6 Pass Through	Disabled
	PPPoE Pass Through	Disabled
	PPTP Pass Through	Enabled
Port Forwarding (Router Mode only)	Port Forwarding Registration Information	none
DMZ (Router Mode only)	IP Address of DMZ	none
UPnP (Router Mode only)	UPnP	Enabled
QoS (Router Mode only)	QoS for transmission to the Internet	Disabled
Movie Engine	Movie Engine switch status	off
	IPv6 Pass Through	Used
	Multicast Rate	11 Mbps
	Multicast Control	Snooping Function Use Aging Time Seconds 300 Seconds Change Priority VI (priority)
	TCP Rwin Size Limit	Size Limit No limit Maximum Rwin Size 65536 bytes
	Wireless Priority Control Rules	None
	Transmission Rate Limit	No Limits
Disk Management	Automatic USB Disk Assignment	Used
	FAT format file name character code	North America (CP437)
	HDD power-saving function	Not used HDD stop time 10 Minutes
Shared Folder	Access Limits	No Limits (Read/Write)
	Web Access	Access Limits
User Management	Current Users	guest

Feature	Parameter	Default Setting
Shared Service	Shared Folder	Enabled
	AirStation Name	AP + AirStation's MAC Address
	AirStation Description	None
	Workgroup Name	WORKGROUP
	Windows Client Language	North America (CP437)
	Shared Service	None
Web Access	Web Access	Disabled
	Web Access Display Language	English
	HTTPS/SSL Encryption	Disabled
	Web Access External Port	Auto (Port Number:9000)
	DNS Service Host Name	Use BuffaloNAS.com registration function
	Web Access status	None
Media Server	Media Server	Disabled
	Status	None
BitTorrent	BitTorrent Function	Disabled
	External Port Number	Auto (Port Number: 9002)
	Bandwidth Restriction	Enabled Maximum Download Speed 1000 KB/s Maximum Upload Speed 200 KB/s
	BitTorrent Status	None
Name	AirStation Name	AP + AirStation's MAC Address
	List Network Services	Enabled
Password	Administrator Name	root (fixed)
	Administrator Password	none
Time/Date	Local Date	2011 Year 1 Month 1 Day
	Local Time	0 Hour 0 Minute 0 Seconds
	Time Zone	(GMT+00:00) Greenwich Mean Time,London
	DST (Daylight Saving Time)	EU type 1 For GMT+00:00(From Last Sunday in Mar to last Sunday in Oct)
NTP	NTP Functionality	Enabled
	NTP Server	time.nist.gov
	Update Interval	24 hours

Feature	Parameter	Default Setting
ECO	Schedule feature	Disabled
	Register schedule	Operational Mode: Normal Start time: 0:00 End time: 0:30 The day of week: none
	User Define Mode	LED: Off Wired LAN: ECO (Slow operation) Wireless LAN: Off
Network-USB	Network-USB	Enabled
	Use multifunction Printer	Enabled
Access	Log Output	Disable
	Limitation Item	Prohibit configuration from wireless LAN Disabled Prohibit configuration from wired LAN Disabled Permit configuration from wired Internet Disabled
Log	Log Transfer	Disabled
	Syslog Server	none
	Transfer Logs	Router Mode: Address Translation, IP Filter, Firewall, PPP Client, Dynamic DNS, DHCP Client, DHCP Server, AOSS, Wireless Client, Authentication, Setting Changes, System Boot, NTP Client, and Wired Link Bridge Mode: IP Filter, DHCP Client, AOSS, Wireless Client, Authentication, Setting Changes, System Boot, NTP Client, and Wired Link

Chapter 8 - Network-USB Navigator

Network-USB Navigator is compatible only with printers and multifunction printers (all-in-one devices with a printer, scanner, and memory card reader). It cannot be used with any other type of USB devices.

Initial Setup for Windows Users

- 1 Insert the AirNavigator CD into your computer.

The setup wizard will launch automatically. If not, open the CD and click on "ASSetWiz.exe" in the "win" folder.

- 2

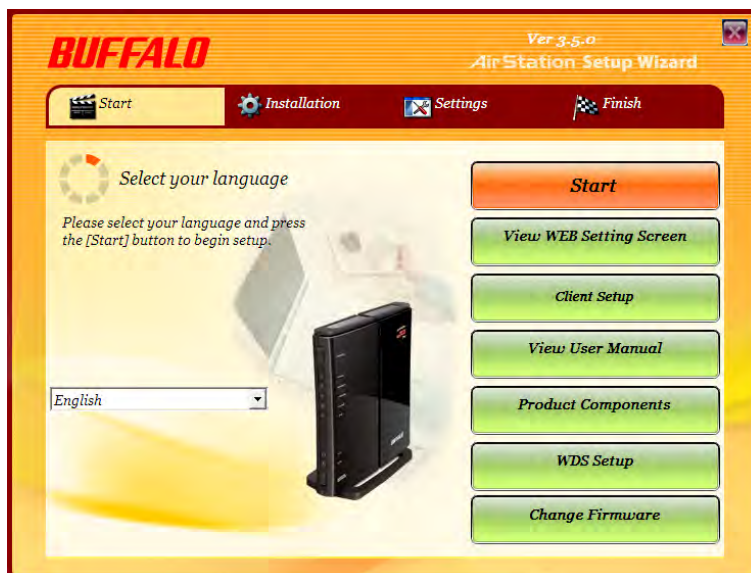

Click [Client setup].

3

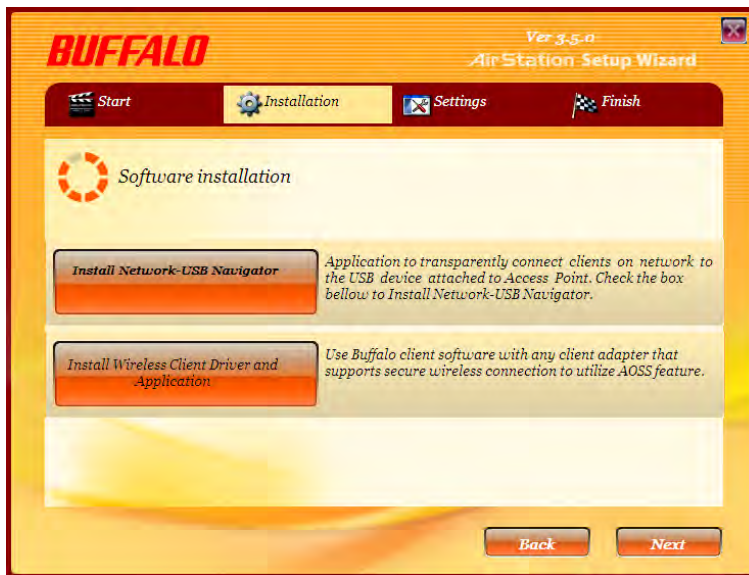

Click [Install Network-USB Navigator].

4



Click [Next].

5

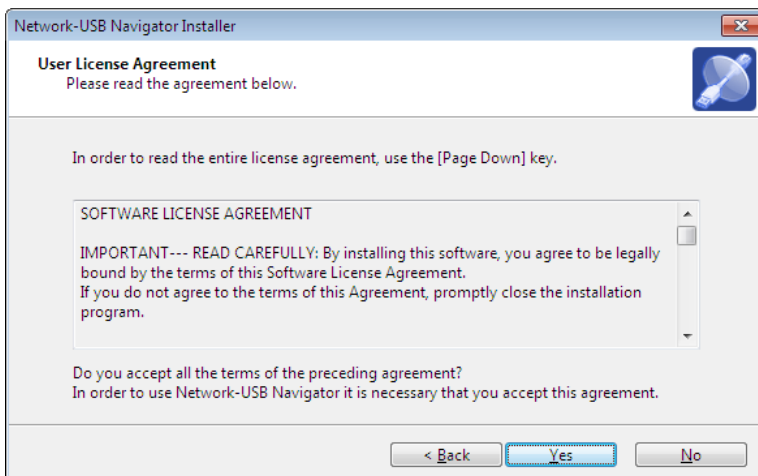

Click [Yes].

6

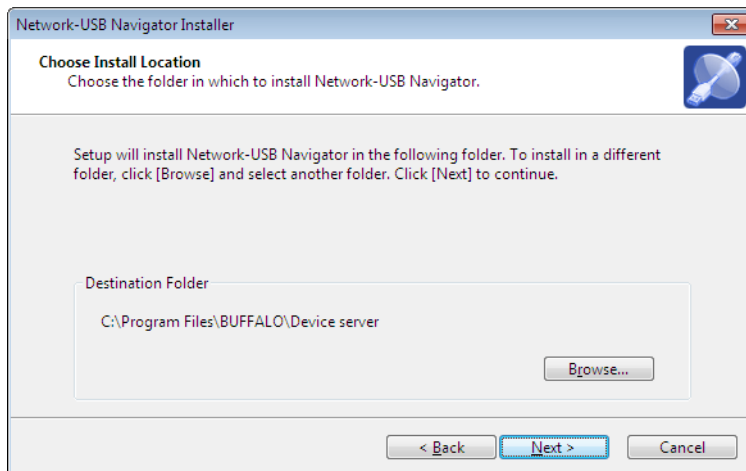

Click [Next].

7

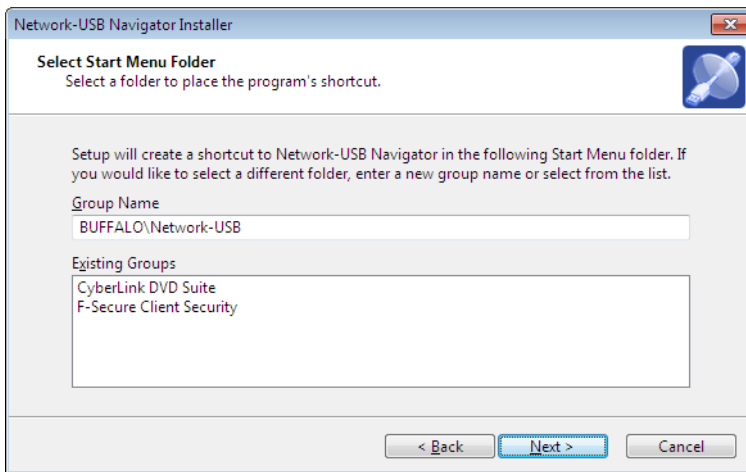

Click [Next].

8

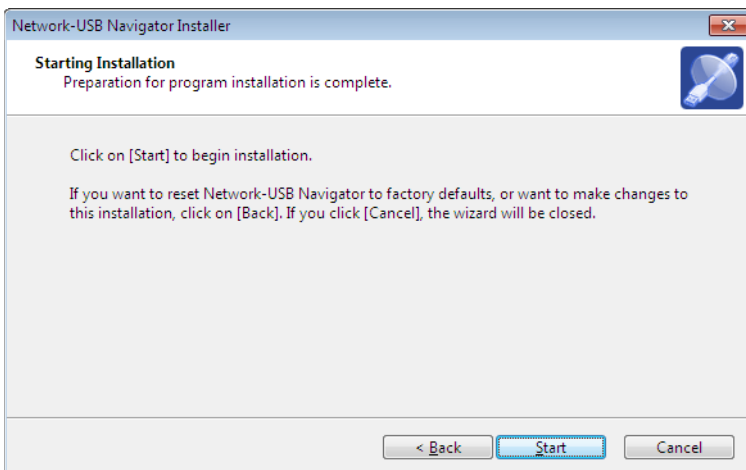

Click [Start].

- Installation on Windows XP (SP2 or later)

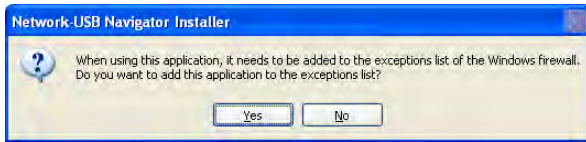

Click [Yes] when this screen is shown.

- Installation on Windows 7/Vista

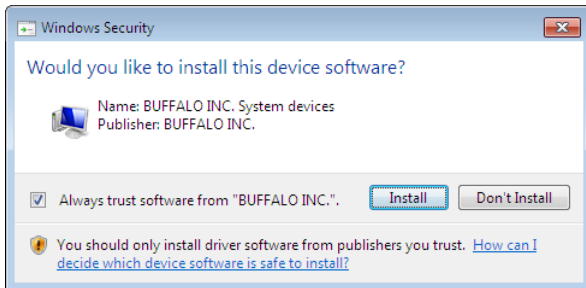

Click [Install] when this screen is shown.

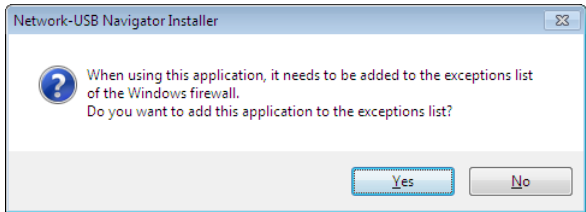

Click [Yes] when this screen is shown.

9

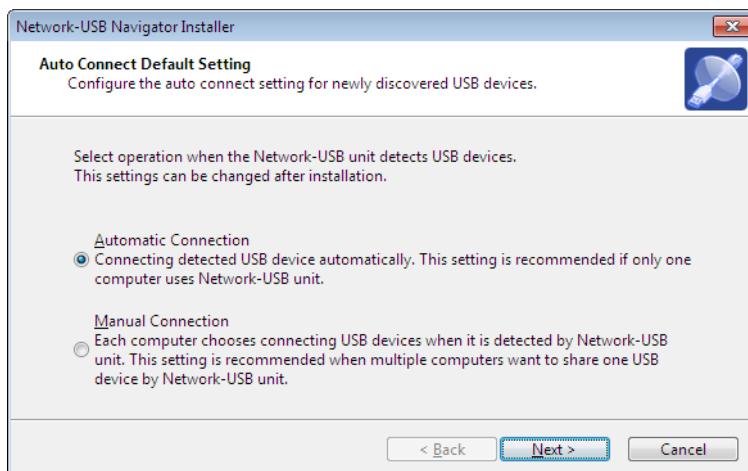

1 You can select the behavior of this product when a USB device is detected. Select the connection behavior suited to your usage environment.

2 Click [Next].

10 Click [Finish] when the "Network-USB Navigator Install is Complete" screen is shown.

Network-USB Navigator installation is complete.

Initial Setup for Mac Users

- 1 Insert the Air Navigator CD.
- 2 Double-click the CD-ROM on the desktop, then double-click the Mac folder.
- 3 Double-Click [USB-Navigator], then [Cosetup.app].



Click [Continue].



Click [Continue].

6



Click [Agree].

7



Click [Continue].

8

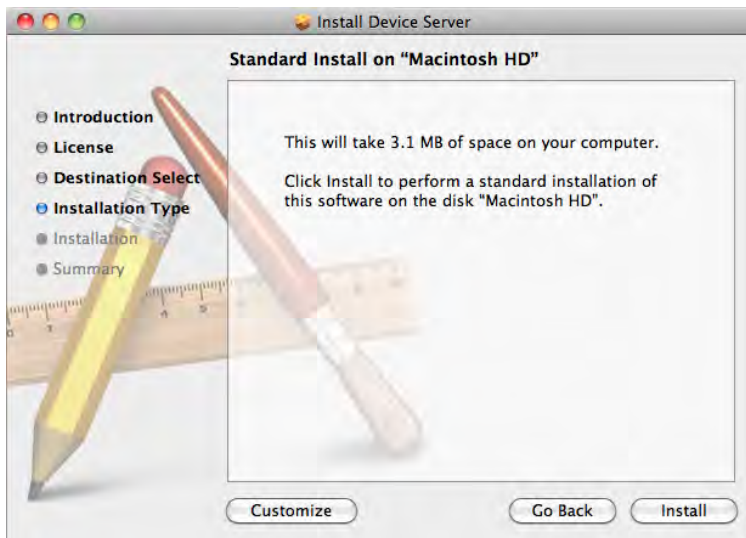

Click [Install].

9



Input your name and password.

Click [OK].

10

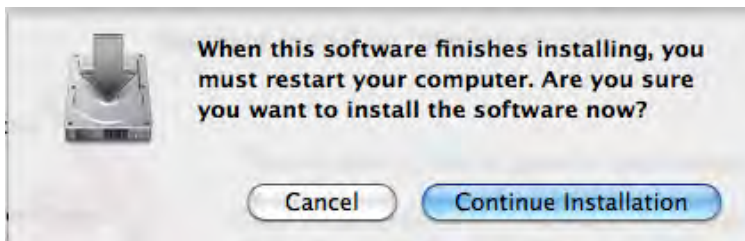

Click [Continue Installation].

11

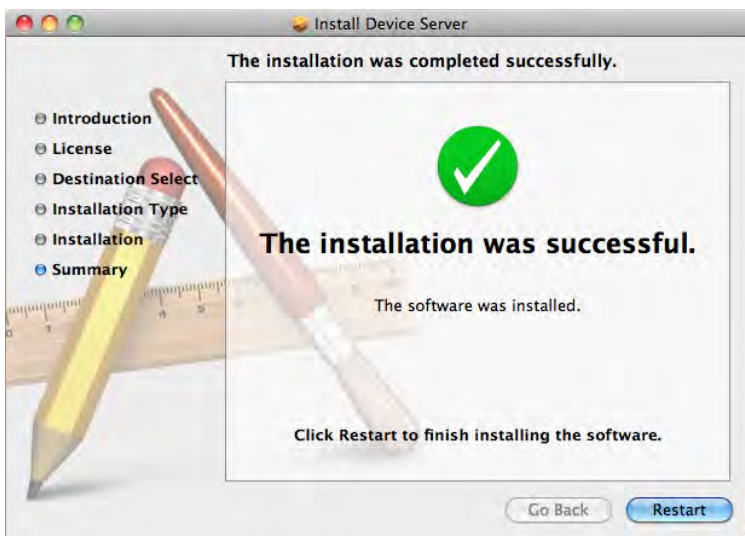

Click [Restart].

12

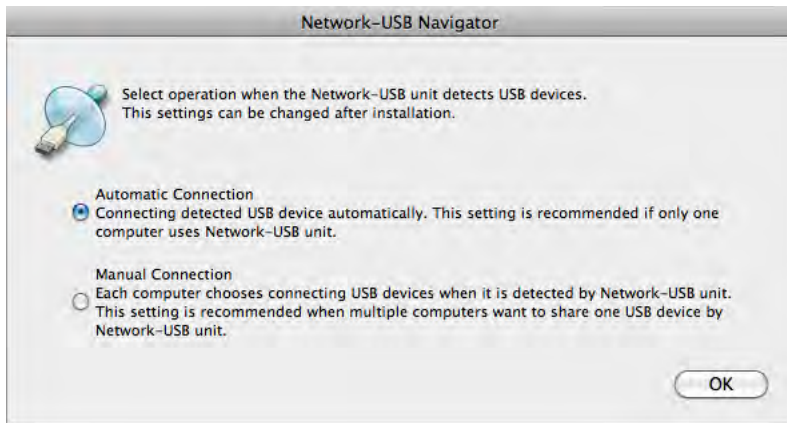

- 1 During the first program launch only, the screen at left will appear before the main program screen is displayed. From here, you can select the behavior of this product when a USB device is detected. Select the connection behavior suited to your usage environment.
- 2 Click [OK].

Network-USB Navigator installation is complete.

Opening the Network-USB User Manual

- 1 Launch Network-USB Navigator.

There are two ways to launch the program.

Windows Users

- a) Click the task tray icon .
- b) From the Start menu, click [(All) Programs]-[BUFFALO]-[Network-USB Navigator]-[Network-USB Navigator].

Macintosh Users

- a) Click the Dock icon .
- b) Click [Macintosh HD]-[Applications]-[BUFFALO]-[Device Server]-[Network-USB Navigator].

2



Click  , then click [Manual Page].

3

Network-USB User Manual will open.

How to use Network-USB

To configure Network-USB, refer to the “Network-USB User Manual”.

Chapter 9 - Checking Wireless Signal Quality

For users of Windows 7, Vista, or Mac OS X (10.4 and later), software supplied with the AirStation can be used to check the quality and strength of the wireless signal.

Windows 7/Vista

- Note:
- If Client Manager V is not already installed, install it from the AirNavigator CD. Click [Install Wireless Client Driver and Application] > [Options] > [Advanced Installation], and install Client Manager V.
 - Client Manager V does not support Windows XP.

1 Click the  icon in the system tray.

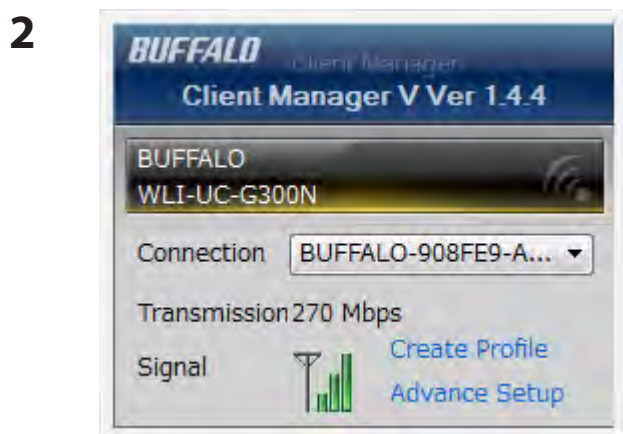

Click [Advanced Setup].

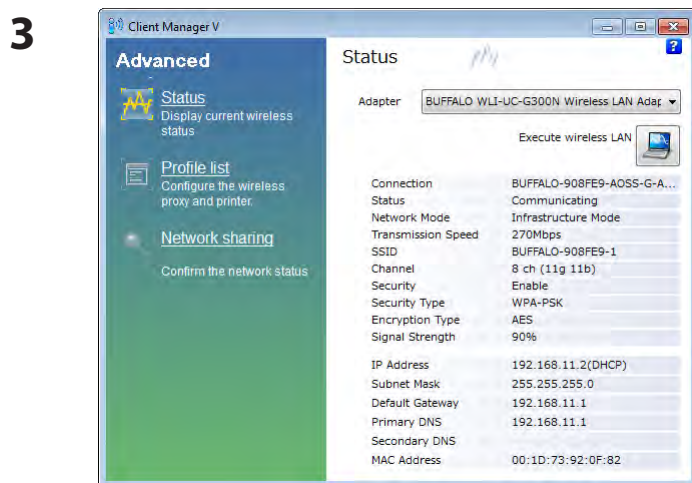

When the Client Manager V status screen is displayed, click .

4

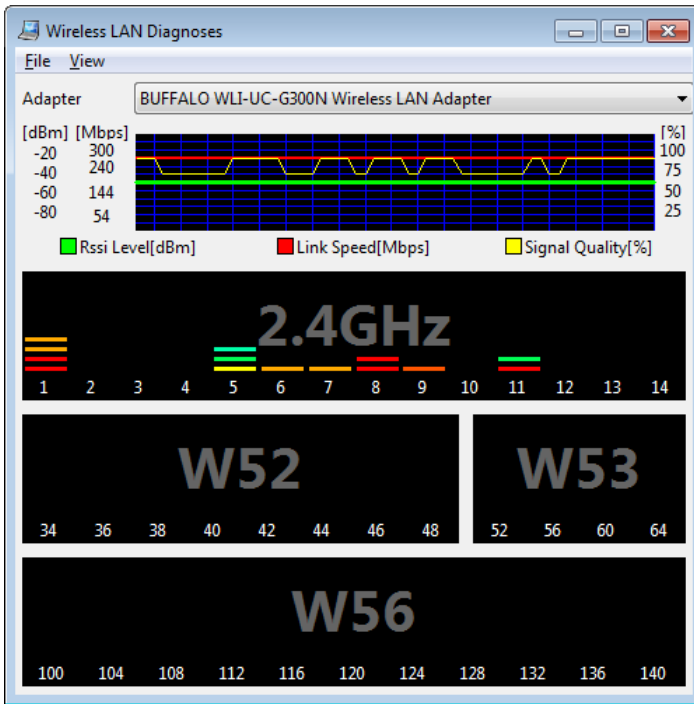

Parameter

Meaning

Connection status

Signal strength (dBm), link speed (Mbps), and signal quality (%) are displayed in one-minute intervals on a real-time graph.

Usage status by channel

The 11b/11g display shows usage in the 2.4 GHz band channels 1 to 11.

Colors are used to indicate the signal strength of the access point. Colors closer to red indicate an access point with a stronger signal strength, and colors closer to blue indicate an access point with a weaker signal strength.

Macintosh

- 1 Load the AirNavigator CD into your Macintosh.
- 2 Double-click the Mac folder in the AirNavigator CD.
- 3 Double-click [WLAN Monitor].

4 The software license screen is displayed when starting for the first time only. Click [Agree] to proceed.

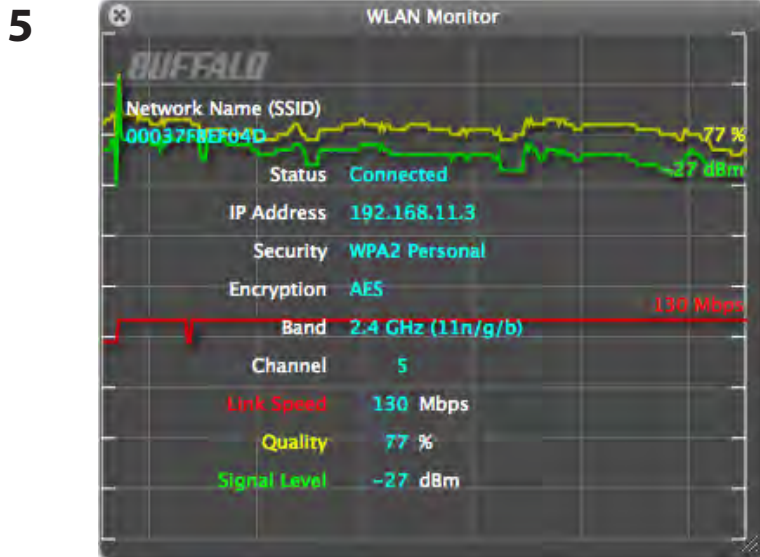

Parameter	Meaning
Network name (SSID)	This displays the SSID of the AirStation that is currently connected.
Status	This indicates the current connection status.
IP Address	This indicates the IP address of the current wireless network port (AirPort).
Security	This indicates the authentication method for the current connection target.
Encryption	This displays the encryption type for the current connection target.
Band	This displays the wireless band for the current connection target.
Channel	This displays the wireless channel for the current connection target.
Link Speed (Mbps)	This displays the current link speed.
Quality (%)	This displays the current signal quality.
Signal Level (dBm)	This indicates the strength of the current signal.

Chapter 10 - TCP/IP Settings

Windows 7

To configure TCP/IP in Windows 7, follow the procedure below.

- 1** Click [Start] > [Control Panel] > [Network and Internet].
- 2** Click [Network and Sharing Center].
- 3** Click [Change Adapter Settings] on the left side menu.
- 4** Right-click on [Local Area Connection], then click [Properties].
- 5** If the User Account Control screen opens, click [Yes] or [Continue].
- 6** Select [Internet Protocol Version 4 (TCP/IPv4)] then click [Properties].
- 7** To have DHCP set your IP address settings automatically, check [Obtain an IP address automatically] and [Obtain DNS server address automatically].

To set your IP address settings manually, enter values for each setting. Examples:

If the router's IP address is 192.168.11.1,

IP address	192.168.11.80
Subnet mask	255.255.255.0
Default gateway	192.168.11.1
Preferred DNS server	192.168.11.1
Alternate DNS server	blank

- 8** Click [OK].

Windows Vista

To configure TCP/IP in Windows Vista, follow the procedure below.

- 1** Click [Start] > [Settings] > [Control Panel].
- 2** Click [Network and Sharing Center].
- 3** Click [Manage network connections] on the left side menu.
- 4** Right-click on [Local Area Connection], then click [Properties].
- 5** If the User Account Control screen opens, click [Yes] or [Continue].
- 6** Select [Internet Protocol Version 4 (TCP/IPv4)], then click [Properties].
- 7** To have DHCP set your IP address settings automatically, check [Obtain an IP address automatically] and [Obtain DNS server address automatically].

To set your IP address settings manually, enter values for each settings. Example:

If the router's IP address is	192.168.11.1,
IP address	192.168.11.80
Subnet mask	255.255.255.0
Default gateway	192.168.11.1
Preferred DNS server	192.168.11.1
Alternate DNS server	blank

- 8** Click [Close].

Windows XP

To configure TCP/IP in Windows XP, follow the procedure below.

- 1** Click [Start] > [Settings] > [Control Panel].
- 2** Double-click [Network].
- 3** Right click on [Local Area Connection], then click [Properties].
- 4** Select [Internet Protocol (TCP/IP)], then click [Properties].
- 5** To have DHCP set your IP address settings automatically, check [Obtain an IP address automatically] and [Obtain DNS server address automatically].

To set your IP address settings manually, enter values for each setting. Examples:

If the router's IP address is 192.168.11.1,	
IP address	192.168.11.80
Subnet mask	255.255.255.0
Default gateway	192.168.11.1
Preferred DNS server	192.168.11.1
Alternate DNS server	blank

- 6** Click [Close].

Mac OS X

To configure TCP/IP in Mac OS X, follow the procedure below.

- 1** Click [Apple menu] > [System Preferences...].
- 2** Click [Network].
- 3** Click [Ethernet].
- 4** To have DHCP set your IP address settings automatically, select [Using DHCP] in the Configure IPv4 field.

To set your IP address settings manually, select [Manually] in the Configure IPv4 field and enter values for each setting. Examples:

If the router's IP address is 192.168.11.1,	
IP Address	192.168.11.80
Subnet Mask	255.255.255.0
Router	192.168.11.1
DNS Server	192.168.11.1
Search Domains	blank

- 5** Click [Apply].

Chapter 11 - Restoring the Default Configuration

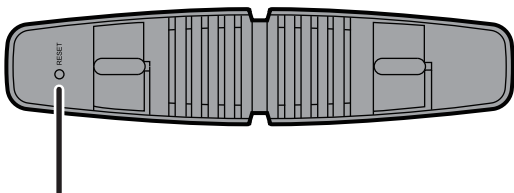

With the AirStation powered on, hold down this button for 3 seconds to return it to factory default settings.

Chapter 12 - Shared Folders and the USB Port

There are several restrictions on using the AirStation's USB port:

- When using two-byte characters (such as Japanese), keep folder and file names within 80 characters. You may not be able to copy a folder or a file whose name length is more than 80 characters.
- You cannot set attributes (hidden or read-only) for folders or files on the AirStation.
- When using access restrictions, you can register up to 16 users for the AirStation.
- Please note that you are not allowed to use any of the following words as a user or group name: adm, administrator, all, bin, daemon, disk, ftp, guest, halt, hdusers, kmen, lp, mail, man, news, nobody, nogroup, none, operator, root, shadow, shutdown, sshd, sync, sys, ttyusers, utmp, uucp, www.
- Please note that you are not allowed to use any of the following words as a shared folder name: global, homes, printers, bittorrent, disk1_pt1, disk1_pt2, disk1_pt3, disk1_pt4, disk2_pt1, disk2_pt2, disk2_pt3, disk2_pt4, disk3_pt1, disk3_pt2, disk3_pt3, disk3_pt4, disk4_pt1, disk4_pt2, disk4_pt3, disk4_pt4.
- If shared folder names, work group names, or file names contain any of the following characters, you may not access data or manipulate files on the AirStation properly. In such a case, use a different character.
- If a file created on a Macintosh contains any of the following characters, it will not be displayed correctly under Windows OS. Also, you cannot copy or properly display a file when connecting via SMB from Mac OS X if it contains any of these characters:
`? [] / \ = + < > ; : " , | *`
- Cancelling or aborting a file copy may leave the file incomplete, and you may no longer be able to delete the incomplete file. This can also happen during a power outage or if the LAN cable is suddenly disconnected. If it happens, restart the AirStation, delete the file, and try copying the file again.
- Use the same username and password for the AirStation as the user's Windows login. If they are different, the user may not be able to access shared folders with access restrictions on the AirStation.
- Date and time stamps stored on the USB hard drive may be updated by the OS accessing the AirStation. File creation or access dates may not be maintained.

- If you view the size of a hard drives on the browser, it shows a bigger value than when you see it in Windows' drive properties. This is because the browser shows the size of the drive in gigabytes but Windows shows it in gibibytes.
- If you have logged in using a "guest" account from Windows 7, Vista, XP or 2000, access restrictions may not work properly. A (different) guest account already exists on the AirStation.
- If you access a shared folder from a Macintosh computer, additional Mac OS X information files may be automatically generated. Do not delete these files from a Windows computer. Otherwise, you may no longer be able to access folders from a Macintosh.
- Device types that can be connected to the AirStation's USB connector are USB hard drives, USB memory sticks, or USB card readers. Card readers with 5 or more slots are not supported. USB devices such as a digital cameras, CD/DVD drives, USB hubs, mice, or keyboards are not supported.
- Encrypted USB hard drives are not supported.
- Only one single drive may be connected to the AirStation's USB port at a time. Drives manufactured by other companies besides Buffalo Technology are not supported.
- If your hard drive has an auto power mode switch, move the switch to [manual] or [on]. Leaving the switch set to [auto] may result in unpredictable behavior.
- Up to 4 partitions can be recognized on a USB hard drive.
- Available file systems for USB hard drives are FAT12, FAT16, FAT32, and XFS.

Appendix A - Specifications

Wireless LAN Interface	
Standard Compliance	IEEE802.11b / IEEE802.11g / IEEE802.11n
Transmission Method	Direct Sequence Spread Spectrum (DSSS), OFDM, MIMO
Frequency Range	2,412 - 2,462 MHz (Channels 1 - 11)
Transmission Rate	802.11b: 11, 5.5, 2, 1 Mbps 802.11g: 54, 48, 36, 24, 18, 12, 9, 6 Mbps 802.11n 20 MHz BW (Long GI) 130, 117, 104, 78, 52, 39, 26, 13 Mbps (2 stream) 65, 58.5, 52, 39, 26, 19.5, 13, 6.5 Mbps (1 stream) (Short GI) 130, 115.5, 86.6, 57.7, 43.3, 28.8, 14.4 Mbps (2 stream) 65, 72.2, 57.8, 43.3, 28.9, 21.7, 14.4, 6.5 Mbps (1 stream) 40 MHz BW (Long GI) 270, 243, 216, 162, 108, 81, 54, 27 Mbps (2 stream) 135, 121.5, 108, 61, 54, 40.5, 27, 13.5 Mbps (1 stream) (Short GI) 300, 270, 240, 180, 120, 90, 60, 30 Mbps (2 stream) 150, 135, 120, 90, 60, 45, 30, 15 Mbps (1 stream)
Access Mode	Infrastructure Mode
Security	AOSS, WPA2-PSK (TKIP/AES), WPA/WPA2 mixed PSK, WPA-PSK (TKIP/AES), 64-bit and 128-bit WEP, Mac Address Filter
Wired LAN Interface	
Standard Compliance	IEEE802.3ab (1000BASE-T), IEEE802.3u (100BASE-TX), IEEE802.3 (10BASE-T)
Transmission Rate	10 / 100 / 1000 Mbps
Transmission Encoding	1000BASE-T 4DPAM5, 100BASE-TX 4B5B/MLT-3, 10BASE-T Manchester Coding
Access Method	CSMA/CD
Speed and Flow Control	10 / 100 / 1000 Mbps, Auto Sensing, Auto MDIX
Number of LAN Ports	4
LAN Port Connector	RJ-45
USB Interface	
Interface	USB 2.0
Connector Type	Type A (plug)
Compliance	5.0 V 500 mA (max 1000 mA)

Other	
Power Supply	External AC 100-240 V Universal, 50/60 Hz
Power Consumption	About 14.0 W (Max)
Dimensions	165 mm x 158 mm x 30 mm (6.5 x 6.2 x 1.2 in.)
Weight	382 g (13.5 oz.) (not including the stand)
Operating Environment	0 - 40° C (32 - 104° F), 20 - 80% (non-condensing)

Appendix B - Regulatory Compliance Information

Federal Communication Commission Interference Statement

This equipment has been tested and found to comply with the limits for a Class B digital device, pursuant to Part 15 of the FCC Rules. These limits are designed to provide reasonable protection against harmful interference in a residential installation. This equipment generates, uses and can radiate radio frequency energy and, if not installed and used in accordance with the instructions, may cause harmful interference to radio communications. However, there is no guarantee that interference will not occur in a particular installation. If this equipment does cause harmful interference to radio or television reception, which can be determined by turning the equipment off and on, the user is encouraged to try to correct the interference by one of the following measures:

- Reorient or relocate the receiving antenna.
- Increase the separation between the equipment and receiver.
- Connect the equipment into an outlet on a circuit different from that to which the receiver is connected.
- Consult the dealer or an experienced radio/TV technician for help.

FCC Caution:

Any changes or modifications not expressly approved by the party responsible for compliance could void the user's authority to operate this equipment.

This device complies with Part 15 of the FCC Rules. Operation is subject to the following two conditions: (1) This device may not cause harmful interference, and (2) this device must accept any interference received, including interference that may cause undesired operation.

Important Note - FCC Radiation Exposure Statement:

This equipment complies with FCC radiation exposure limits set forth for an uncontrolled environment. This equipment should be installed and operated with minimum distance 20cm between the radiator & your body.

This transmitter must not be co-located or operating in conjunction with any other antenna or transmitter.

The availability of some specific channels and/or operational frequency bands are country dependent and are firmware programmed at the factory to match the intended destination. The firmware setting is not accessible by the end user.

Industry Canada statement: Industrie Canada déclaration:

This device complies with RSS-210 of the Industry Canada Rules. Operation is subject to the following two conditions:

- (1) This device may not cause harmful interference, and
- (2) this device must accept any interference received, including interference that may cause undesired operation.

Ce dispositif est conforme à la norme CNR-210 d'Industrie Canada applicable aux appareils radio exempts de licence. Son fonctionnement est sujet aux deux conditions suivantes:

- (1) le dispositif ne doit pas produire de brouillage préjudiciable, et
- (2) ce dispositif doit accepter tout brouillage reçu, y compris un brouillage susceptible de provoquer un fonctionnement indésirable.

Important Note - Radiation Exposure Statement: Note importante - Déclaration d'exposition aux radiations:

This equipment complies with Canada radiation exposure limits set forth for an uncontrolled environment. This equipment should be installed and operated with minimum distance 20cm between the radiator and your body.

Cet équipement est conforme aux limites d'exposition aux rayonnements IC établies pour un environnement non contrôlé. Cet équipement doit être installé et utilisé avec un minimum de 20 cm de distance entre la source de rayonnement et votre corps.

Europe – EU Declaration of Conformity

This device complies with the essential requirements of the R&TTE Directive 1999/5/EC. The following test methods have been applied in order to prove presumption of conformity with the essential requirements of the R&TTE Directive 1999/5/EC:

EN60950-1: 2006 +A11: 2009
Safety of Information Technology Equipment

EN50385 : (2002-08)
Product standard to demonstrate the compliance of radio base stations and fixed terminal stations for wireless telecommunication systems with the basic restrictions or the reference levels related to human exposure to radio frequency electromagnetic fields (110MHz - 40 GHz) - General public

EN 300 328 V1.7.1: (2006-10)
Electromagnetic compatibility and Radio spectrum Matters (ERM); Wideband Transmission systems; Data transmission equipment operating in the 2,4 GHz ISM band and using spread spectrum

modulation techniques; Harmonized EN covering essential requirements under article 3.2 of the R&TTE Directive

EN 301 489-1 V1.8.1: (2008-04)

Electromagnetic compatibility and Radio Spectrum Matters (ERM); ElectroMagnetic Compatibility (EMC) standard for radio equipment and services; Part 1: Common technical requirements

EN 301 489-17 V2.1.1 (2009-05)

Electromagnetic compatibility and Radio spectrum Matters (ERM); ElectroMagnetic Compatibility (EMC) standard for radio equipment; Part 17: Specific conditions for Broadband Data Transmission Systems

This device is a 2.4 GHz wideband transmission system (transceiver), intended for use in all EU member states and EFTA countries, except in France and Italy where restrictive use applies.

In Italy the end-user should apply for a license at the national spectrum authorities in order to obtain authorization to use the device for setting up outdoor radio links and/or for supplying public access to telecommunications and/or network services.

This device may not be used for setting up outdoor radio links in France and in some areas the RF output power may be limited to 10 mW EIRP in the frequency range of 2454 – 2483.5 MHz. For detailed information the end-user should contact the national spectrum authority in France.

CE 0560 

Česky [Czech]

Buffalo Technology Inc. tímto prohlašuje, že tento AirStation WZR-HP-G300NH/WZR-HP-G300NH2 je ve shodě se základními požadavky a dalšími příslušnými ustanoveními směrnice 1999/5/ES.

Dansk [Danish]

Undertegnede Buffalo Technology Inc. erklærer herved, at følgende udstyr AirStation WZR-HP-G300NH/WZR-HP-G300NH2 overholder de væsentlige krav og øvrige relevante krav i direktiv 1999/5/EF.

Deutsch [German]

Hiermit erklärt Buffalo Technology Inc. dass sich das Gerät AirStation WZR-HP-G300NH/WZR-HP-G300NH2 in Übereinstimmung mit den grundlegenden Anforderungen und den übrigen einschlägigen Bestimmungen der Richtlinie 1999/5/EG befindet.

Eesti [Estonian]

Käesolevaga kinnitab Buffalo Technology Inc. seadme AirStation WZR-HP-G300NH/WZR-HP-G300NH2 vastavust direktiivi 1999/5/EÜ põhinõuetele ja nimetatud direktiivist tulenevatele teistele asjakohastele sätetele.

English

Hereby, Buffalo Technology Inc. declares that this AirStation WZR-HP-G300NH/WZR-HP-G300NH2 is in compliance with the essential requirements and other relevant provisions of Directive 1999/5/EC.

Español [Spanish]

Por medio de la presente Buffalo Technology Inc. declara que el AirStation WZR-HP-G300NH/WZR-HP-G300NH2 cumple con los requisitos esenciales y cualesquiera otras disposiciones aplicables o exigibles de la Directiva 1999/5/CE.

Ελληνική [Greek]

ΜΕ ΤΗΝ ΠΑΡΟΥΣΑ Buffalo Technology Inc. ΔΗΛΩΝΕΙ ΟΤΙ AirStation WZR-HP-G300NH/WZR-HP-G300NH2 ΣΥΜΜΟΡΦΩΝΕΤΑΙ ΠΡΟΣ ΤΙΣ ΟΥΣΙΩΔΕΙΣ ΑΠΑΙΤΗΣΕΙΣ ΚΑΙ ΤΙΣ ΛΟΙΠΕΣ ΣΧΕΤΙΚΕΣ ΔΙΑΤΑΞΕΙΣ ΤΗΣ ΟΔΗΓΙΑΣ 1999/5/EK.

Français [French]

Par la présente Buffalo Technology Inc. déclare que l'appareil AirStation WZR-HP-G300NH/WZR-HP-G300NH2 est conforme aux exigences essentielles et aux autres dispositions pertinentes de la directive 1999/5/CE.

Italiano [Italian]

Con la presente Buffalo Technology Inc. dichiara che questo AirStation WZR-HP-G300NH/WZR-HP-G300NH2 è conforme ai requisiti essenziali ed alle altre disposizioni pertinenti stabilite dalla direttiva 1999/5/CE.

Latviski [Latvian]

Ar šo Buffalo Technology Inc. deklarē, ka AirStation WZR-HP-G300NH/WZR-HP-G300NH2 atbilst Direktīvas 1999/5/EK būtiskajām prasībām un citiem ar to saistītajiem noteikumiem.

Lietuvių [Lithuanian]

Šiuo Buffalo Technology Inc. deklaruoja, kad šis AirStation WZR-HP-G300NH/WZR-HP-G300NH2 atitinka esminius reikalavimus ir kitas 1999/5/EB Direktyvos nuostatas.

Nederlands [Dutch]

Hierbij verklaart Buffalo Technology Inc. dat het toestel AirStation WZR-HP-G300NH/WZR-HP-G300NH2 in overeenstemming is met de essentiële eisen en de andere relevante bepalingen van richtlijn 1999/5/EG.

Malti [Maltese]

Hawnhekk, Buffalo Technology Inc. , jiddikjara li dan AirStation WZR-HP-G300NH/WZR-HP-G300NH2 jikkonforma mal-ħtiġijiet essenzjali u ma provvedimenti oħrajn relevanti li hemm fid-Dirrettiva 1999/5/EC.

Magyar [Hungarian]

Alulírott, Buffalo Technology Inc. nyilatkozom, hogy a AirStation WZR-HP-G300NH/WZR-HP-G300NH2 megfelel a vonatkozó alapvető követelményeknek és az 1999/5/EC irányelv egyéb előírásainak.

Polski [Polish]

Ninieszym Buffalo Technology Inc. oświadcza, że AirStation WZR-HP-G300NH/WZR-HP-G300NH2 jest zgodny z zasadniczymi wymogami oraz pozostałymi stosownymi postanowieniami Dyrektywy 1999/5/EC.

Português [Portuguese]

Buffalo Technology Inc. declara que este AirStation WZR-HP-G300NH/WZR-HP-G300NH2 está conforme com os requisitos essenciais e outras disposições da Directiva 1999/5/CE.

Slovensko [Slovenian]

Buffalo Technology Inc. izjavlja, da je ta AirStation WZR-HP-G300NH/WZR-HP-G300NH2 v skladu z bistvenimi zahtevami in ostalimi relevantnimi določili direktive 1999/5/ES.

Slovensky [Slovak]

Buffalo Technology Inc. týmto vyhlasuje, že AirStation WZR-HP-G300NH/WZR-HP-G300NH2 spĺňa základné požiadavky a všetky príslušné ustanovenia Smernice 1999/5/ES.

Suomi [Finnish]

Buffalo Technology Inc. vakuuttaa täten että AirStation WZR-HP-G300NH/WZR-HP-G300NH2 tyyppinen laite on direktiivin 1999/5/EY oleellisten vaatimusten ja sitä koskevien direktiivin muiden ehtojen mukainen.

Svensk [Swedish]

Härmed intygar Buffalo Technology Inc. att denna AirStation WZR-HP-G300NH/WZR-HP-G300NH2 står i överensstämmelse med de väsentliga egenskapskrav och övriga relevanta bestämmelser som framgår av direktiv 1999/5/EG.

Safety

This equipment is designed with the utmost care for the safety of those who install and use it. However, special attention must be paid to the dangers of electric shock and static electricity when working with electrical equipment. All guidelines of this manual and of the computer manufacturer must therefore be allowed at all times to ensure the safe use of the equipment.

根據 NCC 低功率電波輻射性電機管制辦法：

第十二條：

經型式認證合格之低功率射頻電機，非經許可，公司、商號或使用者均不得擅自變更頻率、加大功率或變更原設計之特性及功能。

第十四條：

低功率射頻電機之使用不得影響飛航安全及干擾合法通信；經發現有干擾現象時，應立即停用，並改善至無干擾時方得繼續使用。前項合法通信，指依電信法規定作業之無線電通信。低功率射頻電機須忍受合法通信或工業、科學及醫療用電波輻射性電機設備之干擾。

기종별	사 용 자 안 내 문
B 급 기기 (가정용 정보통신기기)	이 기기는 가정용 (B 급) 전자파적합기기로서 주로 가정에서 사용하는 것을 목적으로 하며, 모든 지역에서 사용할 수 있습니다.

Appendix C - Environmental Information

- The equipment that you have purchased has required the extraction and use of natural resources for its production.
- The equipment may contain hazardous substances that could impact health and the environment.
- In order to avoid the dissemination of those substances in our environment and to diminish the pressure on the natural resources, we encourage you to use the appropriate take-back systems.
- The take-back systems will reuse or recycle most of the materials of your end life equipment in a sound way.
- The crossed-out wheeled bin symbol invites you to use those systems.



- If you need more information on collection, reuse, and recycling systems, please contact your local or regional waste administration.

Appendix D - GPL Information

The source code for Buffalo products that use GPL code is available at <http://opensource.buffalo.jp/>.

Appendix E - Warranty Information

Buffalo Technology (Buffalo Inc.) products come with a two-year limited warranty from the date of purchase. Buffalo Technology (Buffalo Inc.) warrants to the original purchaser of the product good operating condition for the warranty period. This warranty does not include non-Buffalo Technology (Buffalo Inc.) installed components. If the Buffalo product malfunctions during the warranty period, Buffalo Technology/(Buffalo Inc.) will, replace the unit, provided the unit has not been subjected to misuse, abuse, or non-Buffalo Technology/(Buffalo Inc.) authorized alteration, modifications or repair.

All expressed and implied warranties for the Buffalo Technology (Buffalo Inc) product line including, but not limited to, the warranties of merchantability and fitness of a particular purpose are limited in duration to the above period.

Under no circumstances shall Buffalo Technology/(Buffalo Inc.) be liable in any way to the user for damages, including any lost profits, lost savings or other incidental or consequential damages arising out of the use of, or inability to use the Buffalo products.

In no event shall Buffalo Technology/(Buffalo Inc.) liability exceed the price paid for the product from direct, indirect, special, incidental, or consequential damages resulting from the use of the product, its accompanying software, or its documentation. Buffalo Technology (Buffalo Inc.) does not offer refunds for any product.

@ 2003-2011 Buffalo Technology (Buffalo, Inc.)