



Touchstone TG3452 Telephony Gateway

User Guide

Release 34 DRAFT 1.6 June 2017

June 2017

ARRIS Copyrights and Trademarks

© 2017 ARRIS Enterprises LLC. All Rights Reserved.

No part of this publication may be reproduced in any form or by any means or used to make any derivative work (such as translation, transformation, or adaptation) without written permission from ARRIS Enterprises LLC. ("ARRIS"). ARRIS reserves the right to revise this publication and to make changes in content from time to time without obligation on the part of ARRIS to provide notification of such revision or change.

ARRIS and the ARRIS logo are all trademarks of ARRIS Enterprises LLC. Other trademarks and trade names may be used in this document to refer to either the entities claiming the marks or the names of their products. ARRIS disclaims proprietary interest in the marks and names of others.

ARRIS provides this guide without warranty of any kind, implied or expressed, including, but not limited to, the implied warranties of merchantability and fitness for a particular purpose. ARRIS may make improvements or changes in the product(s) described in this manual at any time.

The capabilities, system requirements and/or compatibility with third-party products described herein are subject to change without notice.

Patent Notice

Protected under one or more of the following U.S. patents: <http://www.arris.com/legal>
Other patents pending.

Table of Contents

1. Overview	5
Introduction	5
Getting Support	5
2. Safety Requirements	6
FCC Part 15	7
RF Exposure.....	8
Canadian Compliance	8
Radiation Exposure Statement	8
Innovation, Science and Economic Development Canada statement:	9
For Mexico	9
3. Getting Started	10
About Your New Telephony Gateway	10
What's in the Box.....	10
Items You Need	11
Getting Service.....	12
System Requirements.....	12
Recommended Hardware.....	13
Windows	13
Mac OS.....	13
Linux/Unix.....	13
About this Manual	14
What About Security?.....	14
Ethernet or Wireless?.....	15
4. Installing and Connecting your Telephony Gateway.....	17
Front Panel	18
Rear Panel.....	19
Selecting an Installation Location.....	20
Desktop Mounting Instructions	20
Factors Affecting Wireless Range	20
Connecting the Telephony Gateway	22
Configuring Your Wireless Connection.....	23
Accessing the Configuration Interface.....	24
Setting Parental Controls.....	25
Finding the MAC Address of a Computer	25
Making Your Parental Control Settings.....	26

5.	Configuring Your Ethernet Connection.....	28
	Requirements	28
	How to use this Chapter	28
	TCP/IP Configuration for Windows Vista.....	28
	TCP/IP Configuration for Windows 7, Windows 8, or Windows 10	29
	TCP/IP Configuration for macOS.....	29
6.	Using the Telephony Gateway	31
	Setting up Your Computer to Use the Telephony Gateway	31
	Indicator Lights for the TG3452.....	32
	Online LED.....	32
	Wi-Fi LED	33
	Voice LED	34
	Using the Reset Button.....	35
	Resetting the Router to Factory Defaults	36
7.	Troubleshooting.....	37
	The Telephony Gateway is plugged in, but the Power light is Off	37
	I'm not getting on the Internet (all connections)	37
	I'm not getting on the Internet (Ethernet)	37
	I'm not getting on the Internet (Wireless).....	38
	My wireless Internet connection stops working sometimes	38
	I can get on the Internet, but everything is slow	38
	I don't have a dial tone when I pick up the phone - why?	38
8.	Glossary.....	40

Overview

Introduction

Get ready to experience the Internet's express lane! Whether you're checking out streaming media, downloading new software, checking your email, or talking with friends on the phone, the Touchstone TG3452 Telephony Gateway brings it all to you faster and more reliably. All while providing toll quality Voice over IP telephone service and both wired and wireless connectivity. It also provides a Lithium-Ion battery backup to provide continued telephone service during power outages.

The Touchstone TG3452 Telephony Gateway provides four Ethernet connections for use as the hub of your home/office Local Area Network (LAN). The TG3452 also provides 802.11a/b/g/n/ac wireless connectivity for enhanced mobility and versatility. In addition, the TG3452 provides for up to two separate lines of telephone service.

The Telephony Gateway also offers integrated MoCA 2.0 home networking providing Internet access and transfer of multimedia content between devices over coaxial cable in the home.

Installation is simple and your service provider will provide assistance to you for any special requirements.

Getting Support

If you need assistance with your ARRIS product please contact your service provider.

For additional technical information and product User Guides please visit the ARRIS Support website at <http://www.arris.com/consumers>.

Safety Requirements

The ARRIS Telephony Gateway complies with the applicable requirements for performance, construction, labeling, and information when used as outlined below:

**CAUTION****Potential equipment damage****Potential loss of service**

Connecting the Telephony Gateway to existing telephone wiring should only be performed by a professional installer. Physical connections to the previous telephone provider must be removed and the wiring must be checked; there must not be any voltages. Cancellation of telephone service is not adequate. Failure to do so may result in loss of service and/or permanent damage to the Telephony Gateway.

**CAUTION****Risk of shock**

Mains voltages inside this unit. No user serviceable parts inside. Refer service to qualified personnel only!

**CAUTION****Risk of explosion**

Replacing the battery with an incorrect type, heating a battery above 75°C, or incinerating a battery, can cause product failure and a risk of fire or battery explosion. Do not dispose of in fire. Recycle or dispose of used batteries responsibly and in accordance with local ordinances.

- The Telephony Gateway is designed to be connected directly to a telephone.
- Connecting the Telephony Gateway to the home's existing telephone wiring should only be performed by a professional installer.
- Do not use product near water (i.e. wet basement, bathtub, sink or near a swimming pool, etc.), to avoid risk of electrocution.
- Do not use the telephone to report a gas leak in the vicinity of the leak.
- The product shall be cleaned using only a damp, lint-free, cloth. No solvents or cleaning agents shall be used.
- Do not use spray cleaners or aerosols on the device.
- Avoid using and/or connecting the equipment during an electrical storm, to avoid risk of electrocution.

- Do not locate the equipment within 6 feet (1.9 m) of a flame or ignition source (i.e. heat registers, space heaters, fireplaces, etc.).
- Use only the AC power adapter (if provided) and power cord included with the equipment.
- Equipment should be installed near the power outlet and should be easily accessible.
- The shield of the coaxial cable must be connected to earth (grounded) at the entrance to the building in accordance with applicable national electrical installation codes. In the U.S., this is required by NFPA 70 (National Electrical Code) Article 820. In the European Union and in certain other countries, CATV installation equipotential bonding requirements are specified in IEC 60728-11, *Cable networks for television signals, sound signals and interactive services*, Part 11: Safety. This equipment is intended to be installed in accordance with the requirements of IEC 60728-11 for safe operation.
- If the equipment is to be installed in an area serviced by an IT power line network, as is found in many areas of Norway, special attention should be given that the installation is in accordance with IEC 60728-11, in particular Annex B and Figure B.4.
- In areas of high surge events or poor grounding situations and areas prone to lightning strikes, additional surge protection may be required (i.e. PF11VNT3 from American Power Conversion) on the AC, RF, Ethernet and Phone lines.
- When the Telephony Gateway is connected to a local computer through Ethernet cables, the computer must be properly grounded to the building/residence AC ground network. All plug-in cards within the computer must be properly installed and grounded to the computer frame per the manufacturer's specifications.
- Ensure proper ventilation. Position the Telephony Gateway so that air flows freely around it and the ventilation holes on the unit are not blocked.
- Do not mount the Telephony Gateway on surfaces that are sensitive to heat and/or which may be damaged by the heat generated by the modem, its power supply, or other accessories.

FCC Part 15

This equipment has been tested and found to comply with the requirements for a Class B digital device under Part 15 of the Federal Communications Commission (FCC) rules. These requirements are intended to provide reasonable protection against harmful interference in a residential installation. This equipment generates, uses and can radiate radio frequency energy and, if not installed and used in accordance with the instructions, may cause harmful interference to radio communications. However, there is no guarantee that interference will not occur in a particular installation. If this equipment does cause harmful interference to radio or television reception, which can be determined by turning the equipment off and on, the user is encouraged to try to correct the interference by one or more of the following measures:

- Reorient or relocate the receiving antenna.
- Increase the separation between the equipment and receiver.
- Connect the equipment into an outlet on a circuit different from that to which the receiver is connected.

- Consult the dealer or an experienced radio/TV technician for help.



FCC Caution

Changes or modifications to this equipment not expressly approved by the party responsible for compliance could void the user's authority to operate the equipment.

RF Exposure

This equipment complies with FCC radiation exposure limits set forth for an uncontrolled environment. This equipment should be installed and operated with minimum distance of 11.8 inches (30 cm) between the radiator and your body. This transmitter must not be co-located or operating in conjunction with any other antenna or transmitter.

Canadian Compliance

This Class B digital device complies with Canadian ICES-003.

Cet appareil numérique de la classe B est conforme à la norme NMB-003 du Canada.

Radiation Exposure Statement

The device meets the exemption from the routine evaluation limits in section 2.5 of RSS 102 and compliance with RSS-102 RF exposure, users can obtain Canadian information on RF exposure and compliance.

Le dispositif rencontre l'exemption des limites courantes d'évaluation dans la section 2.5 de RSS 102 et la conformité à l'exposition de RSS-102 rf, utilisateurs peut obtenir l'information canadienne sur l'exposition et la conformité de rf.

This transmitter must not be co-located or operating in conjunction with any other antenna or transmitter. This equipment should be installed and operated with a minimum distance of 30 centimeters between the radiator and your body.

Cet émetteur ne doit pas être Co-placé ou ne fonctionnant en même temps qu'aucune autre antenne ou émetteur. Cet équipement devrait être installé et actionné avec une distance minimum de 30 centimètres entre le radiateur et votre corps.

Operation in the band 5150–5250 MHz is only for indoor use to reduce the potential for harmful interference to co-channel mobile satellite systems.

Le dispositif fonctionnant dans la bande 5150-5250 MHz est réservé uniquement pour une utilisation à l'intérieur afin de réduire les risques de brouillage préjudiciable aux systèmes de satellites mobiles utilisant les mêmes canaux.

Innovation, Science and Economic Development Canada statement:

This device complies with Innovation, Science and Economic Development Canada's licence-exempt RSSs. Operation is subject to the following two conditions:

- (1) This device may not cause interference; and
- (2) This device must accept any interference, including interference that may cause undesired operation of the device.

Le présent appareil est conforme aux CNR d'Innovation, Sciences et Développement économique Canada applicables aux appareils radio exempts de licence. L'exploitation est autorisée aux deux conditions suivantes :

- 1) l'appareil ne doit pas produire de brouillage;
- 2) l'utilisateur de l'appareil doit accepter tout brouillage radioélectrique subi, même si le brouillage est susceptible d'en compromettre le fonctionnement.

For Mexico

The operation of this equipment is subject to the following two conditions: (1) This equipment or device cannot cause harmful interference and (2) this equipment or device must accept any interference, including interference that may cause some unwanted operation of the equipment.

Getting Started

About Your New Telephony Gateway

The Touchstone TG3452 Telephony Gateway is DOCSIS compliant with the following features:

- Speed: much faster than dialup or ISDN service; up to twenty four times faster than DOCSIS 2.0 cable modems.
- Convenience: supports Ethernet and 802.11a/b/g/n/ac wireless connections; both can be used simultaneously
- Flexibility: provides two independent lines of telephone service as well as high speed data
- Compatibility:
 - Data services: DOCSIS 3.1 compliant and backward-compatible with DOCSIS 3.0, 2.0, or 1.1; supports tiered data services (if offered by your service provider)
 - Telephony services: PacketCable™ 2.0 compliant

The TG3452 provides:

- Wireless 802.11a/b/g/n/ac connectivity
- Four Ethernet ports for connections to non-wireless devices
- Up to two lines of telephone service
- Integrated MoCA 2.0 home networking
- DOCSIS 3.1 compliant
- One USB host port (future support for external USB devices)

What's in the Box

Make sure you have the following items before proceeding. Call your service provider for assistance if anything is missing.

- Telephony Gateway
- Power Cord
- Battery (not included with all models)
- Wireless Connection Configuration Guide
- Ethernet Cable
- End User License Agreement

Items You Need

If you are installing the Telephony Gateway yourself, make sure you have the following items on hand before continuing:

- **Telephony Gateway package:** see [What's in the Box](#) (page 10) for a list of items in the package.
- **Coaxial cable (coax):** This is a round cable with a connector on each end. It is the same kind of wire used to connect to your television for cable TV. You can buy coax from any electronics retailer and many discount stores; make sure it has connectors on both ends. There are two types of connectors, slip-on and screw-on; the screw-on connectors are best for use with your Telephony Gateway. The coax should be long enough to reach from your Telephony Gateway to the nearest cable outlet.



Note: For best performance, use high-quality RG-6 type coax cable and minimize or eliminate splitters between the cable jack and the Data Gateway.



- **Phone Cable:** This is a standard phone cable with standard phone connectors (RJ11 type) on both ends. You can buy phone cables from any electronics retailer and many discount stores.

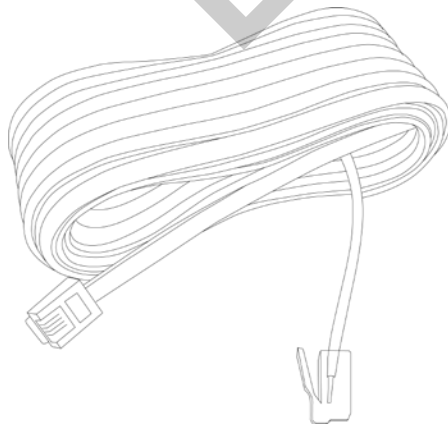

- **Splitter (optional):** provides an extra cable connection by splitting a single outlet into two. You may need a splitter if you have a TV already connected to the cable outlet that you want to use. You can buy a splitter from any electronics retailer and most discount stores; you may also need a short piece of coax cable (with connectors); use it to connect the splitter to the cable outlet and then connect the Telephony Gateway and TV to the splitter.



Note: A splitter effectively cuts the signal in half and sends each half to its two outputs. Using several splitters in a line may deteriorate the quality of your television, telephone, and/or internet connection.

- **Information packet:** your service provider should furnish you with a packet containing information about your service and how to set it up. Read this information carefully and contact your service provider if you have any questions.

Getting Service

Before trying to use your new Telephony Gateway, contact your local service provider to establish an Internet account and telephone service. When you call, have the following information ready:

- the Telephony Gateway serial number and cable MAC addresses of the unit (printed on the Telephony Gateway)
- the model number of the Telephony Gateway (printed on the Telephony Gateway)

If the Telephony Gateway was provided by your service provider, they already have the required information.

In addition, you should ask your service provider the following questions:

- Do you have any special system requirements or files that I need to download after I am connected?
- When can I start using my Telephony Gateway?
- Do I need a user ID or password to access the Internet or my e-mail?
- Will my phone number(s) change?
- What new calling features will I have and how do I use them?

System Requirements

The Touchstone Telephony Gateway operates with most computers. The following describes requirements for each operating system; see the documentation for your system for details on enabling and configuring networking.

To use the Telephony Gateway, you need DOCSIS high-speed Internet service from your service provider. Telephone service requires that the service provider has PacketCable support.

Recommended Hardware

The following hardware configuration is recommended. Computers not meeting this configuration can still work with the TG3452, but may not be able to make maximum use of TG3452 throughput.

- CPU: P4, 3GHz or faster.
- RAM: 1GB or greater.
- Hard drive: 7200 RPM or faster.
- Ethernet: Gig-E (1000BaseT).

Windows

Windows Vista, Windows 7, Windows 8, Windows 10, or Android OS (for mobile devices). A supported Ethernet or wireless LAN connection must be available.

Mac OS

System 7.5 to Mac OS 9.2 (Open Transport recommended), Mac OS X, or iOS (for mobile devices). A supported Ethernet or wireless LAN connection must be available.

Linux/Unix

Hardware drivers, TCP/IP, and DHCP must be enabled in the kernel. A supported Ethernet or wireless LAN connection must be available.

About this Manual

This manual covers the Touchstone TG3452 Telephony Gateway. The model number is on the label affixed to the Telephony Gateway.

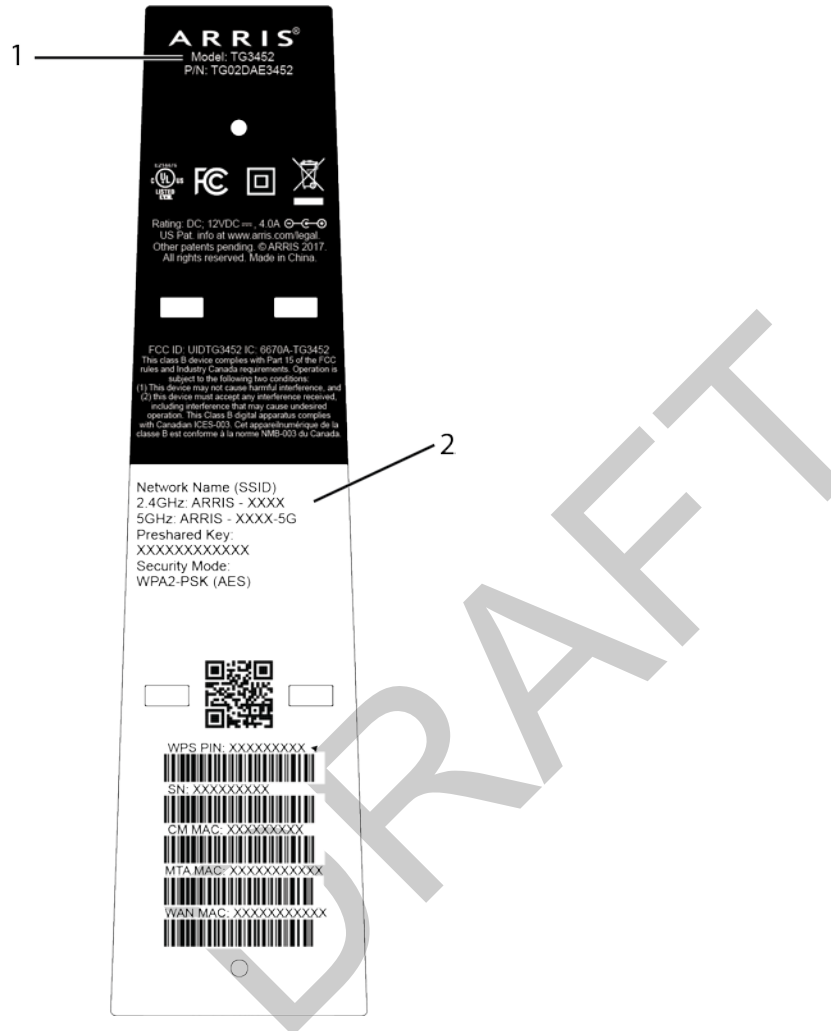

1. Model number
2. Security label

What About Security?

Having a high-speed, always-on connection to the Internet requires a certain amount of responsibility to other Internet users—including the need to maintain a reasonably secure system. While no system is 100% secure, you can use the following tips to enhance your system's security:

- Keep the operating system of your computer updated with the latest security patches. Run the system update utility at least weekly.

- Keep your email program updated with the latest security patches. In addition, avoid opening email containing attachments, or opening files sent through chat rooms, whenever possible.
- Install a virus checker and keep it updated.
- Avoid providing web or file-sharing services over your Telephony Gateway. Besides certain vulnerability problems, most cable companies prohibit running servers on consumer-level accounts and may suspend your account for violating your terms of service.
- Use the service provider's mail servers for sending email.
- Avoid using proxy software unless you are certain that it is not open for abuse by other Internet users (some are shipped open by default). Criminals can take advantage of open proxies to hide their identity when breaking into other computers or sending spam. If you have an open proxy, your service provider may suspend your account to protect the rest of the network.
- The TG3452 ships with wireless LAN security set by default (for the same reasons that you should run only secured proxies). See the security label on your product for the factory security settings. If you need to modify the default wireless security settings, see *Configuring Your Wireless Connection*.

Ethernet or Wireless?

There are two ways to connect your computer (or other equipment) to the Telephony Gateway. The following will help you decide which is best for you:

Ethernet

Ethernet is a standard method of connecting two or more computers into a Local Area Network (LAN). You can use the Ethernet connection if your computer has built-in Ethernet hardware.



Note: To connect more than four computers to the TG3452 through the Ethernet ports, you need an Ethernet hub (available at computer retailers).

The Telephony Gateway package comes with one 4-foot (1.2m) Ethernet cable (the connectors look like wide telephone connectors); you can purchase more cables if necessary at a computer retailer. If you are connecting the Telephony Gateway directly to a computer, or to an Ethernet hub with a cross-over switch, ask for Category 5e (CAT5e) straight-through cable. CAT5e cable is required for gigabit Ethernet (Gig-E), not regular CAT5 cable.

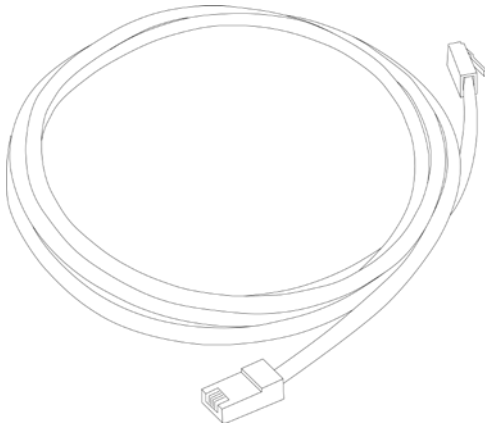

Wireless

Wireless access lets you connect additional (wireless-capable) devices to Telephony Gateway. The 802.11 wireless LAN standard allows one or more computers to access the TG3452 using a wireless (radio) signal. These connections are in addition to the connections supported via Ethernet.



Note: You can use the wireless connection if your computer has a built-in or aftermarket plug-in wireless adapter. To learn more about which wireless hardware works best with your computer, see your computer dealer.

Both

If you have two or more computers, you can use Ethernet for up to four devices and wireless for the others. To connect five or more computers to the Ethernet ports, you will need an Ethernet hub (available at computer retailers.)

Installing and Connecting your Telephony Gateway

Before you start, make sure that:

- You have contacted your service provider and verified that they provide data and telephone service using standard DOCSIS technology.
- You have all the *Items You Need* (page 11).
- Cable, phone, and power outlets are available near the computer. If a cable outlet is not conveniently located, your service provider can install a new one.

If you have ordered service, your service provider should configure the Telephony Gateway automatically. You need only follow the instructions in this section to install and connect the Telephony Gateway.



CAUTION

Risk of equipment damage

Only qualified installation technicians should connect the Telephony Gateway to house wiring. Incumbent telephone service must be physically disconnected at the outside interface box before making any connections.

Front Panel

The front of the TG3452 has the following indicators.

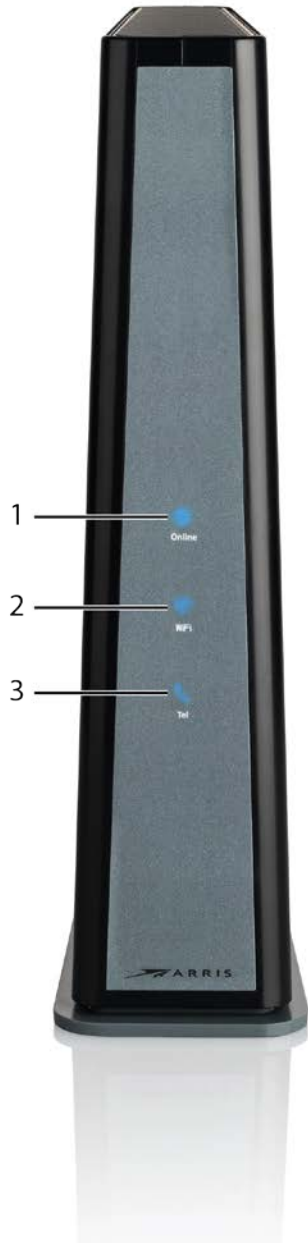

1. Online: indicates internet data transmission status.
2. WiFi: indicates the status of the wireless LAN.
3. Tel: indicates the status of the telephone line.

Rear Panel

The rear of the Telephony Gateway has the following connectors and controls.

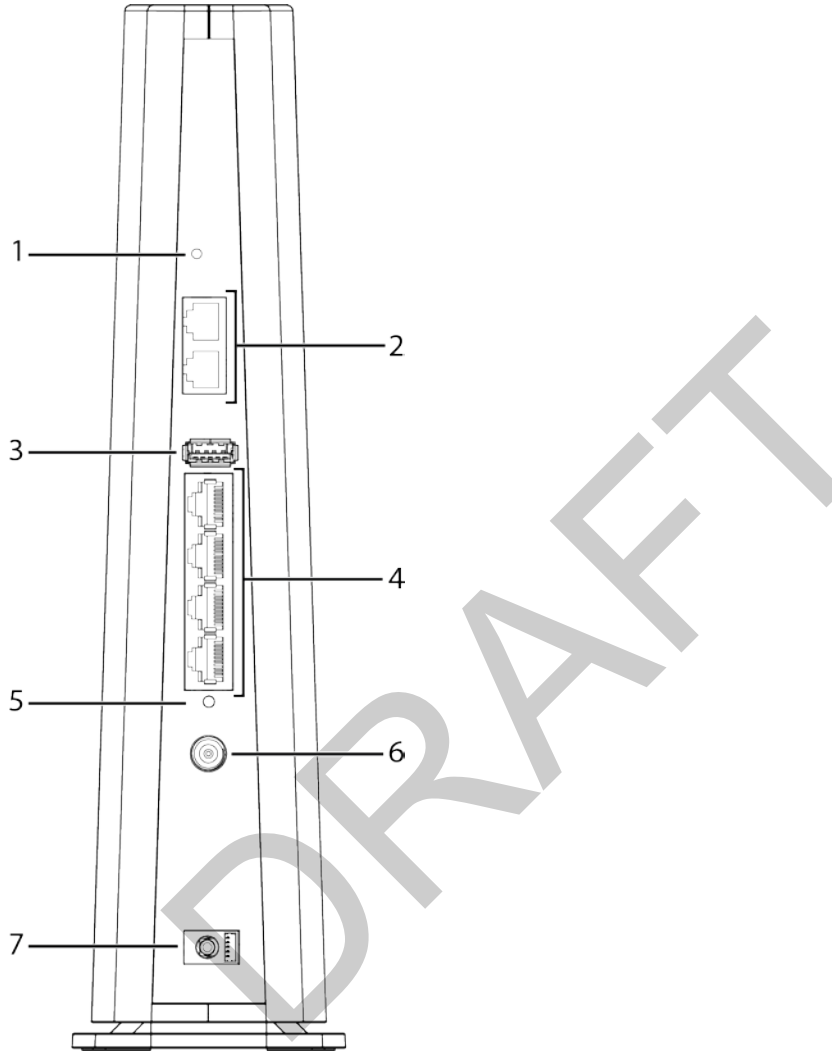

1. **Reset button:** resets the Telephony Gateway as if you power cycled the unit. Use a pointed non-metallic object to press this button.
2. **Tel (1 - 2):** connectors for phone lines.
3. **USB:** USB host connector - future support for external USB devices
4. **Ethernet (1 - 4):** connectors for use with a computer LAN port.
5. **MoCA LED:** indicates the status of the MoCA connection.
6. **Cable:** connector for the coaxial cable.
7. **Power:** connector for the power cord.

Selecting an Installation Location

There are a number of factors to consider when choosing a location to install your Telephony Gateway:

- Is an AC outlet available nearby? For best results, the outlet should not be switched and should be close enough to the Telephony Gateway that extension cords are not required.
- Is a cable jack available? For best performance, keep the number of splitters between the jack and cable drop to a minimum. Each splitter attenuates (reduces) the signal available to the Telephony Gateway. A large number of splitters can slow down the Internet connection and even affect your telephone service.
- Can you easily run cables between the Telephony Gateway's location and the phones?
- If you are connecting devices to the Ethernet ports, can you easily run cables between the Telephony Gateway's location and those devices?
- If you want to install the Telephony Gateway on a desktop, is there enough space on either side to keep the vents clear? Blocking the vents may cause overheating.
- How close are your wireless devices? The Telephony Gateway wireless connection range is typically 100–200 feet (30m–65m). A number of factors can affect connection range, as described below.

Desktop Mounting Instructions

Position the Telephony Gateway so that:

- it stands vertically on its base (Do not lay it flat on its side.)
- air flows freely around it
- the back faces the nearest wall
- it will not fall to the floor if bumped or moved
- the ventilation holes on the sides of the unit are not blocked

Factors Affecting Wireless Range

A number of factors can affect the usable range for wireless connections.

Increases range	<ul style="list-style-type: none"> ■ Raising the unit above the devices (for example, installing the Telephony Gateway in the upper floor of a multi-story dwelling) ■ Adding a wireless extender to the network
Decreases range	<ul style="list-style-type: none"> ■ Lowering the unit below the devices (for example, installing the Telephony Gateway in a basement) ■ Metal or concrete walls between the Telephony Gateway and other devices ■ Large metal appliances, aquariums, or metal cabinets between the Telephony Gateway and other devices ■ Interference and RF noise (2.4 GHz wireless phones, microwave ovens, or other wireless networks)



Note: Note that decreasing the range of your wireless network may be beneficial, as long as the decreased range is sufficient for your needs. By limiting your network's range, you reduce interference with other networks and make it harder for unwanted users to find and connect to your network.



Note: Setting the transmit power level to High increases the range. Setting it to Medium or Low decreases the range proportionately.

DRAFT

Connecting the Telephony Gateway



WARNING

Risk of injury or equipment damage

Connecting the Telephony Gateway to the home's existing telephone wiring should only be performed by a professional installer. Physical connections to the previous telephone provider must be removed and the wiring must be checked; there must not be any voltage. Cancellation of telephone service is not adequate. Failure to do so may result in loss of service and/or permanent damage to the Telephony Gateway.

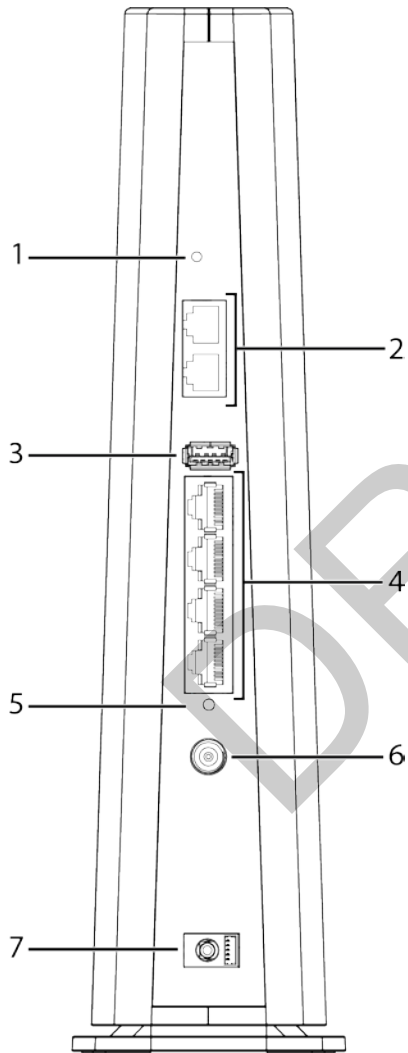

1. Connect one end of the coax cable to the cable outlet or splitter, and the other end to the Telephony Gateway's Cable connector (6). Tighten the connections by hand, then tighten an additional 1/8 turn with a wrench.



Note: For best performance, use high-quality coax cable and minimize or eliminate splitters between the cable jack and the Telephony Gateway. If you are using MoCA for

your home network, MoCA filters must be installed on any legacy client devices. Your service provider will install these filters for you.

2. Insert the plug from the power cord into the Power connector on the back of the Telephony Gateway (7) and insert the power cord into a convenient AC outlet.
3. Connect one end of the Ethernet cable to any Ethernet port on the back of the Telephony Gateway, (4) and the other end to the Ethernet port on a computer, hub, or broadband router.



Note: If you are connecting to a computer, use the Ethernet cable included in the Telephony Gateway package.

4. Connect one end of the telephone cable to one of the telephone ports on the back of the Telephony Gateway (2). Connect the other end to the telephone.

Configuring Your Wireless Connection

The TG3452 ships with wireless LAN security set by default. See the security label on your product for the factory security settings.

DRAFT



Note: You must set up your computer and other client devices to work with the security settings on the TG3452. Refer to the documentation for your client device for instructions on setting security. On most computer systems you only need to select the network name (SSID) device and enter the encryption key.

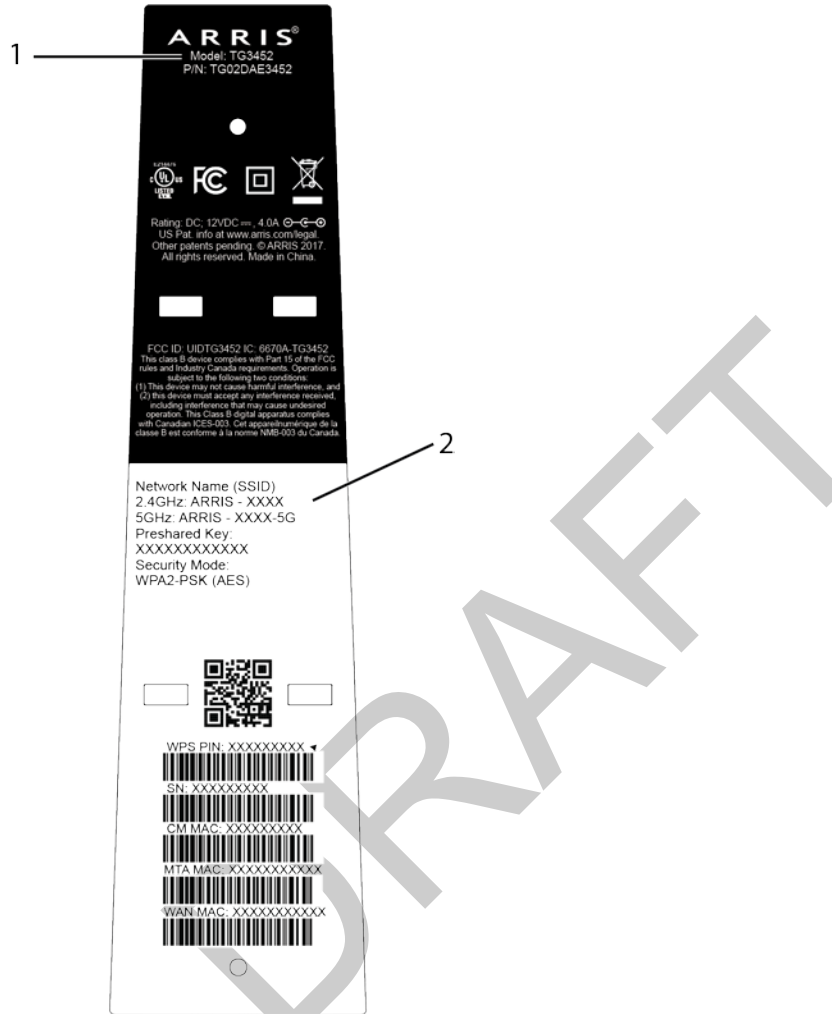

1. Model number
2. Security label

If you need to modify the Telephony Gateway’s default wireless security settings, or if you want to configure any other wireless LAN settings, refer to the following instructions.

Accessing the Configuration Interface

Follow these steps to access the configuration interface. You should have already set up the TG3452 as described in *Installing and Connecting your Telephony Gateway* (page 17).

1. If security has been properly set up on your computer to access the wireless LAN on the TG3452, use the connection utility for your operating system to connect to the wireless LAN using its network name (SSID), as shown on the security label.

2. If you cannot access the wireless LAN, you must first establish a wired Ethernet connection between your computer and the TG3452.
3. In your web browser, open the page <http://192.168.0.1/> to access the wireless router setup.

The Login screen displays.



Note: The default user name is “admin”. The default password is “password”, in lower case letters.

4. Enter the user name and password and click the Apply button to log in.

The System Basic Setup screen displays.

5. Use the online help information to set configuration parameters as required.



Note: Most configuration parameters that you may want to set can be accessed on the System Basic Setup screen, including the security mode and setting a system password.

Setting Parental Controls

The Parental Control feature allows you to block specified keywords and web sites from being accessed and also to specify trusted computers in the network. Trusted computers are not affected by the parental control settings.

Finding the MAC Address of a Computer

In order to set up trusted computers you must first determine the MAC address of those computers.

Use the operating system of your computer to find its MAC address, as follows:

Windows: from the Start menu, find and select the **Control Panel**. Double-click **Network & Sharing Center**. Then double-click either “Wireless Network Connection” for a wireless connection, or “Local Area Connection” for an Ethernet connection. Next click the **Details** button. The “Physical Address” line shows the MAC address.

macOS: open System Preferences and click the Network icon. To find the Ethernet MAC address, select **Built-in Ethernet** from the Show drop-down, then click the Ethernet tab. The “Ethernet ID” field shows the MAC address. To find the wireless MAC address, select **Airport** from the Show drop-down, then click the Airport tab. The “Airport ID” field shows the MAC address.

Linux: open a shell window and type `/sbin/ifconfig` (and press Enter). The wireless interface is eth1 (unless there is no Ethernet adapter, in which case the interface is eth0).

Making Your Parental Control Settings

Follow these steps to set up your Parental Controls:

1. Access and log into the wireless configuration interface as explained in [Accessing the Configuration Interface](#) (page 24).
2. Click the **Firewall** tab and then click **Parental Controls** in the side menu to display the Parental Controls screen.
3. Check the **Enable Parental Controls** checkbox and click the **Apply** button.

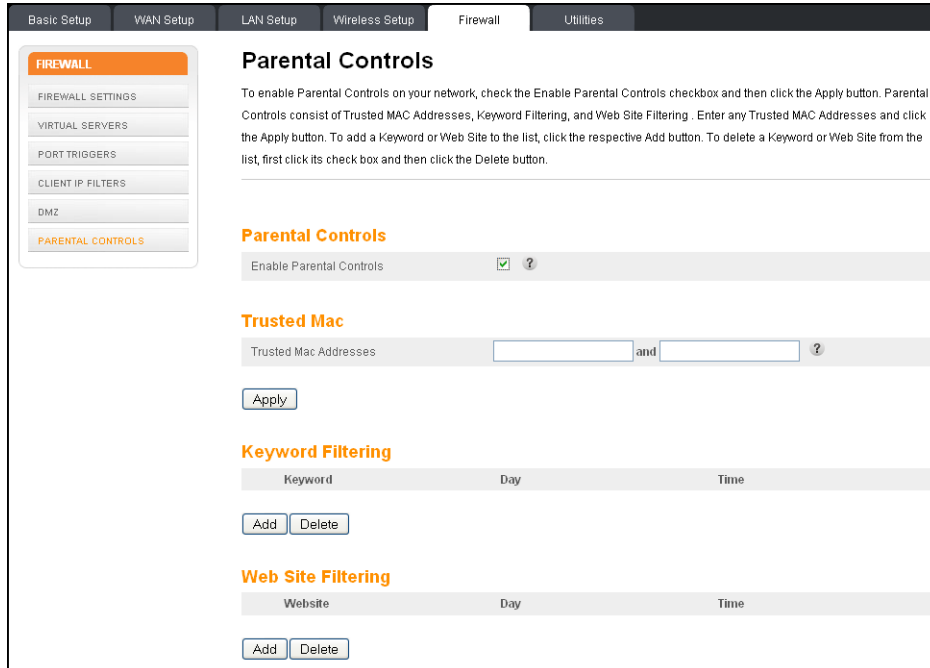

The screenshot shows the 'Parental Controls' configuration page. At the top, there are tabs for 'Basic Setup', 'WAN Setup', 'LAN Setup', 'Wireless Setup', 'Firewall', and 'Utilities'. The 'Firewall' tab is active, and 'Parental Controls' is selected in the sidebar. The main content area is titled 'Parental Controls' and includes the following sections:

- Parental Controls:** A checkbox labeled 'Enable Parental Controls' is checked. A help icon (?) is next to it.
- Trusted Mac:** Two input fields for 'Trusted Mac Addresses' are separated by 'and'. An 'Apply' button is below.
- Keyword Filtering:** A table with columns 'Keyword', 'Day', and 'Time'. 'Add' and 'Delete' buttons are below.
- Web Site Filtering:** A table with columns 'Website', 'Day', and 'Time'. 'Add' and 'Delete' buttons are below.

4. Configure any or all of the following parental controls:

Trusted MAC Addresses:

Enter the MAC addresses of any “trusted” computers on the network and click the **Apply** button. You can add two trusted computers. Once added, these trusted computers will not be affected by the parental control settings. For example, you may want the computers of the father and mother to be trusted, while the childrens’ computers have parental controls in effect.



Note: Refer to the [Finding the MAC Address of a Computer](#) (page 25) for information on determining the MAC address of your computer.

Keyword and Web Site Filtering:

You can add a list of keywords and web sites that you want to block. To add a keyword or web site to the list, click the respective **Add** button. To delete a keyword or web site from the list, first click its check box and then click the **Delete** button.

Add Keyword Filter Dialog Box

The AddKeywordFilter dialog box contains the following elements:

- Keyword:** A text input field with a help icon (?) to its right.
- Day:** A section with a checkbox for ALL WEEK and checkboxes for Sun, Mon, Tue, Wed, Thu, Fri, and Sat.
- Time:** A section with a checkbox for ALL DAY and a time range selector showing until with a help icon (?) to the right.
- Buttons:** and .

Add Web Site Filter Dialog Box

The AddWebSiteFilter dialog box contains the following elements:

- Web Site:** A text input field with a help icon (?) to its right.
- Day:** A section with a checkbox for ALL WEEK and checkboxes for Sun, Mon, Tue, Wed, Thu, Fri, and Sat.
- Time:** A section with a checkbox for ALL DAY and a time range selector showing until with a help icon (?) to the right.
- Buttons:** and .

Adding a Keyword or Web Site Filter

- Enter the keyword in the Keyword field or web site URL address in the Web Site field.
- Click the checkboxes for the days you want access blocked, or click the All Week checkbox for all week.
- Set the start time and end time during the specified days (24-hour clock). (0:00 until 0:00 indicates all day, or just click the All Day checkbox.)
- Click the **Add Keyword Filter** or **Add Web Site Filter** button respectively. Then click the **Apply** button.

Configuring Your Ethernet Connection

If your computer is equipped with a LAN card providing an Ethernet connection, you may have to configure your computer's TCP/IP settings. The steps that follow will guide you through setting your computer's TCP/IP settings to work with the Telephony Gateway.

Requirements

Make sure you have the following before attempting to configure your Ethernet connection:

- Computer with Ethernet interface.
- Ethernet cable (supplied).
- IP address, subnet, gateway, and DNS information for installations not using DHCP.

How to use this Chapter

The following list shows the procedures for modifying the TCP/IP settings on the computer. The procedure is slightly different depending on the operating system that you are using. Please ensure you are using the correct steps for the operating system on your computer. Follow the links below for instructions to configure your Ethernet connection on your operating system.

- [TCP/IP Configuration for Windows Vista](#) (page 28)
- [TCP/IP Configuration for Windows 7, Windows 8, or Windows 10](#) (page 29)
- [TCP/IP Configuration for macOS](#) (page 29)

TCP/IP Configuration for Windows Vista

Follow these steps to configure the Ethernet interface on a Windows Vista operating system.

1. Open the Vista Control Panel.
2. Double-click **Network and Sharing Center** to display the Network and Sharing Center Window.
3. Click **Manage network connections**. If prompted for a connection, choose **Local Area Connection**.

The Network Connections window displays.

4. Double-click the **Local Area Connection** to open the Properties window:



Note: If Windows requests permission to continue, click **Continue**.

5. Double-click **Internet Protocol Version 4 (TCP/IPv4)** to configure TCP/IPv4.



Note: If your cable provider requires TCP/IP version 6, double-click **Internet Protocol Version 6 (TCP/IPv6)** to configure TCP/IPv6.

The TCP/IP properties window for the version you selected displays.

6. For either TCP/IPv4 or TCP/IPv6, select **Obtain an IP address automatically** and **Obtain DNS server address automatically**, unless instructed otherwise by your cable provider.
7. Click **OK** to accept the new settings and close the Properties window.

TCP/IP Configuration for Windows 7, Windows 8, or Windows 10

Follow these steps to configure the Ethernet interface on a Windows 7, Windows 8, or Windows 10 operating system.

1. Click the **Start** menu and type **network and sharing** into the Search box.
2. Select **Network and Sharing Center** when it appears.
3. Click **Change adapter settings** from the left-side menu.
4. Right-click on your local area connection icon and select **Properties** to open the Properties window.
5. Select **Internet Protocol Version 4 (TCP/IPv4)** and click **Properties** to configure TCP/IPv4.



Note: If your cable provider requires TCP/IP version 6, select **Internet Protocol Version 6 (TCP/IPv6)** and click **Properties** to configure TCP/IPv6.

The TCP/IP properties window for the version you selected displays.

6. For either TCP/IPv4 or TCP/IPv6, select **Obtain an IP address automatically** and **Obtain DNS server address automatically**, unless instructed otherwise by your cable provider.
7. Click **OK** to accept the new settings and close the Properties window. Then click **Close** to back out of the remaining setup screens.

TCP/IP Configuration for macOS

Follow these steps to configure the Ethernet interface on a macOS operating system.

1. Open System Preferences, either by choosing **System Preferences** from the Apple menu or by clicking the System Preferences icon in the dock.
2. Click the **Network** icon.

3. Choose **Automatic** from the Location drop-down menu, and **Built-in Ethernet** from the Show menu.
4. Choose the TCP/IP tab, if necessary.
If you are using **TCP/IPv4**, go to **step 5**.
If your cable provider requires **TCP/IPv6**, go to **step 8**.
5. Choose **Using DHCP** from the Configure IPv4 menu.
6. If necessary, click the **Renew DHCP Lease** button.
7. Close the System Properties application.
TCP/IPv4 configuration is completed.
8. If you are using TCP/IPv6, click **Configure IPv6** near the bottom of the previous window.
9. Choose **Automatically** from the Configure IPv6 drop-down menu and click **OK**.
10. Close the System Properties application.

DRAFT

Using the Telephony Gateway

This chapter describes the controls and features available on the Telephony Gateway, and covers basic troubleshooting procedures.

- [Setting up Your Computer to Use the Telephony Gateway](#) (page 31)
- Indicator Lights for the TG3452
- Using the Reset Button
- [Resetting the Router to Factory Defaults](#) (page 36)

Setting up Your Computer to Use the Telephony Gateway

Follow the instructions in the information packet supplied by your service provider. Contact your service provider if you need help setting up your computer.

Indicator Lights for the TG3452



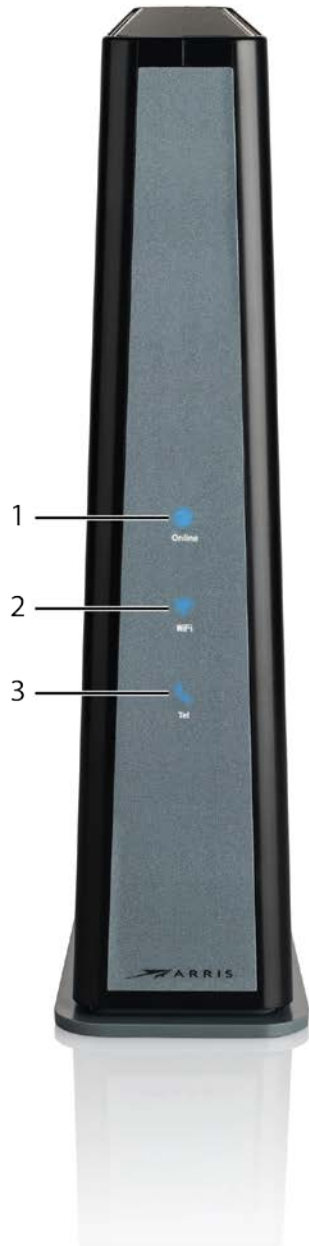

The Telephony Gateway has LED indicator lights to assist in troubleshooting.



1. Online
2. Wi-Fi
3. Tel

Online LED

The following table shows light patterns for the Online LED during normal operation.

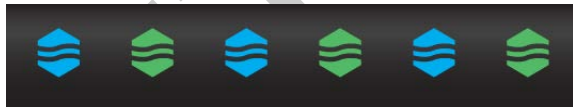



Event	Online LED Status	LED Behavior
Power On	Blue (steady)	
Acquiring downstream lock	Blue (slow blink)	
Acquiring upstream lock	Blue (fast blink)	
IP Link/Online	Green (steady)	
Firmware download	Alternating blue and green	





Caution: If all LEDs are blinking blue (fast blink), a grounding defect has been detected. Unplug the device until the grounding defect can be addressed.

Wi-Fi LED

The following table shows light patterns for the Wi-Fi LED during normal operation.

Event	Wi-Fi LED Status	LED Behavior
No clients found (5 GHz or dual-band)	Green (slow blink)	
Clients found, but no traffic (5 GHz or dual-band)	Green (steady)	
Clients with active traffic/WPS (5 GHz or dual-band)	Green (fast blink)	
No clients found (2.4 GHz band only)	Blue (slow blink)	







Event	Wi-Fi LED Status	LED Behavior
Clients found, but no traffic (2.4 GHz band only)	Blue (steady)	
Clients with active traffic/WPS (2.4 GHz band only)	Blue (fast blink)	



Caution: If all LEDs are blinking blue (fast blink), a grounding defect has been detected. Unplug the device until the grounding defect can be addressed.

Voice LED

The following table shows light patterns for the Voice LED during normal operation.

Event	Voice LED Status	LED Behavior
Good battery, AC power present	Green (steady)	
No battery backup, AC power present	Green (steady)	
Good battery, AC power fail	Blue (steady)	
Low or bad battery	Red (steady)	
Off-hook, AC power present	Alternating red and green (slow blink)	
Off-hook, AC power missing	Alternating red and blue (fast blink)	
Home alarm triggered	Alternating green and blue	



Caution: If all LEDs are blinking blue (fast blink), a grounding defect has been detected. Unplug the device until the grounding defect can be addressed.

Using the Reset Button

Use the **Reset** button (1), on the back of the Telephony Gateway, to reset the modem and perform initialization as if you power cycled the unit. You may need to reset the Telephony Gateway if you are having problems connecting to the Internet. Using this button will be rare.

Use a pointed **non-metallic** object to press this button. The **Reset** button is recessed to prevent accidental resets.

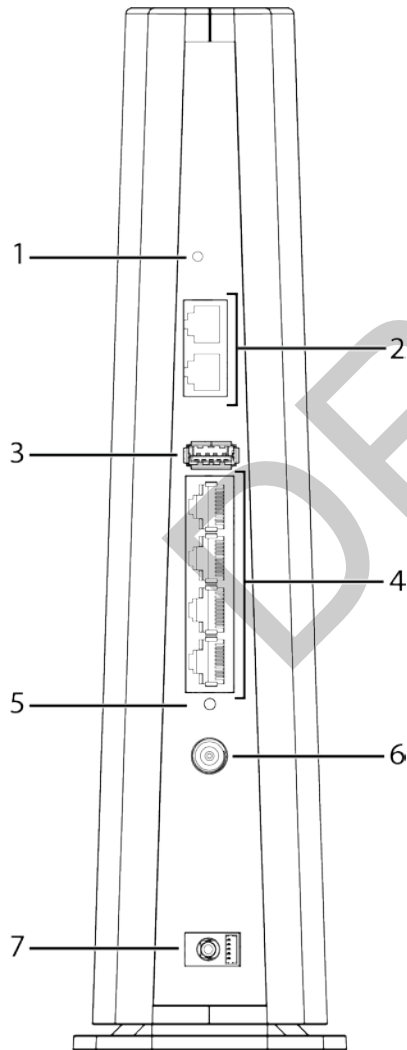

- | | |
|---------------------|-------------|
| 1. Reset button | 5. MoCA LED |
| 2. Tel (1 and 2) | 6. Cable |
| 3. USB | 7. Power |
| 4. Ethernet (1 - 4) | |

Resetting the Router to Factory Defaults

To reset the router to factory defaults, press and hold the **Reset** button on the back of the Telephony Gateway for more than fifteen seconds. This restores the wireless setup configuration and router configuration parameters to the factory defaults. You may need to do this if a misconfiguration has locked out all access.

DRAFT

Troubleshooting

The Telephony Gateway is plugged in, but the Power light is Off

Check all power connections. Is the power cord plugged in firmly at both ends?

If you plugged the power cord into a power strip, make sure the strip is switched on.

Try to plug the power cord into a different outlet. If the outlet is controlled by a wall switch, make sure the switch is on.

Finally, check the fuse or circuit breaker panel.

I'm not getting on the Internet (all connections)

It may take over 30 minutes to establish a connection the first time you power up your Telephony Gateway, especially when many people are online. Always leave your Telephony Gateway plugged into AC power and connected to the cable system.

Check the front panel lights:

- The **Power** and **Online** lights should be on.
- If the **Power** light blinks for more than 30 minutes, call your service provider for assistance.

Check your cable connections. Connectors should be tight. The coax cable should not be pinched, kinked, or bent sharply—any of these can cause a break or short in the cable (you may have to replace the cable). If you have one or more splitters between the Telephony Gateway and CATV outlet, remove the splitters and connect the Telephony Gateway directly to the outlet.

Proceed to the Ethernet or wireless solutions if necessary.

I'm not getting on the Internet (Ethernet)

If you are using a hub, is the hub turned on?

Are you using the right type of Ethernet cable? Use the supplied cable for direct connection to a computer; use a cross-over cable for connection to a hub.

Press the **Reset** button on the back of the Telephony Gateway.

A misconfiguration could lock out all access to the Telephony Gateway router. If you think this has happened, see [Resetting the Router to Factory Defaults](#) (page 36).

I'm not getting on the Internet (Wireless)

Check the indicator lights, see [Using the Telephony Gateway](#) (page 31) — the Wi-Fi light should be on.

Does your connection utility discover your wireless LAN? If you turned off “Broadcast SSID” you need to manually enter the name of your wireless LAN in the connection utility.

Change your security mode to “disabled”. Enable one of the other security modes as soon as you find the problem.

A misconfiguration could lock out all access to the Telephony Gateway router. If you think this has happened, see [Resetting the Router to Factory Defaults](#) (page 36).

My wireless Internet connection stops working sometimes

This is usually caused by interference. Two common sources are 2.4GHz “remote” telephones and microwave ovens. If you cannot remove the interfering product, try using a different channel or setting Protected Mode.

I can get on the Internet, but everything is slow

If the Web site you are visiting is very popular, that site may be having trouble servicing all the requests. If other sites download quickly, wait for a few minutes and try again. Usage during peak hours may also affect the connection speed.

Other communications on the LAN, or interference with wireless connections, may slow down the connection.

I don't have a dial tone when I pick up the phone - why?

In order for telephone service to be functional on the Telephony Gateway, telephone service must have been purchased from the service provider and configured on your Telephony Gateway. The following steps should help in identifying the source of the problem.

1. Is the Power LED lit?

- If not, check to make sure the Telephony Gateway is plugged in and the outlet has power. Use only the external AC power adapter (if provided) and power cord included with the equipment.
 - If the LED is lit, go to the next step.
2. Is the Online LED lit?
 - If not, check the coax connection at the Telephony Gateway and the wall. Ensure they are connected and tight. If they are and you do not have dial tone, contact your service provider.
 - If the Online LED is lit, go to the next step.
 3. Is the Telephone (Tel 1 or Tel 2) LED lit?
 - If not, phone service has not been set up on that line. Contact your service provider.
 - If it is blinking, there is a phone off hook somewhere in the house. Find that phone and hang it up.
 - If it is lit, go to the next step.
 4. Is the phone plugged directly into the Telephony Gateway?
 - Make sure the phone is plugged into the port on the back of the Telephony Gateway labeled “Tel 1” for line 1, and “Tel 2” for line 2.
 - If so, try a different phone. Make sure the new phone is a working phone.
 - If a known good phone is used and you still don’t have dial tone, try a different phone cable. If a new phone and cable do not restore dial tone, call your service provider.
 5. Is the Telephony Gateway plugged into a wall outlet?
 - If so, unplug the phone connector at the back of the Telephony Gateway and plug in a known working phone. If you now have dial tone, the problem is with the house wiring. Contact your service provider or a qualified wiring technician to correct the house wiring. If you still do not have dial tone, contact your service provider.

Glossary

A

Amp-Hour

A measure of battery capacity. For example, a 1.0Ah battery can nominally supply one Ampere of current for one hour.

C

Category 5e (Cat5e)

A high-quality type of cable, used for gigabit Ethernet (1000BaseT) connections. When purchasing Ethernet cables, always look for Category 5e cable.

Coaxial cable (coax)

A thin wire, used to connect your television and Telephony Gateway to the cable TV system. You can buy coax from any electronics retailer and many discount stores.

CPE

Customer Premise Equipment. This is the equipment that is plugged in to the Telephony Gateway; typically a computer or hub.

Cross-over

An Ethernet cable used to connect two hubs (or a hub and a cable modem) together. Also, some Ethernet hubs may have built-in cross-over on one or more ports (which eliminates the need for a cross-over cable).

D

DHCP

Dynamic Host Configuration Protocol. An IP protocol used to provide an IP address and location of services (such as DNS and TFTP) needed by a device connecting to the network. DHCP allows the cable company to configure your computer's networking software for you.

DNS

Domain Name Service (Server). An IP service that associates a domain name (such as www.example.com) with an IP address.

DOCSIS

Data Over Cable System Interface Specification. The interoperability standards used for data communications equipment on an HFC network.

Downstream

In an HFC network, the direction from the head-end to the subscriber. Some older cable documentation may refer to this as the forward path.

E

EMTA

Embedded Multimedia Terminal Adapter. An MTA device that is integrated with a cable modem.

Ethernet

A standard method of connecting two or more computers into a Local Area Network (LAN).

EuroDOCSIS

The European version of DOCSIS.

Event

An informational message used for monitoring network status.

F

F-connector

The type of connector used on coax cable. There are two common types of F-connector, slip-on and screw-on. Use coax with screw-on connectors for connecting your Telephony Gateway.

Firewall

A hardware or software device that prevents unauthorized access to a private network from the Internet. The TG3452 provides a built-in firewall.

G

Gateway

The device, usually a router, that connects devices on a given IP subnet to other IP subnets.

H

Headend

The “central office” in an HFC network. The headend houses both video and data equipment. In larger cable networks, a “master” headend often feeds several “remote” headends to provide distributed services.

HTTP

HyperText Transfer Protocol.

Hub

A box with several Ethernet connectors. Ethernet hubs provide a common point of contact for all connected devices.

I

IP address

A number assigned to your computer by your service provider, used to identify your computer to other systems on the Internet.

ISDN

Integrated Services Digital Network. A digital telephony standard that provides communication speeds about twice as fast as standard dialup.

L

LAN

Local Area Network. A network that allows computers in a single location (such as a building) to communicate with one another.

LED

Light Emitting Diode. A semi-conductor diode that emits light when current is passed through it.

M

MAC address

A number that uniquely identifies any device connected to a network. Your service provider uses your Telephony Gateway’s MAC address to authorize access to the Internet. The MAC address is printed on a label on the bottom of your Telephony Gateway.

P

Protocol

A set of rules and formats that determines the communication behavior of network entities at a given layer.

Proxy

A device or program that stands in between a server (for example, a web site) and a client (your browser), providing a way to relieve some of the burden from the server. For example, your service provider may have a web proxy that keeps copies of popular web pages; the proxy can send you those pages instead of fetching them directly from the web site, resulting in faster page loading and less network congestion.

R

RF

Abbreviation for Radio Frequency. Some literature refers to coax as “RF cable” and the connectors as “RF connectors.”

RJ-11

A standard 2-conductor modular connector, commonly used in North America for connecting telephones.

RJ-45

A standard 8-conductor modular connector, commonly used on Ethernet cable. An RJ-45 connector looks like a wide RJ-11 (telephone) connector.

S

Splitter

A small box with three cable connectors: one input and two outputs. You may need a splitter if you have a TV already connected to the cable outlet that you want to use for your Telephony Gateway. You can buy a splitter from any electronics retailer and most discount stores.

SSID

Service Set Identifier. A string of text (up to 32 characters long) that uniquely identifies a wireless LAN.

Switched outlet

A power outlet that may be turned on and off using a wall switch. Usually intended for lamps. Avoid plugging your computer or Telephony Gateway into a switched outlet to avoid disruptions.

T

TCP/IP

Transmission Control Protocol/Internet Protocol. The protocols used to facilitate communications across one or more connected networks.

TDMA

Time Division Multiple Access. A method used by DOCSIS-compliant cable modems for sending upstream data with minimal interference.

U

Upstream

The path from a subscriber device to the headend. Some older cable documentation may refer to this as the return path or reverse path.

W

WEP

Wired Equivalent Privacy. A common standard for encrypting data sent over a wireless LAN.

WPA

Wi-fi Protected Access. A standard for encrypting data sent over a wireless LAN. WPA offers improved security over WEP.

DRAFT

Corporate Headquarters

ARRIS · Suwanee · Georgia · 30024 · USA

T: 1-678-473-2000 F: 1-678-473-8470

www.arris.com