

# TP-LINK®

## User Guide

**TL-WA500G**

**54M Wireless Access Point**



## **COPYRIGHT & TRADEMARKS**

Specifications are subject to change without notice. **TP-LINK®** is a registered trademark of TP-LINK TECHNOLOGIES CO., LTD. Other brands and product names are trademarks or registered trademarks of their respective holders.

No part of the specifications may be reproduced in any form or by any means or used to make any derivative such as translation, transformation, or adaptation without permission from TP-LINK TECHNOLOGIES CO., LTD. Copyright © 2009 TP-LINK TECHNOLOGIES CO., LTD.

All rights reserved.

<http://www.tp-link.com>

## FCC STATEMENT



This equipment has been tested and found to comply with the limits for a Class B digital device, pursuant to part 15 of the FCC Rules. These limits are designed to provide reasonable protection against harmful interference in a residential installation. This equipment generates, uses and can radiate radio frequency energy and, if not installed and used in accordance with the instructions, may cause harmful interference to radio communications. However, there is no guarantee that interference will not occur in a particular installation. If this equipment does cause harmful interference to radio or television reception, which can be determined by turning the equipment off and on, the user is encouraged to try to correct the interference by one or more of the following measures:

- Reorient or relocate the receiving antenna.
- Increase the separation between the equipment and receiver.
- Connect the equipment into an outlet on a circuit different from that to which the receiver is connected.
- Consult the dealer or an experienced radio/ TV technician for help.

This device complies with part 15 of the FCC Rules. Operation is subject to the following two conditions:

- 1) This device may not cause harmful interference.
- 2) This device must accept any interference received, including interference that may cause undesired operation.

Any changes or modifications not expressly approved by the party responsible for compliance could void the user's authority to operate the equipment.

NOTE:THE MANUFACTURER IS NOT RESPONSIBLE FOR ANY RADIO OR TV INTERFERENCE CAUSED BY UNAUTHORIZED MODIFICATIONS TO THIS EQUIPMENT.SUCH MODIFICATIONS COULD VOID THE USER'S AUTHORITY TO OPERATE THE EQUIPMENT.

### **FCC RF Radiation Exposure Statement**

This equipment complies with FCC RF radiation exposure limits set forth for an uncontrolled environment. This device and its antenna must not be co-located or operating in conjunction with any other antenna or transmitter.

“To comply with FCC RF exposure compliance requirements, this grant is applicable to only Mobile Configurations. The antennas used for this transmitter must be installed to provide a separation distance of at least 20 cm from all persons and must not be co-located or operating in conjunction with any other antenna or transmitter.”

## CE Mark Warning



This is a class B product. In a domestic environment, this product may cause radio interference, in which case the user may be required to take adequate measures.

### National Restrictions

2400.0-2483.5 MHz

Country	Restriction	Reason/remark
Bulgaria		General authorization required for outdoor use and public service
France	Outdoor use limited to 10 mW e.i.r.p. within the band 2454-2483.5 MHz	Military Radiolocation use. Refarming of the 2.4 GHz band has been ongoing in recent years to allow current relaxed regulation. Full implementation planned 2012
Italy		If used outside of own premises, general authorization is required
Luxembourg	None	General authorization required for network and service supply(not for spectrum)
Norway	Implemented	This subsection does not apply for the geographical area within a radius of 20 km from the centre of Ny-Ålesund
Russian Federation		Only for indoor applications

Note: Please don't use the product outdoors in France.

**DECLARATION OF CONFORMITY**

For the following equipment:

Product Description: **54M Wireless Access Point**

Model No.: **TL-WA500G**

Trademark: **TP-LINK**

We declare under our own responsibility that the above products satisfy all the technical regulations applicable to the product within the scope of Council Directives:

Directives 1999/5/EC

The above product is in conformity with the following standards or other normative documents:

**ETSI EN 300 328 V1.7.1: 2006**

**ETSI EN 301 489-1 V1.8.1:2008 & ETSI EN 301 489-17 V1.3.2:2008**

**EN60950-1:2006**

**EN62311:2008**

Directives 2004/108/EC

The above product is in conformity with the following standards or other normative documents

**EN 55022:2006+A1:2007**

**EN 55024:1998+A1:2001+A2:2003**

**EN 61000-3-2:2006**

**EN 61000-3-3:1995+A1:2001+A2:2005**

Directives 2006/95/EC

The above product is in conformity with the following standards or other normative documents

**EN60950-1:2006**

Person is responsible for marking this declaration:



**Zhao Jianjun**

**Director of International Business**





# CONTENTS

<b>Package Contents .....</b>	<b>1</b>
<b>Conventions .....</b>	<b>1</b>
<b>Overview of This Guide .....</b>	<b>2</b>
<b>Chapter 1 Introduction.....</b>	<b>3</b>
1.1 Product Overview.....	3
1.2 Main Features .....	4
1.3 Appearance.....	5
1.3.1 The Front Panel.....	5
1.3.2 The Rear Panel.....	6
<b>Chapter 2 Hardware Installation .....</b>	<b>7</b>
2.1 Before You Begin.....	7
2.2 Basic Requirements.....	7
2.3 Connecting the Device.....	7
<b>Chapter 3 Configure PC.....</b>	<b>9</b>
<b>Chapter 4 Configure the Device.....</b>	<b>13</b>
4.1 Login .....	13
4.2 Status .....	13
4.3 Network.....	15
4.4 Wireless .....	16
4.4.1 Basic Settings .....	16
4.4.2 Wireless Mode .....	17
4.4.3 Survey.....	22
4.4.4 Security Settings.....	23
4.4.5 MAC Filtering .....	27
4.4.6 Wireless Statistics.....	29
4.5 DHCP .....	30
4.5.1 DHCP Settings.....	30
4.5.2 DHCP Clients List.....	32
4.5.3 Address Reservation .....	32
4.6 Wireless Settings .....	33
4.7 System Tools .....	34
4.7.1 Firmware.....	35
4.7.2 Factory Defaults.....	36
4.7.3 Backup & Restore.....	36

4.7.4	Reboot .....	37
4.7.5	Password .....	37
4.7.6	SysLog .....	38
<b>Appendix A: Application Example .....</b>		<b>39</b>
<b>Appendix B: Factory Defaults .....</b>		<b>42</b>
<b>Appendix C: Troubleshooting .....</b>		<b>43</b>
<b>Appendix D: Specifications .....</b>		<b>44</b>
<b>Appendix E: Glossary .....</b>		<b>45</b>

# Package Contents

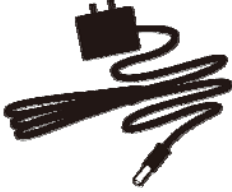
The following items should be found in your package:

	TL-WA500G 54Mbps Wireless Access Point
	Resource CD, including: <ul style="list-style-type: none"><li>● This User Guide</li><li>● Other Helpful Information</li></ul>
	Power Adapter for TL-WA500G 54Mbps Wireless Access Point
	Two Ethernet Cables

 **Note:**

Make sure that the package contains the above items. If any of the listed items are damaged or missing, please contact your distributor.

## Conventions

The AP or TL-WA500G, or device mentioned in this User guide stands for TL-WA500G 54M Wireless Access Point without any explanations.

Parameters provided in the pictures are just references for setting up the product, which may differ from the actual situation.

You can set the parameters according to your demand.



## Overview of This Guide

<b>Package Contents:</b>	Tells what are contained in the box.
<b>Chapter 1 Introduction:</b>	Gives an introduction for the TL-WA500G Wireless Access Point.
<u>1.1 Product Overview:</u>	Introduces advantages of using this AP.
<u>1.2 Main Feature:</u>	Introduces main features and their benefits.
<u>1.3 Appearance:</u>	Gives descriptions of LEDs, ports and buttons on the front and rear panel.
<b>Chapter 2 Hardware Installation:</b>	Tells how to connect the AP and the requirements.
<u>2.1 Before You Begin:</u>	Gives suggestions for better performance of the wireless network.
<u>2.2 Basic Requirement:</u>	Introduces some basic requirements for successful installation and long-term use
<u>2.3 Connecting the Device:</u>	Introduces steps to connect the AP.
<b>Chapter 3 Configure the PC:</b>	Tells how to configure the IP address of your PC in order to access the AP.
<b>Chapter 4 Configure the Device:</b>	Tells how to configure the AP via the web-based management page.
<u>4.1 Login:</u>	Tells how to log on to the web-based management page.
<u>4.2 Status:</u>	Gives information about the AP's current configuration.
<u>4.3 Network:</u>	Tells how to configure the IP parameters of AP.
<u>4.4 Wireless:</u>	Guides to establish the wireless network in different wireless modes and deploy the security features appropriate to your needs.
<u>4.5 DHCP:</u>	Introduces how to set your AP to be a DHCP server so that the AP will automatically assign an IP address for your PC.
<u>4.6 Wireless Settings:</u>	Allows you to make some advanced configurations for your wireless network.
<u>4.7 System Tools:</u>	Allows you to update the firmware, restore the factory defaults, backup the current version, change the default password, and view the system Log.

# Chapter 1 Introduction

Thank you for choosing the **TL-WA500G 54Mbps Wireless Access Point**.

## 1.1 Product Overview

The TL-WA500G 54M Wireless Access Point is dedicated to Small Office/Home Office (SOHO) wireless network solutions. It allows for greater range and mobility within your wireless network while also allowing you to connect the wireless devices to a wired environment. Increased mobility and the absence of cabling will be beneficial for your network.

Powered by **2x to 3x eXtended Range™ WLAN transmission technology**, TL-WA500G Wireless Access Point provides exceptional transmission distance, which is 2-3 times of traditional IEEE 802.11g and IEEE 802.11b solutions, up to 855.36m tested in China. The transmission range is extended to 4-9 times.

With multiple protection measures, including SSID broadcast control and wireless LAN 64/128/152-bit WEP encryption, WiFi protected Access (WPA2- PSK, WPA- PSK), as well as advanced Firewall protections, the TL-WA500G Wireless Access Point delivers complete data privacy.

It supports an easy, web-based setup for installation and management. Even though you may not be familiar with the Access Point, you can easily configure it with the help of this Guide. Before installing the AP, please look through this Guide to get the full information of the TL-WA500G 54Mbps Wireless Access Point.

## 1.2 Main Features

Features	Benefits
Complies with IEEE802.11g, IEEE802.11b, IEEE802.3, IEEE802.3u standards	PCs with different wireless standards can communicate with each other
Adopts 2x to 3x eXtended Range™	Extends the transmission range for your wireless LAN
Supports 54/48/36/24/18/12/9/6Mbps or 11/5.5/3/2/1Mbps wireless LAN data transfer rates	The AP can auto-negotiate the rate with the wireless devices
Provides multiple encryption security Types including: 64/128/152-bit WEP WPA/WPA2 WPA-PSK/WPA2-PSK	Secures your data while the data packets are being transmitted
Supports Built-in DHCP server	Supports dynamic IP address distributing
Supports MAC address filtering	Allows you to control the access rights of the wireless stations, depending on the stations' MAC addresses
Supports multiple operating modes including: <ul style="list-style-type: none"> <li>● Access Point</li> </ul> <hr style="border-top: 1px dashed #000;"/> <ul style="list-style-type: none"> <li>● Client</li> </ul> <hr style="border-top: 1px dashed #000;"/> <ul style="list-style-type: none"> <li>● Repeater</li> </ul> <hr style="border-top: 1px dashed #000;"/> <ul style="list-style-type: none"> <li>● Bridge (Point to Point, Point to Multi-point)</li> </ul>	Makes the AP an ideal solution for your wireless local area network You can create a wireless local area network <hr style="border-top: 1px dashed #000;"/> Wirelessly connects Ethernet devices <hr style="border-top: 1px dashed #000;"/> Relays signal between its stations and the root AP for greater wireless range <hr style="border-top: 1px dashed #000;"/> Bridges the AP and another AP also in bridge mode to connect two or more wired LANs
Supports Firmware Upgrade	You can easily upgrade the firmware to the latest version through the web-based management page
Supports Remote and Web management	Allows you to manage your wireless LAN easily through the web-based management page, while the management by remote computer is also available

## 1.3 Appearance

### 1.3.1 The Front Panel

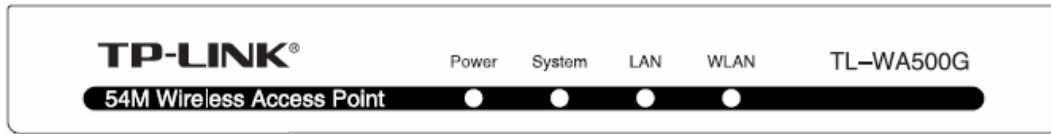

Figure 1-1 TL-WA500G front panel

Viewed from left to right, the TL-WA500G has four status LEDs: Power, System, LAN and WLAN.

LED Explanation

Name	Status	Indication
Power	On	The AP is Powered on
	Off	The AP is Powered off
System	Flashing	The AP is working properly
	Off	The AP has a hard ware error
LAN	On	There is a device linked to the corresponding port but no activity
	Flashing	There is data being transmitted or received wirelessly
	Off	There is no device linked to the corresponding port
WLAN	Flashing	The Wireless Radio function is enabled
	Off	The Wireless Radio function is disabled

 **Note:**

The LEDs' explanation above shows the device's working status after initialization.

### 1.3.2 The Rear Panel

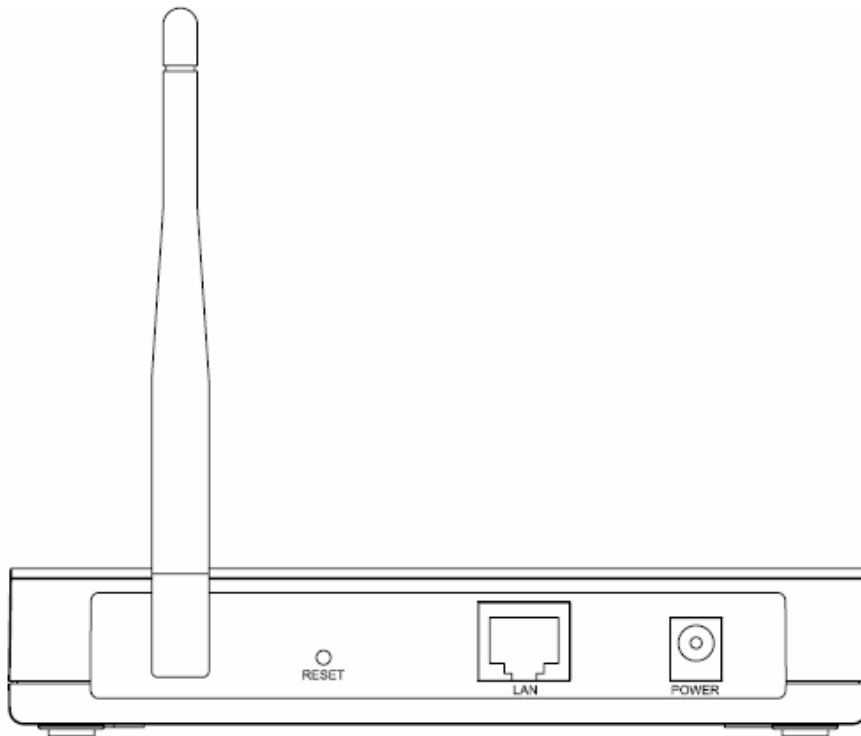

Figure 1-2 TL-WA500G rear panel

Viewed from left to right, the following parts are located on the rear panel of TL-WA500G.

**Wireless antenna:** The external antenna is used to transmit and receive wireless data.

**RESET:** The Reset button is used to restore the AP's factory default settings. There are two ways to reset the Access Point's factory defaults:

- **Method one:** With the Router powered on, use a pin to press and hold the Reset button (about 5 seconds) until the System LED becomes quick-flash from slow-flash. And then release the button and wait the router to reboot to its factory default settings.
- **Method two:** Restore the default settings from "**System Tools > Factory Defaults**" of the Modem's Web-based management page.

 **Note:**

Ensure the AP is powered on before it restarts completely.

**LAN:** One LAN 10/100Mbps RJ45 port connects to a network device, such as a switch or a router.

**POWER:** The power port connects to the power adapter provided with the TL-WA500G 54Mbps Wireless Access Point.

## Chapter 2 Hardware Installation

### 2.1 Before You Begin

Please read this User Guide carefully before installing and using the equipment. The operating distance range of your wireless connection can vary significantly depending on the physical position of the wireless devices. Factors that can weaken signals by getting in the way of your network's radio waves are metal appliances or obstructions, and walls. Typical ranges vary base on the types of materials and background RF (radio frequency) noise in your home or office.

For best performance of your wireless network, you are suggested to:

- 1). Avoid redundant obstacles and interference between the wireless devices.
- 2). Keep your AP away from appliances with a strong electric field or magnetic field, such as a microwave oven or refrigerator.

Place the AP near the center of the area in which your computers operates.

### 2.2 Basic Requirements

- Use only the power adapter provided with your AP
- The electrical outlet shall be installed near the device and shall be easily accessible
- Place your AP in a well ventilated place far from direct sunlight, any heater or heating vent
- Leave at least 2 inches (5cm) space around the device for heat dissipation
- Turn off your AP and unplug the power adapter in a lighting storm to avoid damage
- Web browser, such as Microsoft Internet Explorer 5.0 or above, Netscape Navigator 6.0 or above
- Operating temperature: 0°C~40°C (32°F~104°F)
- Operating Humidity: 10%~90%RH, Non-condensing

### 2.3 Connecting the Device

Figure 2-1 is an example of the typical application of TL-WA500G in the infrastructure network. An Infrastructure network contains an access point or a wireless router.



Figure 2-1 The Example of Infrastructure Network Incorporating the TL-WA500G

To establish a typical connection of the AP, please take the following steps:

1. Connect the Cable or DSL modem to a Router.
2. Locate an optimum location for the AP. The best place is usually near the center of the area in which your PC(s) will wirelessly connect.
3. Adjust the direction of the antenna. Normally, upright is a good direction.
4. Connect the Ethernet Broadband Router to the TL-WA500G Access Point. Power on the AP.
5. Then you can connect a desktop PC or laptop to your network. (Make sure your computer or laptop is equipped with a Wireless Adapter.)

 **Note:**

If you are not so clear about how to connect your devices to the network, please refer to **Appendix A Application Example**.

## Chapter 3 Configure PC

This chapter will guide you to configure your PC to communicate with the AP. The wireless adapter-equipped computers in your network must be in the same IP Address range without overlap with each other. Manually configure the **IP address** as 192.168.1.\* (\* is any integer between 1 to 253), the **Subnet mask** as 255.255.255.0, and the **Default gateway** as 192.168.1.254 for your PC by following the instructions below.

Connect the local PCs to the LAN ports on the AP and configure the IP address manually for your PCs.

1. Click **Start** (in the lower left corner of the screen), right-click **My Network Connections** and choose **Properties**.

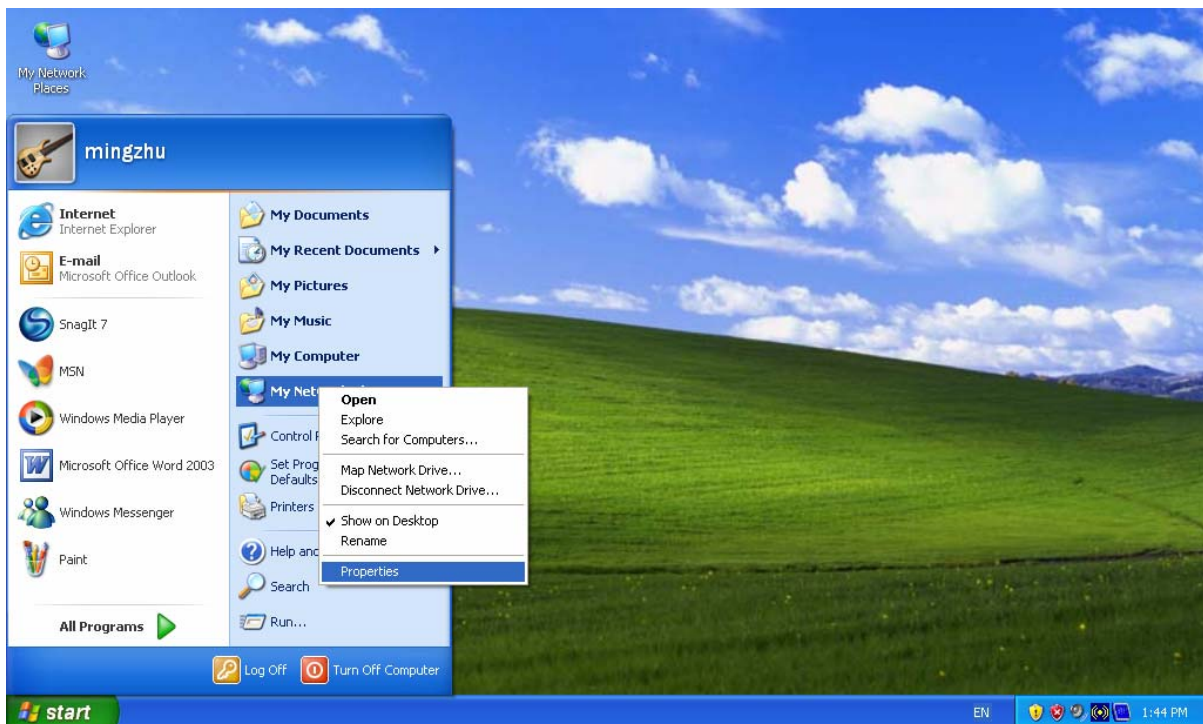

Figure 3-1

2. On the **My Network Connections** window shown as Figure 3-2 below, right-click **LAN (Local Area Connection)** and choose **Properties**.



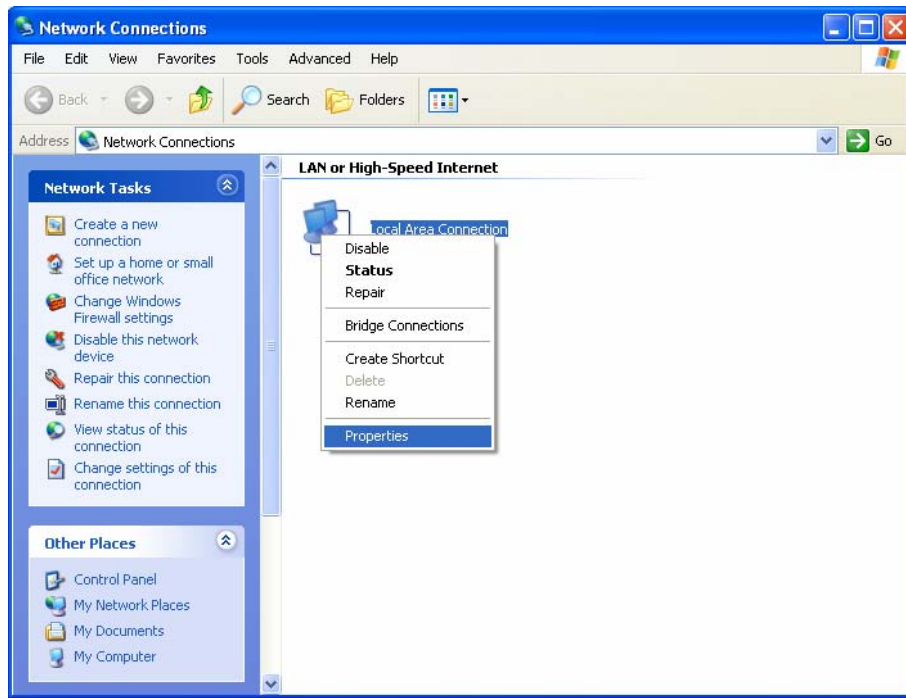

Figure 3-2

3. In the **General** tab of **Internet Protocol (TCP/IP) Properties** window, highlight **Internet Protocol (TCP/IP)** and click **Properties**.

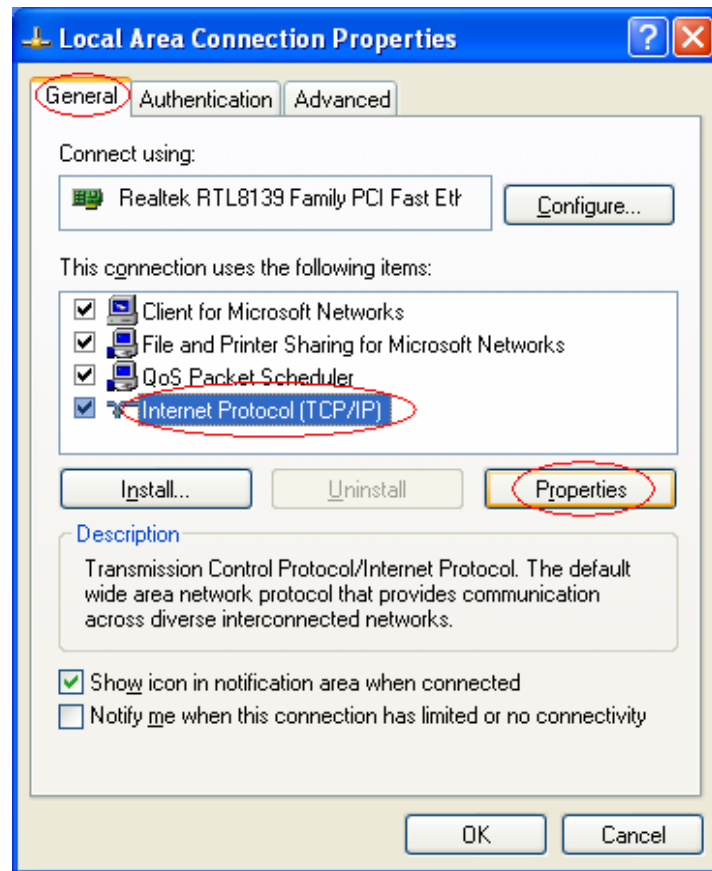

Figure 3-3

4. Configure the IP address manually.

- a) Select **Use the following IP address**.
- b) Enter 192.168.1.\* (\* is any integer between 1 to 253) into the **IP address** filed, 255.255.255.0 into the **Subnet mask** filed and 192.168.1.254 into the **Default gateway** filed.
- c) Click **Ok** to keep your settings.

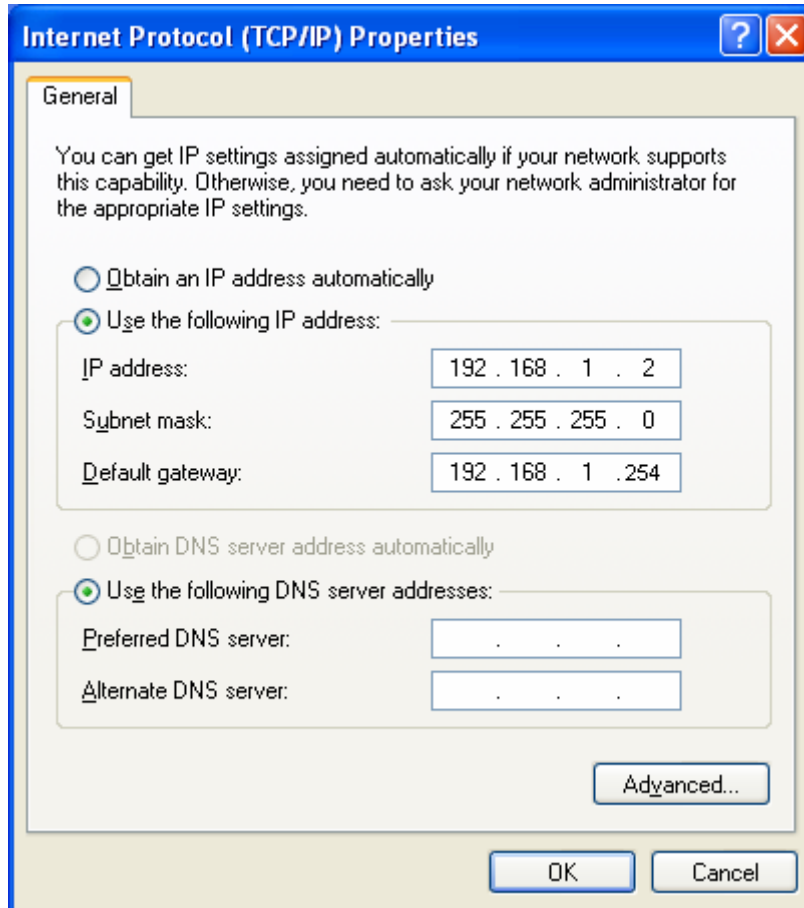

Figure 3-4

- 1) Open TCP/IP Properties of the LAN card in your PC, enter the IP address as 192.168.1.\* (\* is any value between 1 to 253, Subnet mask is 255.255.255.0, Gateway is 192.168.1.254, DNS address is the value provided by ISP).
- 2) Now, you can run the Ping command in the command prompt to verify the network connection between your PC and the AP. The following example is in Windows XP Operating System.
- 3) Open a command prompt, From the Start menu on your desktop, select run tab, type **cmd** in the field, and type *ping 192.168.1.254* on the screen that appears, and then press **Enter**.

If the result displayed is similar to that shown in Figure below, the connection between your PC and the AP has been established.

```
Pinging 192.168.1.254 with 32 bytes of data:

Reply from 192.168.1.254: bytes=32 time<1ms TTL=64
Reply from 192.168.1.254: bytes=32 time<1ms TTL=64
Reply from 192.168.1.254: bytes=32 time<1ms TTL=64
Reply from 192.168.1.254: bytes=32 time<1ms TTL=64

Ping statistics for 192.168.1.254:
    Packets: Sent = 4, Received = 4, Lost = 0 (0% loss),
Approximate round trip times in milli-seconds:
    Minimum = 0ms, Maximum = 0ms, Average = 0ms
```

Figure 3-5

If the result displayed is similar to that shown in Figure below, it means that your PC has not connected to the AP.

```
Pinging 192.168.1.254 with 32 bytes of data:

Request timed out.
Request timed out.
Request timed out.
Request timed out.

Ping statistics for 192.168.1.254:
    Packets: Sent = 4, Received = 0, Lost = 4 (100% loss),
```

Figure 3-6

Please check following these steps:

- 1). Check to see if your PC and the AP are right connected. The LED of LAN port which you link to on the device and the LED on your PC's adapter should be lit up.
- 2). Make sure the TCP/IP for your PC is right configured. If the AP's IP address is 192.168.1.254, your PC's IP address must be within the range of 192.168.1.1 ~ 192.168.1.253.

## Chapter 4 Configure the Device

This Chapter describes how to configure your Access Point via the web-based management page. The TL-WA500G 54Mbps Wireless Access Point is easy to configure and manage with the Web-based ( Internet Explorer, Netscape® Navigator, Firefox, Safari, Opera or Chrome) management page, which can be launched on any windows, Macintosh or UNIX OS with a web browser.

### 4.1 Login

Open your web browser. Type in IP address `http://192.168.1.254` in the address field of web browser and press Enter.



Figure 4-1 Login to the AP

Enter admin for the User Name and Password (both in lower case letters) in Figure.4-2 below. Then click OK or press Enter.

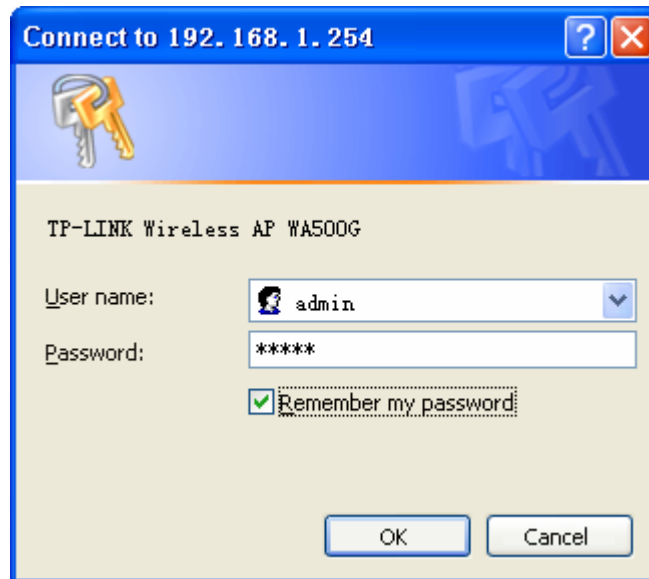

Figure 4-2 Login Windows

#### Note:

If the above screen does not prompt, it means that your web-browser has been set to a proxy. Go to **Tools menu>Internet Options>Connections>LAN Settings**, in the screen that appears, cancel the **Using Proxy** checkbox, and click **OK** to finish it.

After a successful login, you can configure and manage the AP. There are six main menus on the leftmost column of the web-based management page: **Status**, **Network**, **Wireless**, **DHCP**, **Wireless Settings** and **System Tools**. Submenus will be available after clicking one of the main menus. On the right of the web-based management page lies the detailed explanations and instructions for the corresponding page.

### 4.2 Status

Selecting **Status** will enable you to view the AP's current status and configuration, all of which is read-only.

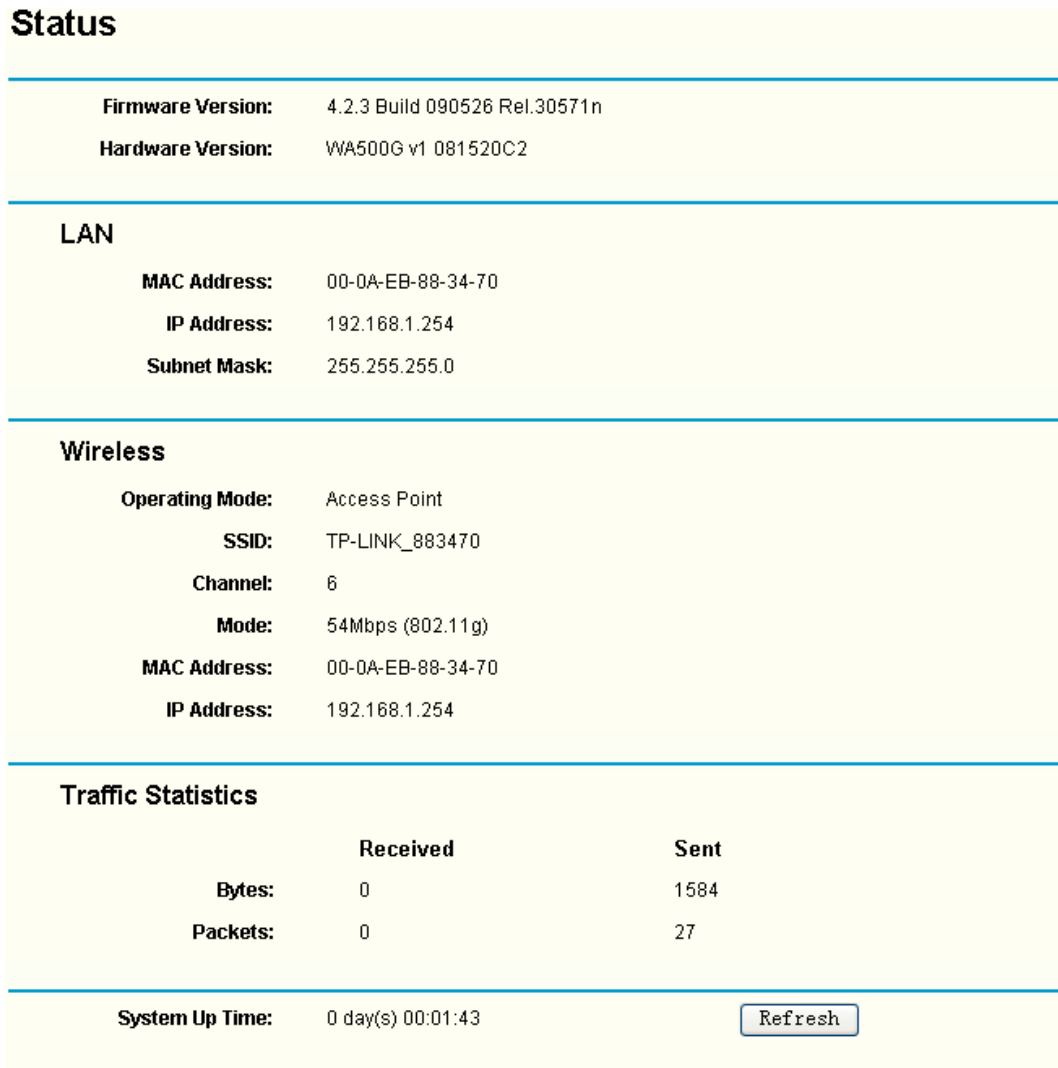

Figure 4-3 AP Status

- **Firmware Version** - This field displays the current firmware version of the AP.
- **Hardware Version** - This field displays the current hardware version of the AP
- **LAN** - This field displays the current settings or information for the Network, including the **MAC address**, **IP address** and **Subnet Mask**.
- **Wireless** - This field displays basic information or status for wireless function, including **Operating Mode**, **SSID**, **Channel**, **Mode**, **MAC Address** and **IP Address**.
- **Traffic Statistics** - This field displays the AP's traffic statistics.
- **System Up Time** - This field displays the run time of the AP since it's powered on or reset.

**Note:**

If you select client mode in Figure 4-7 the wireless status in Figure 4-3 will change, as it showed below:

Wireless	
<b>Operating Mode:</b>	Client
<b>Signal:</b>	
<b>SSID:</b>	TP-LINK_883470
<b>Channel:</b>	4
<b>Mode:</b>	11Mbps (802.11b)
<b>MAC Address:</b>	00-0A-EB-88-34-70
<b>IP Address:</b>	192.168.1.254

### 4.3 Network

The **Network** option allows you to customize your local network manually by changing the default settings of the AP.

Selecting **Network** will enable you to configure the IP parameters of Network on this page.

LAN	
<b>Type:</b>	Static IP
<b>IP Address:</b>	192.168.1.254
<b>Subnet Mask:</b>	255.255.255.0
<b>Gateway:</b>	0.0.0.0
<b>MAC Address:</b>	00-0A-EB-88-34-70

Save

Figure 4-4 Network

- **Type** - Select **Dynamic IP** to get IP address from DHCP server or select **Static IP** to configure IP address manually from the drop-down list.
- **IP Address** - Enter the IP address of your AP in dotted-decimal notation (factory default setting is 192.168.1.254).
- **Subnet Mask** - An address code that determines the size of the network. Normally use 255.255.255.0 as the subnet mask.
- **Gateway** - The gateway should be in the same subnet with your IP address.
- **MAC Address** - The physical address of the AP. The value can't be changed.

 **Note:**

If you change the IP Address, you must use the new IP Address to login the AP.

If the new LAN IP Address you set is not in the same subnet, the IP Address pool in the DHCP sever will not take effect, until they are re-configured.

## 4.4 Wireless

The **Wireless** option, improving functionality and performance for wireless network, can help you make the AP an ideal solution for your wireless network. Here you can create a wireless local area work just through a few settings. With three different security types, the AP can secure your data and provide greater security for your wireless network. MAC filtering allows you to control wireless stations accessing the AP and Wireless Statistics enables you to get detailed information about the current connected wireless stations.

There are five submenus under the Wireless menu (shown in Figure 4-5): **Basic Settings**, **Wireless mode**, **Security Settings**, **MAC Filtering** and **Wireless Statistics**. Clicking any of them will enable you to configure the corresponding function. The detailed explanations for each submenu are provided below.



Figure 4-5 The Wireless menu

### 4.4.1 Basic Settings

Selecting **Wireless > Basic Settings** will enable you to configure the basic settings for your wireless network on the screen below (Figure 4-6).

 A screenshot of a web configuration page titled "Wireless Settings". The page has a light yellow background. At the top, the title "Wireless Settings" is in bold black font. Below the title, there are several configuration fields:
 

- SSID:** A text input field containing "TP-LINK\_883470".
- Region:** A dropdown menu showing "United States".
- Warning:** A text block that reads: "Warning: Ensure you select a correct country to conform local law. Incorrect settings may cause interference."
- Channel:** A dropdown menu showing "6".
- Mode:** A dropdown menu showing "54Mbps (802.11g)".

 At the bottom of the form, there is a "Save" button.

Figure 4-6 Wireless Settings

- **SSID** (Set Service Identifier) - Identifies your wireless network name. Create a name up to 32 characters and make sure all wireless points in the wireless network with the same SSID. The default SSID is TP-LINK\_XXXXXX (XXXXXX indicates the last unique six characters of each device's MAC address). This value is case-sensitive. For example, *TP-LINK* is NOT the same as *tp-link*.
- **Channel** - Determines the operating frequency to be used. It is not necessary to change the wireless channel unless you notice interference problems with another nearby access point.

- **Mode** - Select the desired wireless mode. The options are:
  - **54Mbps (802.11g)** - Both 802.11g and 802.11b wireless stations can connect to the AP.
  - **11Mbps (802.11b)** - Only 802.11b wireless stations can connect to the AP.
- **Region** - Specifies the region where the wireless function of the AP can be used. Select your region from the drop-down list. If your country or region is not listed, please contact your local government agency for assistance.

 **Note:**

The default region is United States. When you select your local region from the pull-down list, the dialog shown in Figure appears below. Click OK.

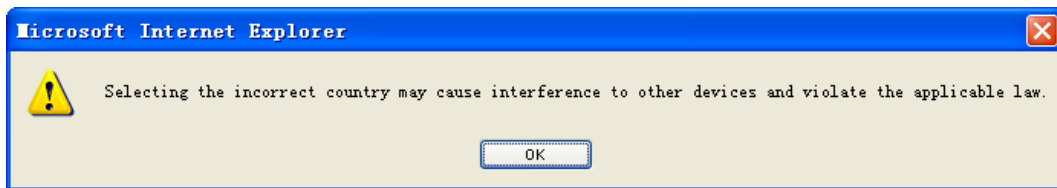

 **Note:**

Restricted by local law regulations, version for North America does not have region selection option. The wireless basic settings for this version are shown below.

## Wireless Settings

<b>SSID:</b>	TP-LINK_883470
<b>Channel:</b>	6
<b>Mode:</b>	54Mbps (802.11g)
<input type="button" value="Save"/>	

 **Note:**

To apply any settings you have altered on the page, please click the **Save** button, and wait the AP reboot automatically.

### 4.4.2 Wireless Mode

Selecting **Wireless > Wireless Mode** will enable you to set up the wireless mode for your wireless network appropriate to your needs on the screen below.



### Wireless Mode Settings

---

**Disable Wireless**

**Access Point**  
 Enable SSID Broadcast

**Client**  
 Enable WDS  
 **SSID:**   
 **MAC of AP:**

**Repeater**  
**MAC of AP:**

**Universal Repeater**  
**MAC of AP:**

**Bridge (Point to Point)**  
 With AP Mode  
**MAC of AP:**

**Bridge (Point to Multi-Point)**  
 With AP Mode  
**MAC of AP1:**   
**MAC of AP2:**   
**MAC of AP3:**   
**MAC of AP4:**   
**MAC of AP5:**   
**MAC of AP6:**

---

**Note:** The current security method may be invalid after changing the wireless mode.

Figure 4-7 Wireless Mode Settings

- **Disable Wireless** - Selecting the radio button before **Disable Wireless** will deny wireless stations access. The wireless of this AP can be enabled or disabled to allow wireless stations access. If disabled, wireless stations will not be able to access the AP.

The AP provides five operating modes: Access Point, Client, Repeater, Bridge (point to point), Bridge (point to Multi-point).

 **Note:**

AP provides five operational modes: Access Point, Client, Repeater, Bridge (point to point), Bridge (point to Multi-point).

- **Access Point** - The **Access Point** mode allows wireless stations including AP clients to access.
  - **Enable SSID Broadcast** - Checking the **Enable SSID Broadcast** box will enable Wireless Access Point to broadcast its name (SSID).
- **Client** - The **Client** mode allows one or more remote LANs to connect a central LAN, and thus creating an extended virtual LAN. In this way, any station of the Remote LAN can successfully communicate with any station of the central LAN, as if all of them belong to the same physical LAN. Wireless Stations can't associate with AP Clients.
  - **Enable WDS** - Checking the **Enable WDS** (Wireless Distribution System) box will forward all traffic from wired networks in the format of WDS frames consist of four address fields. The AP client can connect to AP with WDS enabled or disabled. If WDS is disabled, three address frames are used. If your AP supports WDS well, please select the option.
  - **SSID** - Enter the SSID of AP that you want to access. If you select the radio button before **SSID**, the AP client will connect to AP according to SSID.
  - **MAC of AP** - Enter the MAC address of AP that you want to access. If you select the radio button before **MAC of AP**, the AP client will connect to AP according to MAC address.
- **Repeater** - The wireless **Repeater** mode allows the AP with its own BSS and with WDS enabled to relay data to a root AP, to which it is associated. The wireless repeater relays signal between its stations and the root AP for greater wireless range. Please input the MAC address of root AP in the field of **MAC of AP**.
- **Universal Repeater** - The **Universal Repeater** mode allows APs without WDS function to be communicated with.

 **Note:**

If the available AP can't support with WDS, you may select Client mode without WDS or Universal Repeater mode to associate with the AP.

Here is an example of how to configure wireless repeater.

1. Configure the Operating Mode of the TL-WA500G Access Points.
  - Configure AP1 on LAN Segment 1 in Access Point mode.
  - Configure AP2 in Repeater mode with the MAC address of its root AP (AP1).
  - Configure AP3 in Repeater mode with the MAC address of its root AP (AP2).

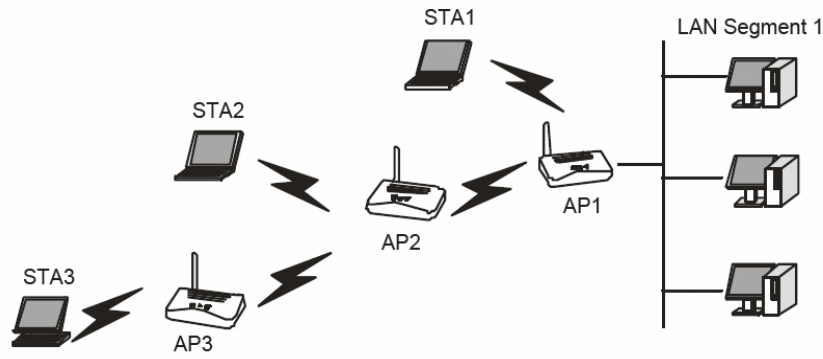

Figure 4-8 Wireless repeating

2. Verify the wireless security parameters for all access points, if any.
3. Verify connectivity across the LANs. A computer on any LAN segment should be able to connect to the Internet or share files and printers with any other PCs or servers connected to any of the three WLAN segments.

**Note:**

You can extend this repeating by adding up to 2 additional TL-WA500Gs configured in repeater mode. However, since Repeater configurations communicate in half-duplex mode, the bandwidth decreases as you add Repeaters to the network. Also, you can extend the range of the wireless network with wireless antenna accessories.

- **Bridge (Point to Point)** - This **Point to Point** mode allows the AP to bridge another AP also in bridge mode to connect two wired LANs. Please input the MAC address of the other AP in the field of MAC of AP.
  - **With AP mode:** Checking **With AP mode** box will make your AP support AP mode as well when it is in Bridge (Point to Point) mode.

Here is an example of how to configure Point-to-Point Bridge.

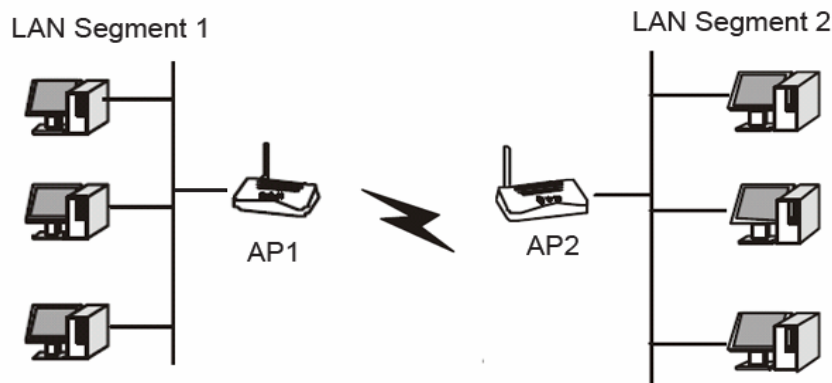

Figure 4-9 Point to Point Bridge

1. Configure the TL-WA500G (AP1) on LAN Segment 1 in Point-to-Point Bridge mode.
2. Configure the TL-WA500G (AP2) on LAN Segment 2 in Point-to-Point Bridge mode. AP1 must have AP2's MAC address in its MAC Address field and AP2 must have AP1's MAC address in its MAC Address field.
3. Configure and verify the following parameters for both access points:

- Both use the same Channel and security settings if security is in use.
  - Verify connectivity across the LAN 1 and LAN 2. A computer on either LAN segment should be able to connect to the Internet or share files and printers of any other PCs or servers connected to LAN Segment 1 or LAN Segment 2.
- **Bridge (Point to Multi-Point)** - This mode allows the AP to bridge up to 6 APs also in bridge mode to connect two or more wired LANs. Please input the MAC address of other APs in the field of MAC of AP1 to MAC of AP6.
- **With AP mode:** Checking **With AP mode** box will make your AP support AP mode as well when it is in Bridge (Point to Multi-Point) mode.

Here is an example of how to configure multi-point bridging.

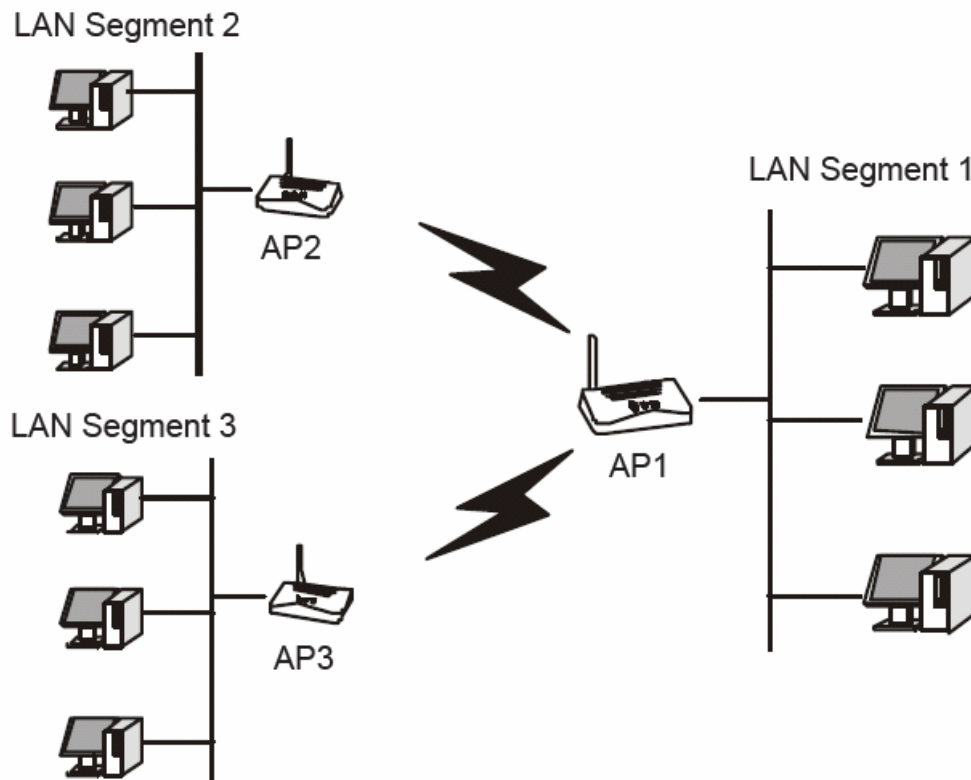

Figure 4-10 Point to Multi-point Bridge

1. Configure the Operating Mode of the TL-WA500G Access Points.
  - Because it is in the central location, configure TL-WA500G (AP1) on LAN Segment 1 in Point-to-Multi-Point Bridge mode. The MAC addresses of AP2 and AP3 are required in AP1.
  - Configure TL-WA500G (AP2) on LAN Segment 2 in Point-to-Point Bridge mode with the MAC Address of AP1.
  - Configure the TL-WA500G (AP3) on LAN 3 in Point-to-Point Bridge mode with the MAC Address of AP1.
2. Verify the following parameters for all access points.
  - All TL-WA500G Access Points use the same Channel, and security settings if any.
  - All Point-to-Point APs must have AP1's MAC address in its AP MAC address field, and

AP1 must have all All Point-to-Point APs' MAC addresses.

3. Verify connectivity across the LANs.

- A computer on any LAN segment should be able to connect to the Internet or share files and printers with any other PCs or servers connected to any of the three LAN segments.
- Wireless stations will not be able to connect to the TL-WA500G Access Points in the illustration above. If you require wireless stations to access any LAN segment, you can add TL-WA500G Access Points configured in Wireless Access Point mode to any LAN segment.

 **Note:**

You can extend this multi-point bridging by adding additional TL-WA500Gs configured in Point-to-Point mode for each additional LAN segment. Furthermore, you can extend the range of the wireless network with wireless antenna accessories.

 **Note:**

To apply any settings you have altered on the page, please click the **Save** button, and wait the AP reboot automatically.

### 4.4.3 Survey

After selecting a mode and pressing button **Survey** on the Figure 4-7 you can view all of APs around you on this page.

## AP List

---

AP Count: 3

ID	BSSID	SSID	Signal	Channel	Security	Choose
1	00-19-77-75-67-88	TP-LINK	25 dB	6	OFF	<a href="#">Connect</a>
2	00-18-84-A3-C1-51	TP-LINK_137B00	29 dB	6	OFF	<a href="#">Connect</a>
3	00-18-84-A3-C1-52	TP-LINK	32 dB	6	ON	<a href="#">Connect</a>

Figure 4-11 AP List

- **ID** - Here displays the index of the entry.
- **SSID** - Here displays the SSID of the AP.
- **BSSID** - Here displays the BSSID of the AP, usually also the MAC address of the AP.
- **Signal** - Here displays the signal received from the AP.
- **Channel** - Here displays the channel the AP works in.
- **Security** - Here displays the AP communicates in privacy.
- **Choose** - Choose one AP from the list to connect to.

Click **Connect** to select the desired AP to communicate with, and then the basic settings will show again. Click **Save** and wait for the AP to reboot automatically. The changes won't take effect until the AP is rebooted.

**Note:**

If wireless is disabled, surveying can't work. And if Access Point mode is selected, there is no reason and no choice to connect to another AP, as it showed below.

## AP List

AP Count: 2

ID	BSSID	SSID	Signal	Channel	Security
1	00-0C-43-30-52-E0	TP-LINK_137B00	27 dB	6	OFF
2	00-19-BE-1F-FE-F0	TP-LINK	33 dB	6	ON

Refresh

### 4.4.4 Security Settings

Selecting **Wireless > Security Settings** will enable you to configure wireless security for your wireless network to protect your data from intruders. The AP provides three security types: WEP, WPA/WPA2 and WPA-PSK/WPA2-PSK. Wireless security can be set on the following screen shown as Figure 4-12.

## Wireless Security

**Disable Security**  
 **WEP**

Type:   
 WEP Key Format:

Key Selected	WEP Key	Key Type
Key 1: <input checked="" type="radio"/>	<input type="text"/>	Disabled <input type="text"/>
Key 2: <input type="radio"/>	<input type="text"/>	Disabled <input type="text"/>
Key 3: <input type="radio"/>	<input type="text"/>	Disabled <input type="text"/>
Key 4: <input type="radio"/>	<input type="text"/>	Disabled <input type="text"/>

**WPA/WPA2**

Version:   
 Encryption:   
 Radius Server IP:   
 Radius Port:  (1-65535, 0 stands for default port 1812)  
 Radius Password:   
 Group Key Update Period:  (in second, minimum is 30, 0 means no update)

**WPA-PSK/WPA2-PSK**

Version:   
 Encryption:   
 PSK Passphrase:   
 (The Passphrase is between 8 and 63 characters long)  
 Group Key Update Period:  (in second, minimum is 30, 0 means no update, only be valid in AP mode.)

**Note:** Some security mode can not be selected since it can not be supported by the current wireless mode.

Figure 4-12 Wireless Securities

- **Disable Security** - Selecting the radio button before **Disable Security** will allow the wireless stations to connect the AP without encryption. It is strongly recommended that you uncheck the box and choose one of following security types to enable security for your wireless network.

## WEP

Wired Equivalent Privacy, a data privacy mechanism based on a 64/128/152-bit shard key algorithm, as described in the IEEE 802.11 standard, can provide security by encrypting data over your wireless network so that it is protected as it is transmitted from one wireless device to another. Selecting the radio button before **WEP** to secure your wireless network.

Figure 4-13 WEP

- **Type** - Select one of following types from the drop-down list:
  - **Automatic** - Select Shared Key or Open System authentication type automatically based on the wireless station's capability and request.
  - **Shared Key** - Select 802.11 Shared Key authentication.
  - **Open System** - Select 802.11 Open System authentication.
- **WEP Key Format** -Select ASCII or Hexadecimal format from the drop-down list.
  - **ASCII** - Stands for any combination of keyboard characters in the specified length. When selecting this format, you must create keys to the **WEP Key** fields with ASCII characters.
  - **Hexadecimal** - Stands for any combination of hexadecimal digits (0-9, a-f, A-F) in the specified length. When selecting this format, you must create keys to the **WEP Key** fields with hexadecimal digits.
- **WEP Key settings** - Select the radio button before a key of the **Key Selected** and enter the matching WEP key information for your network. These values must be identical on all wireless stations in your network.
- **Key Type** - Select the WEP key length (64-bit, or 128-bit, or 152-bit.) for encryption. "Disabled" means this WEP key entry is invalid.
  - **For 64-bit encryption** - Enter 10 hexadecimal digits (any combination of 0-9, a-f, A-F, zero key is not permitted) or 5 ASCII characters.
  - **For 128-bit encryption** - Enter 26 hexadecimal digits (any combination of 0-9, a-f, A-F, zero key is not permitted) or 13 ASCII characters.
  - **For 152-bit encryption** -Enter 32 hexadecimal digits (any combination of 0-9, a-f, A-F, zero key is not permitted) or 16 ASCII characters.

**Note:**

If you do not set the key, the wireless security function is still disabled even if you have selected Shared Key as Authentication Type.

## WPA/WPA2

Wi-Fi Protected Access, improves the features of WEP through adopting the TKIP (Temporal Key Integrity Protocol).WPA/WPA2 authenticates your wireless connecting through the EAP (Extensible Authentication Protocol). EAP, built on a more secure public key encryption system, can ensure that only authorized network users can access the network and protect your network from intruders. Selecting the radio button before **WPA/WPA2** to secure your wireless network, but you should set up a Radius Server first.



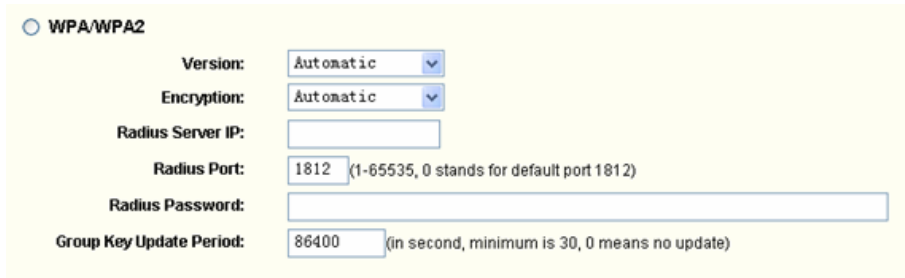

Figure 4-14 WPA/WPA2

- **Version** - Select one of following versions from the drop-down list:
  - **Automatic** - Select WPA or WPA2 automatically based on the wireless station's capability and request.
  - **WPA** - Wi-Fi Protected Access.
  - **WPA2** - WPA version 2.
- **Encryption** - Select Automatic, TKIP or AES from the drop-down list.
  - **Automatic** - Select TKIP or AES automatically based on the wireless station's capability and request.
  - **TKIP** - Temporal Key Integrity Protocol.
  - **AES** - Advanced Encryption Standard.
- **Radius Server IP** - Enter the IP address of the Radius Server.
- **Radius Port** - Enter the port that radius service used.
- **Radius Password** - Enter the password for the Radius Server.

## WPA-PSK/ WPA2-PSK

Pre-shared key of WPA, WPA-PSK/WPA2-PSK uses a password or key to authenticate your wireless connection. The key is an alpha-numeric password between 8 and 63 characters long. The password can include symbols(!?\*\_) and spaces. This key must be identical for your wireless Access Point. Selecting the radio button before **WPA-PSK/WPA2-PSK** to secure your wireless network based on pre-shared passphrase.

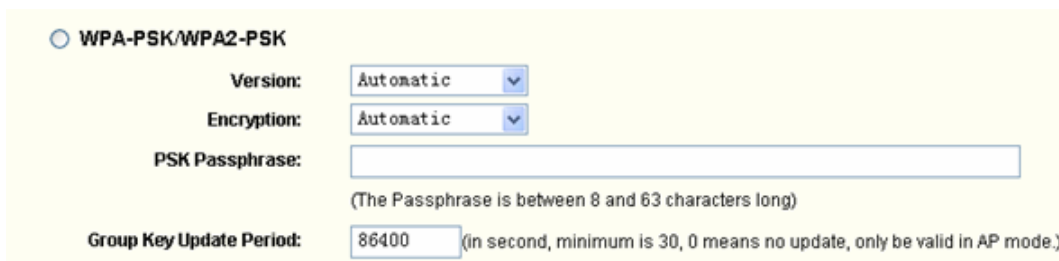

Figure 4-15 WPA-PSK/WPA2-PSK

- **Version** - Select one of following versions from the drop-down list:
  - **Automatic** - Select WPA-PSK or WPA2-PSK automatically based on the wireless station's capability and request.
  - **WPA-PSK** - Pre-shared key of WPA.

- **WPA2-PSK** - Pre-shared key of WPA2.
- **PSK Passphrase** - Enter a passphrase with 8-63 characters.
- **Group Key Update Period** - Specify the group key update interval in seconds. The value can be either 0 or at least 30. Enter 0 to disable the update.

Be sure to click **Save** to save your settings on this page.

 **Note:**

The AP will reboot automatically after you click the **Save** button.

### 4.4.5 MAC Filtering

Selecting **Wireless > MAC Filtering** will allow you to set up some filtering rules to control wireless stations accessing the AP, which depend on the station’s MAC address on the following screen as shown Figure 4-16.

Figure 4-16 Wireless MAC address Filtering

If you want to enable the **Wireless MAC Address Filtering** feature, please click **Enable**; otherwise, keep the default setting of **Disabled**. If you desire the unspecified wireless stations can access the AP, please select **Allow the stations not specified by any entries in the list to access**, otherwise, please select **Deny the stations not specified by any enabled entries in the list to access**.

Figure 4-17 Add or Modify Wireless MAC Address Filtering entry

- **MAC Address** - Enter MAC address of wireless station that you want to filter. The format of the MAC Address is XX-XX-XX-XX-XX-XX (X is any hexadecimal digit). For example: 00-0A-EB-B0-00-0B.
- **Description** - Give a simple description of the wireless station. For example: Wireless station A.
- **Privilege** - Select **Allow**, **Deny** from the drop-down list. **Allow** means allowing the station to access the AP. **Deny** means denying the station to access the AP.
- **Status** - Select **Enabled** or **Disabled** for this entry from the drop-down list. To enable the above settings, please select **Enabled**. Otherwise, select **Disabled**.

Click **Save** to save this entry.

**To modify or delete an existing entry:**

1. Click **Edit** or **Delete** in the **Modify** column in the **Wireless MAC Address Filtering** Table.
2. Enter the value as desired in the **Add or Modify Wireless MAC Address Filtering** entry page, and click **Save**.

Click **Enable All** to make all the entries effective.

Click **Disable All** to make all the entries ineffective.

Click **Delete All** to delete all the entries.

Click **Next** to go to the next page.

Click **Previous** to return to the previous page.

**For example:**

If you desire that the wireless station A with MAC address 00-0A-EB-00-07-BE be able to access the AP, the wireless station B with MAC address 00-0A-EB-00-07-5F not be able to access the AP, while all other wireless stations cannot access the AP, you should configure the **Wireless MAC Address Filtering** list following these steps:

1. Click **Enable** to enable this function.
2. Select the radio button: **Deny the stations not specified by any enabled entries in the list to access for Filtering Rules**.
3. Delete all or disable all entries if there are any entries existing already.
4. Click **Add New...** and enter the MAC address 00-0A-EB-00-07-BE in the **MAC Address** field, enter wireless station A in the **Description** field, select **Allow** in the **Privilege** drop-down list and select **Enabled** in the **Status** pull-down list. Click **Save** and **Back**.
5. Repeat step 4 using the MAC address 00-0A-EB-00-07-5F instead of 00-0A-EB-00-07-BE.

After finishing the above steps, you can see the filtering rules you configured are similar to the following list as in figure

### Wireless MAC Address Filtering

Wireless MAC Address Filtering: **Enabled**

---

#### Filtering Rules

Allow the stations not specified by any enabled entries in the list to access  
 Deny the stations not specified by any enabled entries in the list to access

ID	MAC Address	Status	Privilege	Description	Modify
1	00-0A-EB-00-07-BE	Enabled	allow	wireless station A	<a href="#">Modify</a> <a href="#">Delete</a>
2	00-0A-EB-00-07-5F	Enabled	deny	wireless station B	<a href="#">Modify</a> <a href="#">Delete</a>

---

Figure 4-18 Add or Modify Wireless MAC Address Filtering entry

**Note:**

If you select the radio button **Allow the stations not specified by any enabled entries in the list to access** for **Filtering Rules**, the wireless station B will still not be able to access the AP, however, other wireless stations that are not in the list will be able to access the AP. If you enable the function and select the **Deny the stations not specified by any enabled entries in the list to access** for **Filtering Rules**, and there are not any enable entries in the list, thus, no wireless stations can access the AP.

#### 4.4.6 Wireless Statistics

Selecting **Wireless > Wireless Statistics** will enable you to view **MAC Address**, **Current Status**, **Received Packets** and **Sent Packets** for each connected wireless station.

### Wireless Statistics

Current Connected Wireless Stations numbers: **1**

ID	MAC Address	Current Status	Received Packets	Sent Packets
1	00-0A-EB-86-46-2C	AP-UP	3	609

---

Figure 4-19 The AP attached wireless stations

- **MAC Address** - Here displays MAC address of the connected wireless station.
- **Current Status** - Running status of the connected wireless station, one of STA-AUTH / STA-ASSOC / STA-JOINED / WPA / WPA-PSK / WPA2 / WPA2-PSK / AP-UP / AP-DOWN / Disconnected.
- **Received Packets** - Packets received by the station.

➤ **Sent Packets** - Packets sent by the station.

You cannot change any of the values on this page. To update this page and to show the current connected wireless stations, click **Refresh**.

If the numbers of connected wireless stations go beyond one page, click **Next** to go to the next page and click **Previous** to return the previous page.

 **Note:**

This page will be refreshed automatically every 5 seconds.

## 4.5 DHCP

DHCP stands for Dynamic Host Configuration Protocol. The DHCP Server will automatically assign dynamic IP addresses to the computers on the network. This protocol simplifies network management and allows new wireless devices to receive IP addresses automatically without the need to manually assign new IP addresses.

There are three submenus under the DHCP menu (shown as Figure 4-20): **DHCP Settings**, **DHCP Clients List** and **Address Reservation**. Clicking any of them will enable you to configure the corresponding function. The detailed explanations for each submenu are provided below.

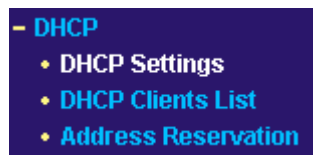

Figure 4-20 The DHCP menu.

### 4.5.1 DHCP Settings

Selecting **DHCP > DHCP Settings** will enable you to set up the AP as a DHCP (Dynamic Host Configuration Protocol) server, which provides the TCP/IP configuration for all the PCs that are connected to the system on the LAN. The DHCP Server can be configured on the page (shown as Figure 4-21):

## DHCP Settings

<b>DHCP Server:</b>	<input checked="" type="radio"/> Disable <input type="radio"/> Enable
<b>Start IP Address:</b>	<input type="text" value="192.168.1.100"/>
<b>End IP Address:</b>	<input type="text" value="192.168.1.199"/>
<b>Address Lease Time:</b>	<input type="text" value="120"/> minutes (1~2880 minutes, the default value is 120)
<b>Default Gateway:</b>	<input type="text" value="0.0.0.0"/> (optional)
<b>Default Domain:</b>	<input type="text"/> (optional)
<b>Primary DNS:</b>	<input type="text" value="0.0.0.0"/> (optional)
<b>Secondary DNS:</b>	<input type="text" value="0.0.0.0"/> (optional)

Figure 4-21 DHCP Settings

- **DHCP Server** - Selecting the radio button before **Disable/Enable** will disable/enable the DHCP server on your AP. The default setting is **Disable**. If you disable the Server, you must have another DHCP server within your network or else you must manually configure the computer.
- **Start IP Address** - Enter an IP address for the DHCP Server to start with when assigning IP addresses. 192.168.1.100 is the default start IP address.
- **End IP Address** - Enter an IP address for the DHCP Server to end with when assigning IP addresses. 192.168.1.199 is the default end address.
- **Address Lease Time** - Enter the amount of time for the PC to connect to the AP with its current assigned dynamic IP address. The time is measured in minutes. After the time is up, the PC will be automatically assigned a new dynamic IP address. The range of the time is 1 ~ 2880 minutes. The default value is 120 minutes.
- **Default Gateway (optional)** - Enter the IP address of the gateway for your LAN. The factory default setting is 0.0.0.0.
- **Default Domain (optional)** - Enter the domain name of the your DHCP server. You can leave the field blank.
- **Primary DNS (optional)** - Enter the DNS IP address provided by your ISP. Consult your ISP if you don't know the DNS value. The factory default setting is 0.0.0.0.
- **Secondary DNS (optional)** - Enter the IP address of another DNS server if your ISP provides two DNS servers. The factory default setting is 0.0.0.0.

 **Note:**

To use the DHCP server function of the AP, you must configure all computers on the LAN as "Obtain an IP Address automatically" mode. This function will take effect until the AP reboots.

### 4.5.2 DHCP Clients List

Selecting **DHCP > DHCP Clients List** will enable you to view the Client Name, MAC Address, Assigned IP and Lease Time for each DHCP Client attached to the AP (Figure 4-22):

ID	Client Name	MAC Address	Assigned IP	Lease Time
1	zhing	00-13-8F-AB-5E-57	192.168.1.100	01:59:12

Figure 4-22 DHCP Clients List

- **ID** - Here displays the index of the DHCP client.
- **Client Name** - Here displays the name of the DHCP client.
- **MAC Address** - Here displays the MAC address of the DHCP client.
- **Assigned IP** - Here displays the IP address that the AP has allocated to the DHCP client.
- **Lease Time** - Here displays the time of the DHCP client leased. Before the time is up, DHCP client will request to renew the lease automatically.

You cannot change any of the values on this page. To update this page and to show the current attached devices, click on the **Refresh** button.

### 4.5.3 Address Reservation

Selecting **DHCP > Address Reservation** will enable you to specify a reserved IP address for a PC on the LAN, so the PC will always obtain the same IP address each time when it accesses the AP. Reserved IP addresses should be assigned to servers that require permanent IP settings. The screen below is used for address reservation (shown in Figure 4-23).

ID	MAC Address	Reserved IP Address	Status	Modify
1	00-0A-EB-00-07-BE	192.168.1.10	Enabled	<a href="#">Modify</a> <a href="#">Delete</a>
2	00-0A-EB-00-07-B5	192.168.1.11	Enabled	<a href="#">Modify</a> <a href="#">Delete</a>

Figure 4-23 Address Reservation

- **MAC Address** - Here displays the MAC address of the PC for which you want to reserve IP address.

- **Reserved IP Address** - Here displays the IP address of the AP reserved.

#### To Reserve IP addresses:

1. Click **Add New...** to add a new Address Reservation entry.
2. Enter the MAC address in XX-XX-XX-XX-XX-XX format and IP address in dotted-decimal notation of the computer you wish to add.
3. Click **Save** when finished.

#### To modify a Reserved IP address:

1. Select the reserved address entry to your needs and click **Modify**. If you wish to delete the entry, make all of the entry fields blank.
2. Click **Save** to keep your changes.

#### To delete all Reserved IP addresses:

Click **Delete All** to delete all reserved IP addresses.

Click **Save** to keep your changes.

Click **Next** to go to the next page and Click **Previous** to return the previous page.

#### **Note:**

The function won't take effect until the AP reboots.

## 4.6 Wireless Settings

Wireless Settings focuses on some advanced settings for your wireless network. You can configure the settings on the screen below (Figure 4-24)

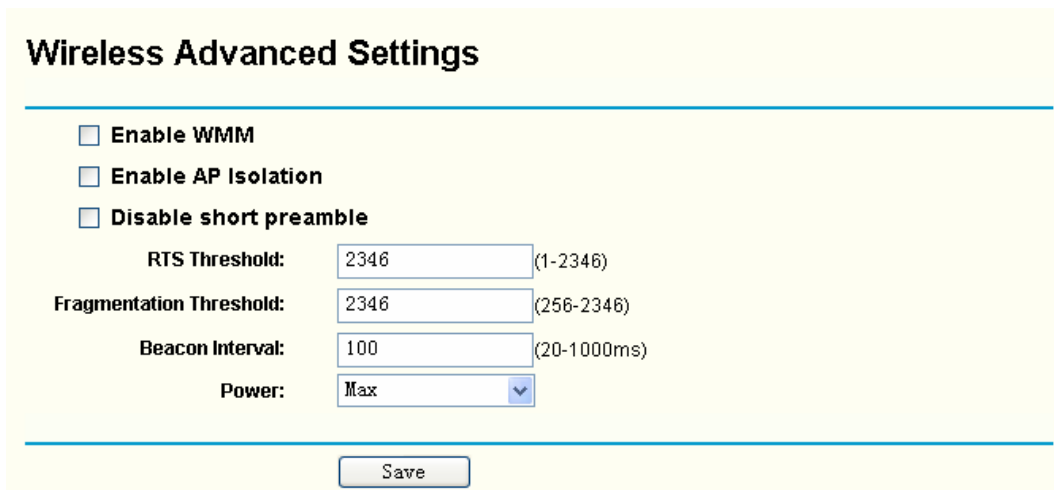

**Wireless Advanced Settings**

Enable WMM

Enable AP Isolation

Disable short preamble

RTS Threshold:  (1-2346)

Fragmentation Threshold:  (256-2346)

Beacon Interval:  (20-1000ms)

Power:

Figure 4-24 AP Wireless Advanced Settings

- **Enable WMM** - Checking **Enable WMM** (Wi-Fi MultiMedia) box will enable Wi-Fi MultiMedia Function.
- **Enable AP Isolation** - Checking **Enable AP Isolation** box will isolate all connected wireless stations so that wireless stations can not access each other through WLAN. This option is available only for AP mode.
- **Disable short preamble** - Preamble is part of the wireless signal that synchronizes network



traffic. A long transmit preamble may provide a more reliable connection or slightly longer range. A short preamble gives better performance. High network traffic areas should use the shorter preamble type. Checking **Disable short preamble** box will disable short preamble and use long preamble only. 802.11b mode supports only long preamble and this parameter will be ignored.

- **RTS threshold** - Specifies the packet size that is used to determine if RTS/CTS should be sent.
- **Fragmentation threshold** - Specifies the maximum packet size used for fragmentation.
- **Beacon Interval** - Specifies the interval time between two successive beacons.
- **Power** - Select the transmit power of the access point from the drop-down list.

 **Note:**

Restricted by local law regulations, version for North America does not have power selection option. The wireless advanced settings for this version are shown below.

### Wireless Advanced Settings

---

**Enable WMM**

**Enable AP Isolation**

**Disable short preamble**

**RTS Threshold:**  (1-2346)

**Fragmentation Threshold:**  (256-2346)

**Beacon Interval:**  (20-1000ms)

---

 **Note:**

The AP will reboot automatically after you click the Save button.

## 4.7 System Tools

**System Tools** option helps you to optimize the configuration of your device. You can upgrade the AP to the most recent version of firmware as well as back up or restore the AP's configuration files. You should change the default password to a more secure one because it controls access to the AP's web-based management page. Besides, you can find out what happened to the system in Syslog.

There are six submenus under the **System Tools** menu (shown as Figure 4-25): **Firmware**, **Factory Defaults**, **Backup & Restore**, **Reboot**, **Password**, and **Syslog**. Clicking any of them will enable you to configure the corresponding function. The detailed explanations for each submenu are provided below.

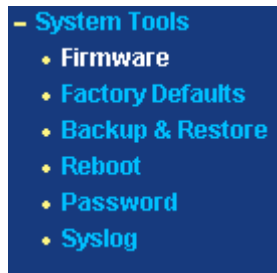

Figure 4-25 The System Tools menu

### 4.7.1 Firmware

Selecting **System Tools** > **Firmware** allows you to upgrade the AP to the most recent version of firmware on the screen below (Figure 4-26).

Figure 4-26 Firmware Upgrade

- **File** - Locate the position path of the upgrade file.
- **Firmware Version** - Displays the current firmware version.
- **Hardware Version** - Displays the current hardware version. The upgrade file must accord with the current hardware version.

New firmware versions are posted on [www.tp-link.com](http://www.tp-link.com) and can be downloaded for free. There is no need to upgrade the firmware unless the new firmware has a new feature you want to use. However, when experiencing problems caused by the AP itself, you can try to upgrade the firmware.

 **Note:**

When you upgrade the AP's firmware, you may lose its configuration settings, so make sure you write down the AP settings before you upgrade its firmware.

To upgrade the AP's firmware, follow these instructions:

1. Download a more recent firmware upgrade file from the TP-LINK website ([www.tp-link.com](http://www.tp-link.com)).
2. Click **Browse** to view the folders and select the downloaded file.
3. Click **Upgrade**.

 **Note:**

Do not turn off the AP or press the Reset button while the firmware is being upgraded.

The AP will reboot after the Upgrading has been finished.

### 4.7.2 Factory Defaults

Selecting **System Tools > Factory Defaults** allows you to restore the factory default settings for the AP on the screen below (Figure 4-27).

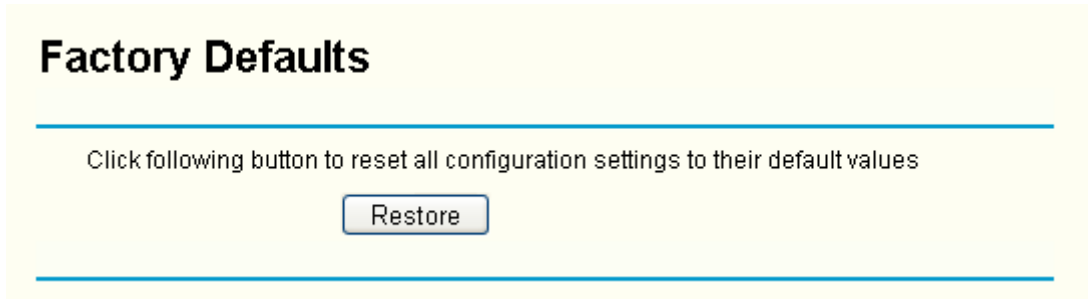

Figure 4-27 Restore Factory Default

Click the **Restore** button to reset all configuration settings to their default values.

- The default **User Name**: admin
- The default **Password**: admin
- The default **IP Address**: 192.168.1.254
- The default **Subnet Mask**: 255.255.255.0

#### **Note:**

Any settings you have saved will be lost when the default settings are reset.

### 4.7.3 Backup & Restore

Selecting **System Tools > Backup & Restore** allows you to save all configuration settings to your local computer as a file or restore the AP's configuration.



Figure 4-28 Save or Restore the Configuration

Click **Backup** to save all configuration settings to your local computer as a file.

To restore the AP's configuration, follow these instructions:

- Click **Browse** to find the configuration file which you want to restore.
- Click **Restore** to update the configuration with the file whose path is the one you have input or selected in the blank.

#### **Note:**

1. The current configuration will be covered with the uploading configuration file.

2. Wrong process will lead the device unmanaged.
3. The restoring process lasts for 20 seconds and restart automatically. Do not power off the device during the process to avoid any damage.

#### 4.7.4 Reboot

Selecting **System Tools** > **Reboot** allows you to reboot the AP on the screen below (Figure 4-29).

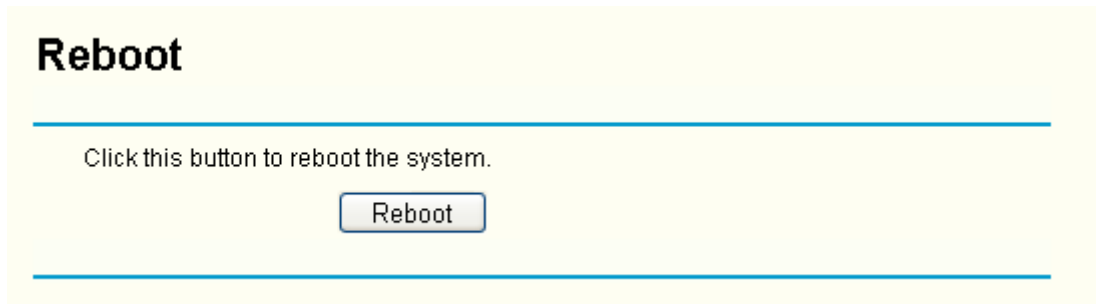

Figure 4-29 Reboot the AP

Click **Reboot** to reboot the AP.

Some settings of the AP will take effect only after rebooting, which include:

- Change LAN IP Address. (System will reboot automatically)
- DHCP service function.
- Static address assignment of DHCP server.
- Upgrade the firmware of the AP (system will reboot automatically).
- Restore the AP's settings to factory default (system will reboot automatically).

#### 4.7.5 Password

Selecting **System Tools** > **Password** allows you to change the factory default user name and password of the AP on the screen below (Figure 4-30).

Figure 4-30 Password

It is strongly recommended that you change the factory default user name and password of the AP. All users who try to access the AP's web-based management page or Quick Setup will be prompted for the AP's user name and password.

**Note:**

The new user name and password can only consist of underline, dash numbers or letters but not any spaces. It must not exceed 14 characters in length. Enter the new Password twice to confirm it.

Click the **Save** button when finished.

Click the **Clear All** button to clear all.

#### 4.7.6 SysLog

Selecting **System Tools > System Log** allows you to query the Logs of the AP on the screen below (Figure 4-31).

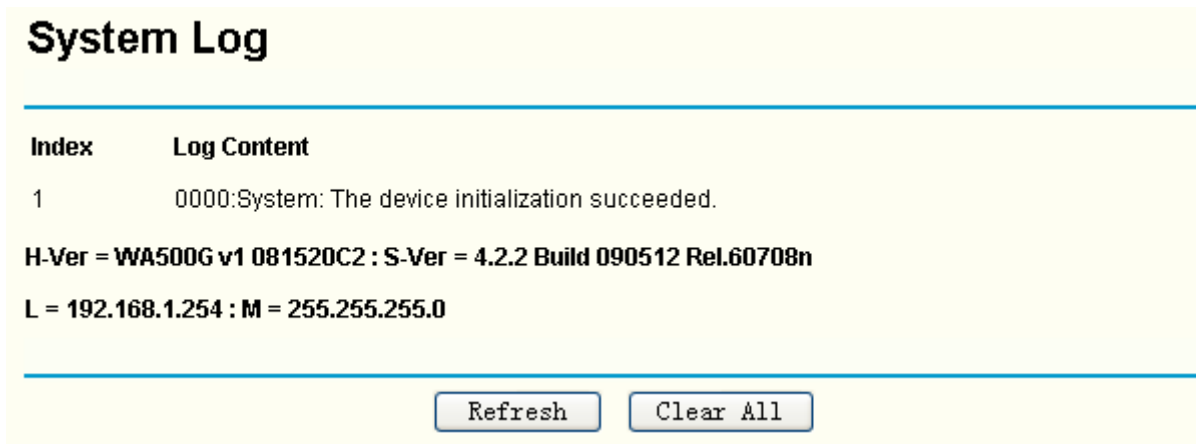

**System Log**

Index	Log Content
1	0000:System: The device initialization succeeded.  H-Ver = WA500G v1 081520C2 : S-Ver = 4.2.2 Build 090512 Rel.60708n  L = 192.168.1.254 : M = 255.255.255.0

Refresh Clear All

Figure 4-31 System Log

The AP can keep logs of all traffic. You can query the logs to find what happened to the AP.

Click **Refresh** to refresh the logs.

Click **Clear ALL** to clear all the logs.

## Appendix A: Application Example

The TL-WA500G allows you to connect a wireless device to the wired network. Providing that you want to connect your computer equipped with wireless adapter to a wired network wirelessly, you can take the following instructions.

1. Configure the AP via a wired connection.
  - 1). Connect your AP to your PC with an Ethernet cable.
  - 2). Configure the IP address for your PC to communicate with the AP referring to **Chapter 3 Configure the PC**.
  - 3). Log on to the web-based management page. Configure your AP in the **Access Point** mode and check the **Enable SSID Broadcast** box referring to **4.4.2 Wireless Mode**.
  - 4). View the **Wireless > Basic Settings** page and keep the SSID of the AP in mind.(Here we choose TP-LINK as the SSID for example.) You are suggested to change the SSID and secure your wireless network referring to **4.4.1 Basic Settings** and **4.4.3 Security Settings**.
  - 5). Remove the Ethernet cable between the AP and your PC.
2. Connect your AP to the LAN port on the Router with an Ethernet cable.

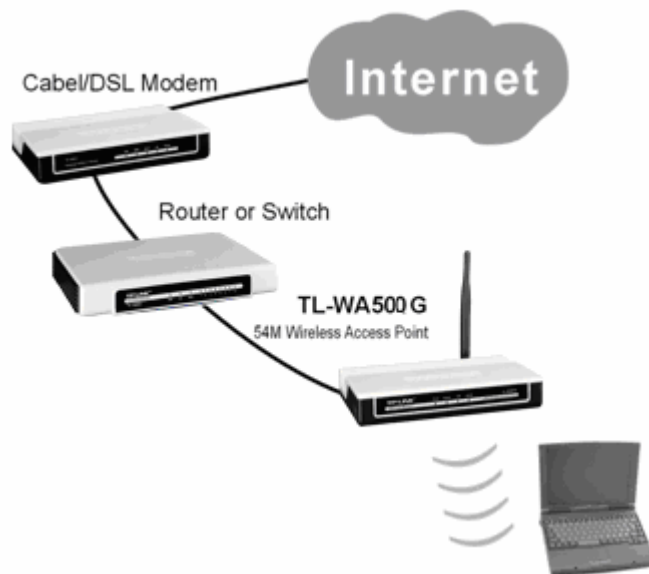

3. Configure your PC to connect to the network wirelessly.
  - 1). Click **Start** ( in the lower left corner of the PC's screen), right-click **My Network Connections** and choose **Properties**.

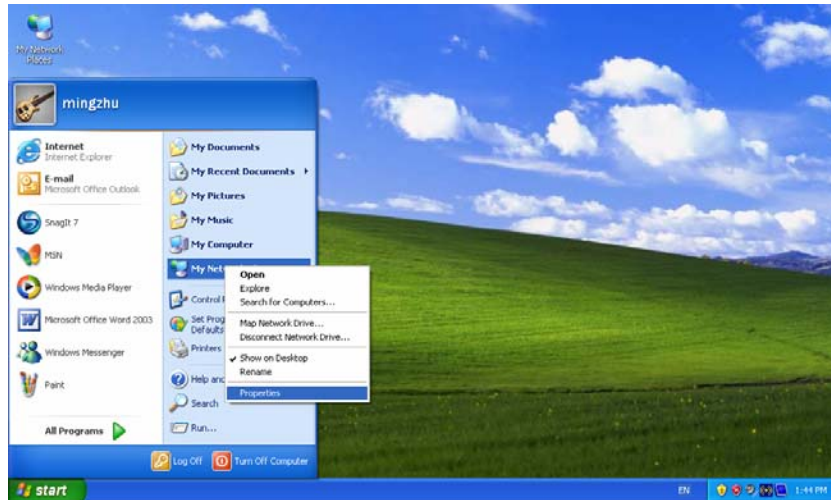

- 2). On the **My Network Connections** window, right-click **Wireless Network** and choose **Enable** to enable wireless network function.

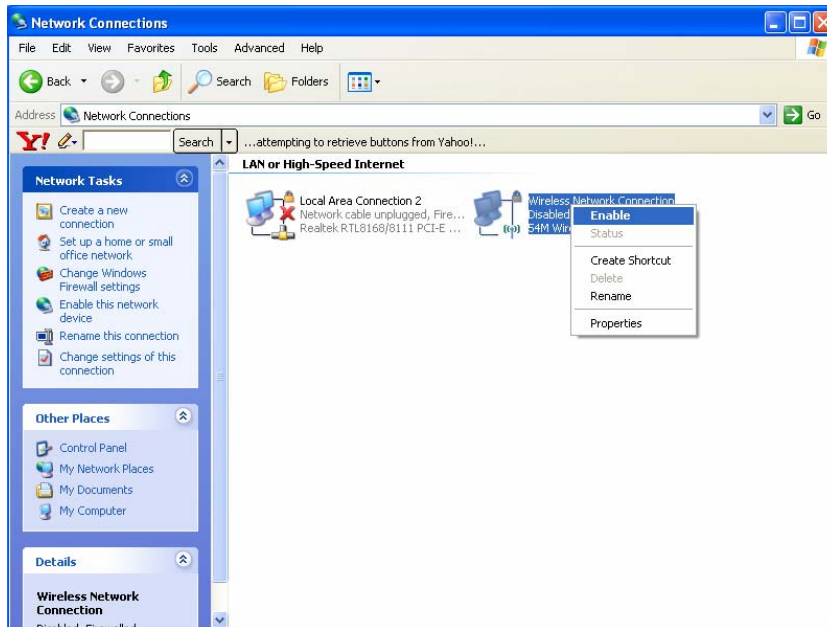

- 3). Right-click the wireless connection icon “” on the screen of the PC and then select **View Available Wireless Networks**.

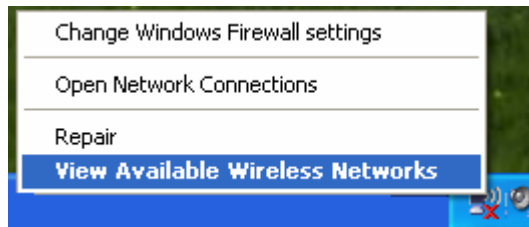

- 4). Highlight the SSID of the AP(Here is TP-LINK) and click **Connect** to add to the network.

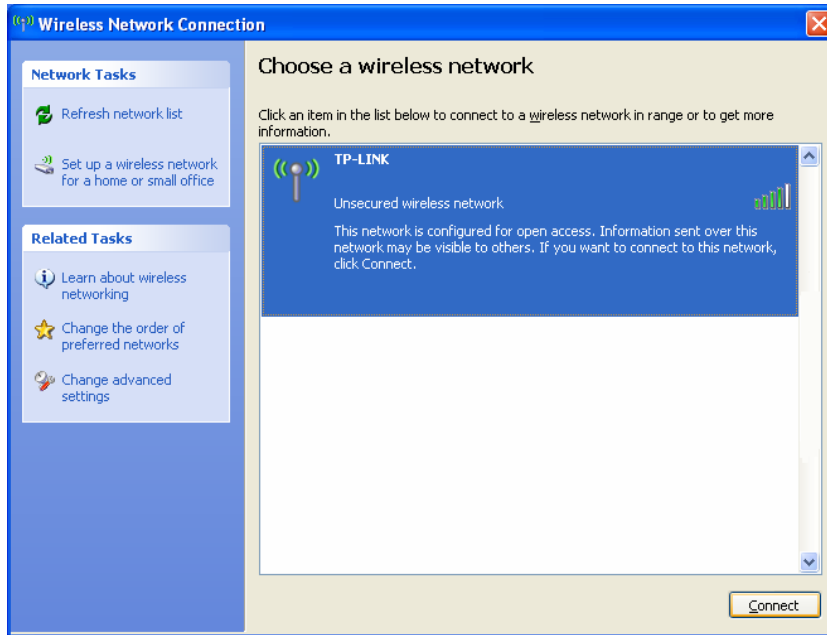

- 5). Then the following page will display, which indicates you have been successfully added to the network wirelessly.

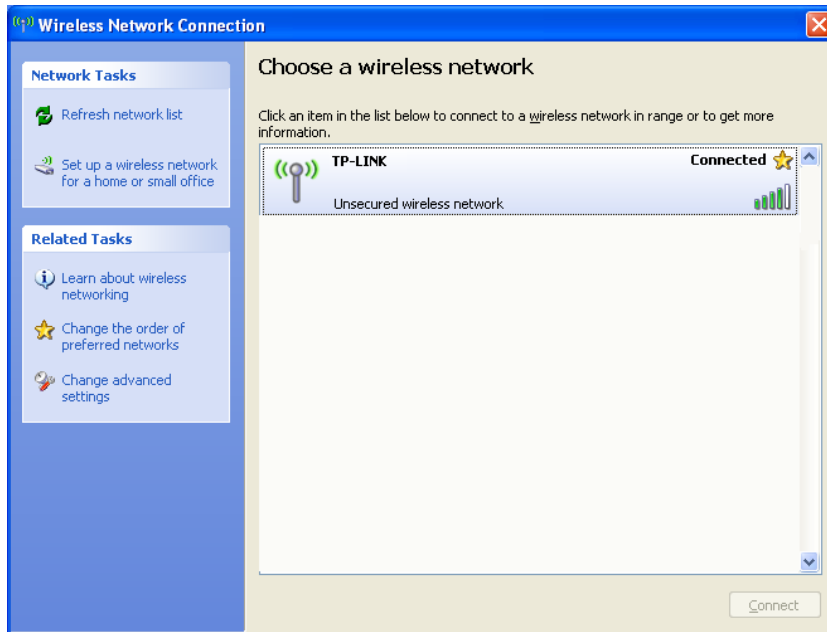



## Appendix B: Factory Defaults

Item	Default Value
<b>Common Default Settings</b>	
Username	admin
Password	admin
IP Address	192.168.1.254
Subnet Mask	255.255.255.0
<b>Wireless</b>	
SSID	TP-LINK_*****
Region	United States
Wireless Security	Disable
Wireless MAC Address Filtering	Disable
<b>DHCP</b>	
DHCP Server	Disable
Start IP Address	192.168.1.100
End IP Address	192.168.1.199
Address Lease Time	120 minutes (Range:1 ~ 2880 minutes)
Default Gateway (optional)	0.0.0.0
Primary DNS (optional)	0.0.0.0
Secondary DNS (optional)	0.0.0.0

 **Note:**

The default SSID is TP-LINK\_\*\*\*\*\* (\*\*\*\*\* indicates the last unique six characters of each device's MAC address). This value is case-sensitive.

## Appendix C: Troubleshooting

### 1. No LEDs are lit on the access point.

It takes a few seconds for the Power LED to light up. Wait a minute and check the status of Power LED. If there the LED is still off, check the following items.

- 1) Make sure the power cord is connected to the Access Point.
- 2) Make sure the power adapter is connected to a functioning electrical outlet and the switch of the electrical outlet is on.
- 3) Make sure you are using the correct TP-LINK power adapter provided with your Access Point.

### 2. The LAN LED is not lit.

There is a hardware connection problem. Check the following items.

- 1) Make sure the cable connectors are securely plugged in at the Access Point and the network device (hub, switch, or Router).
- 2) Make sure the connected device is turned on.
- 3) Make sure the correct cable is used. Use a standard Category 5 Ethernet patch cable. If the network device has Auto Uplink™ (MDI/MDIX) ports, you can use either a crossover cable or a normal patch cable.

### 3. I can not access the AP with a wireless capable computer.

There is a configuration problem. Check the following items.

- 1) You may not have the computer with the wireless adapter restarted to make TCP/IP changes take effect. Restart the computer.
- 2) The computer with the wireless adapter may not have the correct TCP/IP settings to communicate with the network. Restart the computer and check if TCP/IP is set up properly for that network. The usual setting for Windows is “Obtain an IP address automatically” in Network Properties.
- 3) The Access Point’s default values may not work with your network. Check to see if the access point’s default configuration conflicts the configuration of other devices in your network.

## Appendix D: Specifications

<b>General</b>	
Standards and Protocols	IEEE 802.3, 802.3u, 802.11b and 802.11g, TCP/IP, DHCP
Safety & Emission	FCC、CE
Ports	One 10/100M Auto-Negotiation LAN RJ45 port supporting Auto MDI/MDIX
Cabling Type	10BASE-T: UTP category 3, 4, 5 cable (maximum 100m) EIA/TIA-568 100Ω STP (maximum 100m) 100BASE-TX: UTP category 5, 5e cable (maximum 100m) EIA/TIA-568 100Ω STP (maximum 100m)
<b>Wireless</b>	
Wireless Data Rates	54/48/36/24/18/12/9/6Mbps or 11/5.5/3/2/1Mbps
WEP	64/128/152 bits
Wireless Encryptions	64/128/152-bit WEP, WPA/WPA2, WPA-PSK/WPA2-PSK
<b>Physical and Environment</b>	
Working Temperature	0°C~40°C (32°F~104°F)
Working Humidity	10% ~ 90% RH, Non-condensing
Storage Temperature	-40°C~70°C(-40°F~158°F)
Storage Humidity	5% ~ 90% RH, Non-condensing

## Appendix E: Glossary

**2x to 3x eXtended Range™ WLAN Transmission Technology** - The WLAN device with 2x to 3x eXtended Range™ WLAN transmission technology make its sensitivity up to 105 dBm, which gives users the ability to have robust, longer-range wireless connections. With this range-enhancing technology, a 2x to 3x eXtended Range™ based client and access point can maintain a connection at as much as three times the transmission distance of traditional 802.11b and 802.11g products, for a coverage area that is up to nine times greater. A traditional 802.11b and 802.11g product transmission distance is about 300m. A 2x to 3x eXtended Range™ based client and access point can maintain a connection transmission distance may be up to 830m.

**802.11b** - The 802.11b standard specifies a wireless networking at 11 Mbps using direct-sequence spread-spectrum (DSSS) technology and operating in the unlicensed radio spectrum at 2.4GHz, and WEP encryption for security. 802.11b networks are also referred to as Wi-Fi networks.

**802.11g** - specification for wireless networking at 54 Mbps using direct-sequence spread-spectrum (DSSS) technology, using OFDM modulation and operating in the unlicensed radio spectrum at 2.4GHz, and backward compatibility with IEEE 802.11b devices, and WEP encryption for security.

**Access Point (AP)** - A wireless LAN transceiver or "base station" that can connect a wired LAN to one or many wireless devices. Access points can also bridge to each other.

**DNS (Domain Name System)** – An Internet Service that translates the names of websites into IP addresses.

**Domain Name** - A descriptive name for an address or group of addresses on the Internet.

**DoS (Denial of Service)** - A hacker attack designed to prevent your computer or network from operating or communicating.

**DSL (Digital Subscriber Line)** - A technology that allows data to be sent or received over existing traditional phone lines.

**ISP (Internet Service Provider)** - A company that provides access to the Internet.

**MTU (Maximum Transmission Unit)** - The size in bytes of the largest packet that can be transmitted.

**SSID** - A **S**ervice **S**et **I**dentification is a thirty-two character (maximum) alphanumeric key identifying a wireless local area network. For the wireless devices in a network to communicate with each other, all devices must be configured with the same SSID. This is typically the configuration parameter for a wireless PC card. It corresponds to the ESSID in the wireless Access Point and to the wireless network name.

**WEP (Wired Equivalent Privacy)** - A data privacy mechanism based on a 64-bit or 128-bit or 152-bit shared key algorithm, as described in the IEEE 802.11 standard.

**Wi-Fi** - A trade name for the 802.11b wireless networking standard, given by the Wireless Ethernet Compatibility Alliance (WECA, see <http://www.wi-fi.net>), an industry standards group promoting interoperability among 802.11b devices.

**WLAN (Wireless Local Area Network)** - A group of computers and associated devices communicate with each other wirelessly, which network serving users are limited in a local area.

**WPA (Wi-Fi Protected Access)** - WPA is a security technology for wireless networks that improves on the authentication and encryption features of WEP (Wired Equivalent Privacy). In fact, WPA was developed by the networking industry in response to the shortcomings of WEP. One of the key technologies behind WPA is the Temporal Key Integrity Protocol (TKIP). TKIP addresses the encryption weaknesses of WEP. Another key component of WPA is built-in authentication that WEP does not offer. With this feature, WPA provides roughly comparable security to VPN tunneling with WEP, with the benefit of easier administration and use. This is similar to 802.1x support and requires a RADIUS server in order to implement. The Wi-Fi Alliance will call this, WPA-Enterprise. One variation of WPA is called WPA Pre Shared Key or WPA-PSK for short - this provides an authentication alternative to an expensive RADIUS server. WPA-PSK is a simplified but still powerful form of WPA most suitable for home Wi-Fi networking. To use WPA-PSK, a person sets a static key or "passphrase" as with WEP. But, using TKIP, WPA-PSK automatically changes the keys at a preset time interval, making it much more difficult for hackers to find and exploit them. The Wi-Fi Alliance will call this, WPA-Personal.