



User Manual

Preface

D-Link reserves the right to revise this publication and to make changes in the content hereof without obligation to notify any person or organization of such revisions or changes.

Manual Revisions

Revision	Date	Description
1.0	December 16, 2013	• Initial release

Trademarks

D-Link and the D-Link logo are trademarks or registered trademarks of D-Link Corporation or its subsidiaries in the United States or other countries. All other company or product names mentioned herein are trademarks or registered trademarks of their respective companies.

Copyright © 2013 by D-Link Corporation.

All rights reserved. This publication may not be reproduced, in whole or in part, without prior expressed written permission from D-Link Corporation.

This purpose of this product is to create a constant network connection for your devices. As such, it does not have a standby mode or use a power management mode. If you wish to power down this product, please simply unplug it from the power outlet.

Table of Contents

Preface	i	Wireless.....	27
Manual Revisions.....	i	Wireless Basics.....	27
Trademarks	i	Wi-Fi Protected (WPS) Setup.....	30
Product Overview	1	Advanced Wireless.....	31
Package Contents.....	1	Advanced.....	33
System Requirements.....	2	Access Control List.....	33
Introduction	3	Port Triggering	34
Features.....	4	DMZ	35
Hardware Overview.....	5	URL Block	36
Front/Side.....	5	Dynamic DNS	37
Bottom.....	6	QoS.....	38
Operation Modes.....	7	UPnP	40
Router Mode.....	8	Virtual Server	41
Access Point Mode	9	Maintenance.....	43
Wireless Installation Considerations.....	10	Reboot	43
Setting Up With a Web Browser	11	Firmware Upgrade.....	44
Router Mode.....	12	Backup/Restore.....	45
Access Point Mode	12	Admin.....	46
Router Mode	13	Time and Date.....	47
Initial Setup Wizard	13	Status.....	48
Manual Configuration	15	Device Info.....	48
Setup	16	Active Client Table	49
Wizard	16	Statistics	50
Local Network	20	Help.....	51
Internet Setup	24	Access Point Mode	52
		Manual Configuration.....	52

Setup	53	Windows® XP	83
Local Network	53	WPA/WPA2	84
Wireless.....	54	Troubleshooting	86
Wireless Basics.....	54	Wireless Basics	90
Wi-Fi Protected (WPS) Setup.....	57	What is Wireless?.....	91
Advanced Wireless.....	58	Tips.....	93
Maintenance.....	60	Networking Basics	94
Reboot	60	Statically Assign an IP address	95
Firmware Upgrade.....	61	Technical Specifications	96
Backup/Restore.....	62	Safety Statements	97
Admin.....	63		
Time and Date.....	64		
Status.....	65		
Device Info.....	65		
Active Client Table	66		
Statistics	67		
Help.....	68		
Connecting a Wireless Client	69		
WPS Button.....	69		
Windows® 8.....	70		
WPA/WPA2	70		
Windows® 7.....	72		
WPA/WPA2	72		
WPS.....	75		
DIR-516	76		
Windows Vista®.....	79		
WPA/WPA2	80		
WPS/WCN 2.0	82		

Product Overview

Package Contents



DIR-516



Quick Installation Guide

If any of the above items are missing from your package, please contact your reseller.

System Requirements

Network Requirements	<ul style="list-style-type: none">• An Ethernet-based Cable or DSL modem• IEEE 802.11ac, 802.11a, 802.11n or 802.11g wireless clients• 10/100 Ethernet
Web-based Configuration Utility Requirements	<p>Computer with the following:</p> <ul style="list-style-type: none">• Windows®, Macintosh, or Linux-based operating system• An installed Ethernet adapter <p>Browser Requirements:</p> <ul style="list-style-type: none">• Microsoft Internet Explorer® v7, Mozilla® Firefox® v9.0, Google® Chrome 16.0, or Safari® v4 or higher version <p>Windows® Users: Make sure you have the latest version of Java installed. Visit www.java.com to download the latest version.</p>

Introduction

TOTAL COVERAGE

Provides greater wireless signal rates even at farther distances for incredible wireless coverage.

ULTIMATE PERFORMANCE

The D-Link DIR-516 lets you create a secure wireless network to share photos, files, music, video, printers, and network storage throughout your home. Connect the DIR-516 router to a cable or DSL modem and share your high-speed Internet access with everyone on the network.

TOTAL NETWORK SECURITY

The DIR-516 router supports all of the latest wireless security features to prevent unauthorized access, be it from over the wireless network or from the Internet. Support for WPA/WPA2 standards ensure that you'll be able to use the best possible encryption method, regardless of your client devices. In addition, this router utilizes dual active firewalls (SPI and NAT) to prevent potential attacks from across the Internet.

* Maximum wireless signal rate derived from IEEE Standard 802.11a, 802.11g, 802.11n and draft 802.11ac specifications. Actual data throughput will vary. Network conditions and environmental factors, including volume of network traffic, building materials and construction, and network overhead, lower actual data throughput rate. Environmental conditions will adversely affect wireless signal range.

Features

- **Faster Wireless Networking** - The DIR-516 provides an up to 150Mbps wireless connection in 2.4GHz band, 433Mbps wireless connection in 5GHz with other 802.11ac and draft 802.11n wireless clients. This capability allows users to participate in real-time activities online, such as video streaming, online gaming, and real-time audio.
- **Portable and Easy to Use** - Simply plug the DIR-516 into a power outlet at home or abroad to create an instant wireless network wherever you are.
- **Compatible with 802.11a/g/n Devices** - The DIR-516 is still fully compatible with the IEEE 802.11a, 802.11g and 802.11n, so it can connect with existing 802.11a, 802.11g and 802.11n PCI, USB, and FireWire adapters.
- **User-friendly Setup Wizard** - Through its easy-to-use web-based user interface, the DIR-516 lets you control what information is accessible to those on the wireless network, whether from the Internet or from your company's server. Configure your router to your specific settings within minutes.

* Maximum wireless signal rate derived from IEEE Standard 802.11a, 802.11g, 802.11n and draft 802.11ac specifications. Actual data throughput will vary. Network conditions and environmental factors, including volume of network traffic, building materials and construction, and network overhead, lower actual data throughput rate. Environmental conditions will adversely affect wireless signal range.

Hardware Overview

Front/Side

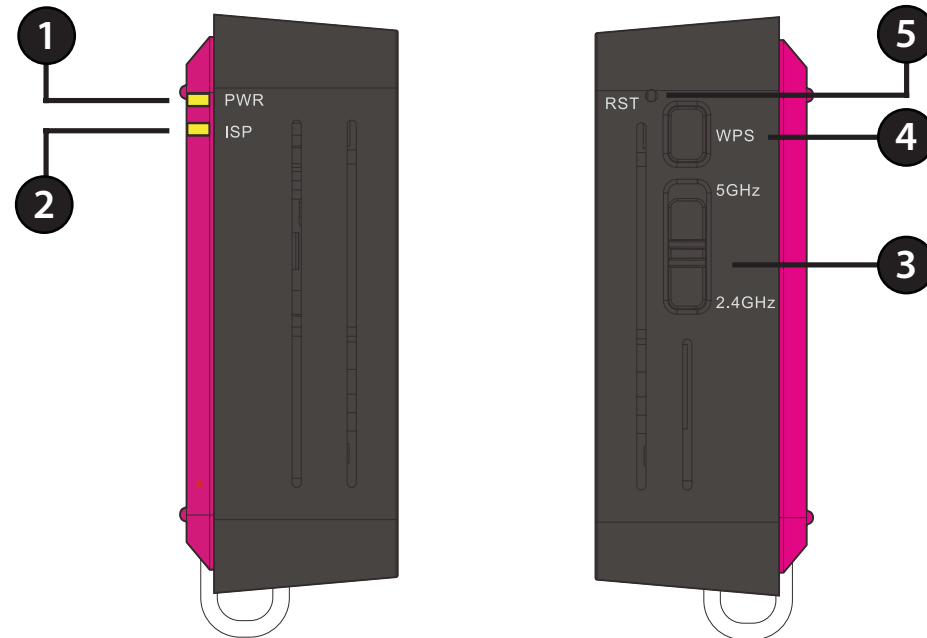

1	Power (PWR LED)	A solid green light indicates a proper connection to the power supply. The light will blink when connecting to a device through WPS.
2	Internet (ISP) LED	A solid light indicates connection on the Internet port.
3	Selector Switch	Slide this switch to select between 2.4GHz and 5GHz
4	WPS Button	Press this to activate Wi-Fi Protected Setup(WPS) to connect other wireless devices automatically.
5	Reset Button	Pressing the Reset button for 5 seconds restores the router to its original factory default settings.

Hardware Overview

Bottom

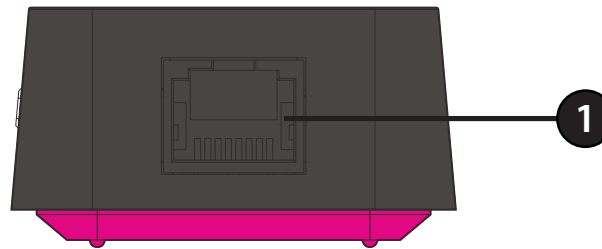

1	Ethernet Port	The auto MDI/MDIX Internet port is the connection for the Ethernet cable to the cable or DSL modem.
----------	---------------	---

Operation Modes

Depending on how you want to use your DIR-516 will determine which mode you use. The following pages describe each mode to help you figure out which one to use.

- Router Mode: page 8
- Access Point Mode: page 9

Router Mode

In Router Mode, the DIR-516 connects to your cable modem, DSL modem, or other Internet source and shares your Internet connection with your devices wirelessly, providing Internet access for an entire home or office.

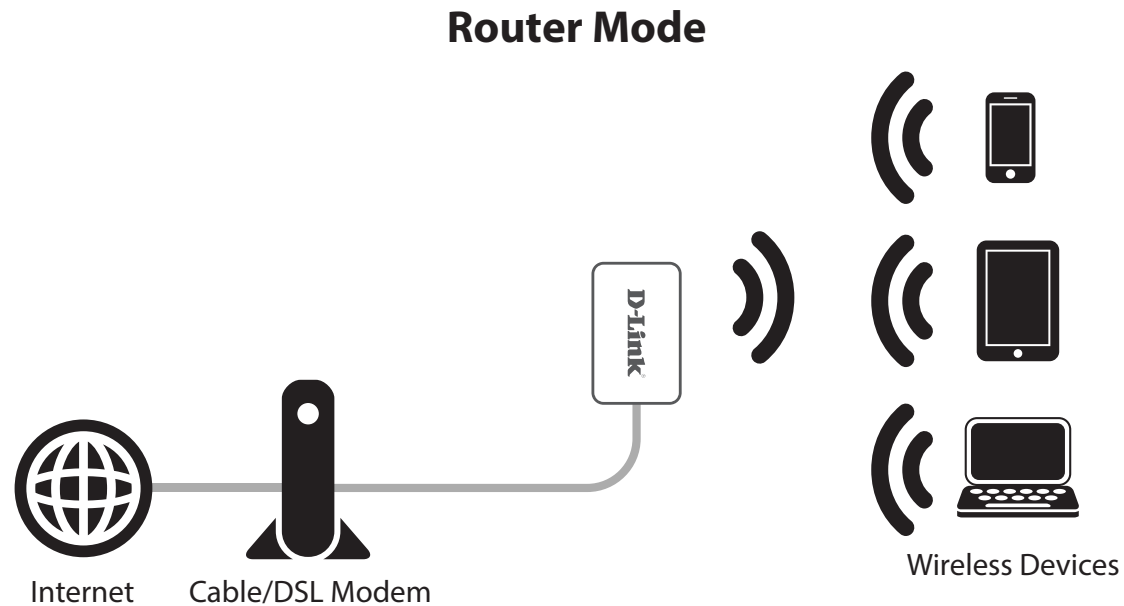

Access Point Mode

In Access Point Mode, the DIR-516 connects your wireless devices together, but does not provide routing functionality. It also allows a connected wired device to connect to your other devices wirelessly. This can be useful if you already have an existing Internet router that does not have built-in wireless capabilities. You can also use this to create a private wireless network without Internet access so that your devices can securely connect to one another without being exposed to the Internet or other computers.

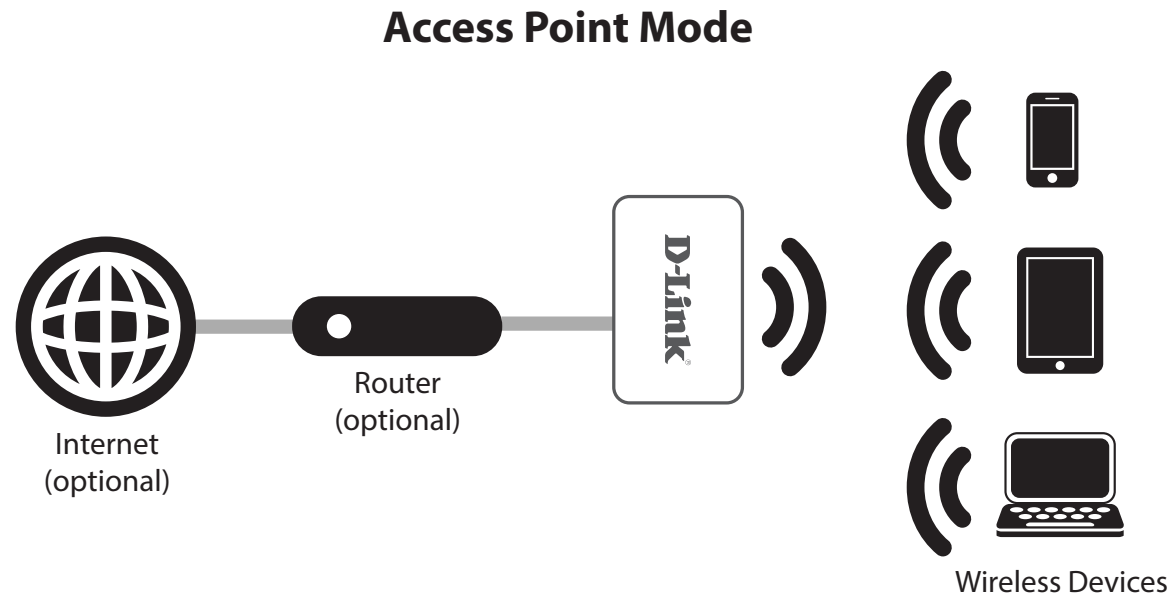

Wireless Installation Considerations

The D-Link wireless router lets you access your network using a wireless connection from virtually anywhere within the operating range of your wireless network. Keep in mind, however, that the number, thickness and location of walls, ceilings, or other objects that the wireless signals must pass through, may limit the range. Typical ranges vary depending on the types of materials and background RF (radio frequency) noise in your home or business. The key to maximizing wireless range is to follow these basic guidelines:

1. Keep the number of walls and ceilings between the D-Link router and other network devices to a minimum - each wall or ceiling can reduce your adapter's range from 3-90 feet (1-30 meters.) Position your devices so that the number of walls or ceilings is minimized.
2. Be aware of the direct line between network devices. A wall that is 1.5 feet thick (.5 meters), at a 45-degree angle appears to be almost 3 feet (1 meter) thick. At a 2-degree angle it looks over 42 feet (14 meters) thick! Position devices so that the signal will travel straight through a wall or ceiling (instead of at an angle) for better reception.
3. Building materials make a difference. A solid metal door or aluminum studs may have a negative effect on range. Try to position access points, wireless routers, and computers so that the signal passes through drywall or open doorways. Materials and objects such as glass, steel, metal, walls with insulation, water (fish tanks), mirrors, file cabinets, brick, and concrete will degrade your wireless signal.
4. Keep your product away (at least 3-6 feet or 1-2 meters) from electrical devices or appliances that generate RF noise.
5. If you are using 2.4 GHz cordless phones or X-10 (wireless products such as ceiling fans, lights, and home security systems), your wireless connection may degrade dramatically or drop completely. Make sure your 2.4 GHz phone base is as far away from your wireless devices as possible. The base transmits a signal even if the phone is not in use.

Router Mode

This section will show you how to configure your new D-Link wireless router using the web-based configuration utility.

To access the configuration utility, open a web-browser such as Internet Explorer and enter the IP address of the router (**192.168.0.1**).

 <http://192.168.0.1/>

Enter **admin** in the User Name field. By default, the password should be left blank.

If you get a **Page Cannot be Displayed** error, please refer to the **Troubleshooting** section for assistance.

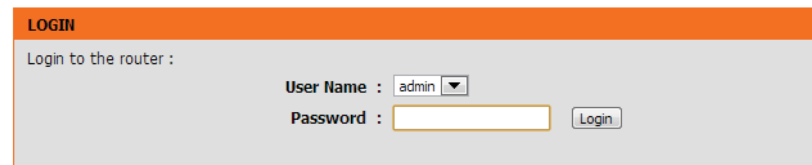

LOGIN

Login to the router :

User Name : admin ▼

Password :

Network Settings

This section will allow you to change the local network settings of the router and to configure the DHCP settings.

LAN Interface: Use this section to configure the router’s local network settings.

DHCP Server Settings: Use this section to configure the DIR-516’s built-in DHCP server settings.

DHCP Static IP Configuration: Use this section to add a new DHCP Static IP configuration.

DHCP Static IP Table: Displays information about the devices that have a static DHCP assigned from the DIR-516. The information includes the *IP Address* and *MAC Address*. You can delete or edit an existing static IP configuration in the table.

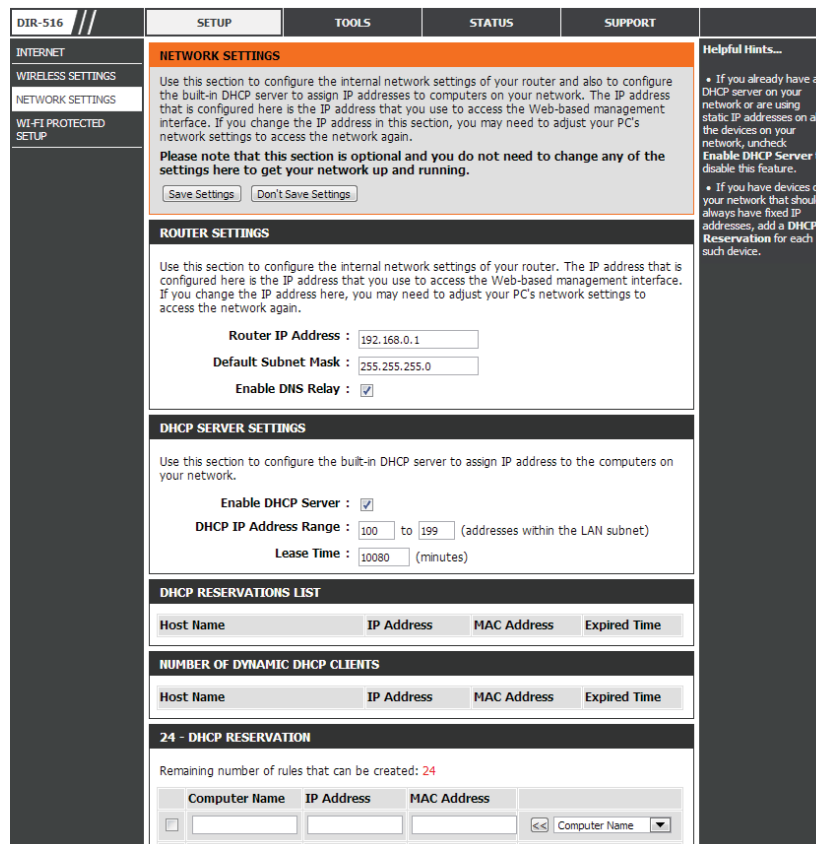

IP Address: Enter the IP address of the router. The default IP address is 192.168.0.1.

If you change the IP address, once you click **Apply**, you will need to enter the new IP address in your browser to get back into the configuration utility.

Subnet Mask: Enter the subnet mask. The default subnet mask is 255.255.255.0.



The screenshot shows a web interface titled "LAN Interface Setup". It contains two input fields: "IP Address" with the value "192.168.0.1" and "Subnet Mask" with the value "255.255.255.0".

Click the **Apply Changes** button to save any changes made.

DHCP stands for Dynamic Host Control Protocol. The DIR-516 has a built-in DHCP server. The DHCP Server will automatically assign an IP address to the computers on the LAN/private network. Be sure to set your computers to be DHCP clients by setting their TCP/IP settings to "Obtain an IP Address Automatically." When you turn your computers on, they will automatically load the proper TCP/IP settings provided by the DIR-516. The DHCP Server will automatically allocate an unused IP address from the IP address pool to the requesting computer. You must specify the starting and ending address of the IP address pool.

DHCP Server: Enable the **DHCP Server** option in the pulldown menu to enable the DHCP server on your router. Choose **None** to disable this function.

DHCP IP Address Range: Enter the starting and ending IP addresses for the DHCP server's IP assignment.

Note: *If you statically (manually) assign IP addresses to your computers or devices, make sure the IP addresses are outside of this range or you may have an IP conflict.*

Lease Time: The maximum length of time for the IP address lease. Enter the Lease time in minutes.

DNS Server 1: Enter the IP address of the first DNS Server.

DNS Server 2: Enter the IP address of the second DNS Server, if there is one.

When you have finished configuring the new DHCP Server Settings, click the **Save Setting** button.

The screenshot shows a web interface titled "DHCP SERVER SETTINGS". Below the title is a subtitle: "Use this section to configure the built-in DHCP server to assign IP address to the computers on your network." There are three main configuration options: "Enable DHCP Server" with a checked checkbox, "DHCP IP Address Range" with input fields for "100" and "199" and a note "(addresses within the LAN subnet)", and "Lease Time" with an input field for "10080" and a note "(minutes)".

If you want a computer or device to always have the same IP address assigned, you can create a DHCP reservation. The router will assign the IP address only to that computer or device.

Note: This IP address must be within the DHCP IP address range.

IP Address: Enter the IP address you want to assign to the computer or device. This IP address must be within the DHCP IP address range.

MAC Address: Enter the MAC address of the computer or device.

When you have finished configuring the new DHCP reservation, click the **Add** button to activate your reservation. It will then be displayed in the DHCP Static IP Table below.

24 - DHCP RESERVATION

Remaining number of rules that can be created: 24

	Computer Name	IP Address	MAC Address	
<input type="checkbox"/>	<input type="text"/>	<input type="text"/>	<input type="text"/>	<< Computer Name ▼
<input type="checkbox"/>	<input type="text"/>	<input type="text"/>	<input type="text"/>	<< Computer Name ▼
<input type="checkbox"/>	<input type="text"/>	<input type="text"/>	<input type="text"/>	<< Computer Name ▼
<input type="checkbox"/>	<input type="text"/>	<input type="text"/>	<input type="text"/>	<< Computer Name ▼
<input type="checkbox"/>	<input type="text"/>	<input type="text"/>	<input type="text"/>	<< Computer Name ▼
<input type="checkbox"/>	<input type="text"/>	<input type="text"/>	<input type="text"/>	<< Computer Name ▼
<input type="checkbox"/>	<input type="text"/>	<input type="text"/>	<input type="text"/>	<< Computer Name ▼

The DHCP Static IP Table displays the IP reservations that have been created. To make any changes, select a reservation in the table by clicking the circle next to it and click **Update**. To delete a reservation, select a reservation and click **Delete Selected**.

Internet Setup

This section allows you to manually configure your router's Internet WAN settings.

WAN Access Type: Select the WAN interface type.

Type:

If you choose DHCP, please configure the following fields:

Host Name: Enter the host name of the router.

MTU Size: Enter the MTU size.

Attain DNS Automatically: Click this if the DNS is to be obtained automatically.

Set DNS Manually: Click this to specify a DNS server. You can enter up to two DNS servers.

MAC Clone Select the MAC address to be used for the connection. Select **Default MAC** to use the router's MAC address. Select **MAC from PC** to copy your PC's MAC address, or select **MAC Manual** to manually enter a MAC address in the field provided.

When you have finished configuring the WAN settings, click the **Save Settings** button.

DIR-516 //	SETUP	TOOLS	STATUS	SUPPORT	
INTERNET	WIRELESS NETWORK				Helpful Hints... <ul style="list-style-type: none"> Changing your Wireless Network Name is the first step in securing your wireless network. We recommend that you change it to a familiar name that does not contain any personal information. Enable Auto Channel Scan the router can select the best possible channel for your wireless network to operate on. Enabling Hidden Mode is another way to secure your network. With this option enabled, no wireless clients will be able to see your wireless network when they perform a scan to see what's available. In order for your wireless devices to connect to your router, you will need to manually enter the Wireless Network Name on each device. If you have enabled Wireless Security, make sure you write down the WEP Key or Passphrase that you have configured. You will need to enter this information on any wireless device that you connect to your wireless network.
WIRELESS SETTINGS	Use this section to configure the wireless settings for your D-Link router. Please note that changes made in this section may also need to be duplicated on your wireless client. To protect your privacy you can configure wireless security features. This device supports four wireless security modes including: WEP, WPA only, WPA2 only, and WPA/WPA2 (auto-detect). <input type="button" value="Save Settings"/> <input type="button" value="Don't Save Settings"/>				
NETWORK SETTINGS	ACCESS POINT MODE Use this to disable NAT on the router and turn it into an Access Point. <input type="checkbox"/> Enabled Access Point Mode				
WI-FI PROTECTED SETUP	WIRELESS NETWORK SETTINGS Wireless Band : 5GHz Band Enable Wireless : <input checked="" type="checkbox"/> Wireless Network Name : DIR-516 (Also called the SSID) 802.11 Mode : Mixed 802.11ac, 802.11n and 802.11a Enable Auto Channel Scan : <input type="checkbox"/> Wireless Channel : 5.745 GHz - CH 149 Channel Width : 20/40/80 MHz(Auto) Visibility Status : <input checked="" type="radio"/> Visible <input type="radio"/> Invisible <input type="button" value="Save Settings"/> <input type="button" value="Don't Save Settings"/>				
	WIRELESS SECURITY MODE Security Mode : None <input type="button" value="Save Settings"/> <input type="button" value="Don't Save Settings"/>				

If you choose Static IP, please configure the following fields;

WAN Access Type: Select **Static IP** from the drop-down menu.

IP Address: Enter the static IP address which was provided to you by your Internet Service Provider (ISP).

Subnet Mask: Enter the subnet provided by your ISP.

Default Gateway: Enter the default gateway provided by your ISP.

MTU Size: Enter the Maximum Transmission Unit size. The default value is 1500.

DNS Server 1: Enter the primary DNS server address provided by your ISP.

DNS Server 2: Enter the secondary DNS server address provided by your ISP.

MAC Clone: Select the MAC address to be used for the connection. Select **Default MAC** to use the router's MAC address. Select **MAC from PC** to copy your PC's MAC address, or select **MAC Manual** to manually enter a MAC address in the field provided.

Click **Save Settings** to save the current configuration, or click **Don't Save Settings** to discard.

INTERNET CONNECTION TYPE

Choose the mode to be used by the router to connect to the Internet.

Internet Connection Type :

STATIC IP ADDRESS INTERNET CONNECTION TYPE :

Enter the static address information provided by your Internet Service Provider (ISP).

IP Address :

Subnet Mask :

Default Gateway :

Primary DNS Server :

Secondary DNS Server :

MTU :

MAC Address :

If you choose PPPoE, please configure the following fields:

WAN Access Type: Select **PPPoE** from the drop-down menu.

User Name: Enter the user name provided to you by your ISP.

Password: Enter the password provided to you by your ISP.

Service Name: Enter the service name if your ISP provided you with one, otherwise leave this field empty.

MTU Size: Enter the Maximum Transmission Unit size. The default value is 1492.

Static IP Address: If your ISP or network administrator requires you to have a static IP address for your connection, enter it here.

Connection Type: Select **Continuous**, **Connect on Demand**, or **Manual** as the connection type from the drop-down menu. If you select Manual, the connect and disconnect buttons will be available.

Attain DNS Automatically: Click this if the DNS is to be obtained automatically.

Set DNS Manually: Click this to specify a DNS server. You can enter up to two DNS servers.

MAC Clone: Select the MAC address to be used for the connection. Select **Default MAC** to use the router's MAC address. Select **MAC from PC** to copy your PC's MAC address, or select **MAC Manual** to manually enter a MAC address in the field provided.

When you have finished configuring the WAN settings, click the **Save Settings** button.

INTERNET CONNECTION TYPE

Choose the mode to be used by the router to connect to the Internet.

Internet Connection Type : PPPoE (Username / Password) ▼

PPPOE INTERNET CONNECTION TYPE :

Enter the information provided by your Internet Service Provider (ISP).

Address Mode : Dynamic IP Static IP

IP Address :

Username :

Password :

Verify Password :

Service Name : (optional)

Connect mode select : Always on On demand Manual

Maximum Idle Time : (minutes, 0=infinite)

DNS Mode : Receive DNS from ISP Enter DNS Manually

Primary DNS Server :

Secondary DNS Server :

MTU :

MAC Address :

Wireless

• Wireless Settings

This page allows you to configure the wireless LAN settings. You can also configure the wireless encryption and wireless network parameters.

Enabled Access Point Mode: Use this to disable NAT on the router and turn it into an Access Point.

Enable Wireless: Enable SSID broadcast if you want the router to transmit its SSID publicly so other wireless devices can discover it.

Name (SSID): Enter the SSID name you want to use for your wireless network.

Mode: Use the dropdown menu to specify the wireless mode.

Channel: Use the dropdown menu to select the wireless channel.

Band Width: Use the dropdown menu to select the channel bandwidth. If you selected the 802.11ac, 802.11n, 802.11 b/g, or 802.11 b/g/n wireless modes, the available options are 20 MHz and 20/40 MHz. 20/40/80MHz(Auto) For the others, 20 MHz is the only option.

Security Options: Select a wireless security encryption option. You can also choose to not use one by selecting **None**, but this is not recommended.

DIR-516 //	SETUP	TOOLS	STATUS	SUPPORT	Helpful Hints...
INTERNET	WIRELESS NETWORK				<ul style="list-style-type: none"> Changing your Wireless Network Name is the first step in securing your wireless network. We recommend that you change it to a familiar name that does not contain any personal information. Enable Auto Channel Scan the router can select the best possible channel for your wireless network to operate on. Enabling Hidden Mode is another way to secure your network. With this option enabled, no wireless clients will be able to see your wireless network when they perform a scan to see what's available. In order for your wireless devices to connect to your router, you will need to manually enter the Wireless Network Name on each device. If you have enabled Wireless Security, make sure you write down the WEP Key or Passphrase that you have configured. You will need to enter this information on any wireless device that you connect to your wireless network.
WIRELESS SETTINGS	Use this section to configure the wireless settings for your D-Link router. Please note that changes made in this section may also need to be duplicated on your wireless client. To protect your privacy you can configure wireless security features. This device supports four wireless security modes including: WEP, WPA only, WPA2 only, and WPA/WPA2 (auto-detect). <input type="button" value="Save Settings"/> <input type="button" value="Don't Save Settings"/>				
NETWORK SETTINGS	ACCESS POINT MODE				
WI-FI PROTECTED SETUP	Use this to disable NAT on the router and turn it into an Access Point. <input type="checkbox"/> Enabled Access Point Mode				
	WIRELESS NETWORK SETTINGS				
	Wireless Band : 5GHz Band Enable Wireless : <input checked="" type="checkbox"/> Wireless Network Name : DIR-516 (Also called the SSID) 802.11 Mode : Mixed 802.11ac, 802.11n and 802.11a Enable Auto Channel Scan : <input type="checkbox"/> Wireless Channel : 5.745 GHz - CH 149 Channel Width : 20/40/80 MHz(Auto) Visibility Status : <input checked="" type="radio"/> Visible <input type="radio"/> Invisible				
	WIRELESS SECURITY MODE				
	Security Mode : None <input type="button" value="Save Settings"/> <input type="button" value="Don't Save Settings"/>				

Wireless security helps to prevent unauthorized users from accessing your wireless network, or seeing data being passed between the router and wireless clients. The DIR-516 supports two popular wireless security protocols, you should select a protocol based on the wireless clients which will be accessing your network.

Wired Equivalent Privacy (WEP)

This is an older form of wireless security and should only be used if your wireless clients do not support the newer WPA or WPA2 protocols.

Security Options: Select **WEP** from the drop-down menu.

Authentication Type: Select either **Automatic** or **Shared Key** as the authentication type.

Encryption Strength: Select the encryption strength from the drop-down menu. **64-bit** - A 64-bit key comprises a string of 10 hexadecimal characters, or 5 ASCII characters. **128-bit** - A 128-bit key comprises a string of 26 hexadecimal characters, or 13 ASCII characters.

Key 1-4: You can predetermine up to 4 WEP keys. Select the WEP key you wish to use by clicking on the radio buttons next to the keys. Select whether you wish to use **HEX** or **ASCII** characters in your key using the drop-down menu. Enter the desired key in the field provided.

Click **Apply** to save the current settings.

WIRELESS SECURITY MODE

Security Mode :

WEP

WEP is the wireless encryption standard. To use it you must enter the same key(s) into the router and the wireless stations. For 64-bit keys you must enter 10 hex digits into each key box. For 128-bit keys you must enter 26 hex digits into each key box. A hex digit is either a number from 0 to 9 or a letter from A to F. For the most secure use of WEP set the authentication type to "Shared Key" when WEP is enabled.

You may also enter any text string into a WEP key box, in which case it will be converted into a hexadecimal key using the ASCII values of the characters. A maximum of 5 text characters can be entered for 64-bit keys, and a maximum of 13 characters for 128-bit keys.

WEP Key Length : (length applies to all keys)

Authentication :

WEP Key 1 :

Wi-Fi Protected Access (WPA/WPA2)

This is a newer and more secure protocol for wireless security. It uses a cipher combined with a pre-shared key (password) to encrypt data being sent over the wireless network. It is recommended that you use this security method if it is supported by your wireless clients.

Security Options: Select **WPA-PSK/WPA2-PSK AES** from the drop-down menu.

Pre-Shared Key: Enter a pre-shared key (password) to secure your wireless network. Wireless clients will require this password in order to connect to your network. It is recommended that you make a record of this password for future reference.

Click **Save Settings** to save the current settings.

WPA

Use **WPA or WPA2** mode to achieve a balance of strong security and best compatibility. This mode uses WPA for legacy clients while maintaining higher security with stations that are WPA2 capable. Also the strongest cipher that the client supports will be used. For best security, use **WPA2 Only** mode. This mode uses AES(CCMP) cipher and legacy stations are not allowed access with WPA security. For maximum compatibility, use **WPA Only**. This mode uses TKIP cipher. Some gaming and legacy devices work only in this mode.

To achieve better wireless performance use **WPA2 Only** security mode (or in other words AES cipher).

WPA Mode :

Cipher Type :

PRE-SHARED KEY

Enter an 8- to 63-character alphanumeric pass-phrase. For good security it should be of ample length and should not be a commonly known phrase.

Pre-Shared Key :

Wi-Fi Protected (WPS) Setup

Wi-Fi Protected Setup (WPS) System is a simplified method for securely connecting new devices to your network. The process as easy as pressing a button (the Push-Button Connection method) or correctly entering the 8-digit code (the PIN method).

If you wish to use the Push-Button Connection (PBC) method, simply press the WPS button on the side of the router. The power LED will begin to flash. Within 120 seconds, press the WPS button on the device that you wish to connect. The power LED will turn solid green if the connection is successful.

To connect using the PIN method, click **Next** to begin the WPS setup process.

Enter the PIN for the wireless NIC and click **Start PIN**. If successful, you will then be taken to another screen and a message will tell you to run WPS in the client device within 2 minutes.

DIR-516	SETUP	TOOLS	STATUS	SUPPORT	
INTERNET	WI-FI PROTECTED SETUP				Helpful Hints... <ul style="list-style-type: none"> • Enable if other wireless devices you wish to include in the local network support Wi-Fi Protected Setup. • Only "Admin" account can change security settings. • Click Connect your Wireless Device to use Wi-Fi Protected Setup to add wireless devices to the wireless network.
WIRELESS SETTINGS	Wi-Fi Protected Setup is used to easily add devices to a network using a PIN or button press. Devices must support Wi-Fi Protected Setup in order to be configured by this method.				
NETWORK SETTINGS	If the PIN changes, the new PIN will be used in following Wi-Fi Protected Setup process. Clicking on "Don't Save Settings" button will not reset the PIN. However, if the new PIN is not saved, it will get lost when the device reboots or loses power. <input type="button" value="Save Settings"/> <input type="button" value="Don't Save Settings"/>				
WI-FI PROTECTED SETUP	WI-FI PROTECTED SETUP Enable : <input checked="" type="checkbox"/> Wi-Fi Protected Status : Enabled / Configured Lock WPS-PIN Setup : <input type="checkbox"/> <input type="button" value="Reset to Unconfigured"/>				
	PIN SETTINGS PIN : 12345670 <input type="button" value="Reset PIN to Default"/> <input type="button" value="Generate New PIN"/>				
	ADD WIRELESS STATION <input type="button" value="Connect your Wireless Device"/> <input type="button" value="Save Settings"/> <input type="button" value="Don't Save Settings"/>				

Firmware

This page allows you to upgrade the firmware of the router. If you plan to install new firmware, make sure the firmware you want to use is on the local hard drive of the computer. Please check the D-Link support site for firmware updates at <http://support.dlink.com>. You can download firmware upgrades to your hard drive from the D-Link support site.

Select File: After you have downloaded the new firmware, click **Browse** to locate the firmware update on your hard drive.

If you want to reset the router's settings to their default values, then check the **Automatically reset default after firmware upgraded** box.

Click the **Upload** button to upload a file to the router after you have selected it.

DIR-516	SETUP	TOOLS	STATUS	SUPPORT
ADMINISTRATOR SETTINGS	FIRMWARE UPDATE			
SYSTEM	<p>There may be new firmware for your router to improve functionality and performance. Click here to check for an upgrade on our support site.</p> <p>To upgrade the firmware, locate the upgrade file on the local hard drive with the Browse button. Once you have found the file to be used, click the Upload button to start the firmware upgrade.</p> <p>The language pack allows you to change the language of the user interface on the router. We suggest that you upgrade your current language pack if you upgrade the firmware. This ensures that any changes in the firmware are displayed correctly.</p> <p>To upgrade the language pack, locate the upgrade file on the local hard drive with the Browse button. Once you have found the file to be used, click the Upload button to start the language pack upgrade.</p>			
FIRMWARE	FIRMWARE INFORMATION			
	<p>Current Firmware Version : 1.00</p> <p>Current Firmware Date : Mon 25 Nov 2013</p> <p>Check Online Now for Latest Firmware Version : <input type="button" value="Check Now"/></p>			
	FIRMWARE UPGRADE			
	<p>Note: Some firmware upgrades reset the configuration options to the factory defaults. Before performing an upgrade, be sure to save the current configuration.</p> <p>To upgrade the firmware, your PC must have a wired connection to the router. Enter the name of the firmware upgrade file, and click on the Upload button.</p> <p>Upload : <input type="button" value="Choose File"/> No file chosen <input type="button" value="Upload"/></p>			
	LANGUAGE PACK UPGRADE			
	<p>Upload : <input type="button" value="Choose File"/> No file chosen <input type="button" value="Upload"/></p>			
	<p>Helpful Hints...</p> <ul style="list-style-type: none"> Firmware Update are released periodically to improve the functionality of your router and also to add features. If you run into a problem with a specific feature of the router, check our support site by clicking on the Click here to check for an upgrade on our support site and see if an updated version of firmware is available for your router. 			

System

This page allows you to save the router's current configuration file onto your computer's hard drive or load a saved file from your hard drive.

Click the **Save Settings to File** button to download the current configuration settings as a file onto your hard drive.

To load a previously saved settings file, click the **Browse** button to locate the file on your hard drive, then click the **Upload** button.

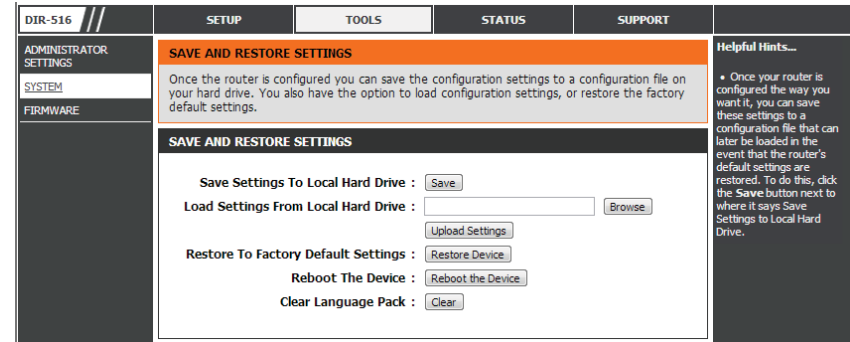

Admin

This page allows you to add a user account to the router's web server. You can also delete or modify existing accounts.

Confirm Password: Retype the new password.

To delete an existing account, click the **Select** tab next to the user account in the table and then click the **Delete** button.

The screenshot shows the web interface for the DIR-516 router. The top navigation bar includes 'DIR-516 //', 'SETUP', 'TOOLS', 'STATUS', and 'SUPPORT'. The left sidebar has 'ADMINISTRATOR SETTINGS', 'SYSTEM', and 'FIRMWARE'. The main content area is titled 'ADMINISTRATOR SETTINGS' and contains the following sections:

- ADMINISTRATOR SETTINGS**: A text block explaining that the 'admin' account has read/write access and can change its password. It notes that by default, there is no password configured and recommends creating one for security. Below this text are two buttons: 'Save Settings' and 'Don't Save Settings'.
- ADMIN PASSWORD**: A section with the instruction 'Please enter the same password into both boxes, for confirmation.' It contains two input fields labeled 'Password :' and 'Verify Password :'.
- REMOTE MANAGEMENT**: A section with a checkbox for 'Enable Remote Management :', which is currently unchecked, and a text input field for 'Remote Admin Port :'. Below these are 'Save Settings' and 'Don't Save Settings' buttons.

On the right side of the interface, there is a 'Helpful Hints...' section with a bullet point: '• For security reasons, it is recommended that you change the password for the Admin account. Be sure to write down the new password to avoid having to reset the router in case they are forgotten.'

Status

Device Info

This page displays the current status and basic settings of the router.

System: Displays the router's time and firmware version.

LAN Configuration: Displays the MAC address and the private (local) IP settings for the router.

WLAN Configuration: Displays the wireless MAC address and your wireless settings such as SSID and Channel.

WAN Configuration: Displays the MAC address and the public IP settings for the router.

Click the **Refresh** button to view the most current information.

DIR-516 //	SETUP	TOOLS	STATUS	SUPPORT	
DEVICE INFO	DEVICE INFORMATION				Helpful Hints... • All of your LAN, Internet and WIRELESS connection details are displayed here.
STATISTICS	All of your Internet and network connection details are displayed on this page. The firmware version is also displayed here.				
WIRELESS	GENERAL				
	Time : 2000/01/02,03:15:21 Firmware Version : 1.00 Mon 25 Nov 2013				
	WAN				
	Connection Type : DHCP Client Cable Status : Connected Network Status : Connected <input type="button" value="Renew"/> <input type="button" value="Release"/> Connection Up Time : 1 Day 2 Hour 46 Min 7 Sec MAC Address : 00:88:81:48:28:59 IP Address : 172.17.5.166 Subnet Mask : 255.255.255.0 Default Gateway : 172.17.5.254 Primary DNS Server : 192.168.168.249 Secondary DNS Server : 192.168.168.201				
	LAN				
	MAC Address : 00:88:81:48:28:58 IP Address : 192.168.0.1 Subnet Mask : 255.255.255.0 DHCP Server : Enabled				
	WIRELESS LAN				
	Wireless : Enabled MAC Address : 00:88:81:48:28:58 802.11 Mode : Mixed 802.11ac, 802.11n and 802.11a Channel Width : 20/40/80 MHz(Auto) Channel : 149 Network Name (SSID) : DIR-516 Security : Disabled				

Wireless

This page displays lists of all wired and wireless clients. The IP address and MAC address of each client is displayed in the tables.

Active Wired Client Table: This table displays all active wired clients.

Active Wireless Client Table: This table displays all active wireless clients.

The screenshot shows the D-Link DIR-516 web interface. At the top, there is a navigation menu with 'SETUP', 'TOOLS', 'STATUS', and 'SUPPORT'. The 'STATUS' tab is selected. Below the navigation menu, there is a 'STATISTICS' section. The 'STATISTICS' section contains a table with the following data:

	Receive	Transmit
Internet	1384116 Packets	79497 Packets
LAN	880 Packets	8010 Packets
WIRELESS 11n	91392 Packets	80757 Packets

Below the table, there are 'Refresh' and 'Reset' buttons. To the right of the statistics table, there is a 'Helpful Hints...' section with the following text: 'This is a summary displaying the number of packets that have passed between the Internet and the LAN since the router was last initialized.'

Statistics

This page displays the statistics for packets that have been transmitted and received on the network on the router’s WAN and LAN ports, and wireless bands.

D-Link				
DIR-516 //	SETUP	TOOLS	STATUS	SUPPORT
DEVICE INFO	CONNECTED WIRELESS CLIENT LIST			Helpful Hints... • This is a list of all wireless clients that are currently connected to your wireless router.
STATISTICS	View the wireless clients that are connected to the router. (A client might linger in the list for a few minutes after an unexpected disconnect.)			
WIRELESS	NUMBER OF WIRELESS CLIENTS: 2			
	SSID	MAC Address	IP Address	
	DIR-516	80:ea:96:36:9b:9e	192.168.0.101	11N
	DIR-516	78:54:2e:03:82:65	192.168.0.103	11AC

Click the **Refresh** button to refresh the router’s traffic statistics.

Support

This section provides an explanation of each configuration or setting for the DIR-516. Click on the links to be taken to the help text for that particular section of router's setup.

DIR-516 //	SETUP	TOOLS	STATUS	SUPPORT
MENU	SUPPORT MENU			
SETUP	<ul style="list-style-type: none">• Setup• Tools• Status			
TOOLS	SETUP HELP			
STATUS	<ul style="list-style-type: none">• Internet• Wireless Settings• Network Settings• Wi-Fi Protected Setup			
	TOOLS HELP			
	<ul style="list-style-type: none">• Administrator Setting• System• Firmware			
	STATUS HELP			
	<ul style="list-style-type: none">• Device Info• Statistics• Wireless			

Access Point Mode Manual Configuration

This section will show you how to configure your new D-Link wireless router using the web-based configuration utility.

To access the configuration utility, open a web-browser such as Internet Explorer and enter the IP address of the router (192.168.0.50).



Enter **admin** in the User Name field. Leave the password blank as the default password.

If you get a **Page Cannot be Displayed** error, please refer to the **Troubleshooting** section for assistance.

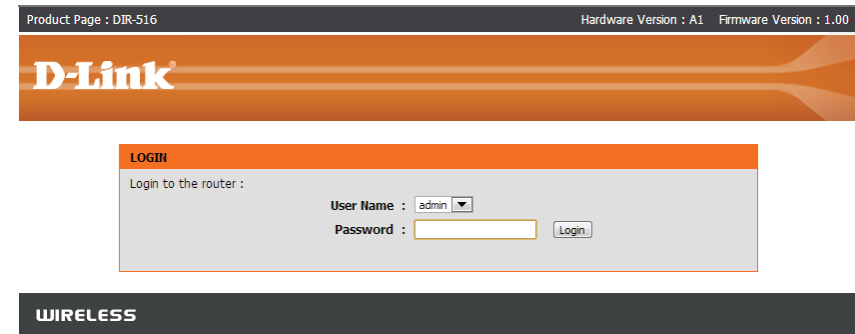

Setup Local Network

This section will allow you to change the local network settings of the access point.

IP Address: Enter the IP address of the access point.

Subnet Mask: Enter the subnet mask of the access point.

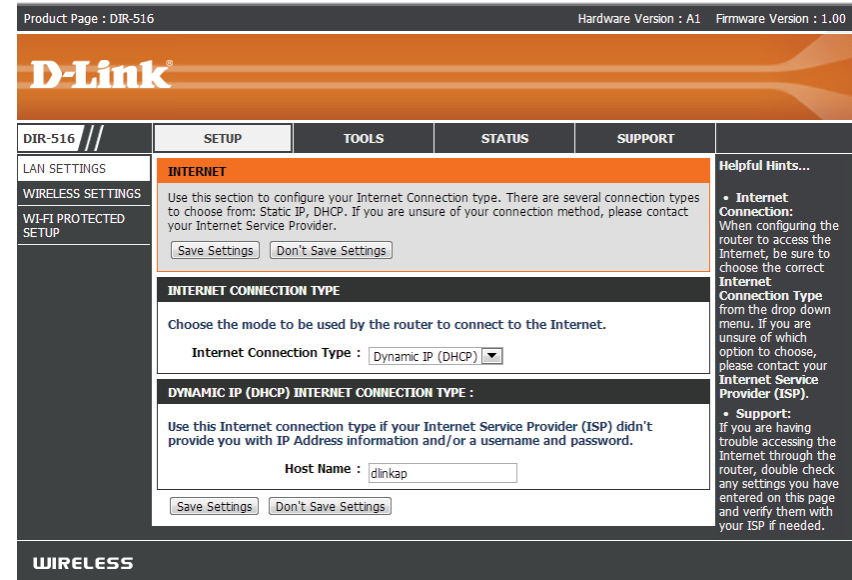

Wireless

Wireless Settings

This page allows you to configure the wireless LAN settings. You can also configure the wireless encryption and wireless network parameters.

Enabled Access Point Mode: Use this to disable NAT on the router and turn it into an Access Point.

Enable SSID Broadcast: Enable SSID broadcast if you want the router to transmit its SSID publicly so other wireless devices can discover it.

Enable Wireless Isolation: Enable wireless isolation to prevent connected wireless devices from connecting to other wireless devices that are also connected to the router.

Name (SSID): Enter the SSID name you want to use for the wireless network.

Mode: Use the dropdown menu to specify the wireless mode.

Channel: Use the dropdown menu to select the wireless channel.

Band Width: Use the dropdown menu to select the channel bandwidth. If you selected the 802.11n, 802.11 b/g, or 802.11 b/g/n wireless modes, the available options are 20 MHz and 20/40 MHz. For the others, 20 MHz is the only option.

Security Options: Select a wireless security encryption option. You can also choose to not use one by selecting **None**, but this is not recommended.

DIR-516 //	SETUP	TOOLS	STATUS	SUPPORT	Helpful Hints...
LAN SETTINGS	WIRELESS NETWORK				<ul style="list-style-type: none"> Changing your Wireless Network Name is the first step in securing your wireless network. We recommend that you change it to a familiar name that does not contain any personal information. Enable Auto Channel Scan the router can select the best possible channel for your wireless network to operate on. Enabling Hidden Mode is another way to secure your network. With this option enabled, no wireless clients will be able to see your wireless network when they perform a scan to see what's available. In order for your wireless devices to connect to your router, you will need to manually enter the Wireless Network Name on each device. If you have enabled Wireless Security, make sure you write down the WEP Key or Passphrase that you have configured. You will need to enter this information on any wireless device that you connect to your wireless network.
WIRELESS SETTINGS	Use this section to configure the wireless settings for your D-Link router. Please note that changes made in this section may also need to be duplicated on your wireless client. To protect your privacy you can configure wireless security features. This device supports four wireless security modes including: WEP, WPA only, WPA2 only, and WPA/WPA2 (auto-detect). <input type="button" value="Save Settings"/> <input type="button" value="Don't Save Settings"/>				
WI-FI PROTECTED SETUP	ACCESS POINT MODE Use this to disable NAT on the router and turn it into an Access Point. <input checked="" type="checkbox"/> Enabled Access Point Mode				
	WIRELESS NETWORK SETTINGS Wireless Band : 5GHz Band Enable Wireless : <input checked="" type="checkbox"/> Wireless Network Name : DIR-516 (Also called the SSID) 802.11 Mode : Mixed 802.11ac, 802.11n and 802.11a Enable Auto Channel Scan : <input type="checkbox"/> Wireless Channel : 5,745 GHz - CH 149 Channel Width : 20/40/80 MHz(Auto) Visibility Status : <input checked="" type="radio"/> Visible <input type="radio"/> Invisible				
	WIRELESS SECURITY MODE Security Mode : None <input type="button" value="Save Settings"/> <input type="button" value="Don't Save Settings"/>				

Wireless security helps to prevent unauthorized users from accessing your wireless network, or seeing data being passed between the router and wireless clients. The DIR-516 supports two popular wireless security protocols, you should select a protocol based on the wireless clients which will be accessing your network.

Wired Equivalent Privacy (WEP)

This is an older form of wireless security and should only be used if your wireless clients do not support the newer WPA or WPA2 protocols.

Security Select **WEP** from the drop-down menu.
Options:

Authentication Select either **Automatic** or **Shared Key** as the authentication
Type: type.

Encryption Select the encryption strength from the drop-down menu.
Strength: **64-bit** - A 64-bit key comprises a string of 10 hexadecimal characters, or 5 ASCII characters.
128-bit - A 128-bit key comprises a string of 26 hexadecimal characters, or 13 ASCII characters.

Key 1-4: You can predetermine up to 4 WEP keys. Select the WEP key you wish to use by clicking on the radio buttons next to the keys. Select whether you wish to use **HEX** or **ASCII** characters in your key using the drop-down menu. Enter the desired key in the field provided.

Click **Save Settings** to save the current settings.

WIRELESS SECURITY MODE

Security Mode :

WEP

WEP is the wireless encryption standard. To use it you must enter the same key(s) into the router and the wireless stations. For 64-bit keys you must enter 10 hex digits into each key box. For 128-bit keys you must enter 26 hex digits into each key box. A hex digit is either a number from 0 to 9 or a letter from A to F. For the most secure use of WEP set the authentication type to "Shared Key" when WEP is enabled.

You may also enter any text string into a WEP key box, in which case it will be converted into a hexadecimal key using the ASCII values of the characters. A maximum of 5 text characters can be entered for 64-bit keys, and a maximum of 13 characters for 128-bit keys.

WEP Key Length : (length applies to all keys)

Authentication :

WEP Key 1 :

Wi-Fi Protected Access (WPA/WPA2)

This is a newer and more secure protocol for wireless security. It uses a cipher combined with a pre-shared key (password) to encrypt data being sent over the wireless network. It is recommended that you use this security method if it is supported by your wireless clients.

Security Options: Select **WPA-PSK/WPA2-PSK AES** from the drop-down menu.

Pre-Shared Key: Enter a pre-shared key (password) to secure your wireless network. Wireless clients will require this password in order to connect to your network. It is recommended that you make a record of this password for future reference.

Click **Save Settings** to save the current settings.

WPA

Use **WPA** or **WPA2** mode to achieve a balance of strong security and best compatibility. This mode uses WPA for legacy clients while maintaining higher security with stations that are WPA2 capable. Also the strongest cipher that the client supports will be used. For best security, use **WPA2 Only** mode. This mode uses AES(CCMP) cipher and legacy stations are not allowed access with WPA security. For maximum compatibility, use **WPA Only**. This mode uses TKIP cipher. Some gaming and legacy devices work only in this mode.

To achieve better wireless performance use **WPA2 Only** security mode (or in other words AES cipher).

WPA Mode :

Cipher Type :

PRE-SHARED KEY

Enter an 8- to 63-character alphanumeric pass-phrase. For good security it should be of ample length and should not be a commonly known phrase.

Pre-Shared Key :

Wi-Fi Protected (WPS) Setup

Wi-Fi Protected Setup (WPS) System is a simplified method for securely connecting new devices to your network. The process is as easy as pressing a button (the Push-Button Connection method) or correctly entering the 8-digit code (the PIN method).

If you wish to use the Push-Button Connection (PBC) method, simply press the WPS button on the side of the router. The power LED will begin to flash. Within 120 seconds, press the WPS button on the device that you wish to connect. The power LED will turn solid green if the connection is successful.

To connect using the PIN method, click **Next** to begin the WPS setup process.

Enter the PIN for the wireless NIC and click **Start PIN**. If successful, you will then be taken to another screen and a message will tell you to run WPS in the client device within 2 minutes.

The screenshot displays the WPS setup interface for a D-Link DIR-516 router. The page is divided into several sections:

- Navigation:** A top bar with tabs for SETUP, TOOLS, STATUS, and SUPPORT. A left sidebar lists menu items: INTERNET, WIRELESS SETTINGS, NETWORK SETTINGS, and WI-FI PROTECTED SETUP.
- WI-FI PROTECTED SETUP (Introduction):** Explains that WPS is used to add devices via PIN or button press. It notes that devices must support WPS and that the PIN will be used in the following process. It also states that clicking "Don't Save Settings" will not reset the PIN. However, if the new PIN is not saved, it will be lost on a reboot. Buttons for "Save Settings" and "Don't Save Settings" are present.
- WI-FI PROTECTED SETUP (Configuration):** Shows the "Enable" checkbox checked. The "Wi-Fi Protected Status" is "Enabled / Configured". The "Lock WPS-PIN Setup" checkbox is unchecked. A "Reset to Unconfigured" button is available.
- PIN SETTINGS:** Displays the current PIN as "12345670". Buttons for "Reset PIN to Default" and "Generate New PIN" are provided.
- ADD WIRELESS STATION:** Features a "Connect your Wireless Device" button.
- Helpful Hints:** A sidebar on the right provides additional information:
 - Enable if other wireless devices you wish to include in the local network support Wi-Fi Protected Setup.
 - Only "Admin" account can change security settings.
 - Click **Connect your Wireless Device** to use Wi-Fi Protected Setup to add wireless devices to the wireless network.
- Footer:** "Save Settings" and "Don't Save Settings" buttons are located at the bottom of the main content area.

Maintenance

Reboot

This page allows you to reboot your router or reset it to the factory default settings.

Click the **Reboot** button to reboot the system. To reset the system to the factory default setting, click the **Reset** button. This will erase the current settings.

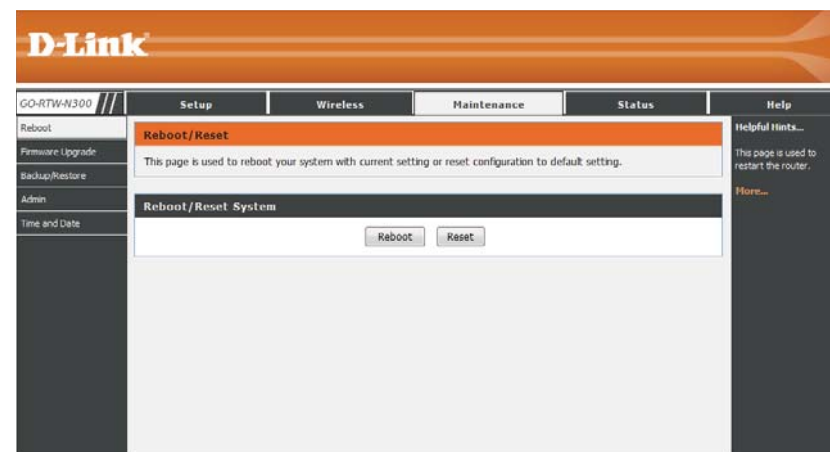

Firmware

This page allows you to upgrade the firmware of the router. If you plan to install new firmware, make sure the firmware you want to use is on the local hard drive of the computer. Please check the D-Link support site for firmware updates at <http://support.dlink.com>. You can download firmware upgrades to your hard drive from the D-Link support site.

Choose File: After you have downloaded the new firmware, click **Browse** to locate the firmware update on your hard drive.

Click the **Upload** button to upload a file to the router after you have selected it, or click the **Reset** button to cancel the selection.

DIR-516	SETUP	TOOLS	STATUS	SUPPORT
ADMINISTRATOR SETTINGS	FIRMWARE UPDATE			
SYSTEM	<p>There may be new firmware for your router to improve functionality and performance. Click here to check for an upgrade on our support site.</p> <p>To upgrade the firmware, locate the upgrade file on the local hard drive with the Browse button. Once you have found the file to be used, click the Upload button to start the firmware upgrade.</p> <p>The language pack allows you to change the language of the user interface on the router. We suggest that you upgrade your current language pack if you upgrade the firmware. This ensures that any changes in the firmware are displayed correctly.</p> <p>To upgrade the language pack, locate the upgrade file on the local hard drive with the Browse button. Once you have found the file to be used, click the Upload button to start the language pack upgrade.</p>			
FIRMWARE	<p>FIRMWARE INFORMATION</p> <p>Current Firmware Version : 1.00 Current Firmware Date : Mon 25 Nov 2013 Check Online Now for Latest Firmware Version : <input type="button" value="Check Now"/></p>			
	<p>FIRMWARE UPGRADE</p> <p>Note: Some firmware upgrades reset the configuration options to the factory defaults. Before performing an upgrade, be sure to save the current configuration.</p> <p>To upgrade the firmware, your PC must have a wired connection to the router. Enter the name of the firmware upgrade file, and click on the Upload button.</p> <p>Upload : <input type="button" value="Choose File"/> No file chosen <input type="button" value="Upload"/></p>			
	<p>LANGUAGE PACK UPGRADE</p> <p>Upload : <input type="button" value="Choose File"/> No file chosen <input type="button" value="Upload"/></p>			
	<p>Helpful Hints...</p> <p>• Firmware Update are released periodically to improve the functionality of your router and also to add features. If you run into a problem with a specific feature of the router, check our support site by clicking on the Click here to check for an upgrade on our support site and see if an updated version of firmware is available for your router.</p>			

System

This page allows you to save the router's current configuration file onto your computer's hard drive or load a saved file from your hard drive.

Click the **Save** button to download the current configuration settings as a file onto your hard drive.

To load a previously saved settings file, click the **Browse** button to locate the file on your hard drive, then click the **Upload** button.

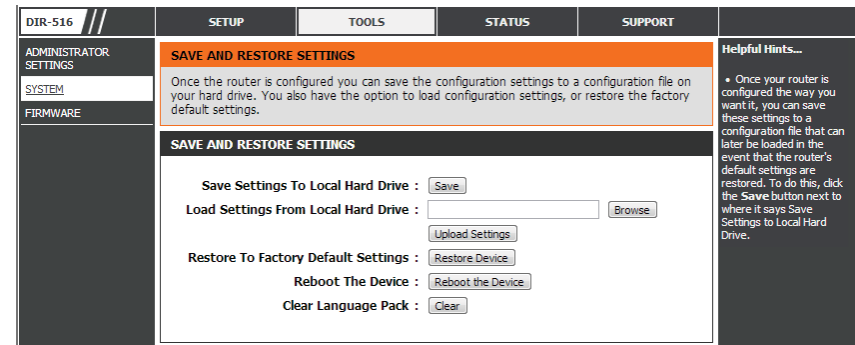

Admin

This page allows you to add a user account to the router's web server. You can also delete or modify existing accounts.

User Name: Enter a username.

Privilege: The user has root privilege.

Old Password: Enter the current password of the account.

New Password: Enter the new password for the account.

Confirm Password: Retype the new password.

The screenshot shows the 'ADMINISTRATOR SETTINGS' page in the D-Link DIR-516 web interface. The page has a dark sidebar on the left with navigation tabs for 'ADMINISTRATOR SETTINGS', 'SYSTEM', and 'FIRMWARE'. The main content area is divided into three sections:

- ADMINISTRATOR SETTINGS:** Contains a warning that the 'admin' account has full access and a recommendation to change the password. It includes 'Save Settings' and 'Don't Save Settings' buttons.
- ADMIN PASSWORD:** Requests the user to enter the same password in two boxes for confirmation. It has 'Password' and 'Verify Password' input fields.
- REMOTE MANAGEMENT:** Includes a checkbox for 'Enable Remote Management' and a 'Remote Admin Port' input field. It also has 'Save Settings' and 'Don't Save Settings' buttons.

On the right side, there is a 'Helpful Hints...' section with a note: 'For security reasons, it is recommended that you change the password for the Admin account. Be sure to write down the new password to avoid having to reset the router in case they are forgotten.'

Click the **Add** button to save any changes made. The user account will also be added to the User Account Table below. To modify an existing user account, click the **Select** tab next to the user account in the table, edit the user settings you wish to change, and then click the **Modify** button.

To delete an existing account, click the **Select** tab next to the user account in the table and then click the **Delete** button.

Status Device Info

This page displays the current status and basic settings of the router.

System: Displays the router's time and firmware version.

LAN Configuration: Displays the MAC address and the private (local) IP settings for the router.

WLAN Configuration: Displays the wireless MAC address and your wireless settings such as SSID and Channel.

WAN Configuration: Displays the MAC address and the public IP settings for the router.

Click the **Refresh** button to view the most current information.

DIR-516 //	SETUP	TOOLS	STATUS	SUPPORT	
DEVICE INFO	DEVICE INFORMATION				Helpful Hints... • All of your LAN, Internet and WIRELESS connection details are displayed here.
STATISTICS	All of your Internet and network connection details are displayed on this page. The firmware version is also displayed here.				
WIRELESS	GENERAL Time : 2000/01/02,03:15:21 Firmware Version : 1.00 Mon 25 Nov 2013				
	WAN Connection Type : DHCP Client Cable Status : Connected Network Status : Connected <input type="button" value="Renew"/> <input type="button" value="Release"/> Connection Up Time : 1 Day 2 Hour 46 Min 7 Sec MAC Address : 00:88:81:48:28:59 IP Address : 172.17.5.166 Subnet Mask : 255.255.255.0 Default Gateway : 172.17.5.254 Primary DNS Server : 192.168.168.249 Secondary DNS Server : 192.168.168.201				
	LAN MAC Address : 00:88:81:48:28:58 IP Address : 192.168.0.1 Subnet Mask : 255.255.255.0 DHCP Server : Enabled				
	WIRELESS LAN Wireless : Enabled MAC Address : 00:88:81:48:28:58 802.11 Mode : Mixed 802.11ac, 802.11n and 802.11a Channel Width : 20/40/80 MHz(Auto) Channel : 149 Network Name (SSID) : DIR-516 Security : Disabled				

Wireless

This page displays lists of all wired and wireless clients. The IP address and MAC address of each client is displayed in the tables.

Active Wired Client Table: This table displays all active wired clients.

Active Wireless Client Table: This table displays all active wireless clients.

Click the **Save Settings** button to save any changes made.

The screenshot shows the D-Link DIR-516 web interface. The top navigation bar includes 'DIR-516 //', 'SETUP', 'TOOLS', 'STATUS', and 'SUPPORT'. The 'WIRELESS' tab is selected in the left sidebar. The main content area displays the 'CONNECTED WIRELESS CLIENT LIST' table, which shows two wireless clients connected to the router. A 'Helpful Hints...' section on the right provides additional information about the list.

SSID	MAC Address	IP Address	Mode
DIR-516	80:ea:96:36:9b:9e	192.168.0.101	11N
DIR-516	78:54:2e:03:82:65	192.168.0.103	11AC

Statistics

This page displays the statistics for packets that have been transmitted and received on the network on the router's WAN and LAN ports, and wireless bands.

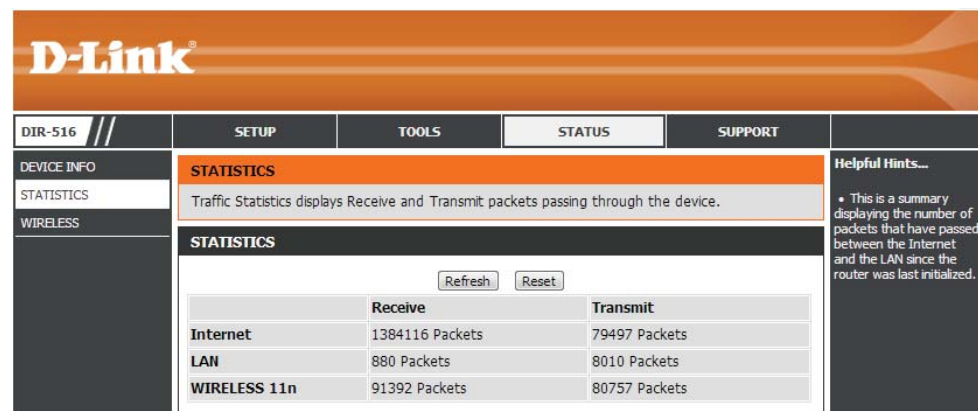

The screenshot shows the D-Link DIR-516 web interface. The top navigation bar includes 'DIR-516', 'SETUP', 'TOOLS', 'STATUS', and 'SUPPORT'. The left sidebar has 'DEVICE INFO', 'STATISTICS', and 'WIRELESS'. The main content area is titled 'STATISTICS' and contains a description: 'Traffic Statistics displays Receive and Transmit packets passing through the device.' Below this is a table with 'Refresh' and 'Reset' buttons. The table shows the following data:

	Receive	Transmit
Internet	1384116 Packets	79497 Packets
LAN	880 Packets	8010 Packets
WIRELESS 11n	91392 Packets	80757 Packets

Helpful Hints...
• This is a summary displaying the number of packets that have passed between the Internet and the LAN since the router was last initialized.

Click the **Refresh** button to refresh the router's traffic statistics.

Support

This section provides an explanation of each configuration or setting for the DIR-516. Click on the links to be taken to the help text for that particular section of router's setup.

DIR-516 //	SETUP	TOOLS	STATUS	SUPPORT
MENU	SUPPORT MENU			
SETUP	<ul style="list-style-type: none">• Setup• Tools• Status			
TOOLS				
STATUS				
	SETUP HELP			
	<ul style="list-style-type: none">• Internet• Wireless Settings• Network Settings• Wi-Fi Protected Setup			
	TOOLS HELP			
	<ul style="list-style-type: none">• Administrator Setting• System• Firmware			
	STATUS HELP			
	<ul style="list-style-type: none">• Device Info• Statistics• Wireless			

Connecting a Wireless Client

WPS Button

The easiest and most secure way to connect your wireless devices to the router is WPS (Wi-Fi Protected Setup). Many wireless devices will have a WPS button (or a software utility with WPS) that you can press to connect to the DIR-516 router. Please refer to your user manual for the wireless device you want to connect to make sure you understand how to enable WPS on it.

Step 1 - Press the WPS button on the DIR-516 for about 1 second. The WPS button will start to blink.

Step 2 - Within 2 minutes, press the WPS button on your wireless client (or launch the software utility and start the WPS process).

Step 3 - Allow up to 1 minute for the devices to configure your connection. Once the WPS light stops blinking, you will be connected and your wireless connection will be secure with WPA2.

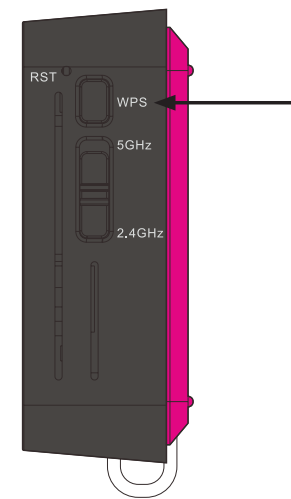

Windows® 8

WPA/WPA2

It is recommended to enable wireless security (WPA/WPA2) on your wireless router or access point before configuring your wireless adapter. If you are joining an existing network, you will need to know the security key (Wi-Fi password) being used.

To join an existing network, locate the wireless network icon in the taskbar, next to the time display.



Clicking on this icon will display a list of wireless networks which are within connecting proximity of your computer. Select the desired network by clicking on the network name.

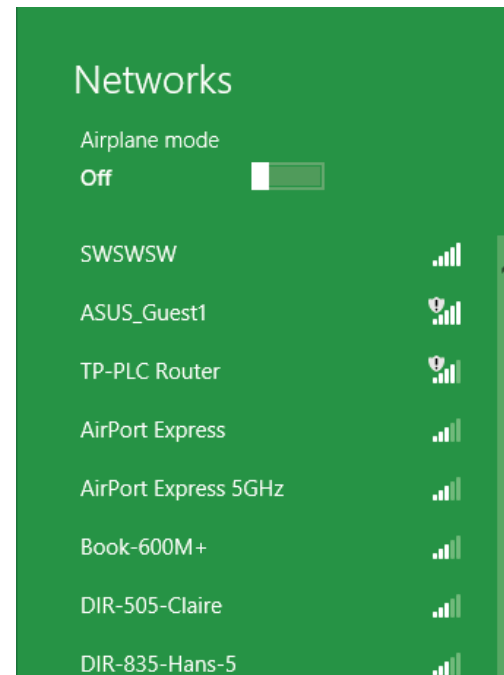

You will then be prompted to enter the network security key (Wi-Fi password) for the wireless network. Enter the password into the box and click **Next**.

If you wish to use Wi-Fi Protected Setup (WPS) to connect to the router, you can also press the WPS button on your router at the point to enable the WPS function.

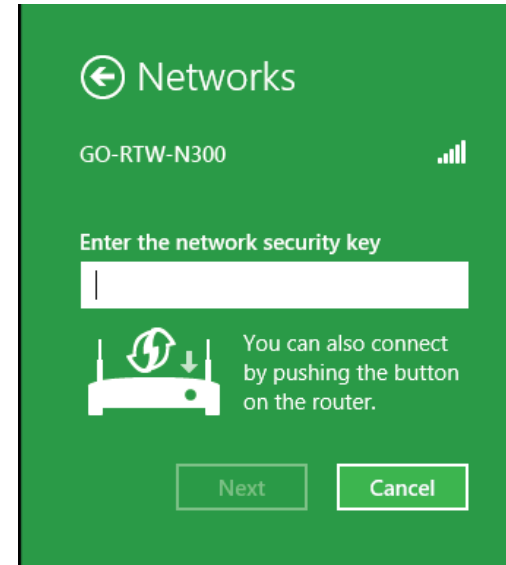

When you have established a successful connection a wireless network, the word **Connected** will appear next to the name of the network to which you are connected.

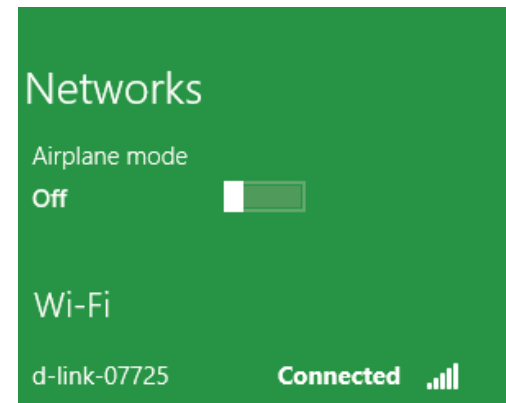

Windows® 7

WPA/WPA2

It is recommended to enable wireless security (WPA/WPA2) on your wireless router or access point before configuring your wireless adapter. If you are joining an existing network, you will need to know the security key or passphrase being used.

1. Click on the wireless icon in your system tray (lower-right corner).



Wireless Icon

2. The utility will display any available wireless networks in your area.



3. Highlight the wireless network (SSID) you would like to connect to and click the **Connect** button.

If you get a good signal but cannot access the Internet, check your TCP/IP settings for your wireless adapter. Refer to the Networking Basics section in this manual for more information.



4. The following window appears while your computer tries to connect to the router.

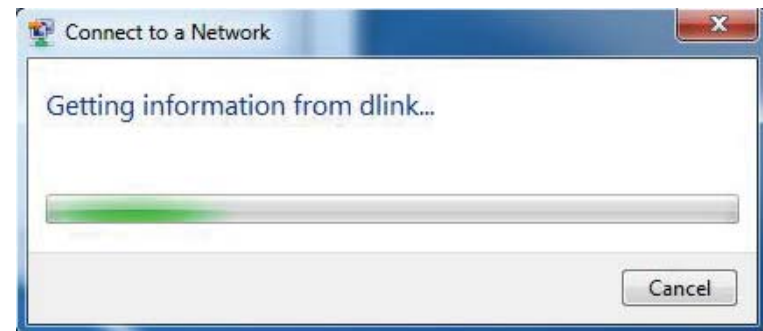

5. Enter the same security key or passphrase that is on your router and click **Connect**. You can also connect by pushing the WPS button on the router.

It may take 20-30 seconds to connect to the wireless network. If the connection fails, please verify that the security settings are correct. The key or passphrase must be exactly the same as on the wireless router.

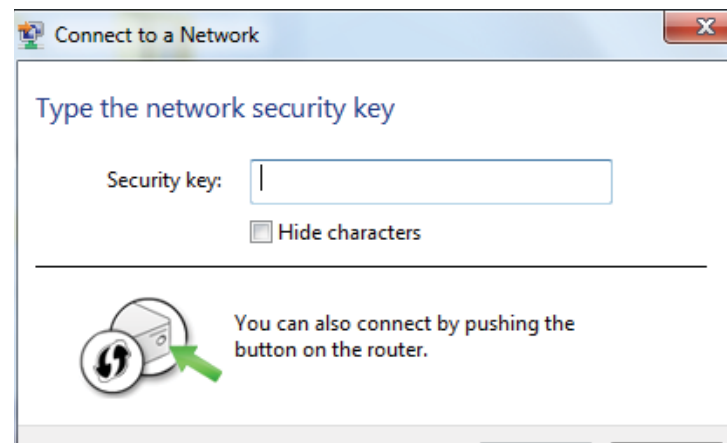

WPS

The WPS feature of the DIR-516 can be configured using Windows® 7. Carry out the following steps to use Windows® 7 to configure the WPS feature:

1. Click the **Start** button and select **Computer** from the Start menu.

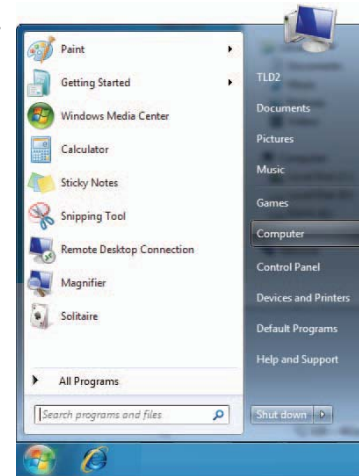

2. Click **Network** on the left side.

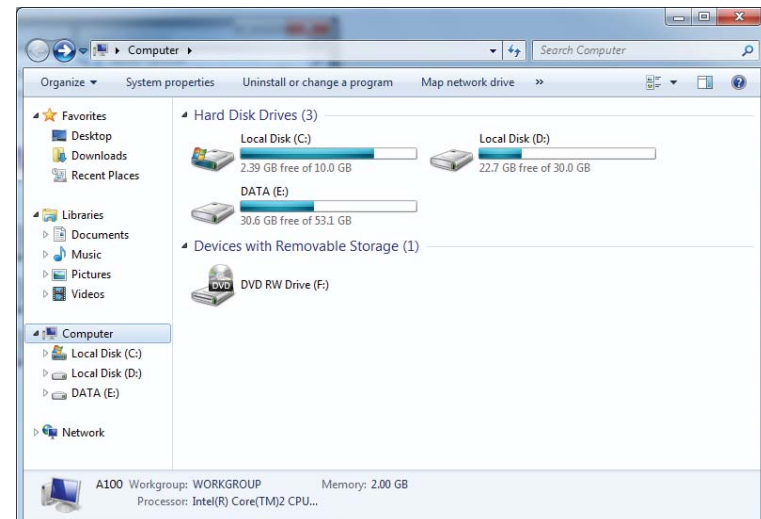

3. Double-click the DIR-516.

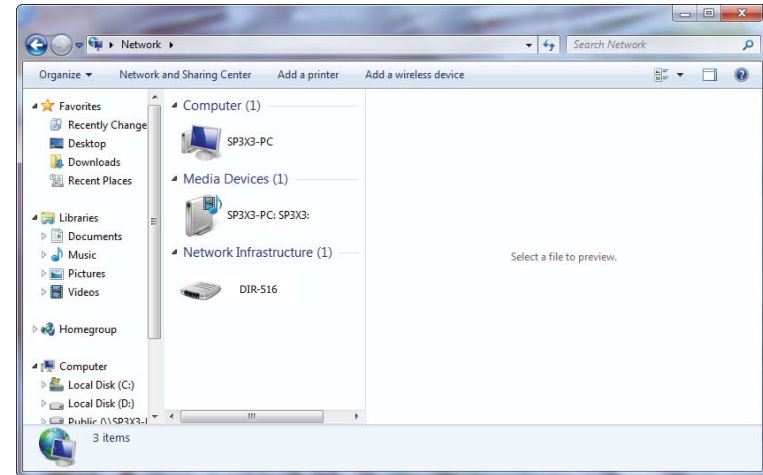

4. Input the WPS PIN number (displayed in the WPS window on the Router's LCD screen or in the **Setup > Wireless Setup** menu in the Router's Web UI) and click **Next**.

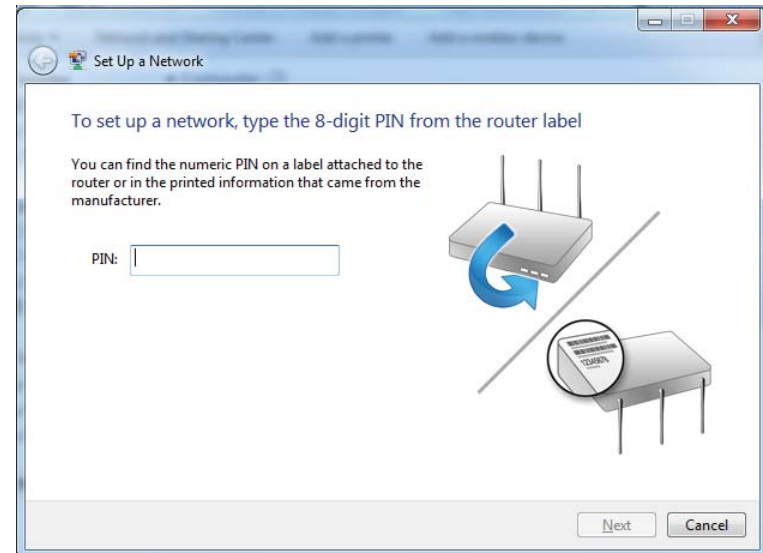

5. Type a name to identify the network.

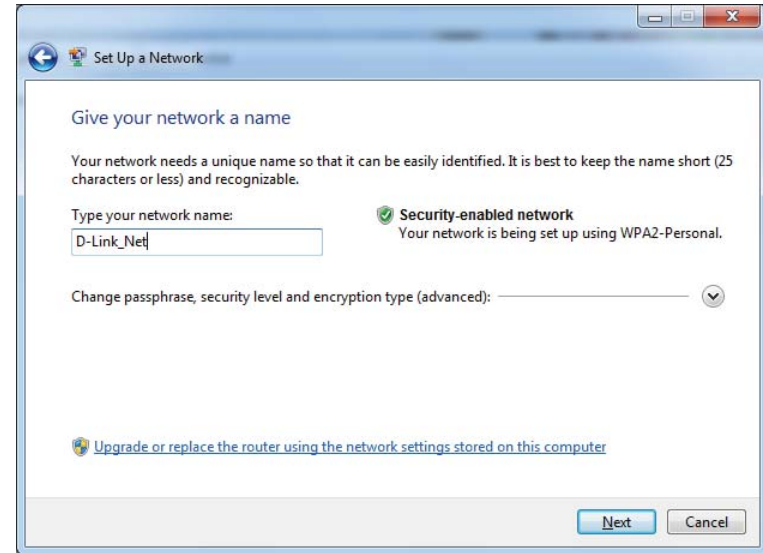

6. To configure advanced settings, click the  icon.

Click **Next** to continue.

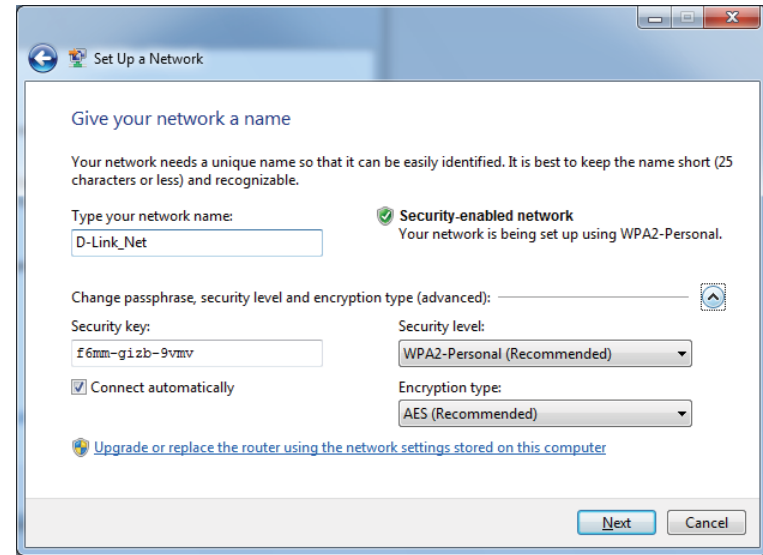

- The following window appears while the Router is being configured.

Wait for the configuration to complete.

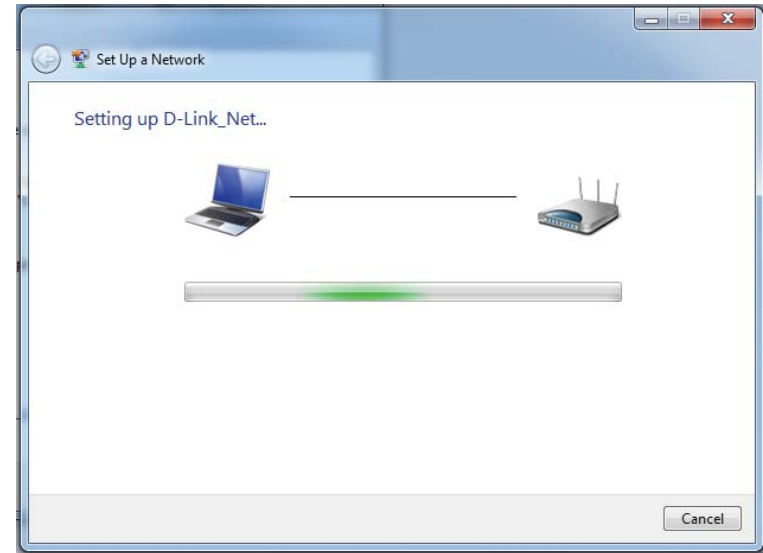

- The following window informs you that WPS on the router has been setup successfully.

Make a note of the security key as you may need to provide this security key if adding an older wireless device to the network in the future.

- Click **Close** to complete WPS setup.

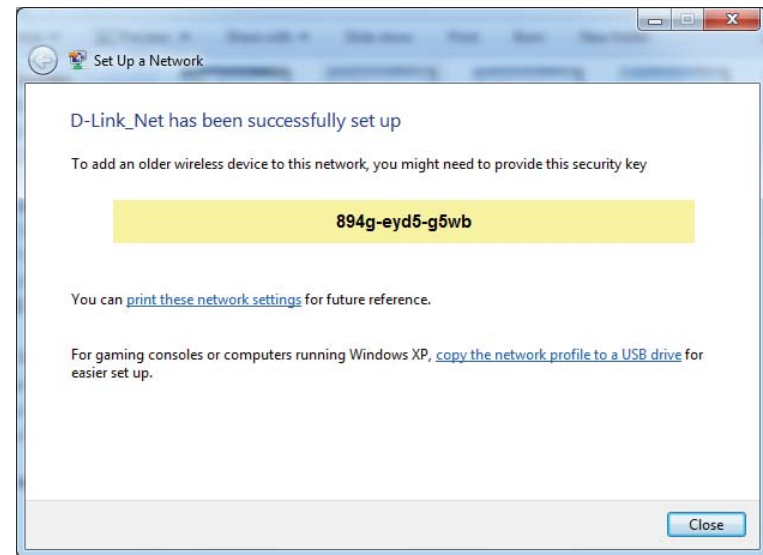

Windows Vista®

Windows Vista® users may use the built-in wireless utility. If you are using another company's utility or Windows® 2000, please refer to the user manual of your wireless adapter for help with connecting to a wireless network. Most utilities will have a "site survey" option similar to the Windows Vista® utility as seen below.

If you receive the **Wireless Networks Detected** bubble, click on the center of the bubble to access the utility.

or

Right-click on the wireless computer icon in your system tray (lower-right corner next to the time). Select **Connect to a network**.

The utility will display any available wireless networks in your area. Click on a network (displayed using the SSID) and click the **Connect** button.

If you get a good signal but cannot access the Internet, check you TCP/IP settings for your wireless adapter. Refer to the **Networking Basics** section in this manual for more information.

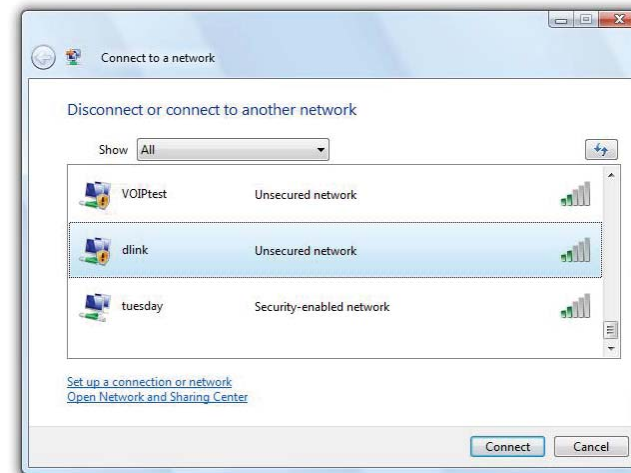

WPA/WPA2

It is recommended to enable wireless security (WPA/WPA2) on your wireless router or access point before configuring your wireless adapter. If you are joining an existing network, you will need to know the security key or passphrase being used.

1. Open the Windows Vista® Wireless Utility by right-clicking on the wireless computer icon in your system tray (lower right corner of screen). Select **Connect to a network**.



2. Highlight the wireless network (SSID) you would like to connect to and click **Connect**.

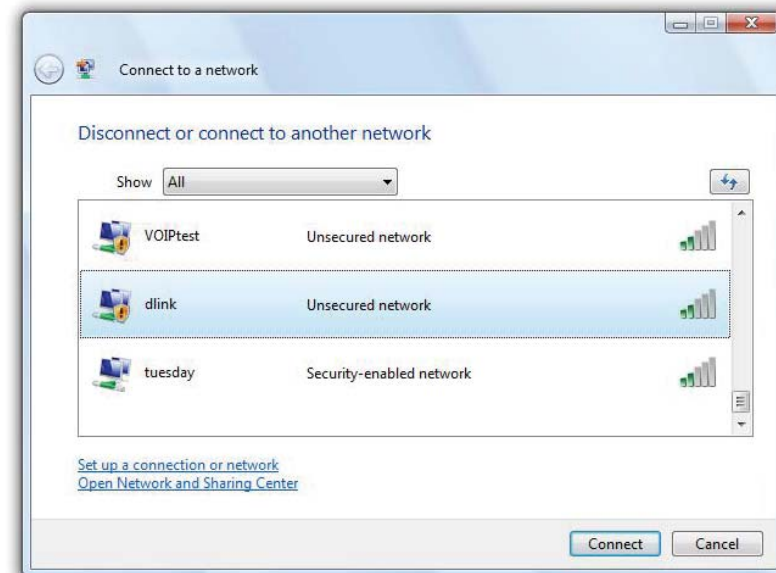

3. Enter the same security key or passphrase that is on your router and click **Connect**.

It may take 20-30 seconds to connect to the wireless network. If the connection fails, please verify that the security settings are correct. The key or passphrase must be exactly the same as on the wireless router.



WPS/WCN 2.0

The router supports Wi-Fi protection, referred to as WCN 2.0 in Windows Vista®. The following instructions for setting this up depends on whether you are using Windows Vista® to configure the router or third party software.

When you first set up the router, Wi-Fi protection is disabled and unconfigured. To enjoy the benefits of Wi-Fi protection, the router must be both enabled and configured. There are three basic methods to accomplish this: use Windows Vista's built-in support for WCN 2.0, use software provided by a third party, or manually configure.

If you are running Windows Vista®, log into the router and click the **Enable** checkbox in the **Basic > Wireless** section. Use the Current PIN that is displayed on the **Advanced > Wi-Fi Protected Setup** section or choose to click the **Generate New PIN** button or **Reset PIN to Default** button.

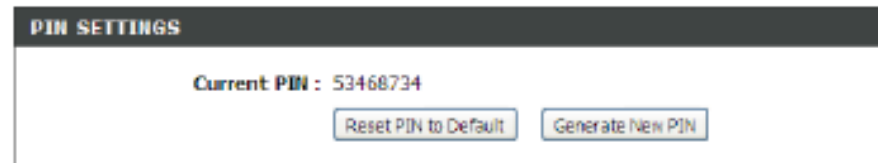

If you are using third party software to set up Wi-Fi Protection, carefully follow the directions. When you are finished, proceed to the next section to set up the newly-configured router.

Windows® XP

Windows® XP users may use the built-in wireless utility (Zero Configuration Utility). The following instructions are for Service Pack 2 users. If you are using another company's utility, please refer to the user manual of your wireless adapter for help with connecting to a wireless network. Most utilities will have a "site survey" option similar to the Windows® XP utility as seen below.

If you receive the **Wireless Networks Detected** bubble, click on the center of the bubble to access the utility.

or

Right-click on the wireless computer icon in your system tray (lower-right corner next to the time). Select **View Available Wireless Networks**.

The utility will display any available wireless networks in your area. Click on a network (displayed using the SSID) and click the **Connect** button.

If you get a good signal but cannot access the Internet, check you TCP/IP settings for your wireless adapter. Refer to the **Networking Basics** section in this manual for more information.

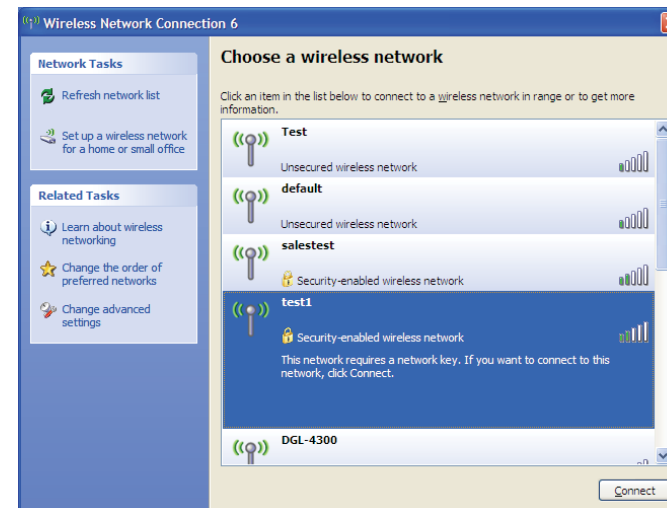
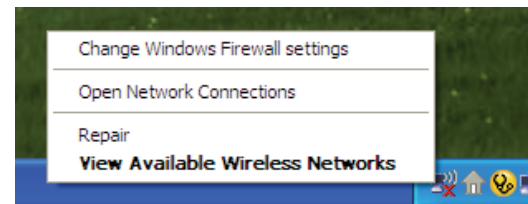
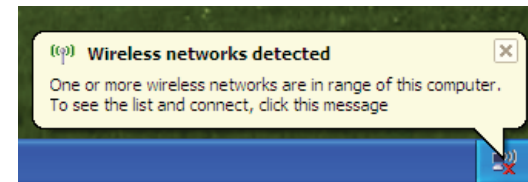

WPA/WPA2

It is recommended to enable WPA on your wireless router or access point before configuring your wireless adapter. If you are joining an existing network, you will need to know the WPA key being used.

1. Open the Windows® XP Wireless Utility by right-clicking on the wireless computer icon in your system tray (lower-right corner of screen). Select **View Available Wireless Networks**.

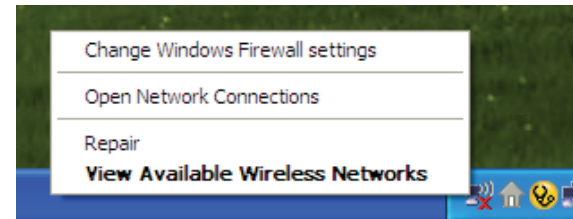

2. Highlight the wireless network (SSID) you would like to connect to and click **Connect**.

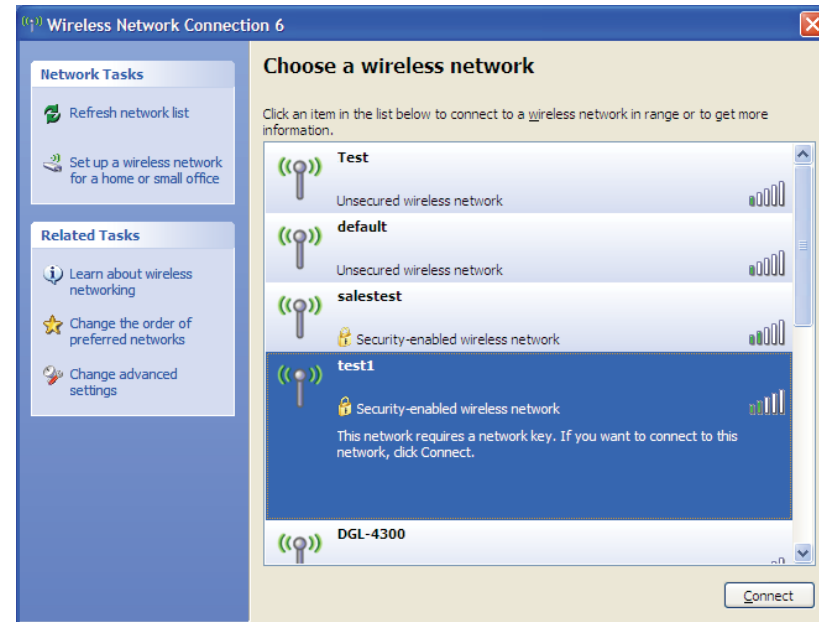

3. The **Wireless Network Connection** box will appear. Enter the WPA-PSK passphrase and click **Connect**.

It may take 20-30 seconds to connect to the wireless network. If the connection fails, please verify that the WPA-PSK settings are correct. The WPA-PSK passphrase must be exactly the same as on the wireless router.

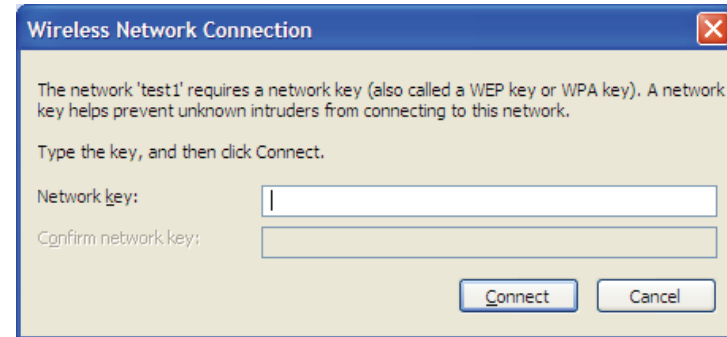

Troubleshooting

This chapter provides solutions to problems that can occur during the installation and operation of the DIR-516. Read the following descriptions if you are having problems. The examples below are illustrated in Windows® XP. If you have a different operating system, the screenshots on your computer will look similar to the following examples.

1. Why can't I access the web-based configuration utility?

When entering the IP address of the D-Link router (192.168.0.1 for example), you are not connecting to a website nor do you have to be connected to the Internet. The device has the utility built-in to a ROM chip in the device itself. Your computer must be on the same IP subnet to connect to the web-based utility.

- Make sure you have an updated Java-enabled web browser. We recommend the following:
 - Microsoft Internet Explorer® 6.0 and higher
 - Mozilla Firefox 3.0 and higher
 - Google™ Chrome 2.0 and higher
 - Apple Safari 3.0 and higher
- Verify physical connectivity by checking for solid link lights on the device. If you do not get a solid link light, try using a different cable or connect to a different port on the device if possible. If the computer is turned off, the link light may not be on.
- Disable any Internet security software running on the computer. Software firewalls such as ZoneAlarm, BlackICE, Sygate, Norton Personal Firewall, and Windows® XP firewall may block access to the configuration pages. Check the help files included with your firewall software for more information on disabling or configuring it.

- Configure your Internet settings:
 - Go to **Start > Settings > Control Panel**. Double-click the **Internet Options** icon. From the **Security** tab, click the button to restore the settings to their defaults.
 - Click the **Connection** tab and set the dial-up option to Never Dial a Connection. Click the LAN Settings button. Make sure nothing is checked. Click **OK**.
 - Go to the **Advanced** tab and click the button to restore these settings to their defaults. Click **OK** three times.
 - Close your web browser (if open) and open it.
- Access the web management. Open your web browser and enter the IP address of your D-Link router in the address bar. This should open the login page for your web management.
- If you still cannot access the configuration, unplug the power to the router for 10 seconds and plug back in. Wait about 30 seconds and try accessing the configuration. If you have multiple computers, try connecting using a different computer.

2. What can I do if I forgot my password?

If you forgot your password, you must reset your router. Unfortunately this process will change all your settings back to the factory defaults.

To reset the router, locate the reset button (hole) on the rear panel of the unit. With the router powered on, use a paperclip to hold the button down for 10 seconds. Release the button and the router will go through its reboot process. Wait about 30 seconds to access the router. The default IP address is 192.168.0.1. When logging in, the username is **admin** and leave the password box empty.

3. Why can't I connect to certain sites or send and receive emails when connecting through my router?

If you are having a problem sending or receiving email, or connecting to secure sites such as eBay, banking sites, and Hotmail, we suggest lowering the MTU in increments of ten (Ex. 1492, 1482, 1472, etc).

To find the proper MTU Size, you'll have to do a special ping of the destination you're trying to go to. A destination could be another computer, or a URL.

- Click on **Start** and then click **Run**.
- Windows® 95, 98, and Me users type in **command** (Windows® NT, 2000, XP, Vista®, 7 and 8 users type in **cmd**) and press **Enter** (or click **OK**).
- Once the window opens, you'll need to do a special ping. Use the following syntax:

ping [url] [-f] [-l] [MTU value]

Example: **ping yahoo.com -f -l 1472**

```
C:\>ping yahoo.com -f -l 1482

Pinging yahoo.com [66.94.234.13] with 1482 bytes of data:

Packet needs to be fragmented but DF set.
Packet needs to be fragmented but DF set.
Packet needs to be fragmented but DF set.
Packet needs to be fragmented but DF set.

Ping statistics for 66.94.234.13:
    Packets: Sent = 4, Received = 0, Lost = 4 (100% loss),
    Approximate round trip times in milli-seconds:
        Minimum = 0ms, Maximum = 0ms, Average = 0ms

C:\>ping yahoo.com -f -l 1472

Pinging yahoo.com [66.94.234.13] with 1472 bytes of data:

Reply from 66.94.234.13: bytes=1472 time=93ms TTL=52
Reply from 66.94.234.13: bytes=1472 time=109ms TTL=52
Reply from 66.94.234.13: bytes=1472 time=125ms TTL=52
Reply from 66.94.234.13: bytes=1472 time=203ms TTL=52

Ping statistics for 66.94.234.13:
    Packets: Sent = 4, Received = 4, Lost = 0 (0% loss),
    Approximate round trip times in milli-seconds:
        Minimum = 93ms, Maximum = 203ms, Average = 132ms

C:\>
```

You should start at 1472 and work your way down by 10 each time. Once you get a reply, go up by 2 until you get a fragmented packet. Take that value and add 28 to the value to account for the various TCP/IP headers. For example, let's say that 1452 was the proper value, the actual MTU size would be 1480, which is the optimum for the network we're working with ($1452+28=1480$).

Once you find your MTU, you can now configure your router with the proper MTU size.

To change the MTU rate on your router follow the steps below:

- Open your browser, enter the IP address of your router (192.168.0.1) and click **OK**.
- Enter your username (admin) and password (blank by default). Click **OK** to enter the web configuration page for the device.
- Click on **Setup** and then click **Manual Configure**.
- To change the MTU enter the number in the MTU field and click **Save Settings** to save your settings.
- Test your email. If changing the MTU does not resolve the problem, continue changing the MTU in increments of ten.

Wireless Basics

D-Link wireless products are based on industry standards to provide easy-to-use and compatible high-speed wireless connectivity within your home, business or public access wireless networks. Strictly adhering to the IEEE standard, the D-Link wireless family of products will allow you to securely access the data you want, when and where you want it. You will be able to enjoy the freedom that wireless networking delivers.

A wireless local area network (WLAN) is a cellular computer network that transmits and receives data with radio signals instead of wires. Wireless LANs are used increasingly in both home and office environments, and public areas such as airports, coffee shops, and universities. Innovative ways to utilize WLAN technology are helping people to work and communicate more efficiently. Increased mobility and the absence of cabling and other fixed infrastructure have proven to be beneficial for many users.

Wireless users can use the same applications they use on a wired network. Wireless adapter cards used on laptop and desktop systems support the same protocols as Ethernet adapter cards.

Under many circumstances, it may be desirable for mobile network devices to link to a conventional Ethernet LAN in order to use servers, printers or an Internet connection supplied through the wired LAN. A wireless router is a device used to provide this link.

What is Wireless?

Wireless or Wi-Fi technology is another way of connecting your computer to the network without using wires. Wi-Fi uses radio frequency to connect wirelessly, so you have the freedom to connect computers anywhere in your home or office network.

Why D-Link Wireless?

D-Link is the worldwide leader and award winning designer, developer, and manufacturer of networking products. D-Link delivers the performance you need at a price you can afford. D-Link has all the products you need to build your network.

How does wireless work?

Wireless works similar to how cordless phone work, through radio signals to transmit data from one point A to point B. But wireless technology has restrictions as to how you can access the network. You must be within the wireless network range area to be able to connect your computer. There are two different types of wireless networks: Wireless Local Area Network (WLAN), and Wireless Personal Area Network (WPAN).

Wireless Local Area Network (WLAN)

In a wireless local area network, a device called an Access Point (AP) connects computers to the network. The access point has a small antenna attached to it, which allows it to transmit data back and forth over radio signals. With an indoor access point as seen in the picture, the signal can travel up to 300 feet. With an outdoor access point the signal can reach out up to 30 miles to serve places like manufacturing plants, industrial locations, college and high school campuses, airports, golf courses, and many other outdoor venues.

Wireless Personal Area Network (WPAN)

Bluetooth is the industry standard wireless technology used for WPAN. Bluetooth devices in WPAN operate in a range up to 30 feet away.

Compared to WLAN the speed and wireless operation range are both less than WLAN, but in return it doesn't use nearly as much power which makes it ideal for personal devices, such as mobile phones, PDAs, headphones, laptops, speakers, and other devices that operate on batteries.

Who uses wireless?

Wireless technology has become so popular in recent years that almost everyone is using it, whether it's for home, office, business, D-Link has a wireless solution for it.

Home

- Gives everyone at home broadband access
- Surf the web, check email, instant message, etc.
- Gets rid of the cables around the house
- Simple and easy to use

Small Office and Home Office

- Stay on top of everything at home as you would at office
- Remotely access your office network from home
- Share Internet connection and printer with multiple computers
- No need to dedicate office space

Where is wireless used?

Wireless technology is expanding everywhere not just at home or office. People like the freedom of mobility and it's becoming so popular that more and more public facilities now provide wireless access to attract people. The wireless connection in public places is usually called "hotspots".

Using a D-Link CardBus Adapter with your laptop, you can access the hotspot to connect to Internet from remote locations such as airports, hotels, coffee shops, libraries, restaurants, and convention centers.

A wireless network is easy to setup, but if you're installing it for the first time it could be quite a task not knowing where to start. That's why we've put together a few setup steps and tips to help you through the process of setting up a wireless network.

Tips

Here are a few things to keep in mind, when you install a wireless network.

Centralize your router or Access Point

Make sure you place the router/access point in a centralized location within your network for the best performance. Try to place the router/access point as high as possible in the room, so the signal gets dispersed throughout your home. If you have a two-story home, you may need a repeater to boost the signal to extend the range.

Eliminate Interference

Place home appliances such as cordless telephones, microwaves, and televisions as far away as possible from the router/access point. This would significantly reduce any interference that the appliances might cause since they operate on same frequency.

Security

Don't let you next-door neighbors or intruders connect to your wireless network. Secure your wireless network by turning on the WPA or WEP security feature on the router. Refer to product manual for detail information on how to set it up.

Networking Basics

Check your IP address

After you install your new D-Link adapter, by default, the TCP/IP settings should be set to obtain an IP address from a DHCP server (i.e. wireless router) automatically. To verify your IP address, please follow the steps below.

Click on **Start > Run**. In the run box type **cmd** and click **OK**. (Windows® 8/7/Vista® users type **cmd** in the **Start Search** box.)

At the prompt, type **ipconfig** and press **Enter**.

This will display the IP address, subnet mask, and the default gateway of your adapter.

If the address is 0.0.0.0, check your adapter installation, security settings, and the settings on your router. Some firewall software programs may block a DHCP request on newly installed adapters.

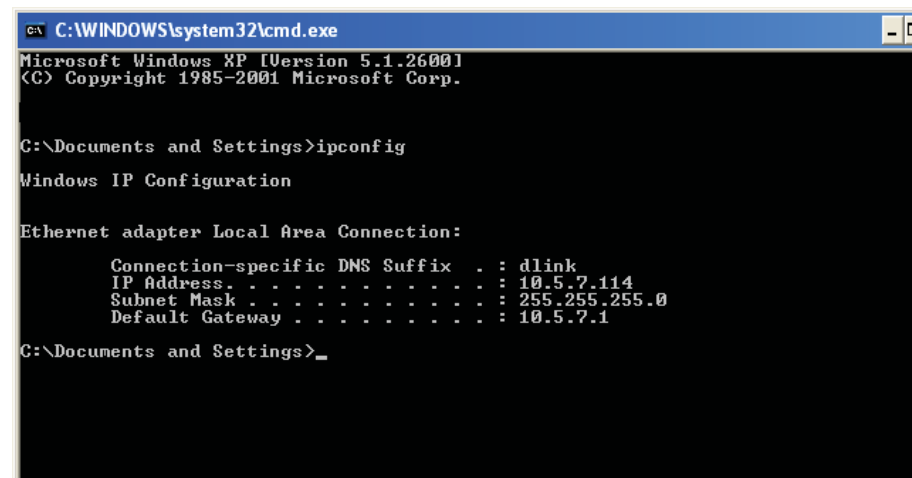

```
C:\WINDOWS\system32\cmd.exe
Microsoft Windows XP [Version 5.1.2600]
(C) Copyright 1985-2001 Microsoft Corp.

C:\Documents and Settings>ipconfig

Windows IP Configuration

Ethernet adapter Local Area Connection:

    Connection-specific DNS Suffix  . : dlink
    IP Address. . . . .                : 10.5.7.114
    Subnet Mask . . . . .              : 255.255.255.0
    Default Gateway . . . . .          : 10.5.7.1

C:\Documents and Settings>_
```

Statically Assign an IP address

If you are not using a DHCP capable gateway/router, or you need to assign a static IP address, please follow the steps below:

Step 1

Windows® 7 - Click on **Start > Control Panel > Network and Internet > Network and Sharing Center**.

Windows Vista® - Click on **Start > Control Panel > Network and Internet > Network and Sharing Center > Manage Network Connections**.

Windows® XP - Click on **Start > Control Panel > Network Connections**.

Windows® 2000 - From the desktop, right-click **My Network Places > Properties**.

Step 2

Right-click on the **Local Area Connection** which represents your network adapter and select **Properties**.

Step 3

Highlight **Internet Protocol (TCP/IP)** and click **Properties**.

Step 4

Click **Use the following IP address** and enter an IP address that is on the same subnet as your network or the LAN IP address on your router.

Example: If the router's LAN IP address is 192.168.0.1, make your IP address 192.168.0.X where X is a number between 2 and 99. Make sure that the number you choose is not in use on the network. Set the Default Gateway the same as the LAN IP address of your router (I.E. 192.168.0.1).

Set Primary DNS the same as the LAN IP address of your router (192.168.0.1). The Secondary DNS is not needed or you may enter a DNS server from your ISP.

Step 5

Click **OK** twice to save your settings.

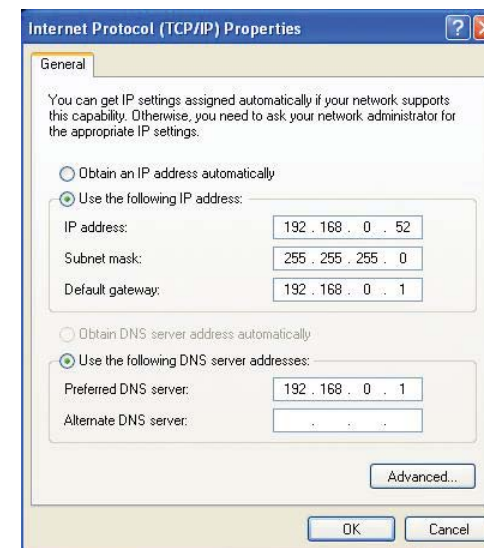

Technical Specifications

Standards

- IEEE 802.11a
- IEEE 802.11b
- IEEE 802.11g
- IEEE 802.11n
- IEEE 802.11ac(Draft)

Interfaces

- 802.11n/g/b wireless
- 10/100 WAN/LAN port
- WPS button
- Reset button
- Switch Button for 2.4GHz/5GHz

Wireless Modes

- Router Mode
- Access Point Mode

Antennas

- Internal Antenna

Security

- Wi-Fi Protected Access (WPA/WPA2)
- WPS™ (PBC)

Diagnostic LEDs

- Power
- Internet

Operating Temperature

- 0 to 40 °C (32 to 104 °F)

Operating Humidity

- 0% to 90% non-condensing

Power

- 5 V DC

Certifications

- CE
- Wi-Fi Certified
- FCC

Dimensions

- 63x44x23mm

Weight

- 29.72g

¹ Frequency Range varies depending on local regulations.

Safety Statements

CE Mark Warning:

This is a Class B product. In a domestic environment, this product may cause radio interference, in which case the user may be required to take adequate measures.

Federal Communication Commission Interference Statement

This device complies with Part 15 of the FCC Rules. Operation is subject to the following two conditions: (1) This device may not cause harmful interference, and (2) this device must accept any interference received, including interference that may cause undesired operation.

This equipment has been tested and found to comply with the limits for a Class B digital device, pursuant to Part 15 of the FCC Rules. These limits are designed to provide reasonable protection against harmful interference in a residential installation. This equipment generates, uses and can radiate radio frequency energy and, if not installed and used in accordance with the instructions, may cause harmful interference to radio communications. However, there is no guarantee that interference will not occur in a particular installation. If this equipment does cause harmful interference to radio or television reception, which can be determined by turning the equipment off and on, the user is encouraged to try to correct the interference by one of the following measures:

- Reorient or relocate the receiving antenna.
- Increase the separation between the equipment and receiver.
- Connect the equipment into an outlet on a circuit different from that to which the receiver is connected.
- Consult the dealer or an experienced radio/TV technician for help.

FCC Caution: Any changes or modifications not expressly approved by the party responsible for compliance could void the user's authority to operate this equipment.

This transmitter must not be co-located or operating in conjunction with any other antenna or transmitter.

For operation within 5.15 ~ 5.25GHz frequency range, it is restricted to indoor environment. This device meets all the other requirements specified in Part 15E, Section 15.407 of the FCC Rules.

Radiation Exposure Statement:

The product comply with the FCC portable RF exposure limit set forth for an uncontrolled environment and are safe for intended operation as described in this manual. The further RF exposure reduction can be achieved if the product can be kept as far as possible from the user body or set the device to lower output power if such function is available.

Appendix D - Safety Statements

The model DIR-516 is intended for use with other certified equipment with limited power source, where the suitability of the combination is to be determined.

注意！

依據 低功率電波輻射性電機管理辦法第十二條：經型式認證合格之低功率射頻電機，非經許可，公司、商號或使用者均不得擅自變更頻率、加大功率或變更原設計之特性及功能。第十四條：低功率射頻電機之使用不得影響飛航安全及干擾合法通信；經發現有干擾現象時，應立即停用，並改善至無干擾時方得繼續使用。前項合法通信，指依電信規定作業之無線電信。低功率射頻電機須受合法通信或工業、科學及醫療用電波輻射性電機設備之干擾。

在5.25-5.35兆赫頻帶內操作之無線資訊傳輸設備，限於室內使用。