

**DSL2000G**

**802.11g WLAN ADSL2+ Router**

**User's Manual**

## Regulatory notes and statements

### Wireless LAN, Health and Authorization for use

Radio frequency electromagnetic energy is emitted from Wireless LAN devices. The energy levels of these emissions however are far much less than the electromagnetic energy emissions from wireless devices like for example mobile phones. Wireless LAN devices are safe for use frequency safety standards and recommendations. The use of Wireless LAN devices may be restricted in some situations or environments for example:

- Onboard airplanes, or
- In an explosive environment, or
- In case the interference risk to other devices or services is perceived or identified as harmful

In case the policy regarding the use of Wireless LAN devices in specific organizations or environments (e.g. airports, hospitals, chemical/oil/gas industrial plants, private buildings etc.) is not clear, please ask for authorization to use these devices prior to operating the equipment.

### Regulatory Information/disclaimers

Installation and use of this Wireless LAN device must be in strict accordance with the instructions included in the user documentation provided with the product. Any changes or modifications made to this device that are not explicitly approved by the manufacturer may void the user's authority to operate the equipment. The Manufacturer is not responsible for any radio or television interference caused by unauthorized modification of this device, of the substitution or attachment. Manufacturer and its authorized resellers or distributors will assume no liability for any damage or violation of government regulations arising from failing to comply with these guidelines.

### FCC statement

#### *Federal Communication Commission Interference Statement*

---

This equipment has been tested and found to comply with the limits for a Class B digital device, pursuant to Part 15 of the FCC Rules. These limits are designed to provide reasonable protection against harmful interference in a residential installation. This equipment generates, uses and can radiate radio frequency energy and, if not installed and used in accordance with the instructions, may cause harmful interference to radio communications. However, there is no guarantee that interference will not occur in a particular installation. If this equipment does cause harmful interference to radio or television reception, which can be determined by turning the equipment off and on, the user is encouraged to try to correct the interference by one of the following measures:

- Reorient or relocate the receiving antenna.
- Increase the separation between the equipment and receiver.
- Connect the equipment into an outlet on a circuit different from that to which the receiver is connected.
- Consult the dealer or an experienced radio/TV technician for help.

**FCC Caution:** Any changes or modifications not expressly approved by the party responsible for compliance could void the user's authority to operate this equipment.

This device complies with Part 15 of the FCC Rules. Operation is subject to the following two conditions: (1) This device may not cause harmful interference, and (2) this device must accept any interference received, including interference that may cause undesired operation.

### IMPORTANT NOTE:

#### **FCC Radiation Exposure Statement:**

This equipment complies with FCC radiation exposure limits set forth for an uncontrolled environment. This equipment should be installed and operated with minimum distance 20cm between the radiator & your body.

This transmitter must not be co-located or operating in conjunction with any other antenna or transmitter.

The availability of some specific channels and/or operational frequency bands are country dependent and are firmware programmed at the factory to match the intended destination. The firmware setting is not accessible by the end user.

## **PART 68 statement**

---

This equipment complies with Part 68 of FCC Rules and the requirements adopted by the ACTA.. On the bass unit of this equipment is a label that contains, among other information, a product identifier in the format **US: CAMDL01BDSLRLR2000G**. If requested, this number must be provided to the telephone company. The REN for this product is part of the product identifier that has the format **US: CAMDL01BDSLRLR2000G**. The digits represented by 01 are the REN without a decimal point.

The REN is useful to determine the quantity of devices you may connect to your telephone line and still have those devices ring when your telephone number is called. In most, but not all areas, the sum of the REN of all devices connected to one line should not exceed five (5.0). To be certain of the number of devices you may connect to your line, as determined by the REN, you should contact your local telephone company to determine the maximum REN for your calling area.

If your equipment causes harm to the telephone network, the telephone company may discontinue your service temporarily. If possible, they will notify you in advance. If advance notice is not practical, you will be notified as soon as possible. You will be informed of your right to file a complaint with the FCC. Your telephone company may make changes in its facilities, equipment, operations or procedures that could affect the proper functioning of your equipment. If they do, you will be notified in advance to give you an opportunity to maintain uninterrupted telephone service.

If you experience trouble with this telephone equipment, please contact the following address and phone number for information on obtaining service or repairs:

The telephone company may ask that you disconnect this equipment from the network until the problem has been corrected or until you are sure that the equipment is not malfunctioning.

This equipment may not be used on coin service provided by the telephone company. Connection to party lines is subject to state tariffs.

### **Contact information for service center in case of problems as below:**

Company: TRENDware International, Inc.

Address: 20675 Manhattan Place Torrance, CA 90501 USA

Tel no.:310-961-5500

## **CE statement**

### ***Europe – EU Declaration of Conformity***

---

This device complies with the essential requirements of the R&TTE Directive 1999/5/EC. The following test methods have been applied in order to prove presumption of conformity with the essential requirements of the R&TTE Directive 1999/5/EC:

#### **EN60950-1: 2006**

Safety of Information Technology Equipment

#### **EN 50385: 2002**

Product standard to demonstrate the compliance of radio base stations and fixed terminal stations for wireless telecommunication systems with the basic restrictions or the reference levels related to human exposure to radio frequency electromagnetic fields (110MHz - 40 GHz) - General public

#### **EN 300 328 V1.7.1 (2006-10)**

Electromagnetic compatibility and Radio spectrum Matters (ERM); Wideband transmission systems; Data transmission equipment operating in the 2,4 GHz ISM band and using wide band modulation techniques; Harmonized EN covering essential requirements under article 3.2 of the R&TTE Directive

#### **EN 301 489-1 V1.8.1 (2008-04)**

Electromagnetic compatibility and Radio Spectrum Matters (ERM); ElectroMagnetic Compatibility (EMC) standard for radio equipment and services; Part 1: Common technical requirements





#### **EN 301 489-17 V1.3.2 (2008-04)**

Electromagnetic compatibility and Radio spectrum Matters (ERM); ElectroMagnetic Compatibility (EMC) standard for radio equipment and services; Part 17: Specific conditions for 2,4 GHz wideband transmission systems , 5 GHz high performance RLAN equipment and 5,8GHz Broadband Data Transmitting Systems.

This device is a 2.4 GHz wideband transmission system (transceiver), intended for use in all EU member states and EFTA countries, except in France and Italy where restrictive use applies.

In Italy the end-user should apply for a license at the national spectrum authorities in order to obtain authorization to use the device for setting up outdoor radio links and/or for supplying public access to telecommunications and/or network services.

This device may not be used for setting up outdoor radio links in France and in some areas the RF output power may be limited to 10 mW EIRP in the frequency range of 2454 – 2483.5 MHz. For detailed information the end-user should contact the national spectrum authority in France.

 Český [Czech]	<i>[Jméno výrobce]</i> tímto prohlašuje, že tento <i>[typ zařízení]</i> je ve shodě se základními požadavky a dalšími příslušnými ustanoveními směrnice 1999/5/ES.
 Dansk [Danish]	Undertegnede <i>[fabrikantens navn]</i> erklærer herved, at følgende udstyr <i>[udstyrets typebetegnelse]</i> overholder de væsentlige krav og øvrige relevante krav i direktiv 1999/5/EF.
 Deutsch [German]	Hiermit erkläre <i>[Name des Herstellers]</i> , dass sich das Gerät <i>[Gerätetyp]</i> in Übereinstimmung mit den grundlegenden Anforderungen und den übrigen einschlägigen Bestimmungen der Richtlinie 1999/5/EG befindet.
 Eesti [Estonian]	Käesolevaga kinnitab <i>[tootja nimi = name of manufacturer]</i> seadme <i>[seadme tüüp = type of equipment]</i> vastavust direktiivi 1999/5/EÜ põhinõuetele ja nimetatud direktiivist tulenevatele teistele asjakohastele sätetele.
 English	Hereby, <i>[name of manufacturer]</i> , declares that this <i>[type of equipment]</i> is in compliance with the essential requirements and other relevant provisions of Directive 1999/5/EC.
 Español [Spanish]	Por medio de la presente <i>[nombre del fabricante]</i> declara que el <i>[clase de equipo]</i> cumple con los requisitos esenciales y cualesquiera otras disposiciones aplicables o exigibles de la Directiva 1999/5/CE.
 Ελληνική [Greek]	ΜΕ ΤΗΝ ΠΑΡΟΥΣΑ <i>[name of manufacturer]</i> ΔΗΛΩΝΕΙ ΟΤΙ <i>[type of equipment]</i> ΣΥΜΜΟΡΦΩΝΕΤΑΙ ΠΡΟΣ ΤΙΣ ΟΥΣΙΩΔΕΙΣ ΑΠΑΙΤΗΣΕΙΣ ΚΑΙ ΤΙΣ ΛΟΙΠΕΣ ΣΧΕΤΙΚΕΣ ΔΙΑΤΑΞΕΙΣ ΤΗΣ ΟΔΗΓΙΑΣ 1999/5/ΕΚ.
 Français [French]	Par la présente <i>[nom du fabricant]</i> déclare que l'appareil <i>[type d'appareil]</i> est conforme aux exigences essentielles et aux autres dispositions pertinentes de la directive 1999/5/CE.
 Italiano [Italian]	Con la presente <i>[nome del costruttore]</i> dichiara che questo <i>[tipo di apparecchio]</i> è conforme ai requisiti essenziali ed alle altre disposizioni pertinenti stabilite dalla direttiva 1999/5/CE.
Latviski [Latvian]	Ar šo <i>[name of manufacturer / izgatavotāja nosaukums]</i> deklarē, ka <i>[type of equipment / iekārtas tips]</i> atbilst Direktīvas 1999/5/EK būtiskajām prasībām un citiem ar to saistītajiem noteikumiem.
Lietuvių [Lithuanian]	Šiuo <i>[manufacturer name]</i> deklaruoją, kad šis <i>[equipment type]</i> atitinka esminius reikalavimus ir kitas 1999/5/EB Direktyvos nuostatas.
 Nederlands [Dutch]	Hierbij verklaart <i>[naam van de fabrikant]</i> dat het toestel <i>[type van toestel]</i> in overeenstemming is met de essentiële eisen en de andere relevante bepalingen van richtlijn 1999/5/EG.
 Malti [Maltese]	Hawnhekk, <i>[isem tal-manifattur]</i> , jiddikjara li dan <i>[il-mudell tal-prodott]</i> jikkonforma mal-htigijiet essenzjali u ma provvedimenti oħrajn relevanti li hemm fid-Direttiva 1999/5/EC.
 Magyar [Hungarian]	Alulírott, <i>[gyártó neve]</i> nyilatkozom, hogy a <i>[... típus]</i> megfelel a vonatkozó alapvető követelményeknek és az 1999/5/EC irányelv egyéb előírásainak.
 Polski [Polish]	Niniejszym <i>[nazwa producenta]</i> oświadczam, że <i>[nazwa wyrobu]</i> jest zgodny z zasadniczymi wymogami oraz pozostałymi stosownymi postanowieniami Dyrektywy 1999/5/EC.
 Português [Portuguese]	<i>[Nome do fabricante]</i> declara que este <i>[tipo de equipamento]</i> está conforme com os requisitos essenciais e outras disposições da Directiva 1999/5/CE.
 Slovensko [Slovenian]	<i>[Ime proizvajalca]</i> izjavlja, da je ta <i>[tip opreme]</i> v skladu z bistvenimi zahtevami in ostalimi relevantnimi določili direktive 1999/5/ES.
Slovensky [Slovak]	<i>[Meno výrobcu]</i> týmto vyhlasuje, že <i>[typ zariadenia]</i> spĺňa základné požiadavky a všetky príslušné ustanovenia Smernice 1999/5/ES.
 Suomi [Finnish]	<i>[Valmistaja = manufacturer]</i> vakuuttaa täten että <i>[type of equipment = laitteen tyyppimerkintä]</i> tyyppinen laite on direktiivin 1999/5/EY oleellisten vaatimusten ja sitä koskevien direktiivin muiden ehtojen mukainen.
 Svenska [Swedish]	Härmed intygar <i>[företag]</i> att denna <i>[utrustningstyp]</i> står i överensstämmelse med de väsentliga egenskapskrav och övriga relevanta bestämmelser som framgår av direktiv 1999/5/EG.

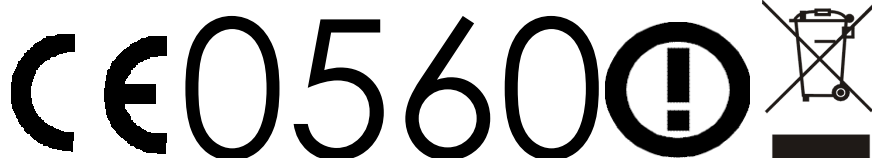

# TABLE OF CONTENT

---

<b>ABOUT THIS GUIDE</b> .....	<b>1</b>
Purpose.....	1
Terms/Usage .....	1
Overview of this User’s Guide.....	1
<b>INTRODUCTION</b> .....	<b>2</b>
Applications: .....	2
Supported Features: .....	2
<b>UNPACKING AND SETUP</b> .....	<b>4</b>
Unpacking.....	4
Setup .....	4
<b>HARDWARE INSTALLATION</b> .....	<b>5</b>
Front Panel .....	5
LED Indicators.....	5
Rear Panel .....	6
Hardware connections.....	7
Connecting the WLAN ADSL Router .....	7
Check the installation.....	7
<b>PC NETWORK TCP/IP SETTING</b> .....	<b>8</b>
Windows 95/98/ME .....	8
Windows 2000 .....	9
Windows XP / Vista.....	10
<b>CONFIGURATION</b> .....	<b>11</b>
Login to the WLAN ADSL Router through Wireless LAN.....	11
Login to the WLAN ADSL Router.....	11
Using the Web Browser .....	11
Configuration Menu.....	13
<b>SETUP WIZARD</b> .....	<b>14</b>
Step 1: Determine Connection Method.....	14
Step 2: ADSL Setting.....	15
Step 3: Select Channel Mode .....	15
Step 4: Completed the Setup Wizard .....	21
<b>MANUAL SETINGS</b> .....	<b>22</b>
Status.....	22
Setup .....	22
Internet Setup.....	22
LAN Setup .....	24
Wireless .....	25
DHCP Settings .....	30
Time Zone.....	32
Firewall – Used only on Router mode settings .....	33
IP/Port Filtering .....	33
MAC Filtering.....	34
Port Forwarding .....	35

URL Blocking.....	37
Domain Blocking.....	38
Port Triggering.....	39
DMZ.....	40
Advance – Used only on Router mode settings.....	41
Wireless.....	41
DNS Server.....	45
Dynamic DNS.....	46
Bridging.....	47
Routing.....	48
IGMP Proxy.....	50
UPnP.....	50
RIP.....	51
SNMP.....	52
Port Mapping.....	53
IP QoS.....	54
Remote Access.....	55
ATM Settings.....	56
ADSL Settings.....	57
Maintainance.....	59
Backup/Restore.....	59
Password.....	59
Upgrade Firmware.....	61
Access Controls.....	62
TR-069 Config.....	63
Logout.....	64
Diagnostic.....	64
Ping.....	64
ATM Loopback.....	66
ADSL.....	67
Diagnostic Test.....	68
Monitoring.....	69
DHCP Clients.....	69
Routing Table.....	69
ARP Table.....	70
Bridge FDB Table.....	70
Interface Statistics.....	71
ADSL Statistics.....	71
Mode.....	72
Reboot.....	73
<b>TECHNICAL SPECIFICATIONS.....</b>	<b>74</b>

## ***ABOUT THIS GUIDE***

---

Congratulations on your purchase of this IEEE 802.11b/g Wireless ADSL Router. This integrated access device combines ADSL modem, Internet gateway functions with wireless LAN and Fast Ethernet switch. It provides a complete solution for Internet surfing and office resource sharing, and it is easy to configure and operate for every user.

---

### **Purpose**

---

This manual discusses how to install the IEEE 802.11b/g Wireless ADSL Router.

---

### **Terms/Usage**

---

In this guide, the term “the WLAN ADSL Router” refers to your IEEE 802.11b/g Wireless ADSL Router.

---

### **Overview of this User’s Guide**

---

**Introduction.** Describes the IEEE 802.11b/g Wireless ADSL Router and its features.

**Unpacking and Setup.** Helps you get started with the basic installation of the IEEE 802.11b/g Wireless ADSL Router.

**Identifying External Components.** Describes the front panel, rear panel and LED indicators of the IEEE 802.11b/g Wireless ADSL Router.

**Connecting the WLAN ADSL Router.** Tells how you can connect the IEEE 802.11b/g Wireless ADSL Router.

**Technical Specifications.** Lists the technical (general, physical and environmental, performance and Routers settings) specifications of the IEEE 802.11b/g Wireless ADSL Router.

## ***INTRODUCTION***

---

The wireless router is a high-speed ADSL2+ Ethernet/Wireless router that is specifically designed to connect to the Internet and to directly connect to your local area network (LAN) via high-speed 10/100 Mbps Ethernet, or wireless LAN (WLAN). The ADSL2+ modem is compatible with the latest ADSL standards, including ADSL2 and ADSL2+, and supports up to 24 Mbps downstream and 1.5 Mbps upstream to deliver true broadband speed and throughput. The DSL router supports wireless 802.11b/g and the following security protocols: WEP, WPA, and WPA2, and 802.1x. To ensure fully compatibility, the DSL device was tested with all major DSLAMs, and support standard 10/100 Mbps Base-T Ethernet interface Auto MDI/MDIx 10/100 Switch function allowing user easily to link to PC or other Switches/Hubs. The DSL device is an idea solution for multi-users utilizing build-in channel mode (PPPoE/A, IPoA, IPoE), IP routing, NAT functionalities sharing the ADSL link. The DSL device is also a perfect solution for the residential users, it supports the users with bridge mode in host based PPPoE Client.

---

### **Applications:**

---

#### **Broadband Internet access:**

Several computers can share one high-speed broadband connection through wireless or wired (WLAN, LAN and WAN-Internet).

#### **Resource sharing:**

Share resources such as printers, scanners and other peripherals.

#### **File sharing:**

Exchange data, messages, and distribute files thus making good use of hard disk space.

#### **Online gaming:**

Through the local area network, online gaming and e-commerce services can be easily setup.

#### **Firewall:**

A built-in firewall function — for security and anti-hacking systems.

---

### **Supported Features:**

---

- ◆ Built-in ADSL Modem. The Wireless ADSL Router has a built-in ADSL modem, supporting all common ADSL connections
  - ◆ PPPoE, PPPoA, 1483 Bridged, 1483 MER, 1483 Routed and 1577 Routed. The Wireless ADSL Router supports all common connection methods
-



- ◆ Auto-detection of Internet Connection Method. In most situations, the Wireless ADSL Router can test your ADSL and Internet connection to determine the connection method used by ISP
- ◆ Supports ADSL standards for ITU-T G.992.1(G.dmt), ANSI T1.413 Issue 2, G.992.2 (G.lite), ADSL2 G.dmt.bis (G.992.3), ADSL2+ (G.992.5)
- ◆ Wi-Fi compliant with IEEE 802.11g and IEEE 802.11b standards
- ◆ 4 x 10/100Mbps Auto-MDIX LAN port and 1 x 10/100Mbps WAN port (Internet)
- ◆ High-speed up to 54Mbps data rate using wireless IEEE 802.11g connection
- ◆ One 2dBi dipole external antenna supports high speed performance and great coverage
- ◆ Firewall features for IP/Port filtering, MAC filtering, Port forwarding, URL blocking, Domain blocking, Port triggering and DMZ
- ◆ Support Wi-Fi Protected Setup (WPS) for easy connection
- ◆ Easy management via web browser and remote management
- ◆ Supports 64/128-bit WEP, WPA/WPA2 and WPA-PSK/WPA2-PSK
- ◆ Works with Windows 95/98/NT/2000/XP/2003 Server/Vista, Linux and Mac OS
- ◆ Coverage up to 30 meters (330ft.) indoor;(depends on the environment)
- ◆ Coverage up to 100 meters (980ft.) outdoor;(depends on the environment)

## ***UNPACKING AND SETUP***

---

This chapter provides unpacking and setup information for the IEEE 802.11b/g Wireless ADSL Router.

---

### **Unpacking**

---

Open the box of the WLAN ADSL Router and carefully unpack it. The box should contain the following items:

- ◆ TEW-436BRM Wireless ADSL Router
- ◆ CD-Rom (User's Guide)
- ◆ External power adapter
- ◆ 1 1.5m (5ft) Cat.5 Ethernet Cable
- ◆ 1 RJ-11 (ADSL) cable

If any item is found missing or damaged, please contact your local reseller for replacement.

---

### **Setup**

---

The setup of the WLAN ADSL Router can be performed properly using the following methods:

- ◆ The power outlet should be within 1.82 meters (6 feet) of the Broadband Router.
- ◆ Visually inspect the DC power jack and make sure that it is fully secured to the power adapter.
- ◆ Make sure that there is proper heat dissipation and adequate ventilation around the WLAN ADSL Router. Do not place heavy objects on the WLAN ADSL Router.
- ◆ Fix the direction of the antenna. Try to place the WLAN ADSL Router in a position that can best cover your wireless network. Normally, the higher you place the antenna, the better the performance will be. The antenna's position enhances the receiving sensitivity.

# HARDWARE INSTALLATION

## Front Panel

The figure below shows the front panel of the IEEE 802.11b/g Wireless ADSL Router.

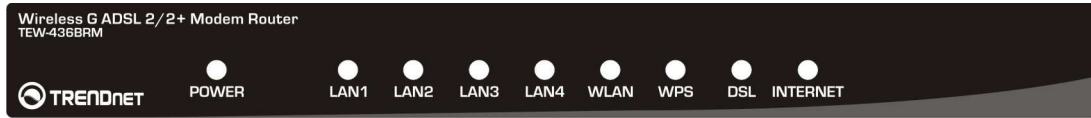

Front Panel

## LED Indicators

LED	Color	State	Description
Power	Green	Solid on	Power on, normal operation.
	Red	Solid on	Power on, self-test failed, indicating device malfunction.
	Off		Power off.
DSL	Green	Blinking	Pending ADSL line synchronization.
		Solid on	ADSL line synchronized.
Internet	Green	Blinking	Internet activity.
		Solid on	Internet connectivity, no activity.
	Red	Solid on	Internet connection setup failed.
	Off		No Internet connection.
LAN 1~4	Green	Blinking	Ethernet activity.
		Solid on	Ethernet connection, no activity.
	Off		No Ethernet connection.
WLAN	Green	Blinking	Wireless activity.
		Solid on	Wireless connection, no activity.
	Off		Wireless disabled.
WPS	Green	Blinking	WPS in progress.
		Solid on	WPS success.
	Red	Solid on	WPS fail.
	Off		WPS disabled.

---

## Rear Panel

---

The figure below shows the rear panel of the IEEE 802.11b/g Wireless ADSL Router.

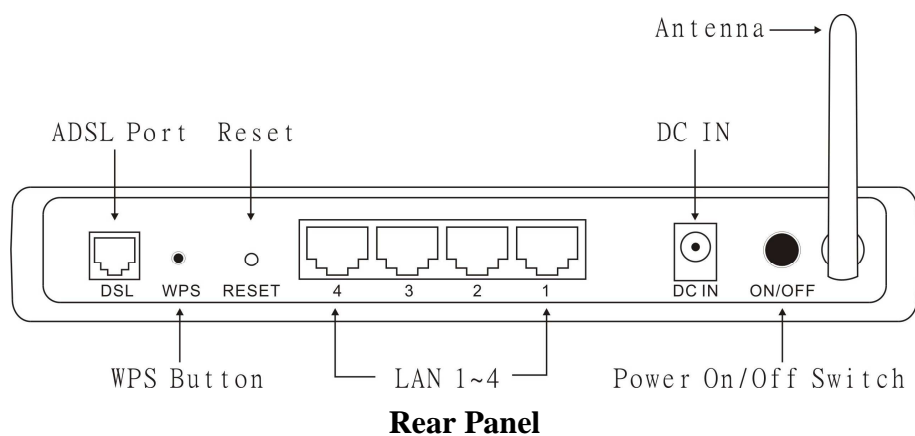

### Antenna

One 2dBi gain antenna for wireless connection.

### LAN (1-4)

Four RJ-45 10/100Mbps Auto-MDIX ports for connecting to either 10Mbps or 100Mbps Ethernet connections.

### DSL (ADSL Port)

Connect to an active telephone line (RJ-11).

### DC IN

Receptor for the supplied power adapter.

### ON/OFF (On/Off Switch)

Press this button to turn the unit on or off.

### WPS Button

Press to enable Wi-Fi Protected Setup.

### RESET

Holding the Reset button for 5 seconds restores the WLAN ADSL Router to its original factory default settings.

---

## Hardware connections

---

### Connecting the WLAN ADSL Router

---

#### 1. Connect ADSL Cable

Connect the supplied RJ-11 ADSL cable from to the DSL port on the Wireless ADSL Router (the RJ11 connector) to the ADSL terminator provided by your phone company.

#### 2. Connect LAN Cables

Use standard LAN cables to connect PCs to the LAN ports on the Wireless ADSL Router.

#### 3. Connect Power

Connect the supplied power adapter to the Wireless ADSL Router. Use only the power adapter provided. Using a different one may cause hardware damage.

---

### Check the installation

---

The LEDs on the WLAN ADSL Router are clearly visible and the status of the network link can be seen instantly:

1. With the power source on, once the device is connected to the phone line and PCs, the Power, LAN, WLAN and DSL, INETRNET LEDs of the WLAN ADSL Router will light up indicating a normal status.
2. When the ADSL line is connected the DSL LED will light up.
3. When the Internet is connected the INTERNET LED will light up. (Need to configuration)

## ***PC NETWORK TCP/IP SETTING***

---

The network TCP/IP settings differ based on the computer's operating system (Win95/98/ME/NT/2000/XP/Vista) and are as follows.

---

### **Windows 95/98/ME**

---

1. Click on the “**Network neighborhood**” icon found on the desktop.
2. Click the right mouse button and a context menu will be show.
3. Select “**Properties**” to enter the TCP/IP setting screen.
4. Select “**Obtain an IP address automatically**” on the “**IP address**” field.

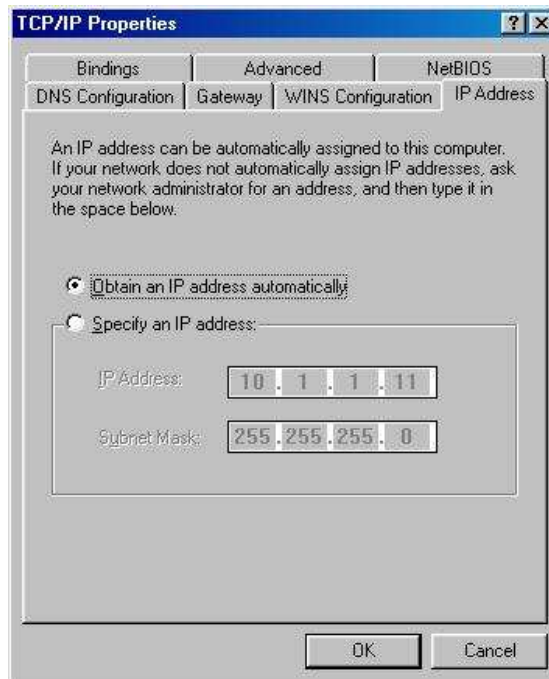

5. Select “**Disable DNS**” in the “**DNS**” field.

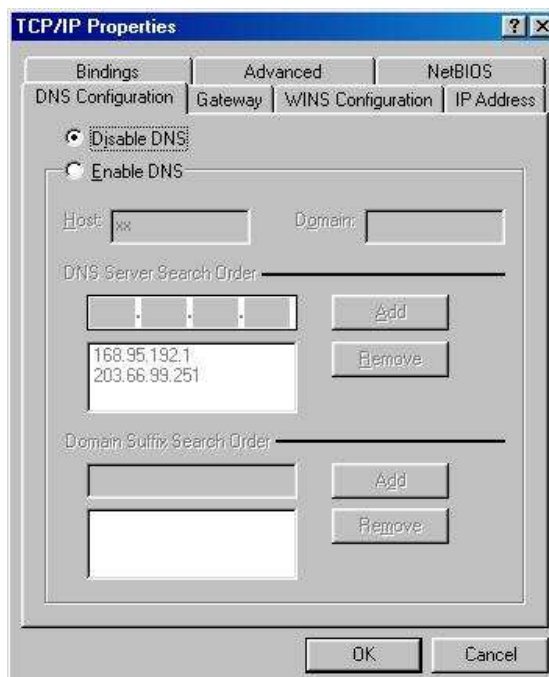

6. Select “None” for the “Gateway address” field.

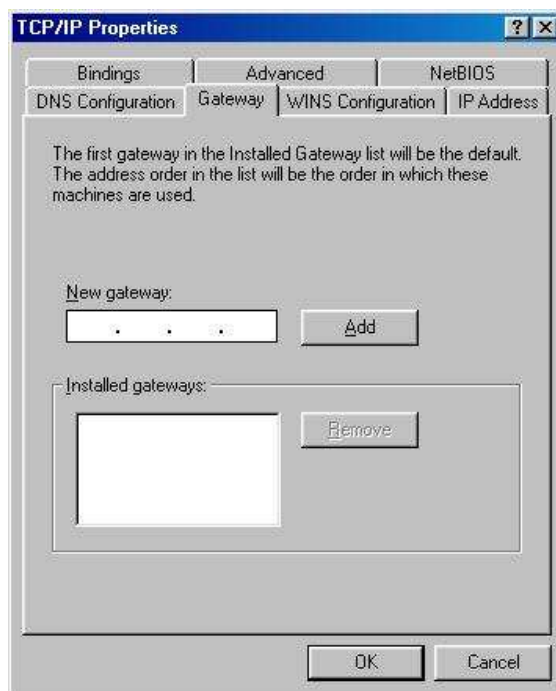

---

## Windows 2000

---

Double click on the “**My Computer**” icon on the desktop. When “**My Computer**” window opens, open the “**Control Panel**” and then open the “**Network dialup connection**” applet. Double click on the “**Local area network connection**” icon. Select “**Properties**” to enter the TCP/IP setting window.

1. In the “**Local area network status**” window, click on “**Properties.**”
2. In the “**Local area network connection**” window, first select TCP/IP setting and then select “**Properties.**”
3. Set both “**IP address**” and “**DNS**” to **Automatic configuration.**

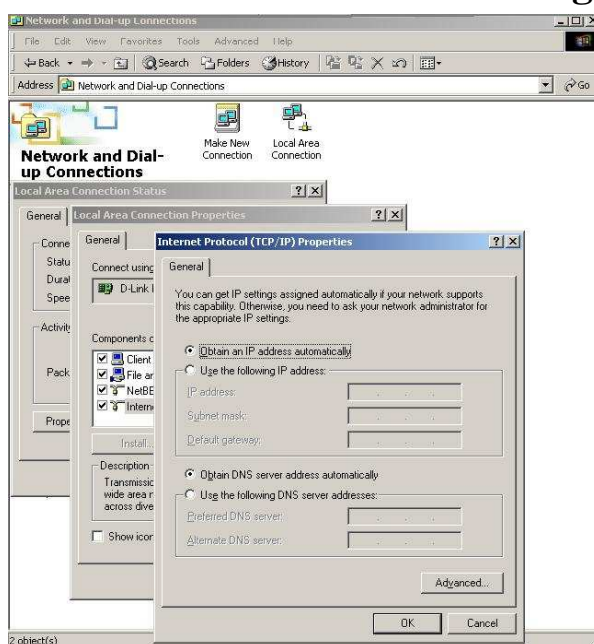

---

## Windows XP / Vista

---

Point the cursor and click the right button on the “My Network Place” icon. Select “properties” to enter the TCP/IP setting window.

1. Set “**IP address**” to “**Obtain an IP address automatically.**”
2. Set “**DNS**” to “**Obtain DNS server address automatically.**”

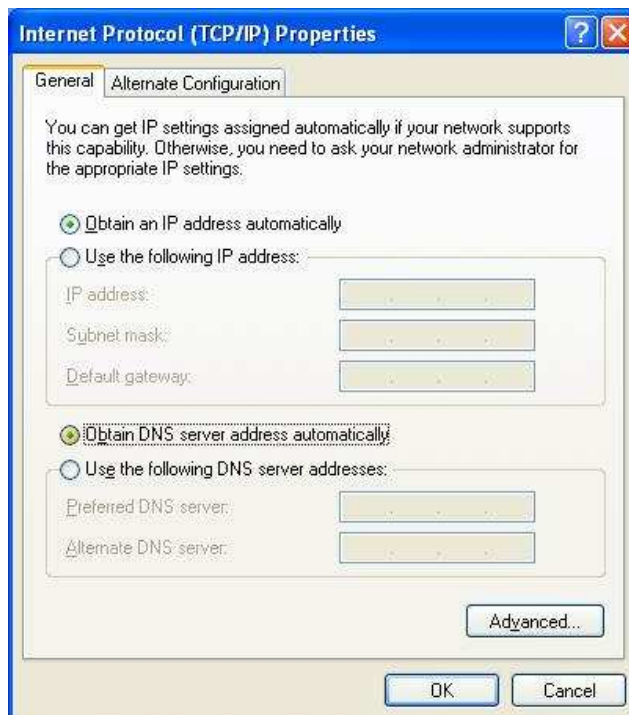



## ***CONFIGURATION***

---

First make sure that the network connections are functioning normally.

This WLAN Router can be configured using Internet Explorer 5.0 or newer web browser versions.

---

### **Login to the WLAN ADSL Router through Wireless LAN**

---

Before configuring the WLAN ADSL Router through WLAN, make sure that the SSID, Channel and the WEP is set properly.

The default setting of the WLAN ADSL Router that you will use:

- ✓ SSID: TRENDnet436
  - ✓ Channel: Auto
  - ✓ 802.11 Mode: 802.11b+g mixed mode
  - ✓ Security: disable
  - ✓ IP Address: 192.168.10.1
  - ✓ VPI/VCI for ATM: 5/35
  - ✓ ADSL Line mode: Auto-detect
- 

### **Login to the WLAN ADSL Router**

---

Before you configure this device, note that when the WLAN ADSL Router, make sure the host PC must be set on the **IP subnet** that can be accessed by the xDSL/Cable modem. For example, when the default network address of the xDSL/Cable modem Ethernet interface is 192.168.10.x, then the host PC should be set at 192.168.10.xxx (where xxx is a number between 2 and 254), and the default subnet mask is 255.255.255.0.

---

### **Using the Web Browser**

---

1. Open Internet Explorer 6.0 or above Internet browser.
2. Enter IP address <http://192.168.10.1> (the factory-default IP address setting) to the URL web address location.



3. When the following dialog box appears, enter the user name and password to login to the main configuration window, the default username and password is "*admin*".



After entering the user name and password, the main page comes up, the screen will display the WLAN ADSL Router status.

**TRENDNET** Wireless ADSL Modem Router  
TEW-436BRM

TEW-436BRM  
 Setup Wizard  
 Status  
 Setup  
 Firewall  
 Advance  
 Maintenance  
 Diagnostic  
 Monitoring  
 Mode  
 Reboot

### ADSL Router Status

This page shows the current status and some basic settings of the device.

System	
Alias Name	TEW-436BRM
Uptime	22 min
Firmware Version	1.00.10
DSP Version	2.9.0.4
Name Servers	
Default Gateway	

DSL	
Operational Status	ACTIVATING.
Upstream Speed	0 kbps
Downstream Speed	0 kbps

LAN Configuration	
IP Address	192.168.10.1
Subnet Mask	255.255.255.0
DHCP Server	Enabled
MAC Address	0018e75c3c4a

WAN Configuration						
Interface	VPI/VCI	Encap	Protocol	IP Address	Gateway	Status
vc0	5/35	LLC	br1483			down
vc1	0/32	LLC	br1483			down

Refresh

Copyright © 2009 TRENDnet. All Rights Reserved.

---

## Configuration Menu

---

When the main page appears, find the Configuration menu in the left side of the screen. Click on the setup item that you want to configure. There are ten options: Setup Wizard, Status, Setup, Firewall (form router mode only), Advance (form router mode only), Maintenance, Diagnostic, Monitoring, Mode and Reboot as shown in the Configuration Menu screen.

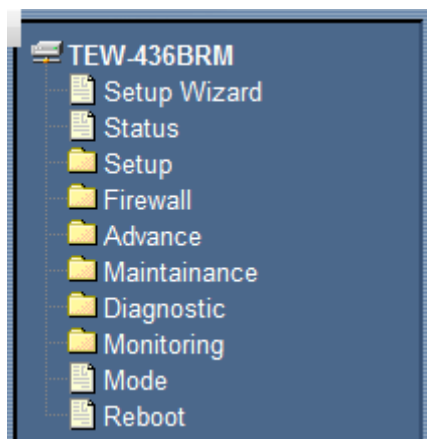

**Configure menu on Router mode**

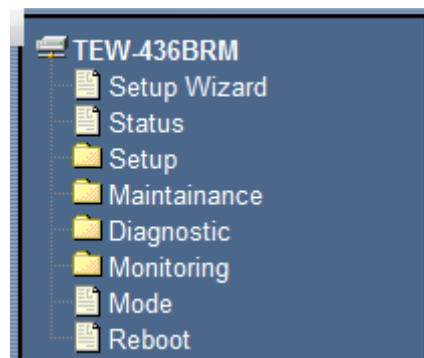

**Configure menu on Modem mode**

## ***SETUP WIZARD***

---

Setup wizard is provided as part of the web configuration utility. User can simply follow the step-by-step process to get the WLAN ADSL Router configuration ready by clicking on the “Wizard” button on the function menu. The following screen will appear.

---

### **Step 1: Determine Connection Method**

---

Choose “Auto-detect” for auto detect the Internet connection method or “Manual Selection” for manually configure the ADSL setting.

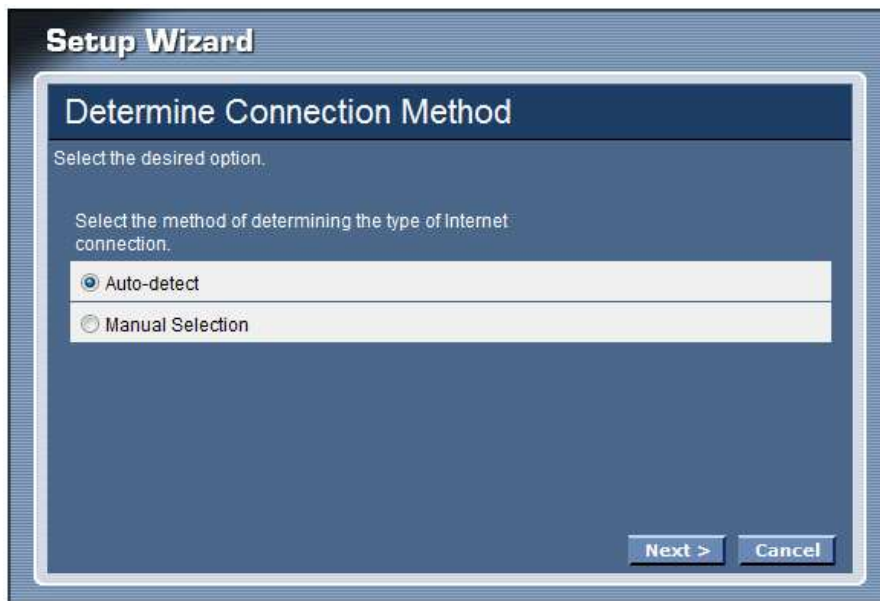

#### Auto-detect

Selected the “Auto-detect” then click “Next” button, the wizard will automatically detect the first usable PVC and automatically detect PPPoE, PPPoA, and Bridge Protocol (with DHCP Server available)

#### Manual Selection

Selected the “Manual Selection” then click “Next” button, the wizard will setting the Internet connection manually.

---

## Step 2: ADSL Setting

---

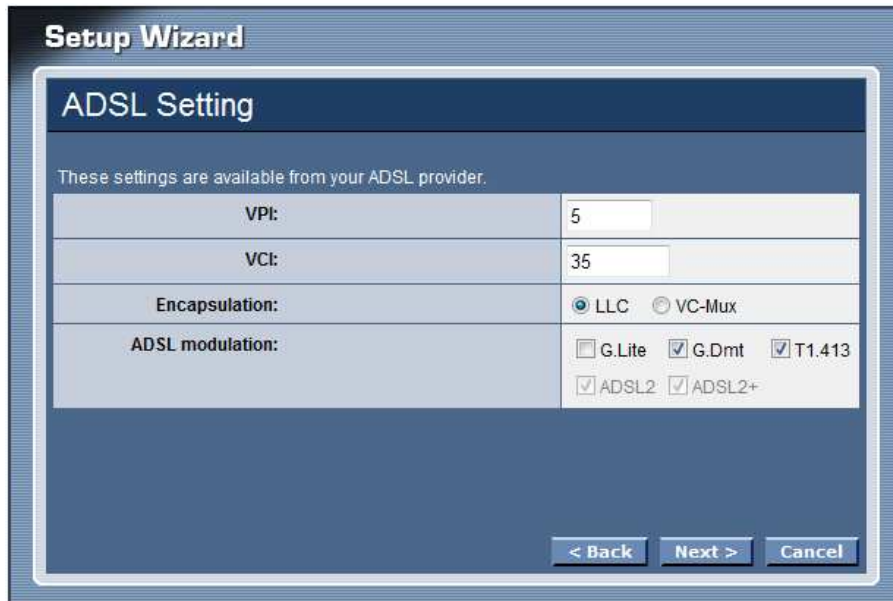

The screenshot shows a 'Setup Wizard' window with the title 'ADSL Setting'. Below the title, it says 'These settings are available from your ADSL provider.' The settings are as follows:

VPI:	5
VCI:	35
Encapsulation:	<input checked="" type="radio"/> LLC <input type="radio"/> VC-Mux
ADSL modulation:	<input type="checkbox"/> G.Lite <input checked="" type="checkbox"/> G.Dmt <input checked="" type="checkbox"/> T1.413 <input checked="" type="checkbox"/> ADSL2 <input checked="" type="checkbox"/> ADSL2+

At the bottom right, there are three buttons: '< Back', 'Next >', and 'Cancel'.

**VPI:** Enter the VPI value provided by ISP

**VCI:** Enter the VCI value provided by ISP

**Encapsulation:** Select the encapsulation type for LLC or VC-Mux

**ADSL modulation:** Select the ADSL modulation type defined by your ISP

---

## Step 3: Select Channel Mode

---

Select the type of network protocol for 1483 Bridged, 1483 MER, PPPoE, PPPoA or 1483 Routed.



The screenshot shows a 'Setup Wizard' window with the title 'Select Channel Mode'. Below the title, it says 'Channel Mode:'. The options are as follows:

- 1483 Bridged
- 1483 MER
- PPPoE
- PPPoA
- 1483 Routed

At the bottom right, there are three buttons: '< Back', 'Next >', and 'Cancel'.

## **1483 Bridged**

Selected the 1483 Bridged mode then click next button, the WLAN ADSL Router will save configuration and reboot the WLAN ADSL Router.

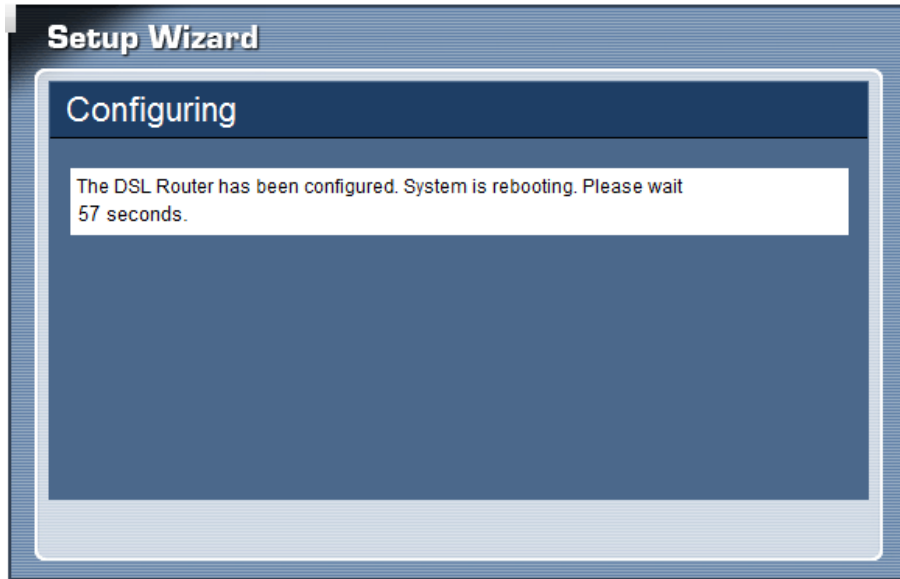

When rebooted the WLAN ADSL Router, enabled the “Test Internet Connection” then click finish button for test Internet connection; click close button close the setup wizard.



## 1483 MER

Selected the 1483 MER mode then click next button, continuing the WAN IP setting.



The image shows a 'Setup Wizard' window titled 'Select Channel Mode'. It contains a list of channel modes with radio buttons. The '1483 MER' option is selected. At the bottom, there are three buttons: '< Back', 'Next >', and 'Cancel'.

Channel Mode:
<input type="radio"/> 1483 Bridged
<input checked="" type="radio"/> 1483 MER
<input type="radio"/> PPPoE
<input type="radio"/> PPPoA
<input type="radio"/> 1483 Routed

Select whether user wants to specify an IP address manually, or want DHCP to obtain an IP address automatically. When Fixed IP is selected, type the Local IP Address, Remote IP Address and Subnet Mask in the text boxes. User's ISP will provide with this information.



The image shows a 'Setup Wizard' window titled '1483 MER'. It contains 'WAN IP Settings' with a 'Type' dropdown set to 'DHCP'. Below are text boxes for 'Local IP Address', 'Remote IP Address', and 'Subnet Mask'. The 'Default Route' is set to 'Disable'. At the bottom, there are three buttons: '< Back', 'Next >', and 'Cancel'.

WAN IP Settings	
Type:	<input type="radio"/> Fixed IP <input checked="" type="radio"/> DHCP
Local IP Address:	<input type="text"/>
Remote IP Address:	<input type="text"/>
Subnet Mask:	<input type="text"/>
Default Route:	<input checked="" type="radio"/> Disable <input type="radio"/> Enable

Click next button to save configuration and reboot the WLAN ADSL Router

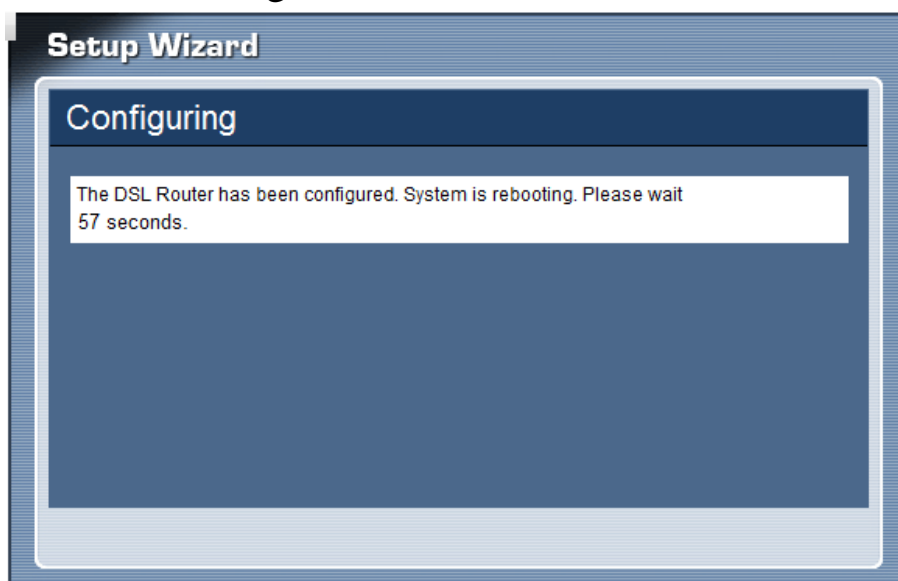

When rebooted the WLAN ADSL Router, enabled the “Test Internet Connection” then click finish button for test Internet connection; click close button close the setup wizard.



## PPPoE/PPPoA

Selected the PPPoE or PPPoA mode then click next button, continue the account setting.

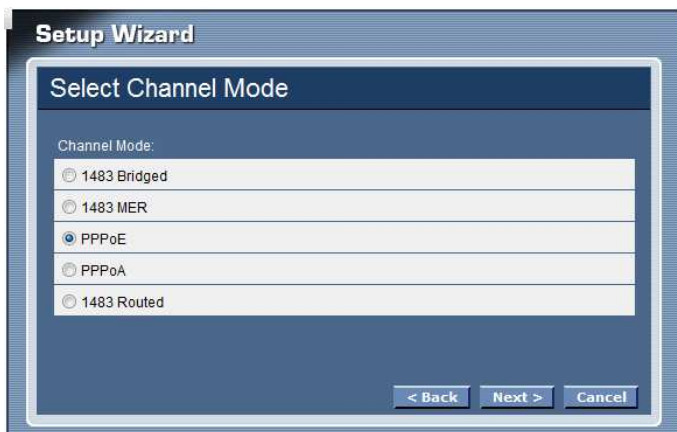



**User Name:** Enter the username provided by ISP.

**Password:** Enter the password provided by ISP

**Type:** Select the connection type for *Continuous* Connecting, *Connect on Demand* or *Manual* connecting.

**Idle Time:** Enter the idle time for Connect on Daemon, when no Internet access during the idle time, the ADSL connection will auto disconnect.

**Default Route:** Setting the default router function disable or enable.

The image shows two side-by-side screenshots of the 'Setup Wizard' configuration interface. The left window is titled 'PPPoE' and contains the following fields: 'User Name:' (text input), 'Password' (text input), 'Type' (dropdown menu set to 'Continuous'), 'Idle Time (min):' (text input), and 'Default Route:' (radio buttons for 'Disable' and 'Enable', with 'Disable' selected). The right window is titled 'PPPoA' and contains the same fields. Both windows have '< Back', 'Next >', and 'Cancel' buttons at the bottom.

Click next button to save configuration and reboot the WLAN ADSL Router

The image shows a screenshot of the 'Setup Wizard' interface at the 'Configuring' step. The title bar reads 'Setup Wizard' and the main heading is 'Configuring'. A white message box in the center contains the text: 'The DSL Router has been configured. System is rebooting. Please wait 57 seconds.'

When rebooted the WLAN ADSL Router, enabled the “Test Internet Connection” then click finish button for test Internet connection; click close button close the setup wizard.



### **1483 Routed**

Selected the 1483 Routed mode then click next button, continuing the WAN IP setting.



**NAPT:** Checked to enable the NAPT on the WLAN ADSL Router.

**Local IP Address :** Enter local IP address provided by ISP

**Remote IP Address :** Enter remote IP address provided by ISP

**Unnumbered:** Checked to enable the IP unnumbered on the WLAN ADSL Router.

**Default Route:** Setting the default router function disable or enable.

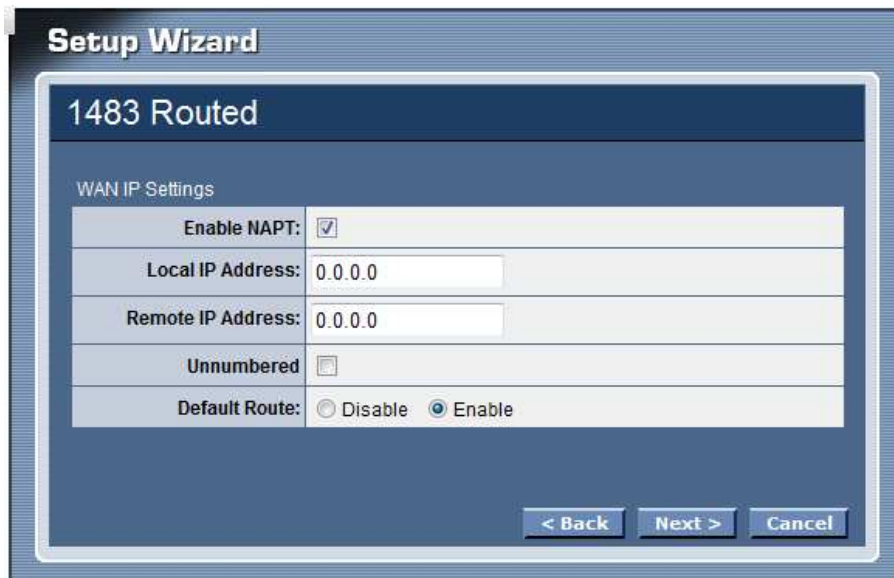

Click next button to save configuration and reboot the WLAN ADSL Router

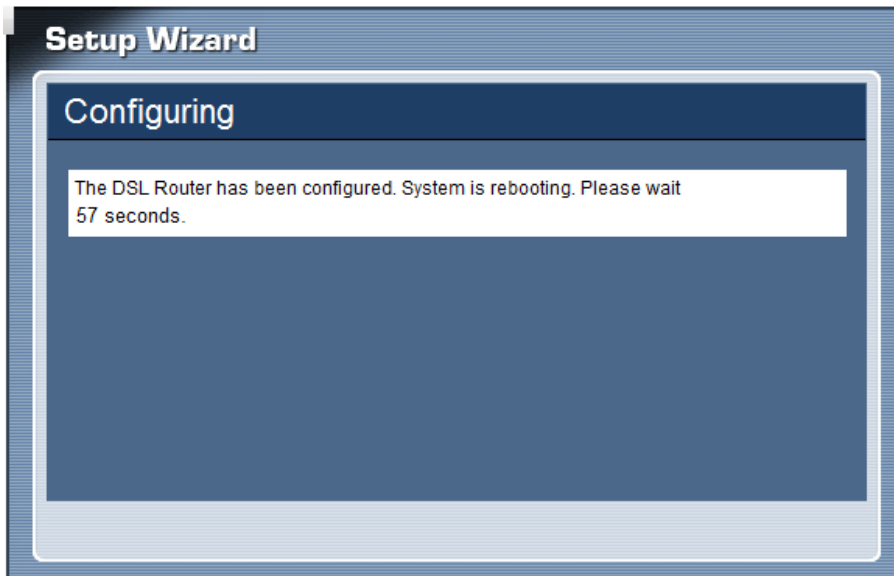

---

### Step 4: Completed the Setup Wizard

---

When rebooted the WLAN ADSL Router, enabled the “Test Internet Connection” then click finish button for test Internet connection; click close button close the setup wizard.

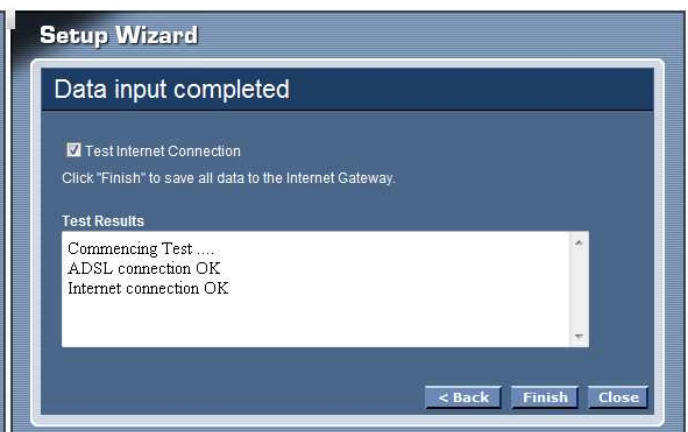
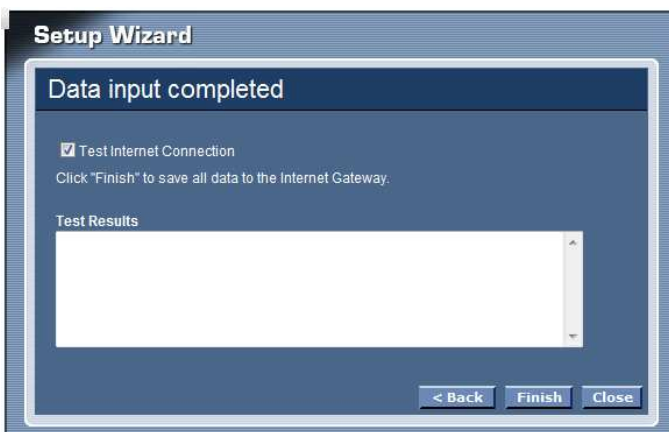

## MANUAL SETTINGS

---

Find that there are ten items, including Setup Wizard, Status, Setup, Firewall (form router mode only), Advance (form router mode only), Maintenance, Diagnostic, Monitoring, Mode and Reboot in Setup menu.

---

### Status

---

This page displays the WLAN ADSL Router current status and settings. Click the “Refresh” button to update the status.

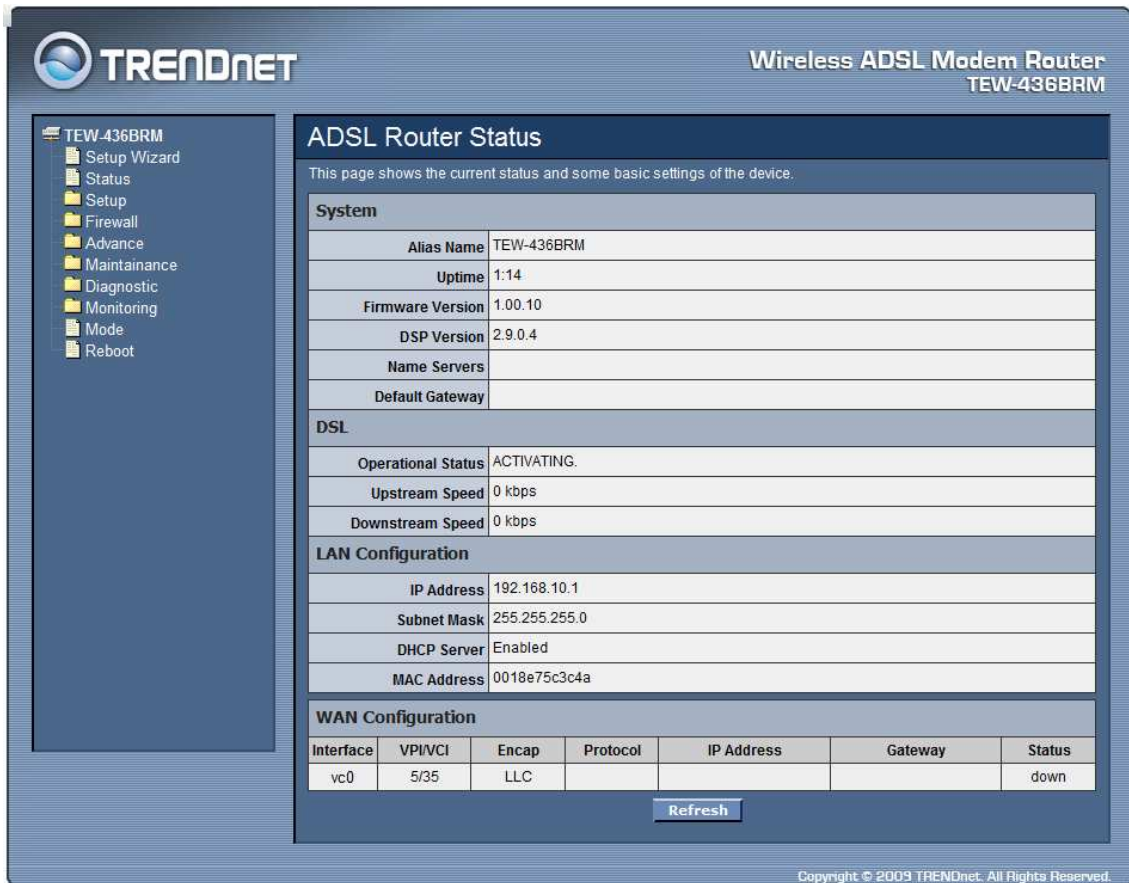

The screenshot displays the web interface of a Trendnet Wireless ADSL Modem Router (TEW-436BRM). The main content area is titled "ADSL Router Status" and contains the following information:

**System**

Alias Name	TEW-436BRM
Uptime	1:14
Firmware Version	1.00.10
DSP Version	2.9.0.4
Name Servers	
Default Gateway	

**DSL**

Operational Status	ACTIVATING.
Upstream Speed	0 kbps
Downstream Speed	0 kbps

**LAN Configuration**

IP Address	192.168.10.1
Subnet Mask	255.255.255.0
DHCP Server	Enabled
MAC Address	0018e75c3c4a

**WAN Configuration**

Interface	VPI/VCI	Encap	Protocol	IP Address	Gateway	Status
vc0	5/35	LLC				down

A "Refresh" button is located at the bottom of the status page.

Copyright © 2009 TRENDnet. All Rights Reserved.

### Setup

---

The section enables users to configure the Internet (ADSL), LAN, Wireless, DHCP and Time Zone setting.

---

#### Internet Setup

---

The WLAN ADSL Router comes with 8 ATM Permanent Virtual Channels (PVCs) at the most. There are mainly three operations for each of the PVC channels: add, delete and modify. And there are several channel modes to be selected for each PVC channel. For each of the channel modes, the setting is quite different accordingly.



**VPI:** Virtual Path Identifier. Enter the VPI value provided by ISP.

**VCI:** Virtual Channel Identifier. Enter the VCI value provided by ISP.

**Encapsulation:** Select the encapsulation type LLC or VC-Mux produced by your ISP.

**Channel Mode:** Select the channel mode for 1483 Bridged, 1483 MER, PPPoE, PPPoA, 1483 Routed or 1577 Routed provide by ISP.

**Enable NAPT:** Checked to enable the NAPT function on the WLAN ADSL Router.

**Admin Status:** Enable or disable the ATM VC setting when adding to the ATM VC Table.

**PPP Settings:** When the channel mode selected by PPPoE or PPPoA.

**User Name:** Enter the user name provide by ISP.

**Password:** Enter the user name provide by ISP.

**Type:** Select the connection type for “Continuous”, “Connect on Daemon” or “Manual” connect.

**Idle Time:** Enter the idle time for Connect on Daemon, when no Internet access during the idle time, the ADSL connection will auto disconnect.

## WAN IP Settings:

**Type:** Select whether user wants to specify an IP address manually, or want DHCP to obtain an IP address automatically. When Fixed IP is selected, type the Local IP Address, Remote IP Address and Subnet Mask in the text boxes. User's ISP will provide with this information.

**Unnumbered:** Checked to enable the IP unnumbered on the WLAN ADSL Router.

**Default Route:** Setting the default router function disable or enable.

**Add Button:** Click add button to add the new VC setting to the ATM VC Table.

**Modify Button:** Selected on of VC setting from the Current ATM VC Table then click the Modify button to save the modified VC setting.

**Current ATM VC Table:** Shows all of the ATM VC settings in the table.

**Auto-PVC Search:** Enable the Auto-PVC Search or add new PVC setting manually.

**Current Auto-PVC Table:** Shows all of the Auto-PVC settings in the table.

---

## LAN Setup

---

This screen enables users to set up the WLAN ADSL Router WAN connection, specify the IP address for the WAN, add DNS numbers, and enter the MAC address.

The screenshot displays the LAN Setup configuration page for a Trendnet Wireless ADSL Modem Router (TEW-436BRM). The page is titled "LAN Setup" and includes a navigation menu on the left with options like Setup Wizard, Status, Setup, Internet Setup, LAN Setup, Wireless, DHCP Settings, Time Zone, Firewall, Advance, Maintenance, Diagnostic, Monitoring, Mode, and Reboot. The main content area contains the following configuration fields:

Interface Name:	br0	
IP Address:	192.168.10.1	
Subnet Mask:	255.255.255.0	
GateWay:	192.168.10.1 (Auto config by dhcp server)	
	<input type="checkbox"/> Secondary IP	
IP Address:	192.168.100.1	
Subnet Mask:	255.255.255.0	
IGMP Snooping:	<input checked="" type="radio"/> Disabled <input type="radio"/> Enabled	
Ethernet to Wireless Blocking:	<input checked="" type="radio"/> Disabled <input type="radio"/> Enabled	
	<input type="button" value="Apply Changes"/>	

Copyright © 2009 TRENDnet. All Rights Reserved.

**IP Address:** This is the IP address of the router. The default IP address is 192.168.10.1.

**Subnet Mask:** Type the subnet mask for the router in the text box. The default subnet mask is 255.255.255.0.

**Secondary IP:** Checked to enable the secondary IP address setting on the LAN.

**IP Address:** The secondary IP address setting of the LAN.

**Subnet Mask:** The secondary Subnet Mask setting of the LAN.

**Ethernet to Wireless Blocking:** When enabled the Ethernet to Wireless Blocking, all of Ethernet users can't communicate with WLAN users.

---

## Wireless

---

This section enables users to configuration the wireless communications parameters for the WLAN ADSL Router.

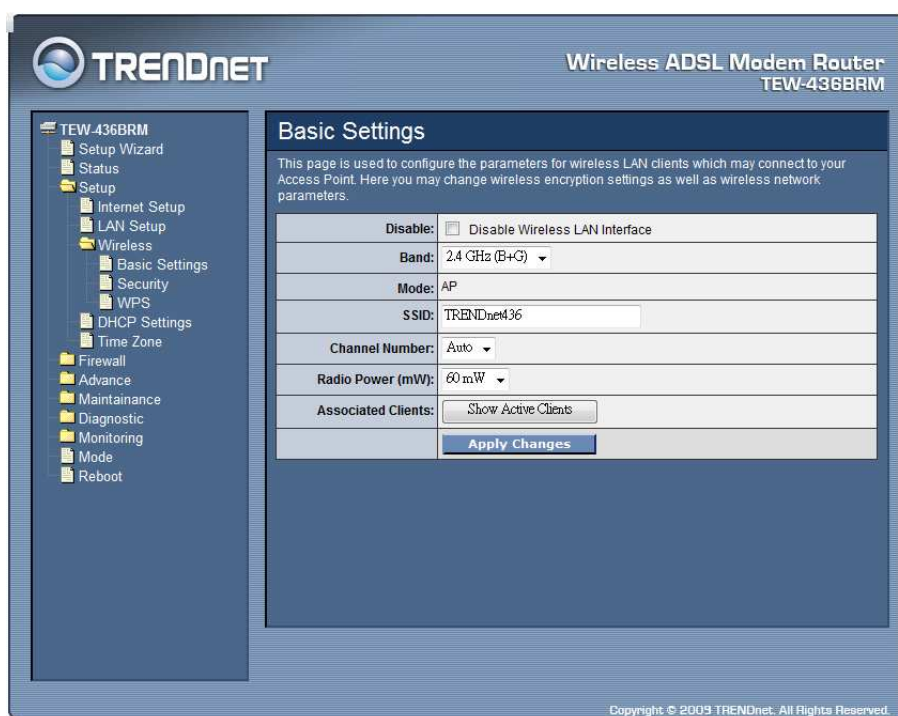

## Basic

This page allow user to enable and disable the wireless LAN function, create a SSID, and select the channel for wireless communications.

**Disable:** Checked to disable the wireless function of the WLAN ADSL Router.

**Band:** Select one of the following:

- **2.4Ghz (B+G)** - Selected if you are allowing both 802.11b and 802.11g wireless clients connect to the WLAN ADSL Router at the same time.
- **2.4Ghz (B)** - Selected if you are allowing the 802.11b wireless clients connect to the WLAN ADSL Router only.
- **2.4Ghz (G)** - Selected if you are allowing the 802.11g wireless clients connect to the WLAN ADSL Router only.

**SSID:** Type an SSID in the text box. The SSID of any wireless device must match the SSID typed here in order for the wireless device to access the LAN and WAN via the WLAN ADSL Router.

**Channel:** Select a transmission channel for wireless communications. The channel of any wireless device must match the channel selected here in order for the wireless device to access the LAN and WAN via the WLAN ADSL Router.

**Radio Power (mW):** The maximum output power for wireless LAN: 15mW, 30mW or 60mW.

**Associated Clients:** Click the “Show Active Client” button displays the information of connected wireless clients.

## Security



**SSID TYPE:** The WLAN ADSL Router supports up to four multiple SSID feature (Multiple Virtual AP), select which AP (Root AP, VAP0~VAP3) will configure the security setting.

**Encryption:** There are 4 types of security to be selected. To secure your WLAN, it's strongly recommending to enable this feature.

**WEP:** Make sure that all wireless devices on your network are using the same encryption level and key. Click Set WEP Key button to set the encryption key.

**WPA (TKIP):** WPA uses Temporal Key Integrity Protocol (TKIP) for data encryption. TKIP utilized a stronger encryption method and incorporates Message Integrity Code (MIC) to provide protection against hackers.

**WPA2 (AES):** WPA2, also known as 802.11i, uses Advanced Encryption Standard (AES) for data encryption. AES utilized a symmetric 128-bit block data encryption.



**WAP2 Mixed:** The AP supports WPA (TKIP) and WPA2 (AES) for data encryption. The actual selection of the encryption methods will depend on the clients.

**802.1x Authentication:** Checked to enable the 802.1x authentication. This option is selectable only when the “Encryption” is selected to either None or WEP. If the “Encryption” is WEP, you need to further select the WEP key length to be either WEP 64bits or WEP 128bits.

**WEP:** Click the “Set WEP Key” button to setting WEP key when the “Encryption” is selected to “WEP”.

Set WEP Key	
This page allows you setup the WEP Key value. You could choose use 64-bit or 128-bit as the encryption key, and select ASCII or Hex as the format of input value.	
SSID TYPE:	<input checked="" type="radio"/> Root <input type="radio"/> VAP0 <input type="radio"/> VAP1 <input type="radio"/> VAP2 <input type="radio"/> VAP3
Key Length:	64-bit
Key Format:	ASCII (5 characters)
Default Tx Key:	Key 1
Encryption Key 1:	*****
Encryption Key 2:	*****
Encryption Key 3:	*****
Encryption Key 4:	*****
<input type="button" value="Apply Changes"/> <input type="button" value="Reset"/> <input type="button" value="Close"/>	

**SSID TYPE:** The WLAN ADSL Router supports up to four multiple SSID feature (Multiple Virtual AP), select which AP (Root AP, VAP0~VAP3) will setting the WEP key.

**Key Length:** Select the level of encryption from the drop-down list 64 and 128-bit encryption.

**Key Format:** Select the key format from the drop-down list HEX or ASCII.

**Default TX Key:** Select which encryption key 1~4 will be use to default TX key.

**Encryption Key 1 ~ 4:** Enables users to create up to 4 different WEP keys, manually enter a set of values for each key.

**WPA Authentication Mode:** There are 2 types of authentication mode for WPA.

**Enterprise (RADIUS):** WPA RADIUS uses an external RADIUS server to perform user authentication. To use WPA RADIUS, enter the IP address of the RADIUS server, the RADIUS port (default is 1812) and the shared secret from the RADIUS server. Please refer to “Authentication RADIUS Server” setting below for RADIUS setting.

**Personal (Pre-Shared Key):** Pre-Shared Key authentication is based on a shared secret that is known only by the parties involved. To use WPA Pre-Shared Key, select key format and enter a password in the “Pre-Shared Key Format” and “Pre-Shared Key” setting respectively. Please refer to “Pre-Shared Key Format” and “Pre-Shared Key” setting below.

### **Pre-Shared Key Format:**

**Passphrase:** Select this to enter the Pre-Shared Key secret as user-friendly textual secret.

**Hex (64 characters):** Select this to enter the Pre-Shared Key secret as hexadecimal secret.

**Pre-Shared Key:** Specify the shared secret used by this Pre-Shared Key. If the “Pre-Shared Key Format” is specified as Passphrase, then it indicates a passphrase of 8 to 63 bytes long; or if the “Pre-Shared Key Format” is specified as Passphrase, then it indicates a 64-hexadecimal number.

**Authentication RADIUS Server:** If the WPA-RADIUS is selected at “WPA Authentication Mode”, the port (default is 1812), IP address and password of external RADIUS server are specified here.

## **WPS**

Although home Wi-Fi networks have become more and more popular, users still have trouble with the initial set up of network. This obstacle forces users to use the open security and increases the risk of eavesdropping. Therefore, The Wi-Fi Protected Setup (WPS) is designed to ease set up of security-enabled Wi-Fi networks and subsequently network management. The largest difference between WPS-enabled devices and legacy devices is that users do not need the knowledge about SSID, channel and security settings, but they could still surf in a security-enabled Wi-Fi network. This device supports Push Button method and PIN method for WPS. The following sub-paragraphs will describe the function of each item. The webpage is as below. Although home Wi-Fi networks have become more and more popular, users still have trouble with the initial set up of network. This obstacle forces users to use the open security and increases the risk of eavesdropping. Therefore, The Wi-Fi Protected Setup (WPS) is designed to ease set up of security-enabled Wi-Fi networks and subsequently network management. The largest difference between WPS-enabled devices and legacy devices is that users do not need the knowledge about SSID, channel and security settings, but they could still surf in a security-enabled Wi-Fi network. This device supports Push Button method and PIN method for WPS. The following sub-paragraphs will describe the function of each item. The webpage is as below.

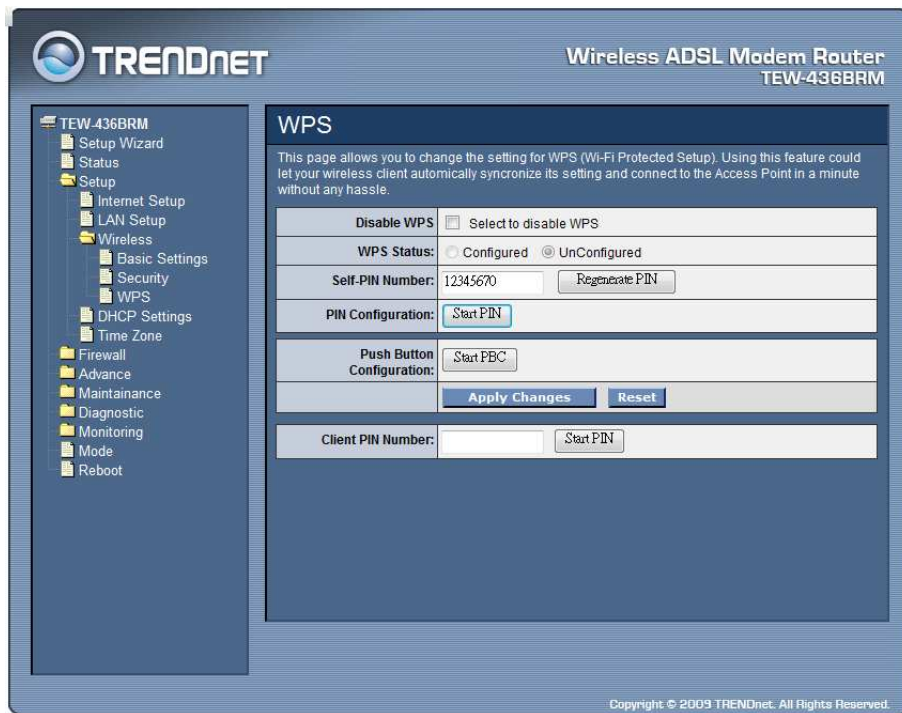

**Disable WPS:** Checked to disable the Wi-Fi protected Setup.

**WPS Status:** When the WLAN ADSL Router settings are factory default (out of box), it is set to open security and un-configured state. “WPS Status” will display it as “UnConfigured”. If it already shows “Configured”, some registrars such as Vista WCN will not configure AP. Users will need to go to the “Backup/Restore” page and click “Reset” to reload factory default settings.

**Self-PIN Number:** The “Self-PIN Number” is AP’s PIN. Whenever users want to change AP’s PIN, they could click “Regenerate PIN” and then click “Apply Changes”. Moreover, if users want to make their own PIN, they could enter four-digit PIN without checksum and then click “Apply Changes”. However, this would not be recommended since the registrar side needs to be supported with four-digit PIN.

**PIN Configuration:** Click the “Start PIN” button to start the PIN method of WPS.

**Push Button Configuration:** Click the “Start PBC” button to start the push button method of WPS.

**Client PIN Number:** It is only used when users want their station to join AP’s network. The length of PIN is limited to four or eight numeric digits. If users enter eight-digit PIN with checksum error, there will be a warning message popping up. If users insist on this PIN, AP will take it.

---

## DHCP Settings

---

You can configure your WLAN ADSL Router to use the Dynamic Host Configuration Protocol (DHCP). This section provides DHCP instructions for implementing it on your network by selecting the role of DHCP protocol that this device wants to play.

**DHCP Mode:** There are two different DHCP roles that this device can act as: DHCP Server and DHCP Relay. When acting as DHCP server, you can setup the server parameters at the below DHCP Server setting; while acting as DHCP Relay, you can setup the relay at the below DHCP Relay setting. Otherwise, selected the None to disable the DHCP service.

### DHCP Relay

Some ISPs perform the DHCP server function for their customers' home/small office network. In this case, you can configure this device to act as a DHCP relay agent. When a host on your network requests Internet access, the device contacts your ISP to obtain the IP configuration, and then forward that information to the host. You should set the DHCP mode after you configure the DHCP relay.

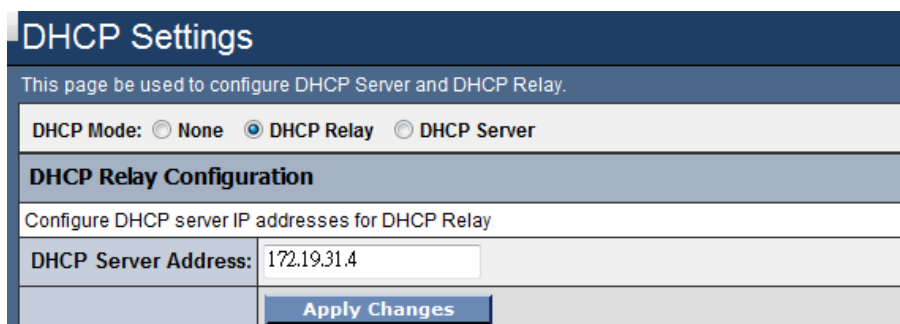

DHCP Settings	
This page be used to configure DHCP Server and DHCP Relay.	
DHCP Mode: <input type="radio"/> None <input checked="" type="radio"/> DHCP Relay <input type="radio"/> DHCP Server	
DHCP Relay Configuration	
Configure DHCP server IP addresses for DHCP Relay	
DHCP Server Address:	<input type="text" value="172.19.31.4"/>
<input type="button" value="Apply Changes"/>	

**DHCP Server Address:** Specify the IP address of your ISP's DHCP server. Requests for IP information from your LAN will be passed to the default gateway, which should route the request appropriately.

### DHCP Server

By default, the device is configured as a DHCP server, with a predefined IP address pool of 192.168.10.2 through 192.168.10.100 (subnet mask 255.255.255.0).

### DHCP Settings

This page be used to configure DHCP Server and DHCP Relay.

DHCP Mode:  None  DHCP Relay  DHCP Server

#### DHCP Server

Enable DHCP Server if you are using this device as a DHCP server. This page lists the IP address pools available to hosts on your LAN. The device distributes numbers in the pool to hosts on your network as they request Internet access.

LAN IP Address:	192.168.10.1	
Subnet Mask:	255.255.255.0	
IP Pool Range:	192.168.10.2 - 192.168.10.100	<input type="button" value="Show Client"/>
Subnet Mask:	255.255.255.0	
Max Lease Time:	86400	seconds (-1 indicates an infinite lease)
Domain Name:	domain.name	
Gateway Address:	192.168.10.1	

**IP Pool Range:** Specify the lowest and highest addresses in the pool.

**Subnet Mask:** Specify the subnet mask value.

**Max Lease Time:** The Lease Time is the amount of time that a network user is allowed to maintain a network connection to the device using the current dynamic IP address. At the end of the Lease Time, the lease is either renewed or a new IP is issued by the DHCP server. The amount of time is in units of seconds. The default value is 86400 seconds (1 day). The value -1 stands for the infinite lease.

**Domain Name:** A user-friendly name that refers to the group of hosts (subnet) that will be assigned addresses from this pool.

**Gateway Address:** Specify the gateway IP address.

**Show Client:** When click the “Show Client” button, all dynamic DHCP client computers are listed in the new window and providing the IP address, MAC address and Time Expired of the client.

### DHCP Client

This table shows the assigned IP address, MAC address and time expired for each DHCP leased client.

IP Address	MAC Address	Time Expired(s)
192.168.10.2	00:14:d1:64:3c:bd	76610

**MAC-Base Assignment:** Click the “MAC-Base Assignment” button to configure the static IP base on MAC Address. You can assign/delete the static IP. The Host MAC Address, please input a string with hex number. Such as "00-d0-59-c6-12-43". The Assigned IP Address, please input a string with digit. Such as "192.168.10.100". Click “Assign IP” button to add the static DHCP setting to the MAC-Base Assignment Table.

### Static IP Assignment Table

This page is used to configure the static IP base on MAC Address. You can assign/delete the static IP. The Host MAC Address, please input a string with hex number. Such as "00-d0-59-c6-12-43". The Assigned IP Address, please input a string with digit. Such as "192.168.1.100".

<b>Host MAC Address(xx-xx-xx-xx-xx-xx):</b>	<input style="width: 90%;" type="text"/>
<b>Assigned IP Address (xxx.xxx.xxx.xxx):</b>	<input style="width: 90%;" type="text"/>
<input type="button" value="Assign IP"/> <input type="button" value="Delete Assigned IP"/> <input type="button" value="Close"/>	

MAC-Base Assignment Table		
Select	Host MAC Address	Assigned IP Address

---

## Time Zone

---

Simple Network Timing Protocol (SNTP) is a protocol used to synchronize the system time to the public SNTP servers. The WLAN ADSL Router supports SNTP client functionality in compliance with IETF RFC2030. SNTP client functioning in daemon mode which issues sending client requests to the configured SNTP server addresses periodically can configure the system clock in the WLAN ADSL Router.

The screenshot shows the configuration interface for the Time Zone on a Trendnet Wireless ADSL Modem Router. The interface includes a sidebar with navigation options like Setup Wizard, Status, Setup, Internet Setup, LAN Setup, Wireless, DHCP Settings, Time Zone, Firewall, Advance, Maintenance, Diagnostic, Monitoring, Mode, and Reboot. The main content area is titled "Time Zone" and contains the following settings:

- Current Time:** Yr 2000, Mon 1, Day 1, Hr 0, Mn 0, Sec 48
- Time Zone Select:** (GMT-05:00)Eastern Time (US & Canada)
- SNTP server:**
  - Enable SNTP client update
  - 203.117.180.36 - Asia Pacific
  - 220.130.158.52 (Manual IP Setting)
- Daylight Saving:**
  - Enable Daylight Saving:
  - Daylight Saving Dates:
    - Start: Mar 2nd Sun 2 am
    - End: Nov 1st Sun 2 am

Buttons for "Apply Change" and "Refresh" are located at the bottom of the configuration area. The footer of the page reads "Copyright © 2009 TRENDnet. All Rights Reserved."

**Current Time:** The current time of the specified time zone. You can set the current time by yourself or configured by SNTP.

**Time Zone Select:** The time zone in which the WLAN ADSL Router resides.

**Enable SNTP client update:** Enable the SNTP client to update the system clock.

**SNTP server:** The IP address or the host name of the SNTP server. You can select from the list or set it manually.

**Daylight Saving:** Checked to enable daylight saving time. When enabled, select the start and end date for daylight saving time.

---

## Firewall – Used only on Router mode settings

---

The Firewall setting for the WLAN ADSL Router is configured on Router mode only. Please refer to the **Mode** setting in page 72.

Firewall contains several features that are used to deny or allow traffic from passing through the device.

---

### IP/Port Filtering

---

The IP/Port filtering feature allows you to deny/allow specific services or applications in the forwarding path.

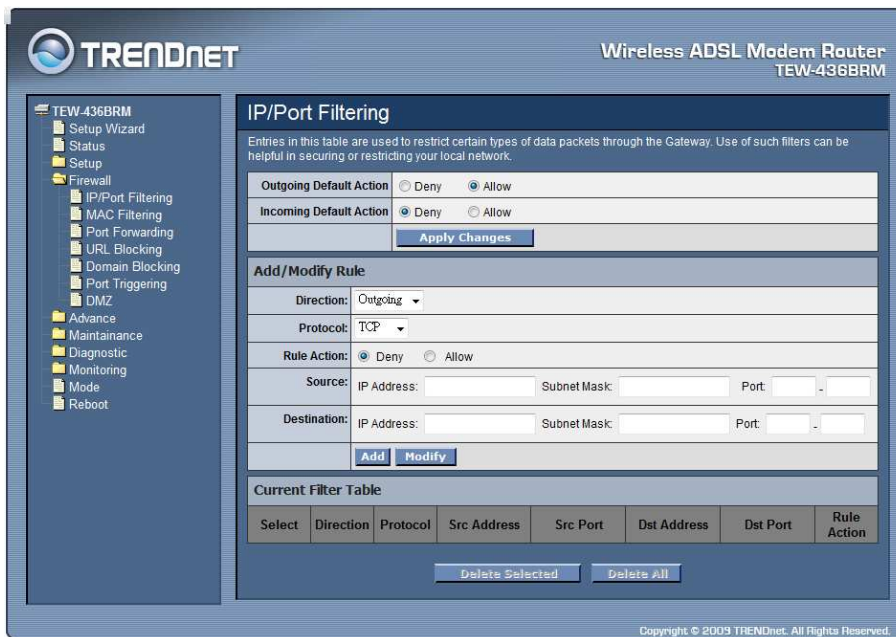

**Outgoing Default Action:** Specify the default action on the LAN to WAN forwarding path.

**Incoming Default Action:** Specify the default action on the WAN to LAN forwarding path.

## Add/Modify Rule

Add or modify the IP/Port filtering rule.

**Direction:** Select the traffic forwarding direction “Outgoing” or “Incoming”.

**Protocol:** Select the protocol type for TCP, UDP or ICMP.

**Rule Action:** Deny or allow traffic when matching this rule.

**Source:** The source IP address, Subnet Mask and Port range assigned to the traffic on which filtering is applied.

**Destination:** The destination IP address, Subnet Mask and Port range assigned to the traffic on which filtering is applied.

**Add:** Click the “Add” button to save the rule entry to the configuration.

**Modify:** Click the “Modify” button to modify the selected rule form the Current Filter Table.

**Delete Selected:** Click the “Delete Selected” button to delete the selected rule from Current Filter Table.

**Delete All:** Click the “Delete All” button to delete the all of rule in the Current Filter Table.

---

## MAC Filtering

---

The MAC filtering feature allows you to define rules to allow or deny frames through the device based on source MAC address, and traffic direction.

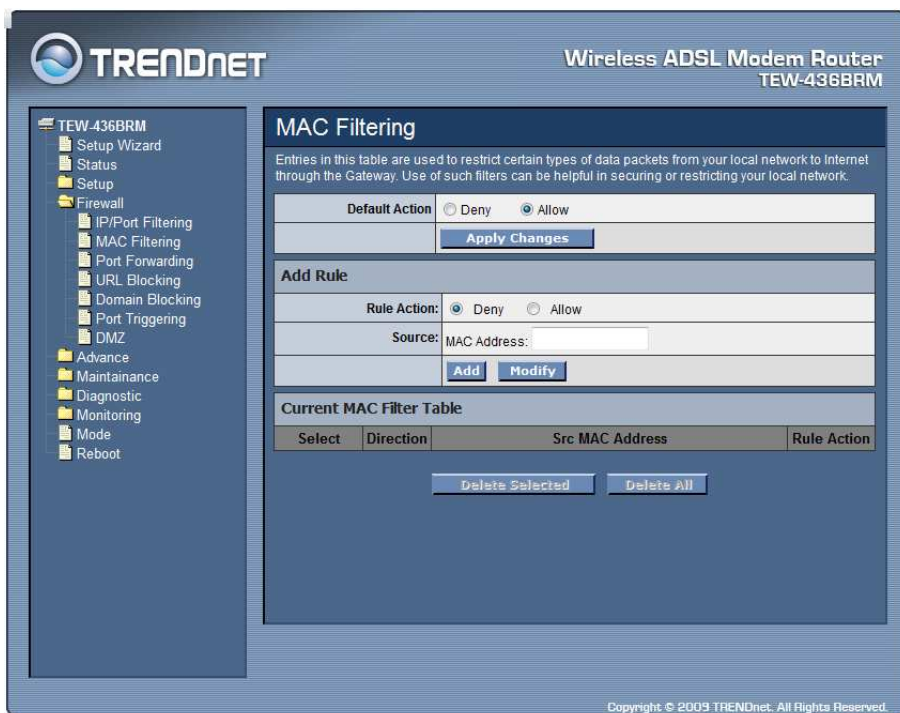

**Default Action:** Specify the default action on the LAN to WAN forwarding path.



## Add/Modify Rule

Add or modify the MAC filtering rule.

**Rule Action:** Deny or allow traffic when matching this rule.

**Source:** The source MAC address. It must be xxxxxxxxxxxx format. Blanks can be used in the MAC address space and are considered as don't care.

**Add:** Click the "Add" button to save the rule entry to the configuration.

**Modify:** Click the "Modify" button to modify the selected rule from the Current MAC Filter Table.

**Delete Selected:** Click the "Delete Selected" button to delete the selected rule from Current MAC Filter Table.

**Delete All:** Click the "Delete All" button to delete the all of rule in the Current MAC Filter Table.

---

## Port Forwarding

---

Firewall keeps unwanted traffic from the Internet away from your LAN computers. Add a Port Forwarding entry will create a tunnel through your firewall so that the computers on the Internet can communicate to one of the computers on your LAN on a single port.

The screenshot shows the configuration interface for a Trendnet Wireless ADSL Modem Router (TEW-436BRM). The page is titled "Port Forwarding" and includes a sidebar with navigation options like "Setup Wizard", "Status", "Firewall", and "DMZ". The main content area has a "Port Forwarding" section with radio buttons for "Disable" (selected) and "Enable", and an "Apply Changes" button. Below this is an "Add Rule" section with fields for "Protocol" (set to "Both"), "Comment", "Enable" (checked), "Interface", "Local" (IP Address and Port), and "Remote" (IP Address and Port). There are "Add" and "Modify" buttons. At the bottom, there is a "Current Port Forwarding Table" with columns: Select, Local IP Address, Protocol, Local Port, Comment, Enable, Remote Host, Public Port, and Interface. Below the table are "Delete Selected" and "Delete All" buttons. The footer contains the copyright notice: "Copyright © 2009 TRENDnet. All Rights Reserved."

**Port Forwarding:** Select to enable or disable the port forwarding feature.

## Add/Modify Rule

Add or modify the Port Forwarding rule.

**Protocol:** Select the protocol type for TCP, UDP or Both (TCP and UTP).

**Enable:** Check to enable this rule.

**Interface:** Select the WAN interface on which the port-forwarding rule is to be applied.

**Local:** The local IP address and Port range assigned to the traffic on which filtering is applied.

**Destination:** The remote IP address and Port range assigned to the traffic on which filtering is applied.

**Add:** Click the “Add” button to save the rule entry to the configuration.

**Modify:** Click the “Modify” button to modify the selected rule from the Current Port Forwarding Table.

**Delete Selected:** Click the “Delete Selected” button to delete the selected rule from Current Port Forwarding Table.

**Delete All:** Click the “Delete All” button to delete the all of rule in the Current Port Forwarding Table.

---

## URL Blocking

---

The URL Blocking is the web filtering solution. The firewall includes the ability to block access to specific web URLs based on string matches. This can allow large numbers of URLs to be blocked by specifying only a FQDN (such as tw.yahoo.com). The URL Blocking enforce a Web usage policy to control content downloaded from, and uploaded to, the Web.

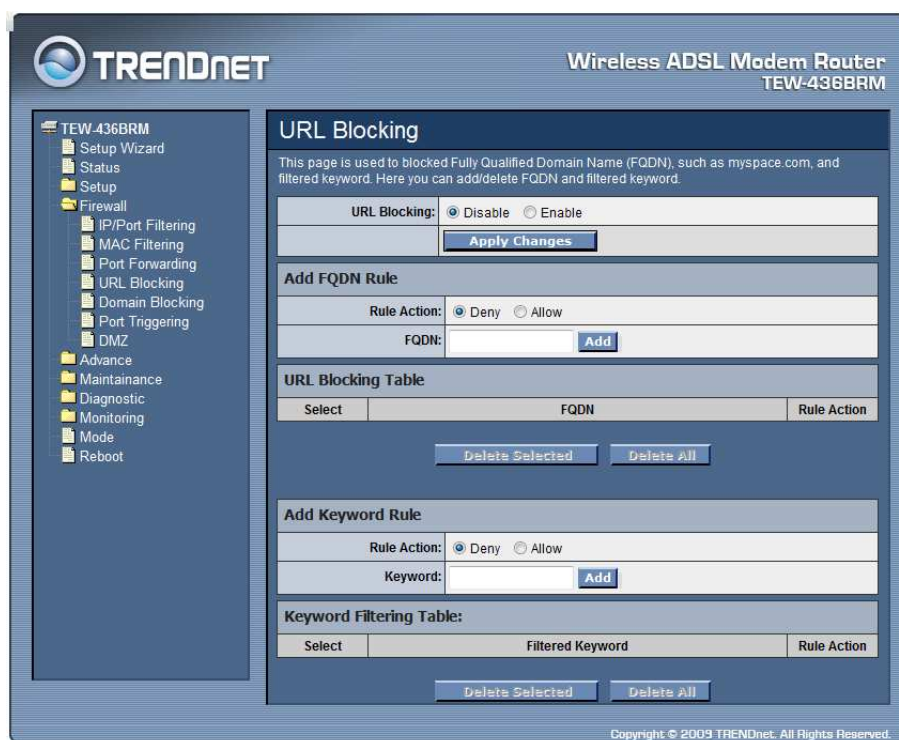

**URL Blocking:** Select to enable or disable the URL blocking feature.

### Add FQDN Rule

**Rule Action:** Deny or allow traffic when matching this rule.

**FQDN:** A fully qualified domain name (or FQDN) is an unambiguous domain name that specifies the node's position in the DNS tree hierarchy absolutely, such as tw.yahoo.com. The FQDN will be blocked to access.

**Add:** Click the “Add” button to save the rule entry to the configuration.

**Delete Selected:** Click the “Delete Selected” button to delete the selected rule from URL Blocking Table.

**Delete All:** Click the “Delete All” button to delete the all of rule in the URL Blocking Table.

## Add Keyword Rule

**Rule Action:** Deny or allow traffic when matching this rule.

**Keyword:** The filtered keyword such as yahoo. If the URL includes this keyword, the URL will be blocked to access.

**Add:** Click the “Add” button to save the rule entry to the configuration.

**Delete Selected:** Click the “Delete Selected” button to delete the selected rule from Keyword Filtering Table.

**Delete All:** Click the “Delete All” button to delete the all of rule in the Keyword Filtering Table.

---

## Domain Blocking

---

The firewall includes the ability to block access to specific domain based on string matches. For example, if the URL of Taiwan Yahoo web site is “tw.yahoo.com” and you enter “yahoo.com”, the firewall will block all the DNS queries with “yahoo.com” string. So the Host will be blocked to access all the URLs belong to “yahoo.com” domain. That means you can protect your computer, your house, your office and anything else that uses DNS from being able to service domains that you don’t want to load.

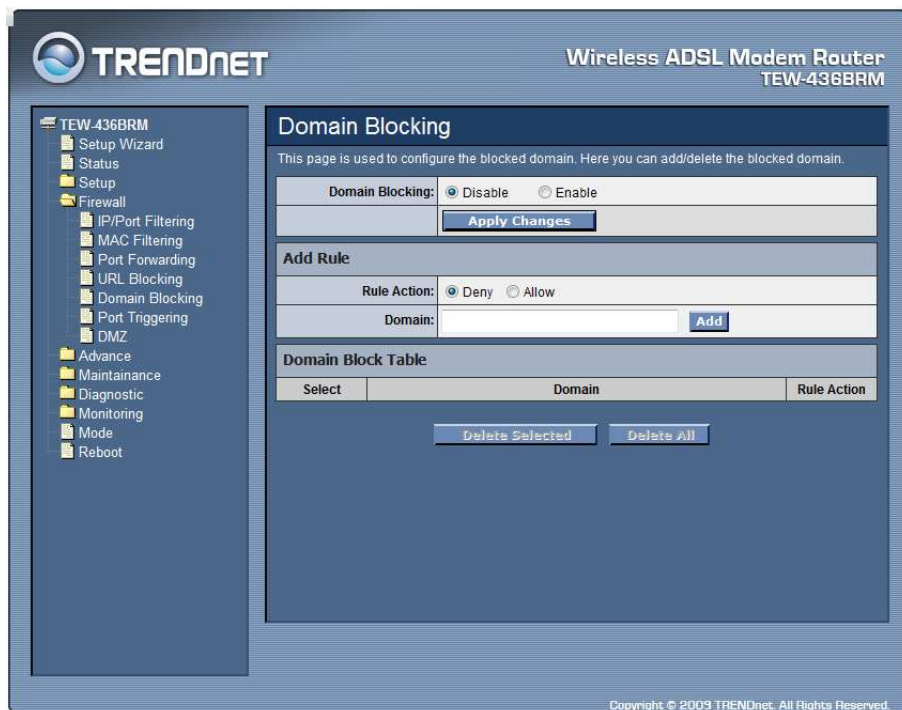

**Domain Blocking:** Select to enable or disable the Domain blocking feature.

## Add Rule

**Rule Action:** Deny or allow traffic when matching this rule.

**Domain:** Enter the blocked domain.

**Add:** Click the “Add” button to save the rule entry to the configuration.

**Delete Selected:** Click the “Delete Selected” button to delete the selected rule from Domain Block Table.

**Delete All:** Click the “Delete All” button to delete the all of rule in the Domain Blocking Table.

---

## Port Triggering

---

The Port Triggering enables users to specify special applications, such as games which require multiple connections that are blocked by NAT.

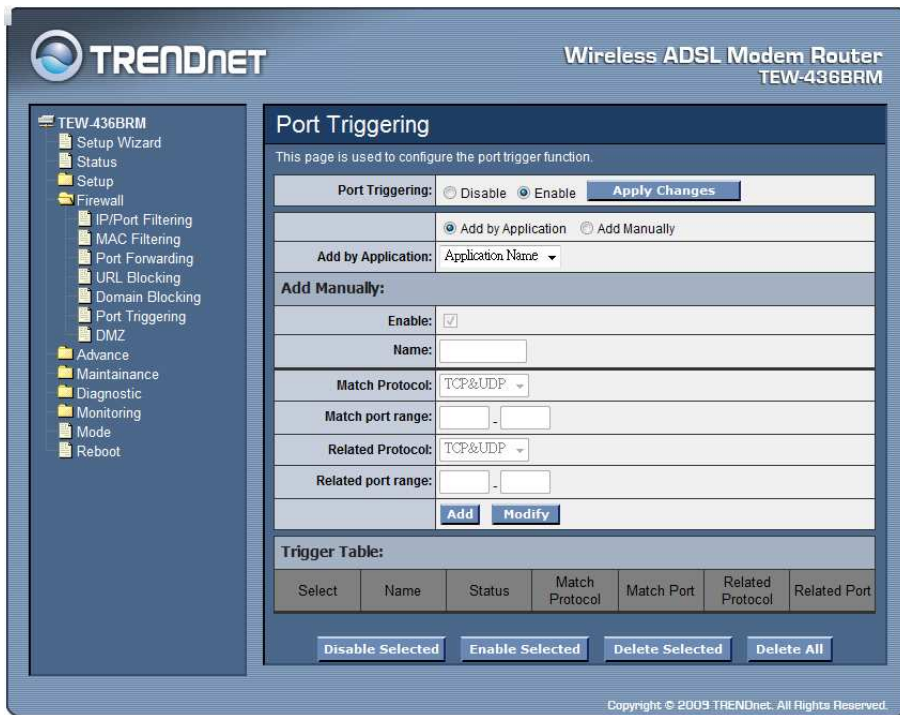

**Port Triggering:** Select to enable or disable the Port Triggering feature.

## Add by Application

**Add by Application:** Select pre-define the application rule from list then click “Add” button to add the selected application rule.

## Add by Manually

**Enable:** Check to enable this rule.

**Name:** Enter a descriptive name for the application rule.

**Match Protocol:** Select the outgoing protocol type for TCP, UDP or TCP&UTP.

**Match port range:** Enter the outgoing port range that can be used to access the application in the text boxes.

**Related Protocol:** Select the incoming protocol type for TCP, UDP or TCP&UTP.

**Related port range:** Enter the incoming port range that can be used to access the application in the text boxes.

**Add:** Click the “Add” button to save the rule entry to the configuration.

**Modify:** Click the “Modify” button to modify the selected rule form the Trigger Table.

**Delete Selected:** Click the “Delete Selected” button to delete the selected rule from Trigger Table.

**Delete All:** Click the “Delete All” button to delete the all of rule in the Trigger Table.

**Disable Selected:** Click the “Disable Selected” button to disable the selected rule from Trigger Table.

**Enable Selected:** Click the “Enable Selected” button to Enable the selected rule from Trigger Table.

---

## DMZ

---

A DMZ (Demilitarized Zone) allows a single computer on your LAN to expose ALL of its ports to the Internet. Enter the IP address of that computer as a DMZ (Demilitarized Zone) host with unrestricted Internet access. When doing this, the DMZ host is no longer behind the firewall.

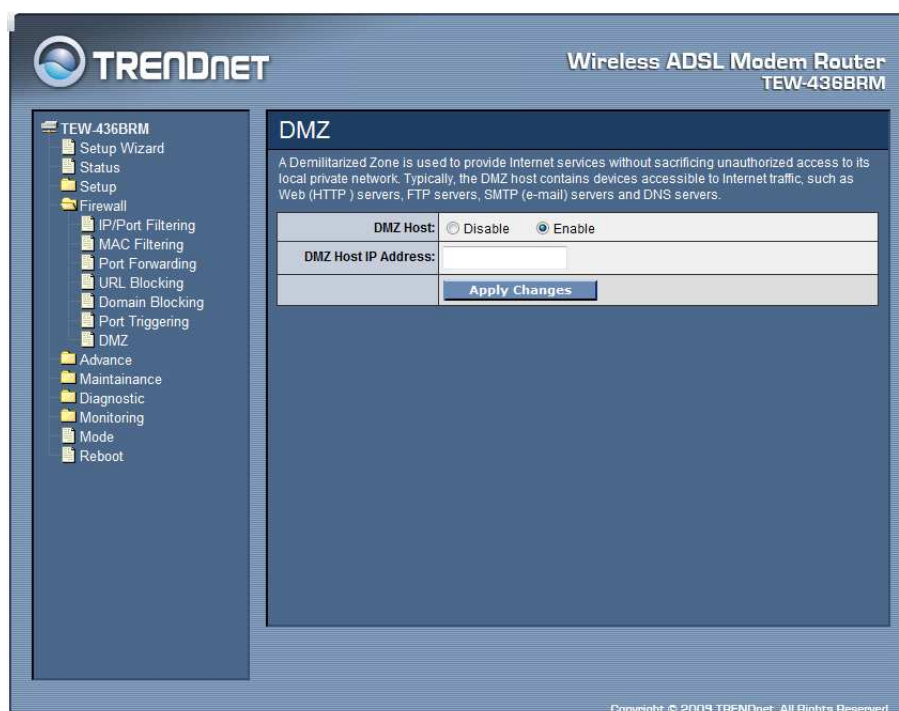

**DMZ Host:** Select to enable or disable the DMZ feature.

**DMZ Host IP Address:** Enter a IP address of the local host. This feature sets a local host to be exposed to the Internet

---

## Advance – Used only on Router mode settings

---

The Advance setting is for the WLAN ADSL Router is configured on Router mode only. Please refer the **Mode** setting in page 72.

---

### Wireless

---

## Advanced Settings

These settings are only for more technically advanced users who have a sufficient knowledge about wireless LAN. These settings should not be changed unless you know what effect the changes will have on your WLAN ADSL Router.

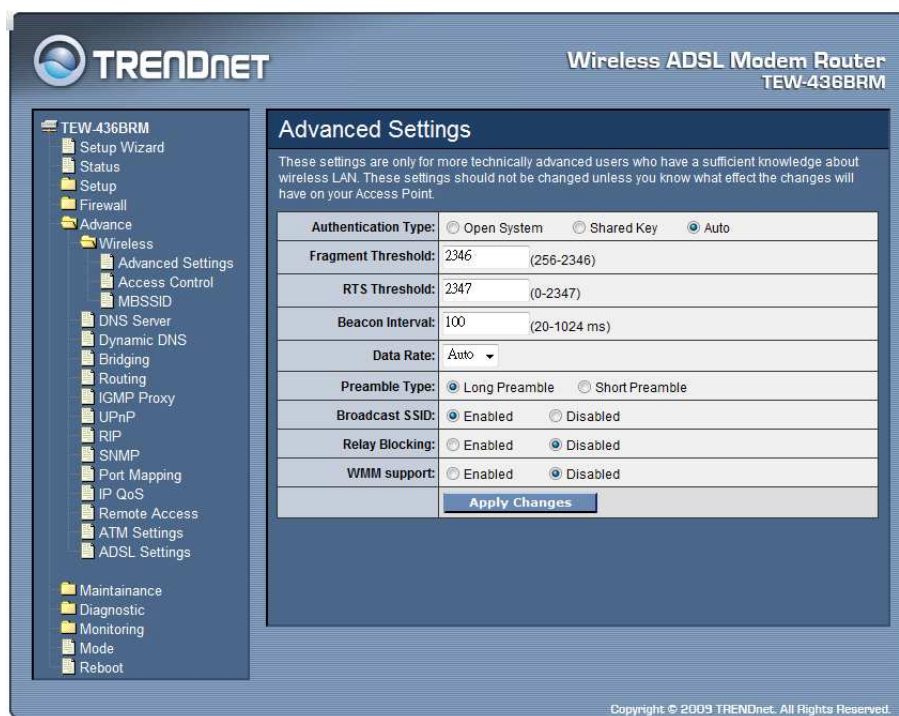

**Authentication Type: Open System:** Open System authentication is not required to be successful while a client may decline to authenticate with any particular other client. **Shared Key:** Shared Key is only available if the WEP option is implemented. Shared Key authentication supports authentication of clients as either a member of those who know a shared secret key or a member of those who do not. IEEE 802.11 Shared Key authentication accomplishes this without the need to transmit the secret key in clear. Requiring the use of the WEP privacy mechanism. **Auto:** Auto is the default authentication algorithm. It will change its authentication type automatically to fulfill client's requirement.

**Fragment Threshold:** This value should remain at its default setting of 2000. It specifies the maximum size for a packet before data is fragmented into multiple packets. If you experience a high packet error rate, you may slightly increase the “Fragment Threshold” value within the value range of 256 to 2346. Setting this value too low may result in poor network performance. Only minor modifications of this value are recommended. The default is 2346.

**RTS Threshold:** This value should remain at its default setting of 2000. Should you encounter inconsistent data flow, only minor modifications are recommended. If a network packet is smaller than the preset “RTS threshold” size, the RTS/CTS mechanism will not be enabled. The ADSL modem (or AP) sends Request to Send (RTS) frames to a particular receiving station and negotiates the sending of a data frame. After receiving an RTS, the wireless station responds with a Clear to Send (CTS) frame to acknowledge the right to begin transmission. The default is 2347.

**Beacon Interval:** The Beacon Interval value indicates the frequency interval of the beacon. Enter a value between 20 and 1024. A beacon is a packet broadcast by the ADSL modem (or AP) to synchronize the wireless network. The default is 100.

**Data Rate:** The rate of data transmission should be set depending on the speed of your wireless network. You should select from a range of transmission speeds, or you can select Auto to have the WLAN ADSL Router automatically use the fastest possible data rate and enable the Auto-Fallback feature. Auto-Fallback will negotiate the best possible connection speed between the AP and a wireless client. The default setting is Auto.

**Preamble Type:** The Preamble Type defines the length of the CRC (Cyclic Redundancy Check) block for communication between the AP and mobile wireless stations. Make sure to select the appropriate preamble type. Note that high network traffic areas should use the short preamble type. CRC is a common technique for detecting data transmission errors.

**Broadcast SSID:** Select to enable or disable the Broadcast SSID feature. If this option is enabled, the device will automatically transmit their network name (SSID) into open air at regular interval. This feature is intended to allow clients to dynamically discover and roam between WLANs; if this option is disabled, the device will hide its SSID. When this is done, the station cannot directly discover its WLAN and MUST be configured with the SSID. Note that in a home Wi-Fi network, roaming is largely unnecessary and the SSID broadcast feature serves no useful purpose. You should disable this feature to improve the security of your WLAN.



**Relay Blocking:** Select to enable or disable the Relay Blocking feature. When Relay Blocking is enabled, wireless clients will not be able to directly access other wireless clients.

**WMM support:** Select to enable or disable the WMM (Wi-Fi Multimedia) QoS feature.

## Access Control

This feature allows administrator to have access control by enter MAC address of client stations. When Enable this function, MAC address can be added into access control list and only those clients whose wireless MAC address are in the access control list will be able to connect to your WLAN ADSL Router.

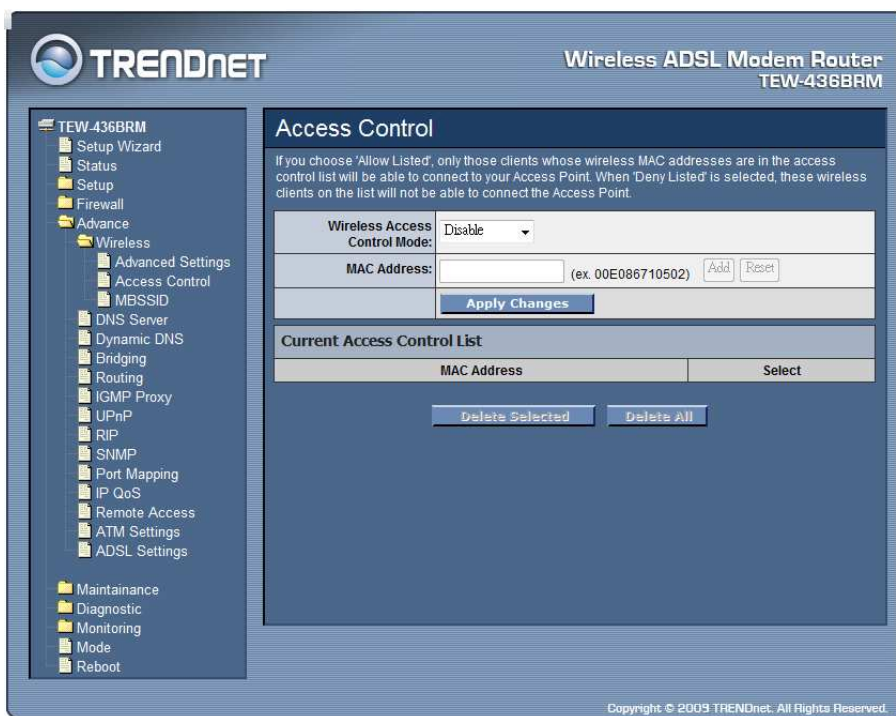

**Wireless Access Control Mode: Disable:** Disable the wireless ACL feature;  
**Allow Listed:** When this option is selected, no wireless clients except those whose MAC addresses are in the current access control list will be able to connect (to this device);  
**Deny Listed:** When this option is selected, all wireless clients except those whose MAC addresses are in the current access control list will be able to connect (to this device).

**MAC Address:** Enter client MAC address and click “Add” button to add client MAC address into current access control list.

**Delete Selected:** Click the “Delete Selected” button to delete the selected rule from Current Access Control List.

**Delete All:** Click the “Delete All” button to delete the all of rule in the Current Access Control List.