

# TP-LINK®

## User Guide

**TL-WR843ND**

**300Mbps Wireless AP/Client Router**



---

Rev: 1.0.0

1910010694

## COPYRIGHT & TRADEMARKS

Specifications are subject to change without notice. **TP-LINK®** is a registered trademark of TP-LINK TECHNOLOGIES CO., LTD. Other brands and product names are trademarks or registered trademarks of their respective holders.

No part of the specifications may be reproduced in any form or by any means or used to make any derivative such as translation, transformation, or adaptation without permission from TP-LINK TECHNOLOGIES CO., LTD. Copyright © 2012 TP-LINK TECHNOLOGIES CO., LTD. All rights reserved.

<http://www.tp-link.com>

## FCC STATEMENT



This equipment has been tested and found to comply with the limits for a Class B digital device, pursuant to part 15 of the FCC Rules. These limits are designed to provide reasonable protection against harmful interference in a residential installation. This equipment generates, uses and can radiate radio frequency energy and, if not installed and used in accordance with the instructions, may cause harmful interference to radio communications. However, there is no guarantee that interference will not occur in a particular installation. If this equipment does cause harmful interference to radio or television reception, which can be determined by turning the equipment off and on, the user is encouraged to try to correct the interference by one or more of the following measures:

- Reorient or relocate the receiving antenna.
- Increase the separation between the equipment and receiver.
- Connect the equipment into an outlet on a circuit different from that to which the receiver is connected.
- Consult the dealer or an experienced radio/ TV technician for help.

This device complies with part 15 of the FCC Rules. Operation is subject to the following two conditions:

- 1) This device may not cause harmful interference.
- 2) This device must accept any interference received, including interference that may cause undesired operation.

Any changes or modifications not expressly approved by the party responsible for compliance could void the user's authority to operate the equipment.

Note: The manufacturer is not responsible for any radio or tv interference caused by unauthorized modifications to this equipment. Such modifications could void the user's authority to operate the equipment.

## **FCC RF Radiation Exposure Statement**

This equipment complies with FCC RF radiation exposure limits set forth for an uncontrolled environment. This device and its antenna must not be co-located or operating in conjunction with any other antenna or transmitter.

“To comply with FCC RF exposure compliance requirements, this grant is applicable to only Mobile Configurations. The antennas used for this transmitter must be installed to provide a separation distance of at least 20 cm from all persons and must not be co-located or operating in conjunction with any other antenna or transmitter.”

## **CE Mark Warning**

# **CE 1588**

This is a Class B product. In a domestic environment, this product may cause radio interference, in which case the user may be required to take adequate measures.

This device has been designed to operate with the antennas listed below, and having a maximum gain of 5 dBi. Antennas not included in this list or having a gain greater than 5 dBi are strictly prohibited for use with this device. The required antenna impedance is 50 ohms.

To reduce potential radio interference to other users, the antenna type and its gain should be so chosen that the equivalent isotropically radiated power (e.i.r.p.) is not more than that permitted for successful communication.

## **Canadian Compliance Statement**

This device complies with Industry Canada license-exempt RSS standard(s). Operation is subject to the following two conditions:

- (1) This device may not cause interference, and
- (2) This device must accept any interference, including interference that may cause undesired operation of the device.

Cet appareil est conforme aux normes CNR exemptes de licence d'Industrie Canada. Le fonctionnement est soumis aux deux conditions suivantes:

- (1) cet appareil ne doit pas provoquer d'interférences et
- (2) cet appareil doit accepter toute interférence, y compris celles susceptibles de provoquer un fonctionnement non souhaité de l'appareil.

## **Industry Canada Statement**

Complies with the Canadian ICES-003 Class B specifications.

Cet appareil numérique de la classe B est conforme à la norme NMB-003 du Canada.

This device complies with RSS 210 of Industry Canada. This Class B device meets all the requirements of the Canadian interference-causing equipment regulations.

Cet appareil numérique de la Classe B respecte toutes les exigences du Règlement sur le matériel brouilleur du Canada.

## Korea Warning Statements

당해 무선설비는 운용중 전파혼신 가능성이 있음.

## NCC Notice

經型式認證合格之低功率射頻電機，非經許可，公司、商號或使用者均不得擅自變更頻率、加大功率或變更原設計之特性及功能。

低功率射頻電機之使用不得影響飛航安全及干擾合法通信；經發現有干擾現象時，應立即停用，並改善至無干擾時方得繼續使用。前項合法通信，指依電信法規定作業之無線電通信。低功率射頻電機須忍受合法通信或工業、科學及醫療用電波輻射性電機設備之干擾。



Продукт сертифіковано згідно с правилами системи УкрСЕПРО на відповідність вимогам нормативних документів та вимогам, що передбачені чинними законодавчими актами України.

## Safety Information

- When product has power button, the power button is one of the way to shut off the product; when there is no power button, the only way to completely shut off power is to disconnect the product or the power adapter from the power source.
- Don't disassemble the product, or make repairs yourself. You run the risk of electric shock and voiding the limited warranty. If you need service, please contact us.
- Avoid water and wet locations.

This product can be used in the following countries:

AT	BG	BY	CA	CZ	DE	DK	EE
ES	FI	FR	GB	GR	HU	IE	IT
LT	LV	MT	NL	NO	PL	PT	RO
RU	SE	SK	TR	UA			

## DECLARATION OF CONFORMITY

For the following equipment:

Product Description: 300Mbps Wireless AP/Client Router

Model No.: TL-WR843ND

Trademark: TP-LINK

We declare under our own responsibility that the above products satisfy all the technical regulations applicable to the product within the scope of Council Directives:

Directives 1999/5/EC, Directives 2004/108/EC, Directives 2006/95/EC, Directives 1999/519/EC, Directives 2011/65/EU

The above product is in conformity with the following standards or other normative documents

ETSI EN 300 328 V1.7.1: 2006

ETSI EN 301 489-1 V1.8.1:2008& ETSI EN 301 489-17 V2.2.1:2012

EN 55022:2010

EN 55024:2010

EN 61000-3-2:2006+A1:2009+A2:2009

EN 61000-3-3:2008

EN60950-1:2006+A11; 2009+A1:2010+A12:2011

EN62311:2008

The product carries the CE Mark:

**CE 1588**

Person is responsible for marking this declaration:



Yang Hongliang

Product Manager of International Business

Date of issue: 2012

TP-LINK TECHNOLOGIES CO., LTD.

Building 24 (floors 1, 3, 4, 5), and 28 (floors 1-4) Central Science and Technology Park,  
Shennan Rd, Nanshan, Shenzhen, China

# CONTENTS

<b>Package Contents</b> .....	<b>1</b>
<b>Chapter 1. Introduction</b> .....	<b>2</b>
1.1 Overview of the Router.....	2
1.2 Conventions .....	3
1.3 Main Features .....	3
1.4 Panel Layout .....	4
1.4.1 The Front Panel.....	4
1.4.2 The Rear Panel .....	5
<b>Chapter 2. Connecting the Router</b> .....	<b>7</b>
2.1 System Requirements .....	7
2.2 Installation Environment Requirements.....	7
2.3 Connecting the Router .....	7
<b>Chapter 3. Quick Installation Guide</b> .....	<b>10</b>
3.1 TCP/IP Configuration .....	10
3.2 Quick Installation Guide .....	12
3.2.1 Configuration for Router Mode .....	14
3.2.2 Configuration for Client Router Mode .....	17
<b>Chapter 4. Configuring the Router</b> .....	<b>23</b>
4.1 Login .....	23
4.2 Status .....	23
4.3 Quick Setup.....	24
4.4 WPS.....	25
4.5 Working Mode .....	27
4.6 Network.....	28
4.6.1 WAN .....	28
4.6.2 MAC Clone .....	37
4.6.3 LAN .....	38
4.7 Wireless .....	39
4.7.1 Wireless Settings.....	39
4.7.2 Wireless Security.....	46
4.7.3 Wireless MAC Filtering .....	49
4.7.4 Wireless Advanced .....	50

4.7.5	Wireless Statistics.....	52
4.8	DHCP.....	53
4.8.1	DHCP Settings.....	53
4.8.2	DHCP Client List.....	54
4.8.3	Address Reservation.....	54
4.9	Forwarding.....	56
4.9.1	Virtual Servers.....	56
4.9.2	Port Triggering.....	58
4.9.3	DMZ.....	59
4.9.4	UPnP.....	60
4.10	Security.....	61
4.10.1	Basic Security.....	61
4.10.2	Advanced Security.....	63
4.10.3	Local Management.....	64
4.10.4	Remote Management.....	65
4.11	Parental Control.....	66
4.12	Access Control.....	69
4.12.1	Rule.....	69
4.12.2	Host.....	75
4.12.3	Target.....	76
4.12.4	Schedule.....	79
4.13	Advanced Routing.....	80
4.13.1	Static Routing.....	81
4.13.2	System Routing Table.....	82
4.14	Bandwidth Control.....	82
4.14.1	Control Settings.....	83
4.14.2	Rules List.....	83
4.15	IP & MAC Binding.....	84
4.15.1	Binding Settings.....	84
4.15.2	ARP List.....	86
4.16	Dynamic DNS.....	87
4.16.1	Comexe.cn DDNS.....	87
4.16.2	Dyndns.org DDNS.....	88
4.16.3	No-ip.com DDNS.....	89
4.17	System Tools.....	90

4.17.1 Time Settings.....	90
4.17.2 Diagnostic.....	92
4.17.3 Firmware Upgrade.....	94
4.17.4 Factory Defaults .....	95
4.17.5 Backup & Restore.....	95
4.17.6 Reboot.....	96
4.17.7 Password.....	97
4.17.8 System Log.....	97
4.17.9 Statistics .....	100
<b>Appendix A: FAQ .....</b>	<b>102</b>
<b>Appendix B: Configuring the PC .....</b>	<b>107</b>
<b>Appendix C: Specifications .....</b>	<b>111</b>
<b>Appendix D: Glossary .....</b>	<b>112</b>



## Package Contents

The following items should be found in your package:

- TL-WR843ND 300Mbps Wireless AP/Client Router
- Power Adapter for TL-WR843ND 300Mbps Wireless AP/Client Router
- Quick Installation Guide
- Resource CD for TL-WR843ND 300Mbps Wireless AP/Client Router, including:
  - This Guide
  - Other Helpful Information

 **Note:**

Make sure that the package contains the above items. If any of the listed items are damaged or missing, please contact your distributor.

## Chapter 1. Introduction

### 1.1 Overview of the Router

The TL-WR843ND 300Mbps Wireless AP/Client Router integrates 4-port Switch, Firewall, NAT-Router and Wireless AP. Powered by 2x2 MIMO technology, the 300Mbps Wireless AP/Client Router delivers exceptional range and speed, which can fully meet the need of Small Office/Home Office (SOHO) networks and the users demanding higher networking performance.

#### Incredible Speed

The TL-WR843ND 300Mbps Wireless AP/Client Router provides up to 300Mbps wireless connection with other 802.11n wireless clients. The incredible speed makes it ideal for handling multiple data streams at the same time, which ensures your network stable and smooth. The performance of this 802.11n wireless Router will give you the unexpected networking experience at speed much faster than 802.11g. It is also compatible with all IEEE 802.11g and IEEE 802.11b products.

#### Multiple Working Modes

The TL-WR843ND 300Mbps Wireless AP/Client Router supports two working modes. The WISP Client Router mode allows the TL-WR843ND to connect to the WISP and create a local area network via wireless connection. The Standard Wireless Router mode enables the TL-WR843ND to work as a router for network sharing with high speed.

#### Multiple Security Protections

With multiple protection measures, including SSID broadcast control and wireless LAN 64/128/152-bit WEP encryption, WiFi protected Access (WPA2- PSK, WPA- PSK), as well as advanced Firewall protections, the TL-WR843ND 300Mbps Wireless AP/Client Router provides complete data privacy.

#### Flexible Access Control

The TL-WR843ND 300Mbps Wireless AP/Client Router provides flexible access control, so that parents or network administrators can establish restricted access policies for children or staff. It also supports Virtual Server and DMZ host for Port Triggering, and then the network administrators can manage and monitor the network in real time with the remote management function.

## Simple Installation

Since the Router is compatible with virtually all the major operating systems, it is very easy to manage. Quick Setup Wizard is supported and detailed instructions are provided step by step in this user guide. Before installing the Router, please look through this guide to know all the Router's functions.

## 1.2 Conventions

The Router or TL-WR843ND mentioned in this guide stands for TL-WR843ND 300Mbps Wireless AP/Client Router without any explanation.

## 1.3 Main Features

- Complies with IEEE 802.11n to provide a wireless data rate of up to 300Mbps.
- One 10/100M Auto-Negotiation RJ45 INTERNET port, supporting passive POE at AP Client Router mode.
- Four 10/100M Auto-Negotiation RJ45 LAN ports, supporting Auto MDI/MDIX.
- Provides WPA/WPA2, WPA-PSK/WPA2-PSK authentication, TKIP/AES encryption security.
- Shares data and Internet access for users, supporting Dynamic IP/Static IP/PPPoE Internet access.
- Supports Client Router mode for WISP Connection.
- Supports Virtual Server, Special Application and DMZ host.
- Supports UPnP, Dynamic DNS, Static Routing.
- Provides Automatic-connection and Scheduled Connection on certain time to the Internet
- Built-in NAT and DHCP server supporting static IP address distributing.
- Supports Parental Control and Access Control.
- Connects Internet on demand and disconnects from the Internet when idle for PPPoE.
- Provides 64/128/152-bit WEP encryption security and wireless LAN ACL (Access Control List).
- Supports Flow Statistics.
- Supports firmware upgrade and Web management.

## 1.4 Panel Layout

### 1.4.1 The Front Panel

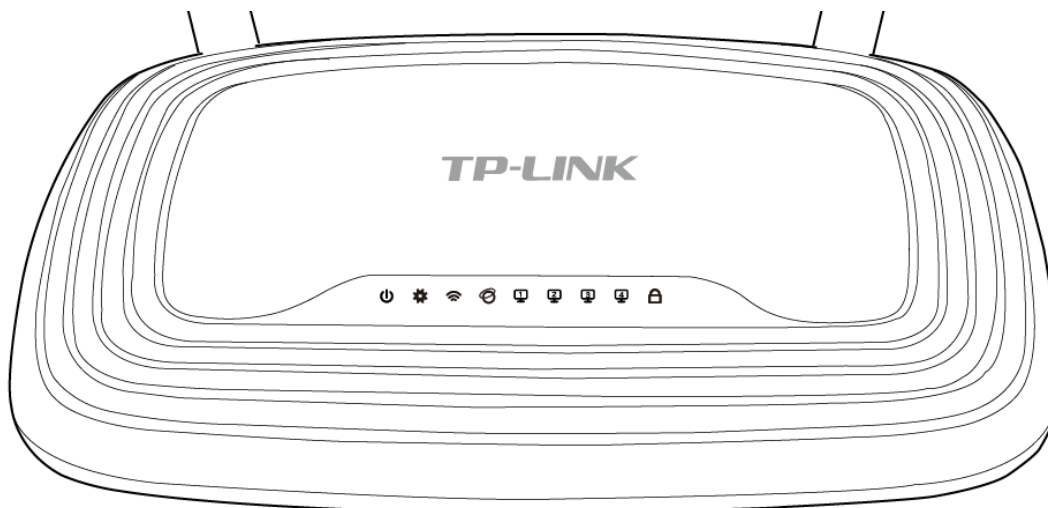

Figure 1-1 Front Panel sketch

The Router's LEDs are located on the front panel (View from left to right).

Name	Status	Indication
⏻ (Power)	Off	Power is off.
	On	Power is on.
⚙️ (System)	Flashing	The Router is working properly.
	On/Off	The Router has a system error.
📶 (WLAN)	Off	The Wireless function is disabled.
	Flashing	The Wireless function is enabled.
🌐 (WAN), 📺 (LAN 1-4)	Off	There is no device linked to the corresponding port.
	On	There is a device linked to the corresponding port but there is no activity.
	Flashing	There is an active device linked to the corresponding port.
🔒 (WPS)	Slow Flash	A wireless device is connecting to the network by WPS function. This process will last in the first 2 minutes.
	On	A wireless device has been successfully added to the network by WPS function.
	Quick Flash	A wireless device failed to be added to the network by WPS function.

Table 1-1 The LEDs Description

**Note:**

After a device is successfully added to the network by WPS function, the WPS LED will keep on for about 5 minutes and then turn off.

## 1.4.2 The Rear Panel

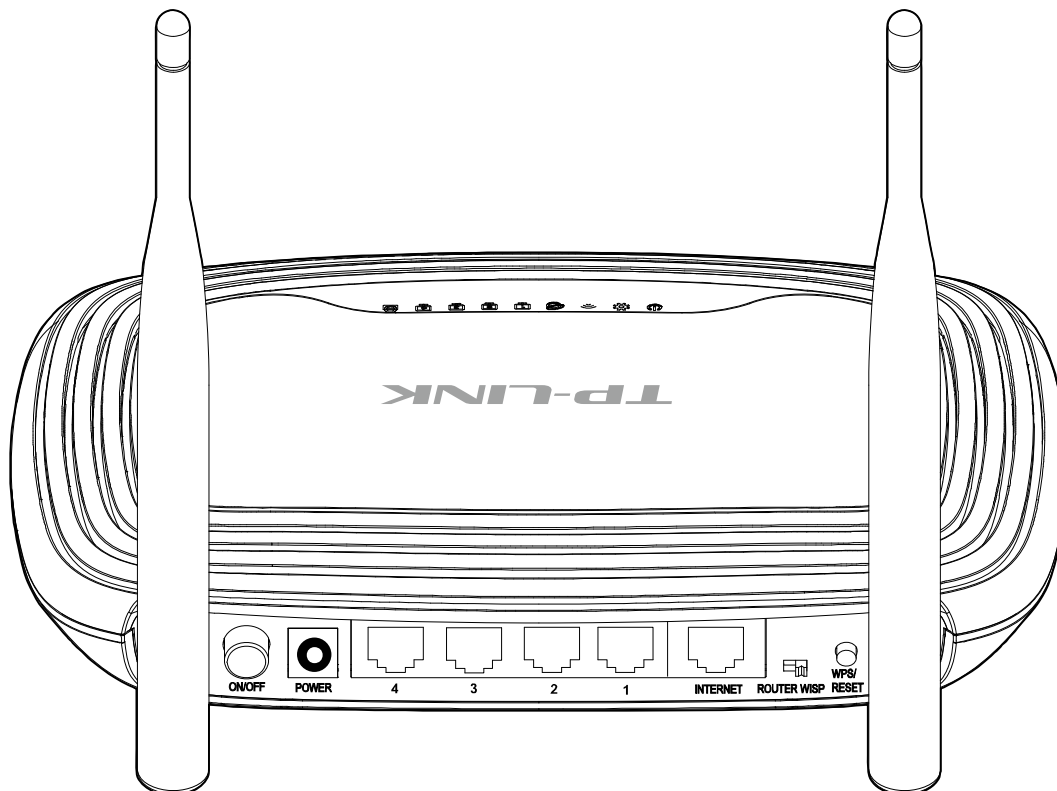

Figure 1-2 Rear Panel sketch

The following parts are located on the rear panel (View from left to right).

- **ON/OFF:** The switch for the power.
- **POWER:** The Power socket is where you will connect the power adapter. Please use the power adapter provided with this TL-WR843ND 300Mbps Wireless AP/Client Router.
- **4,3,2,1 (LAN):** These ports (4,3,2,1) connect the Router to the local PC(s).
- **INTERNET:** This INTERNET port is where you will connect the DSL/cable Modem, or Ethernet.
- **ROUTER WISP:** This switch is used to select working mode.
- **WPS/RESET:** This button is used for both WPS and Reset function. To use the WPS function, press it for less than five seconds; to use the RESET function, press it for more than five seconds.

- **Used as RESET button:**

There are two ways to reset to the Router's factory defaults:

- 1) Use the **Factory Defaults** function on **System Tools** → **Factory Defaults** page in the Router's Web-based Utility.
- 2) Use the **WPS/RESET** button: With the Router powered on, press and hold the **WPS/RESET** button (more than 5 seconds) until the SYS LED becomes quick-flash from slow-flash. Then release the button and wait the Router to reboot to its factory default

settings.

- **Used as WPS button:**

If you have client devices, such as wireless adapters, that support Wi-Fi Protected Setup, then you can press this button to quickly establish a connection between the Router and client devices and automatically configure wireless security for your wireless network.

➤ **Wireless antenna:** To receive and transmit the wireless data.

## Chapter 2. Connecting the Router

### 2.1 System Requirements

- Broadband Internet Access Service (DSL/Cable/Ethernet)
- One DSL/Cable Modem that has an RJ45 connector (which is not necessary if the Router is connected directly to the Ethernet.)
- PCs with a working Ethernet Adapter and an Ethernet cable with RJ45 connectors
- TCP/IP protocol on each PC
- Web browser, such as Microsoft Internet Explorer, Mozilla Firefox or Apple Safari

### 2.2 Installation Environment Requirements

- Place the Router in a well ventilated place far from any heater or heating vent
- Avoid direct irradiation of any strong light (such as sunlight)
- Keep at least 2 inches (5 cm) of clear space around the Router
- Operating Temperature: 0°C~40°C (32°F~104°F)
- Operating Humidity: 10%~90%RH, Non-condensing

### 2.3 Connecting the Router

To connect the Router, please follow the steps below:

- 1) Locate an optimum location for the Router. The best place is usually at the center of your wireless network. The place must accord with the [Installation Environment Requirements](#).
- 2) Adjust the direction of the antenna. Normally, upright is a good direction.

After finishing the steps above, please choose the working mode you need and carry out the corresponding steps. There are two working mode supported by this router: **WISP Client Router** and **Standard Wireless Router**.

**a) WISP Client Router Mode**

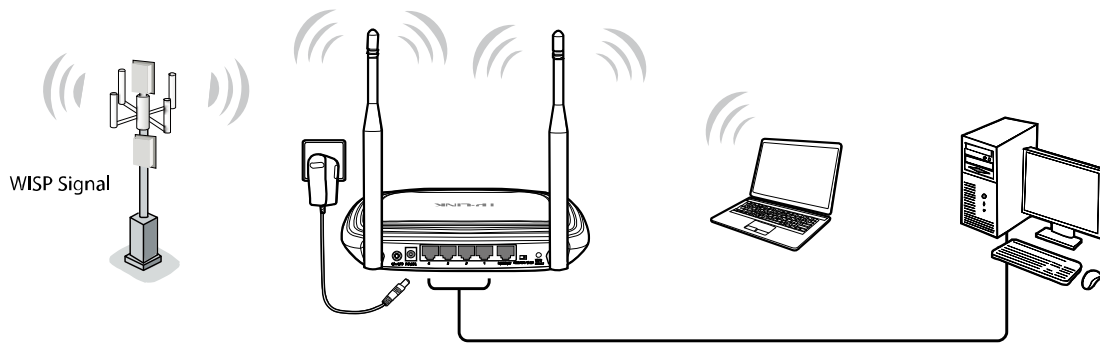

Figure 2-1 Hardware Installation of the TL-WR843ND in WISP Client Router mode

1. Connect the notebook/PC to the LAN port of TL-WR843ND router with an Ethernet cable.
2. Plug one end of the provided power adapter into the POWER jack of the router, and the other end to a standard electrical wall socket.
3. Press the ON/OFF button of the router.

**b) Standard Wireless Router Mode**

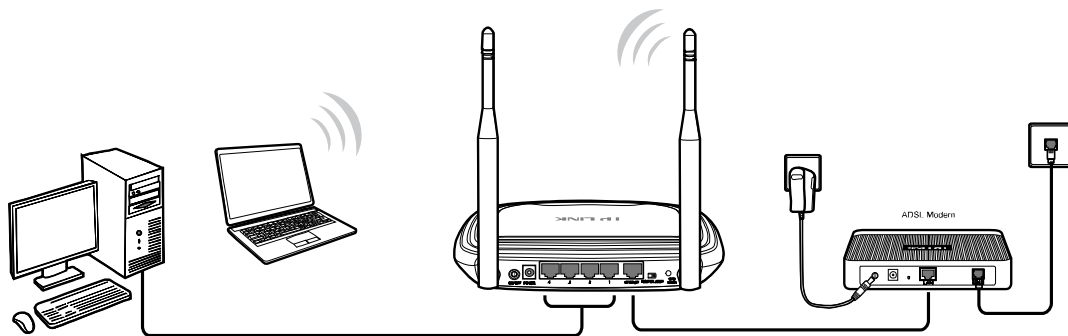

Figure 2-2 Hardware Installation of the TL-WR843ND in Router mode

1. Connect the PC(s)/Switch/Hub in your LAN to the LAN Ports on the Router.
2. Connect the DSL/Cable Modem to the INTERNET port on the Router.
3. Plug one end of the provided power adapter into the POWER jack of the router, and the other end to a standard electrical wall socket.
4. Press the ON/OFF button of the router.



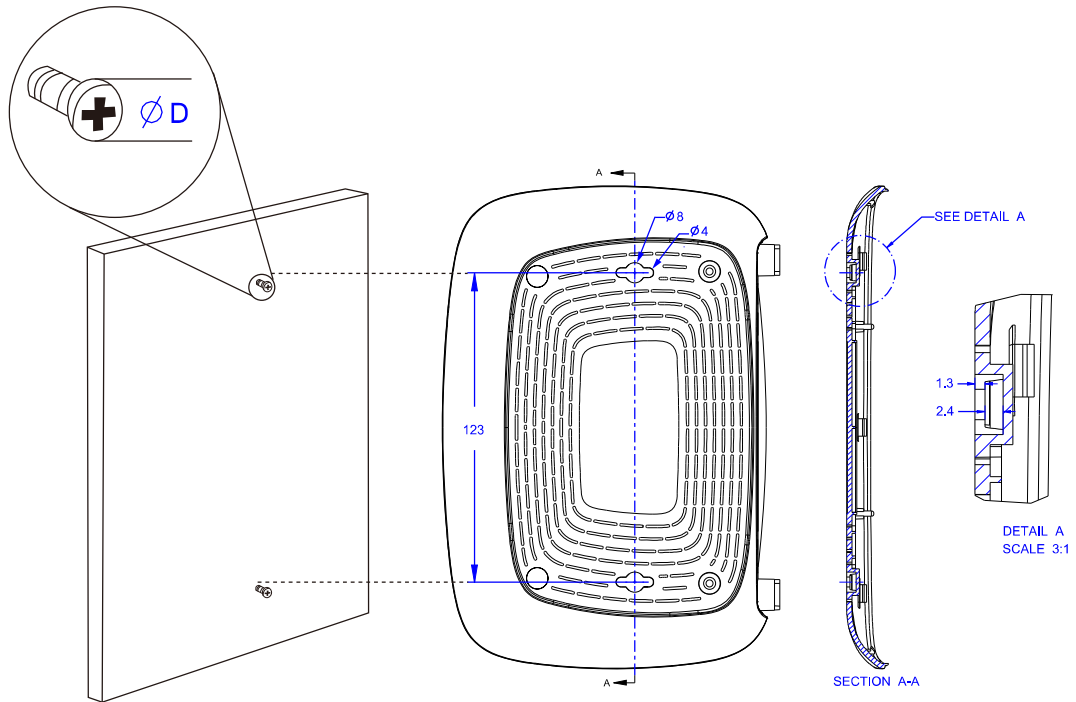

Figure 2-3 Wall-mount Install

Note: The diameter of the screw,  $4\text{mm} < D < 8\text{mm}$ , and the distance of two screws is 123mm. The screw that project from the wall need around 4mm based, and the length of the screw need to be at least 20mm to withstand the weight of the product.

## Chapter 3. Quick Installation Guide

This chapter will show you how to configure the basic functions of your TL-WR843ND 300Mbps Wireless AP/Client Router using **Quick Setup Wizard** within minutes.

### 3.1 TCP/IP Configuration

The default domain name of the TL-WR843ND 300Mbps Wireless AP/Client Router is <http://tplinklogin.net>, the default IP address is 192.168.0.1, and the default Subnet Mask is 255.255.255.0. These values can be changed as you desire. In this guide, we use all the default values for description.

Connect the local PC to the LAN ports of the Router. And then you can configure the IP address for your PC in the following two ways.

- Configure the IP address manually
  - 1) Set up the TCP/IP Protocol for your PC. If you need instructions as to how to do this, please refer to [Appendix B: "Configuring the PC"](#).
  - 2) Configure the network parameters. The IP address is 192.168.0.xxx ("xxx" is any number from 2 to 254), Subnet Mask is 255.255.255.0, and Gateway is 192.168.0.1 (The Router's default IP address)
- Obtain an IP address automatically
  - 1) Set up the TCP/IP Protocol in "**Obtain an IP address automatically**" mode on your PC. If you need instructions as to how to do this, please refer to [Appendix B: "Configuring the PC"](#).
  - 2) Then the built-in DHCP server will assign IP address for the PC.

Now, you can run the Ping command in the **command prompt** to verify the network connection between your PC and the Router. The following example is in Windows XP.

Open a command prompt, and type *ping 192.168.0.1*, and then press **Enter**.

- If the result displayed is similar to the Figure 3-1, it means the connection between your PC and the Router has been established well.

```

C:\WINDOWS\system32\cmd.exe
Microsoft Windows XP [Version 5.1.2600]
(C) Copyright 1985-2001 Microsoft Corp.

C:\Documents and Settings\english>ping 192.168.0.1

Pinging 192.168.0.1 with 32 bytes of data:

Reply from 192.168.0.1: bytes=32 time<1ms TTL=64
Reply from 192.168.0.1: bytes=32 time<1ms TTL=64
Reply from 192.168.0.1: bytes=32 time<1ms TTL=64
Reply from 192.168.0.1: bytes=32 time<1ms TTL=64

Ping statistics for 192.168.0.1:
    Packets: Sent = 4, Received = 4, Lost = 0 (0% loss),
    Approximate round trip times in milli-seconds:
        Minimum = 0ms, Maximum = 0ms, Average = 0ms

C:\Documents and Settings\english>
    
```

Figure 3-1 Success result of Ping command

- If the result displayed is similar to the Figure 3-2, it means the connection between your PC and the Router is failed.

```

C:\WINDOWS\system32\cmd.exe
Microsoft Windows XP [Version 5.1.2600]
(C) Copyright 1985-2001 Microsoft Corp.

C:\Documents and Settings\english>ping 192.168.0.1

Pinging 192.168.0.1 with 32 bytes of data:

Destination host unreachable.
Destination host unreachable.
Destination host unreachable.
Destination host unreachable.

Ping statistics for 192.168.0.1:
    Packets: Sent = 4, Received = 0, Lost = 4 (100% loss),

C:\Documents and Settings\english>
    
```

Figure 3-2 Failure result of Ping command

**Please check the connection following these steps:**

1. Is the connection between your PC and the Router correct?

**Note:**

The 1/2/3/4 LEDs of LAN ports which you link to on the Router and LEDs on your PC's adapter should be lit.

2. Is the TCP/IP configuration for your PC correct?

**Note:**

If the Router's IP address is 192.168.0.1, your PC's IP address must be within the range of 192.168.0.2 ~ 192.168.0.254.

- Is the default LAN IP of the Router correct?

 **Note:**

If the LAN IP of the modem connected with your router is 192.168.0.x, the default LAN IP of the Router will automatically switch from 192.168.0.1 to 192.168.1.1 to avoid IP conflict. Therefore, in order to verify the network connection between your PC and the Router, you can open a command prompt, and type *ping 192.168.1.1*, and then press **Enter**.

## 3.2 Quick Installation Guide

With a Web-based utility, it is easy to configure and manage the TL-WR843ND 300Mbps Wireless AP/Client Router. The Web-based utility can be used on any Windows, Macintosh or UNIX OS with a Web browser, such as Microsoft Internet Explorer, Mozilla Firefox or Apple Safari.

- To access the configuration utility, open a web-browser and type in the default address <http://tplinklogin.net> in the address field of the browser.



Figure 3-3 Log in the Router

After a moment, a login window will appear, similar to the Figure 3-4. Enter **admin** for the User Name and Password, both in lower case letters. Then click the **OK** button or press the **Enter** key.

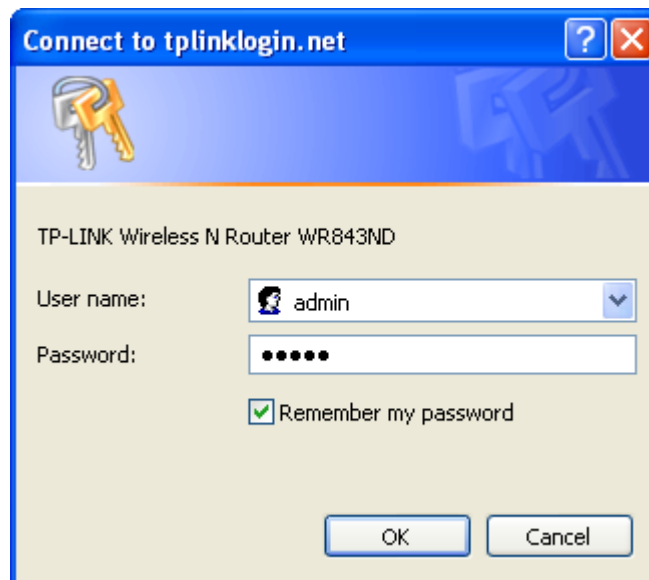

Figure 3-4 Login Windows

 **Note:**

If the above screen does not pop-up, it means that your Web-browser has been set to a proxy. Go to Tools menu>Internet Options>Connections>LAN Settings, in the screen that appears, cancel the Using Proxy checkbox, and click **OK** to finish it.

2. After a successful login, you can click the **Quick Setup** menu to quickly configure your Router.

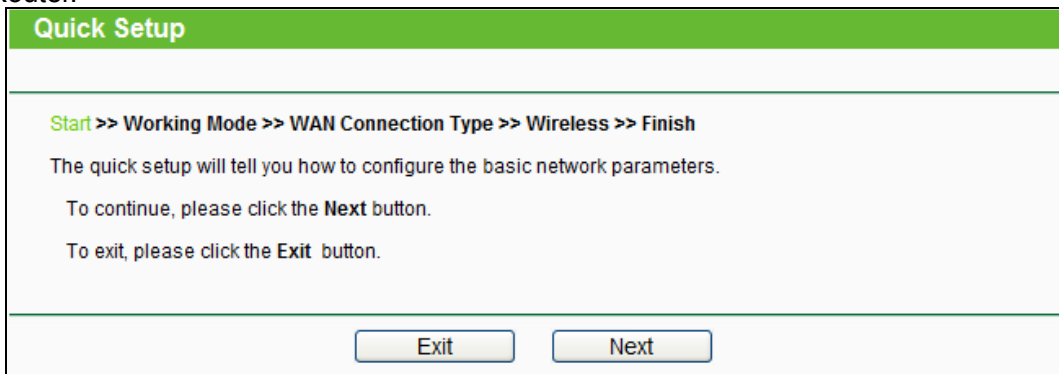

Figure 3-5 Quick Setup

3. Click **Next**, and then **Working Mode** page will appear. Tick **Control the system mode by software**, as shown in Figure 3-6.

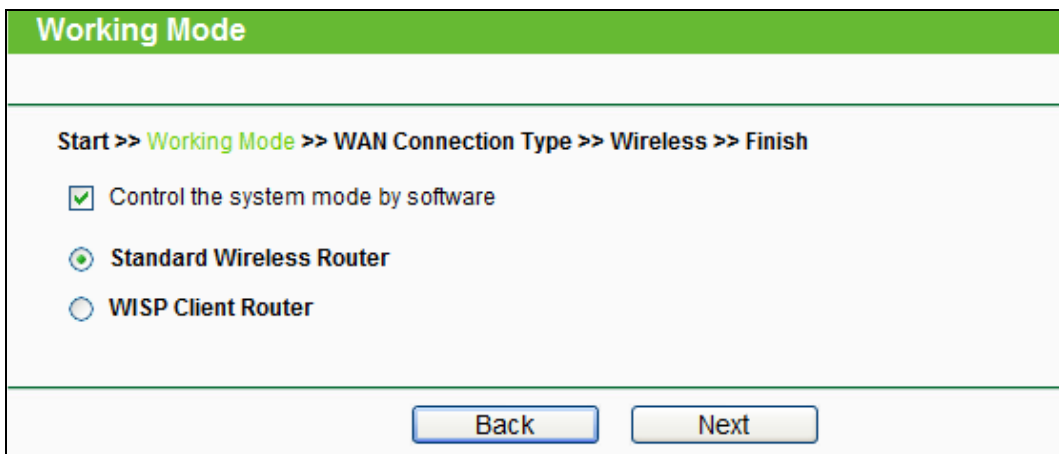
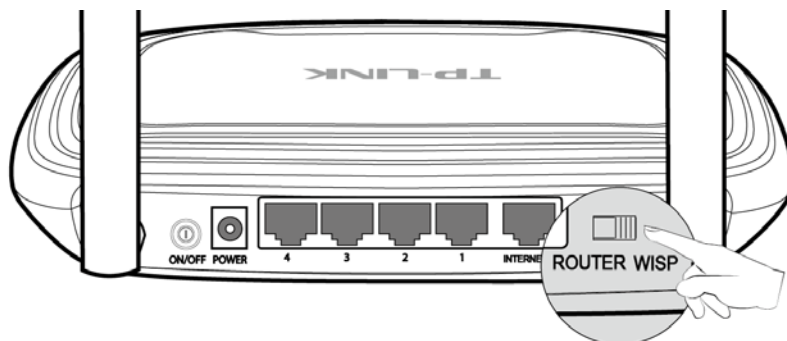

Figure 3-6 Working Mode

**Note:**

- 1) The Router supports two working modes for multi-user to access the Internet: Standard Wireless Router and WISP Client Router, you can either select working mode by software as shown above or select it by turn the **work mode switch** at the back panel of your router, as shown below.



- 2) If you are unsure about which one to select, please refer to **Working Mode Help** page on the right. You can configure your device quickly by the following steps in different modes.

### 3.2.1 Configuration for Router Mode

When you choose **Standard Wireless Router** on **Working Mode** page as shown in Figure 3-6 , take the following steps:

1. Click **Next**, and then **WAN Connection Type** page will appear as shown in Figure 3-7.

Figure 3-7 WAN Connection Type

The Router provides **Auto-Detect** function and supports three popular ways **Dynamic IP**, **PPPoE** and **Static IP** to connect to the Internet. It's recommended that you make use of the **Auto-Detect** function. If you are sure of what kind of connection type your ISP provides, you can select the very type and click **Next** to continue configuring.

2. If you select **Auto-Detect**, the Router will automatically detect the connection type your ISP provides. Make sure the cable is securely plugged into the WAN port before detection. The appropriate configuration page will be displayed when an active Internet service is successfully detected by the Router.
  - 1) If the connection type detected is **Dynamic IP**, the next screen will appear as shown in Figure 3-8. **MAC Clone** is necessary for most users using Cable Modem. It's highly recommended to do this on the **MAIN COMPUTER** that was originally connected to your Cable Modem.

Figure 3-8 MAC Clone

- 2) If the connection type detected is **PPPoE**, the next screen will appear as shown in Figure 3-9.

Figure 3-9 Quick Setup - PPPoE

- 3) If the connection type detected is **Static IP**, the next screen will appear as shown in Figure 3-10.

Figure 3-10 Quick Setup - Static IP

3. Click **Next** to continue, the Wireless settings page will appear as shown in Figure 3-11.

**Quick Setup - Wireless**

Start >> Working Mode >> WAN Connection Type >> **Wireless** >> Finish

Wireless Radio:  (dropdown)

Wireless Network Name:  (Also called the SSID)

Region:  (dropdown)

Warning: Ensure you select a correct country to conform local law. Incorrect settings may cause interference.

Mode:  (dropdown)

Channel Width:  (dropdown)

Channel:  (dropdown)

Max Tx Rate:  (dropdown)

Wireless Security:

Disable Security

WPA-PSK/WPA2-PSK

PSK Password:  (You can enter ASCII characters between 8 and 63 or Hexadecimal characters between 8 and 64.)

No Change

Figure 3-11 Quick Setup – Wireless

- **Wireless Radio** - The wireless radio can only be enabled and disabled.
- **Wireless Network Name** - Enter a value of up to 32 characters. The same name of SSID (Service Set Identification) must be assigned to all wireless devices in your network. Considering your wireless network security, the default SSID is set to be TP-LINK\_XXXXXX (XXXXXX indicates the last unique six numbers of each Router's MAC address). This value is case-sensitive. For example, *TEST* is NOT the same as *test*.
- **Region** - Select your region from the drop-down list. This field specifies the region where the wireless function of the Router can be used. It may be illegal to use the wireless function of the Router in a region other than one of those specified in this field. If your country or region is not listed, please contact your local government agency for assistance.

 **Note:**

Limited by local law regulations, version for North America does not have region selection option.

- **Mode** - This field determines the wireless mode which the Router works on.



- **Channel Width** - Select any channel width from the drop-down list. The default setting is automatic, which can adjust the channel width for your clients automatically.
- **Channel** - This field determines which operating frequency will be used. The default channel is set to **Auto**, so the AP will choose the best channel automatically. It is not necessary to change the wireless channel unless you notice interference problems with another nearby access point.
- **Max Tx Rate** - You can limit the maximum transmission rate of the Router through this field.
- **Disable Security** - The wireless security function can be enabled or disabled. If disabled, the wireless stations will be able to connect the Router without encryption. It is recommended strongly that you choose one of following options to enable security.
- **WPA-PSK/WPA2-PSK** - Select WPA based on pre-shared passphrase.
  - **PSK Password** - You can enter **ASCII** or **Hexadecimal** characters.
 

For **ASCII**, the key can be made up of any numbers 0 to 9 and any letters A to Z, the length should be between 8 and 63 characters.

For **Hexadecimal**, the key can be made up of any numbers 0 to 9 and letters A to F, the length should be between 8 and 64 characters.

Please also note the key is case sensitive, this means that upper and lower case keys will affect the outcome. It would also be a good idea to write down the key and all related wireless security settings.
- **No Change** - If you chose this option, wireless security configuration will not change!

These settings are only for basic wireless parameters. For advanced settings, please refer to [4.7 Wireless](#).

4. Click the **Next** button. You will see the page as shown in Figure 3-12. Please click the **Reboot/Finish** button to make your configuration take effect and finish the **Quick Setup**.

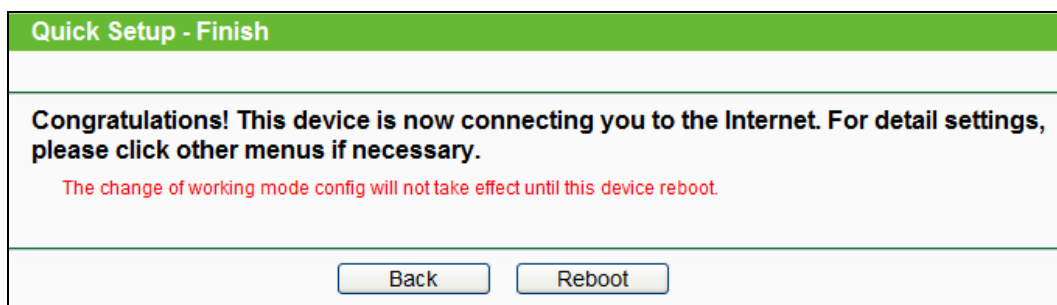

Figure 3-12 Quick Setup – Finish

### 3.2.2 Configuration for Client Router Mode

When you choose **Client Router** on **Working Mode** page in Figure 3-6 , take the following steps:

1. Click **Next**, and then WAN Connection Type page will appear as shown in Figure 3-13.

Figure 3-13 Quick Setup – WAN Connection Type

The router in Client Router mode supports three popular ways to connect to the Internet. Please select the one compatible with your ISP.

- a) If you choose "**Dynamic IP**", the router will automatically receive the IP parameters from your ISP without needing to enter any parameters.
- b) If you choose "**PPPoE**", you will see this page shown in Figure 3-14.

Figure 3-14 PPPoE

- **User Name and Password** - Enter the User Name and Password provided by your ISP. These fields are case-sensitive.
  - **Confirm Password** - Enter again the Password provided by your ISP to ensure the password you entered is correct.
- c) If you Choose "**Static IP**", the Static IP settings page will appear as shown in Figure 3-15.

**Quick Setup - Static IP**

Start >> Working Mode >> WAN Connection Type >> Wireless >> Finish

IP Address:

Subnet Mask:

Default Gateway:  (Optional)

Primary DNS:  (Optional)

Secondary DNS:  (Optional)

Figure 3-15 Static IP

**Note:**

The IP parameters should have been provided by your ISP.

- **IP Address** - This is the WAN IP address as seen by external users on the Internet (including your ISP). Enter the IP address into the field.
  - **Subnet Mask** - The Subnet Mask is used for the WAN IP address, it is usually 255.255.255.0.
  - **Default Gateway** - Enter the gateway IP address into the box if required.
  - **Primary DNS** - Enter the DNS Server IP address into the boxes if required.
  - **Secondary DNS** - If your ISP provides another DNS server, enter it into this field.
2. Click **Next**, and the Wireless settings page will appear as shown in Figure 3-16.

**Quick Setup - Wireless**

Start >> Working Mode >> WAN Connection Type >> **Wireless** >> Finish

**Client Setting**

SSID:

BSSID:  Example:00-1D-0F-11-22-33

Key type:

WEP Index:

Auth type:

Password:

**AP Setting**

Local SSID:

Wireless Security Mode:

Wireless Password:

You can enter ASCII or Hexadecimal characters. For Hexadecimal, the length should be between 8 and 64 characters; for ASCII, the length should be between 8 and 63 characters. For good security it should be of ample length and should not be a commonly known phrase.

Figure 3-16 Quick Setup – Wireless

- **SSID-** The SSID of the AP your Router is going to connect to as a client. You can also use the search function to select the SSID to join.
- **BSSID-** The BSSID of the AP your Router is going to connect to as a client. You can also use the search function to select the BSSID to join.
- **Survey** - Click this button, you can survey the AP which runs nearby.
- **Key type-** This option should be chosen according to the AP's security configuration. It is recommended that the key type is the same as your AP's security type.
- **WEP Index-** This option should be chosen if the key type is WEP (ASCII) or WEP (HEX).It indicates the index of the WEP key.
- **Auth Type-** This option should be chosen if the key type is WEP (ASCII) or WEP (HEX).It indicates the authorization type of the Root AP.
- **Password-** If the AP your device is going to connect needs password, you need to fill the password in this blank.

Click **Survey** button on the Wireless page as shown in Figure 3-16, and then AP List page will appear as shown in Figure 3-17. Find the SSID of the Access Point you want to access, and click **Connect** in the corresponding row. For example, the first item is selected. The target network's SSID will be automatically filled into the corresponding box which is shown as the Figure 3-18.

AP List						
AP Count: 2						
ID	BSSID	SSID	Signal	Channel	Security	Choose
1	94-0C-6D-2F-3C-BE	Network1	30dB	4	WPA-PSK	<a href="#">Connect</a>
2	74-EA-3A-78-A2-36	TP-LINK_78A236	8dB	9	None	<a href="#">Connect</a>
<input type="button" value="Back"/> <input type="button" value="Refresh"/>						

Figure 3-17 AP List

### Quick Setup - Wireless

Start >> Working Mode >> WAN Connection Type >> **Wireless** >> Finish

#### Client Setting

SSID:   
 BSSID:  Example:00-1D-0F-11-22-33  
  
Key type is selected.  
 Key type:   
 WEP Index:   
 Auth type:   
 Password:

---

#### AP Setting

Local SSID:   
 Wireless Security Mode:   
 Wireless Password:   
You can enter ASCII or Hexadecimal characters. For Hexadecimal, the length should be between 8 and 64 characters; for ASCII, the length should be between 8 and 63 characters. For good security it should be of ample length and should not be a commonly known phrase.

Figure 3-18 Quick Setup – Wireless

**Note:**

If you know the SSID of the desired AP, you can also input it into the field "SSID" manually.

- **Local SSID-** Enter a value of up to 32 characters. The same Name (SSID) must be assigned to all wireless devices in your network.
- **Wireless Security Mode –** Select one of the three options: No Security, Secure(WEP), Most Secure(WPA/WPA2-PSK). WPA/WPA2-PSK is recommended.
- **Wireless Password-** Enter a unique and easy-to-remember password for your own wireless network.

3. After you have completed the above, click **Next**, the Finish page will appear as below. Please click the **Reboot/Finish** button to make your configuration take effect and finish the **Quick Setup**.

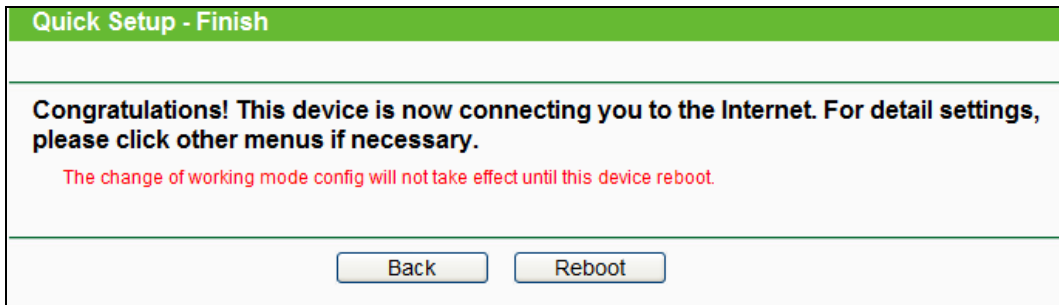

Figure 3-19 Finish

## Chapter 4. Configuring the Router

This chapter will show each Web page's key functions and the configuration way.

### 4.1 Login

After your successful login, you will see the sixteen main menus on the left of the Web-based utility. On the right, there are the corresponding explanations and instructions.

Status
Quick Setup
WPS
Working Mode
Network
Wireless
DHCP
Forwarding
Security
Parental Control
Access Control
Advanced Routing
Bandwidth Control
IP & MAC Binding
Dynamic DNS
System Tools

The detailed explanations for each Web page's key function are listed below.

### 4.2 Status

The Status page provides the current status information about the Router. All information is read-only.

Status		
Firmware Version:	3.13.26 Build 120723 Rel.64660n	
Hardware Version:	WR843ND v1 00000000	
<b>LAN</b>		
MAC Address:	00-0A-EB-08-43-67	
IP Address:	192.168.0.1	
Subnet Mask:	255.255.255.0	
<b>Wireless</b>		
Wireless Radio:	Enable	
Name (SSID):	TP-LINK_084367	
Channel:	9	
Mode:	11bgn mixed	
Channel Width:	Automatic	
MAC Address:	00-0A-EB-08-43-67	
Client Status:	Run	
<b>WAN</b>		
MAC Address:	00-0A-EB-08-43-68	
IP Address:	192.168.1.104	Dynamic IP
Subnet Mask:	255.255.255.0	
Default Gateway:	192.168.1.1	<input type="button" value="Release"/>
DNS Server:	192.168.1.1 , 0.0.0.0	
<b>Traffic Statistics</b>		
	Received	Sent
Bytes:	13,871,201	1,558,050
Packets:	48,172	13,501
System Up Time:	0 days 00:23:10	<input type="button" value="Refresh"/>

Figure 4-1 Router Status

### 4.3 Quick Setup

Please refer to [3.2 Quick Installation Guide](#).



## 4.4 WPS

This section will guide you to add a new wireless device to an existing network quickly by WPS (**Wi-Fi Protected Setup**) function.

- a). Choose menu “WPS”, and you will see the next screen (shown in Figure 4-2 ).

Figure 4-2 WPS

- **WPS Status** - Enable or disable the WPS function here.
- **Current PIN** - The current value of the Router's PIN is displayed here. The default PIN of the Router can be found in the label attached on the router.
- **Restore PIN** - Restore the PIN of the Router to its default.
- **Gen New PIN** - Click this button, and then you can get a new random value for the Router's PIN. You can ensure the network security by generating a new PIN.
- **Disable PIN of this device** - You can disable the Router's PIN manually here. If the router receives multiple failed attempts to authenticate an external registrar, this function will be disabled automatically.
- **Add Device** - You can add a new device to the existing network manually by clicking this button.

- b). To add a new device:

If the wireless adapter supports Wi-Fi Protected Setup (WPS), you can establish a wireless connection between wireless adapter and Router using either Push Button Configuration (PBC) method or PIN method.

 **Note:**

To build a successful connection by WPS, you should also do the corresponding configuration of the new device for WPS function meanwhile.

### I. Use the Wi-Fi Protected Setup Button

Use this method if your client device has a Wi-Fi Protected Setup button.

**Step 1:** Press the WPS/RESET button on the back panel of the Router for one second.

You can also keep the default WPS Status as **Enabled** and click the **Add Device** button in Figure 4-2, then Choose “**Press the button of the new device in two minutes**” and click **Connect**. (Shown in the following figure)

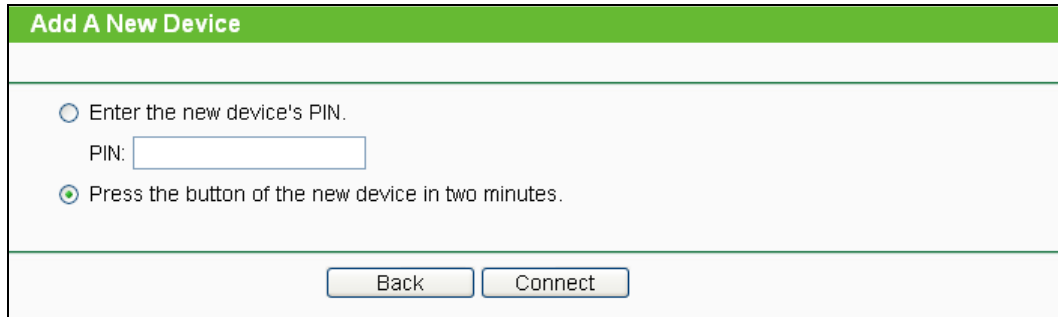

Figure 4-3 Add A New Device

**Step 2:** Press and hold the WPS button of the client device directly.

**Step 3:** The Wi-Fi Protected Setup LED flashes for two minutes during the Wi-Fi Protected Setup process.

**Step 4:** When the WPS LED is on, the client device has successfully connected to the Router.

**Step 5:** Refer back to your client device or its documentation for further instructions.

## II. Enter the client device’s PIN on the Router

Use this method if your client device has a Wi-Fi Protected Setup PIN number.

**Step 1:** Keep the default WPS Status as **Enabled** and click the **Add Device** button in Figure 4-2, then the following screen will appear.

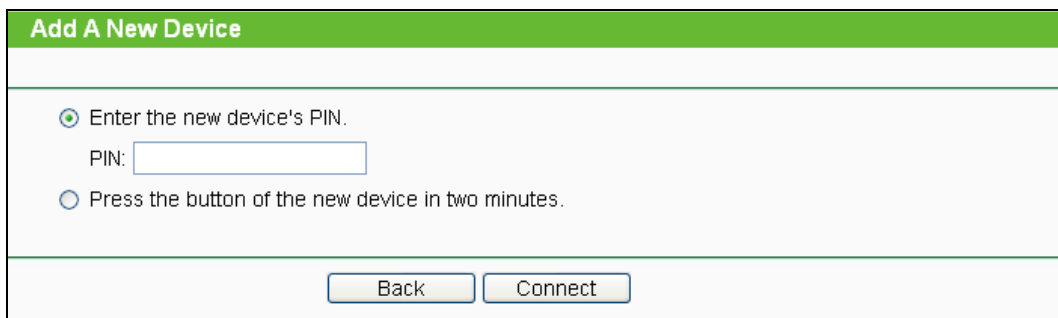

Figure 4-4 Add A New Device

**Step 2:** Enter the PIN number from the client device in the field on the above WPS screen. Then click **Connect** button.

**Step 3:** “**Connect successfully**” will appear on the screen of Figure 4-4, which means the client device has successfully connected to the Router.

## III. Enter the Router’s PIN on your client device

Use this method if your client device asks for the Router’s PIN number.

**Step 1:** On the client device, enter the PIN number listed on the Router’s Wi-Fi Protected Setup screen. (It is also labeled on the bottom of the Router.)

**Step 2:** The Wi-Fi Protected Setup LED flashes for two minutes during the Wi-Fi Protected Setup process.

**Step 3:** When the WPS LED is on, the client device has successfully connected to the Router.

**Step 4:** Refer back to your client device or its documentation for further instructions.

**Note:**

- 1) The WPS LED on the Router will light green for five minutes if the device has been successfully added to the network.
- 2) The WPS function cannot be configured if the Wireless Function of the Router is disabled. Please make sure the Wireless Function is enabled before configuring the WPS.

## 4.5 Working Mode

The Router supports two working modes: **Standard Wireless Router** and **WISP Client Router**. Please select one you want. Click **Save** to save your choice, which is shown as Figure 4-5.

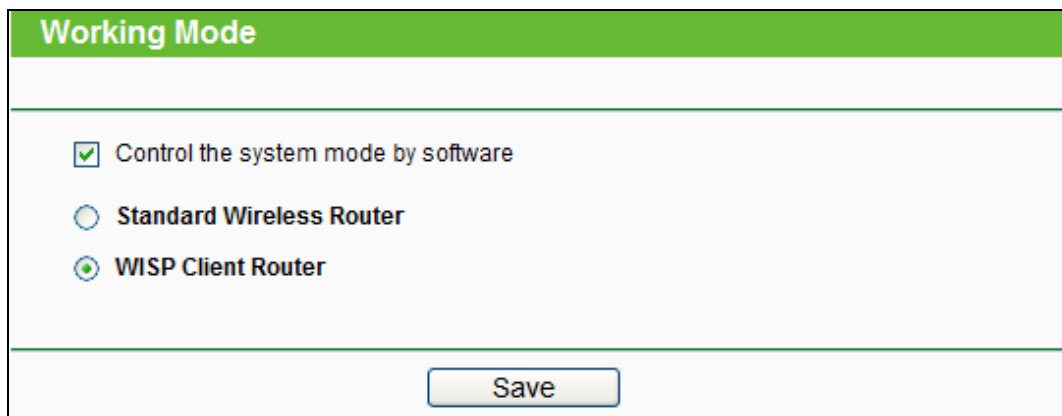

The screenshot shows a web interface for configuring the router's working mode. At the top, there is a green header with the text "Working Mode". Below this header, there is a checkbox labeled "Control the system mode by software" which is checked. Underneath this checkbox, there are two radio button options: "Standard Wireless Router" and "WISP Client Router". The "WISP Client Router" option is selected. At the bottom of the form, there is a "Save" button.

Figure 4-5 Working Mode

- **Control the system mode by software** – Tick this item, you will see the two options of working mode. You can also select it by turn the work mode switch at the back panel of your Router.
- **Standard Wireless Router** - In this mode, the device enables multi-users to share Internet via ADSL/Cable Modem. The wireless port share the same IP to ISP through Ethernet WAN port. The Wireless port acts the same as a LAN port while at Router mode.
- **WISP Client Router** - In this mode, the device enables multi-users to share Internet from WISP. The LAN port devices share the same IP from WISP through Wireless port. While connecting to WISP, the Wireless port works as a WAN port at Client Router mode. The Ethernet port acts as a LAN port.

## 4.6 Network

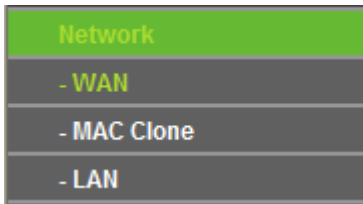

Figure 4-6 the Network menu

There are three submenus under the Network menu (shown in Figure 4-6): **WAN**, **MAC Clone** and **LAN**. Click any of them, and you will be able to configure the corresponding function.

### 4.6.1 WAN

Choose menu “**Network** → **WAN**”, you can configure the IP parameters of the WAN on the screen below.

1. If your ISP provides the DHCP service, please choose **Dynamic IP** type, and the Router will automatically get IP parameters from your ISP. You can see the page as follows (Figure 4-7):

The screenshot shows the WAN configuration interface. At the top is a green header with the word 'WAN'. Below it, the 'WAN Connection Type' is set to 'Dynamic IP' with a dropdown arrow and a 'Detect' button. The IP Address is 192.168.1.109, Subnet Mask is 255.255.255.0, and Default Gateway is 192.168.1.1. There are 'Renew' and 'Release' buttons. The MTU Size (in bytes) is 1500, with a note: '(The default is 1500, do not change unless necessary.)'. There is a checkbox for 'Use These DNS Servers' which is unchecked. The Primary DNS is 192.168.1.1 and the Secondary DNS is 0.0.0.0 (Optional). The Host Name is TL-WR843ND. At the bottom, there is a checkbox for 'Get IP with Unicast DHCP (It is usually not required.)' which is unchecked, and a 'Save' button.

Figure 4-7 WAN – Dynamic IP

This page displays the WAN IP parameters assigned dynamically by your ISP, including IP address, Subnet Mask, Default Gateway, etc. Click the **Renew** button to renew the IP parameters from your ISP. Click the **Release** button to release the IP parameters.

- **MTU Size** - The normal **MTU** (Maximum Transmission Unit) value for most Ethernet networks is 1500 Bytes. It is not recommended that you change the default **MTU Size** unless required by your ISP.
- **Use These DNS Servers** - If your ISP gives you one or two DNS addresses, select **Use These DNS Servers** and enter the primary and secondary addresses into the correct fields. Otherwise, the DNS servers will be assigned dynamically from your ISP.

 **Note:**

If you find error when you go to a website after entering the DNS addresses, it is likely that your DNS servers are set up improperly. You should contact your ISP to get DNS server addresses.

- **Host Name** - This option specifies the Host Name of the Router.
- **Get IP with Unicast DHCP** - A few ISPs' DHCP servers do not support the broadcast applications. If you cannot get the IP Address normally, you can choose this option. (It is rarely required.)

Click the **Save** button to save your settings.

2. If your ISP provides a static or fixed IP Address, Subnet Mask, Gateway and DNS setting, select **Static IP**. The Static IP settings page will appear, shown in Figure 4-8.

Figure 4-8 WAN - Static IP

- **IP Address** - Enter the IP address in dotted-decimal notation provided by your ISP.

- **Subnet Mask** - Enter the subnet Mask in dotted-decimal notation provided by your ISP, usually is 255.255.255.0.
- **Default Gateway** - (Optional) Enter the gateway IP address in dotted-decimal notation provided by your ISP.
- **MTU Size** - The normal **MTU** (Maximum Transmission Unit) value for most Ethernet networks is 1500 Bytes. It is not recommended that you change the default **MTU Size** unless required by your ISP.
- **Primary/Secondary DNS** - (Optional) Enter one or two DNS addresses in dotted-decimal notation provided by your ISP.

Click the **Save** button to save your settings.

3. If your ISP provides a PPPoE connection, select **PPPoE/Russia PPPoE** option. Then should enter the following parameters (Figure 4-9):

The screenshot shows the WAN configuration interface. At the top, there is a green header with the text 'WAN'. Below this, the 'WAN Connection Type' is set to 'PPPoE/Russia PPPoE' with a dropdown menu and a 'Detect' button. Under 'PPPoE Connection', there are three input fields: 'User Name' containing 'username', 'Password' with masked characters, and 'Confirm Password' also with masked characters. The 'Secondary Connection' section has three radio buttons: 'Disabled' (selected), 'Dynamic IP', and 'Static IP', with a note '(For Dual Access/Russia PPPoE)'. The 'Wan Connection Mode' section has four radio buttons: 'Connect on Demand' (selected), 'Connect Automatically', 'Time-based Connecting', and 'Connect Manually'. Under 'Connect on Demand', there is a 'Max Idle Time' field set to '15' minutes. Under 'Time-based Connecting', there is a 'Period of Time' field set from '0 : 0 (HH:MM) to 23 : 59 (HH:MM)'. Under 'Connect Manually', there is another 'Max Idle Time' field set to '15' minutes. At the bottom of the configuration area, there are three buttons: 'Connect', 'Disconnect', and 'Disconnected!'. At the very bottom of the page, there are two buttons: 'Save' and 'Advanced'.

Figure 4-9 WAN - PPPoE

- **User Name/Password** - Enter the User Name and Password provided by your ISP. These fields are case-sensitive.
- **Secondary Connection** - It's available only for PPPoE Connection. If your ISP provides an extra Connection type such as Dynamic/Static IP to connect to a local area network, then you can check the radio button of Dynamic/Static IP to activate this secondary connection.

- **Disabled** - The Secondary Connection is disabled by default, so there is PPPoE connection only. This is recommended.
  - **Dynamic IP** - You can check this radio button to use Dynamic IP as the secondary connection to connect to the local area network provided by ISP.
  - **Static IP** - You can check this radio button to use Static IP as the secondary connection to connect to the local area network provided by ISP.
- **Connect on Demand** - In this mode, the Internet connection can be terminated automatically after a specified inactivity period (**Max Idle Time**) and be re-established when you attempt to access the Internet again. If you want your Internet connection keeps active all the time, please enter "0" in the **Max Idle Time** field. Otherwise, enter the number of minutes you want to have elapsed before your Internet access disconnects.
- **Connect Automatically** - The connection can be re-established automatically when it was down.
- **Time-based Connecting** - The connection will only be established in the period from the start time to the end time (both are in HH:MM format).

 **Note:**

Only when you have configured the system time on "**System Tools** → **Time settings**" page, will the **Time-based Connecting** function take effect.

- **Connect Manually** - You can click the **Connect/Disconnect** button to connect/disconnect immediately. This mode also supports the **Max Idle Time** function as **Connect on Demand** mode. The Internet connection can be disconnected automatically after a specified inactivity period and re-established when you attempt to access the Internet again.

Click the **Connect** button to connect immediately. Click the **Disconnect** button to disconnect immediately.

**Caution:** Sometimes the connection cannot be terminated although you specify a time to Max Idle Time because some applications are visiting the Internet continually in the background.

If you want to do some advanced configurations, please click the **Advanced** button, and the page shown in Figure 4-10 will then appear:

Figure 4-10 PPPoE Advanced Settings

- **MTU Size** - The default MTU size is “1480” bytes, which is usually fine. It is not recommended that you change the default **MTU Size** unless required by your ISP.
- **Service Name/AC Name** - The service name and AC (Access Concentrator) name should not be configured unless you are sure it is necessary for your ISP. In most cases, leaving these fields blank will work.
- **ISP Specified IP Address** - If your ISP does not automatically assign IP addresses to the Router during login, please click “**Use IP address specified by ISP**” check box and enter the IP address provided by your ISP in dotted-decimal notation.
- **Detect Online Interval** - The Router will detect Access Concentrator online at every interval. The default value is “0”. You can input the value between “0” and “120”. The value “0” means no detect.
- **Primary DNS/Secondary DNS** - If your ISP does not automatically assign DNS addresses to the Router during login, please click “**Use the following DNS servers**” check box and enter the IP address in dotted-decimal notation of your ISP’s primary DNS server. If a secondary DNS server address is available, enter it as well.

Click the **Save** button to save your settings.

4. If your ISP provides BigPond Cable (or Heart Beat Signal) connection, please select **BigPond Cable**. And you should enter the following parameters (Figure 4-11):



Figure 4-11

- **User Name/Password** - Enter the User Name and Password provided by your ISP. These fields are case-sensitive.
- **Auth Server** - Enter the authenticating server IP address or host name.
- **Auth Domain** - Type in the domain suffix server name based on your location.  
e.g.  
NSW / ACT - **nsw.bigpond.net.au**  
VIC / TAS / WA / SA / NT - **vic.bigpond.net.au**  
QLD - **qld.bigpond.net.au**
- **MTU Size** - The normal **MTU** (Maximum Transmission Unit) value for most Ethernet networks is 1500 Bytes. It is not recommended that you change the default **MTU Size** unless required by your ISP.
- **Connect on Demand** - In this mode, the Internet connection can be terminated automatically after a specified inactivity period (**Max Idle Time**) and be re-established when you attempt to access the Internet again. If you want your Internet connection keeps active all the time, please enter “0” in the **Max Idle Time** field. Otherwise, enter the number of minutes you want to have elapsed before your Internet access disconnects.
- **Connect Automatically** - The connection can be re-established automatically when it was down.

- **Connect Manually** - You can click the **Connect/Disconnect** button to connect/disconnect immediately. This mode also supports the **Max Idle Time** function as **Connect on Demand** mode. The Internet connection can be disconnected automatically after a specified inactivity period and re-established when you attempt to access the Internet again.

Click the **Connect** button to connect immediately. Click the **Disconnect** button to disconnect immediately.

**Caution:** Sometimes the connection cannot be terminated although you specify a time to Max Idle Time because some applications are visiting the Internet continually in the background.

Click the **Save** button to save your settings.

5. If your ISP provides L2TP connection, please select **L2TP/Russia L2TP** option. And you should enter the following parameters (Figure 4-12):

The screenshot shows the WAN configuration interface for L2TP/Russia L2TP. The 'WAN Connection Type' is set to 'L2TP/Russia L2TP'. The 'User Name' field contains 'username' and the 'Password' field is masked with dots. Below the password field are 'Connect' and 'Disconnect' buttons, with a 'Disconnected!' status indicator. The 'Server IP Address/Name' field is empty. Below it are fields for 'IP Address', 'Subnet Mask', 'Gateway', and 'DNS', all set to '0.0.0.0'. The 'Internet IP Address' and 'Internet DNS' fields are also set to '0.0.0.0'. The 'MTU Size (in bytes)' is set to '1460' with a note: '(The default is 1460, do not change unless necessary.)'. The 'Max Idle Time' is set to '15' minutes with a note: '(0 means remain active at all times.)'. The 'Connection Mode' has three radio buttons: 'Connect on Demand' (selected), 'Connect Automatically', and 'Connect Manually'. A 'Save' button is at the bottom.

Figure 4-12

- **User Name/Password** - Enter the User Name and Password provided by your ISP. These fields are case-sensitive.

- **Dynamic IP/ Static IP** - Choose either as you are given by your ISP. Click the **Connect** button to connect immediately. Click the **Disconnect** button to disconnect immediately.
- **Server IP Address/Name** - Enter the Server IP Address/Name provided by your ISP. It can be IP address or Domain Name.
- **Connect on Demand** - You can configure the Router to disconnect from your Internet connection after a specified period of inactivity (**Max Idle Time**). If your Internet connection has been terminated due to inactivity, **Connect on Demand** enables the Router to automatically re-establish your connection as soon as you attempt to access the Internet again. If you wish to activate **Connect on Demand**, check the radio button. If you want your Internet connection to remain active at all times, enter 0 in the **Max Idle Time** field. Otherwise, enter the number of minutes you want to have elapsed before your Internet connection terminates.
- **Connect Automatically** - Connect automatically after the Router is disconnected. To use this option, check the radio button.
- **Connect Manually** - You can configure the Router to make it connect or disconnect manually. After a specified period of inactivity (**Max Idle Time**), the Router will disconnect from your Internet connection, and you will not be able to re-establish your connection automatically as soon as you attempt to access the Internet again. To use this option, check the radio button. If you want your Internet connection to remain active at all times, enter "0" in the **Max Idle Time** field. Otherwise, enter the number of minutes that you wish to have the Internet connecting last unless a new link is requested.

**Caution:** Sometimes the connection cannot be disconnected although you specify a time to **Max Idle Time**, because some applications are visiting the Internet continually in the background.

Click the **Save** button to save your settings.

6. If your ISP provides PPTP connection, please select **PPTP/Russia PPTP** option. And you should enter the following parameters (Figure 4-13):

Figure 4-13 PPTP Settings

- **User Name/Password** - Enter the User Name and Password provided by your ISP. These fields are case-sensitive.
- **Dynamic IP/ Static IP** - Choose either as you are given by your ISP and enter the ISP's IP address or the domain name.

If you choose static IP and enter the domain name, you should also enter the DNS assigned by your ISP. And click the **Save** button.

Click the **Connect** button to connect immediately. Click the **Disconnect** button to disconnect immediately.

- **Connect on Demand** - You can configure the Router to disconnect from your Internet connection after a specified period of inactivity (**Max Idle Time**). If your Internet connection has been terminated due to inactivity, **Connect on Demand** enables the Router to automatically re-establish your connection as soon as you attempt to access the Internet again. If you wish to activate **Connect on Demand**, check the radio button. If you want your Internet connection to remain active at all times, enter "0" in the **Max Idle Time** field.

Otherwise, enter the number of minutes you want to have elapsed before your Internet connection terminates.

- **Connect Automatically** - Connect automatically after the Router is disconnected. To use this option, check the radio button.
- **Connect Manually** - You can configure the Router to make it connect or disconnect manually. After a specified period of inactivity (**Max Idle Time**), the Router will disconnect from your Internet connection, and you will not be able to re-establish your connection automatically as soon as you attempt to access the Internet again. To use this option, click the radio button. If you want your Internet connection to remain active at all times, enter "0" in the **Max Idle Time** field. Otherwise, enter the number in minutes that you wish to have the Internet connecting last unless a new link is requested.

**Caution:** Sometimes the connection cannot be disconnected although you specify a time to **Max Idle Time** because some applications are visiting the Internet continually in the background.

Click the **Save** button to save your settings.

 **Note:**

If you don't know how to choose the appropriate connection type, click the **Detect** button to allow the Router to automatically search your Internet connection for servers and protocols. The connection type will be reported when an active Internet service is successfully detected by the Router. This report is for your reference only. To make sure the connection type your ISP provides, please refer to the ISP. The various types of Internet connections that the Router can detect are as follows:

- **PPPoE** - Connections which use PPPoE that requires a user name and password.
- **Dynamic IP** - Connections which use dynamic IP address assignment.
- **Static IP** - Connections which use static IP address assignment.

The Router can not detect PPTP/L2TP/BigPond connections with your ISP. If your ISP uses one of these protocols, then you must configure your connection manually.

#### 4.6.2 MAC Clone

Choose menu "**Network** → **MAC Clone**", you can configure the MAC address of the WAN on the screen below, Figure 4-14:

Figure 4-14 MAC Address Clone

Some ISPs require that you register the MAC Address of your adapter. Changes are rarely needed here.

- **WAN MAC Address** - This field displays the current MAC address of the WAN port. If your ISP requires you to register the MAC address, please enter the correct MAC address into this field in XX-XX-XX-XX-XX-XX format (X is any hexadecimal digit).
- **Your PC's MAC Address** - This field displays the MAC address of the PC that is managing the Router. If the MAC address is required, you can click the **Clone MAC Address To** button and this MAC address will fill in the **WAN MAC Address** field.

Click **Restore Factory MAC** to restore the MAC address of WAN port to the factory default value.

Click the **Save** button to save your settings.

**Note:**

Only the PC on your LAN can use the MAC Address Clone function.

### 4.6.3 LAN

Choose menu “**Network** → **LAN**”, you can configure the IP parameters of the LAN on the screen as below.

Figure 4-15 LAN

- **MAC Address** - The physical address of the Router, as seen from the LAN. The value can't be changed.
- **IP Address** - Enter the IP address of your Router or reset it in dotted-decimal notation (factory default: 192.168.0.1).

- **Subnet Mask** - An address code that determines the size of the network. Normally use 255.255.255.0 as the subnet mask.

 **Note:**

- 1) If you change the IP Address of LAN, you must use the new IP Address to log in the Router.
- 2) If the new LAN IP Address you set is not in the same subnet, the IP Address pool of the DHCP server will change accordingly at the same time, while the Virtual Server and DMZ Host will not take effect until they are re-configured.

## 4.7 Wireless



Figure 4-16 Wireless menu

There are five submenus under the Wireless menu (shown in Figure 4-16): **Wireless Settings**, **Wireless Security**, **Wireless MAC Filtering**, **Wireless Advanced** and **Wireless Statistics**. Click any of them, and you will be able to configure the corresponding function.

### 4.7.1 Wireless Settings

Choose menu "**Wireless** → **Wireless Settings**", you can configure the basic settings for the wireless network on this page.

#### 4.7.1.1. Wireless Settings on Router Mode

If you select **Standard Wireless Router** mode in Figure 4-5, the Wireless Settings page will display as Figure 4-17.

Figure 4-17 Wireless Settings

- **Wireless Network Name (also called the SSID)** - Enter a value of up to 32 characters. The same name of SSID (Service Set Identification) must be assigned to all wireless devices in your network. Considering your wireless network security, the default SSID is set to be TP-LINK\_XXXXXXX (XXXXXX indicates the last unique six numbers of each Router’s MAC address). This value is case-sensitive. For example, *TEST* is NOT the same as *test*.
- **Region** - Select your region from the pull-down list. This field specifies the region where the wireless function of the Router can be used. It may be illegal to use the wireless function of the Router in a region other than one of those specified in this field. If your country or region is not listed, please contact your local government agency for assistance.

When you select your local region from the pull-down list, click the **Save** button, then the Note Dialog appears. Click **OK**.

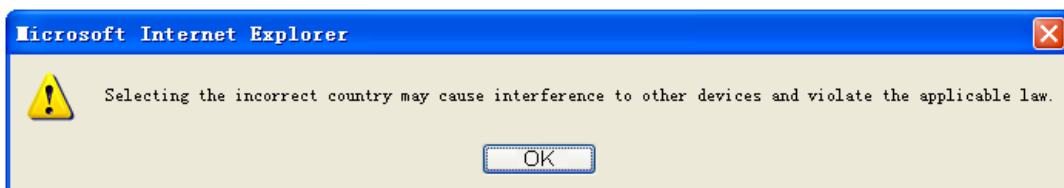

Note Dialog

**Note:**

Limited by local law regulations, version for North America does not have region selection option.



- **Mode** - Select the desired mode. The default setting is 11bgn mixed.

**11b only** - Select if all of your wireless clients are 802.11b.

**11g only** - Select if all of your wireless clients are 802.11g.

**11n only** - Select if all of your wireless clients are 802.11n.

**11bg mixed** - Select if you are using both 802.11b and 802.11g wireless clients.

**11bgn mixed** - Select if you are using a mix of 802.11b, 11g, and 11n wireless clients.

Select the desired wireless mode. When 802.11g mode is selected, only 802.11g wireless stations can connect to the Router. When 802.11b mode is selected, only 802.11b wireless stations can connect to the Router. When 802.11n mode is selected, only 802.11n wireless stations can connect to the Router. It is strongly recommended that you set the Mode to **802.11b&g&n**, and all of 802.11b, 802.11g, and 802.11n wireless stations can connect to the Router.

- **Channel width** - Select the channel width from the pull-down list. The default setting is Auto, which can automatically adjust the channel width for your clients.

 **Note:**

If **11b only**, **11g only**, or **11bg mixed** is selected in the **Mode** field, the **Channel Width** selecting field will turn grey and the value will become 20MHz, which is unable to be changed.

- **Channel** - This field determines which operating frequency will be used. The default channel is set to 6. It is not necessary to change the wireless channel unless you notice interference problems with another nearby access point.
- **Max Tx Rate** - You can limit the maximum tx rate of the Router through this field.
- **Enable Wireless Router Radio** - The wireless radio of the Router can be enabled or disabled to allow wireless stations access. If enabled, the wireless stations will be able to access the Router. Otherwise, wireless stations will not be able to access the Router.
- **Enable SSID Broadcast** - If you select the Enable SSID Broadcast checkbox, the wireless router will broadcast its name (SSID) on the air.
- **Enable WDS Bridging** - You can select this to enable WDS Bridging, with this function, the Router can bridge two or more WLANs. NOTE: If this checkbox is selected, you had better make sure the following settings are correct.

- **SSID (to be bridged)** - The SSID of the AP your Router is going to connect to as a client. You can also use the survey function to select the SSID to join.
- **BSSID (to be bridged)** - The BSSID of the AP your Router is going to connect to as a client. You can also use the survey function to select the BSSID to join.
- **Survey** - Click this button, you can survey the AP which runs nearby.
- **Key type** - This option should be chosen according to the AP's security configuration. It is recommended that the security type is the same as your AP's security type.
- **WEP Index** - This option should be chosen if the key type is WEP (ASCII) or WEP (HEX). It indicates the index of the WEP key.
- **Auth Type** - This option should be chosen if the key type is WEP (ASCII) or WEP (HEX). It indicates the authorization type of the Root AP.
- **Password** - If the AP your Router is going to connect needs password, you need to fill the password in this blank.

Be sure to click the **Save** button to save your settings on this page.

**Note:**

- 1) The operating distance or range of your wireless connection varies significantly based on the physical placement of the Router. For best results, place your Router.
  - Near the center of the area in which your wireless stations will operate.
  - In an elevated location such as a high shelf.
  - Away from the potential sources of interference, such as PCs, microwaves, and cordless phones.
  - With the Antenna in the upright position.
  - Away from large metal surfaces.

- 2) Failure to follow these guidelines can result in significant performance degradation or inability to wirelessly connect to the Router.

#### 4.7.1.2. Wireless Settings on WISP Client Router Mode

If you select **WISP Client Router** mode in Figure 4-5, the Wireless Settings page will display as Figure 4-18.

Figure 4-18 Wireless Settings

- **SSID** - The SSID of the AP your Router is going to connect to as a client. You can also use the search function to select the SSID to join.
- **BSSID** - The BSSID of the AP your Router is going to connect to as a client. You can also use the search function to select the BSSID to join.
- **Survey** - Click this button, you can search the AP which runs nearby.
- **Key type** - This option should be chosen according to the AP's security configuration. It is recommended that the security type is the same as your AP's security type.

- **WEP Index** - This option should be chosen if the key type is WEP (ASCII) or WEP (HEX). It indicates the index of the WEP key.
- **Auth type** - This option should be chosen if the key type is WEP (ASCII) or WEP (HEX).It indicates the authorization type of the Root AP.
- **Password** - If the AP your Router is going to connect needs password, you need to fill the password in this blank.
- **Local SSID** - Enter a value of up to 32 characters. The same Name (SSID) must be assigned to all wireless devices in your network.
- **Enable Wireless Router Radio** - The wireless radio of the Router can be enabled or disabled to allow wireless stations access. If enabled, the wireless stations will be able to access the Router. Otherwise, wireless stations will not be able to access the Router and you cannot access to the WISP.
- **Enable SSID Broadcast** - If you select the **Enable SSID Broadcast** checkbox, the wireless router will broadcast its name (SSID) on the air.
- **Disable Local Wireless Access** - If you select the **Disable Local Wireless Access** checkbox, the wireless router will disable local wireless access; other stations will not be able to access the Router by wireless.

Click **Survey** button on the Wireless page shown as Figure 4-18, and then AP List page will appear, as shown in Figure 4-19. Find the SSID of the Access Point you want to access, and click **Connect** in the corresponding row. For example, the desired item is selected. The target network's SSID will be automatically filled into the corresponding box which is shown as the Figure 4-20.

AP List						
AP Count: 2						
ID	BSSID	SSID	Signal	Channel	Security	Choose
1	94-0C-6D-2F-3C-BE	Network1	30dB	4	WPA-PSK	<a href="#">Connect</a>
2	74-EA-3A-78-A2-36	TP-LINK_78A236	8dB	9	None	<a href="#">Connect</a>
<input type="button" value="Back"/> <input type="button" value="Refresh"/>						

Figure 4-19 AP List

Wireless Settings

### Client Setting

SSID:

BSSID:  Example:00-1D-0F-11-22-33

Key type:  ▼

WEP Index:  ▼

Auth type:  ▼

Password:

### AP Setting

Local SSID:

Enable Wireless Router Radio

Enable SSID Broadcast

Disable Local Wireless Access

Figure 4-20

 **Note:**

If you know the SSID of the desired AP, you can also input it into the field "Wireless Name of WISP Station" manually.

Be sure to click the **Save** button to save your settings on this page.

 **Note:**

- 1) The operating distance or range of your wireless connection varies significantly based on the physical placement of the Router. For best results, place your Router.
  - Near the center of the area in which your wireless stations will operate.
  - In an elevated location such as a high shelf.
  - Away from the potential sources of interference, such as PCs, microwaves, and cordless phones.
  - With the Antenna in the upright position.
  - Away from large metal surfaces.

- 2) Failure to follow these guidelines can result in significant performance degradation or inability to wirelessly connect to the Router.

### 4.7.2 Wireless Security

Choose menu “**Wireless** → **Wireless Security**”, you can configure the security settings of your wireless network.

There are five wireless security modes supported by the Router: WEP (Wired Equivalent Privacy), WPA (Wi-Fi Protected Access), WPA2 (Wi-Fi Protected Access 2), WPA-PSK (Pre-Shared Key), WPA2-PSK (Pre-Shared Key).

Figure 4-21 Wireless Security

- **Disable Security** - If you do not want to use wireless security, check this radio button. But it's strongly recommended to choose one of the following modes to enable security.
- **WPA-PSK/WPA2-PSK – Personal (Recommended)** - It's the WPA/WPA2 authentication type based on pre-shared passphrase.
  - **Version** - you can choose the version of the WPA-PSK security on the drop-down list. The

default setting is **Automatic**, which can select **WPA-PSK** (Pre-shared key of WPA) or **WPA2-PSK** (Pre-shared key of WPA) automatically based on the wireless station's capability and request.

- **Encryption** - When **WPA-PSK** or **WPA** is set as the Authentication Type, you can select either **Automatic**, or **TKIP** or **AES** as Encryption.

**Note:**

If you check the **WPA-PSK/WPA2-PSK – Personal (Recommended)** radio button and choose TKIP encryption, you will find a notice in red as shown in Figure 4-22.

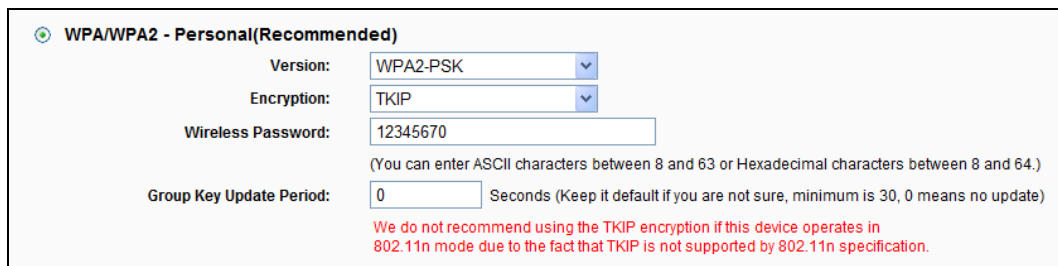

Figure 4-22

- **PSK Password** - You can enter ASCII characters between 8 and 63 characters or 8 to 64 Hexadecimal characters.
- **Group Key Update Period** - Specify the group key update interval in seconds. The value should be 30 or above. Enter 0 to disable the update.

➤ **WPA /WPA2 – Enterprise** - It's based on Radius Server.

- **Version** - you can choose the version of the WPA security on the drop-down list. The default setting is **Automatic**, which can select **WPA** (Wi-Fi Protected Access) or **WPA2** (WPA version 2) automatically based on the wireless station's capability and request.
- **Encryption** - You can select either **Automatic**, or **TKIP** or **AES**.

**Note:**

If you check the **WPA /WPA2 – Enterprise** radio button and choose TKIP encryption, you will find a notice in red as shown in Figure 4-23.

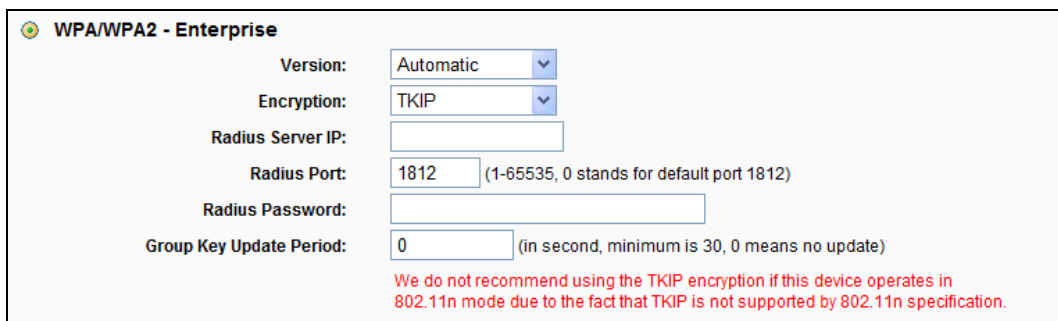

Figure 4-23

- **Radius Server IP** - Enter the IP address of the Radius server.

- **Radius Port** - Enter the port number of the Radius server.
  - **Radius Password** - Enter the password for the Radius server.
  - **Group Key Update Period** - Specify the group key update interval in seconds. The value should be 30 or above. Enter 0 to disable the update.
- **WEP** - It is based on the IEEE 802.11 standard. If you check this radio button, you will find a notice in red as show in Figure 4-24.

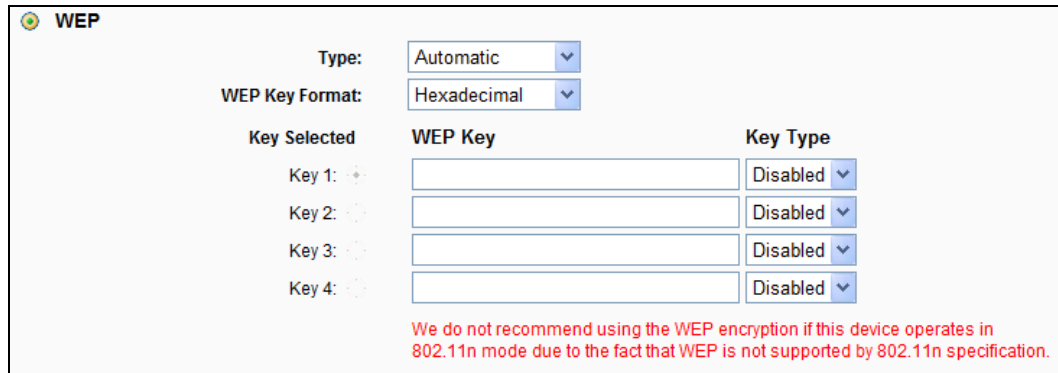

Figure 4-24

- **Type** - you can choose the type for the WEP security on the drop-down list. The default setting is **Automatic**, which can select **Shared Key** or **Open System** authentication type automatically based on the wireless station's capability and request.
- **WEP Key Format** - **Hexadecimal** and **ASCII** formats are provided here. **Hexadecimal** format stands for any combination of hexadecimal digits (0-9, a-f, A-F) in the specified length. **ASCII** format stands for any combination of keyboard characters in the specified length.
- **WEP Key** - Select which of the four keys will be used and enter the matching WEP key that you create. Make sure these values are identical on all wireless stations in your network.
- **Key Type** - You can select the WEP key length (64-bit, or 128-bit, or 152-bit.) for encryption. "Disabled" means this WEP key entry is invalid.

**64-bit** - You can enter 10 hexadecimal digits (any combination of 0-9, a-f, A-F, zero key is not promoted) or 5 ASCII characters.

**128-bit** - You can enter 26 hexadecimal digits (any combination of 0-9, a-f, A-F, zero key is not promoted) or 13 ASCII characters.

**152-bit** - You can enter 32 hexadecimal digits (any combination of 0-9, a-f, A-F, zero key is not promoted) or 16 ASCII characters.

**Note:**

If you do not set the key, the wireless security function is still disabled even if you have selected Shared Key as Authentication Type.

Be sure to click the **Save** button to save your settings on this page.



### 4.7.3 Wireless MAC Filtering

Choose menu “**Wireless** → **MAC Filtering**”, you can control the wireless access by configuring the **Wireless MAC Filtering** function, shown in Figure 4-25.

Figure 4-25 Wireless MAC Filtering

To filter wireless users by MAC Address, click **Enable**. The default setting is **Disabled**.

- **MAC Address** - The wireless station's MAC address that you want to filter.
- **Status** - The status of this entry, either **Enabled** or **Disabled**.
- **Description** - A simple description of the wireless station.

To Add a Wireless MAC Address filtering entry, click the **Add New...** button. The "**Add or Modify Wireless MAC Address Filtering entry**" page will appear, shown in Figure 4-26:

Figure 4-26 Add or Modify Wireless MAC Address Filtering entry

**To add or modify a MAC Address Filtering entry, follow these instructions:**

1. Enter the appropriate MAC Address into the **MAC Address** field. The format of the MAC Address is XX-XX-XX-XX-XX-XX (X is any hexadecimal digit). For example: 00-0A-EB-B0-00-0B.
2. Give a simple description for the wireless station in the **Description** field. For example: Wireless station A.
3. Select **Enabled** or **Disabled** for this entry on the **Status** drop-down list.
4. Click the **Save** button to save this entry.

**To modify or delete an existing entry:**

1. Click the **Modify** in the entry you want to modify. If you want to delete the entry, click the **Delete**.
2. Modify the information.
3. Click the **Save** button.

Click the **Enable All** button to make all entries enabled

Click the **Disable All** button to make all entries disabled.

Click the **Delete All** button to delete all entries.

Click the **Next** button to go to the next page.

Click the **Previous** button to return to the previous page.

**For example:** If you desire that the wireless station A with MAC address 00-0A-EB-B0-00-0B and the wireless station B with MAC address 00-0A-EB-00-07-5F are able to access the Router, but all the other wireless stations cannot access the Router, you can configure the **Wireless MAC Address Filtering** list by following these steps:

1. Click the **Enable** button to enable this function.
2. Select the radio button “Allow the stations specified by any enabled entries in the list to access” for **Filtering Rules**.
3. Delete all or disable all entries if there are any entries already.
4. Click the **Add New...** button.
  - 1) Enter the MAC address 00-0A-EB-B0-00-0B/00-0A-EB-00-07-5F in the **MAC Address** field.
  - 2) Enter wireless station A/B in the **Description** field.
  - 3) Select **Enabled** in the **Status** drop-down list.
  - 4) Click the **Save** button.
  - 5) Click the **Back** button.

The filtering rules that configured should be similar to the following list:

Filtering Rules				
<input type="radio"/> Deny the stations specified by any enabled entries in the list to access.				
<input checked="" type="radio"/> Allow the stations specified by any enabled entries in the list to access.				
ID	MAC Address	Status	Description	Modify
1	00-0A-EB-B0-00-0B	Enabled	wireless station A	<a href="#">Modify</a> <a href="#">Delete</a>
2	00-0A-EB-00-07-5F	Enabled	wireless station B	<a href="#">Modify</a> <a href="#">Delete</a>

#### 4.7.4 Wireless Advanced

Choose menu “**Wireless** → **Wireless Advanced**”, you can configure the advanced settings of your wireless network.

<b>Wireless Advanced</b>	
Transmit Power:	High
Beacon Interval:	100 (40-1000)
RTS Threshold:	2346 (256-2346)
Fragmentation Threshold:	2346 (256-2346)
DTIM Interval:	1 (1-255)
	<input checked="" type="checkbox"/> Enable WMM
	<input checked="" type="checkbox"/> Enable Short GI
	<input type="checkbox"/> Enable AP Isolation
<input type="button" value="Save"/>	

Figure 4-27 Wireless Advanced

- **Transmit Power** - Here you can specify the transmit power of Router. You can select High, Middle or Low which you would like. High is the default setting and is recommended.
- **Beacon Interval** - Enter a value between 40-1000 milliseconds for Beacon Interval here. The beacons are the packets sent by the Router to synchronize a wireless network. Beacon Interval value determines the time interval of the beacons. The default value is 100.
- **RTS Threshold** - Here you can specify the RTS (Request to Send) Threshold. If the packet is larger than the specified RTS Threshold size, the Router will send RTS frames to a particular receiving station and negotiate the sending of a data frame. The default value is 2346.
- **Fragmentation Threshold** - This value is the maximum size determining whether packets will be fragmented. Setting the Fragmentation Threshold too low may result in poor network performance because of excessive packets. 2346 is the default setting and is recommended.
- **DTIM Interval** - This value determines the interval of the Delivery Traffic Indication Message (DTIM). A DTIM field is a countdown field informing clients of the next window for listening to broadcast and multicast messages. When the Router has buffered broadcast or multicast messages for associated clients, it sends the next DTIM with a DTIM Interval value. You can specify the value between 1-255 Beacon Intervals. The default value is 1, which indicates the DTIM Interval is the same as Beacon Interval.
- **Enable WMM** - WMM function can guarantee the packets with high-priority messages being transmitted preferentially. It is strongly recommended.
- **Enable Short GI** - This function is recommended for it will increase the data capacity by reducing the guard interval time.

- **Enabled AP Isolation** - This function can isolate wireless stations on your network from each other. Wireless devices will be able to communicate with the Router but not with each other. To use this function, check this box. AP Isolation is disabled by default.

**Note:**

If you are not familiar with the setting items in this page, it's strongly recommended to keep the provided default values; otherwise it may result in lower wireless network performance.

### 4.7.5 Wireless Statistics

Choose menu “**Wireless** → **Wireless Statistics**”, you can see the MAC Address, Current Status, Received Packets and Sent Packets for each connected wireless station.

Wireless Statistics					
Current Connected Wireless Stations numbers:		1	<input type="button" value="Refresh"/>		
ID	MAC Address	Current Status	Received Packets	Sent Packets	Configure
1	A8-26-D9-EE-3F-84	WPA2-PSK	638	557	<input type="button" value="Deny"/>
		<input type="button" value="Previous"/>	<input type="button" value="Next"/>		

Figure 4-28 Wireless Statistics

- **MAC Address** - The connected wireless station's MAC address.
- **Current Status** - The connected wireless station's running status, one of **STA-AUTH/ STA-ASSOC/ STA-JOINED/ WPA/ WPA-PSK/ WPA2/ WPA2-PSK/ AP-UP/ AP-DOWN/ Disconnected**.
- **Received Packets** - Packets received by the station.
- **Sent Packets** - Packets sent by the station.
- **Configure** - The button is used for loading the item to the Wireless MAC Filtering list.
  - **Deny** - if the Wireless MAC Filtering function enable, deny the station to access.
  - **Allow** - if the Wireless MAC Filtering function enable, allow the station to access.

You cannot change any of the values on this page. To update this page and to show the current connected wireless stations, click on the **Refresh** button.

If the numbers of connected wireless stations go beyond one page, click the **Next** button to go to the next page and click the **Previous** button to return the previous page.

**Note:**

This page will be refreshed automatically every 5 seconds.

## 4.8 DHCP

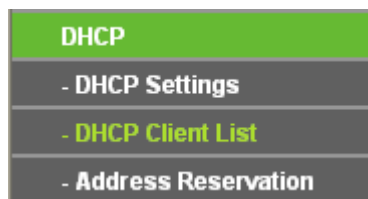

Figure 4-29 The DHCP menu

There are three submenus under the DHCP menu (shown in Figure 4-29): **DHCP Settings**, **DHCP Client List** and **Address Reservation**. Click any of them, and you will be able to configure the corresponding function.

### 4.8.1 DHCP Settings

Choose menu "**DHCP** → **DHCP Settings**", you can configure the DHCP Server on the page as shown in Figure 4-30. The Router is set up by default as a DHCP (Dynamic Host Configuration Protocol) server, which provides the TCP/IP configuration for all the PC(s) that are connected to the Router on the LAN.

 A screenshot of a web configuration page titled "DHCP Settings". The page has a green header bar. Below the header, there are several configuration options:
 

- DHCP Server:** Radio buttons for "Disable" and "Enable". "Enable" is selected.
- Start IP Address:** Text input field containing "192.168.0.100".
- End IP Address:** Text input field containing "192.168.0.199".
- Address Lease Time:** Text input field containing "120" followed by "minutes (1~2880 minutes, the default value is 120)".
- Default Gateway:** Text input field containing "192.168.0.1" with "(Optional)" to its right.
- Default Domain:** Text input field with "(Optional)" to its right.
- Primary DNS:** Text input field containing "0.0.0.0" with "(Optional)" to its right.
- Secondary DNS:** Text input field containing "0.0.0.0" with "(Optional)" to its right.

 At the bottom of the form is a "Save" button.

Figure 4-30 DHCP Settings

- **DHCP Server - Enable or Disable** the DHCP server. If you disable the Server, you must have another DHCP server within your network or else you must configure the computer manually.
- **Start IP Address** - Specify an IP address for the DHCP Server to start with when assigning IP addresses. 192.168.0.100 is the default start address.
- **End IP Address** - Specify an IP address for the DHCP Server to end with when assigning IP addresses. 192.168.0.199 is the default end address.
- **Address Lease Time** - The **Address Lease Time** is the amount of time a network user will be allowed connection to the Router with their current dynamic IP Address. Enter the amount of time in minutes and the user will be "leased" this dynamic IP Address. After the

time is up, the user will be automatically assigned a new dynamic IP address. The range of the time is 1 ~ 2880 minutes. The default value is 120 minutes.

- **Default Gateway** - (Optional.) It is suggested to input the IP address of the LAN port of the Router. The default value is 192.168.0.1.
- **Default Domain** - (Optional.) Input the domain name of your network.
- **Primary DNS** - (Optional.) Input the DNS IP address provided by your ISP or consult your ISP.
- **Secondary DNS** - (Optional.) Input the IP address of another DNS server if your ISP provides two DNS servers.

 **Note:**

To use the DHCP server function of the Router, you must configure all computers on the LAN as "Obtain an IP Address automatically".

### 4.8.2 DHCP Client List

Choose menu "DHCP → DHCP Client List", you can view the information about the clients attached to the Router in the screen as shown in Figure 4-31.

DHCP Client List				
ID	Client Name	MAC Address	Assigned IP	Lease Time
1	viola	40-61-86-CF-20-7A	192.168.0.100	01:29:35

Figure 4-31 DHCP Clients List

- **Client Name** - The name of the DHCP client
- **MAC Address** - The MAC address of the DHCP client
- **Assigned IP** - The IP address that the Router has allocated to the DHCP client
- **Lease Time** - The time of the DHCP client leased. After the dynamic IP address has expired, a new dynamic IP address will be automatically assigned to the user.

You cannot change any of the values on this page. To update this page and to show the current attached devices, click the **Refresh** button.

### 4.8.3 Address Reservation

Choose menu "DHCP → Address Reservation", you can view and add a reserved address for clients via the next screen (shown in Figure 4-32).When you specify a reserved IP address for a PC on the LAN, that PC will always receive the same IP address each time when it accesses the DHCP server. Reserved IP addresses should be assigned to the servers that require permanent IP settings.

ID	MAC Address	Reserved IP Address	Status	Modify
<input type="button" value="Add New..."/> <input type="button" value="Enable All"/> <input type="button" value="Disable All"/> <input type="button" value="Delete All"/>				
<input type="button" value="Previous"/> <input type="button" value="Next"/>				

Figure 4-32 Address Reservation

- **MAC Address** - The MAC address of the PC for which you want to reserve an IP address.
- **Reserved IP Address** - The IP address reserved for the PC by the Router.
- **Status** - The status of this entry, either **Enabled** or **Disabled**.

**To Reserve an IP address:**

1. Click the **Add New...** button. Then Figure 4-33 will pop up.
2. Enter the MAC address (in XX-XX-XX-XX-XX-XX format.) and IP address (in dotted-decimal notation) of the computer for which you want to reserve an IP address.
3. Click the **Save** button.

**Add or Modify an Address Reservation Entry**

MAC Address:

Reserved IP Address:

Status:

Figure 4-33 Add or Modify an Address Reservation Entry

**To modify or delete an existing entry:**

1. Click the **Modify** in the entry you want to modify. If you want to delete the entry, click the **Delete**.
2. Modify the information.
3. Click the **Save** button.

Click the **Enable/Disable All** button to make all entries enabled/disabled

Click the **Delete All** button to delete all entries.

Click the **Next** button to go to the next page and Click the **Previous** button to return the previous page.

## 4.9 Forwarding

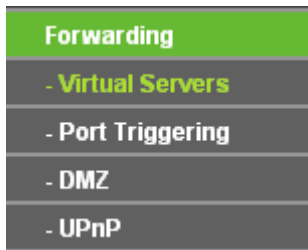

Figure 4-34 The Forwarding menu

There are four submenus under the Forwarding menu (shown in Figure 4-34): **Virtual Servers**, **Port Triggering**, **DMZ** and **UPnP**. Click any of them, and you will be able to configure the corresponding function.

### 4.9.1 Virtual Servers

Choose menu “**Forwarding** → **Virtual Servers**”, you can view and add virtual servers in the screen as shown in Figure 4-35. Virtual servers can be used for setting up public services on your LAN, such as DNS, Email and FTP. A virtual server is defined as a service port, and all requests from the Internet to this service port will be redirected to the computer specified by the server IP. Any PC that was used for a virtual server must have a static or reserved IP Address because its IP Address may be changed when using the DHCP function.

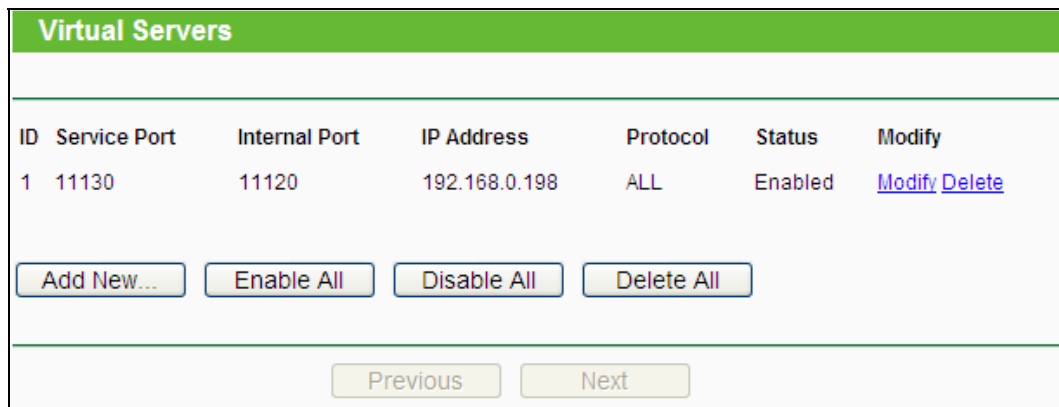

Figure 4-35 Virtual Servers

- **Service Port** - The numbers of External Ports. You can type a service port or a range of service ports (in XXX – YYY format, XXX is the start port number, YYY is the end port number).
- **Internal Port** - The Internal Service Port number of the PC running the service application. You can leave it blank if the **Internal Port** is the same as the **Service Port**, or enter a specific port number when **Service Port** is a single one.
- **IP Address** - The IP Address of the PC providing the service application.
- **Protocol** - The protocol used for this application, either **TCP**, **UDP**, or **All** (all protocols supported by the Router).
- **Status** - The status of this entry, either **Enabled** or **Disabled**.



**To set up a virtual server entry:**

1. Click the **Add New...** button, the next screen will pop-up as shown in Figure 4-36.
2. Select the service port you want to use from the **Common Service Port** list. If the **Common Service Port** list does not have the service that you want to use, type the service port number or service port range in the **Service Port** box.
3. Type the IP Address of the computer in the **IP Address** box.
4. Select the protocol used for this application, either **TCP**, **UDP**, or **All**.
5. Select the **Enable** to enable the virtual server.
6. Click the **Save** button.

Figure 4-36 Add or Modify a Virtual Server Entry

**Note:**

If your computer or server has more than one type of available service, please select another service, and enter the same IP Address for that computer or server.

**To modify or delete an existing entry:**

1. Click the **Modify** in the entry you want to modify. If you want to delete the entry, click the **Delete**.
2. Modify the information.
3. Click the **Save** button.

Click the **Enable/Disable All** button to make all entries enabled/disabled.

Click the **Delete All** button to delete all entries.

Click the **Next** button to go to the next page and click the **Previous** button to return the previous page.

**Note:**

If you set the service port of the virtual server as 80, you must set the Web management port on "**Security → Remote Management**" page to be any other value except 80 such as 8080. Otherwise there will be a conflict to disable the virtual server.

## 4.9.2 Port Triggering

Choose menu “**Forwarding** → **Port Triggering**”, you can view and add port triggering in the screen as shown in Figure 4-37. Some applications require multiple connections, like Internet games, video conferencing, Internet calling and so on. These applications cannot work with a pure NAT Router. Port Triggering is used for some of these applications that can work with an NAT Router.

ID	Trigger Port	Trigger Protocol	Incoming Ports	Incoming Protocol	Status	Modify
<input type="button" value="Add New..."/> <input type="button" value="Enable All"/> <input type="button" value="Disable All"/> <input type="button" value="Delete All"/>						
<input type="button" value="Previous"/> <input type="button" value="Next"/>						

Figure 4-37 Port Triggering

Once the Router is configured, the operation is as follows:

1. A local host makes an outgoing connection using a destination port number defined in the Trigger Port field.
  2. The Router records this connection, opens the incoming port or ports associated with this entry in the Port Triggering table, and associates them with the local host.
  3. When necessary, the external host will be able to connect to the local host using one of the ports defined in the **Incoming Ports** field.
- **Trigger Port** - The port for outgoing traffic. An outgoing connection using this port will trigger this rule.
  - **Trigger Protocol** - The protocol used for Trigger Ports, either **TCP**, **UDP**, or **All** (all protocols supported by the Router).
  - **Incoming Ports** - The port or port range used by the remote system when it responds to the outgoing request. A response using one of these ports will be forwarded to the PC that triggered this rule. You can input at most 5 groups of ports (or port sections). Every group of ports must be set apart with ",". For example, 2000-2038, 2050-2051, 2085, 3010-3030.
  - **Incoming Protocol** - The protocol used for Incoming Ports Range, either **TCP** or **UDP**, or **ALL** (all protocols supported by the Router).
  - **Status** - The status of this entry, either **Enabled** or **Disabled**.

**To add a new rule, follow the steps below.**

1. Click the **Add New...** button, the next screen will pop-up as shown in Figure 4-38.
2. Select a common application from the **Common Applications** drop-down list, then the **Trigger Port** field and the **Incoming Ports** field will be automatically filled. If the **Common Applications** do not have the application you need, enter the **Trigger Port** and the **Incoming Ports** manually.

3. Select the protocol used for Trigger Port from the **Trigger Protocol** drop-down list, either **TCP**, **UDP**, or **All**.
4. Select the protocol used for Incoming Ports from the **Incoming Protocol** drop-down list, either **TCP** or **UDP**, or **All**.
5. Select **Enable** in **Status** field.
6. Click the **Save** button to save the new rule.

The screenshot shows a web form titled "Add or Modify a Port Triggering Entry". The form contains the following fields and controls:

- Trigger Port:** An empty text input field.
- Trigger Protocol:** A dropdown menu with "All" selected.
- Incoming Ports:** An empty text input field.
- Incoming Protocol:** A dropdown menu with "All" selected.
- Status:** A dropdown menu with "Enabled" selected.
- Common Applications:** A dropdown menu with "--Select One--" selected.

At the bottom of the form, there are two buttons: "Save" and "Back".

Figure 4-38 Add or Modify a Port Triggering Entry

#### To modify or delete an existing entry:

1. Click the **Modify** in the entry you want to modify. If you want to delete the entry, click the **Delete**.
2. Modify the information.
3. Click the **Save** button.

Click the **Enable All** button to make all entries enabled

Click the **Disable All** button to make all entries disabled.

Click the **Delete All** button to delete all entries

#### **Note:**

- 1) When the trigger connection is released, the corresponding opening ports will be closed.
- 2) Each rule is allowed to be used only by one host on LAN synchronously. The trigger connection of other hosts on LAN will be refused.
- 3) Incoming Ports cannot overlap each other.

### 4.9.3 DMZ

Choose menu "**Forwarding** → **DMZ**", you can view and configure DMZ host in the screen as shown in Figure 4-39. The DMZ host feature allows one local host to be exposed to the Internet for a special-purpose service such as Internet gaming or videoconferencing. DMZ host forwards all the ports at the same time. Any PC whose port is being forwarded must have its DHCP client

function disabled and should have a new static IP Address assigned to it because its IP Address may be changed when using the DHCP function.

Figure 4-39 DMZ

**To assign a computer or server to be a DMZ server:**

1. Check the **Enable** radio button.
2. Enter the IP Address of a local host in the **DMZ Host IP Address** field.
3. Click the **Save** button.

**Note:**

After you set the DMZ host, the firewall related to the host will not work.

**4.9.4 UPnP**

Choose menu “**Forwarding → UPnP**”, you can view the information about **UPnP** (Universal Plug and Play) in the screen as shown in Figure 4-40. The UPnP feature allows the devices, such as Internet computers, to access the local host resources or devices as needed. UPnP devices can be automatically discovered by the UPnP service application on the LAN.

ID	App Description	External Port	Protocol	Internal Port	IP Address	Status
1	BitComet(192.168.0.100:23959)	23959	TCP	23959	192.168.0.100	Enabled
2	BitComet(192.168.0.100:23959)	23959	UDP	23959	192.168.0.100	Enabled

Figure 4-40 UPnP

- **Current UPnP Status** - UPnP can be enabled or disabled by clicking the **Enable** or **Disable** button.
- **Current UPnP Settings List** - This table displays the current UPnP information.

- **App Description** - The description provided by the application in the UPnP request.
- **External Port** - The external port the Router opens for the application.
- **Protocol** - The type of protocol the Router opens for the application.
- **Internal Port** - The Internal port the Router opens for local host.
- **IP Address** - The IP address of the UPnP device that is currently accessing the Router.
- **Status** - The status of the port is displayed here. "Enabled" means that the port is still active. Otherwise, the port is inactive.

Click **Refresh** to update the Current UPnP Settings List.

## 4.10 Security



Figure 4-41 The Security menu

There are four submenus under the Security menu as shown in Figure 4-41: **Basic Security**, **Advanced Security**, **Local Management** and **Remote Management**. Click any of them, and you will be able to configure the corresponding function.

### 4.10.1 Basic Security

Choose menu "**Security** → **Basic Security**", you can configure the basic security in the screen as shown in Figure 4-42.

**Basic Security**

**Firewall**

SPI Firewall:  Enable  Disable

**VPN**

PPTP Passthrough:  Enable  Disable

L2TP Passthrough:  Enable  Disable

IPSec Passthrough:  Enable  Disable

**ALG**

FTP ALG:  Enable  Disable

TFTP ALG:  Enable  Disable

H323 ALG:  Enable  Disable

RTSP ALG:  Enable  Disable

Save

Figure 4-42 Basic Security

- **Firewall** - A firewall protects your network from the outside world. Here you can enable or disable the Router's firewall.
  - **SPI Firewall** - SPI (Stateful Packet Inspection, also known as dynamic packet filtering) helps to prevent cyber attacks by tracking more state per session. It validates that the traffic passing through the session conforms to the protocol. SPI Firewall is enabled by factory default. If you want all the computers on the LAN exposed to the outside world, you can disable it.
- **VPN** - VPN Passthrough must be enabled if you want to allow VPN tunnels using IPSec, PPTP, or L2TP protocols to pass through the Router's firewall.
  - **PPTP Passthrough** - Point-to-Point Tunneling Protocol (PPTP) allows the Point-to-Point Protocol (PPP) to be tunneled through an IP network. To allow PPTP tunnels to pass through the Router, keep the default, **Enabled**.
  - **L2TP Passthrough** - Layer 2 Tunneling Protocol (L2TP) is the method used to enable Point-to-Point sessions via the Internet on the Layer 2 level. To allow L2TP tunnels to pass through the Router, keep the default, **Enabled**.
  - **IPSec Passthrough** - Internet Protocol Security (IPSec) is a suite of protocols for ensuring private, secure communications over Internet Protocol (IP) networks, through the use of cryptographic security services. To allow IPSec tunnels to pass through the Router, keep the default, **Enabled**.
- **ALG** - It is recommended to enable Application Layer Gateway (ALG) because ALG allows customized Network Address Translation (NAT) traversal filters to be plugged into the gateway to support address and port translation for certain application layer "control/data"

protocols such as FTP, TFTP, H323 etc.

- **FTP ALG** - To allow FTP clients and servers to transfer data across NAT, keep the default **Enable**.
- **TFTP ALG** - To allow TFTP clients and servers to transfer data across NAT, keep the default **Enable**.
- **H323 ALG** - To allow Microsoft NetMeeting clients to communicate across NAT, keep the default **Enable**.
- **RTSP ALG** - To allow some media player clients to communicate with some streaming media servers across NAT, click **Enable**.

Click the **Save** button to save your settings.

#### 4.10.2 Advanced Security

Choose menu “**Security** → **Advanced Security**”, you can protect the Router from being attacked by TCP-SYN Flood, UDP Flood and ICMP-Flood in the screen as shown in Figure 4-43.

Figure 4-43 Advanced Security

- **Packets Statistics Interval (5~60)** - The default value is 10. Select a value between 5 and 60 seconds from the drop-down list. The Packets Statistics Interval value indicates the time section of the packets statistics. The result of the statistics is used for analysis by SYN Flood, UDP Flood and ICMP-Flood.
- **DoS Protection** - Denial of Service protection. Check the Enable or Disable button to enable or disable the DoS protection function. Only when it is enabled, will the flood filters be enabled.

 **Note:**

Dos Protection will take effect only when the **Traffic Statistics** in “**System Tool** → **Traffic Statistics**” is enabled.

- **Enable ICMP-FLOOD Attack Filtering** - Enable or Disable the ICMP-FLOOD Attack Filtering.
- **ICMP-FLOOD Packets Threshold (5~3600)** - The default value is 50. Enter a value between 5 ~ 3600. When the current ICMP-FLOOD Packets number is beyond the set value, the Router will startup the blocking function immediately.
- **Enable UDP-FLOOD Filtering** - Enable or Disable the UDP-FLOOD Filtering.
- **UDP-FLOOD Packets Threshold (5~3600)** - The default value is 500. Enter a value between 5 ~ 3600. When the current UPD-FLOOD Packets number is beyond the set value, the Router will startup the blocking function immediately.
- **Enable TCP-SYN-FLOOD Attack Filtering** - Enable or Disable the TCP-SYN-FLOOD Attack Filtering.
- **TCP-SYN-FLOOD Packets Threshold (5~3600)** - The default value is 50. Enter a value between 5 ~ 3600. When the current TCP-SYN-FLOOD Packets numbers is beyond the set value, the Router will startup the blocking function immediately.
- **Ignore Ping Packet From WAN Port to Router** - Enable or Disable Ignore Ping Packet From WAN Port to Router. The default setting is disabled. If enabled, the ping packet from the Internet cannot access the Router.
- **Forbid Ping Packet From LAN Port to Router** - Enable or Disable Forbid Ping Packet From LAN Port to Router. The default setting is disabled. If enabled, the ping packet from LAN cannot access the Router. This function can be used to defend against some viruses.

Click the **Save** button to save the settings.

Click the **Blocked DoS Host List** button to display the DoS host table by blocking.

### 4.10.3 Local Management

Choose menu “**Security** → **Local Management**”, you can configure the management rule in the screen as shown in Figure 4-44. The management feature allows you to deny computers in LAN from accessing the Router.



Figure 4-44 Local Management

By default, the radio button “**All the PCs on the LAN are allowed to access the Router's Web-Based Utility**” is checked. If you want to allow PCs with specific MAC Addresses to access the Setup page of the Router's Web-Based Utility locally from inside the network, check the radio button “**Only the PCs listed can browse the built-in web pages to perform Administrator tasks**”, and then enter each MAC Address in a separate field. The format for the MAC Address is XX-XX-XX-XX-XX-XX (X is any hexadecimal digit). Only the PCs with MAC address listed can use the password to browse the built-in web pages to perform Administrator tasks while all the others will be blocked.

After click the **Add** button, your PC's MAC Address will be placed in the list above.

Click the **Save** button to save your settings.

**Note:**

If your PC is blocked but you want to access the Router again, press and hold the **WPS/RESET** button on the back panel for about 8 seconds to reset the Router's factory defaults.

#### 4.10.4 Remote Management

Choose menu “**Security → Remote Management**”, you can configure the Remote Management function in the screen as shown in Figure 4-45. This feature allows you to manage your Router from a remote location via the Internet.

Figure 4-45 Remote Management

- **Web Management Port** - Web browser access normally uses the standard HTTP service port 80. This Router's default remote management web port number is 80. For greater security, you can change the remote management web port to a custom port by entering that number in the box provided. Choose a number between 1 and 65534 but do not use the number of any common service port.
- **Remote Management IP Address** - This is the current address you will use when accessing your Router from the Internet. This function is disabled when the IP address is set to the default value of 0.0.0.0. To enable this function change 0.0.0.0 to a valid IP address. If set to 255.255.255.255, then all the hosts can access the Router from internet.

**Note:**

- 1) To access the Router, you should type your Router's WAN IP address into your browser's address (in IE) or Location (in Navigator) box, followed by a colon and the custom port number. For example, if your Router's WAN address is 202.96.12.8, and the port number used is 8080, please enter <http://202.96.12.8:8080> in your browser. Later, you may be asked for the Router's password. After successfully entering the username and password, you will be able to access the Router's web-based utility.
- 2) Be sure to change the Router's default password to a very secure password.

## 4.11 Parental Control

Choose menu “**Parental Control**”, and you can configure the parental control in the screen as shown in Figure 4-46. The Parental Control function can be used to control the internet activities of the children, limit the children to access certain websites and restrict the time of surfing.

Figure 4-46 Parental Control Settings

- **Parental Control** - Check **Enable** if you want this function to take effect, otherwise check **Disable**.

- **MAC Address of Parental PC** - In this field, enter the MAC address of the controlling PC, or you can make use of the **Copy To Above** button below.
- **MAC Address of Your PC** - This field displays the MAC address of the PC that is managing this Router. If the MAC Address of your adapter is registered, you can click the Copy To Above button to fill this address to the MAC Address of Parental PC field above.
- **Website Description** - Description of the allowed website for the PC controlled.
- **Schedule** - The time period allowed for the PC controlled to access the Internet. For detailed information, please go to "**Access Control** → **Schedule**".
- **Modify** - Here you can edit or delete an existing entry.

**To add a new entry, please follow the steps below.**

1. Click the **Add New...** button and the next screen will pop-up as shown in Figure 4-47.
2. Enter the MAC address of the PC (e.g. 00-11-22-33-44-AA) you'd like to control in the MAC Addresses of Children PC field. Or you can choose the MAC address from the All Address in Current LAN drop-down list.
3. Give a description (e.g. Allow Google) for the website allowed to be accessed in the Website Description field.
4. Enter the allowed domain name of the website, either the full name or the keywords (e.g. google) in the Allowed Domain Name field. Any domain name with keywords in it ([www.google.com](http://www.google.com), [www.google.com.hk](http://www.google.com.hk)) will be allowed.
5. Select from the Effective Time drop-down list the schedule (e.g. Schedule\_1) you want the entry to take effect. If there are not suitable schedules for you, click the **Schedule** in red below to go to the Advance Schedule Settings page and create the schedule you need.
6. In the Status field, you can select **Enabled** or **Disabled** to enable or disable your entry.
7. Click the **Save** button.

Click the **Enable All** button to enable all the rules in the list.

Click the **Disable All** button to disable all the rules in the list.

Click the **Delete All** button to delete all the entries in the table.

Click the **Next** button to go to the next page, or click the **Previous** button return to the previous page.

Figure 4-47 Add or Modify Parental Control Entry

**For example:** If you desire that the children’s PC with MAC address 00-11-22-33-44-AA can access www.google.com on Saturday only while the parent PC with MAC address 00-11-22-33-44-BB is without any restriction, you should follow the settings below.

1. Click **“Parental Control”** menu on the left to enter the Parental Control Settings page. Check Enable and enter the MAC address 00-11-22-33-44-BB in the MAC Address of Parental PC field.
2. Click **“Access Control → Schedule”** on the left to enter the Schedule Settings page. Click **Add New...** button to create a new schedule with Schedule Description is Schedule\_1, Day is Sat and Time is all day-24 hours.
3. Click **“Parental Control”** menu on the left to go back to the Add or Modify Parental Control Entry page:
  - Click **Add New...** button.
  - Enter 00-11-22-33-44-AA in the **MAC Address of Children’s PC** field.
  - Enter “Allow Google” in the **Website Description** field.
  - Enter “www.google.com” in the **Allowed Website Name** field.
  - Select “Schedule\_1” you create just now from the **Effective Time** drop-down list.
  - In **Status** field, select Enable.
4. Click **Save** to complete the settings.

Then you will go back to the Parental Control Settings page and see the following list, as shown in Figure 4-48.

ID	MAC address	Website Description	Schedule	Status	Modify
1	00-11-22-33-44-AA	Allow Google	Schedule_1	Enabled	<a href="#">Edit</a> <a href="#">Delete</a>

Figure 4-48 Parental Control Settings

## 4.12 Access Control



Figure 4-49 Access Control

There are four submenus under the Access Control menu as shown in Figure 4-49: **Rule**, **Host**, **Target** and **Schedule**. Click any of them, and you will be able to configure the corresponding function.

### 4.12.1 Rule

Choose menu “**Access Control** → **Rule**”, you can view and set Access Control rules in the screen as shown in Figure 4-50.

Figure 4-50 Access Control Rule Management

- **Enable Internet Access Control** - Select the check box to enable the Internet Access Control function, so the Default Filter Policy can take effect.
- **Rule Name** - Here displays the name of the rule and this name is unique.
- **Host** - Here displays the host selected in the corresponding rule.
- **Target** - Here displays the target selected in the corresponding rule.
- **Schedule** - Here displays the schedule selected in the corresponding rule.
- **Status** - This field displays the status of the rule. **Enabled** means the rule will take effect, **Disabled** means the rule will not take effect.
- **Modify** - Here you can edit or delete an existing rule.

There are two methods to add a new rule.

**Method One:**

1. Click **Setup Wizard** button and the next screen will appear as shown in Figure 4-51.

Figure 4-51 Quick Setup – Create a Host Entry

- **Mode** - Here are two options, **IP Address** and **MAC Address**. You can select either of them from the drop-down list.
  - **Host Description** - In this field, create a unique description for the host (e.g. Host\_1).  
If the **IP Address** is selected, you can see the following item:
  - **LAN IP Address** - Enter the IP address or address range of the host in dotted-decimal format (e.g. 192.168.0.23).  
If the **MAC Address** is selected, you can see the following item:
  - **MAC Address** - Enter the MAC address of the host in XX-XX-XX-XX-XX-XX format (e.g. 00-11-22-33-44-AA).
2. Click **Next** when finishing creating the host entry, and the next screen will appear as shown in Figure 4-52.

Figure 4-52 Quick Setup – Create an Access Target Entry

- **Mode** - Here are two options, **IP Address** and **Domain Name**. You can choose either of them from the drop-down list.

- **Target Description** - In this field, create a description for the target. Note that this description should be unique (e.g. Target\_1).

If the **IP Address** is selected, you will see the following items:

- **IP Address** - Enter the IP address (or address range) of the target (targets) in dotted-decimal format (e.g. 192.168.0.23).
- **Target Port** - Specify the port or port range for the target. For some common service ports, you can make use of the Common Service Port item below.
- **Protocol** - Here are four options, All, TCP, UDP, and ICMP. Select one of them from the drop-down list for the target.
- **Common Service Port** - Here lists some common service ports. Select one from the drop-down list, and the corresponding port number will be filled in the Target Port field automatically. For example, if you select "FTP", "21" will be filled in the Target Port automatically.

If the **Domain Name** is selected, you will see the following items:

- **Domain Name** - Here you can enter 4 domain names, either the full name or the keywords (for example, google). Any domain name with keywords in it (www.google.com, www.google.cn) will be blocked or allowed.
3. Click **Next** when finishing creating the access target entry, and the next screen will appear as shown in Figure 4-53.

Figure 4-53 Quick Setup – Create an Advanced Schedule Entry

- **Schedule Description** - In this field, create a description for the schedule. Note that this description should be unique (e.g. Schedule\_1).
- **Day** - Choose Select Days and select the certain day (days), or choose Everyday.



- **Time** - Select "24 hours", or specify the Start Time and Stop Time yourself.
  - **Start Time** - Enter the start time in HHMM format (HHMM are 4 numbers). For example 0800 is 8:00.
  - **Stop Time** - Enter the stop time in HHMM format (HHMM are 4 numbers). For example 2000 is 20:00.
4. Click **Next** when finishing creating the advanced schedule entry, and the next screen will appear as shown in Figure 4-54.

The screenshot shows a web form titled "Quick Setup - Create an Internet Access Control Entry". The form contains the following fields and options:

- Rule Name:** A text input field containing "Rule 1".
- Host:** A dropdown menu with "John's Computer" selected.
- Target:** A dropdown menu with "Viola's Computer" selected.
- Schedule:** A dropdown menu with "Anytime" selected.
- Status:** A dropdown menu with "Enabled" selected.

At the bottom of the form, there are two buttons: "Back" and "Finish".

Figure 4-54 Quick Setup – Create an Internet Access Control Entry

- **Rule** - In this field, create a name for the rule. Note that this name should be unique (e.g. Rule\_1).
  - **Host** - In this field, select a host from the drop-down list for the rule. The default value is the **Host Description** you set just now.
  - **Target** - In this field, select a target from the drop-down list for the rule. The default value is the **Target Description** you set just now.
  - **Schedule** - In this field, select a schedule from the drop-down list for the rule. The default value is the **Schedule Description** you set just now.
  - **Status** - In this field, there are two options, **Enabled** or **Disabled**. Select **Enabled** so that the rule will take effect. Select **Disabled** so that the rule won't take effect.
5. Click **Finish** to complete adding a new rule.

#### Method Two:

1. Click the **Add New...** button and the next screen will pop up as shown in Figure 4-55.
2. Give a name (e.g. Rule\_1) for the rule in the **Rule Name** field.
3. Select a host from the **Host** drop-down list or choose "**Click Here To Add New Host List**".
4. Select a target from the **Target** drop-down list or choose "**Click Here To Add New Target List**".

5. Select a schedule from the **Schedule** drop-down list or choose “**Click Here To Add New Schedule**”.
6. In the **Status** field, select **Enabled** or **Disabled** to enable or disable your entry.
7. Click the **Save** button.

Figure 4-55 Add Internet Access Control Entry

**For example:** If you desire to allow the host with MAC address 00-11-22-33-44-AA to access www.google.com only from 18:00 to 20:00 on Saturday and Sunday, and forbid other hosts in the LAN to access the Internet, you should follow the settings below:

1. Click the submenu **Rule of Access Control** in the left to return to the Rule List page. Select Enable Internet Access Control and choose "Allow the packets specified by any enabled access control policy to pass through the Router".
2. We recommend that you click **Setup Wizard** button to finish all the following settings.
3. Click the submenu **Host of Access Control** in the left to enter the Host List page. Add a new entry with the Host Description is Host\_1 and MAC Address is 00-11-22-33-44-AA.
4. Click the submenu **Target of Access Control** in the left to enter the Target List page. Add a new entry with the Target Description is Target\_1 and Domain Name is www.google.com.
5. Click the submenu **Schedule of Access Control** in the left to enter the Schedule List page. Add a new entry with the Schedule Description is Schedule\_1, Day is Sat and Sun, Start Time is 1800 and Stop Time is 2000.
6. Click the submenu **Rule of Access Control** in the left, Click **Add New...** button to add a new rule as follows:
  - In Rule Name field, create a name for the rule. Note that this name should be unique, for example Rule\_1.
  - In Host field, select Host\_1.
  - In Target field, select Target\_1.
  - In Schedule field, select Schedule\_1.
  - In Status field, select Enable.

- Click Save to complete the settings.

Then you will go back to the Access Control Rule Management page and see the following list.

ID	Rule Name	Host	Target	Schedule	Enable	Modify
1	Rule_1	<a href="#">Host_1</a>	<a href="#">Target_1</a>	<a href="#">Schedule_1</a>	<input checked="" type="checkbox"/>	<a href="#">Edit</a> <a href="#">Delete</a>

#### 4.12.2 Host

Choose menu “**Access Control → Host**”, you can view and set a Host list in the screen as shown in Figure 4-56. The host list is necessary for the Access Control Rule.

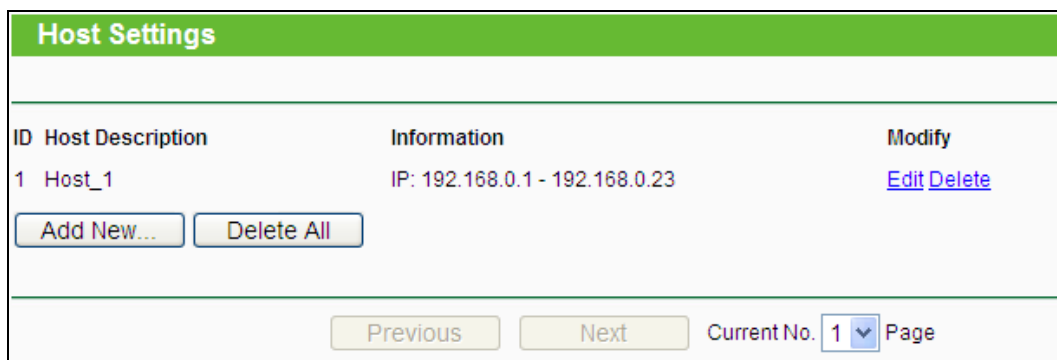

Figure 4-56 Host Settings

- **Host Description** - Here displays the description of the host and this description is unique.
- **Information** - Here displays the information about the host. It can be IP or MAC.
- **Modify** - To modify or delete an existing entry.

**To add a new entry, please follow the steps below.**

1. Click the **Add New...** button.
2. In the **Mode** field, select IP Address or MAC Address.
  - If you select IP Address, the screen shown is Figure 4-57.
    - 1) In **Host Description** field, create a unique description for the host (e.g. Host\_1).
    - 2) In **LAN IP Address** field, enter the IP address.
  - If you select MAC Address, the screen shown is Figure 4-58.
    - 1) In **Host Description** field, create a unique description for the host (e.g. Host\_1).
    - 2) In **MAC Address** field, enter the MAC address.
3. Click the **Save** button to complete the settings.

Click the **Delete All** button to delete all the entries in the table.

Click the **Next** button to go to the next page, or click the **Previous** button return to the previous page.

The screenshot shows a web form titled "Add or Modify a Host Entry". It has a green header bar with the title. Below the header, there are three input fields: "Mode" is a dropdown menu set to "IP Address"; "Host Description" is a text box containing "Host\_1"; and "LAN IP Address" consists of two text boxes, the first containing "192.168.0.1" and the second containing "192.168.0.23", separated by a hyphen. At the bottom of the form are two buttons: "Save" and "Back".

Figure 4-57 Add or Modify a Host Entry

The screenshot shows the same "Add or Modify a Host Entry" form, but with the "Mode" dropdown menu set to "MAC Address". The "Host Description" text box still contains "Host\_1". The "MAC Address" text box now contains "00-11-22-33-44-AA". The "Save" and "Back" buttons are still present at the bottom.

Figure 4-58 Add or Modify a Host Entry

**For example:** If you desire to restrict the internet activities of host with MAC address 00-11-22-33-44-AA, you should first follow the settings below:

1. Click **Add New...** button in Figure 4-56 to enter the Add or Modify a Host Entry page.
2. In **Mode** field, select MAC Address from the drop-down list.
3. In **Host Description** field, create a **unique** description for the host (e.g. Host\_1).
4. In **MAC Address** field, enter 00-11-22-33-44-AA.
5. Click **Save** to complete the settings.

Then you will go back to the Host Settings page and see the following list.

ID	Host Description	Information	Modify
1	Host_1	MAC: 00-11-22-33-44-AA	<a href="#">Edit</a> <a href="#">Delete</a>

### 4.12.3 Target

Choose menu "**Access Control** → **Target**", you can view and set a Target list in the screen as shown in Figure 4-59. The target list is necessary for the Access Control Rule.

Target Settings			
ID	Target Description	Information	Modify
1	Target_1	192.168.0.2 - 192.168.0.23/21/TCP	<a href="#">Edit</a> <a href="#">Delete</a>
<input type="button" value="Add New..."/> <input type="button" value="Delete All"/>			
		<input type="button" value="Previous"/> <input type="button" value="Next"/>	Current No. <input type="text" value="1"/> Page

Figure 4-59 Target Settings

- **Target Description** - Here displays the description about the target and this description is unique.
- **Information** - The target can be IP address, port, or domain name.
- **Modify** - To modify or delete an existing entry.

**To add a new entry, please follow the steps below.**

1. Click the **Add New...** button.
2. In **Mode** field, select IP Address or Domain Name.
  - If you select **IP Address**, the screen shown is Figure 4-60.
    - 1) In **Target Description** field, create a unique description for the target (e.g. Target\_1).
    - 2) In **IP Address** field, enter the IP address of the target.
    - 3) Select a common service from **Common Service Port** drop-down list, so that the **Target Port** will be automatically filled. If the **Common Service Port** drop-down list doesn't have the service you want, specify the **Target Port** manually.
    - 4) In **Protocol** field, select TCP, UDP, ICMP or ALL.
  - If you select **Domain Name**, the screen shown is Figure 4-61.
    - 1) In **Target Description** field, create a unique description for the target (e.g. Target\_1).
    - 2) In **Domain Name** field, enter the domain name, either the full name or the keywords (for example google) in the blank. Any domain name with keywords in it ([www.google.com](http://www.google.com), [www.google.hk](http://www.google.hk)) will be blocked or allowed. You can enter 4 domain names.
3. Click the **Save** button.

Click the **Delete All** button to delete all the entries in the table.

Click the **Next** button to go to the next page, or click the **Previous** button return to the previous page.

The screenshot shows a web form titled "Add or Modify an Access Target Entry". The "Mode" dropdown is set to "IP Address". The form includes the following fields:
 

- Mode:** IP Address (dropdown)
- Target Description:** [Text input field]
- IP Address:** [Text input field] - [Text input field]
- Target Port:** [Text input field] - [Text input field]
- Protocol:** ALL (dropdown)
- Common Service Port:** --please select-- (dropdown)

 At the bottom, there are "Save" and "Back" buttons.

Figure 4-60 Add or Modify an Access Target Entry

The screenshot shows the same web form, but the "Mode" dropdown is now set to "Domain Name". The form includes the following fields:
 

- Mode:** Domain Name (dropdown)
- Target Description:** [Text input field]
- Domain Name:** [Text input field]
- [Text input field]
- [Text input field]
- [Text input field]

 At the bottom, there are "Save" and "Back" buttons.

Figure 4-61 Add or Modify an Access Target Entry

**For example:** If you desire to restrict the internet activities of host with MAC address 00-11-22-33-44-AA in the LAN to access **www.google.com** only, you should first follow the settings below:

1. Click **Add New...** button in Figure 4-59 to enter the Add or Modify an Access Target Entry page.
2. In **Mode** field, select Domain Name from the drop-down list.
3. In **Target Description** field, create a unique description for the target (e.g. Target\_1).
4. In **Domain Name** field, enter www.google.com.
5. Click **Save** to complete the settings.

Then you will go back to the Target Settings page and see the following list,

ID	Target Description	Information	Modify
1	Target_1	www.google.com	<a href="#">Edit</a> <a href="#">Delete</a>

#### 4.12.4 Schedule

Choose menu “**Access Control** → **Schedule**”, you can view and set a Schedule list in the next screen as shown in Figure 4-62. The Schedule list is necessary for the Access Control Rule.

ID	Schedule Description	Day	Time	Modify
<input type="button" value="Add New..."/> <input type="button" value="Delete All"/>				
		<input type="button" value="Previous"/> <input type="button" value="Next"/> Current No. <input type="button" value="1"/> Page		

Figure 4-62 Schedule Settings

- **Schedule Description** - Here displays the description of the schedule and this description is unique.
- **Day** - Here displays the day(s) in a week.
- **Time** - Here displays the time period in a day.
- **Modify** - Here you can edit or delete an existing schedule.

**To add a new schedule, follow the steps below.**

1. Click **Add New...** button shown in Figure 4-62 and the next screen will pop-up as shown in Figure 4-63.
2. In **Schedule Description** field, create a unique description for the schedule (e.g. Schedule\_1).
3. In **Day** field, select the day or days you need.
4. In **Time** field, you can select all day-24 hours or you may enter the Start Time and Stop Time in the corresponding field.
5. Click **Save** to complete the settings.

Click the **Delete All** button to delete all the entries in the table.

Click the **Next** button to go to the next page, or click the **Previous** button return to the previous page.

Figure 4-63 Advanced Schedule Settings

**For example:** If you desire to restrict the internet activities of host with MAC address 00-11-22-33-44-AA to access www.google.com only from **18:00 to 20:00** on **Saturday** and **Sunday**, you should first follow the settings below:

1. Click **Add New...** button shown in Figure 4-62 to enter the Advanced Schedule Settings page.
2. In **Schedule Description** field, create a unique description for the schedule (e.g. Schedule\_1).
3. In **Day** field, check the Select Days radio button and then select Sat and Sun.
4. In **Time** field, enter 1800 in Start Time field and 2000 in Stop Time field.
5. Click **Save** to complete the settings.

Then you will go back to the Schedule Settings page and see the following list.

ID	Schedule Description	Day	Time	Modify
1	Schedule_1	Sat Sun	18:00 - 20:00	<a href="#">Edit</a> <a href="#">Delete</a>

## 4.13 Advanced Routing

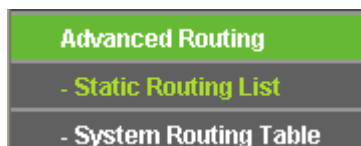

Figure 4-64 Advanced Routing Menu

There are two submenus under the Network menu (shown in Figure 4-64): **Static Routing List** and **System Routing Table**. Click any of them, and you will be able to configure the corresponding function.



### 4.13.1 Static Routing

Choose menu “**Advanced Routing** → **Static Routing**”, and you can configure the static route in the next screen, shown in Figure 4-65. A static route is a pre-determined path that network information must travel to reach a specific host or network.

ID	Destination Network	Subnet Mask	Default Gateway	Status	Modify
<input type="button" value="Add New..."/> <input type="button" value="Enable All"/> <input type="button" value="Disable All"/> <input type="button" value="Delete All"/>					
<input type="button" value="Previous"/> <input type="button" value="Next"/>					

Figure 4-65 Static Routing

To add static routing entries, follow the steps below.

1. Click **Add New...** shown in Figure 4-65, you will see the following screen Figure 4-66.

**Destination Network:**   
**Subnet Mask:**   
**Default Gateway:**   
**Status:**

Figure 4-66 Add or Modify a Static Route Entry

2. Enter the following data.
  - **Destination Network** - The **Destination Network** is the address of the network or host that you want to assign to a static route.
  - **Subnet Mask** - The **Subnet Mask** determines which portion of an IP Address is the network portion, and which portion is the host portion.
  - **Default Gateway** - This is the IP Address of the default gateway device that allows for the contact between the Router and the network or host.
3. Select **Enabled** or **Disabled** for this entry on the **Status** drop-down list.
4. Click the **Save** button to make the entry take effect.

Click the **Delete** button to delete the entry.

Click the **Enable All** button to enable all the entries.

Click the **Disable All** button to disable all the entries.

Click the **Delete All** button to delete all the entries.

Click the **Previous** button to view the information in the previous screen, click the **Next** button to view the information in the next screen.

### 4.13.2 System Routing Table

Choose menu “**Advanced Routing → System Routing Table**”, and you can views all of the valid route entries in use. The Destination IP address, Subnet Mask, Gateway, and Interface will be displayed for each entry.

System Routing Table				
ID	Destination Network	Subnet Mask	Gateway	Interface
1	192.168.1.0	255.255.255.0	0.0.0.0	WAN
2	192.168.0.0	255.255.255.0	0.0.0.0	LAN & WLAN
3	0.0.0.0	0.0.0.0	192.168.1.1	WAN

- **Destination Network** - The Destination Network is the address of the network or host to which the static route is assigned.
- **Subnet Mask** - The Subnet Mask determines which portion of an IP address is the network portion, and which portion is the host portion.
- **Gateway** - This is the IP address of the gateway device that allows for contact between the Router and the network or host.
- **Interface** - This interface tells you whether the Destination IP Address is on the **LAN & WLAN** (internal wired and wireless networks), the **WAN(Internet)**.

Click the **Refresh** button to refresh the data displayed.

### 4.14 Bandwidth Control

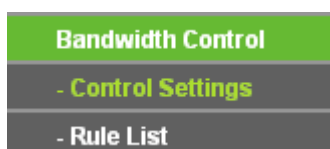

Figure 4-67

There are two submenus under the Bandwidth Control menu as shown in Figure 4-67. Click any of them, and you will be able to configure the corresponding function. The detailed explanations for each submenu are provided below.

### 4.14.1 Control Settings

Choose menu “**Bandwidth Control** → **Control Settings**”, you can configure the Egress Bandwidth and Ingress Bandwidth in the next screen. Their values you configure should be less than 100000Kbps. For optimal control of the bandwidth, please select the right Line Type and ask your ISP for the total bandwidth of the egress and ingress.

Figure 4-68 Bandwidth Control Settings

- **Enable Bandwidth Control** - Check this box so that the Bandwidth Control settings can take effect.
- **Line Type** - Select the right type for you network connection. If you don't know how to choose, please ask your ISP for the information.
- **Egress Bandwidth** - The upload speed through the WAN port.
- **Ingress Bandwidth** - The download speed through the WAN port.

### 4.14.2 Rules List

Choose menu “**Bandwidth Control** → **Rules List**”, you can view and configure the Bandwidth Control rules in the screen below.

Figure 4-69 Bandwidth Control Rules List

- **Description** - This is the information about the rules such as address range.
- **Egress bandwidth** - This field displays the max and mix upload bandwidth through the WAN port, the default is 0.

- **Ingress bandwidth** - This field displays the max and mix download bandwidth through the WAN port, the default is 0.
- **Enable** - This displays the status of the rule.
- **Modify** - Click **Modify** to edit the rule. Click **Delete** to delete the rule.

To add a **Bandwidth Control** rule, follow the steps below.

**Step 1:** Click **Add New...** shown in Figure 4-69, you will see a new screen shown in Figure 4-70.

**Step 2:** Enter the information like the screen shown below.

Figure 4-70 Bandwidth Control Rule Settings

**Step 3:** Click the **Save** button.

## 4.15 IP & MAC Binding

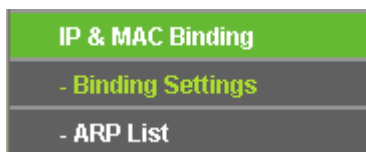

Figure 4-71 the IP & MAC Binding menu

There are two submenus under the **IP & MAC Binding** menu (shown in Figure 4-71): **Binding Settings** and **ARP List**. Click any of them, and you will be able to scan or configure the corresponding function. The detailed explanations for each submenu are provided below.

### 4.15.1 Binding Settings

This page displays the **IP & MAC Binding** table; you can operate it in accord with your desire as shown in Figure 4-72.

Figure 4-72 Binding Settings

- **MAC Address** - The MAC address of the controlled computer in the LAN.
- **IP Address** - The assigned IP address of the controlled computer in the LAN.
- **Bind** - Check this option to enable ARP binding for a specific device.
- **Modify** - To modify or delete an existing entry.

When you want to add or modify an IP & MAC Binding entry, you can click the **Add New...** button or **Modify** button, and then you will go to the next page. This page is used for adding or modifying an IP & MAC Binding entry, shown in Figure 4-73.

Figure 4-73 IP & MAC Binding Settings

**To add IP & MAC Binding entries, follow the steps below.**

1. Click the **Add New...** button as shown in Figure 4-72.
2. Enter the MAC Address and IP Address.
3. Select the Bind checkbox.
4. Click the **Save** button to save it.

**To modify or delete an existing entry, follow the steps below.**

1. Find the desired entry in the table.

2. Click **Modify** or **Delete** as desired on the **Modify** column.

**To find an existing entry, follow the steps below.**

1. Click the **Find** button as shown in Figure 4-72.
2. Enter the MAC Address or IP Address.
3. Click the **Find** button in the page as shown in Figure 4-74.

Find IP & MAC Binding Entry			
MAC Address:	<input type="text" value="00-14-5E-91-19-E3"/>		
IP Address:	<input type="text"/>		
ID	MAC Address	IP Address	Bind Link
2	00-14-5E-91-19-E3	192.168.1.56	<input checked="" type="checkbox"/> <a href="#">To page</a>
<input type="button" value="Find"/> <input type="button" value="Back"/>			

Figure 4-74 Find IP & MAC Binding Entry

Click the **Enable All** button to make all entries enabled.

Click the **Delete All** button to delete all entries.

#### 4.15.2 ARP List

To manage the computer, you could observe the computers in the LAN by checking the relationship of MAC address and IP address on the ARP list, and you could configure the items on the ARP list also. This page displays the ARP List; it shows all the existing IP & MAC Binding entries as shown in Figure 4-75.

ARP List				
ID	MAC Address	IP Address	Status	Configure
1	40-61-86-FC-74-93	192.168.0.100	Unbound	<a href="#">Load Delete</a>
<input type="button" value="Bind All"/> <input type="button" value="Load All"/> <input type="button" value="Refresh"/>				

Figure 4-75 ARP List

- **MAC Address** - The MAC address of the controlled computer in the LAN.
- **IP Address** - The assigned IP address of the controlled computer in the LAN.
- **Status** - Indicates whether or not the MAC and IP addresses are bound.
- **Configure** - Load or delete an item.
  - **Load** - Load the item to the IP & MAC Binding list.

- **Delete** - Delete the item.

Click the **Bind All** button to bind all the current items, available after enable.

Click the **Load All** button to load all items to the IP & MAC Binding list.

Click the **Refresh** button to refresh all items.

 **Note:**

An item could not be loaded to the IP & MAC Binding list if the IP address of the item has been loaded before. Error warning will prompt as well. Likewise, "Load All" only loads the items without interference to the IP & MAC Binding list.

## 4.16 Dynamic DNS

Choose menu "**Dynamic DNS**", and you can configure the Dynamic DNS function.

The Router offers the **DDNS** (Dynamic Domain Name System) feature, which allows the hosting of a website, FTP server, or e-mail server with a fixed domain name (named by yourself) and a dynamic IP address, and then your friends can connect to your server by entering your domain name no matter what your IP address is. Before using this feature, you need to sign up for DDNS service providers such as [www.comexe.cn](http://www.comexe.cn), [www.dyndns.org](http://www.dyndns.org), or [www.no-ip.com](http://www.no-ip.com). The Dynamic DNS client service provider will give you a password or key.

### 4.16.1 Comexe.cn DDNS

If the dynamic DNS **Service Provider** you select is [www.comexe.cn](http://www.comexe.cn), the page will appear as shown in Figure 4-76.

**DDNS**

**Service Provider:** Comexe ( www.comexe.cn )

**Domain Name:**

**Domain Name:**

**Domain Name:**

**Domain Name:**

**Domain Name:**

**User Name:**

**Password:**

Enable DDNS

**Connection Status:** DDNS not launching!

Figure 4-76 Comexe.cn DDNS Settings

**To set up for DDNS, follow these instructions:**

1. Type the **Domain Name** received from your dynamic DNS service provider.
2. Type the **User Name** for your DDNS account.
3. Type the **Password** for your DDNS account.
4. Click the **Login** button to log in to the DDNS service.

**Connection Status** -The status of the DDNS service connection is displayed here.

Click **Logout** to log out of the DDNS service.

**4.16.2 Dyndns.org DDNS**

If the dynamic DNS **Service Provider** you select is [www.dyndns.org](http://www.dyndns.org), the page will appear as shown in Figure 4-77.



Figure 4-77 Dyndns.org DDNS Settings

To set up for DDNS, follow these instructions:

1. Type the **User Name** for your DDNS account.
2. Type the **Password** for your DDNS account.
3. Type the **Domain Name** you received from dynamic DNS service provider here.
4. Click the **Login** button to log in to the DDNS service.

**Connection Status** -The status of the DDNS service connection is displayed here.

Click **Logout** to logout of the DDNS service.

#### 4.16.3 No-ip.com DDNS

If the dynamic DNS **Service Provider** you select is [www.no-ip.com](http://www.no-ip.com), the page will appear as shown in Figure 4-78.

Figure 4-78 No-ip.com DDNS Settings

To set up for DDNS, follow these instructions:

1. Type the **User Name** for your DDNS account.
2. Type the **Password** for your DDNS account.
3. Type the **Domain Name** you received from dynamic DNS service provider.
4. Click the **Login** button to log in the DDNS service.

**Connection Status** - The status of the DDNS service connection is displayed here.

Click **Logout** to log out the DDNS service.

## 4.17 System Tools

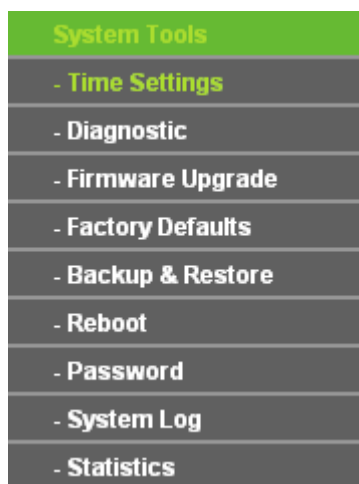
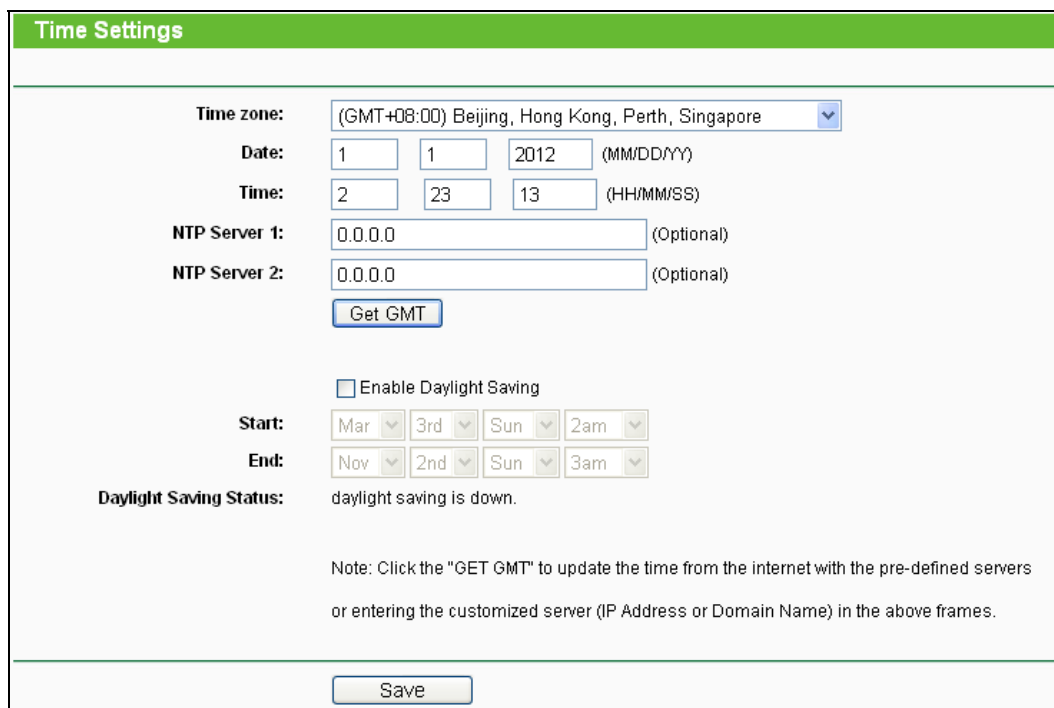

Figure 4-79 The System Tools menu

Choose menu "**System Tools**", and you can see the submenus under the main menu: **Time Settings**, **Diagnostic**, **Firmware Upgrade**, **Factory Defaults**, **Backup & Restore**, **Reboot**, **Password**, **System Log** and **Statistics**. Click any of them, and you will be able to configure the corresponding function. The detailed explanations for each submenu are provided below.

### 4.17.1 Time Settings

Choose menu "**System Tools** → **Time Settings**", you can configure the time on the following screen.



**Time Settings**

**Time zone:** (GMT+08:00) Beijing, Hong Kong, Perth, Singapore

**Date:** 1 / 1 / 2012 (MM/DD/YY)

**Time:** 2 : 23 : 13 (HH/MM/SS)

**NTP Server 1:** 0.0.0.0 (Optional)

**NTP Server 2:** 0.0.0.0 (Optional)

Enable Daylight Saving

**Start:** Mar / 3rd / Sun / 2am

**End:** Nov / 2nd / Sun / 3am

**Daylight Saving Status:** daylight saving is down.

Note: Click the "GET GMT" to update the time from the internet with the pre-defined servers or entering the customized server (IP Address or Domain Name) in the above frames.

Figure 4-80 Time settings

- **Time zone** - Select your local time zone from this drop-down list.
- **Date** - Enter your local date in MM/DD/YY into the right blanks.
- **Time** - Enter your local time in HH/MM/SS into the right blanks.
- **NTP Server 1 / NTP Server 2** - Enter the address or domain of the **NTP Server 1** or **NTP Server 2**, and then the Router will get the time from the NTP Server preferentially. In addition, the Router built-in some common NTP Servers, so it can get time automatically once it connects the Internet.
- **Enable Daylight Saving** - Check the box to enable the Daylight Saving function.
- **Start** - The time to start the Daylight Saving. Select the month in the first field, the week in the second field, the day in the third field and the time in the last field.
- **End** - The time to end the Daylight Saving. Select the month in the first field, the week in the second field, the day in the third field and the time in the last field.
- **Daylight Saving Status** - Displays the status whether the Daylight Saving is in use.

#### To set time manually:

1. Select your local time zone.
2. Enter the **Date** in Month/Day/Year format.
3. Enter the **Time** in Hour/Minute/Second format.
4. Click **Save**.

**To set time automatically:**

1. Select your local time zone.
2. Enter the address or domain of the **NTP Server I** or **NTP Server II**.
3. Click the **Get GMT** button to get system time from Internet if you have connected to the Internet.

**To set Daylight Saving:**

1. Check the box to enable Daylight Saving.
2. Select the start time from the drop-down lists in the **Start** field.
3. Select the end time from the drop-down lists in the **End** field.
4. Click the **Save** button to save the settings.

	<input checked="" type="checkbox"/> Enable Daylight Saving
<b>Start:</b>	Mar 3rd Sun 2am
<b>End:</b>	Nov 2nd Sun 3am
<b>Daylight Saving Status:</b>	daylight saving is down.
<p>Note: Click the "GET GMT" to update the time from the internet with the pre-defined servers or entering the customized server (IP Address or Domain Name) in the above frames.</p>	

 **Note:**

- 1) This setting will be used for some time-based functions such as firewall. You must specify your time zone once you login to the router successfully, otherwise, these functions will not take effect.
- 2) The time will be lost if the router is turned off.
- 3) The Router will automatically obtain GMT from the Internet if it is configured accordingly.
- 4) The Daylight Saving will take effect one minute after the configurations are completed.

**4.17.2 Diagnostic**

Choose menu "**System Tools** → **Diagnostic**", you can transact Ping or Traceroute function to check connectivity of your network in the following screen.

**Diagnostic Tools**

**Diagnostic Parameters**

**Diagnostic Tool:**  Ping  Traceroute

**IP Address/ Domain Name:**

**Ping Count:**  (1-50)

**Ping Packet Size:**  (4-1472 Bytes)

**Ping Timeout:**  (100-2000 Milliseconds)

**Traceroute Max TTL:**  (1-30)

**Diagnostic Results**

The Router is ready.

Figure 4-81 Diagnostic Tools

- **Diagnostic Tool** - Check the radio button to select one diagnostic tool.
  - **Ping** - This diagnostic tool troubleshoots connectivity, reachability, and name resolution to a given host or gateway.
  - **Traceroute** - This diagnostic tool tests the performance of a connection.

**Note:**

You can use ping/traceroute to test both numeric IP address or domain name. If pinging/tracerouting the IP address is successful, but pinging/tracerouting the domain name is not, you might have a name resolution problem. In this case, ensure that the domain name you are specifying can be resolved by using Domain Name System (DNS) queries.

- **IP Address/Domain Name** - Type the destination IP address (such as 192.168.0.1) or Domain name (such as http://www.tp-link.com).
- **Pings Count** - The number of Ping packets for a Ping connection.
- **Ping Packet Size** - The size of Ping packet.
- **Ping Timeout** - Set the waiting time for the reply of each Ping packet. If there is no reply in the specified time, the connection is overtime.
- **Traceroute Max TTL** - The max number of hops for a Traceroute connection.

Click **Start** to check the connectivity of the Internet.

The **Diagnostic Results** page displays the result of diagnosis.

If the result is similar to the following screen, the connectivity of the Internet is fine.

```

Diagnostic Results
-----
Pinging 192.168.0.1 with 64 bytes of data:

Reply from 192.168.0.1: bytes=64 time=1 TTL=64 seq=1
Reply from 192.168.0.1: bytes=64 time=1 TTL=64 seq=2
Reply from 192.168.0.1: bytes=64 time=1 TTL=64 seq=3
Reply from 192.168.0.1: bytes=64 time=1 TTL=64 seq=4

Ping statistics for 192.168.0.1
Packets: Sent = 4, Received = 4, Lost = 0 (0% loss)
Approximate round trip times in milliseconds:
Minimum = 1, Maximum = 1, Average = 1
    
```

Figure 4-82 Diagnostic Results

**Note:**

Only one user can use this tool at one time. Options “Number of Pings”, “Ping Size” and “Ping Timeout” are used for **Ping** function. Option “Tracert Hops” are used for **Tracert** function.

### 4.17.3 Firmware Upgrade

Choose menu “**System Tools** → **Firmware Upgrade**”, you can update the latest version of firmware for the Router on the following screen.

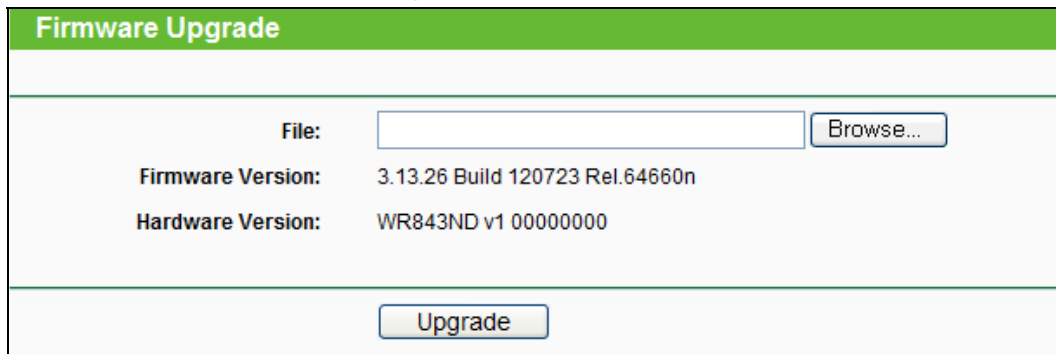

Figure 4-83 Firmware Upgrade

- **Firmware Version** - This displays the current firmware version.
- **Hardware Version** - This displays the current hardware version. The hardware version of the upgrade file must accord with the Router’s current hardware version.

**To upgrade the Router's firmware, follow these instructions below:**

1. Download a more recent firmware upgrade file from the TP-LINK website (<http://www.tp-link.com>).
2. Type the path and file name of the update file into the **File** field. Or click the **Browse** button to locate the update file.
3. Click the **Upgrade** button.

**Note:**

- 1) New firmware versions are posted at <http://www.tp-link.com> and can be downloaded for free.

There is no need to upgrade the firmware unless the new firmware has a new feature you want to use. However, when experiencing problems caused by the Router rather than the configuration, you can try to upgrade the firmware.

- 2) When you upgrade the Router's firmware, you may lose its current configurations, so before upgrading the firmware please write down some of your customized settings to avoid losing important settings.
- 3) Do not turn off the Router or press the Reset button while the firmware is being upgraded, otherwise, the Router may be damaged.
- 4) The Router will reboot after the upgrading has been finished.

#### 4.17.4 Factory Defaults

Choose menu “**System Tools** → **Factory Defaults**”, and you can restore the configurations of the Router to factory defaults on the following screen

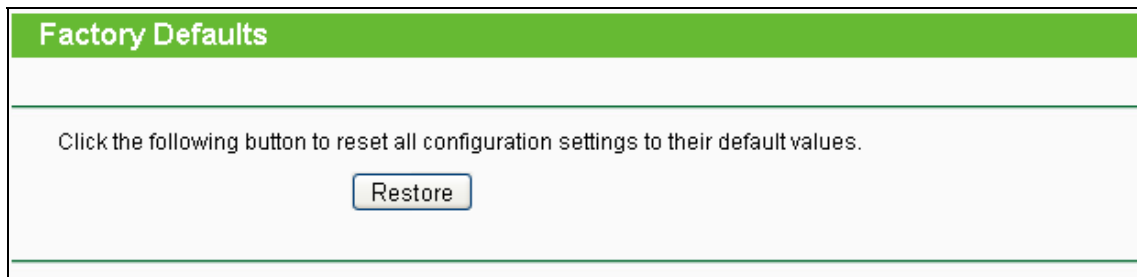

Figure 4-84 Restore Factory Default

Click the **Restore** button to reset all configuration settings to their default values.

- The default **User Name**: admin
- The default **Password**: admin
- The default **IP Address**: 192.168.0.1
- The default **Subnet Mask**: 255.255.255.0

 **Note:**

Any settings you have saved will be lost when the default settings are restored.

#### 4.17.5 Backup & Restore

Choose menu “**System Tools** → **Backup & Restore**”, you can save the current configuration of the Router as a backup file and restore the configuration via a backup file as shown in Figure 4-85.

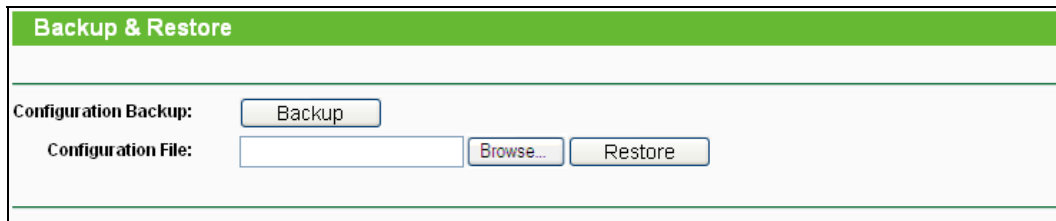

Figure 4-85 Backup & Restore Configuration

- Click the **Backup** button to save all configuration settings as a backup file in your local computer.
- To upgrade the Router's configuration, follow these instructions.
  - Click the **Browse...** button to locate the update file for the Router, or enter the exact path to the Setting file in the text box.
  - Click the **Restore** button.

**Note:**

The current configuration will be covered by the uploading configuration file. The upgrade process lasts for 20 seconds and the Router will restart automatically. Keep the Router on during the upgrading process to prevent any damage.

#### 4.17.6 Reboot

Choose menu “**System Tools** → **Reboot**”, you can click the **Reboot** button to reboot the Router via the next screen.

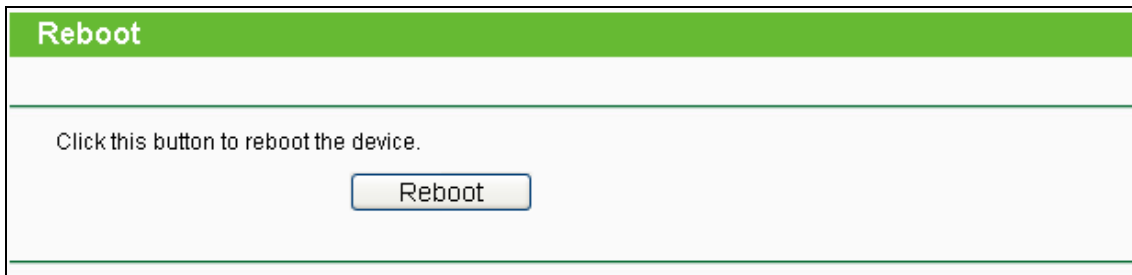

Figure 4-86 Reboot the Router

Some settings of the Router will take effect only after rebooting, which include

- Change the LAN IP Address (system will reboot automatically).
- Change the DHCP Settings.
- Change the Working Modes.
- Change the Web Management Port.
- Upgrade the firmware of the Router (system will reboot automatically).
- Restore the Router's settings to factory defaults (system will reboot automatically).



- Update the configuration with the file (system will reboot automatically).

#### 4.17.7 Password

Choose menu “**System Tools** → **Password**”, you can change the factory default user name and password of the Router in the next screen as shown in Figure 4-87.

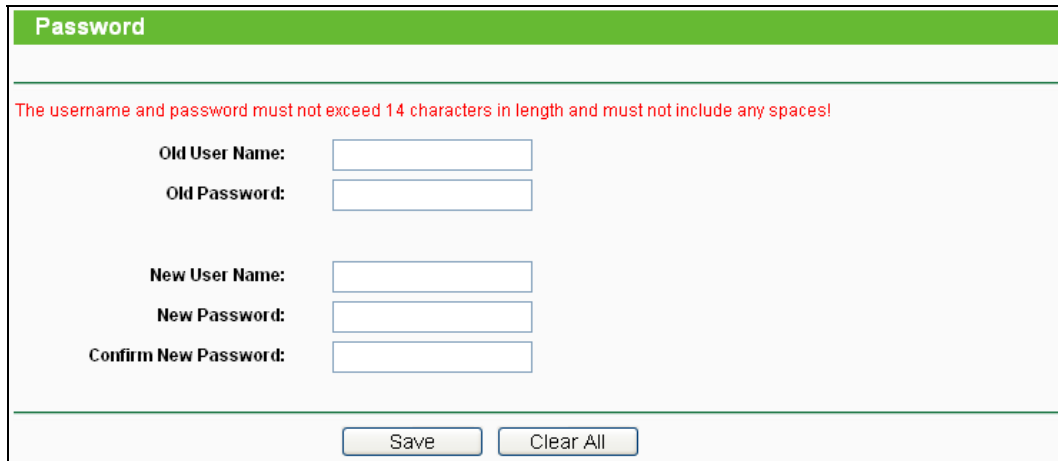

The screenshot shows a web page titled "Password" with a green header. Below the header, a red warning message states: "The username and password must not exceed 14 characters in length and must not include any spaces!". The form contains six input fields: "Old User Name:", "Old Password:", "New User Name:", "New Password:", and "Confirm New Password:". At the bottom of the form, there are two buttons: "Save" and "Clear All".

Figure 4-87 Password

It is strongly recommended that you should change the factory default user name and password of the Router, because all users who try to access the Router's Web-based utility or Quick Setup will be prompted for the Router's default user name and password.

 **Note:**

The new user name and password must not exceed 14 characters in length and not include any spaces. Enter the new Password twice to confirm.

Click the **Save** button when finished.

Click the **Clear All** button to clear all.

#### 4.17.8 System Log

Choose menu “**System Tools** → **System Log**”, you can view the logs of the Router.

System Log

---

Auto Mail Feature: Disabled Mail Settings

Log Type: ALL Log Level: ALL

Index	Time	Type	Level	Log Content
6	Jul 24 14:31:26	SECURITY	INFO	FTP ALG enabled
5	Jul 24 14:31:26	SECURITY	INFO	IPSEC Passthrough enabled
4	Jul 24 14:31:26	SECURITY	INFO	L2TP Passthrough enabled
3	Jul 24 14:31:26	SECURITY	INFO	PPTP Passthrough enabled
2	Jul 24 14:31:26	DHCP	NOTICE	DHCP server started
1	Jul 24 14:31:21	OTHER	INFO	System started

Time = 2012-07-24 17:10:28 9553s  
H-Ver = WR843ND v1 00000000 : S-Ver = 3.13.26 Build 120723 Rel.64660n  
L = 192.168.0.1 : M = 255.255.255.0  
W1 = DHCP : W = 192.168.1.104 : M = 255.255.255.0 : G = 192.168.1.1

Refresh
Save Log
Mail Log
Clear Log

---

Previous
Next
Current No. 2
Page

Figure 4-88 System Log

- **Auto Mail Feature** - Indicates whether auto mail feature is enabled or not.
- **Mail Settings** - Set the receiving and sending mailbox address, server address, validation information as well as the timetable for Auto Mail Feature, as shown in Figure 4-89.

Mail Account Settings

---

**From:**

**To:**

**SMTP Server:**

Authentication

**User Name:**

**Password:**

**Confirm The Password:**

---

Enable Auto Mail Feature

Everyday, mail the log at  :  (HH:MM)

Mail the log every  hours

---

Save
Back

Figure 4-89 Mail Account Settings

- **From** - Your mail box address. The Router would connect it to send logs.
- **To** - Recipient's address. The destination mailbox where the logs would be received.
- **SMTP Server** - Your smtp server. It corresponds with the mailbox filled in the From field. You can log on the relevant website for Help if you are not clear with the address.
- **Authentication** - Most SMTP Server requires Authentication. It is required by most mailboxes that need User Name and Password to log in.

 **Note:**

Only when you select **Authentication**, do you have to enter the User Name and Password in the following fields.

- **User Name** - Your mail account name filled in the From field. The part behind @ is excluded.
- **Password** - Your mail account password.
- **Confirm The Password** - Enter the password again to confirm.
- **Enable Auto Mail Feature** - Select it to mail logs automatically. You could mail the current logs either at a specified time everyday or by intervals, but only one could be the current effective rule. Enter the desired time or intervals in the corresponding field as shown in Figure 4-89

Click **Save** to keep your settings.

Click **Back** to return to the previous page.

- **Log Type** - By selecting the log type, only logs of this type will be shown.
- **Log Level** - By selecting the log level, only logs of this level will be shown.
- **Refresh** - Refresh the page to show the latest log list.
- **Save Log** - Click to save all the logs in a txt file.
- **Mail Log** - Click to send an email of current logs manually according to the address and validation information set in Mail Settings.
- **Clear Log** - All the logs will be deleted from the Router permanently, not just from the page.

Click the **Next** button to go to the next page, or click the **Previous** button return to the previous page.

#### 4.17.9 Statistics

Choose menu "**System Tools** → **Statistics**", you can view the statistics of the Router, including total traffic and the value of the last Packets Statistic Interval in seconds.

Figure 4-90 Statistics

- **Current Statistics Status** - Enable or Disable. The default value is disabled. To enable, click the **Enable** button. If disabled, the function of DoS protection in Security settings will be disabled.
- **Packets Statistics Interval (5-60)** - The default value is 10. Select a value between 5 and 60 seconds in the drop-down list. The Packets Statistic interval indicates the time section of the packets statistic.
- **Sorted Rules** – Choose how displayed statistics are sorted.

Select the **Auto-refresh** checkbox to refresh automatically.

Click the **Refresh** button to refresh immediately.

Click **Reset All** to reset the values of all the entries to zero.

Click **Delete All** to delete all entries in the table.

**Statistics Table:**

<b>IP/MAC Address</b>		The IP and MAC address are displayed with related statistics.
<b>Total</b>	<b>Packets</b>	The total number of packets received and transmitted by the Router.
	<b>Bytes</b>	The total number of bytes received and transmitted by the Router.
<b>Current</b>	<b>Packets</b>	The total number of packets received and transmitted in the last Packets Statistic interval seconds.
	<b>Bytes</b>	The total number of bytes received and transmitted in the last Packets Statistic interval seconds.
	<b>ICMP Tx</b>	The number of the ICMP packets transmitted to WAN per second at the specified Packets Statistics interval. It is shown like “current transmitting rate / Max transmitting rate”.

	<b>UDP Tx</b>	The number of UDP packets transmitted to the WAN per second at the specified Packets Statistics interval. It is shown like “current transmitting rate / Max transmitting rate”.
	<b>TCP SYN Tx</b>	The number of TCP SYN packets transmitted to the WAN per second at the specified Packets Statistics interval. It is shown like “current transmitting rate / Max transmitting rate”.
<b>Modify</b>	<b>Reset</b>	Reset the value of the entry to zero.
	<b>Delete</b>	Delete the existing entry in the table.

Click **Previous** to return to the previous page and **Next** to the next page.

## Appendix A: FAQ

### 1. How do I configure the Router to access Internet by ADSL users?

- 1) First, configure the ADSL Modem in bridge mode.
- 2) Connect the Ethernet cable from your ADSL Modem to the WAN port on the Router. The telephone cord plugs into the Line port of the ADSL Modem.
- 3) Log in to the Router, click the **"Network"** menu on the left of your browser, and click **"WAN"** submenu. On the **WAN** page, select "PPPoE" for WAN Connection Type. Type user name in the "User Name" field and password in the "Password" field, finish by clicking **Connect**.

WAN Connection Type:

PPPoE Connection:

User Name:

Password:

Figure A-1 PPPoE Connection Type

- 4) If your ADSL lease is in "pay-according-time" mode, select "Connect on Demand" or "Connect Manually" for Internet connection mode. Type an appropriate number for "Max Idle Time" to avoid wasting paid time. Otherwise, you can select "Auto-connecting" for Internet connection mode.

Wan Connection Mode:

Connect on Demand  
Max Idle Time:  minutes (0 means remain active at all times.)

Connect Automatically

Time-based Connecting  
Period of Time: from  :  (HH:MM) to  :  (HH:MM)

Connect Manually  
Max Idle Time:  minutes (0 means remain active at all times.)

**Disconnected!**

Figure A-2 PPPoE Connection Mode

#### Note:

- 1) Sometimes the connection cannot be disconnected although you specify a time to Max Idle Time, since some applications is visiting the Internet continually in the background.
- 2) If you are a Cable user, please configure the Router following the above steps.

### 2. How do I configure the Router to access Internet by Ethernet users?

- 1) Log in to the Router, click the **"Network"** menu on the left of your browser, and click **"WAN"** submenu. On the **WAN** page, select "Dynamic IP" for "WAN Connection Type", finish by clicking **Save**.

- 2) Some ISPs require that you register the MAC Address of your adapter, which is connected to your cable/DSL Modem during installation. If your ISP requires MAC register, log in to the Router and click the **"Network"** menu link on the left of your browser, and then click **"MAC Clone"** submenu link. On the **"MAC Clone"** page, if your PC's MAC address is proper MAC address, click the **Clone MAC Address** button and your PC's MAC address will fill in the "WAN MAC Address" field. Or else, type the MAC Address into the "WAN MAC Address" field. The format for the MAC Address is XX-XX-XX-XX-XX-XX. Then click the **Save** button. It will take effect after rebooting.

Figure A-3 MAC Clone

**3. I want to use NetMeeting, what do I need to do?**

- 1) If you start NetMeeting as a sponsor, you don't need to do anything with the Router.
- 2) If you start as a response, you need to configure Virtual Server or DMZ Host and make sure the H323 ALG is enabled.
- 3) How to configure Virtual Server: Log in to the Router, click the **"Forwarding"** menu on the left of your browser, and click **"Virtual Servers"** submenu. On the **"Virtual Servers"** page, click **Add New....** Then on the **"Add or Modify a Virtual Server Entry"** page, enter "11130" for the "Service Port" blank, and your IP address for the "IP Address" blank, taking 192.168.0.198 for an example, remember to **Enable** and **Save**.

ID	Service Port	Internal Port	IP Address	Protocol	Status	Modify
1	11130	11120	192.168.0.198	ALL	Enabled	<a href="#">Modify</a> <a href="#">Delete</a>

Figure A-4 Virtual Servers

**Add or Modify a Virtual Server Entry**

Service Port:  (XX-XX or XX)

Internal Port:  (XX, Only valid for single Service Port or leave it blank)

IP Address:

Protocol:

Status:

Common Service Port:

Figure A-5 Add or Modify a Virtual server Entry

**Note:**

Your opposite side should call your WAN IP, which is displayed on the “Status” page.

- 4) How to enable DMZ Host: Log in to the Router, click the “**Forwarding**” menu on the left of your browser, and click “**DMZ**” submenu. On the “DMZ” page, click **Enable** radio button and type your IP address into the “DMZ Host IP Address” field, using 192.168.0.198 as an example, remember to click the **Save** button.

**DMZ**

Current DMZ Status:  Enable  Disable

DMZ Host IP Address:

Figure A-6 DMZ

- 5) How to enable H323 ALG: Log in to the Router, click the “**Security**” menu on the left of your browser, and click “**Basic Security**” submenu. On the “**Basic Security**” page, check the **Enable** radio button next to **H323 ALG**. Remember to click the **Save** button.



Figure A-7 Basic Security

4. I want to build a WEB Server on the LAN, what should I do?

- 1) Because the WEB Server port 80 will interfere with the WEB management port 80 on the Router, you must change the WEB management port number to avoid interference.
- 2) To change the WEB management port number: Log in to the Router, click the “**Security**” menu on the left of your browser, and click “**Remote Management**” submenu. On the “**Remote Management**” page, type a port number except 80, such as 88, into the “Web Management Port” field. Click **Save** and reboot the Router.

Figure A-8 Remote Management

**Note:**

If the above configuration takes effect, configure to the Router by typing 192.168.0.1:88 (the Router’s LAN IP address: Web Management Port) in the address field of the Web browser.

- 3) Log in to the Router, click the “**Forwarding**” menu on the left of your browser, and click the “**Virtual Servers**” submenu. On the “**Virtual Servers**” page, click **Add New...**, then on the “**Add or Modify a Virtual Server**” page, enter “80” into the blank next to the

“**Service Port**”, and your IP address next to the “**IP Address**”, assuming 192.168.0.188 for an example, remember to **Enable** and **Save**.

Virtual Servers						
ID	Service Port	Internal Port	IP Address	Protocol	Status	Modify
1	80	21	192.168.0.188	ALL	Enabled	<a href="#">Modify</a> <a href="#">Delete</a>

Figure A-9 Virtual Servers

Add or Modify a Virtual Server Entry	
Service Port:	<input type="text" value="80"/> (XX-XX or XX)
Internal Port:	<input type="text" value="21"/> (XX, Only valid for single Service Port or leave it blank)
IP Address:	<input type="text" value="192.168.0.188"/>
Protocol:	<input type="text" value="ALL"/>
Status:	<input type="text" value="Enabled"/>
Common Service Port:	<input type="text" value="--Select One--"/>

Figure A-10 Add or Modify a Virtual server Entry

**5. The wireless stations cannot connect to the Router.**

- 1) Make sure the "**Enable Wireless Router Radio**" is checked and the **Disable Local Wireless Access** is unchecked.
- 2) Make sure that the wireless stations' SSID accord with the Router's SSID.
- 3) Make sure the wireless stations have right KEY for encryption when the Router is encrypted.
- 4) If the wireless connection is ready, but you can't access the Router, check the IP Address of your wireless stations.

## Appendix B: Configuring the PC

In this section, we'll introduce how to install and configure the TCP/IP correctly in Windows XP. First make sure your Ethernet Adapter is working, refer to the adapter's manual if necessary.

### 1. Configure TCP/IP component

- 1) On the Windows taskbar, click the **Start** button, and then click **Control Panel**.
- 2) Click the **Network and Internet Connections** icon, and then click on the **Network Connections** tab in the appearing window.
- 3) Right click the icon that showed below, select Properties on the prompt page.

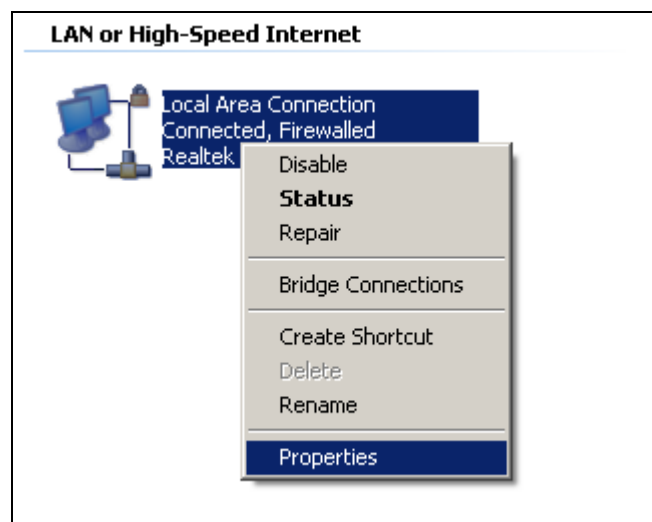

Figure B-1

- 4) In the prompt page that showed below, double click on the **Internet Protocol (TCP/IP)**.

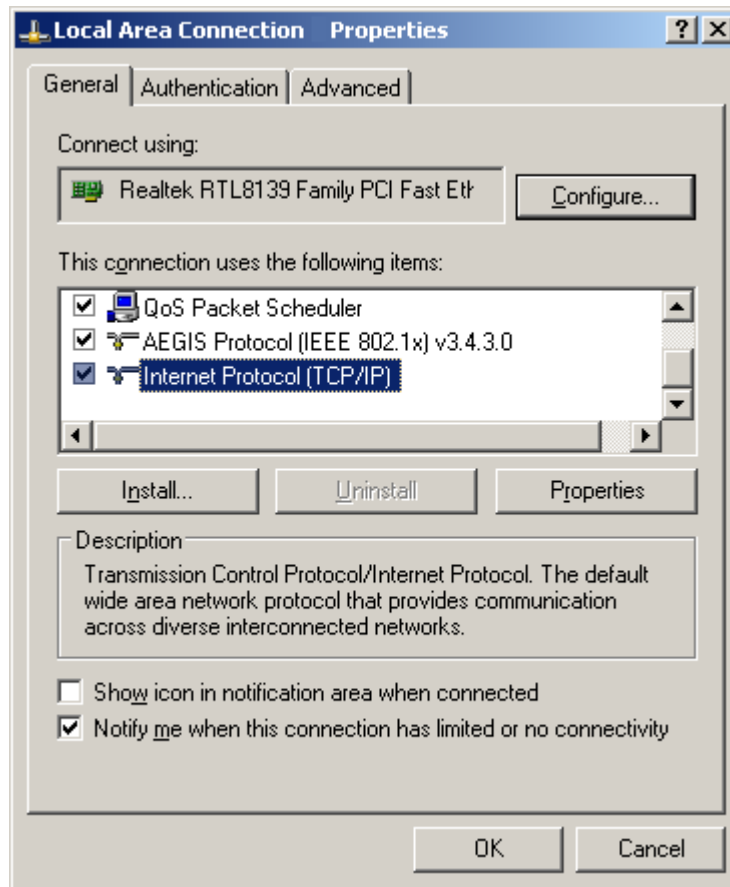

Figure B-2

- 5) The following **TCP/IP Properties** window will display and the **IP Address** tab is open on this window by default.

Now you have two ways to configure the **TCP/IP** protocol below:

➤ **Setting IP address automatically**

Select **Obtain an IP address automatically**, Choose **Obtain DNS server automatically**, as shown in the Figure below:

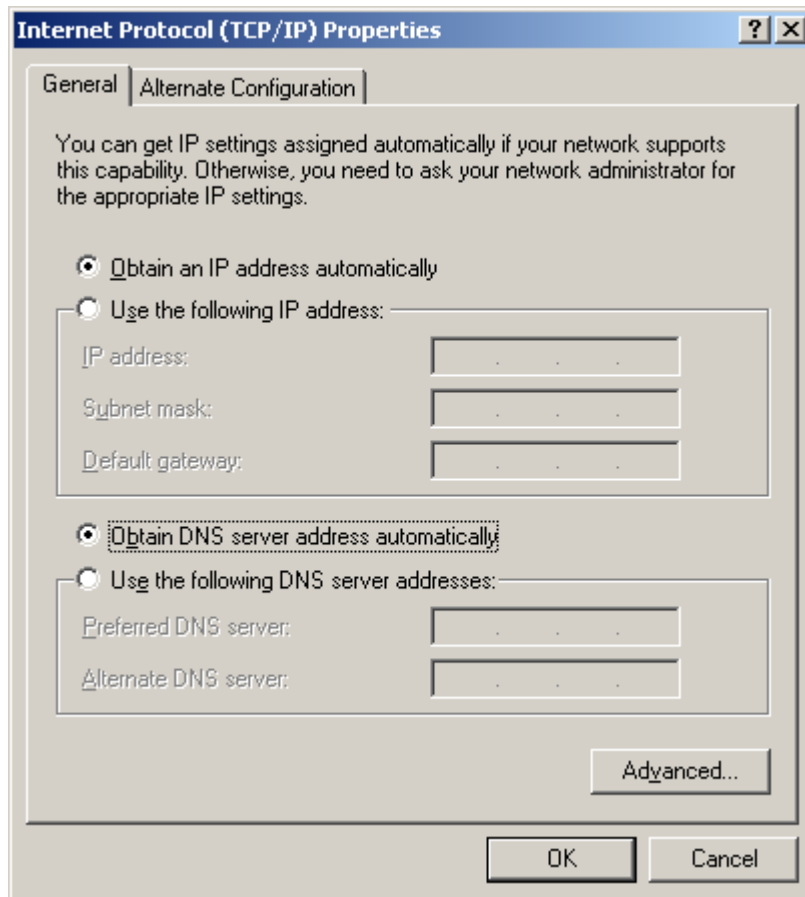

Figure B-3

 **Note:**

For Windows 98 OS or before, the PC and Router may need to be restarted.

➤ **Setting IP address manually**

- 1 Select **Use the following IP address** radio button. And the following items available
- 2 If the Router's LAN IP address is 192.168.0.1, specify the **IP address** as 192.168.0.x (x is from 2 to 254), and the **Subnet mask** as 255.255.255.0.
- 3 Type the Router's LAN IP address (the default IP is 192.168.0.1) into the **Default gateway** field.
- 4 Select **Use the following DNS server addresses**. In the **Preferred DNS Server** field you can enter the same value as the **Default gateway** or type the local DNS server IP address.

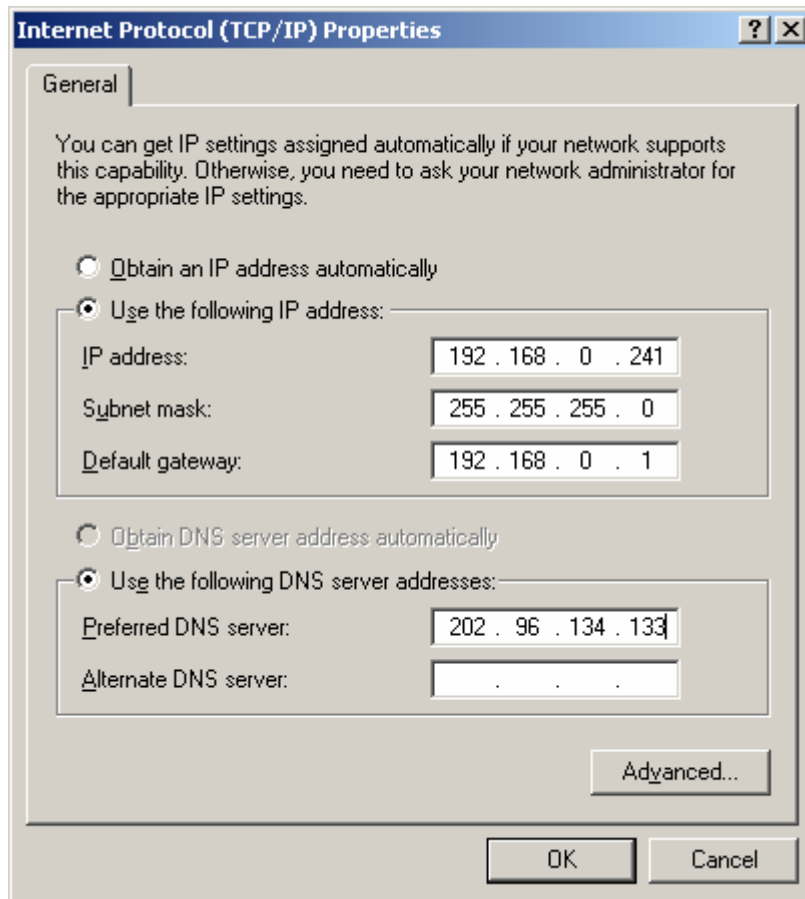

Now click **OK** to keep your settings.

## Appendix C: Specifications

General	
Standards	IEEE 802.3, IEEE 802.3u, IEEE 802.11b, IEEE 802.11g and IEEE 802.11n
Protocols	TCP/IP, PPPoE, DHCP, ICMP, NAT, SNTP
Ports	One 10/100M Auto-Negotiation WAN RJ45 port, Four 10/100M Auto-Negotiation LAN RJ45 ports supporting Auto MDI/MDIX
Cabling Type	10BASE-T: UTP category 3, 4, 5 cable (maximum 100m) EIA/TIA-568 100Ω STP (maximum 100m)
	100BASE-TX: UTP category 5, 5e cable (maximum 100m) EIA/TIA-568 100Ω STP (maximum 100m)
LEDs	⏻ (Power), ⚙️ (System), 📶 (WLAN), 🌐 (INTERNET), 📡 (LAN 1-4), 🔒 (WPS)
Safety & Emissions	FCC, CE
Wireless	
Frequency Band	2.4~2.4835GHz
Radio Data Rate	11n: up to 300Mbps (Automatic) 11g: 54/48/36/24/18/12/9/6Mbps (Automatic) 11b: 11/5.5/2/1Mbps (Automatic)
Frequency Expansion	DSSS(Direct Sequence Spread Spectrum)
Modulation	DBPSK, DQPSK, CCK, OFDM, 16-QAM, 64-QAM
Security	WEP/WPA/WPA2/WPA2-PSK/WPA-PSK
Sensitivity @PER	270M: -68dBm@10% PER; 130M: -68dBm@10% PER 108M: -68dBm@10% PER; 54M: -68dBm@10% PER 11M: -85dBm@8% PER; 6M: -88dBm@10% PER 1M: -90dBm@8% PER
Environmental and Physical	
Temperature	Operating : 0°C~40°C (32°F~104°F)
	Storage: -40°C~70°C(-40°F~158°F)
Humidity	Operating: 10% - 90% RH, Non-condensing
	Storage: 5% - 90% RH, Non-condensing

## Appendix D: Glossary

- **802.11n** - 802.11n builds upon previous 802.11 standards by adding MIMO (multiple-input multiple-output). MIMO uses multiple transmitter and receiver antennas to allow for increased data throughput via spatial multiplexing and increased range by exploiting the spatial diversity, perhaps through coding schemes like Alamouti coding. The Enhanced Wireless Consortium (EWC) [3] was formed to help accelerate the IEEE 802.11n development process and promote a technology specification for interoperability of next-generation wireless local area networking (WLAN) products.
- **802.11b** - The 802.11b standard specifies a wireless networking at 11 Mbps using direct-sequence spread-spectrum (DSSS) technology and operating in the unlicensed radio spectrum at 2.4GHz, and WEP encryption for security. 802.11b networks are also referred to as Wi-Fi networks.
- **802.11g** - specification for wireless networking at 54 Mbps using direct-sequence spread-spectrum (DSSS) technology, using OFDM modulation and operating in the unlicensed radio spectrum at 2.4GHz, and backward compatibility with IEEE 802.11b devices, and WEP encryption for security.
- **DDNS (Dynamic Domain Name System)** - The capability of assigning a fixed host and domain name to a dynamic Internet IP Address.
- **DHCP (Dynamic Host Configuration Protocol)** - A protocol that automatically configure the TCP/IP parameters for the all the PC(s) that are connected to a DHCP server.
- **DMZ (Demilitarized Zone)** - A Demilitarized Zone allows one local host to be exposed to the Internet for a special-purpose service such as Internet gaming or videoconferencing.
- **DNS (Domain Name System)** – An Internet Service that translates the names of websites into IP addresses.
- **Domain Name** - A descriptive name for an address or group of addresses on the Internet.
- **DSL (Digital Subscriber Line)** - A technology that allows data to be sent or received over existing traditional phone lines.
- **ISP (Internet Service Provider)** - A company that provides access to the Internet.
- **MTU (Maximum Transmission Unit)** - The size in bytes of the largest packet that can be transmitted.
- **NAT (Network Address Translation)** - NAT technology translates IP addresses of a local area network to a different IP address for the Internet.
- **PPPoE (Point to Point Protocol over Ethernet)** - PPPoE is a protocol for connecting remote



hosts to the Internet over an always-on connection by simulating a dial-up connection.

- **SSID** - A **S**ervice **S**et **I**dentification is a thirty-two character (maximum) alphanumeric key identifying a wireless local area network. For the wireless devices in a network to communicate with each other, all devices must be configured with the same SSID. This is typically the configuration parameter for a wireless PC card. It corresponds to the ESSID in the wireless Access Point and to the wireless network name.
- **WEP (Wired Equivalent Privacy)** - A data privacy mechanism based on a 64-bit or 128-bit or 152-bit shared key algorithm, as described in the IEEE 802.11 standard.
- **Wi-Fi** - A trade name for the 802.11b wireless networking standard, given by the Wireless Ethernet Compatibility Alliance (WECA, see <http://www.wi-fi.net>), an industry standards group promoting interoperability among 802.11b devices.
- **WLAN (Wireless Local Area Network)** - A group of computers and associated devices communicate with each other wirelessly, which network serving users are limited in a local area.